

# JVC



## DVD PLAYER

# XV-M557GD/XV-M556TN

Introduction	1
Preliminary knowledge	4
Getting started	12
Basic operations	17
Advanced operations	20
Karaoke operation	35
Initial settings	42
Additional information	48

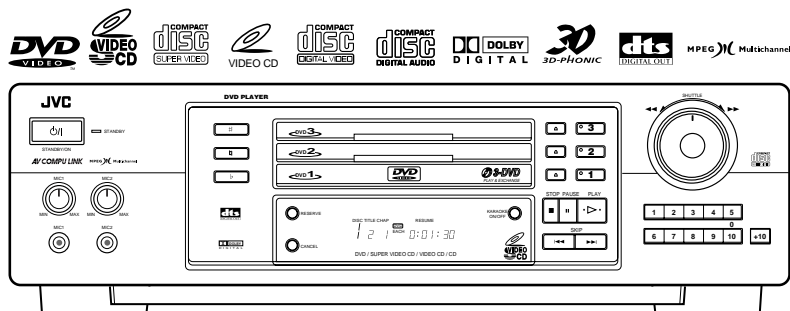
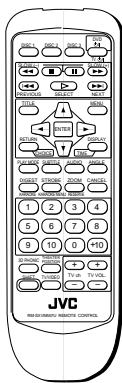

## INSTRUCTIONS

### For Customer Use:

Enter below the Model No. and Serial No. which are located on the rear, bottom or side of the cabinet. Retain this information for future reference.

Model No. \_\_\_\_\_

Serial No. \_\_\_\_\_

LVT0391-016A  
[UX, 3U, 4U, US, UT, UB]

# Warnings, Cautions and Others

## CAUTION

To reduce the risk of electrical shocks, fire, etc.:

1. Do not remove screws, covers or cabinet.
2. Do not expose this appliance to rain or moisture.

## Caution — button!

Disconnect the mains plug to shut the power off completely. The  button in any position does not disconnect the mains line. The power can be remote controlled.

## IMPORTANT FOR LASER PRODUCTS

### REPRODUCTION OF LABELS

① CLASSIFICATION LABEL, PLACED ON REAR ENCLOSURE

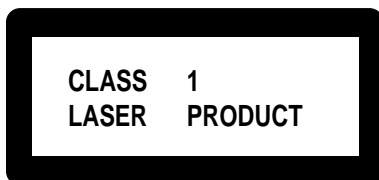

② WARNING LABEL, PLACED INSIDE THE UNIT

CAUTION	-LASER RADIATION WHEN OPEN. DO NOT STARE INTO BEAM.
ATTENTION	-RAYONNEMENT LASER EN CAS D'OUVERTURE. NE PAS REGARDER DANS LE FAISCEAU.
VORSICHT	-LASERSTRAHLUNG, WENN ABDECKUNG GEÖFFNET. NICHT IN DEN STRAHL BLICKEN.
ADVARSEL	-LASERSTRÅLING VED ÅBNING. SE IKKE IND I STRÅLEN.
ADVARSEL	-LASERSTRÅLING NÅR DEKSEL ÅPNES. STIRR IKKE INN I STRÅLEN.
VARNING	-LASERSTRÅLNING NÅR DENNA DEL ÄR ÖPPNAD. STRÅR EJ IN I STRÅLEN.
VARO!	AVATTAESSA OLET ALTTIINA LASERSATEILYLE. ÄLÄ TUJOTA SÄTEESEENI.
注意	- 当打开这里会出现激光, 请不要直视激光。
注意	- ここを開くとレーザー光が出ます。 レーザー光をのぞきまなしないでください。

1. CLASS 1 LASER PRODUCT
2. **DANGER:**Visible laser radiation when open and interlock failed or defeated. Avoid direct exposure to beam.
3. **CAUTION:** Do not open the top cover. There are no user serviceable parts inside the Unit; leave all servicing to qualified service personnel.

### Caution: Proper Ventilation

To avoid risk of electric shock and fire and to protect from damage.

Locate the apparatus as follows:

- Front: No obstructions open spacing.  
Sides: No obstructions in 3 cm from the sides.  
Top: No obstructions in 5 cm from the top.  
Back: No obstructions in 15 cm from the back  
Bottom: No obstructions, place on the level surface.

# Table of contents

<b>Introduction</b>	Page 1		
<b>Features</b>	1		
<b>Supplied accessories</b>	1		
<b>About this instruction manual</b>	2		
<b>Notes on handling</b>	3		
<b>Preliminary Knowledge</b>	Page 4		
<b>Names of parts and controls</b>			
Front panel	4		
Remote control unit	5		
Display window	7		
Rear panel	7		
<b>Operational Principles</b>			
On-screen displays	8		
To prevent the monitor from burning out [SCREEN SAVER]	10		
On-screen guide icons	10		
How to use numeric buttons	10		
<b>About discs</b>			
Playable disc types	11		
Disc structure	11		
<b>Getting started</b>	Page 12		
<b>Connections</b>			
Before making any connections	12		
To connect to a TV	12		
To connect to a TV with the component video jacks	13		
To connect to an audio amplifier or receiver	13		
To connect to audio equipment with a digital input	14		
To connect the power cord	14		
<b>Using the remote control unit</b>			
To install batteries in the remote control unit	15		
To use the remote control unit for TV operation	16		
<b>Basic operations</b>	Page 17		
<b>Turning on/off the unit</b>	17		
<b>Inserting and removing discs</b>	17		
<b>Basic playback</b>			
To start playback	18		
To stop playback completely	18		
To stop playback temporarily	18		
To advance or reverse play rapidly while monitoring	19		
To locate the beginning of a scene or song	19		
To resume playback	19		
<b>Advanced operations</b>	Page 20		
<b>Playing from a specific position on a disc</b>			
To locate a desired scene from the DVD menu	20		
To locate a desired scene from the menu of the Video CD with PBC	20		
To locate a desired title or track directly	21		
To locate a desired chapter or track using ►► or ◀◀	21		
To locate a desired scene by specifying the chapter number [CHAP. SEARCH]	22		
To locate a desired position in the current title or track [TIME SEARCH]	22		
To locate a desired scene from the opening scene digest display [DIGEST]	23		
<b>Special picture playback</b>			
To advance a still picture frame-by-frame	24		
To display still pictures [STROBE]	24		
To playback in slow-motion [SLOW]	25		
To zoom a scene [ZOOM]	25		
<b>Changing the playback order</b>			
To playback titles/tracks in the desired order [PROGRAM]	26		
			To playback titles or tracks in random order [RANDOM] ..... 27
			<b>Repeat playback</b>
			To repeat a current title, chapter or track, or all discs [REPEAT] ..... 27
			To repeat a desired part [A-B REPEAT] ..... 28
			<b>Viewing from multiple angles</b>
			To select a scene angle from the normal screen [ANGLE] ..... 29
			To select a scene angle from the angle list display [ANGLE] ..... 30
			<b>Changing the language and sound</b>
			To select the subtitle language [SUBTITLE] ..... 30
			To change the audio language or sound [AUDIO] ..... 31
			<b>Selecting the picture character</b>
			To select the picture character [THEATER POSITION] ..... 31
			<b>Enjoying virtual surround sound</b>
			To simulate surround sound [3D PHONIC] ..... 32
			<b>Checking the status</b>
			To check the disc/time information ..... 33
			To check the DVD function status ..... 34
			<b>KARAOKE function</b> Page 35
			<b>Preparation</b>
			Turning on the KARAOKE function ..... 35
			Connecting microphones ..... 35
			<b>Reserving songs</b> ..... 36
			<b>Selecting audio</b>
			Selecting audio track(s) [AUDIO] ..... 37
			Selecting Karaoke sound [KARAOKE SOUND] ..... 37
			Masking the vocal recorded on a disc [VOCAL MASK] ... 38
			Playing back the guide vocal only when you stop singing [VOCAL REPLACE] ..... 39
			<b>Adding an effect to your voice</b>
			Adding an echo effect [ECHO] ..... 39
			Adding various effects to the vocal [VOCAL EFFECT] ..... 40
			<b>Shifting the musical key</b>
			Operating the front panel ..... 40
			Operating the front remote control unit ..... 41
			<b>Initial settings</b> Page 42
			<b>Selecting preferences</b>
			How to set preferences ..... 42
			LANGUAGE page ..... 42
			AUDIO page ..... 43
			DISPLAY page ..... 44
			SYSTEM page ..... 45
			<b>Limiting playback by children</b>
			To set Parental Lock for the first time [PARENTAL LOCK] ..... 46
			To change the settings [PARENTAL LOCK] ..... 47
			To temporarily release the Parental lock [PARENTAL LOCK] ..... 47
			<b>Additional information</b> Page 48
			<b>AV COMPU LINK remote control system</b>
			Connection and setup ..... 48
			Operation ..... 49
			<b>Care and handling of discs</b> ..... 49
			<b>Troubleshooting</b> ..... 50
			<b>Specifications</b> ..... 51
			<b>Table of languages and their   abbreviations</b> ..... Appendix A
			<b>Country code list for parental lock</b> ..... Appendix B

## Features

### Picture functions

- **Strobe function**  
The unit can display nine continuous still pictures on the TV screen.
- **Digest function**  
You can select the desired title from the opening scenes displayed on the TV screen.
- **Angle function\***  
You can select a desired angle from multiple camera angles recorded on the DVD disc.
- **Zoom function**  
You can view scenes close-up.
- **Parental lock\***  
You can restrict the playback of DVD discs with scenes which you do not want children to see, such as adult or violent films.
- **Theater position**  
You can select the picture character according to the lighting of your room.

### Audio functions

- **High quality digital sound**  
You can enjoy high quality sound with Dolby Digital or Linear-PCM.
- **Surround function\***  
The unit is compatible with Dolby Digital surround, DTS surround and MPEG Multichannel. (DTS surround and MPEG Multichannel are available for digital output only.)
- **3D Phonic function**  
You can enjoy surround sound with your 2-channel system.

### Other functions

- **Triple disc trays**  
You can insert up to three discs in the unit and can play them continuously.
- **Multi-language subtitles and sound\***  
You can select a subtitle or sound language from those recorded on the DVD disc.
- **Multi-disc playback**  
You can enjoy Audio CD discs and Video CD discs, as well as DVD discs.
- **Operation from the on-screen display**  
User-friendly on-screen displays allow you to operate the unit easily.

Functions with (\*) mark only work on a DVD disc that is compatible with each function.

## Supplied accessories

- Audio/video cable (x 1)



- S-video cable (x 1)



- AV compulink cord (x 1)

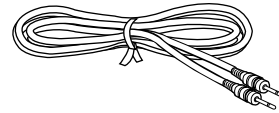

- Remote Control Unit (x 1)

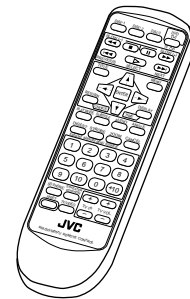

- R6P(SUM-3)/AA(15F) batteries (x 2)

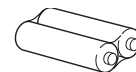

- Instruction manual (x 1)

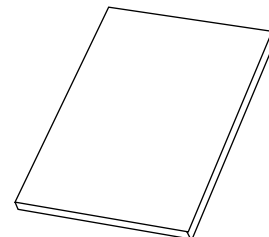

- AC power cord (x 1)

- AC plug adaptor (x 1)  
(except Hong Kong)

# About this instruction manual

This instruction manual basically explains operations as follows:

Advanced operations

**To playback titles or tracks in random order [RANDOM]**



You can play titles or tracks on the discs inserted in random order by using the Random function.

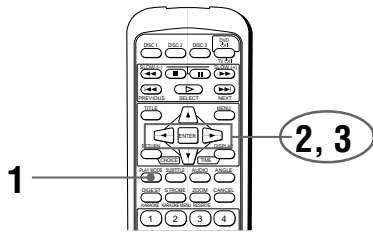

**1** Press PLAY MODE.  
The play mode menu appears on the TV screen.

**2** Use CURSOR ◀/▶ to move  to [RANDOM].

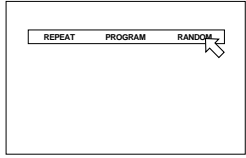

**3** Press ENTER.

The unit starts random playback of the selected disc.  
When all titles/tracks of the disc have been played once, the unit starts random playback of the next disc (if inserted). After playing all titles/tracks of the second disc, the unit starts random playback of the third disc (if inserted). After playing all titles/tracks of all the discs, random playback ends.

 **Hints**

The same title or track will not be played back more than once during random play.

- **To stop/quit random playback in the middle**  
Press ■ to stop playback. The unit is still in random playback mode, so pressing ▷ starts random playback again.  
To quit random playback, press ■ again while stopped.

**NOTE**

Some DVD discs may not be played back correctly in random mode.

Introduction

These symbols indicate the types of discs which the operation can be used for.

The number indicates the following procedural step(s) in which the button(s) is(are) used.  
You may also use the corresponding buttons on the front panel of the unit if available.

The number indicates the procedural step.

The names of buttons on the remote control unit (or on the front panel of the unit) are all given in uppercase letters.

Other convenient procedures, etc.

Additional supplemental remarks

27

# Notes on handling

## Important cautions

### Installation of the unit

- Select a place which is level, dry and neither too hot nor too cold (between 5°C and 35°C, 41°F and 95°F).
- Leave sufficient distance between the unit and the TV.
- Do not use the player in a place subject to vibrations.

### Power cord

- Do not handle the power cord with wet hands!
- A small amount of power (3.8 watts) is always consumed while the power cord is connected to the wall outlet.
- When unplugging the player from the wall outlet, always pull the plug, not the power cord.

### To prevent malfunction of the unit

- There are no user-serviceable parts inside. If anything goes wrong, unplug the power cord and consult your dealer.
- Do not insert any metallic object into the unit.
- Do not use any non-standard shape disc available on the market, because it may damage the unit.
- Do not use a disc with tape, seals, or paste on it, because damage to the unit may result.

### Note about copyright laws

- Please check the copyright laws in your country before recording from DVD VIDEO, Audio CD, and Video CD discs. Recording of copyrighted material may infringe copyright laws.

### Note about the copyguard system

- The DVD VIDEO disc is protected by the copyguard system. When you connect the unit to your VCR directly, the copyguard system activates and the picture may not be played back correctly.

## Safety precautions

### Avoid moisture, water and dust

Do not place the unit in moist or dusty places.

### Avoid high temperatures

Do not expose the unit to direct sunlight or place it near a heating device.

### When you're away

When away on travel or otherwise for an extended period of time, remove the plug from the wall outlet.

### Do not insert foreign objects into the unit

Do not insert wires, hairpins, coins, etc. into the unit.

### Do not block the vents

Blocking the vents may damage the unit.

### Care of the cabinet

When cleaning the unit, use a soft cloth and follow the relevant instructions on the use of chemically-coated cloths. Do not use benzene, thinner or other organic solvents and disinfectants. These may cause deformation or discoloring.

### If water gets inside the unit

Turn off the power switch and remove the plug from the wall outlet, then call the store where you made your purchase. Using the unit in this state may cause a fire or electrical shock.

This product incorporates copyright protection technology that is protected by method claims of certain U.S. patents and other intellectual property rights owned by Macrovision Corporation and other rights owners. Use of this copyright protection technology must be authorized by Macrovision Corporation, and is intended for home and other limited viewing uses only unless otherwise authorized by Macrovision Corporation. Reverse engineering or disassembly is prohibited.

Manufactured under license from Dolby Laboratories. "Dolby" and double-D symbol are trademarks of Dolby Laboratories.

Confidential Unpublished Works.

© 1992-1997 Dolby Laboratories, Inc. All rights reserved.

Manufactured under license from Digital Theater Systems, Inc. US Pat. No. 5,451,942 and other world-wide patents issued and pending. "DTS", "DTS Digital Surround", are trademarks of Digital Theater System, Inc.

© 1996 Digital Theater Systems, Inc. All Rights Reserved.

## Names of parts and controls

Refer to the corresponding pages indicated in ( ) for details.

### Front panel

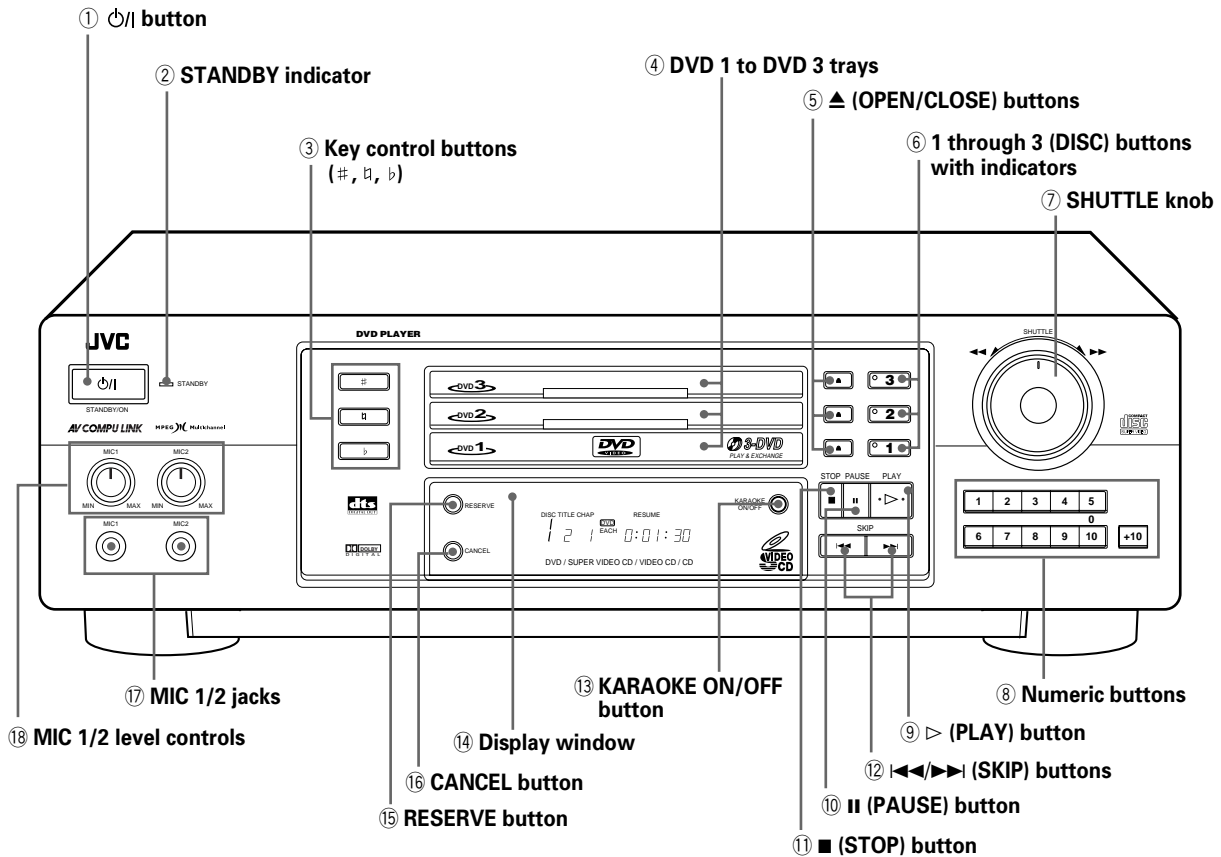

#### 1 ⏻/⏻ button (17)

Turns the unit on or off (standby).

#### 2 STANDBY indicator

Lights when the power cord is connected and the unit is on standby. When the unit is turned on, the STANDBY indicator goes off.

#### 3 Key control buttons (40)

Used to shift the musical key of a song being played to match with your voice.  
# raises the key, and ♭ lowers the key. ♮ returns to the original (normal) key.

#### 4 DVD 1 to DVD 3 trays (17)

Used to load discs. To insert/remove discs, press the ▲ (OPEN/CLOSE) button located on the right of the tray corresponding to disc number.

#### 5 ▲ (OPEN/CLOSE) buttons (17)

Used to open and close disc trays 1 to 3 respectively. When, after opening the DVD1 tray, another ▲(OPEN/CLOSE) button is pressed, the DVD1 tray is first closed, then the other DVD tray selected is opened.

#### 6 1 through 3 (DISC) buttons with indicators (18)

Used to start playback of the disc in the tray corresponding with the number indicated on the button (these function the same as the DISC 1 through 3 buttons on the remote control unit). While playing, the corresponding indicator blinks. In this manual, they are sometimes called "DISC" buttons.

#### 7 SHUTTLE knob (19, 25)

Performs rapid advance/reverse playback operations. Also used for slow-motion playback of a picture (for DVD/Video CD/SVCD).

#### 8 Numeric buttons

Mainly used to select title/track numbers when reserving songs for karaoke or starting from a desired title/track.

#### 9 ▶ (PLAY) button (18)

Starts playback. Also used as a SELECT button for the PBC of Video CDs/SVCDs. Functions the same as the ▶ (SELECT) button on the remote control unit.

#### 10 ⏸ (PAUSE) button (18)

Pauses playback

#### 11 ■ (STOP) button (18)

Stops playback.

#### 12 ⏮/⏭ (SKIP) button (19)

Used to skip chapter, title or track. Also used for the page selection of a menu screen (for Video CD/SVCD).

#### 13 KARAOKE ON/OFF button (35)

Turns the karaoke function on or off.

#### 14 Display window

Indicates the current status of the unit.

#### 15 RESERVE button (36)

Used to reserve songs to be played back for karaoke.

#### 16 CANCEL button (36)

Cancels reserved songs.

#### 17 MIC 1/2 jacks (35)

Used to connect microphones.

#### 18 MIC 1/2 level controls (35)

Used to control the input level of microphones connected to the MIC 1/2 jacks.



## Remote control unit

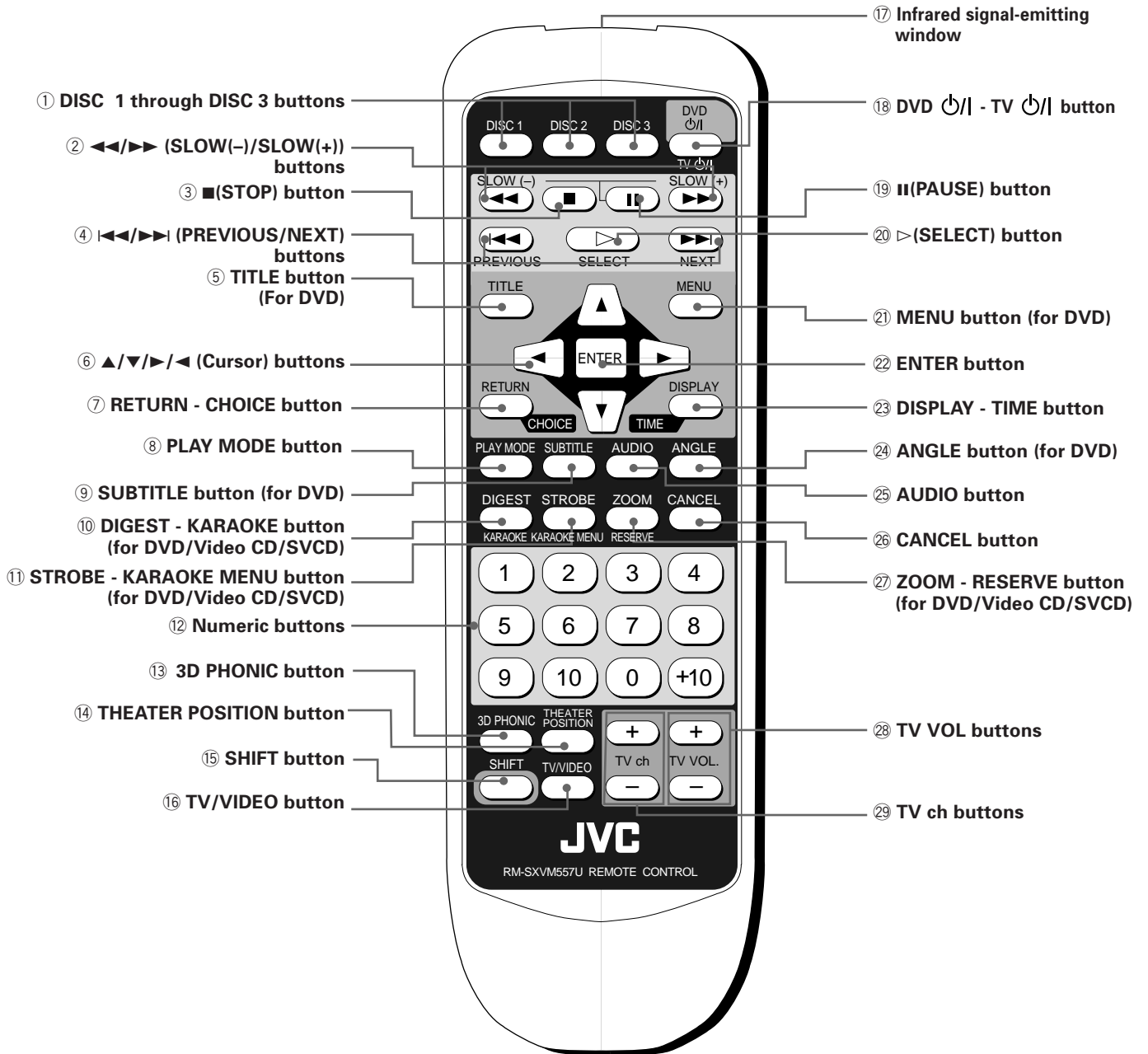

Preliminary Knowledge



- ① **DISC 1 through DISC 3 buttons (18)**  
Used to start playback of the disc in the corresponding tray. Function the same as the 1 through 3 buttons on the front panel.
- ② **◀◀/▶▶ (SLOW(-)/SLOW(+)) buttons (19, 25)**  
Perform rapid advance/reverse playback operations. Also used for slow-motion playback of a picture (for DVD/Video CD/SVCD).
- ③ **■ (STOP) button (18)**  
Stops playback.  
Also used to erase all the programmed tracks for program play.
- ④ **◀◀/▶▶ (PREVIOUS/NEXT) buttons (19)**  
Performs skipping a chapter, title or track.  
Also used for the page selection of a menu screen (for DVD/Video CD/SVCD).
- ⑤ **TITLE button (for DVD) (20)**  
Displays a DVD title menu on the TV screen or monitor.
- ⑥ **▲/▼/▶/◀ (CURSOR) buttons**  
Used to select an item from a menu or on-screen display, or to change the setting of an item in the on-screen display.
- ⑦ **RETURN - CHOICE button (20, 42)**  
Returns to the previous menu (for DVD/Video CD/SVCD).  
When pressed while holding down the SHIFT button, the Preference on-screen display appears on the TV screen.
- ⑧ **PLAY MODE button**  
Displays an on-screen display for controlling the advanced playback functions.
- ⑨ **SUBTITLE button (for DVD/SVCD) (30)**  
Used to display the Subtitle selection display on the TV screen, as well as used to turn the subtitle on or off (for DVD) or select the subtitle (for SVCD).
- ⑩ **DIGEST - KARAOKE button (for DVD/Video CD/SVCD) (23, 35)**  
Displays beginning scenes of each title, chapter, or track on the TV screen.  
Pressing this button while holding down the SHIFT button turns the karaoke function on or off.
- ⑪ **STROBE - KARAOKE MENU button (for DVD/Video CD/SVCD) (24, 37)**  
Displays nine continuous still pictures.  
Pressing this button while holding down the SHIFT button displays the karaoke menu on the TV screen.
- ⑫ **Numeric buttons (10)**  
Mainly used to select a title/track number, or a TV channel. Also used to enter a time for the Time search and a chapter number for the Chapter search.
- ⑬ **3D PHONIC button (32)**  
Produces a simulated surround effect.
- ⑭ **THEATER POSITION button (31)**  
Selects a picture character from 4 settings.
- ⑮ **SHIFT button (16, 33, 35, 42, 45)**  
Used together with other keys for activating their second functions.
- ⑯ **TV/VIDEO button (16)**  
Switches the TV input mode.
- ⑰ **Infrared signal-emitting window**  
Point this window toward the remote sensor on the front panel when pressing buttons.
- ⑱ **DVD ⏻/| - TV ⏻/| button (16, 17)**  
Turns the unit on or off (standby). Pressing this button while holding down the SHIFT button turns the TV on or off.
- ⑲ **⏸ (PAUSE) button (18)**  
Pauses playback.
- ⑳ **▷ (SELECT) button (18)**  
Starts playback. Also used as a SELECT button for PBC of Video CDs/SVCDs.  
Functions the same as the ▷ (PLAY) button on the front panel.
- ㉑ **MENU button (for DVD) (20)**  
Displays a DVD menu on the TV screen or monitor.
- ㉒ **ENTER button**  
Executes the selected item in a menu or on-screen display when pressing the button.
- ㉓ **DISPLAY - TIME button (33)**  
Displays the status information (only for DVD) or the time information (for all types of discs) when the karaoke function is off. When the time information is displayed, pressing this button while holding down the SHIFT button changes the time mode. When the karaoke function is on, pressing this button displays the karaoke menu.
- ㉔ **ANGLE button (for DVD) (29)**  
Changes camera angles during playback of a DVD containing multiple camera angles.
- ㉕ **AUDIO button (31)**  
Selects the audio (for DVD/Video CD/SVCD).
- ㉖ **CANCEL button (26)**  
Cancels the previous settings.
- ㉗ **ZOOM-RESERVE button (for DVD/Video CD/SVCD) (25, 36)**  
Zoom-in for a close-up view of the scene.  
Pressing this button while holding down the SHIFT button displays the karaoke reservation table on the TV screen.
- ㉘ **TV VOL buttons (16)**  
Adjust the TV volume.
- ㉙ **TV ch buttons (16)**  
Changes the TV channels.

## Display window

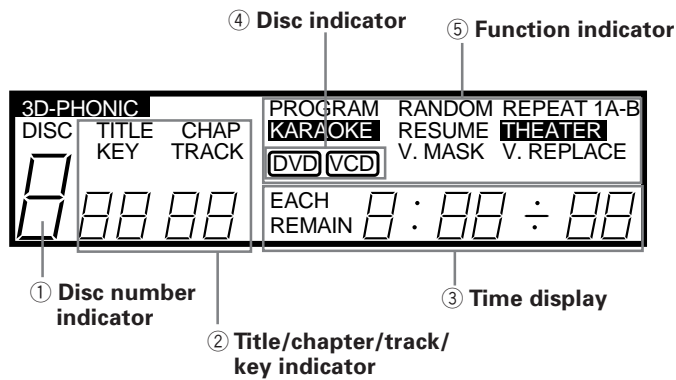

- ① **Disc number indicator**  
Shows the disc number being selected.
- ② **Title/chapter/track/key indicator**  
Usually displays the title/chapter, or track number. When you shift the musical key, the status is displayed. For example, if you lower the key two level, the display shows "-2."
- ③ **Time display**  
Shows the cumulative or remaining time of the track or disc, or the total disc time.
- ④ **Disc indicator**  
Indicates the type of the disc set in the selected tray. When a DVD disc is set, "DVD" is indicated. When a Video CD or SVCD is set, "VCD" is indicated. When an Audio CD is set, there is no indication.
- ⑤ **Function indicator**  
Activated function indicators light up.

## Rear panel

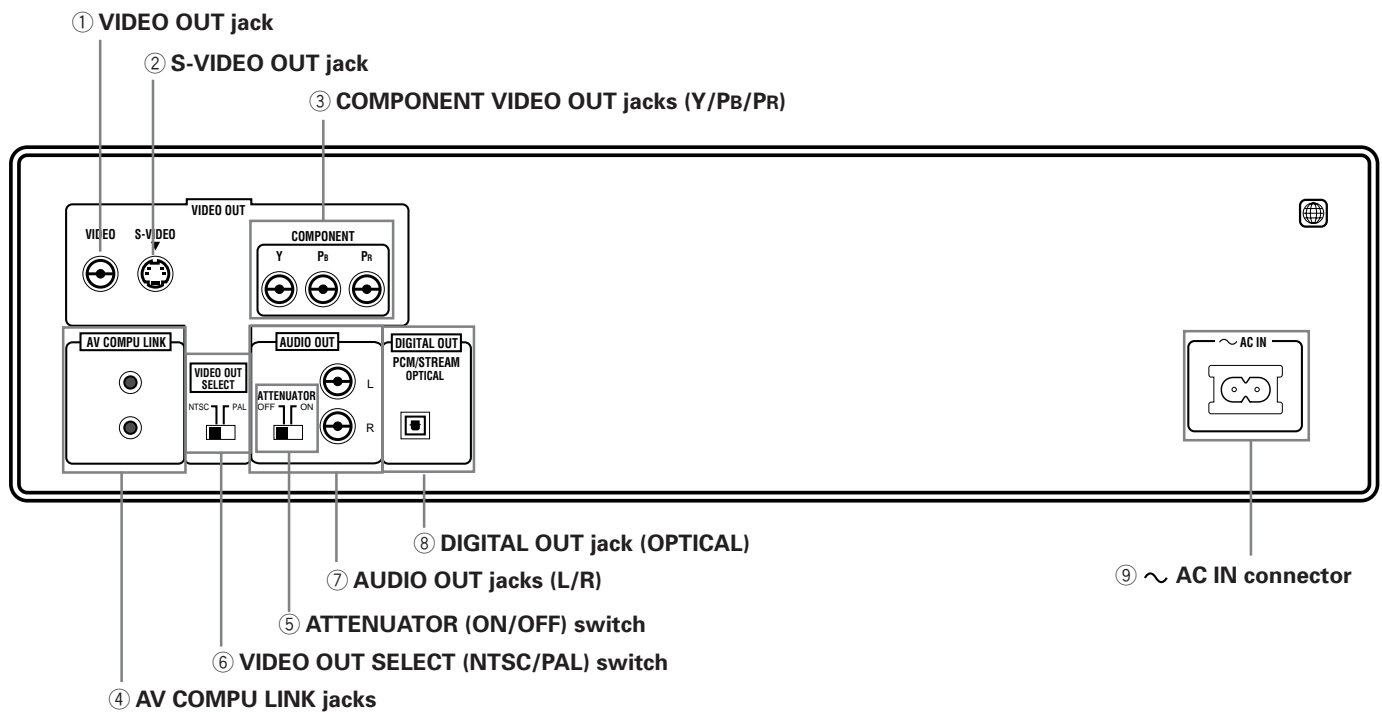

- ① **VIDEO OUT jack (12)**  
Outputs a composite video signal.
- ② **S-VIDEO OUT jack (12)**  
Outputs an S-video signal.
- ③ **COMPONENT VIDEO OUT jacks (Y/Pb/Pr) (13)**  
Outputs component video signals.
- ④ **AV COMPU LINK jacks (48)**  
Connects with other JVC equipment supporting the AV Compulink function to facilitate integrated operations.
- ⑤ **ATTENUATOR (ON/OFF) switch (12)**  
Attenuates the output level when it is set to ON.
- ⑥ **VIDEO OUT SELECT (NTSC/PAL) switch (12)**  
Selects NTSC or PAL according to the color system of your TV.
- ⑦ **AUDIO OUT jacks (L/R) (12)**  
Outputs stereo analog audio signals.
- ⑧ **DIGITAL OUT jack (OPTICAL) (14)**  
Outputs digital audio signals. Only an optical connector is provided.
- ⑨ **~ AC IN connector (14)**  
Connects to the wall outlet using the supplied AC power cord.

# Operational Principles

## On-screen displays

The unit provides several on-screen displays. With some displays, you can set or select preferences or functions, while the others are display-only.

### Opening displays

The Opening display appears automatically in some conditions. At the bottom, the following information are indicated depending on the unit's status.

- NOW READING: The unit is now reading the disc information (TOC).
- REGION CODE ERROR!: The DVD disc loaded cannot be played because the region code of the disc does not match the unit.
- CHANGE → DISC 1: The unit is now changing the disc tray to DISC 1.
- OPEN: The selected tray is now opening.
- CLOSE: The selected tray is now closing.

### Preference displays

When the unit is stopped, pressing the RETURN-CHOICE button while holding the SHIFT button accesses the preference display for setting the preferences. There are four pages: LANGUAGE, AUDIO, DISPLAY and SYSTEM as shown in the right. See page 42 for detailed information.

Opening display

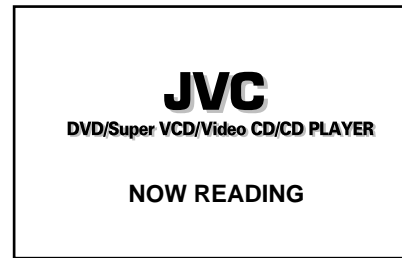

LANGUAGE

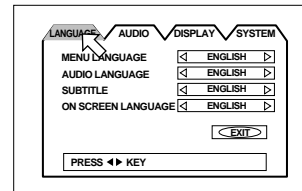

AUDIO

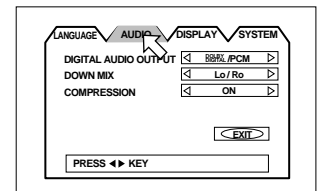

DISPLAY

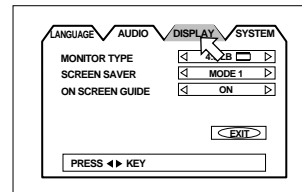

SYSTEM

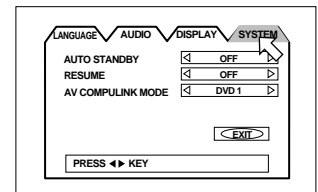

### PARENTAL LOCK displays

When no disc is inserted or a DVD disc is stopped in the selected disc tray, pressing the ENTER button while holding down the SHIFT button accesses the PARENTAL LOCK display in which you can set the level for limiting playback. See page 46 for detailed information.

PARENTAL LOCK

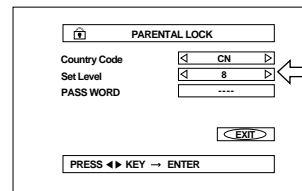

### Play mode displays

Pressing the PLAY MODE button accesses the play mode display in which you can control playback functions. Different displays appear depending on the disc type and the unit's status.

While stopped

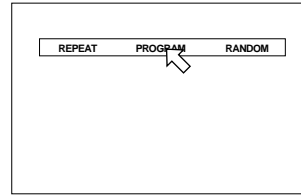

During DVD playback

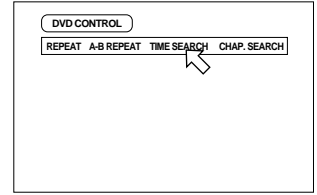

During Audio CD playback

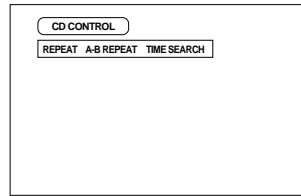

During Video CD/SVCD playback

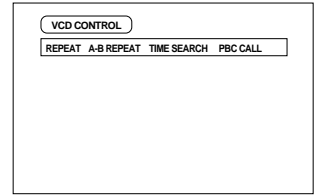

### Status displays

Pressing the DISPLAY-TIME button during playback accesses the status display. For a DVD disc, pressing the DISPLAY-TIME button toggles between the DVD function status display and the disc/time display and off. For a Video CD or Audio CD disc, pressing the DISPLAY-TIME button switches the disc/time display on and off.

DVD function status

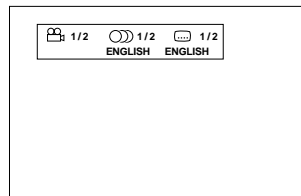

Disc/time (DVD)

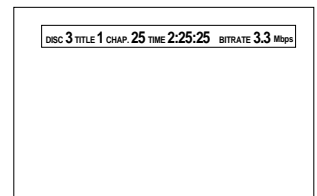

Disc time (Audio CD/Video CD/SVCD without PBC)

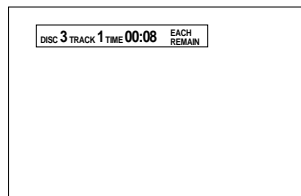

Disc time (Video CD/SVCD with PBC)

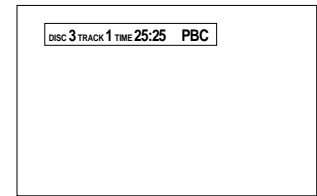

### Karaoke setting displays

When karaoke mode is on, pressing the DISPLAY-TIME button, or pressing the STROBE-KARAOKE MENU button while holding down the SHIFT button accesses the karaoke menu display in which you can set several karaoke functions.

Pressing ZOOM-KARAOKE RESERVE button while holding down the SHIFT button accesses the karaoke reservation display in which you can reserve songs to be played.

Karaoke function display

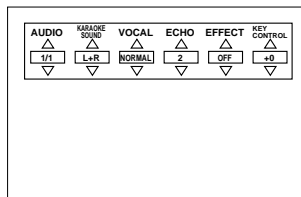

Karaoke reservation

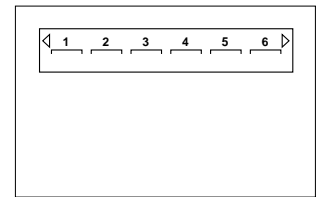

## To prevent the monitor from burning out [SCREEN SAVER]

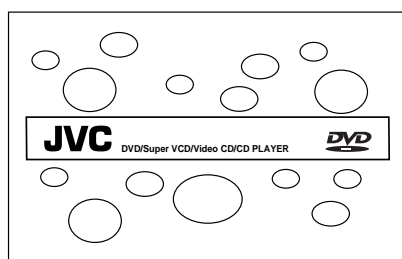

A television monitor screen may be burned out if a static picture is displayed for a long time. To prevent this, the unit automatically activates the screen saver function if a static picture, such as an on-screen display or menu, is displayed for over 5 minutes.

- Pressing any button on the unit or the remote control unit will release the screen saver function and return to the previous display.
- You can select one of several screen saver modes available (see page 44).
- The screen saver function is not activated during Audio CD playback or after stopping Audio CD playback.

## On-screen guide icons

During DVD playback, you may see icons displayed over the picture. These have the following meanings.



: Displayed at the beginning of a scene recorded from multiple angles. (See page 29.)





: Displayed at the beginning of a scene recorded with multiple audio languages. (See page 31.)



: Displayed at the beginning of a scene recorded with multiple subtitle languages. (See page 30.)

You can set the unit not to display on-screen icons above via the preference settings described on page 44.

### About invalid operation icon

When you press a button, if the unit does not accept its operation,  appears on your television screen. Operations are occasionally unacceptable even if  is not displayed.

Note that some operations may not be accepted. For example, some discs may not allow rapid advance/reverse or slow-motion playback.

## How to use numeric buttons

### To select a track/title number

- **To select a number between 1 and 10**  
Press the corresponding button for the number.
- **To select a number higher than 10**  
Use the +10 button.

Examples:

To select 13    +10 → 3

To select 34    +10 → +10 → +10 → 4

To select 40    +10 → +10 → +10 → 10

### To enter a time or chapter number

The method for entering a time for Time search or chapter number for Chapter search is different from above. See the corresponding sections in this manual for the details.

### To select a TV channel.







Press the corresponding numeric buttons (between 0 and 9) while holding down the SHIFT button.

# About discs

## Playable disc types

Playable and non-playable disc types are as follows:

### Playable discs

DVD VIDEO	Video CD	SVCD	Audio CD
	 	 	

The DVD Logo is a trademark.

- DVD players and DVD discs have their own Region Code numbers. This unit only can play back DVD discs whose Region Code numbers include the unit's Region Code, which is indicated on the region code symbol on the rear panel.

Examples of playable DVD discs if the unit's Region Code is "2":



### Non-playable discs

DVD-ROM, DVD-RAM, DVD Audio, DVD-R, DVD-RW, CD-R, CD-ROM, PHOTO CD, CD-RW, CD-EXTRA, CD-G, CD-TEXT

- Playing back discs listed as "Non-playable discs" in the table above may generate noise and damage speakers.
- This unit can play back audio recorded in CD-G, CD-EXTRA and CD-TEXT discs.

**NOTE**

- With some DVD, Video CD and SVCD discs, you may not be able to control them according to the instructions described in this manual, because of the contents of the disc.

## Disc structure

A DVD disc is comprised of "titles," while an Audio CD, Video CD or SVCD is comprised of "tracks." Each title may be divided into some "chapters." For example, if a DVD disc contains some movies, each movie may have its own title number, and each movie may be divided into some chapters. In a DVD karaoke disc, each song usually has its own title number and does not have chapters. In general, each title has independent content, while each chapter in the same title has continuity.

(Example: DVD disc)

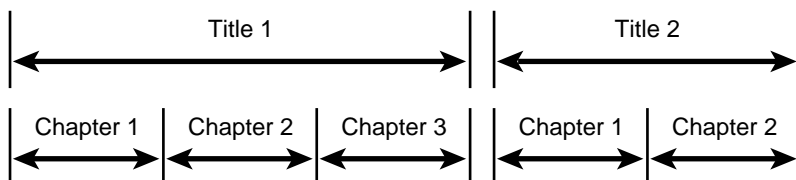

(Example: Audio CD/Video CD/SVCD)

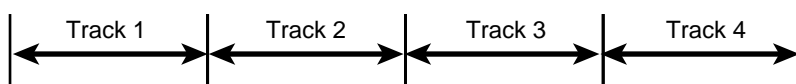

## Connections

\*In the following description, "TV" may be substituted with "monitor" or "projector."

\*Before using the unit, you have to connect the unit to a TV and/or amplifier.

### Before making any connections

- Do not connect the AC power cord until all other connections have been made.
- Since different components often have different terminal names, carefully read the instructions supplied with the component you are going to connect.

### To connect to a TV

You can enjoy using the unit by simply connecting it to a TV. To improve audio sound quality, connect the audio outputs to your separate audio equipment. (See the following pages.)

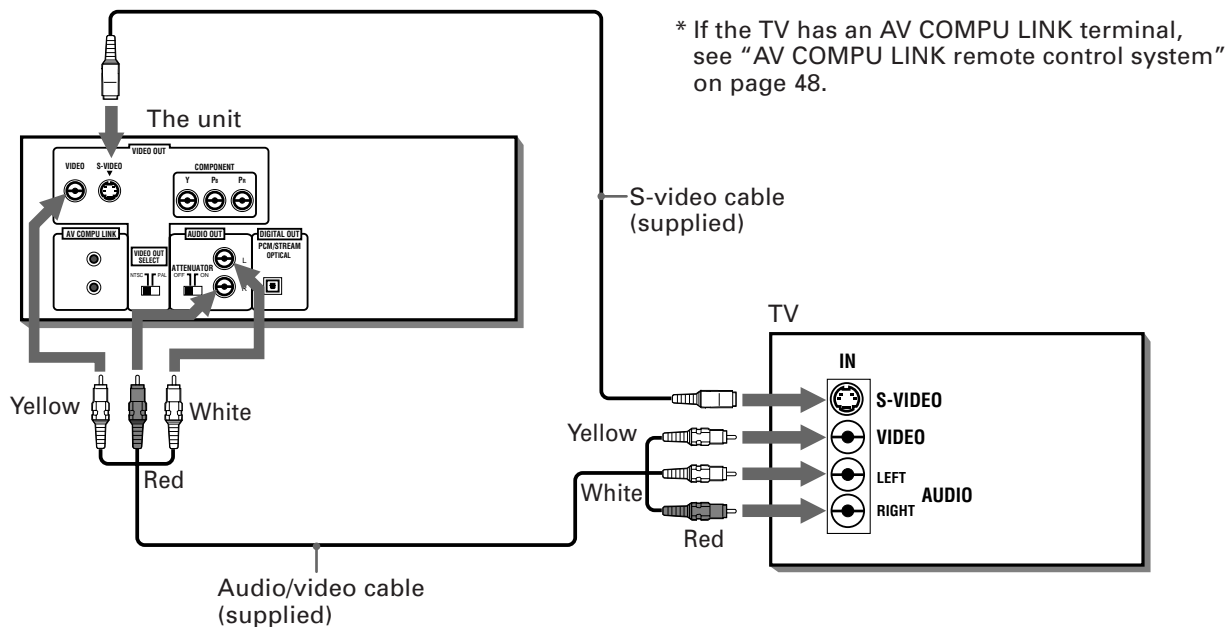

Connect the unit to a TV equipped with stereo audio input and video input jacks using the supplied audio/video cables.

- If your TV has a monaural audio input instead of stereo, you need to use an optional audio cable which converts stereo audio output to monaural.
- If your TV has an S-video input, you should connect it with the S-VIDEO output of the unit using the supplied S-video cable in addition to the (standard) video connection to get better picture quality.
- The ATTENUATOR switch should be normally set to OFF. If you hear distorted audio because the sensitivity of the TV's audio input is too high, set this switch to ON.

The unit is compatible with the PAL and NTSC color systems. Set the VIDEO OUT SELECT switch on the rear panel to match the color system of your TV. Make sure that the color system of the DVD/Video CD/SVCD disc labeled on the package matches your TV.

If you use a multi-system TV, you can play discs recorded on both PAL and NTSC systems.

#### NOTE

- Connect VIDEO OUT of the unit directly to the video input of your TV. Connecting VIDEO OUT of the unit to a TV via a VCR may cause a monitor problem when playing back a copy-protected disc.



## To connect to a TV with the component video input jacks

You can enjoy high picture quality by connecting the unit's COMPONENT VIDEO OUT jacks to the COMPONENT VIDEO IN jacks of your TV with the video cables.

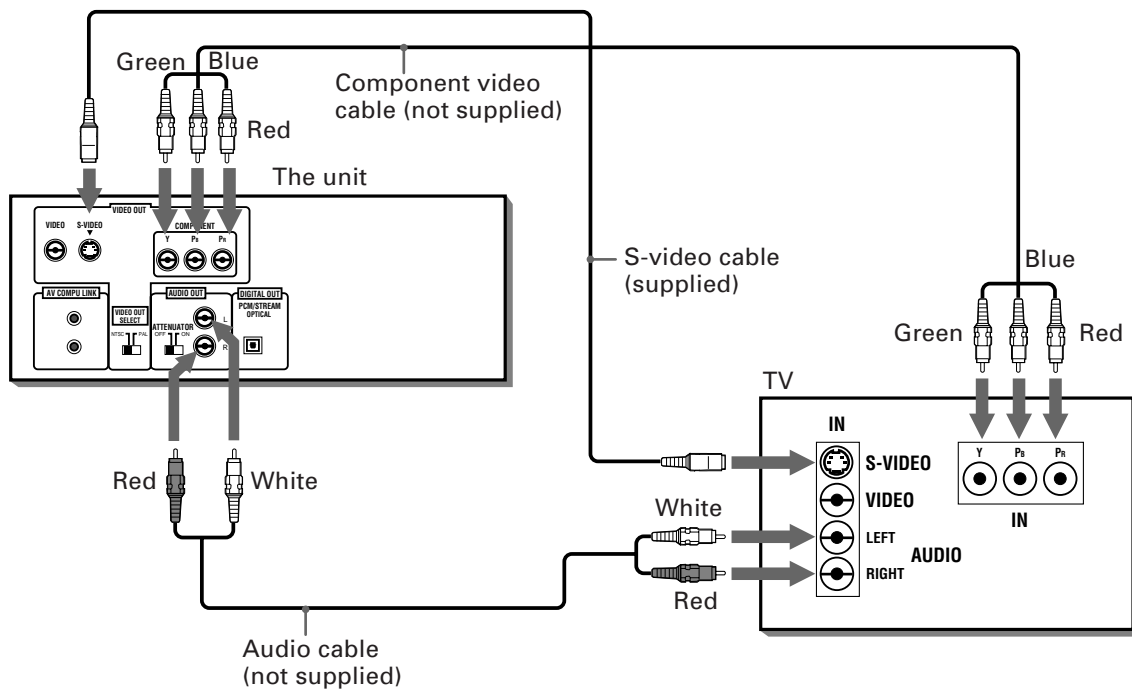

- Connect "Y" to "Y," "PB" to "PB," and "PR" to "PR" correctly.

### NOTES

- When the component video input jacks of the TV are of the BNC type, use an adapter to convert the pin jacks to BNC jacks (optional).
- If you do not connect the unit with the S-video cable, some functions of your TV may not work.

## To connect to an audio amplifier or receiver

You can enjoy high-quality audio by connecting the unit's audio output to your amplifier or receiver.

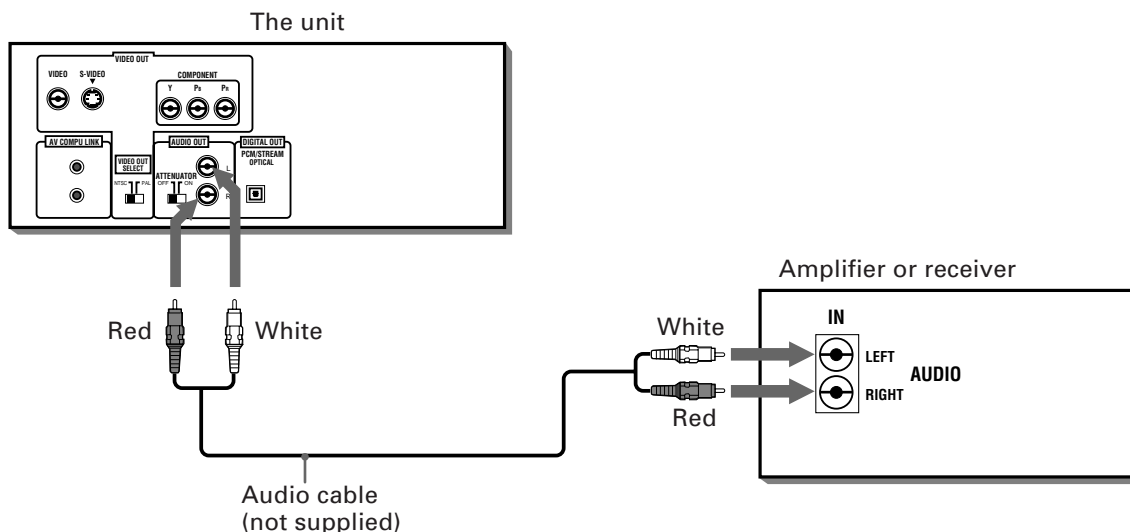

- Connect the unit's AUDIO OUT to any line-level inputs (such as AUX, DVD, CD, etc.) of an audio amplifier or receiver.

## To connect to audio equipment with a digital input

You can enhance the sound quality by connecting the unit's DIGITAL OUT (optical) to the digital input of an amplifier, DAT or MD by using an optional digital cable. The digital stereo audio signal from a disc is directly transferred. If you connect the unit to a Dolby Digital, DTS or MPEG Multichannel decoder or an amplifier with a built-in decoder by using an optional digital cable, you can enjoy high-quality surround sound.

When you make the digital connection, also make the analog connection, because, depending on the disc type, no audio may be reproduced from the DIGITAL OUT.

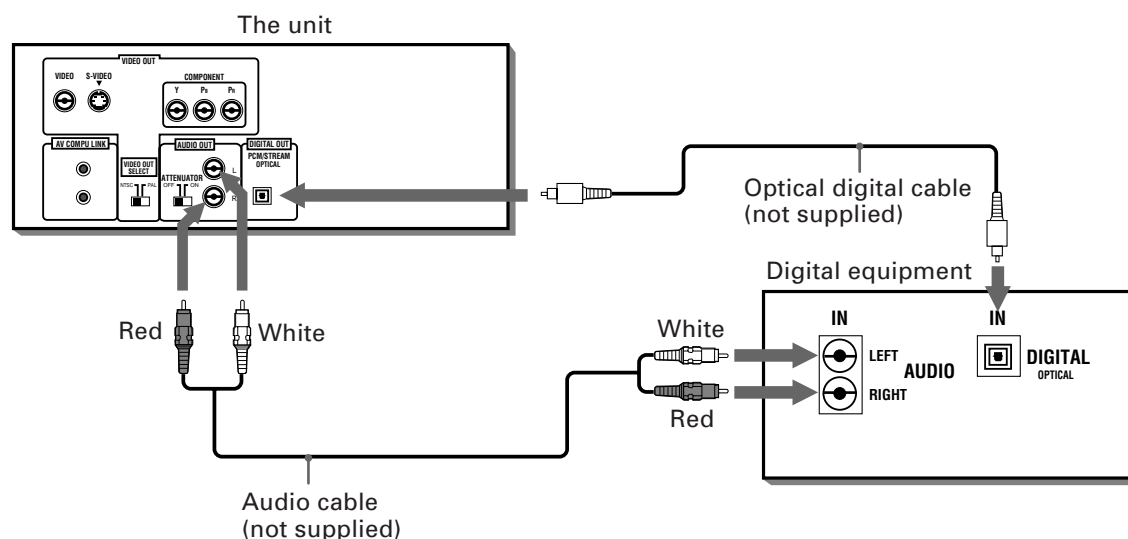

- For digital connection, connect the unit's DIGITAL OUT (optical) to the digital input of audio equipment using an optional digital cable.

### NOTES

- When you connect the unit's DIGITAL OUT to digital audio equipment, before using, make the "DIGITAL AUDIO OUTPUT" setting in the "AUDIO" page of the preference display correctly according to the connected audio equipment. If the "DIGITAL AUDIO OUTPUT" is not set correctly, loud noise may be generated from speakers, causing damage to your speakers. See "DIGITAL AUDIO OUTPUT" on page 43.
- With the digital connection, the unit's settings for COMPRESSION and DOWN MIX in the AUDIO page of the preference display are invalid. Settings for these items must be made from the decoder.

## To connect the power cord

When all the audio/video connections have been made, insert the smaller plug of the supplied AC power cord to the unit's AC IN connector, then insert the other end to the wall outlet. Make sure that plugs are inserted firmly. The STANDBY indicator lights and setup is completed.

### Warning

- Disconnect the power cord if you are not going to use the unit for a long time.
- Disconnect the power cord before cleaning the unit.
- Disconnect the power cord before moving the unit.
- Do not connect or disconnect the power cord with wet hands.
- Do not pull the power cord when disconnecting it, as this may damage the cord and cause fire, electric shock, or other accidents.

### Caution

- Do not damage, alter, twist, or pull the power cord, as this may cause fire, electric shock, or other accidents.
- To prevent any accidents or damages caused by an unsuitable AC power cord, only use the supplied power cord. If the cord is damaged, contact a dealer and get a new power cord.
- Do not put anything heavy, or the unit, on the power cord, as this may cause fire, electric shock, or other accidents.

## Using the remote control unit

Using the remote control, you can operate not only all the functions of the unit, but also basic functions of your TV.

### To install batteries in the remote control unit

The battery compartment is located on the back of the remote control unit.

- 1 Press down on the point shown by the arrow at the top of the compartment cover, and pull up the cover to open the compartment.

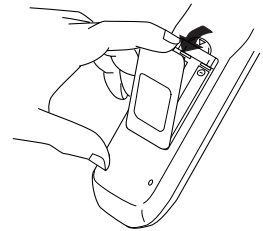

- 2 Place the two accessory R6P (SUM-3)/AA(15F) batteries in the remote control according to the polarity markings (“+” and “-”) inside the compartment and on the batteries.

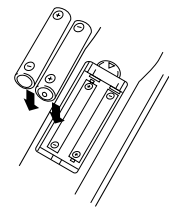

- 3 Place the cover over the compartment, and press down lightly.

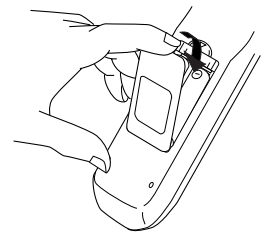

- The batteries will last about six months with normal use. If the functions of the remote control become erratic, replace the batteries. See below for more information.

### Precautions for the safe use of batteries

Observe the following precautions for the safe use of batteries. If they are used improperly their life will be shortened, they may burst or their contents may leak.

#### Precaution

- Remove the batteries from the remote control if it is not going to be used for a long period of time.
- Remove dead batteries and dispose of them properly.
- Never leave dead batteries lying around, take them apart, mix them with other refuse, or throw them into an incinerator.
- Never touch liquid that has leaked out of a battery.
- Do not mix new and old batteries, or batteries of different types, when replacing them.

## To use the remote control unit for TV operation

You can operate your TV from the remote control unit.

### Setting the remote control signal for operating your TV.

- 1 Holding down TV/VIDEO, enter the manufacturer code of your TV listed below by using the numeric buttons (0 - 9). Do not release TV/VIDEO. Keep holding it until the next step is completed.

#### Manufacturer code list

No.	Manufacturer
01	JVC
02	PANASONIC
03	SONY
04	SHARP
05	TOSHIBA/BEIJING/CHANGHONG
06	MITSUBISHI/CHANGHONG
07	HITACHI
08	SANYO
09	FUNAI
10	AIWA
11	DAEWOO
12	SAMSUNG
13	LG (GOLDSTAR)
14	THOMSON
15	FERGUSON
16	PHILIPS/TCL/CHANGHONG
17	GRUNDIG





No.	Manufacturer
18	ITT
19	MIVER
20	FINLUX
21	NOKIA
22	NEC
23	JINXING/PEONY
24	PEONY
25	PEONY/CHANGHONG
26	KONKA
27	PEIJIN/NOBLEX
28	TCL

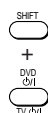

#### Example:

To enter the manufacturer code "01":  
Press "0" then "1."

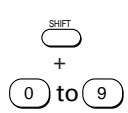
- 2 Press  while holding down TV/VIDEO.

The following buttons can be used for operating the TV:

	Turns the TV on or off.
	Changes the TV channels.
	Adjusts the TV volume.
	Selects the TV channels *For some TVs, pressing "+10" while holding down SHIFT functions as the "RETURN" button, and pressing "10" while holding down SHIFT functions as the "- / -" button.
	Switches input mode (either TV or VIDEO).

- 3 Try to operate your TV by pressing DVD  - TV  while holding SHIFT. If your TV turns on or off, you have successfully set the control signal.

#### NOTES

- The remote control unit is initially set for operating a JVC TV.
- If there is more than one code listed for the manufacturer of your TV, try them one by one until you succeed.

# Basic operations



In the following description, the buttons on the remote control unit are used, however, you may use the corresponding buttons on the front panel of the unit if available.

## Turning on/off the unit

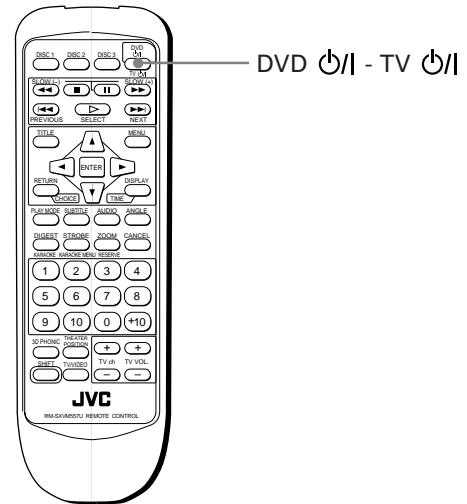
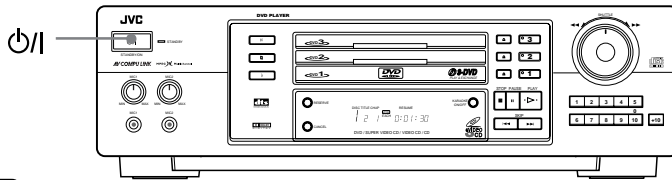
Press  on the front panel or press DVD  - TV  on the remote control unit.



### Hints

- You can turn on the unit by pressing the  (PLAY) button or any one of 1 through 3 buttons on the front panel or, the  button or any one of DISC 1 through 3 buttons on the remote control unit. In this operation, the unit starts playback if the disc is set in the selected tray.
- You can also turn on the unit by pressing any one of the  (OPEN/CLOSE) buttons on the front panel.

### NOTE

- Even if you press the  or DVD  - TV  button to turn off the unit, the unit is not disconnected from the AC power source as long as it is connected to the wall outlet. This state is called the standby mode. In this state, the unit is designed to consume a very small quantity of power.

## Inserting and removing discs

Up to three discs can be set in the unit. You may insert a disc into any of disc trays 1 through 3.

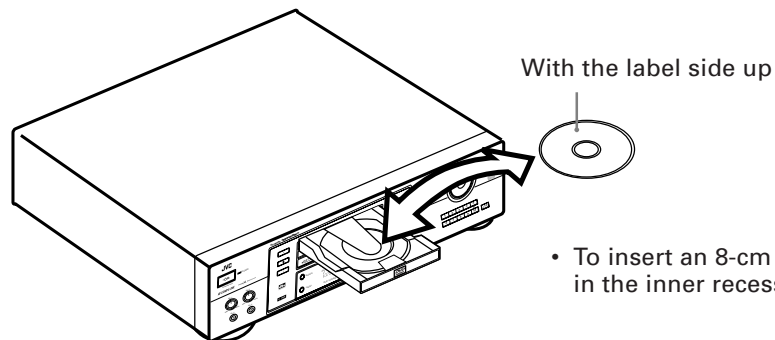

- 1 Press  (OPEN/CLOSE) located on the right of the tray corresponding to disc number. The corresponding disc tray opens.
- 2 Place the disc in the tray.



- To insert an 8-cm disc, place it in the inner recess.

- 3 Press  (OPEN/CLOSE) to close the disc tray.

### Hints

- If you press  (OPEN/CLOSE) for the disc being played, the unit stops and then opens the tray.
- You can change, insert or remove the disc by pressing  (OPEN/CLOSE) for a disc tray which is not in use for playback while the disc in another tray is being played, without stopping play.

### NOTES

- The unit can playback DVD, Audio CD, Video CD and SVCD discs only. Do not load other disc types. For details about playable disc types, see page 11.
- When loading a disc in the tray, be sure to position the disc inside the recess. Otherwise, the disc may be damaged when the tray is closed, and the disc may not be removed from the unit.

## Basic playback

Now you can play a disc. First, let's enjoy simple playback according to following procedure.

### To start playback



Press  $\triangleright$ ,  
or

press one of the DISC buttons (1 through 3) on the front panel or DISC 1 through 3 on the remote control unit.

The unit starts playback from:

- the selected disc indicated in the display window when pressing  $\triangleright$
- or
- the corresponding disc when pressing a DISC button.

The indicator on the DISC button (1 - 3) on the front panel corresponding to the disc being played flashes.

In both cases above, the unit basically plays back all discs in the trays continuously in the following sequence and then stops.

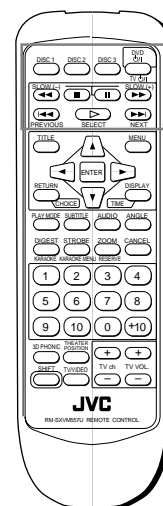

Basic control buttons

- With a DVD disc or a Video CD/SVCD disc with PBC function, or when the Karaoke function is activated, the unit does not automatically playback the next disc. To playback the next disc in such a case, press the corresponding disc button.

#### NOTES

- The 1 through 3 buttons on the front panel function the same as the respective DISC 1 through 3 buttons on the remote control unit.
- During playback, the display window shows the disc number and the title/chapter or track number being played.
- When the resume point is memorized, the unit starts playback from that point instead of the beginning. See page 19.
- With Video CD or SVCD discs with PBC control or some DVD discs, the menu display may appear on the TV screen after starting playback. In such a case, select an item to be played back from the menu.  
For operation using a menu, see page 20.
- With some DVD discs, the unit starts playback automatically after inserting the disc.

### To stop playback completely



Press  $\blacksquare$ .

The unit stops playback.

### To stop playback temporarily



Press  $\parallel$ .

The unit pauses playback. To continue playback, press  $\triangleright$ .

## To advance or reverse play rapidly while monitoring

DVD Audio CD Video CD Super VCD

### ■ During playback

#### From the remote control unit

Press ►► or ◀◀.

Pressing ►► advances playback rapidly, while pressing ◀◀ reverses playback rapidly. Each time you press the button, advance or reverse playback speed increases. To return to normal playback, press ▷.

#### From the front panel

Use the SHUTTLE knob.

To advance playback rapidly, turn the shuttle knob to the right and hold, and to reverse play rapidly, turn the shuttle knob to the left and hold. When you release the shuttle knob, the unit returns to normal playback. The playback speed changes according to the amount you turn the shuttle knob.

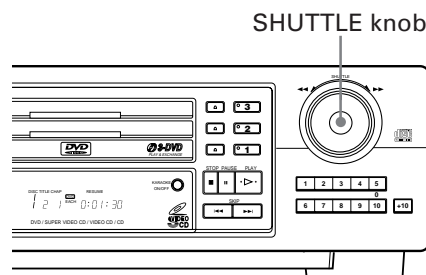

## To locate the beginning of the scene or song

DVD Audio CD Video CD Super VCD

### ■ During playback

Press ►►| or |◀◀.

Press |◀◀ to locate the beginning of the current chapter, title, or track, and press ►►| to locate the beginning of the next chapter, title, or track.

#### NOTE

When you play a Video CD/SVCD disc with the PBC function or a DVD disc, the unit may locate a different place, but it will generally locate the beginning of the title or chapter or track.

## To resume playback

DVD Video CD Super VCD

When RESUME on the SYSTEM page of the preference display is set to ON, the unit memories the position on a disc where you interrupt playback and resumes playback from that position next time you press ▷. (See Page 45.)

When the unit memorizes the resume position, "RESUME" is displayed in the display window.

### ■ When the disc you interrupted playback last time remains selected and stopped:

Press ▷.

The unit starts playback from the position where you interrupted playback last time.

#### ● To clear the memory of the resume position

Take out the disc from the unit, or press ■ while stopped.

#### NOTES

- Pressing a DISC button (1-3) does not activate the resume function. It always starts playback from the beginning.
- The resume function does not work with Audio CD discs.
- The resume function does not work if RESUME on the SYSTEM page of the preference display is set to OFF.
- You can store the position where you interrupt playing by pressing ■, as well as by turning the unit off.
- In the case of a Video CD/SVCD disc with PBC function, the unit may resume playback from a point slightly earlier than the resume point you stored.
- The resume function does not work in the program or random mode.



# Advanced operations

When you operate the functions described below while stopped, make sure that the desired disc number is selected by checking the the disc indicator in the display window. If it is not selected, press the corresponding DISC button to start playback and then press ■.

## Playing from a specific position on a disc

You can play a disc from the selected track, title or chapter, or from the specified time.

### To locate a desired scene from the DVD menu



DVD discs generally have their own menus which show the disc contents. These menus contain various items such as titles of a movie, names of songs, or artist information, and display them on the TV screen. You can locate a desired scene by using the menu.

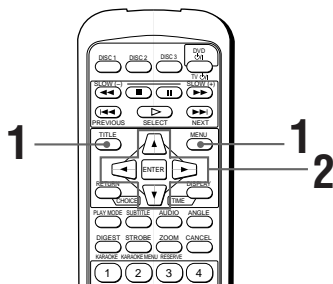

■ Whenever a DVD disc is loaded

#### 1 Press MENU or TITLE.

The menu appears on the TV screen.



#### About menu

Normally, a DVD disc which contains more than one title may have a "title" menu which lists the titles. In this case, the menu appears on the TV screen by pressing the TITLE button. Some DVD discs may also have a different menu which appears by pressing the MENU button.

Example

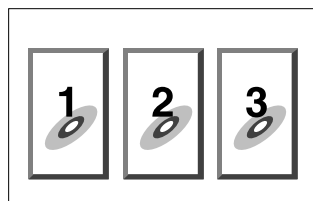

See the instructions of each DVD disc for its particular menu.

#### 2 Use CURSOR ◀/▶/▲/▼ to select a desired item, then press ENTER.

The unit starts playback of the selected item.



With some discs, you can also select items by entering the corresponding number using the numeric buttons, which may cause the unit to automatically start playback.

### NOTES

- When appears on the TV screen by pressing TITLE in step 1:  
The disc does not have a menu listing the titles.
- When appears on the TV screen by pressing MENU in step 1:  
The disc does not have a menu.
- The MENU button does not work while stopped.

### To locate a desired scene from the menu of the Video CD with PBC



Some Video CD discs are compatible with the PBC function. PBC is an abbreviation of "PlayBack Control." A Video CD disc recorded with PBC has its own menus, such as a list of the songs of the disc and items recorded on the disc. You can also locate a specific scene by using the menu.

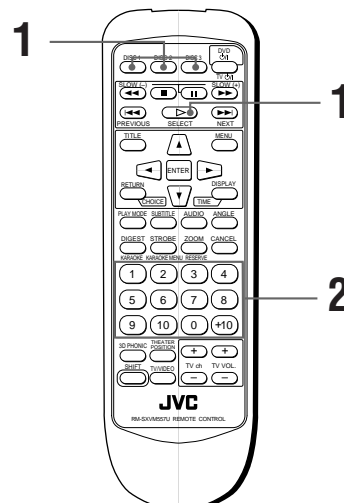

■ When a Video CD disc with PBC is stopped

#### 1 Press ▷ or the corresponding DISC (1-3) button.

A disc menu appears on the TV screen (The PBC function is activated).

Example:

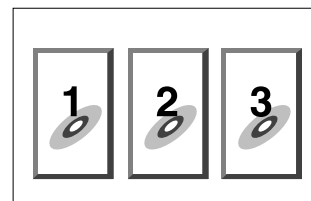

"Pbc" is indicated in the display window on the front panel.

#### 2 Use the numeric buttons to select the desired number of the item.

- See page 10 for details about how to use the numeric buttons.

Playback starts from the selected item.

You can return to the menu by pressing RETURN.

When "NEXT" or "PREVIOUS" appears on the TV screen, the unit generally works as follows:

- Pressing ►► advances to the next page.
- Pressing ◀◀ returns to the previous page.
- \* The method of the operation is different depending on the disc.

**Hints**

- To activate the PBC function when a PBC-compatible Video CD or SVCD disc is being played back without the PBC function, press ■ then press ▷.
- You can also activate the PBC function using the play mode menu display as follows.
  1. Press PLAY MODE.
  2. Use the ◀▶ buttons to move to [PBC CALL], then press ENTER.
- If you want to playback a PBC-compatible Video CD or SVCD disc without activating the PBC function, start playback by using the numeric buttons instead of the ▷ button. See the next paragraph.

**To locate a desired title or track directly**

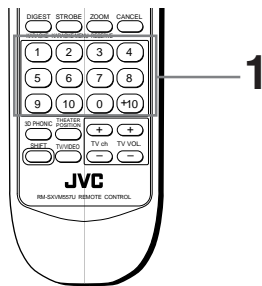

You can play a desired title for DVDs or track for Audio CD/Video CD/SVCD.

- For DVD: While stopped
- For Audio CD: Whenever an Audio CD disc is loaded
- For Video CD/SVCD: During playback without PBC function or while stopped

**1** Use the numeric buttons to select the desired title or track number.

- See page 10 for details about how to use the numeric buttons.

The selected title or track number appears in the display window on the front panel.

Display window

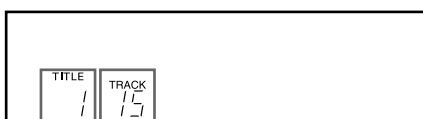

Selected track number (for Audio CD/Video CD/SVCD)  
Selected title number (for DVD)

The unit starts playback from the selected title or track.

**NOTES**

- When ⊘ appears on the TV screen. The title or track you have selected is not contained in the disc.
- This function does not work during Video CD/SVCD playback with PBC function

**To locate a desired chapter or track using ►► or ◀◀**

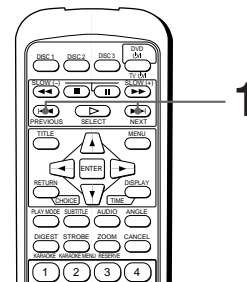

- For DVD: During playback
- For Audio CD: During playback
- For Video CD/SVCD: During playback without PBC function

**1** Press ►► or ◀◀.

The selected chapter or track number appears in the display window on the front panel.

Display window

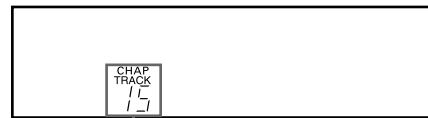

Selected chapter or track number

- To skip to a succeeding track, press ►► once or repeatedly until the desired track appears in the display.
- To skip to beginning of the current track, press ◀◀ once.
- To skip to a preceding track, press ►► repeatedly until the desired track appears in the display.

**NOTES**

- This function may not work with some DVD discs.
- This function does not work during Video CD/SVCD playback with PBC function

## To locate a desired scene by specifying the chapter number [CHAP. SEARCH]

DVD

If the current title of a DVD disc being played is divided into chapters, you can skip to a desired chapter by specifying the chapter number using the on-screen display.

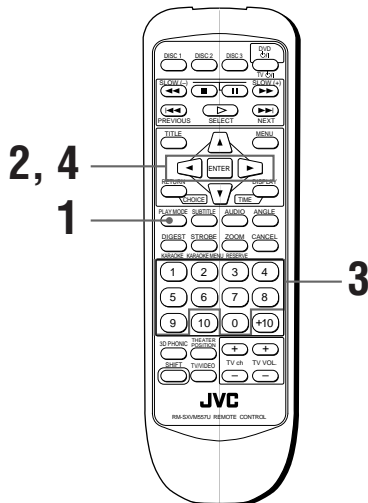

### ■ During DVD playback

#### 1 Press PLAY MODE.

The DVD play mode menu is superimposed on the TV screen.

#### 2 Use CURSOR ◀▶ to move to [CHAP. SEARCH], then press ENTER.

"GO TO CHAPTER =" appears under the menu.

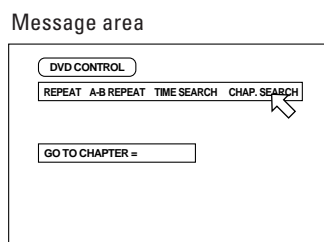

#### 3 Use the numeric buttons (0 ~ 9) to enter the desired chapter number.

Example:

To select chapter number 8: Press "8" → ENTER.

To select chapter number 37: Press "3" → "7" → ENTER.

#### 4 Press ENTER.

The unit starts playback from the selected chapter.



The "10" and "+10" buttons are not used in this function.

### NOTES

- When the chapter number is incorrect in step 3: Overwrite the incorrect number with the correct number.
- When  is displayed in the TV screen in step 4: The chapter you have selected is not contained in the disc, or chapter search does not work on the disc.
- With some discs, the unit automatically starts searching for the chapter after entering the chapter number in step 3.
- To turn off the play mode menu: Press PLAY MODE.

## To locate a desired position in the current title or track [TIME SEARCH]

DVD Audio CD Video CD Super VCD

You can play a disc from the desired position by specifying the elapsed time from the beginning of the current title or track using the TIME SEARCH function. Note that some DVD discs do not contain time information, and the TIME SEARCH function cannot be used.

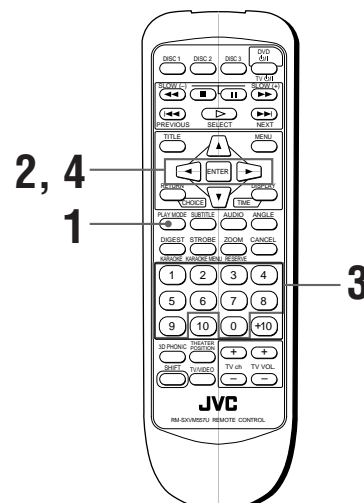

- For DVD: During playback
- For Audio CD: During playback
- For Video CD/SVCD: During playback without PBC function

#### 1 Press PLAY MODE.

The play mode menu appears on the TV screen.

#### 2 Use CURSOR ◀▶ to move to [TIME SEARCH], then press ENTER.

"GO TO" appears under the menu.

#### 3 Use the numeric buttons (0 ~ 9) to enter the time.

You can specify the elapsed time of the current title or track to set the location which you want to playback from.

## 4 Press ENTER.

The unit starts playback from the specified time.

(for DVD)

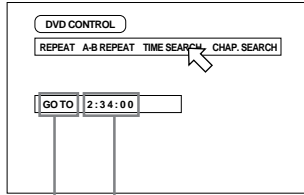

Message area Selected time

(for Audio CD)

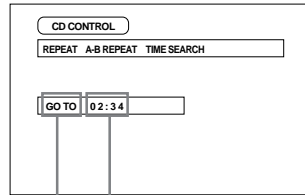

Message area Selected time

### Hints

- "10" and "+10" buttons are not used in this function.
- You can specify the time in hour/minute/second format for DVD discs, and in minute/second format for Audio CD, Video CD and SVCD discs.

(for Video CD/SVCD)

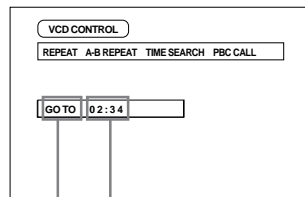

Message area Selected time

Example (for DVD):

To playback from 2(H):34(M):00(S)

GO TO \_ : \_ : \_

↓ Press "2".

GO TO 2 : \_ : \_

↓ Press "3".

GO TO 2 : 3 \_ : \_

↓ Press "4".

GO TO 2 : 3 4 : \_

↓

Press ENTER.

You do not have to press "0" to enter the trailing zeros (for the last two digits in the example above). Of course, it is possible to enter them.

- When you make a mistake

Move the cursor to the incorrect value, then press the correct button to re-select the value.

GO TO 2 : 3 5 : \_

↓ Press CURSOR ←.

GO TO 2 : 3 \_ : \_

↓ Press "4".

GO TO 2 : 3 4 : \_

### NOTES

- When appears on the TV screen in step 2: The time you have selected is not contained on the disc, or the time search function does not work on the disc. Also note that the time search function does not work during Video CD/SVCD playback with the PBC function.
- To turn off the play mode menu: Press PLAY MODE .

## To locate a desired scene from the opening scene digest display [DIGEST]



The unit can display the opening scene of each title or chapter on a DVD or each track of a Video CD/SVCD. You can select a desired scene from those displayed on the TV screen.

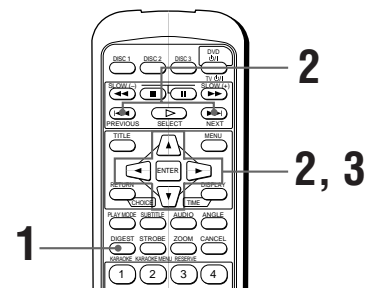

- For DVD: While stopped or during playback
- For Video CD/SVCD: While stopped or during playback without PBC function.

If you use the Digest function while stopped, make sure that the disc number indicator on the front-panel display shows the desired number. If it does not, select the disc before operating the following procedure by pressing the corresponding DISC (1 - 3) button to start playback, then press ■.

## 1 Press DIGEST - KARAOKE.

Up to nine opening scenes are displayed.

- While a DVD disc is stopped: The opening scene of each title appears on the TV screen.
- During DVD disc playback: The opening scene of each chapter in the current title appears on the TV screen.
- When a Video CD or SVCD disc is loaded: The opening scene of each track appears on the TV screen .



**2** Use CURSOR  $\leftarrow/\rightarrow/\uparrow/\downarrow$  or  $\lll/\ggg$  to select the desired scene.

The selected scene is indicated by .

If there are more than 9 scenes, the digest screen will have more than one page. In this case, pressing CURSOR  $\rightarrow$  or  $\ggg$  when selecting the lower right scene advances to the next page, while pressing CURSOR  $\leftarrow$  or  $\lll$  when selecting the upper left scene returns to the previous page.



Selected scene

**Hints**

When there is more than one digest page, after pressing DIGEST, pressing  $\ggg$  before all 9 scenes of the first page appear on the TV screen will advance to the next page. Similarly, pressing  $\lll$  before all the scenes of the second or latter page appear on the TV screen will return to the previous page.

**3** Press ENTER.

The unit starts playback from the selected title or track.

**NOTE**

- With some discs, depending on the contents, it may take some time until all the scenes appear on the screen.

## Special picture playback

The unit provides special picture playback functions including Frame-by-frame, Strobe, Slow-motion and Zoom.

### To advance a still picture frame-by-frame

DVD Video Super VCD

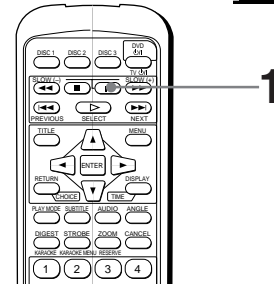

■ While paused (still)

**1** Press **II**.

Each time you press **II**, the still picture advances to the next frame.

Pressing  $\rightarrow$  returns to the normal playback mode.

### To display still pictures [STROBE]

DVD Video Super VCD

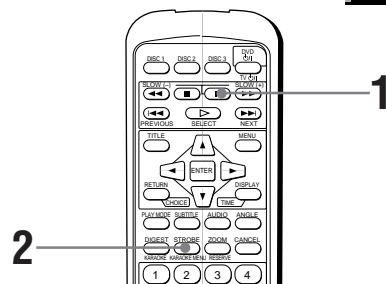

■ During playback

**1** At the point you want to view as continuous photographs, press **II**.

The unit pauses playback.

**2** Press STROBE - KARAOKE MENU.

Nine continuous still pictures appear on the TV screen.

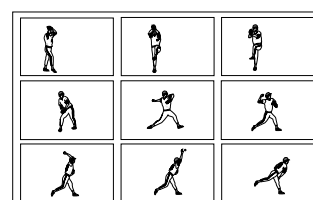

**Hints**

- Pressing **II** when the nine still pictures appear will advance to the next nine still pictures.

• **To cancel strobe play**

Press STROBE.

**NOTES**

- Pressing and holding **II** for more than 1 second also activates the Strobe function.
- If you press STROBE during playback, nine still pictures also appear but they advance in realtime.

**To playback in slow-motion [SLOW]**



- During playback

**From the remote control unit**

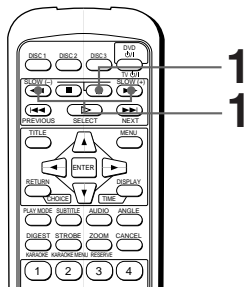

**1** Press **II**, then press **▶▶** or **◀◀**.

To play forward slow-motion, press **▶▶**, and to play reverse slow-motion (for DVD discs only), press **◀◀**. First, the unit plays the slowest speed, and each time you press these buttons, the playback speed increases.

**From the front panel**

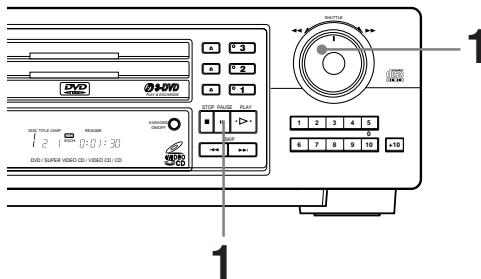

**1** Press **II** (PAUSE), then use the SHUTTLE knob.

To play forward slow-motion, turn the SHUTTLE knob to the right. To play reverse slow-motion (for DVD discs only), turn it to the left. The more you turn the knob, the more the slow-motion speed increases.

• **To return to normal playback**

Press **▷**.

• **To pause slow-motion playback**

Press **II**.

**NOTES**

- The sound is muted during slow-motion playback.
- Reverse slow-motion playback is not possible for a Video CD/SVCD.

**To zoom a scene [ZOOM]**

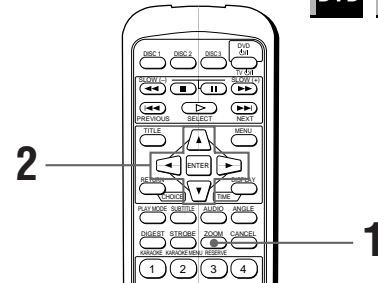

- During playback or while paused

**1** Press ZOOM - RESERVE.

"ZOOM" appears on the TV screen.

The unit zooms in to the center part of the scene to produce a double-sized image.

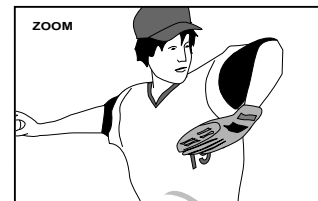
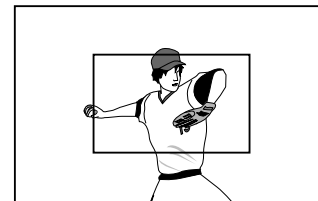

**2** Use CURSOR **◀/▶/▲/▼** to move the zoomed-in scene.

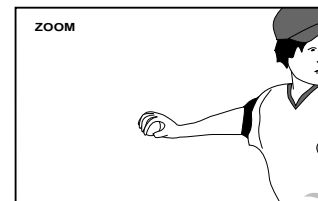

• **To pause zoom play**

Press **II**.

To resume zoom play, press **▷**.

• **To return to normal playback**

Press ZOOM - RESERVE.

**NOTE**

- During Zoom play, the picture may be garbled or noisy.

# Changing the playback order

You can play titles and tracks on the discs inserted in the desired order or in random order.

## To playback titles/tracks in the desired order [PROGRAM]



You can play titles or tracks on the discs inserted in the desired order by using the Program function.

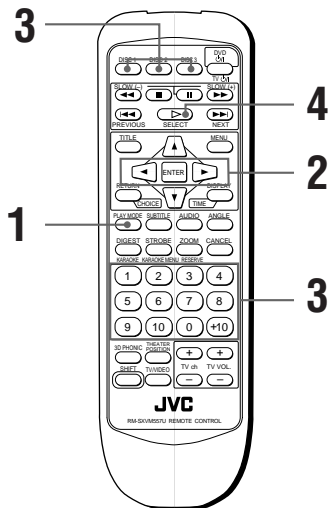

■ While stopped

### 1 Press PLAY MODE.

The play mode menu appears on the TV screen.

### 2 Use CURSOR $\leftarrow/\rightarrow$ to move $\leftarrow$ to [PROGRAM] and press ENTER.

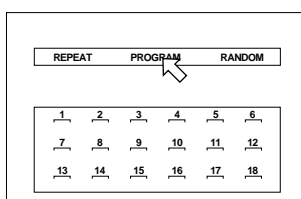

The program table appears under the menu bar (as shown above).

The "PROGRAM" indicator appears in the display window on the front panel.

### 3 Specify the disc by a DISC (1-3) button and then the title or track by the numeric buttons.

Up to 18 titles or tracks can be programmed by repeating this procedure.

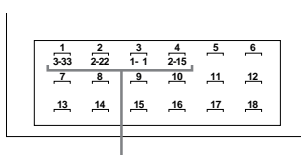

The programmed disc number and title/track number are shown under each program number.

#### • When you specify a wrong selection

Press CANCEL. The last selection programmed is erased.

#### • To clear the program

Press ■.

### 4 Press $\triangleright$ to start program play.

When all of the programmed titles/tracks have finished playback, the unit stops but the program remains.

#### NOTES

- Some DVD discs may not be played back correctly in program mode.
- During program playback, you can use  $\lll$  and  $\ggg$  to skip to the previous/next selection of the program.
- By pressing PLAY MODE during program playback, the program table is displayed on the TV screen and the current program number is indicated in yellow.
- In program mode, the DISC buttons are invalid.

#### • To quit program playback

Press ■ twice.

The "PROGRAM" indicator in the display window turns off.

Note that the program remains.



While stopped and the play mode menu is displayed on the TV screen, by moving  $\leftarrow$  to [PROGRAM] and pressing ENTER, the program mode quits and the program is cleared.



## To playback titles or tracks in random order [RANDOM]



You can play titles or tracks on the discs inserted in random order by using the Random function.

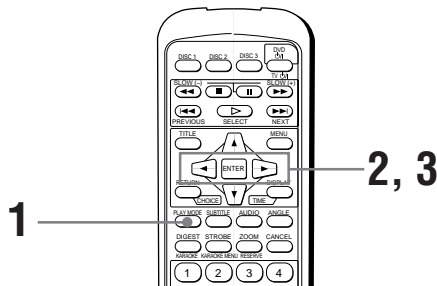

■ While stopped

### 1 Press PLAY MODE.

The play mode menu appears on the TV screen.

### 2 Use CURSOR ◀▶ to move to [RANDOM].

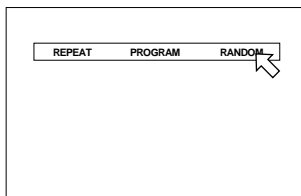

The "RANDOM" indicator appears in the display window on the front panel.

### 3 Press ENTER.

The unit starts random playback of the selected disc.

When all titles/tracks of the disc have been played once, the unit starts random playback of the next disc (if inserted). After playing all titles/tracks of the second disc, the unit starts random playback of the third disc (if inserted). After playing all titles/tracks of all the discs, random playback ends.



The same title or track will not be played back more than once during random play.

#### • To stop/quit random playback in the middle

Press ■ to stop playback. The unit is still in random playback mode, so pressing ▷ starts random playback again.

To quit random playback, press ■ again while stopped. The "RANDOM" indicator in the display window turns off.

#### NOTE

Some DVD discs may not be played back correctly in random mode.

## Repeat playback

You can repeat playback of the current title or chapter (for DVD) or current track (for Audio CD/Video CD/SVCD), or all discs inserted. You can also repeat playback of a desired part.

## To repeat a current title, chapter or track, or all discs [REPEAT]

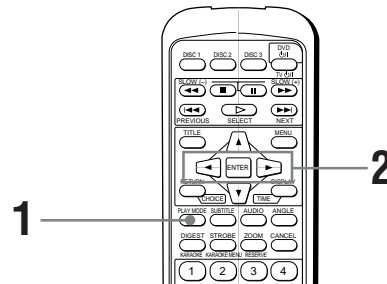

■ In any condition except Video CD/SVCD playback with PBC

### 1 Press PLAY MODE.

The play mode menu appears on the TV screen.

### 2 Use CURSOR ◀▶ to move to [REPEAT], then press ENTER.

Each time you press ENTER, the repeat mode changes as follows:

#### • During DVD playback

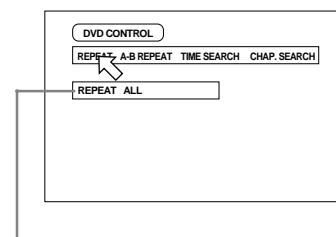

The selected repeat mode appears on the TV screen.

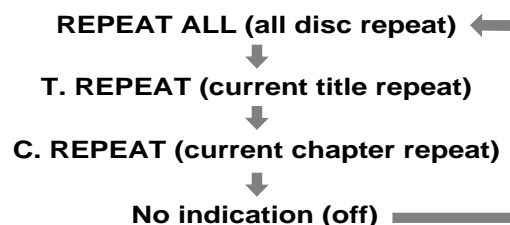

• During Audio/Video CD/SVCD playback

(for Audio CD)

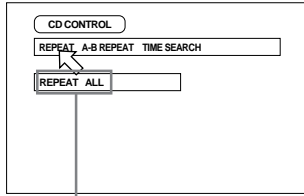

Selected repeat mode

(for Video CD/SVCD)

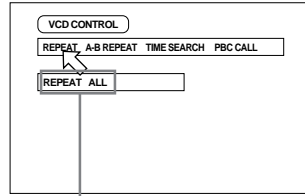

Selected repeat mode

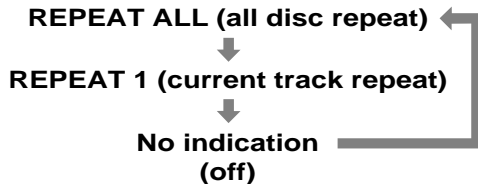

• While stopped

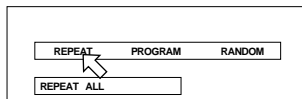

• To stop repeat playback

Press ■.

Hints

- If you press ■ in REPEAT ALL mode, the unit stops playback but remains in the mode.
- If you press ■ in REPEAT1, TITLE REPEAT or CHAPTER REPEAT mode, the unit stops playback and quits the mode.

• To quit repeat playback

With pointed to [REPEAT], press ENTER repeatedly until the mode is set to off.

**NOTES**

- Some DVD discs do not allow the title repeat or/and chapter repeat.
- Some DVD discs automatically stops playback in the middle of the disc.  
If you execute REPEAT ALL with such a DVD disc inserted, when it automatically stops playback in the middle of the disc, the unit starts playback of the next disc.
- In the REPEAT ALL mode, if the next disc is a PBC-compatible Video CD/SVCD disc, the unit plays the disc without PBC function.
- Repeat playback function cannot be used during Video CD/SVCD playback with PBC function.
- To turn off the play mode menu display  
Press PLAY MODE.

**To repeat a desired part [A-B REPEAT]**

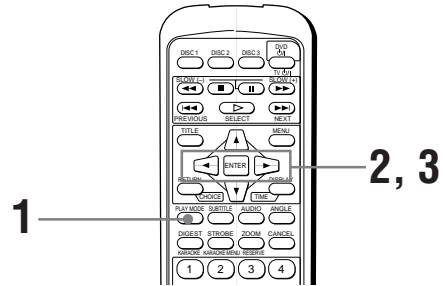

■ During playback

1 Press PLAY MODE.

The play mode menu appears on the TV screen.

2 Use CURSOR to move to [A-B REPEAT], then press ENTER at the beginning of the part you want to repeat (point A).

Make sure that REPEAT mode is off. If any one of the REPEAT modes is selected, you cannot move to [A-B REPEAT].

3 Press ENTER at the end of the part you want to repeat (point B).

The unit locates "A" and starts repeat playback between "A" and "B."

(for DVD)

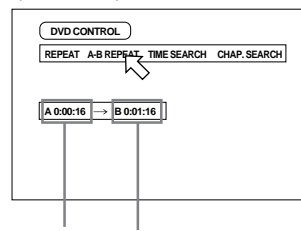

Point A Point B

(for Audio CD)

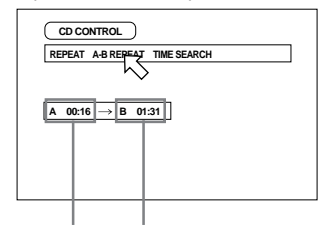

Point A Point B

(for Video CD)

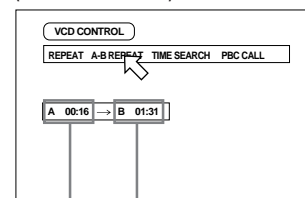

Point A Point B

**To quit A-B repeat playback**

Press ■. The unit stops playback and quits A-B repeat mode.



- During playback, pressing ENTER when [A-B REPEAT] is pointed at [A-B REPEAT] quits A-B repeat mode and continues playback.
- You can also quit A-B repeat mode by pressing I◀◀ or ▶▶I.

**NOTES**

- **To turn off the play mode menu**  
Press PLAY MODE.
- If ⊘ appears when pressing ENTER in step 2 during DVD playback  
You cannot repeat the selected portion because of the disc contents.

# Viewing from multiple angles

You can enjoy a variety of scene angles if the DVD disc contains "multi-angle" parts, where multiple cameras were used to shoot the same scene from different angles.



At the beginning of "multi-angle" parts, 🎥 appears on the TV screen.

## To select a scene angle from the normal screen [ANGLE]

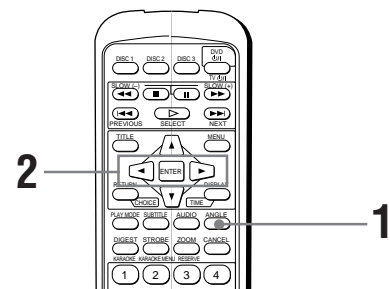

■ During DVD playback

### 1 Press ANGLE.

The Angle selection display appears on the TV screen.

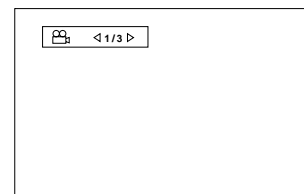

### 2 Press ANGLE or CURSOR ◀/▶ to select the desired angle.

Each time you press ANGLE or CURSOR ◀/▶, the angle changes.

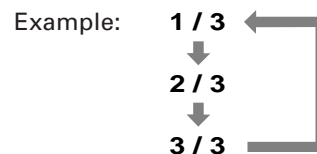

**NOTES**

- The Angle selection display will automatically disappear if you do not change the angle for 10 seconds.
- To turn off the Angle selection display manually, press ENTER.
- When ⊘ appears on the TV screen  
The current scene is not recorded from multiple angles.

## To select a scene angle from the angle list display [ANGLE]

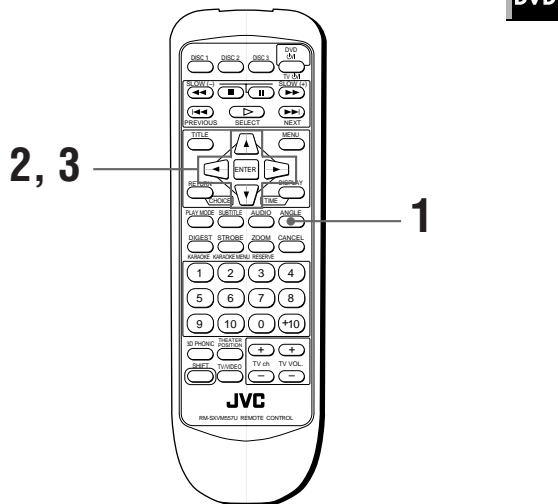

■ During DVD playback

**1** Press and hold ANGLE for more than 1 second.

Up to nine camera angles recorded on a disc appear on the TV screen.

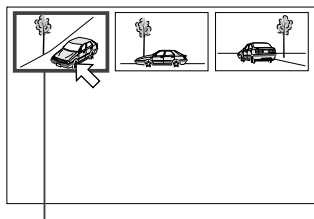

The selected camera angle

**2** Use CURSOR  $\blacktriangle/\blacktriangledown/\blacktriangleleft/\blacktriangleright$  to select the desired angle.

**3** Press ENTER.

■ The selected angle appears on the TV screen.

### NOTES

- When  $\text{⊗}$  appears on the TV screen in step 1: The current scene is not recorded from multiple angles.
- During the operation above, audio is muted.

## Changing the language and sound

For DVD and SVCD discs, you can select the subtitle language, as well as the audio language/sound included on a disc. For Video CD and SVCD discs, you can select the audio channel(s).

### To select the subtitle language [SUBTITLE]

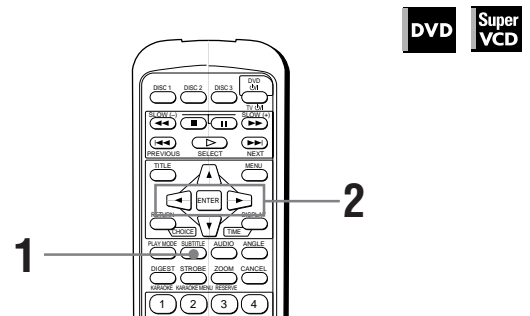

■ During playback

**1** Press SUBTITLE.

The Subtitle selection display appears on the TV screen. For DVD, pressing SUBTITLE while the subtitle selection display is shown on the TV screen turns the subtitle on or off.

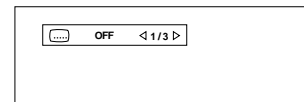

**2** To select the subtitle language, press CURSOR  $\blacktriangleleft/\blacktriangleright$ .

• For DVD

Pressing CURSOR  $\blacktriangleleft/\blacktriangleright$  cycles among the subtitles recorded on the disc.

Example:

1/3 ENGLISH  
↓  
2/3 FRENCH  
↓  
3/3 SPANISH  
↓  
-3 (off)

• For SVCD

Pressing CURSOR  $\blacktriangleleft/\blacktriangleright$  cycles among the four subtitle channels as follows regardless of whether the subtitles are recorded or not. You can also select the subtitle by pressing SUBTITLE.

OFF -/4  
↓  
1/4  
↓  
2/4  
↓  
3/4  
↓  
4/4

### NOTES

- The Subtitle selection display will automatically disappear if you do not change the subtitle for 10 seconds.
- To turn off the Subtitle selection display manually, press ENTER.
- For DVD, the selected language may abbreviated on the TV screen. See "Appendix A: Table of languages and their abbreviations" at the end of this manual.
- When  $\text{⊗}$  appears on the TV screen: You cannot select the subtitle.

## To change the audio language or sound [AUDIO]



By AUDIO selection, you can choose the audio language of movies or choose to enjoy karaoke with or without the guide vocal.

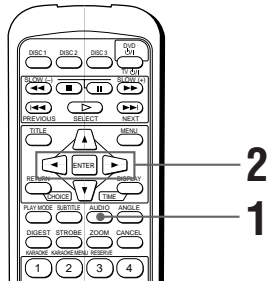

■ During playback

### 1 Press AUDIO.

The Audio selection display appears on the TV screen.

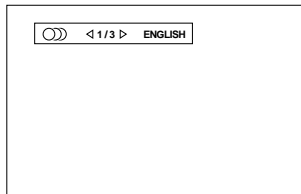

### 2 Press AUDIO or CURSOR <|> to select the desired audio.

• For DVD

Each time you press AUDIO or CURSOR <|>, the audio language or sound changes.

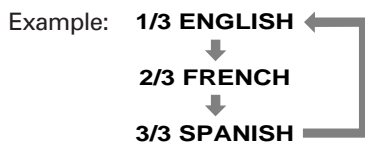

• For Video CD/SVCD

Each time you press AUDIO or CURSOR <|>, the playback audio changes.

Example:

(For Video CD)

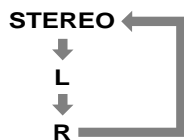

(For SVCD)

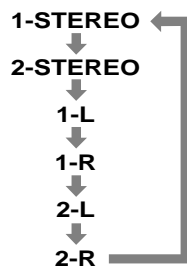

### NOTES

- The Audio selection display will automatically disappear if you do not change the audio for 10 seconds.
- To turn off the Audio selection display manually, press ENTER.
- When  appears on the TV screen: You cannot select the audio.

## Selecting the picture character

You can select the quality of the image from among four options (OFF, 1, 2 and 3) according to the type of programming, picture tone or personal preferences.

## To select the picture character [THEATER POSITION]

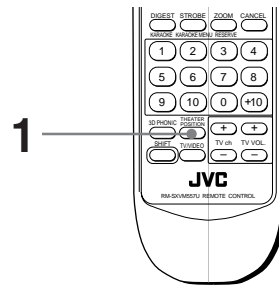

■ During playback

### 1 Press THEATER POSITION to select the desired picture character.

Each time you press the button, the picture character changes as follows:

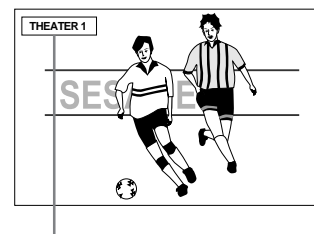

Selected effect mode

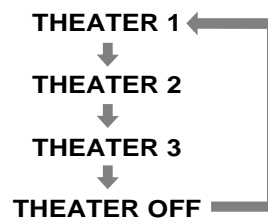

“OFF” is the normal position. Selecting a higher number tones down the picture character.

## Enjoying virtual surround sound

Using the 3D Phonic function, you can get a simulated surround effect from your stereo system.

### To simulate surround sound [3D PHONIC]

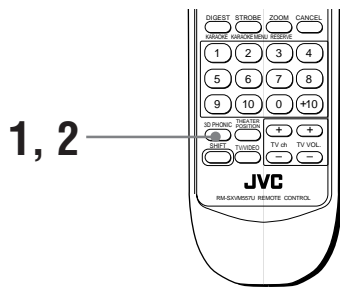

■ During playback

**1** Press 3D PHONIC.

**2** Select the desired effect mode by pressing 3D PHONIC.

Each time you press 3D PHONIC, the effect mode changes as follows:

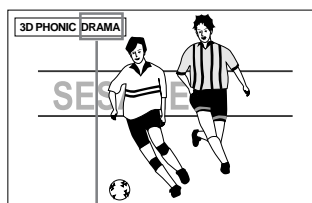

Selected effect mode

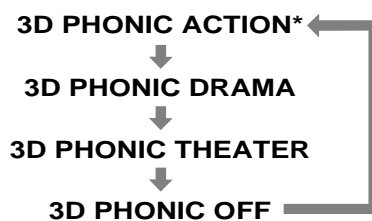

\* When you play a DVD disc recorded in Dolby Digital which contains more than 3 channels, ACTION does not appear.

### NOTES

- The 3D phonic function works correctly when playing back discs recorded in the Dolby Surround or Dolby Digital 5.1-CH format.  
It also works when playing back discs other than those above, but does not provide the correct effect.
- The 3D Phonic function does not affect the DTS or Dolby Digital bitstream signal from the DIGITAL OUT jack.
- The sound effect will not be set or operate, even if 3D PHONIC is pressed, for the sound of DVD discs recorded in Linear PCM.
- When you set the 3D PHONIC function to on, the DOWN MIX and COMPRESSION settings in the AUDIO page of the preference display are disabled.

# Checking the status

You can check the disc/time information, as well as the DVD functions, of the current disc.

## To check the disc/time information

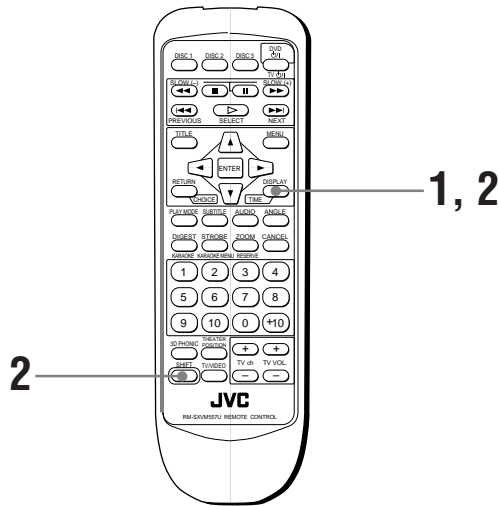

■ During playback

- 1 Press DISPLAY-TIME once for an Audio CD, Video CD or SVCD disc, or twice for a DVD disc.

The disc/time display appears on the TV screen.

(for DVD)

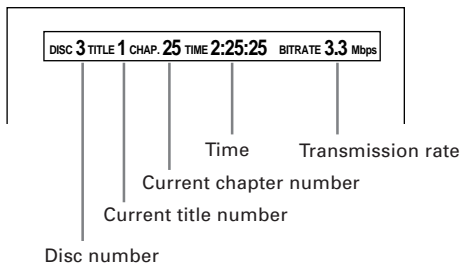

(for Audio CD, or Video CD/SVCD playing without PBC)

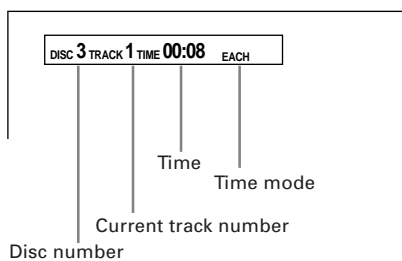

(for Video CD/SVCD playing with PBC)

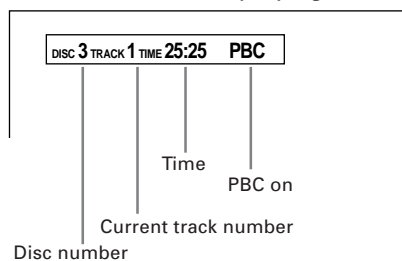

- 2 To change the time display mode (only for Audio CD or Video CD/SVCD without PBC), press DISPLAY-TIME while holding down SHIFT.

The time display mode cycles as below.

(for Audio CD)

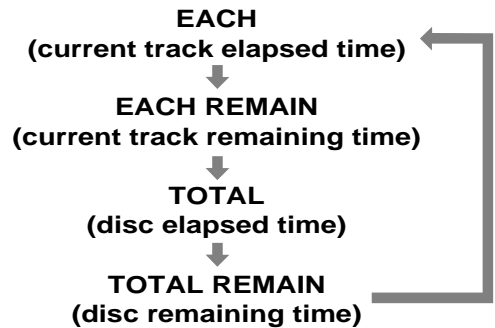

(for Video CD/SVCD without PBC)



The selected time information is displayed on the TV screen, as well as in the front panel display window.

■ While stopped

You can check the total disc time and current (selected) track time of an Audio CD/Video CD/SVCD only from the front panel display window.

- 1 Press DISPLAY - TIME while holding down SHIFT.

When EACH and REMAIN are indicated, the current (selected) track time appears. When only REMAIN is indicated, the total disc time appears.



You can change the current (selected) track by pressing |◀◀ or ▶▶|.

• To turn off the disc/time display

Press DISPLAY-TIME.



## To check the DVD function status

**DVD**

- During DVD playback

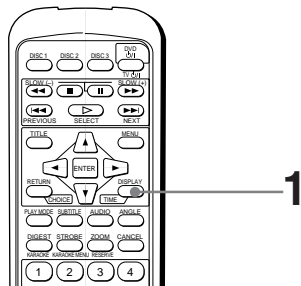

### 2 Press DISPLAY – TIME.

The DVD function status display appears on the TV screen.

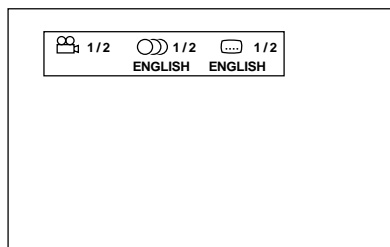

The current selections of the camera angle, audio language and subtitle language are displayed.

- **To turn off the DVD function status display**

Press DISPLAY-TIME twice.

## Preparation

### Turning on the KARAOKE function



(From the remote control unit)

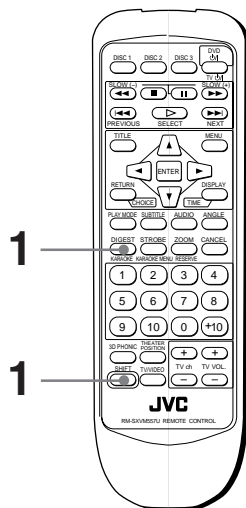

(From the front panel)

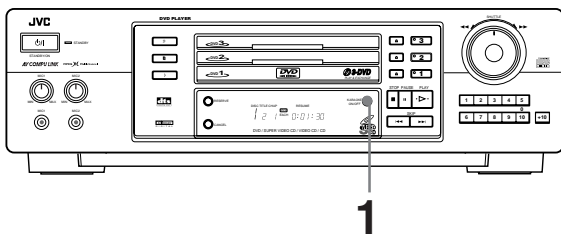

- 1 Press DIGEST-KARAOKE while holding down SHIFT to turn on the KARAOKE function (or press KARAOKE on the front panel).

Each time you perform the operation above, the karaoke function switches on and off.

When "on," "KARAOKE" appears in the display on the front panel.

(Display window)

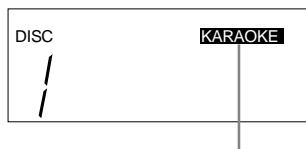

KARAOKE function indicator

#### NOTE

- When playing back a DVD recorded with linear PCM audio, you cannot turn on the KARAOKE function.
- During program or random playback, you cannot turn on the KARAOKE function.

## Connecting microphones

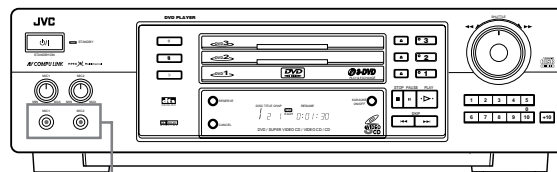

- 1 Connect microphone(s) to the MIC 1/2 jack(s) on the front panel.

#### NOTES

- While an Audio CD disc is selected (not only during playback but also while stopped), the input signals from the MIC 1/2 jacks are not output from the DIGITAL OUT jack.
- To adjust the microphone volume, use MIC 1/2 LEVEL. Turning it clockwise raises the level, while turning it counter-clockwise lowers the levels.

# Reserving songs

You can reserve songs to play in the desired order while the disc is stopped. Up to 12 songs can be reserved.

Of course, it is possible to enjoy karaoke without reserving songs.

(From the remote control unit)

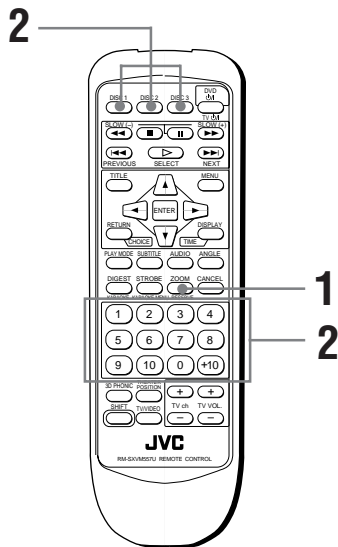

(From the front panel)

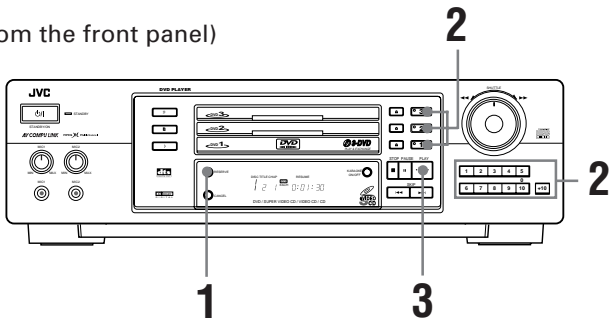

■ While stopped, when the KARAOKE function is on

## 1 Press ZOOM-RESERVE while holding down SHIFT (or press RESERVE on the front panel).

The reservation table appears on the TV screen. If any song(s) is/are reserved, The "PROGRAM" indicator appears in the display window on the front panel.

(TV screen)

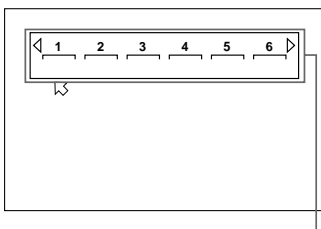

Reservation table

(Display window)

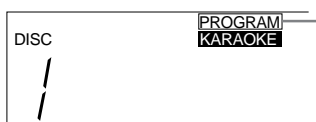

PROGRAM indicator

## 2 Specify the disc by a DISC (1-3) button and then the title or track by the numeric buttons.

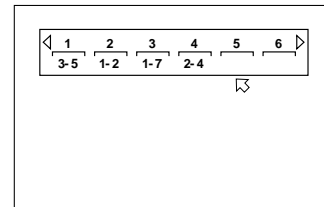

Example:

To reserve track 13 of the disc loaded in tray 2: Press DISC 2 → +10 → 3.

The specified song is reserved and the moves to the next position.

Repeat this operation until all desired songs (up to 12 songs) are reserved.

## 3 Press .

The unit starts playback of songs in the reserved order.

A song which has finished playback is deleted from the reservation table.

After playing back all reserved songs, the unit stops, and the "PROGRAM" indicator in the display window turns off.

- To check the reserved songs  
Press ZOOM-RESERVE while holding down SHIFT (or press RESERVE on the front panel) to display the reservation table.
- To cancel display of the reservation table  
Press ZOOM-RESERVE while holding down SHIFT (or press RESERVE on the front panel).
- To reserve additional songs  
Make sure that points the next to the last song in the reservation table on the TV screen, and use the DISC and numeric buttons to select the song(s) you want to reserve.
- To insert a song to be reserved  
Move to the position where you want to insert a song using CURSOR , then press the DISC and numeric button to select the song you want to reserve.
- To cancel the reserved song  
Move to the song you want to cancel using CURSOR , then press CANCEL.

### NOTES

- **To cancel all songs**  
While the unit is stopped and the reservation table is displayed on the TV screen, press STOP ■.
- **For Audio CDs, the A-B repeat function cannot be operated while playing back a reserved song.**

# Selecting audio

Most Karaoke discs have the capability of adding a "Guide vocal" or "Guide melody" to the Karaoke accompaniment.

## Selecting audio track(s) [AUDIO]



With most DVD or SVCD Karaoke discs, you can choose audio track(s) some options such as "with guide vocal," "with guide melody" and "accompaniment only." You can choose "AUDIO" only for DVD and SVCD discs.

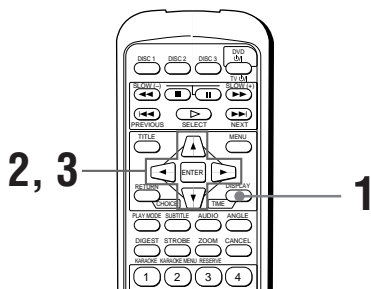

■ During playback, when the KARAOKE function is on

### 1 Press DISPLAY-TIME.

The Karaoke menu appears on the TV screen.

- The Karaoke menu also appears by pressing STROBE-KARAOKE MENU while holding down SHIFT.

### 2 Use CURSOR ◀▶ to move [ ] to [AUDIO].

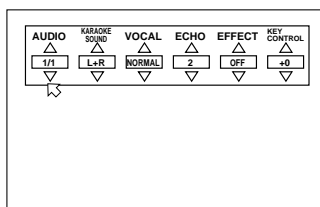

### 3 Use CURSOR ▲▼ to select the desired audio track(s) to be played back.

Example:  
(For DVD)

- 1/3 Multi audio karaoke
- 2/3 With guide vocal
- 3/3 Accompaniment only

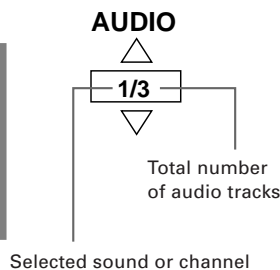

(For SVCD)

- 1/2 With guide vocal
- 2/2 Accompaniment only

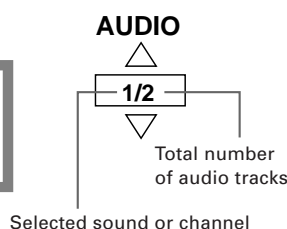

## NOTES

- To cancel display of the Karaoke menu  
Press DISPLAY-TIME.
- When [ ] appears on the TV screen  
The disc does not contain multi audio tracks, or the disc inhibits the audio selection.

## Selecting Karaoke sound [KARAOKE SOUND]



Among "Karaoke" DVD discs, there are "Multi-sound Karaoke" discs. With such a disc, for example, you can sing along with the other vocal part recorded in a disc.

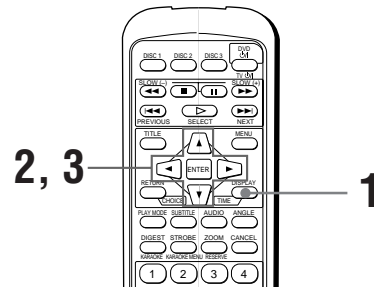

■ During playback, when the KARAOKE function is on,

### 1 Press DISPLAY-TIME.

The Karaoke menu appears on the TV screen.

- The Karaoke menu also appears by pressing STROBE-KARAOKE MENU while holding down SHIFT.

When playing back a "Multi-sound Karaoke" disc, [AUDIO] should be set to 1 (See the left column).

### 2 Use CURSOR ◀▶ to move [ ] to [KARAOKE SOUND].

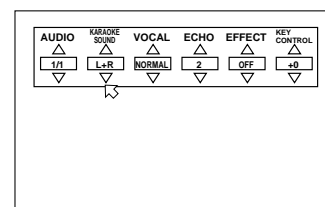

### 3 Use CURSOR ▲▼ to select the desired sound to be played back.

Example 1: A multi-sound Karaoke DVD

Pressing CURSOR ▲ button cycles the sound as follows. Pressing CURSOR ▼ cycles the sound in reverse order.

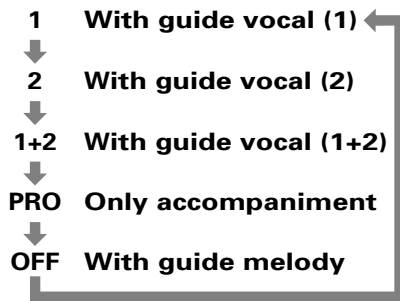

"2" and "1+2" above appear only with materials for vocal duet.

Example 2: A Video CD, SVCD or Audio CD with Karaoke

Pressing CURSOR ▲ button cycles the sound as follows. Pressing CURSOR ▼ cycles the sound in reverse order.

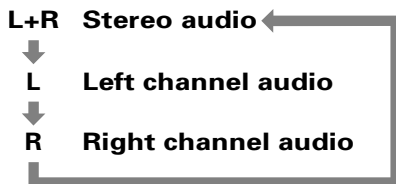

**NOTES**

- To cancel display of the Karaoke menu Press DISPLAY-TIME.
- For Video CD and SVCD, the selection of [KARAOKE SOUND] matches the audio selection using the AUDIO button.
- With a DVD disc which does not contain "Multi-sound Karaoke," [KARAOKE SOUND] cannot be changed.

**Masking the vocal recorded on a disc [VOCAL MASK]**



Using the Voice cancel function, you can mask a vocal recorded on normal non-Karaoke discs. When playing back a Karaoke disc, such as a disc with multiplex audio and multi-sound Karaoke, eliminate the vocal by selecting "KARAOKE SOUND," instead of "VOCAL MASK" (See page 37).

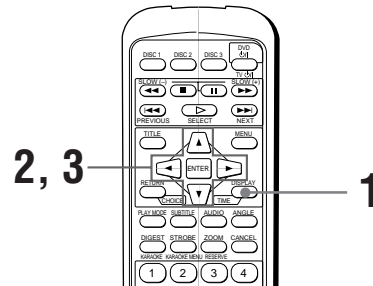

■ During playback, when the KARAOKE function is on,

**1** Press DISPLAY-TIME.

The Karaoke menu appears on the TV screen.

- The Karaoke menu also appears by pressing STROBE-KARAOKE MENU while holding down SHIFT.

If [KARAOKE SOUND] is set to L or R, the voice cancel function does not work correctly. Change the setting to L+R (See page 37).

**2** Use CURSOR ◀▶ to move to [VOCAL].

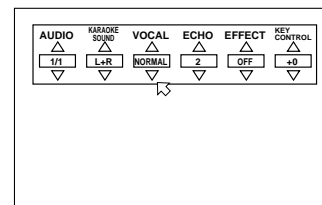

**3** Use CURSOR ▲/▼ to select [MASK].

Pressing CURSOR ▲ cycles the vocal mode as shown below.

Pressing CURSOR ▼ cycles the mode in reverse order.

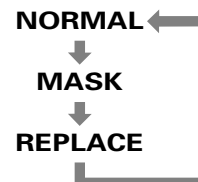

**NOTES**

- To cancel display of the Karaoke menu Press DISPLAY-TIME.
- If [KARAOKE SOUND] is set to L or R, the vocal mask function does not work correctly.
- With some materials, such as those recorded in monaural and sung by multiple voices, the voice may not be satisfactorily masked.

## Playing back the guide vocal only when you stop singing [VOCAL REPLACE]



You may have experiences where you could not sing in the middle of a Karaoke song because you forgot the melody, etc. In such cases, by using the vocal replace function, the guide vocal automatically replaces your voice when you stop singing. It may be useful for practicing Karaoke.

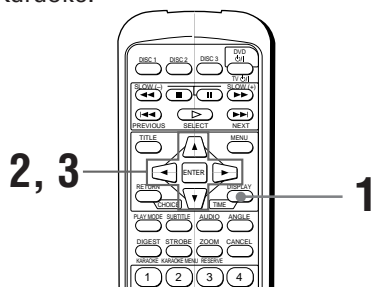

■ During playback, when the KARAOKE function is on,

### 1 Press DISPLAY-TIME.

The Karaoke menu appears on the TV screen.

- The Karaoke menu also appears by pressing STROBE-KARAOKE MENU while holding down SHIFT.

If the disc is recorded with the multiplex audio, set [KARAOKE SOUND] to L or R for playing back the guide vocal.

If the disc is not recorded for Karaoke, set [KARAOKE SOUND] to L+R (See page 37).

### 2 Use CURSOR ◀/▶ to move [VOCAL].

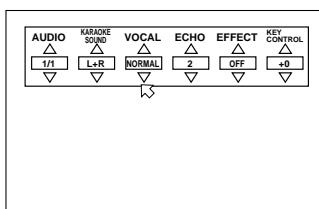

### 3 Use CURSOR ▲/▼ to select [REPLACE].

Pressing CURSOR ▲ cycles the mode as shown below.

Pressing CURSOR ▼ cycles the mode in reverse order.

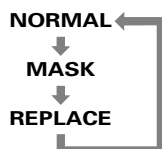

■ The recorded voice (guide vocal) is played back only when no sound is fed to the microphone(s).

#### NOTES

- To cancel display of the Karaoke menu  
Press DISPLAY-TIME.
- When playing back a disc with the multiplex audio or with multi-sound Karaoke, the guide vocal is not played back at all. With other discs, the voice may not be satisfactorily masked.

## Adding an effect to your voice

You can add various effects to your voice using the Echo and Vocal Effect functions.

### Adding an echo effect [ECHO]

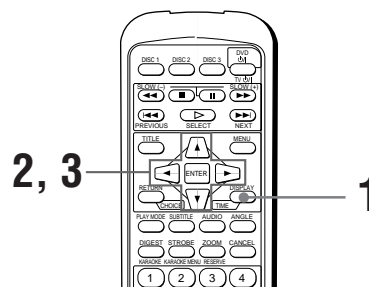

■ When the KARAOKE function is on,

### 1 Press DISPLAY-TIME.

The Karaoke menu appears on the TV screen.

- The Karaoke menu also appears by pressing STROBE-KARAOKE MENU while holding down SHIFT.

### 2 Use CURSOR ◀/▶ to move [ECHO].

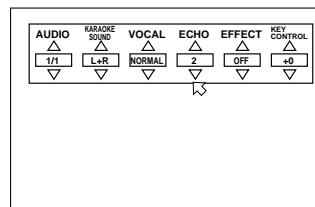

### 3 Use CURSOR ▲/▼ to adjust the echo level.

Each time you press CURSOR ▲, the echo level increases.

Pressing CURSOR ▼ changes the echo level decreases.

The higher the number, the stronger the echo.

3 ↔ 2 ↔ 1 ↔ OFF

#### NOTE

- To cancel display of the Karaoke menu  
Press DISPLAY-TIME.

## Adding various effects to the vocal [VOCAL EFFECT]

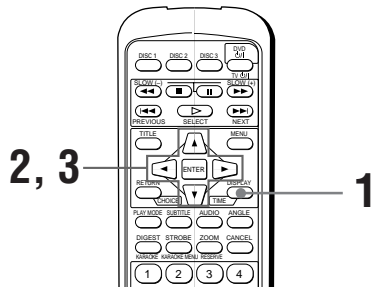

■ When the KARAOKE function is on,

### 1 Press DISPLAY-TIME.

The Karaoke menu appears on the TV screen.

- The Karaoke menu also appears by pressing STROBE-KARAOKE MENU while holding down SHIFT.

### 2 Use CURSOR ◀/▶ to move to [EFFECT].

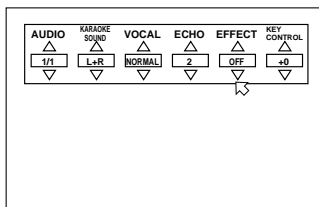

### 3 Use CURSOR ▲/▼ to select the effect.

Pressing CURSOR ▲ button cycles the effect as follows.  
Pressing CURSOR ▼ cycles the effect in reverse order.

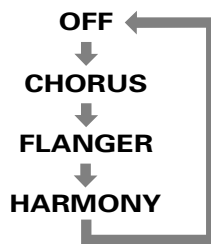

- **CHORUS:**  
Produces a doubling effect on your vocal, as if another person is singing in unison.
- **FLANGER:**  
Adds a wet, metallic sweeping sound to your voice, similar to some electric guitar sounds.
- **HARMONY:**  
Adds a harmony vocal to your voice.

#### NOTE

- **To cancel display of the Karaoke menu**  
Press DISPLAY-TIME.

## Shifting the musical key

You can shift the musical key of a song recorded on a disc to fit to your voice.

### Operating from the front panel

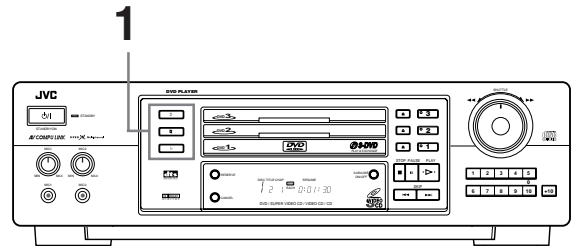

■ When the KARAOKE function is on

### 1 Use the Key control buttons (#, ♭ and ♮) to shift the musical key.

- Pressing # raises the key.
- Pressing ♭ drops the key.
- Pressing ♮ returns to the original key.

The key shift status appears in the front panel display window, as well as on the TV screen.

(Display window)



Selected key number

(TV screen)

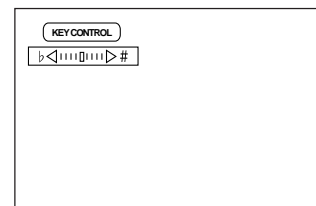

#### NOTES

- The key returns to the normal key after the current song ends.
- While an Audio CD disc is selected (not only during playback but also while stopped), the key control function does not affect the output signal from the DIGITAL OUT jack.

## Operating from the remote control unit

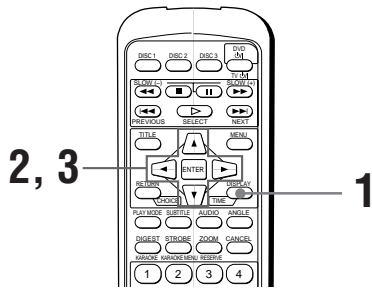

■ When the KARAOKE function is on

### 1 Press DISPLAY-TIME.

The Karaoke menu appears on the TV screen.

- The Karaoke menu also appears by pressing STROBE-KARAOKE MENU while holding down SHIFT.

### 2 Use CURSOR ◀/▶ to move to [KEY CONTROL].

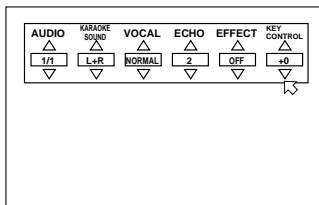

### 3 Use CURSOR ▲/▼ to shift the musical key.

- Pressing CURSOR ▲ raises the key.
- Pressing CURSOR ▼ drops the key.

The key shift status appears in the front panel display window and on the TV screen, in the same way as it appears when using the key control buttons on the front panel.

#### NOTES

- **To cancel display of the Karaoke menu**  
Press DISPLAY-TIME.
- **The key returns to the normal key after the current song ends.**
- **While an Audio CD disc is selected (not only during playback but also while stopped), the key control function does not affect the output signal from the DIGITAL OUT jack.**



## Selecting preferences

You can set various preferences for playback via four dedicated displays.

### How to set preferences

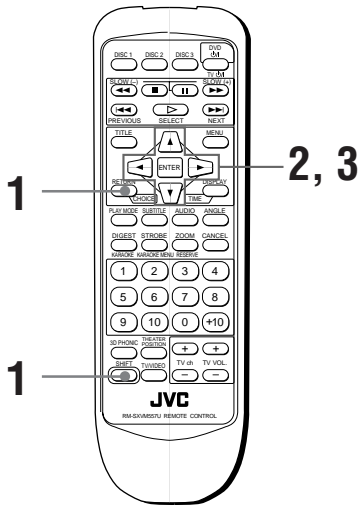

**1** When a DVD or Video CD disc is stopped or no disc is inserted, press RETURN-CHOICE while holding down SHIFT.

One of the preference pages appears on the TV screen.

There are four preference pages: LANGUAGE, AUDIO, DISPLAY and SYSTEM. To turn the page, move to the desired tab using CURSOR .

#### LANGUAGE

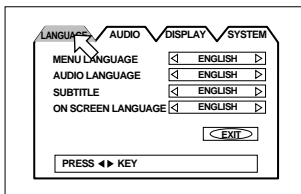

#### AUDIO

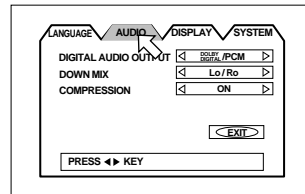

#### DISPLAY

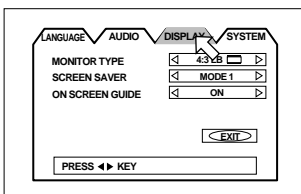

#### SYSTEM

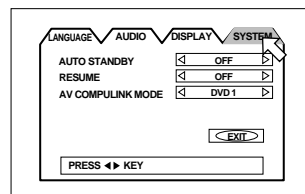

**2** Move to select the item you want to set by using CURSOR .

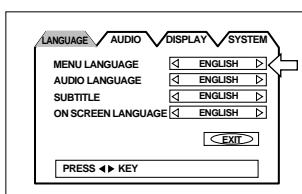

**3** Press CURSOR to select the setting you want.

- To cancel display of the preference display, press RETURN-CHOICE while holding down SHIFT, or move to [EXIT] and press ENTER.
- For details about each setting, see the paragraphs below:

### LANGUAGE page

#### MENU LANGUAGE

You can select a default “display” language to be displayed if it is contained on the disc.

Each time you press CURSOR , the language setting changes in the following order:

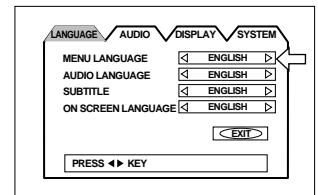

**ENGLISH → SPANISH → FRENCH → CHINESE → GERMAN → ITALIAN → JAPANESE → language code from AA to ZU**

(See “Table of languages and their abbreviations” at the end of this manual.)

Pressing CURSOR changes the language setting in the reverse order of the above.

\* If the selected language is not recorded, the disc’s default display language is displayed.

#### AUDIO LANGUAGE

You can select the default audio language to be played if it is contained on the disc.

Each time you press CURSOR , the language setting changes in the following order:

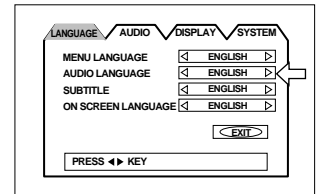

**ENGLISH → SPANISH → FRENCH → CHINESE → GERMAN → ITALIAN → JAPANESE → language code from AA to ZU**

(See “Table of languages and their abbreviations” at the end of this manual.)

Pressing CURSOR changes the language setting in the reverse order of the above.

\* If the selected language is not recorded, the disc’s default audio language will be played.

## SUBTITLE

You can select the default subtitle language to be displayed when it is contained on a playback disc.

Each time you press CURSOR ►, the language setting changes in the following order:

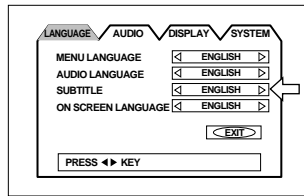

**ENGLISH → SPANISH → FRENCH → CHINESE → GERMAN → ITALIAN → JAPANESE → language code from AA to ZU**

(See "Table of languages and their abbreviations" at the end of this manual.)

Pressing CURSOR ◀ changes the language setting in the reverse order of the above.

\* If the selected language is not recorded, the disc's default subtitle language will be displayed.

## ON SCREEN LANGUAGE

You can select the on-screen display language to be displayed.

Each time you press CURSOR ◀/►, the language setting changes as follows:

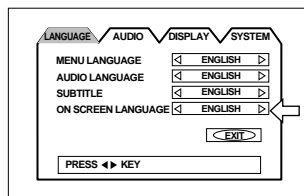

English	ON SCREEN LANGUAGE ◀ ENGLISH ▶
Spanish	IDIOMA EN PANTALLA ◀ ESPAÑOL ▶
Chinese	字幕语言 ◀ 中国语 ▶

## AUDIO page

### DIGITAL AUDIO OUTPUT

To connect the unit's digital output to an external device equipped with a digital input, this item must be set correctly.

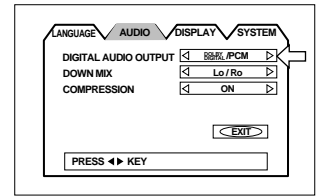

- PCM ONLY:**  
 When you connect the DIGITAL OUT jack of the unit to the linear PCM digital input of other audio equipment.
- STREAM/PCM:**  
 When you connect to the digital input of an amplifier with a built-in DTS, Dolby Digital, or MPEG audio decoder.
- DOLBY DIGITAL/PCM:**  
 When you connect to the digital input of a Dolby Digital decoder, or an amplifier with a built-in Dolby Digital decoder.

The following chart shows the relationship between types of playback discs and output signals.

Playback discs	Output		
	STREAM/PCM	DOLBY DIGITAL/PCM	PCM ONLY
DVD with 48-kHz, 16-bit linear PCM	48-kHz, 16-bit linear PCM	←	←
DVD with 48-kHz, 20/24-bit linear PCM	48-kHz, 20-bit linear PCM	←	←
DVD with 96-kHz, linear PCM	No output	←	←
DVD with DTS	DTS bitstream	No output	←
DVD with Dolby Digital	Dolby Digital bitstream	←	48-kHz, 16-bit linear PCM
DVD with MPEG audio	MPEG bitstream	48-kHz, 16-bit linear PCM	←
Video CD SVCD	44.1-kHz, 16-bit linear PCM	←	←
Audio CD	44.1-kHz, 16-bit linear PCM	←	←
Audio CD with DTS	DTS bitstream	←	←

### NOTES

- The unit does not provide the DTS decoding function.
- When playing a DVD or Audio CD disc with DTS, use a DTS decoder to get the correct signals for your speakers. Never use the unit's analog output jacks, which output incorrect signals that may damage your speakers.  
If you connect the analog outputs and digital outputs simultaneously, be sure to select the source of the amplifier correctly, or set the level control of the amplifier connected to the analog outputs to minimum.

## DOWN MIX

By setting DOWN MIX correctly, you can get the optimum stereo mix for your audio system from DVD discs recorded with Dolby Digital surround multichannel audio.

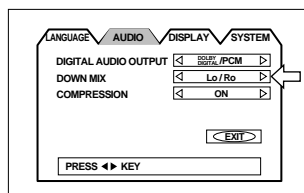

- **Lt/Rt (Dolby Digital disc only):**  
For monitoring the unit's 2-channel audio output signals via a Dolby Pro Logic decoder.
- **Lo/Ro:**  
For monitoring the unit's 2-channel audio output signals via a TV or an amplifier without built-in Dolby Pro Logic decoder. This is also for recording DVD audio to a cassette tape, MD, etc.

### NOTE

- The Down mix function does not work when the 3D PHONIC function is activated.

## COMPRESSION

You can compress the dynamic range of the sound if needed. Using this function, you can listen to sound at low volumes easily.

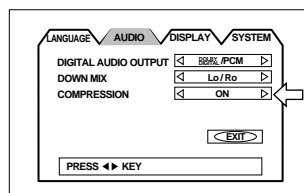

- **ON**  
Audio is played back with the dynamic range compressed.
- **OFF**  
Audio is played back as it was recorded.

### NOTES

- The Compression function works only when playing back a disc recorded with DOLBY DIGITAL 1CH or 2CH. The setting is not effective for other discs.
- The Compression function does not work when the 3D PHONIC function is activated.

## DISPLAY page

### MONITOR TYPE

You can select the monitor type to match your TV when you playback DVD discs recorded for wide screen televisions.

- **4:3 LB**  (Letter Box Conversion)

When you connect a normal TV to the unit.

When you play a wide picture recorded on a DVD disc, the picture is displayed with bands across the upper and lower portions of the screen.



- **4:3 PS**  (Pan scan Conversion)

When you connect a normal TV to the unit.

When you play a wide picture recorded on a DVD disc, a portion of the picture is automatically cut off from the left and right sides of the image.

Depending on the disc, it may not be possible to playback in this mode. In that case, the picture is played back as in 4:3 LB  mode.

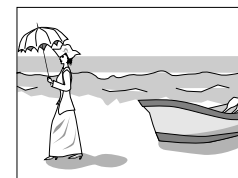

- **16:9 WIDE** (Wide Television screen)

When you connect a wide-screen TV to the unit.

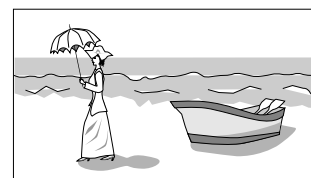

### SCREEN SAVER

A television monitor screen may be burned out if a static picture is displayed for a long time. To prevent this, the unit automatically activates the screen saver function if a static picture, such as an on-screen display or menu, is displayed for over 5 minutes.

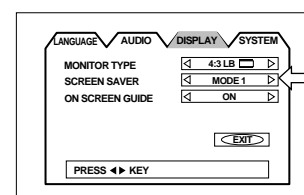

- **MODE 1**  
The current picture gets dark.
- **MODE 2**  
The "screen saver" picture appears and its brightness changes.
- **OFF**  
The screen saver function is off.

### NOTES

- The monitor screen of a projector or projection TV is easily burned out if the screen saver mode is set to OFF and a static picture is displayed for a long time.
- The screen saver function is not activated when the selected disc is an Audio CD.

## ON SCREEN GUIDE

The unit can display "on-screen guide" icons or characters on the picture, which show what is happening to the disc or the unit.

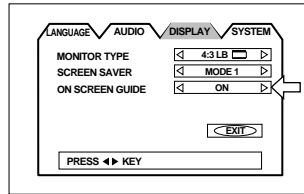

- **ON**  
The guide display is turned on.
- **OFF**  
The guide display is turned off.

Examples of "on-screen guide" icons or characters:



## SYSTEM page

### AUTO STANDBY

When the unit is stopped for more than 30 minutes or 60 minutes, the unit enters standby mode automatically.

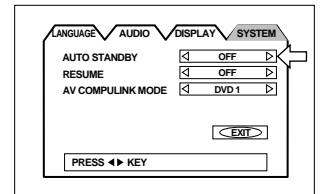

- **60**  
Time is set to 60 minutes.
- **30**  
Time is set to 30 minutes.
- **OFF**  
The auto standby function is off.

### RESUME

You can select the resume function to be on or off. See page 19.

- **ON**  
Pressing > while stopped starts playback from the resume point if it is memorized.
- **OFF**  
Pressing > while stopped starts playback from the beginning of the disc.

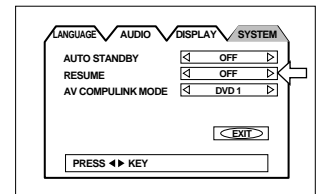

### AV COMPULINK MODE

If you use the AV Compulink system, you must set this item correctly.

Select from the three options: "DVD1," "DVD2" and "DVD3" according to the equipment to be connected. See page 48.

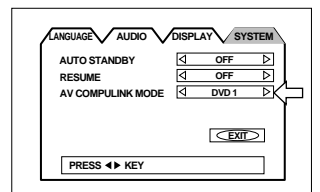

## Limiting playback by children

This function restricts playback of DVD discs which contain violent (and other) scenes according to the level set by the user. For example, if a movie which includes violent scenes supports the parental lock feature, such scenes which you do not want to let children view can be cut or replaced with other scenes.

### To set Parental Lock for the first time [PARENTAL LOCK]

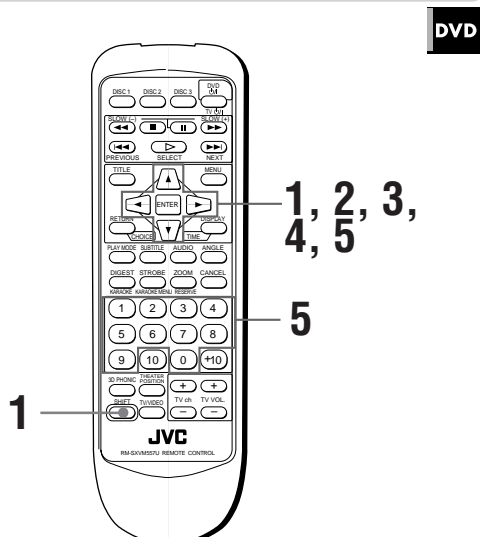

DVD

■ While a DVD disc is stopped or no disc is inserted in the selected disc tray

- 1 Press ENTER while holding down SHIFT.  
The Parental Lock on-screen display appears on the TV screen.
- 2 Use CURSOR ▲/▼ to move  to [Country Code], then use CURSOR ◀/▶ to select the country code and press ENTER.  
The country code whose standards were applied to rate the DVD video disc should be selected. See "Appendix B: Country code list for parental lock."

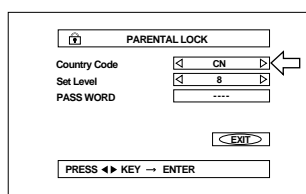

- 3 Use CURSOR ▲/▼ to move  to [Set Level], then use CURSOR ◀/▶ to select the parental lock level.

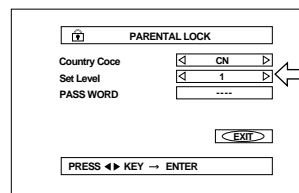

Each time you press CURSOR ◀/▶, the parental level changes between 1 and 8.

#### Hints

"1" is the strictest level. "8" means no restriction. Discs rated higher than the level you selected are restricted.

- 4 Press ENTER.
- 5 Enter your 4-digit password using the numeric buttons (0 to 9) and press ENTER.  
The parental level and password are set.

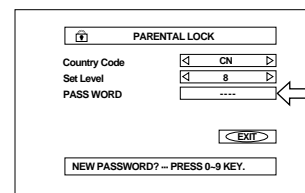

## To change the settings [PARENTAL LOCK]

DVD

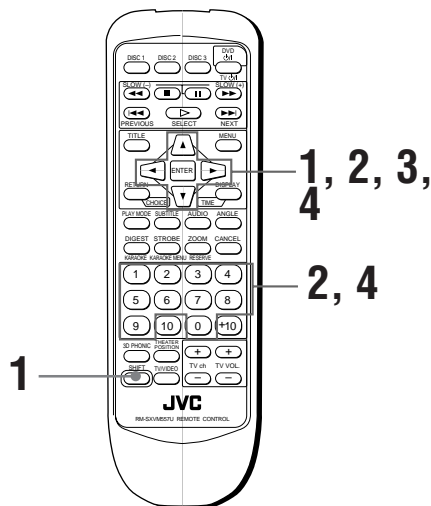

- While a DVD disc is stopped or no disc is inserted

### 1 Press ENTER while holding down SHIFT.

The Parental Lock on-screen display appears on the TV screen.

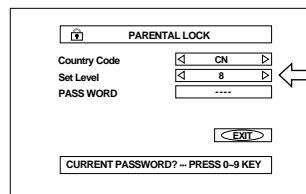

### 2 Enter your current 4-digit password using the numeric buttons (0 to 9) and press ENTER.

If you enter the wrong password, "WRONG! RETRY....." appears on the TV screen, and you cannot go to next step.

### 3 Use CURSOR ▲/▼ to move to [Set Level], and use CURSOR ◀/▶ to select the parental lock level, then press ENTER.

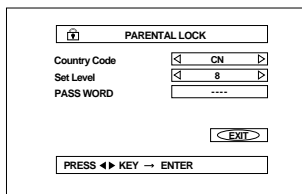

### 4 Enter your new 4-digit password using the numeric buttons (0 to 9) and press ENTER.

The new setting is effective.

#### NOTES

- When you enter the wrong password more than 3 times in step 2 above, an arrow moves to [EXIT] automatically and CURSOR ▲/▼ does not work.
- If you forget your password in step 2 Enter "8888."

## To temporarily release the Parental lock [PARENTAL LOCK]

DVD

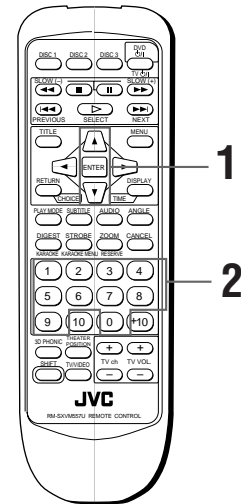

When you set the parental level strictly, some discs may not be played back at all. When you insert such a disc and try to play it, the Parental Lock on-screen display appears on the TV screen, and the unit will ask you whether you want the parental lock to be temporarily released or not.

### 1 Use the CURSOR ▲/▼ to move to [YES] or [NO], then press ENTER.

If you select [YES] and press ENTER, an arrow moves to the PASSWORD field.

When selecting [NO], press the corresponding ▲ to remove the disc.

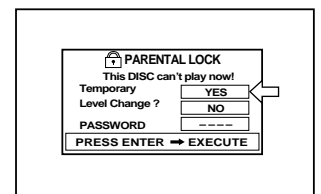

### 2 Enter your 4-digit password using the numeric buttons (0 to 9).

If you enter the wrong password, "WRONG! RETRY..." appears on the TV screen, and you cannot go to next step.

The Parental lock is released, and the unit starts playback.

#### NOTE

- When you enter the wrong password more than 3 times in step 2 above, an arrow moves to [NO] automatically and CURSOR ▲/▼ do not work.

## AV COMPU LINK remote control system

When you buy a separate TV, VCR, DVD player, receiver, or other component and connect them to each other, you have to operate each component individually. JVC's AV COMPU LINK remote control system meets the demands of a system made up of single components and has the ease of operation of a single unit.

**AV COMPU LINK**

### Connection and setup

Using the AV COMPU LINK cable, connect the AV COMPU LINK terminals of each component to one another.

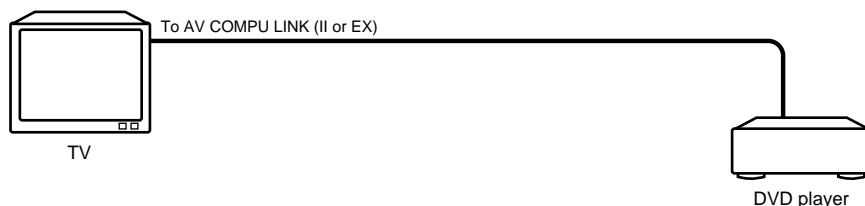

• If you connect a DVD player to a television via AV COMPU LINK, set the DVD player's AV COMPU LINK setting as follows.

- When connecting to VIDEO-1 input terminal of the television: DVD2
- When connecting to VIDEO-2 input terminal of the television: DVD3

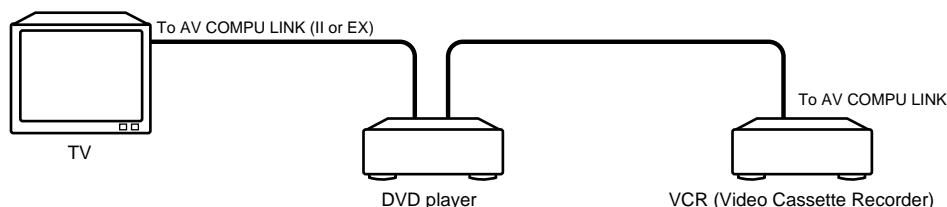

• If you connect a DVD player to a television and VCR via AV COMPU LINK, set the VCR's Remote Control Code and DVD player's AV COMPU LINK setting as follows.

- When connecting to VIDEO-1 input terminal of the television:  
DVD player's AV COMPU LINK setting: DVD2  
VCR's Remote Control Code: B
- When connecting to VIDEO-2 input terminal of the television:  
DVD player's AV COMPU LINK setting: DVD3  
VCR's Remote Control Code: A

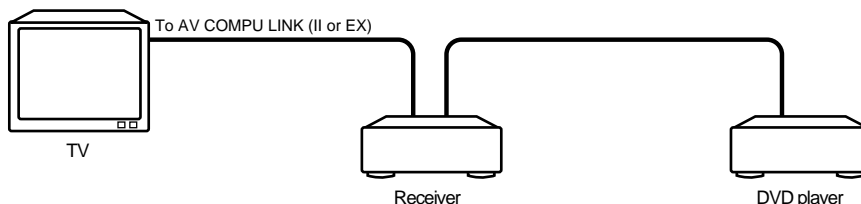

• If you connect a DVD player to a television and receiver via AV COMPU LINK, set the DVD player's AV COMPU LINK setting to DVD1.

- The DVD player's AV COMPU LINK setting is operated in the SYSTEM page of the preference display. See page 45 for operation.
- For information on the connection between the TV and the Receiver, refer to the Receiver's Instructions.

### IMPORTANT !

If you connect the component video output to your TV:

- Set the DVD player's AV COMPU LINK setting to DVD1.
- Make the video/audio connection between the DVD player and your receiver using the supplied audio/video cable, and do not make the S-VIDEO connection.



**Notes for connection**

- If you connect a DVD player to a receiver via AV COMPU LINK in a system including a Dolby digital decoder, some functions may not be performed automatically.
- The AV COMPU LINK terminal on some televisions indicates "II." Do not connect a terminal indicating "II" with the AV COMPU LINK terminal on a receiver. If connected, the system will not work correctly.
- Connect the AUDIO OUT jacks of the DVD player to the audio input jacks of a receiver that indicates "DVD." Otherwise, the system will not work correctly.
- There may be no description about connections to a DVD player in the instruction manual of a television or VCR. However, a television or VCR with AV COMPU LINK terminals indicating "II" or "EX" can be connected to a DVD player.

**Operation**

You can enjoy pictures and/or sound by just putting a source component (which plays back the pictures and/or sound such as a DVD player or VCR) into play mode. You do not have to operate the TV and receiver, including not having to perform power switching.

- 1 Turn on the main power of the television.
- 2 Insert a disc into the source component.
- 3 Press ► of the source component.

The following actions are performed automatically:

- Turning on the power for the television.
- Setting the source of the television to the external input (VIDEO-1 or VIDEO-2).
- Turning on the power for the receiver.
- Setting the source of the receiver to the component which has started playback.

**Care and handling of discs****How to handle discs**

When handling a disc, do not touch the surface of the disc. Since discs are made of plastic, they are easily damaged. If a disc gets dirty, dusty, scratched or warped, the images and sound will not be picked up correctly, and such a disc may cause the player to malfunction.

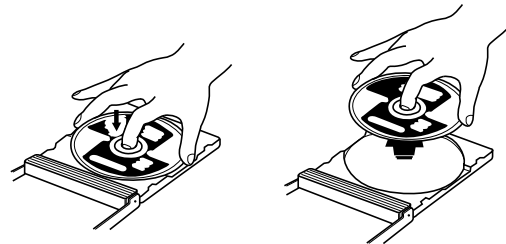
**Label side**

Do not damage the label side, stick paper to or use any adhesive on its surface.

**Storage**

Make sure that discs are kept in their cases. If discs are piled on top of one another without their protective cases, they can be damaged. Do not put discs in a location where they may be exposed to direct sunlight, or in a place where the humidity or temperature is high. Avoid leaving discs in your car!

**Maintenance of discs**

If there are fingerprints or other dirt adhering to a disc, wipe with a soft dry cloth, moving from the center outwards. If a disc is difficult to clean, wipe with a cloth moistened with water. Never use record cleaners, petrol, alcohol or any anti-static agents.

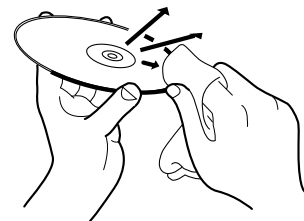
**CAUTION**

Sometimes during play noise or images may be garbled. This is sometimes due to the disc. (It may not be up to industry standards.)

These symptoms are caused by the discs, not by the malfunction of the unit.



## Troubleshooting

What appears to be a malfunction may not always be serious. Please go through the following list before requesting service.

Symptom	Possible case	Remedy
Power does not come on.	Power plug is not inserted securely.	Plug in securely.
Remote control does not work.	Too far from the unit.	Move closer to the unit.
	The tip of the remote unit is not pointed in the right direction.	Point the infrared light-emitting window toward the remote sensor on the front panel.
	Batteries are exhausted.	Replace the batteries with new ones.
	Battery polarity is incorrect.	Take out the batteries and insert them again in the correct direction.
No picture is displayed on the monitor.	Connection of video cable is incorrect.	Connect the cable correctly.
	Input selection of TV is incorrect.	Select correctly.
	Disc is not playable.	Use a playable disc. (See page 11.)
Picture is noisy.	The unit is connected to a VCR directly and the copyguard function is activated.	Connect the unit so that the picture signal flows directly to the TV.
No audio is reproduced.	Connection is incorrect.	Check the connections.
	Input selection of amplifier is incorrect.	Select correctly.
No audio is reproduced when playing back a DVD disc recorded with 96-kHz, linear PCM audio.	The audio signal is derived from the unit's DIGITAL OUT.	Use the AUDIO OUT when playing back such discs.
Sound is distorted or noise is generated.	Disc is dirty.	Wipe the disc surface.
Picture does not fit the television screen.	MONITOR TYPE is not correctly set.	Select monitor type correctly. (See page 44.)
	Television is not correctly set.	Set the television correctly.
Operation is not possible.	Microcomputer malfunction due to lightning or static electricity.	Turn off the power and unplug the power cord, then connect the power cord again.
	Moisture condensation caused by a sudden change of temperature or humidity.	Turn off the power, then turn it on a few hours later.

# Specifications

## General

Readable discs: DVD VIDEO, Audio CD, Video CD, SVCD  
 Video format: NTSC color, PAL selectable

## Other

Power requirements: AC 110-240 V ~ , 50/60 Hz  
 Power consumption: 20 W (POWER ON), 3.8 W (STANDBY mode)  
 Mass: 5.1 kg (11.3 lbs)  
 Dimensions (W x H x D): 435 x 126.5 x 324.6 mm  
 17-3/16 x 5 x 12-13/16 inch

## Video output

COMPONENT (pin jack): Y Output: 1.0 Vp-p (75 ohms)  
 PB/PR Output: 0.7 Vp-p (75 ohms)  
 VIDEO OUT (pin jack): 1.0 Vp-p (75 ohms)  
 S-VIDEO OUT (S jack): Y Output: 1.0 Vp-p (75 ohms)  
 C Output: 286 mVp-p (75 ohms)  
 Horizontal resolution: 500 Lines  
 Signal to noise ratio: 65 dB

## Audio output

ANALOG OUT (pin jack): ATTENUATOR OFF: 2.0 Vrms (10 k ohms)  
 ATTENUATOR ON: 1.0 Vrms (10 k ohms)  
 DIGITAL OUT (optical): - 21 to -15 dBm (Peak)

## Audio input

MIC1/MIC2: 2 mVrms (8.2 k ohms)

## Audio characteristics

Frequency response: CD (sampling frequency 44.1 kHz): 2 Hz to 20 kHz  
 DVD (sampling frequency 48 kHz): 2 Hz to 22 kHz  
 DVD (sampling frequency 96 kHz): 2 Hz to 44 kHz  
 Dynamic range: 16 bit: More than 98 dB  
 20 bit: More than 106 dB  
 24 bit: More than 106 dB  
 Wow and flutter: Unmeasurable (less than ± 0.002%)  
 Total harmonic distortion: Less than 0.002%

\* Specifications and appearance subject to change without prior notice.

# Appendix A: Table of languages and their abbreviations

When you select the subtitle language or sound, the languages shown below are displayed as abbreviations. To select the desired language, select the abbreviation corresponding the language you want to.

AA	Afar	FA	Persian	KM	Cambodian	OM	(Afan) Oromo	SU	Sundanese
AB	Abkhazian	FI	Finnish	KN	Kannada	OR	Oriya	SV	Swedish
AF	Afrikaans	FJ	Fiji	KO	Korean (KOR)	PA	Panjabi	SW	Swahili
AM	Ameharic	FO	Faroese	KS	Kashmiri	PL	Polish	TA	Tamil
AR	Arabic	FY	Frisian	KU	Kurdish	PS	Pashto, Pushto	TE	Telugu
AS	Assamese	GA	Irish	KY	Kirghiz	PT	Portuguese	TG	Tajik
AY	Aymara	GD	Scots Gaelic	LA	Latin	QU	Quechua	TH	Thai
AZ	Azerbaijani	GL	Galician	LN	Lingala	RM	Rhaeto-Romance	TI	Tigrinya
BA	Bashkir	GN	Guarani	LO	Laothian	RN	Kirundi	TK	Turkmen
BE	Byelorussian	GU	Gujarati	LT	Lithuanian	RO	Rumanian	TL	Tagalog
BG	Bulgarian	HA	Hausa	LV	Latvian, Lettish	RU	Russian	TN	Setswana
BH	Bihari	HI	Hindi	MG	Malagasy	RW	Kinyarwanda	TO	Tonga
BI	Bislama	HR	Croatian	MI	Maori	SA	Sanskrit	TR	Turkish
BN	Bengali, Bangla	HU	Hungarian	MK	Macedonian	SD	Sindhi	TS	Tsonga
BO	Tibetan	HY	Armenian	ML	Malayalam	SG	Sangho	TT	Tatar
BR	Breton	IA	Interlingua	MN	Mongolian	SH	Serbo-Croatian	TW	Twi
CA	Catalan	IE	Interlingue	MO	Moldavian	SI	Singhalese	UK	Ukrainian
CO	Corsican	IK	Inupiak	MR	Marathi	SK	Slovak	UR	Urdu
CS	Czech	IN	Indonesian	MS	Malay (MAY)	SL	Slovenian	UZ	Uzbek
CY	Welsh	IS	Icelandic	MT	Maltese	SM	Samoan	VI	Vietnamese
DA	Danish	IW	Hebrew	MY	Burmese	SN	Shona	VO	Volapuk
DZ	Bhutani	JI	Yiddish	NA	Nauru	SO	Somali	WO	Wolof
EL	Greek	JW	Javanese	NE	Nepali	SQ	Albanian	XH	Xhosa
EO	Esperanto	KA	Georgian	NL	Dutch	SR	Serbian	YO	Yoruba
ET	Estonian	KK	Kazakh	NO	Norwegian	SS	Siswati	ZU	Zulu
EU	Basque	KL	Greenlandic	OC	Occitan	ST	Sesotho		

# Appendix B: Country code list for parental lock

This list is used for the Parental Lock operation. For details, see page 46.

AD	Andorra
AE	United Arab Emirates
AF	Afghanistan
AG	Antigua and Barbuda
AI	Anguilla
AL	Albania
AM	Armenia
AN	Netherlands Antilles
AO	Angola
AQ	Antarctica
AR	Argentina
AS	American Samoa
AT	Austria
AU	Australia
AW	Aruba
AZ	Azerbaijan
BA	Bosnia and Herzegovina
BB	Barbados
BD	Bangladesh
BE	Belgium
BF	Burkina Faso
BG	Bulgaria
BH	Bahrain
BI	Burundi
BJ	Benin
BM	Bermuda
BN	Brunei Darussalam
BO	Bolivia
BR	Brazil
BS	Bahamas
BT	Bhutan
BV	Bouvet Island
BW	Botswana
BY	Belarus
BZ	Belize
CA	Canada
CC	Cocos (Keeling) Islands
CF	Central African Republic
CG	Congo
CH	Switzerland
CI	Côte d'Ivoire
CK	Cook Islands
CL	Chile
CM	Cameroon
CN	China
CO	Colombia
CR	Costa Rica
CU	Cuba
CV	Cape Verde
CX	Christmas Island
CY	Cyprus
CZ	Czech Republic
DE	Germany
DJ	Djibouti
DK	Denmark
DM	Dominica
DO	Dominican Republic
DZ	Algeria
EC	Ecuador
EE	Estonia
EG	Egypt
EH	Western Sahara
ER	Eritrea

ES	Spain
ET	Ethiopia
FI	Finland
FJ	Fiji
FK	Falkland Islands (Malvinas)
FM	Micronesia (Federated States of)
FO	Faroe Islands
FR	France
FX	France, Metropolitan
GA	Gabon
GB	United Kingdom
GD	Grenada
GE	Georgia
GF	French Guiana
GH	Ghana
GI	Gibraltar
GL	Greenland
GM	Gambia
GN	Guinea
GP	Guadeloupe
GQ	Equatorial Guinea
GR	Greece
GS	South Georgia and the South Sandwich Islands
GT	Guatemala
GU	Guam
GW	Guinea-Bissau
GY	Guyana
HK	Hong Kong
HM	Heard Island and McDonald Islands
HN	Honduras
HR	Croatia
HT	Haiti
HU	Hungary
ID	Indonesia
IE	Ireland
IL	Israel
IN	India
IO	British Indian Ocean Territory
IQ	Iraq
IR	Iran (Islamic Republic of)
IS	Iceland
IT	Italy
JM	Jamaica
JO	Jordan
JP	Japan
KE	Kenya
KG	Kyrgyzstan
KH	Cambodia
KI	Kiribati
KM	Comoros
KN	Saint Kitts and Nevis
KP	Korea, Democratic People's Republic of
KR	Korea, Republic of
KW	Kuwait
KY	Cayman Islands
KZ	Kazakhstan
LA	Lao People's Democratic Republic

LB	Lebanon
LC	Saint Lucia
LI	Liechtenstein
LK	Sri Lanka
LR	Liberia
LS	Lesotho
LT	Lithuania
LU	Luxembourg
LV	Latvia
LY	Libyan Arab Jamahiriya
MA	Morocco
MC	Monaco
MD	Moldova, Republic of
MG	Madagascar
MH	Marshall Islands
ML	Mali
MM	Myanmar
MN	Mongolia
MO	Macau
MP	Northern Mariana Islands
MQ	Martinique
MR	Mauritania
MS	Montserrat
MT	Malta
MU	Mauritius
MV	Maldives
MW	Malawi
MX	Mexico
MY	Malaysia
MZ	Mozambique
NA	Namibia
NC	New Caledonia
NE	Niger
NF	Norfolk Island
NG	Nigeria
NI	Nicaragua
NL	Netherlands
NO	Norway
NP	Nepal
NR	Nauru
NU	Niue
NZ	New Zealand
OM	Oman
PA	Panama
PE	Peru
PF	French Polynesia
PG	Papua New Guinea
PH	Philippines
PK	Pakistan
PL	Poland
PM	Saint Pierre and Miquelon
PN	Pitcairn
PR	Puerto Rico
PT	Portugal
PW	Palau
PY	Paraguay
QA	Qatar
RE	Réunion
RO	Romania
RU	Russian Federation
RW	Rwanda

SA	Saudi Arabia
SB	Solomon Islands
SC	Seychelles
SD	Sudan
SE	Sweden
SG	Singapore
SH	Saint Helena
SI	Slovenia
SJ	Svalbard and Jan Mayen
SK	Slovakia
SL	Sierra Leone
SM	San Marino
SN	Senegal
SO	Somalia
SR	Suriname
ST	Sao Tome and Principe
SV	El Salvador
SY	Syrian Arab Republic
SZ	Swaziland
TC	Turks and Caicos Islands
TD	Chad
TF	French Southern Territories
TG	Togo
TH	Thailand
TJ	Tajikistan
TK	Tokelau
TM	Turkmenistan
TN	Tunisia
TO	Tonga
TP	East Timor
TR	Turkey
TT	Trinidad and Tobago
TV	Tuvalu
TW	Taiwan, Province of China
TZ	Tanzania, United Republic of
UA	Ukraine
UG	Uganda
UM	United States Minor Outlying Islands
US	United States
UY	Uruguay
UZ	Uzbekistan
VA	Vatican City State (Holy See)
VC	Saint Vincent and the Grenadines
VE	Venezuela
VG	Virgin Islands (British)
VI	Virgin Islands (U.S.)
VN	Vietnam
VU	Vanuatu
WF	Wallis and Futuna Islands
WS	Samoa
YE	Yemen
YT	Mayotte
YU	Yugoslavia
ZA	South Africa
ZM	Zambia
ZR	Zaire
ZW	Zimbabwe

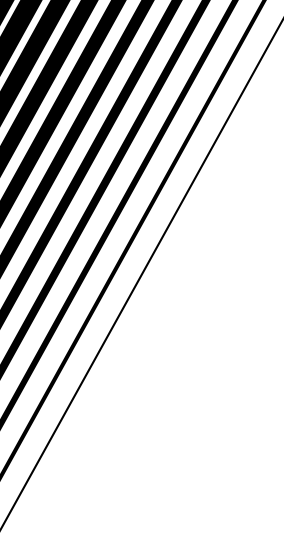

**JVC**  
VICTOR COMPANY OF JAPAN, LIMITED

## Free Manuals Download Website

<http://myh66.com>

<http://usermanuals.us>

<http://www.somanuals.com>

<http://www.4manuals.cc>

<http://www.manual-lib.com>

<http://www.404manual.com>

<http://www.luxmanual.com>

<http://aubethermostatmanual.com>

Golf course search by state

<http://golfingnear.com>

Email search by domain

<http://emailbydomain.com>

Auto manuals search

<http://auto.somanuals.com>

TV manuals search

<http://tv.somanuals.com>