

# JVC



## DVD VIDEO PLAYER

---

### XV-NK38SL

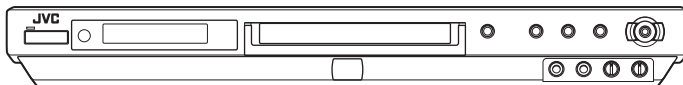

Before operation	2
Preparations	3
Basic operations	6
Advanced operations	11
MP3 disc playback	19
KARAOKE operation	21
Changing the initial settings	26
Additional information	31

## INSTRUCTIONS

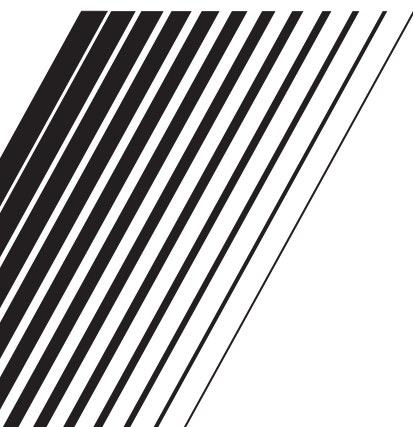

GNT0028-003A  
[US/UB/UG/UX]

# Warnings, Cautions and Others

## CAUTION

To reduce the risk of electrical shocks, fire, etc.:

1. Do not remove screws, covers or cabinet.
2. Do not expose this appliance to rain or moisture.

## Caution — STANDBY/ON button!

Disconnect the mains plug to shut the power off completely. The STANDBY/ON  button in any position does not disconnect the mains line. The power can be remote controlled.

## CAUTION

- Do not block the ventilation openings or holes.  
(If the ventilation openings or holes are blocked by a newspaper or cloth, etc., the heat may not be able to get out).
- Do not place any naked flame sources, such as lighted candles, on the apparatus.
- When discarding batteries, environmental problems must be considered and local rules or laws governing the disposal of these batteries must be followed strictly.
- Do not expose this apparatus to rain, moisture, dripping or splashing and that no objects filled with liquids, such as vases, shall be placed on the apparatus.

## Caution: Proper Ventilation

To avoid risk of electric shock and fire and to protect from damage, locate the apparatus as follows:

Front: No obstructions and open spacing.

Sides: No obstructions in 3 cm from the sides.

Top: No obstructions in 5 cm from the top.

Back: No obstructions in 15 cm from the back.

Bottom: No obstructions, place on the level surface.

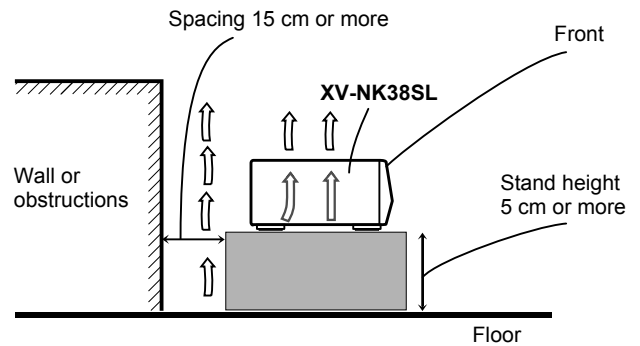

## IMPORTANT FOR LASER PRODUCTS

1. CLASS 1 LASER PRODUCT
2. **CAUTION:** Do not open the top cover. There are no user serviceable parts inside the Unit; leave all servicing to qualified service personnel.
3. **CAUTION:** Visible and invisible laser radiation when open and interlock failed or defeated. Avoid direct exposure to beam.
4. REPRODUCTION OF LABEL: CAUTION LABEL, PLACED INSIDE THE UNIT.

<b>CAUTION:</b> Visible and invisible laser radiation when open and interlock failed or defeated. AVOID DIRECT EXPOSURE TO BEAM.	<b>ADVARSEL:</b> Synlig og usynlig laserstråling når maskinen er åben eller interlocken fejler. Undgå direkte eksponering til stråling.	<b>VARNING:</b> Synlig och osynlig laserstråling när den öppnas och spärren är urkopplad. Beträkta ej strålen.	<b>VARO:</b> Avattaessa ja suojalukitus ohitettuna tai viallisena olet alittuna näkyväille ja näkymättömälle lasersäteilylle. Vältä silmien kohdistumista suoraan itseesi. (1)
(e)	(e)	(d)	(s)

## Supplied accessories

Check that you have all the following accessories supplied to you. If anything is missing, consult your dealer immediately.

- Audio/video cable (Yellow/White/Red) (× 1)
- Remote control unit (× 1)
- R6P(SUM-3)/AA(15F) battery (× 2)
- AC power plug (× 1)  
(except for Hong Kong model)

## About this manual

- The display window information and OSD (On Screen Display) menu items are put in brackets [ ] in the operation procedures.
- Usable disc(s) for each operation/function is (are) referred to by the icons;



## Precautions

### Notes on the power cord

- When you are away on travel or otherwise for an extended period of time, remove the plug from the wall outlet. A small amount of power (0.9W) is always consumed while the power cord is connected to the wall outlet.
- When unplugging the unit from the wall outlet, always pull the plug, not the power cord.
- Do not handle the power cord with wet hands!

### Avoid moisture, water and dust

- Do not place the unit in moist or dusty places.
- If water gets inside the unit, turn off the power and remove the plug from the wall outlet, then consult your dealer. Using the unit in this state may cause a fire or electrical shock.

### Avoid high temperatures

- Do not expose the unit to direct sunlight or place it near a heating device.

### Notes on installation

- Select a place which is level, dry and neither too hot nor too cold between 5°C and 35°C.
- Leave sufficient distance between the unit and the TV.
- Do not install the unit in a place subject to vibrations.

### To prevent malfunction of the unit

- There are no user-serviceable parts inside. If anything goes wrong, unplug the power cord and consult your dealer.
- Do not insert any metallic objects, such as wires, hairpins, coins, etc. into the unit.
- Do not block the vents. Blocking the vents may damage the unit.

### To clean the cabinet

- Use a soft cloth. Follow the relevant instructions on the use of chemically-coated cloths.
- Do not use benzene, thinner or other organic solvents and disinfectants. These may cause deformation or discoloring.

## Table of contents

<b>Supplied accessories</b> .....	1
<b>About this manual</b> .....	1
<b>Precautions</b> .....	1
<hr/>	
<b>Before operation</b> .....	2
About discs .....	2
<hr/>	
<b>Preparations</b> .....	3
Connections.....	3
Using the remote control unit.....	5
<hr/>	
<b>Basic operations</b> .....	6
Turning on/off the unit.....	6
Initial setup .....	6
Basic playback.....	7
Resuming playback .....	8
Various speed playback .....	9
Locating the beginning of a scene or song .....	10
<hr/>	
<b>Advanced operations</b> .....	11
Playing from a specific position .....	11
Changing the playback order.....	12
Repeat playback .....	14
Changing the language, sound and scene angle .....	15
Special picture/sound effect .....	16
Menu bar functions .....	17
<hr/>	
<b>MP3 disc playback</b> .....	19
Operations .....	19
<hr/>	
<b>KARAOKE operation</b> .....	21
Preparation .....	21
Reserving songs .....	21
Selecting audio .....	22
Adding an effect to your voice .....	24
Shifting the musical key .....	25
<hr/>	
<b>Changing the initial settings</b> .....	26
Selecting preferences .....	26
Limiting playback by children.....	29
<hr/>	
<b>Additional information</b> .....	31
Names of parts and controls.....	31
AV COMPU LINK remote control system .....	33
Troubleshooting.....	34
Specifications .....	35
Appendix A: Country/Area code list for Parental Lock.....	36
Appendix B: Table of languages and their abbreviations .....	37
Appendix C: Digital output signal chart.....	38
Appendix D: Glossary .....	39

# Before operation

## About discs

### Playable disc types

Discs with the following marks can be played back on the unit.

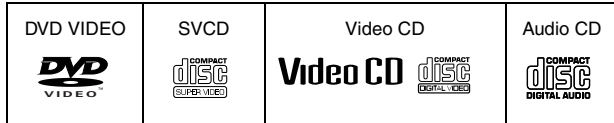

The DVD Logo is a trademark.

The unit can also play back the following discs:

- DVD-R, DVD-RW and +RW discs written in the DVD VIDEO format and finalized
- CD-R and CD-RW discs written in the SVCD, Video CD or Audio CD format and finalized
- CD-R and CD-RW discs written in MP3 in accordance with the "ISO 9660" format (See page 19 for details.)

#### NOTE

If a disc gets dirty, scratched or warped, or due to the disc characteristics or recording conditions, it may take considerable time for the unit to read the content, or the unit may not be able to play back such discs.

The unit can play back audio signals recorded in MIX-MODE CD, CD-G, CD-EXTRA and CD TEXT.

### Region code of DVD VIDEO

DVD VIDEO players and DVD VIDEO discs have their own Region Code numbers. This unit can playback DVD VIDEO discs whose Region Code numbers include the unit's Region Code, which is indicated on the region code symbol on the rear panel. Example of playable DVD discs when the unit's Region Code is "2":



### Color system format

This unit is compatible with the PAL and NTSC systems. You can select "PAL" or "NTSC" while using the VIDEO SIGNAL SELECTOR on the rear panel (for details, see page 5).

### Unplayable discs

The unit does not play back discs listed below. If you try to play back these discs, noise may generate causing damage to speakers.

- DVD-RW discs written in the VR format
- DVD-ROM, DVD-RAM, DVD AUDIO, CD-ROM, PHOTO CD, SACD

In addition, the unit does not play:

- Unfinalized discs
- Discs of irregular shape or discs with tape, seals or paste on either the label side or playback side. Playing back these discs may damage the unit.

## Digital audio formats

The unit supports the following digital audio formats (see page 39 "Glossary" for descriptions of each audio format):

Linear PCM, Dolby Digital, DTS (Digital Theater Systems)

#### NOTES

- Depending on the unit's [DIGITAL AUDIO OUTPUT] setting, digital audio signals may not be output as they are recorded on the disc. See "DIGITAL AUDIO OUTPUT" on page 28 for details.
- To play back DTS-encoded DVD VIDEO or DTS-encoded Audio CD discs correctly, connect the unit to an amplifier with a built-in DTS decoder. If the unit is connected to an amplifier without a DTS decoder, playback sound will be distorted.

### Notes on discs

- With some DVD VIDEO discs, the unit starts playback automatically after inserting the disc.
- The image may be sometimes poor or noisy due to defects in the disc itself.
- With some discs, operations described in this manual may not be possible.

## Care and handling of discs

If a disc gets dirty, dusty, scratched or warped, playback sound and picture may be deteriorated. Take proper precautions when handling discs.

#### Handling

- Do not touch the surface of the disc.
- Do not damage, stick paper to, or use any adhesive on either the label side or playback side.

#### Storing discs

- Keep discs in their cases. If discs are piled on top of one another without their protective cases, they can be damaged.
- Do not put discs in a location where they may be exposed to direct sunlight, or where the humidity or temperature is high. Avoid leaving discs in a car!

#### Cleaning discs

- Wipe with a soft dry cloth, moving from the center outwards. If a disc is difficult to clean, wipe with a cloth moistened with water.

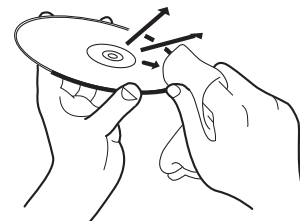

- Never use record cleaners, petrol, alcohol or any anti-static agents.

#### Notes on copyright

Check the copyright laws in your country before recording from DVD VIDEO, SVCD, Video CD, Audio CD and MP3 discs. Recording of copyrighted material may infringe copyright laws.

This product incorporates copyright protection technology that is protected by method claims of certain U.S. patents and other intellectual property rights owned by Macrovision Corporation and other rights owners. Use of this copyright protection technology must be authorized by Macrovision Corporation, and is intended for home and other limited viewing uses only unless otherwise authorized by Macrovision Corporation. Reverse engineering or disassembly is prohibited.

# Preparations

## Connections

Before using the unit, connect the unit to a TV and/or amplifier.

### Before making connections

- Do not connect the AC power cord until all other connections have been made.
- Connect VIDEO OUT of the unit directly to the video input of your TV. Connecting VIDEO OUT of the unit to a TV via a VCR may cause a monitor problem when playing back a copy-protected disc. You may also have a monitor problem when connecting the unit to an integrated TV/Video system.

- In the following description, "TV" may be substituted with "monitor" or "projector."
- Terminal names used for other components may be different from those used in the following description.

## Connecting to a TV

The following sections (A) to (C) describe TV connections where only a TV is connected to the unit so that you will hear audio from the TV.

### (A) Connecting to a conventional TV

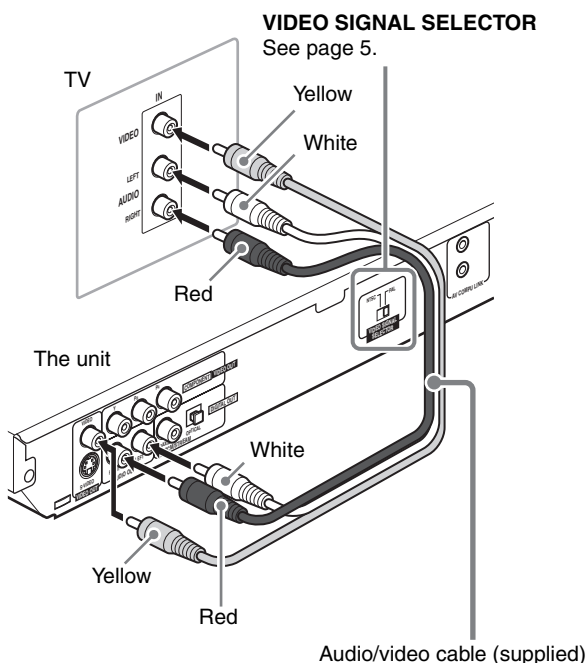

#### NOTE

If your TV has a monaural audio input instead of stereo, you need to use an optional audio cable which converts stereo audio output to monaural.

### (B) Connecting to a TV with an S-video jack

If your TV has an S-VIDEO input, you can get better picture quality by connecting it with the S-VIDEO output of the unit using an S-video cable instead of connecting the video input of the TV to the VIDEO jack of the unit.

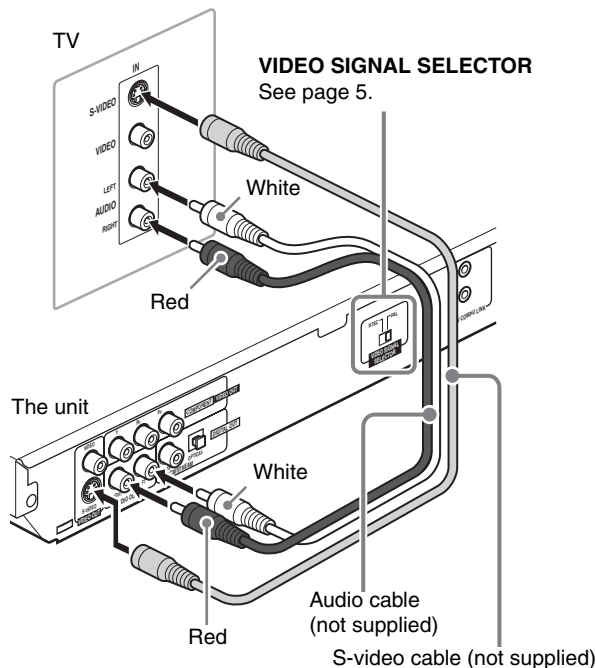

#### NOTE

When using the S-VIDEO output jack, do not connect the COMPONENT VIDEO OUT jacks on the unit.

### (C) Connecting to a TV with component jacks

You can enjoy picture of high-fidelity color reproduction by connecting the COMPONENT VIDEO OUT jacks on the unit to your TV.

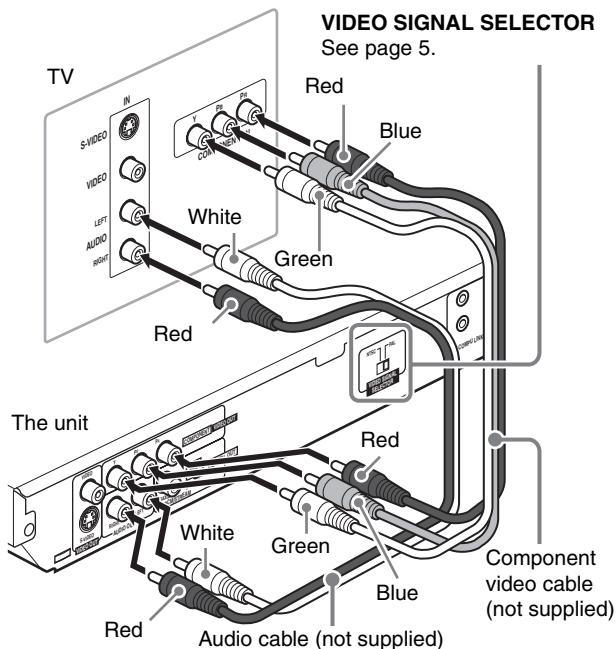

#### NOTES

- Connect "Y" to "Y," "P<sub>B</sub>" to "P<sub>B</sub>" (C<sub>B</sub>), "P<sub>R</sub>" to "P<sub>R</sub>" (C<sub>R</sub>) correctly.
- When using the COMPONENT VIDEO OUT jacks, do not connect the S-VIDEO output jack on the unit.
- When the component video input jacks on the TV are of the BNC type, use an adapter to convert a pin jack to a BNC jack (not supplied).

## Connecting to optional audio equipment

### Connecting to a stereo audio amplifier/receiver

Connect the unit's AUDIO OUT (LEFT/RIGHT) jacks to any line-level inputs (such as AUX, DVD, CD, etc.) of an audio amplifier or receiver.

**NOTE**

Sound recorded on DTS-encoded DVD VIDEO or DTS-encoded Audio CD discs are not output from the analog (AUDIO OUT LEFT/RIGHT) jacks of the unit.

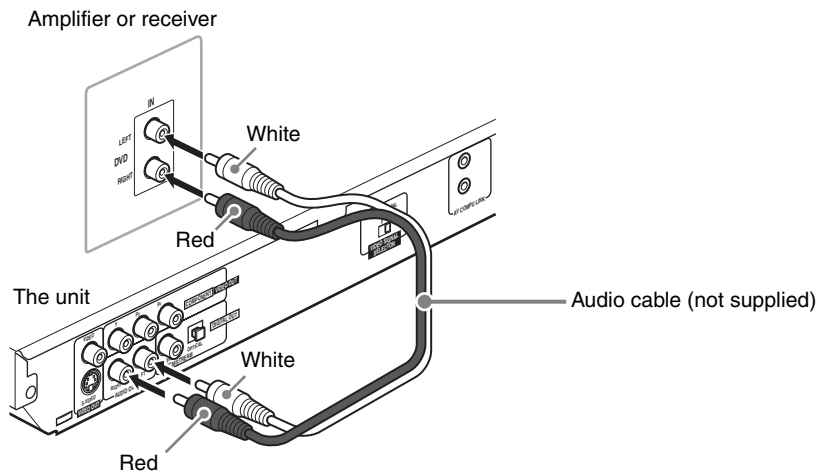

Preparations

### Connecting to a digital audio device

You can enjoy sound of enhanced quality by connecting the unit's DIGITAL OUT (either OPTICAL or COAXIAL) jack to a digital input of an amplifier, etc., using an optical or coaxial digital cable. The digital audio signal on a disc will be transferred directly from the unit. If the connected digital audio equipment is a Dolby Digital or DTS decoder or an amplifier with a built-in decoder, you can enjoy high-quality surround sound.

**NOTES**

- Connect the unit and the digital audio device by using either an optical digital cable or a coaxial digital cable.
- It is not recommended to use the digital jacks for dubbing. When recording the sounds (DVD VIDEO, SVCD, Video CD or Audio CD) played back on the unit, record them through the analog jacks.
- Depending on the disc, no signal may be output from the DIGITAL OUT. Make an analog connection in this case.
- **Set [DIGITAL AUDIO OUTPUT] in the [AUDIO] preference display correctly according to the connected digital audio equipment. If setting made for [DIGITAL AUDIO OUTPUT] is incorrect, loud noise may be generated causing damage to the speakers (see page 28).**

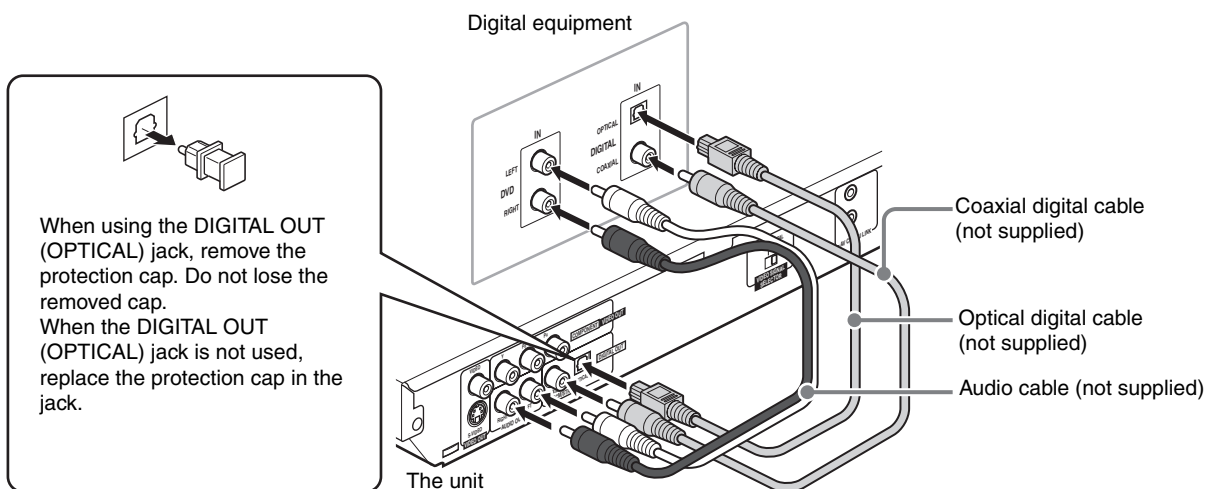

## Selecting NTSC or PAL

Set the VIDEO SIGNAL SELECTOR on the rear panel to "NTSC" or "PAL" to match the color system of your TV. Make sure that the color system of a DVD VIDEO/SVCD/video CD disc labeled on the package matches your TV.

If you use a multi-color system TV, you can play discs recorded on both PAL and NTSC systems by setting the VIDEO SIGNAL SELECTOR appropriately.

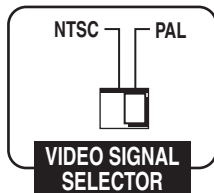

### NOTE

Change the VIDEO SIGNAL SELECTOR position in stop mode or with no disc inserted. The changed setting is not effective if you change the selector position in playback mode.

## Connecting the power cord

When all the audio/video connections have been made, connect the AC power plug to the wall outlet. Make sure that the plugs are inserted firmly.

The STANDBY indicator lights in red.



### Warning

- Disconnect the power cord:
  - if you are not going to use the unit for a long time.
  - before cleaning the unit.
  - before moving the unit.
- Do not:
  - connect or disconnect the power cord with wet hands.
  - pull the power cord when disconnecting it, as this may damage the cord and cause fire, electric shock, or other accidents.



### Caution

- Do not alter, twist or pull the power cord, or put anything heavy on it, which may cause fire, electric shock, or other accidents.
- If the cord is damaged, consult a dealer and have the power cord replaced with a new one.

## Using the remote control unit

### To install batteries

Open the compartment cover, and place the two supplied R6P(SUM-3)/AA(15F) batteries in the remote control unit according to the polarity markings ("+" and "-") inside the compartment. Then replace the cover.

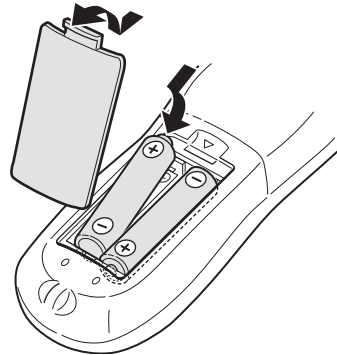

The batteries will last about six months with normal use.

If the functions of the remote control unit become erratic, replace the batteries.

### Precautions of the safe use of batteries

Observe the following precautions for the safe use of batteries. If they are used improperly their lives will be shortened, they may burst or their contents may leak.

- Remove the batteries from the remote control unit if it is not going to be used for a long period of time.
- Remove dead batteries and dispose of them properly.
- Never leave dead batteries lying around, take them apart, mix them with other refuse, or throw them into an incinerator.
- Never touch liquid that has leaked out of a battery.
- Do not mix new and old batteries, or batteries of different types, when replacing them.

## Remote sensor

Point the top of the remote control unit toward the remote sensor as directly as possible. If you operate it from a diagonal position, the operating range (approx. 5 m) may be shorter.

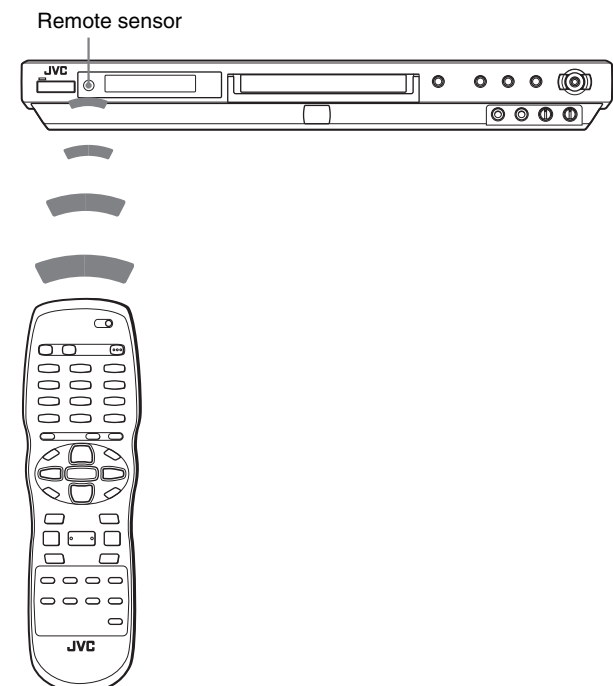



# Basic operations

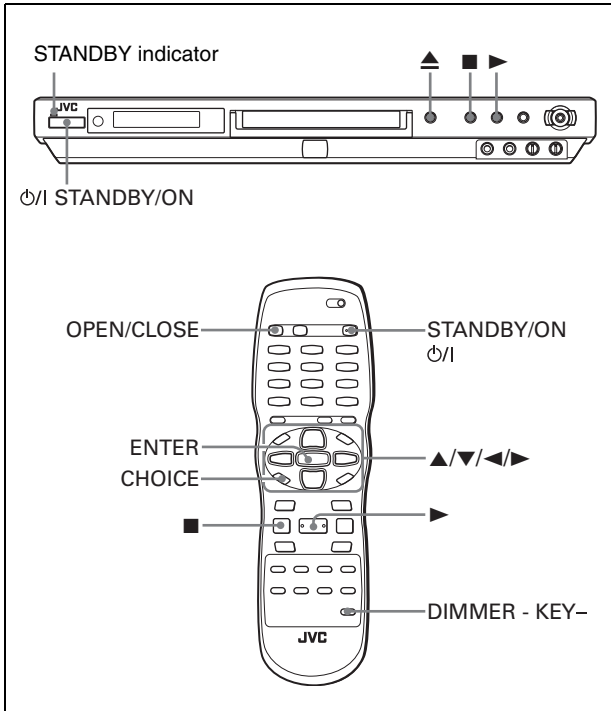

## NOTE



Make sure that the KARAOKE - DVD switch on the remote control unit is set to "DVD" when using the ▲/▼/◀/▶ and numeric buttons for controlling the unit.

## About invalid operation icon

When you press a button, and if the unit does not accept its operation, a symbol appears on your TV screen. Operations are occasionally unacceptable even if the symbol is not displayed. Note that some operations may not be accepted. For example, some discs may not allow rapid advance/reverse or slow-motion playback.

## Turning on/off the unit

Press **STANDBY/ON** on the remote control unit or press **STANDBY/ON** on the front panel.

The STANDBY indicator on the front panel, which lights in red during standby, goes off.

The opening display appears on the TV screen, and the following messages may appear at the bottom of the opening display.



Message area

- NOW READING (The unit is reading the disc information.)
- REGION CODE ERROR! (The region code of the DVD VIDEO disc does not match the unit. The disc cannot be played back.)
- OPEN
- CLOSE
- NO DISC

## NOTE

Even if you turn off the unit, the unit is not disconnected from the AC power source as long as it is connected to the wall outlet. This state is called standby mode. In this state, the unit consumes a very small amount of power.

## Initial setup

When you turn on the unit for the first time after purchase, the following message appears on the TV screen.

EXECUTE DVD PLAYER SETUP? - BASIC PICTURE/AUDIO SETTING  
YES - PRESS ENTER NO - CANCEL

You can set the display language, TV monitor type and digital output before using the unit, by following the procedure below.

### 1 Press ENTER.

The first page of the DVD PLAYER SET UP display appears. The pull-down menu of the [ON SCREEN LANGUAGE] is already open.

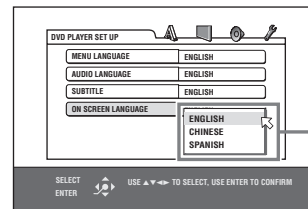

ON SCREEN LANGUAGE options

### 2 Press ▲/▼ to select the desired language.

You can select the on-screen language for the preference displays, etc. from among ENGLISH, CHINESE and SPANISH.

### 3 Press ENTER.

The second page is shown, in which the pull-down menu of the [MONITOR TYPE] is already open.

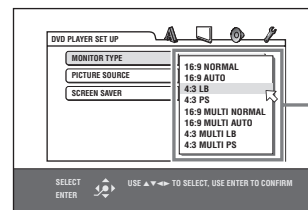

MONITOR TYPE options

### 4 Press ▲/▼ to select the desired monitor type.

For a normal (conventional) TV, select [4:3 LB] or [4:3 PS]. For a wide-screen TV, select [16:9 NORMAL] or [16:9 AUTO] (see page 27) .



**5 Press ENTER.**

The third page is shown, in which the pull-down menu of the [DIGITAL AUDIO OUTPUT] is already open.

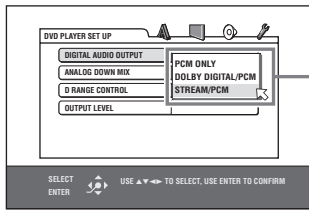

DIGITAL AUDIO OUTPUT options

**6 Press ▲/▼ to select a desired digital output signal type.**

Set this item correctly when you connect the unit to an external surround decoder or D/A converter. (If you do not connect the unit to such a device, you do not have to set this item.)

- When connecting to a Dolby Digital decoder, select [DOLBY DIGITAL/PCM].
- When connecting to a DTS decoder, select [STREAM/PCM].
- When connecting to other digital device, select [PCM ONLY].

**7 Press ENTER.**

The TV screen returns to the opening display.

**To bring up the DVD PLAYER SET UP display later**

Press CHOICE for a few seconds until the DVD PLAYER SET UP display appears.

**To change the brightness of the display window**

Press DIMMER - KEY-.

You can select the display window brightness from three levels.

**Basic playback**

**1** Press ▲ (or OPEN/CLOSE on the remote control unit) to open the disc tray.

**2** Place a disc in the disc tray.

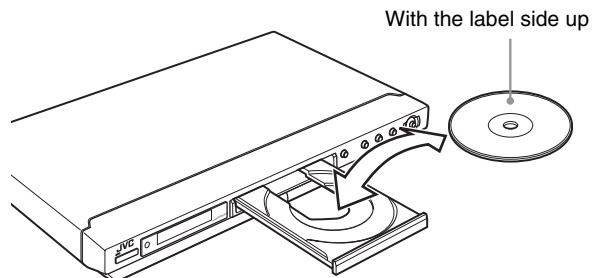

- To insert an 8-cm disc, place it in the inner recess.

**3** Press ▶.

The unit starts playback from the beginning.

**If a menu is shown on the TV screen**

When inserting a DVD VIDEO, SVCD or Video CD disc, a menu may be shown on the TV screen. From the menu, you can select a desired item to be played back.

**For DVD VIDEO**

- 1 Press ▲/▼/◀/▶ to select a desired item.
- 2 Press ENTER.

The unit starts playback of the selected item.

**For SVCD/Video CD**

Press the numeric buttons to select a desired item. The unit starts playback of the selected item.

**NOTES**

- Do not insert an unplayable disc (see page 2).
- When inserting a disc on the disc tray, be sure to position the disc inside the recess. Otherwise, the disc may be damaged when the disc tray is closed, or you may not be able to remove the disc from the unit.

**About PBC (Playback Control)**

Some SVCD/Video CD discs support the PBC function. The PBC function allows you to enjoy menu-driven operation and high-resolution still images which have a resolution four times greater than moving pictures.

- To play a PBC-compatible SVCD/Video CD disc without activating the PBC function, press the numeric buttons instead of ▶ to start playback.
- To activate the PBC function again,
  - 1) press TOP MENU or MENU,
  - or
  - 2) press ■ to stop playback, then press ▶.

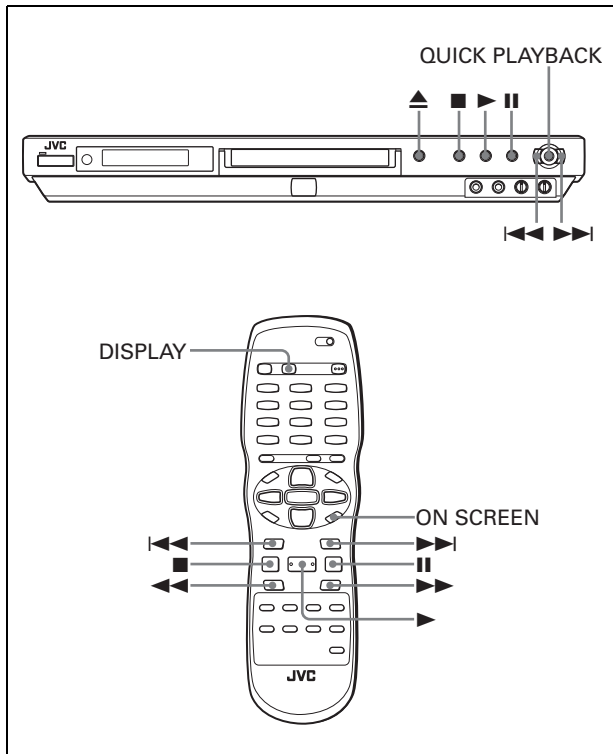

**To stop playback completely**

Press ■.

**Hint**

If you press ▲ during playback, the unit stops playback and opens the disc tray.

**To stop playback temporarily**

Press II.



To resume playback, press ►. (See the following item.)

**NOTE**

When playback is stopped temporarily while the KARAOKE function is turned on, the input signal from the MIC jack(s) is not output.

**About On-screen guide icons**

You may see the following icons displayed over the picture. They have the following meanings.

-  : Appears at the beginning of a scene recorded from multiple angles (see page 15).
-  : Appears at the beginning of a scene recorded with multiple audio languages (see page 15).
-  : Appears at the beginning of a scene recorded with multiple subtitle languages (see page 15).

**To check the playback status**

You can see the current selection number (the title/chapter number for DVD VIDEO or track number for SVCD/Video CD/ Audio CD), time information (the track or chapter time while stopped, or elapsed track or chapter time during playback) and the transport status (stop, playback, pause, etc.) on the TV screen.

Press ON SCREEN.

Example: for DVD VIDEO

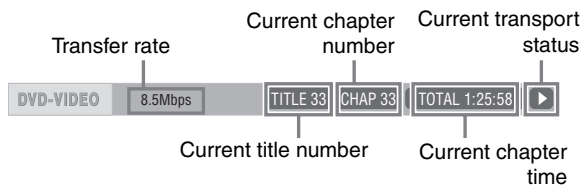

Note that pressing ON SCREEN again brings up the menu bar under the status bar, from which you can access various functions. See page 17 for details about the menu bar.

**To turn off the status bar**

Press ON SCREEN repeatedly until the status bar goes off.

**To change the display window contents**

Press DISPLAY.

Example: for DVD VIDEO

Each time you press DISPLAY, the total time display and the title/chapter number display appear alternately.

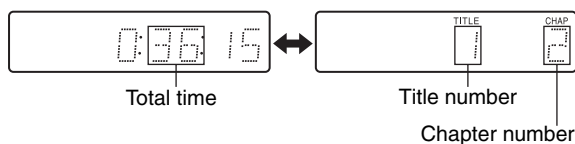

**Resuming playback**



The unit can memorize the position on a disc where you interrupt playback, and resume playback from that position later. There are three resume modes; ON, OFF and DISC RESUME. The mode is initially set to ON when you purchased the unit.

- You can select the mode using the preference display (see page 28).

**When the resume mode is "ON"**

When you press ■, the unit stops playback and memorizes the interrupted position. The TV screen shows [RESUME STOP]. The memory of the interrupted position is not cleared if you turn off the unit.

When you turn off the unit after setting the resume function, simply press ►. The unit is turned on, and playback starts from the interrupted position. If you turn on the unit by pressing ⏻/STANDBY/ON then press ►, playback starts from the beginning of the disc.

Note that the memory is cleared if you open the disc tray.

**When the resume mode is "DISC RESUME"**

When you press ■, the unit stops playback and memorizes the interrupted position. The TV screen shows [RESUME STOP].

The memory of the interrupted position is not cleared if you open the disc tray or turn off the unit.

**Hint**

The unit memorizes interrupted positions for the last 30 discs played. Storing a new interrupted position will erase the interrupted position stored for the first disc.

**To clear the memory**

Press ■ while the disc is stopped.

## To resume playback

### When the resume mode is "ON"

**While the disc you interrupted playback is still on the disc tray, press ►.**

The unit resumes playback from the position where playback was interrupted. The TV screen shows [RESUME PLAY].

#### To play back from the beginning

Press ■ before pressing ► to start playback.

### When the resume mode is "DISC RESUME"

**1 Press ▲ to insert a disc for which the unit has stored an interrupted position.**

The TV screen shows [RESUME STOP].

**2 Press ►.**

The TV screen shows [RESUME PLAY] and the unit resumes playback from the position where playback was interrupted.

#### To play back from the beginning

After inserting the disc, press ■ before pressing ► to start playback.

#### NOTES

- If you change the [RESUME] setting from [DISC RESUME] to [OFF] or [ON], you cannot resume playback of a disc whose "resuming" position is stored. However, when you again set [RESUME] to [DISC RESUME], you will then be able to resume playback of the disc.
- If you interrupt the playback of a disc for which an interrupted position has already been stored, the memory will be updated with the new interrupted position.
- For a double-sided DVD VIDEO disc, the unit regards each side as a different disc. Therefore, to resume playback of such a disc, the disc must be inserted with the same side down.
- When the unit memorizes an interrupted point for a disc, it also memorizes Audio, Subtitle and Angle settings.
- The unit may not resume playback exactly from the interrupted point. In the case of an SVCD/Video CD disc with PBC function, the unit may resume playback from a point slightly earlier or later than the point where playback was interrupted.

## Various speed playback

### x1.5 Quick Playback with sound



**During playback, press QUICK PLAYBACK on the unit.**

The lamp on the QUICK PLAYBACK button turns on, and the disc is played back at about 1.5 times normal speed. The sound is not muted, and the subtitle does not go off.

#### To return to the normal playback

Press QUICK PLAYBACK again. The lamp on the button goes off.

#### NOTES

- x1.5 Quick Playback can also be achieved by pressing ►► once. (See next section.) In this case, however, the lamp on the QUICK PLAYBACK button does not turn on.
- At the x1.5 Quick Playback mode, the digital sound is output in stereo linear PCM format. Note that the sound of a DTS-encoded DVD VIDEO disc is not output.
- Depending on a disc, the sound may not be in tune, or the sound quality may alter during the x1.5 Quick Playback mode.
- When the KARAOKE function is turned on, no sound will be heard during x 1.5 Quick Playback. Also, note that you cannot change the KARAOKE function settings during x 1.5 Quick Playback, though the input signal from the MIC jack(s) is output from the unit.
- When the KARAOKE function is turned on, the QUICK PLAYBACK button is inoperative.

### To advance or reverse playback rapidly while monitoring



**During playback, press ►► or ◀◀ on the remote control unit.**

You can select from 1.5 times, 5 times, 20 times and 60 times normal speed. Pressing ► returns the unit to normal playback.

**During playback, hold down ►► or ◀◀.**

Playback is advanced or reversed at 5 times normal speed.

#### NOTE

During rapid playback, the sound will be muted except when playing an Audio CD, and when playing a DVD VIDEO or Video CD at 1.5 times normal speed.

### To advance a still picture frame by frame



**While paused, press II.**

Each time you press II, the still picture advances to the next frame.

Pressing ► returns to normal playback.

### To play back in slow motion



You can select from 1/32 times, 1/16 times, 1/4 times and 1/2 times normal speed.

**During playback, press II, then press ►► (to play forward slow motion), or ◀◀ (to play reverse slow motion, for DVD VIDEO disc only).**

Pressing ► returns to normal playback.

#### NOTES

- During slow motion playback, the sound will be muted.
- Reverse slow motion playback is not possible for an SVCD and Video CD.
- When a DVD VIDEO disc is played in reverse slow motion while the KARAOKE function is turned on, the input signal from the MIC jack(s) is not output.

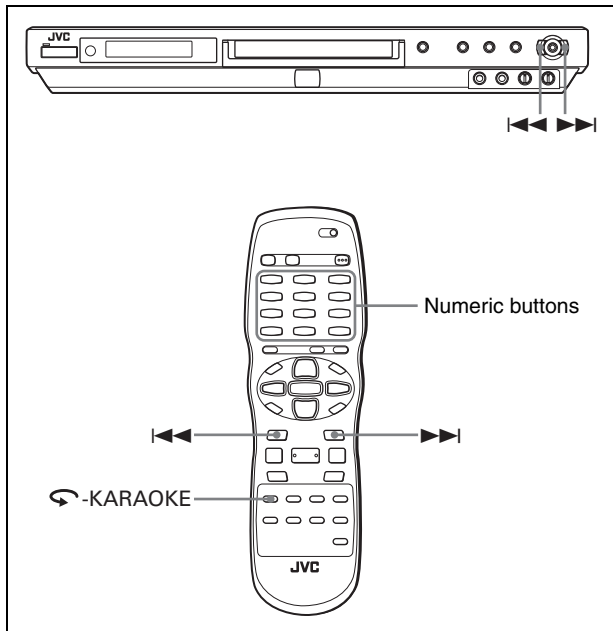

### To replay the previous scenes (One touch replay function)

**DVD VIDEO**

During DVD VIDEO playback, press - KARAOKE.

The playback position moves back 10 seconds before the current position.

**NOTES**

- This function works only within the same title, though it works between chapters.
- This function may not work with some DVD VIDEO discs.
- Before using this function while the KARAOKE function is turned on, be sure to set the KARAOKE - DVD switch on the remote control unit to "DVD."

### Locating the beginning of a scene or song

**DVD VIDEO Super VCD Video CD Audio CD**

For DVD VIDEO: During playback, you can skip a chapter or title, depending on the disc configuration.

For SVCD/Video CD: During playback without PBC function, you can skip a track.

For Audio CD: During playback or while in stop mode, you can skip a track.

To skip forward, press .

To skip backward, press .

### Using the numeric buttons

For DVD VIDEO/Audio CD: During playback or while in stop mode

For SVCD/Video CD: During playback without PBC function or while in stop mode

Press the numeric buttons to specify the number.

To select 5: press 5.

To select 23: press +10, +10, then 3.

To select 40: press +10, +10, +10, then 10.

The unit starts playback from the beginning of the selection.

**NOTES**

- Depending on the disc type and the unit status, what is specified differs:

Unit status	Disc type	What is specified
While stopped	DVD VIDEO	title
	SVCD/Video CD/Audio CD	track
During playback	DVD VIDEO	chapter
	SVCD/Video CD/Audio CD	track

- During DVD VIDEO playback, if a menu is shown on the TV screen, the numeric buttons may be used for selecting an item in the menu.

### About screen saver function

A television monitor may have an image burned into it if a static image is displayed for a long time. To prevent this, the unit automatically activates the screen saver function if a static picture, such as an on-screen display or menu, is displayed for over 5 minutes.

When the screen saver function is activated, the TV screen gets darker.

Pressing any buttons will release the screen saver function.

# Advanced operations

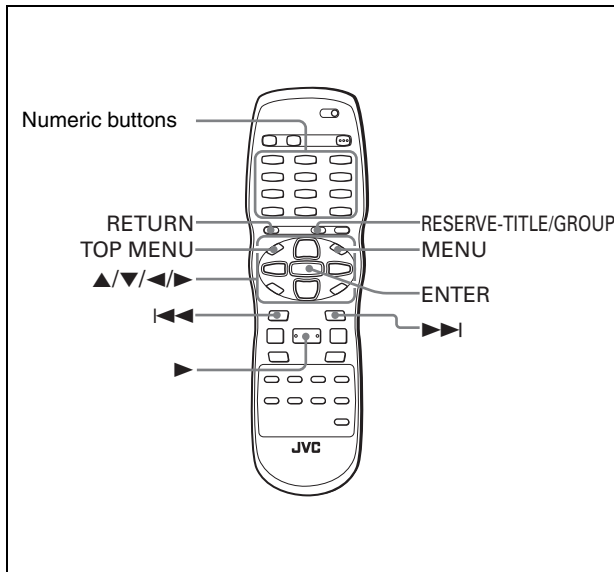

## NOTE



Make sure that the KARAOKE - DVD switch on the remote control unit is set to "DVD" when using the ▲/▼/◀/▶ and numeric buttons for controlling the unit.

## Playing from a specific position

### Locating a desired scene from the DVD menu



DVD VIDEO discs generally have their own menus which show the disc contents. These menus contain various items such as titles of movies, names of songs, or artist information, and display them on the TV screen. You can locate a desired scene using the DVD menu.

#### 1 While a DVD VIDEO disc is inserted, press TOP MENU or MENU.

The menu appears on the TV screen.

#### 2 Press ▲/▼/◀/▶ to select a desired item, then press ENTER.

The unit starts playback of the selected item.

#### Hints

- Some DVD VIDEO discs may also have a different menu which appears when MENU is pressed.
- See the instructions of each DVD VIDEO disc for its particular menu.
- With some discs, you can select items by entering the corresponding number using the numeric buttons, which may cause the unit to automatically start playback.

## NOTE

The MENU button does not work while stopped.

### Locating a desired scene from the menu of a SVCD/Video CD with PBC



Some SVCD/Video CD discs support the PBC function. PBC is an abbreviation of "Playback Control." Some SVCD/Video CD discs recorded with PBC have their own menus, such as a list of the songs of the disc. You can locate a specific scene by using the PBC menu.

#### 1 In stop mode, press ► or TOP MENU.

A disc menu appears on the TV screen.

#### 2 Press the numeric buttons to select the desired item.

To select 5: press 5.

To select 23: press +10, +10, then 3.

To select 40: press +10, +10, +10, then 10.

The unit starts playback of the selected item.

To return to the menu, press RETURN.

#### Hint

If something like [NEXT] or [PREVIOUS] appears on the TV screen, pressing ►| advances to the next page, and pressing ◀| returns to the previous page.

### Specifying a desired title



#### 1 During playback, press RESERVE - TITLE/ GROUP.

[--] is shown in the title display area of the display window.

#### 2 Press the numeric buttons to specify a title to be played.

To select 5: press 5.

To select 23: press +10, +10, then 3.

To select 40: press +10, +10, +10, then 10.

The unit starts playback from the specified title.

## NOTE

This function may not work with some DVD VIDEO discs.

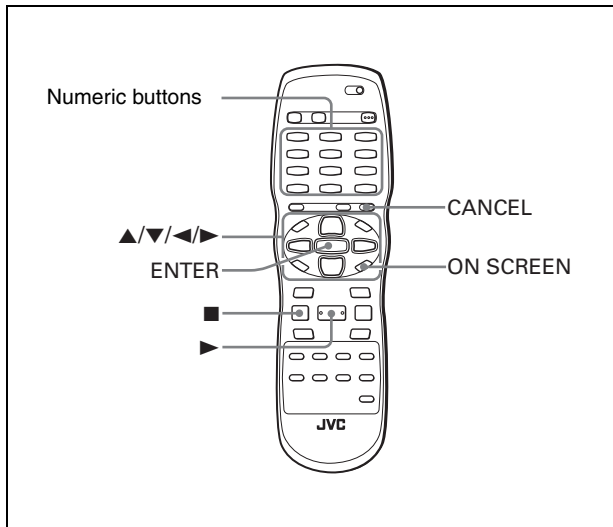

### Locating a desired position in the current title or track (Time search)



You can play a disc from the desired position by specifying the time from the beginning of the current title (for DVD VIDEO) or the disc (for SVCD/Video CD/Audio CD).

For DVD VIDEO/Audio CD: During playback or while in stop mode

For SVCD/Video CD: In any condition except SVCD/Video CD playback with PBC

#### 1 Press ON SCREEN twice.

The menu bar appears on the TV screen.

#### 2 Press ◀▶ to move to ⏪ to ⏩, then press ENTER.

The pull-down menu for entering time appears.

##### Screen example for DVD VIDEO

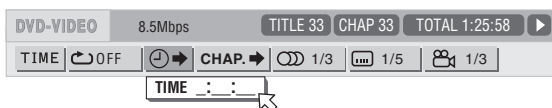

##### Screen example for Audio CD

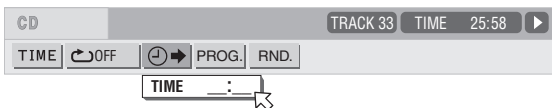

#### 3 Press the numeric buttons (0 to 9) to enter the desired time.

The specified time is displayed in the pull-down menu.

##### Example (for DVD VIDEO)

To play back from 2(H):34(M):00(S)  
Press 2, 3, then 4.

TIME 2:34:\_\_

##### Example (for SVCD/Video CD/Audio CD)

To play back from 23(M):40(S)  
Press 2, 3, then 4.

TIME 23:4\_

You do not have to press "0" to enter the trailing zeros (for the last two digits in the example above).

##### To correct a mistake

Press ◀ repeatedly to move back to the digit where you entered a wrong number, and reenter the correct one.

#### 4 Press ENTER.

The unit starts playback from the specified time.

#### To dismiss the menu bar

Press ON SCREEN.

#### Hint

"10" and "+10" buttons are not used with this function.

#### NOTES

- Some DVD VIDEO discs do not contain time information, and the time search function cannot be used.
- The time search function cannot be used during program playback.

## Changing the playback order

### To play back in a specific order (Program play)



By programming tracks, you can play up to 99 tracks in any order. You may program the same track more than once.

#### 1 In stop mode, press ON SCREEN twice.

The menu bar appears on the TV screen.

#### 2 Press ◀▶ to move to ⏪ to ⏩, then press PROG.

Screen example for Audio CD

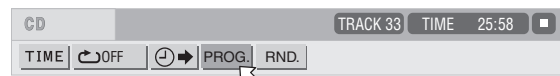

#### 3 Press ENTER.

The program table appears.

The [PROG] indicator lights up in the display window.

#### 4 Press the numeric buttons to specify tracks in the desired order.

To select 5: press 5.  
 To select 23: press +10, +10, then 3.  
 To select 40: press +10, +10, +10, then 10.

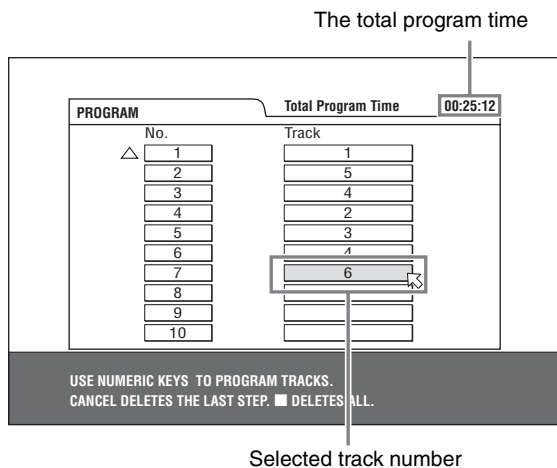

#### To correct the program

Press ▲/▼ to move  $\leftarrow$  to the track to be corrected, then press CANCEL. The track is erased and the subsequent programmed tracks move up.  
 Pressing ■ clears all the programmed tracks.

#### 5 Press ► to start program playback.

With an Audio CD disc, the program table remains on the TV screen during program playback. (Pressing ON SCREEN brings up the status bar.)  
 When all of the programmed tracks have finished playback, the unit stops and the program table appears again.  
 Note that the program remains.

- During program playback, you cannot edit the program contents.

#### To check the program contents

During playback, press ■. Playback stops and the program table is shown.  
 When the unit is playing back an Audio CD and the program table is not shown, you can bring up the table by carrying out steps 1 to 3.  
 During SVCD/Video CD playback, you can check the program contents via the menu bar.

#### To stop program playback

Press ■.

#### To clear the program

While stopped and the program table is shown, press ■.

#### To exit the program mode

After clearing the program, press ON SCREEN.

#### NOTE

When the disc tray is opened or the unit is turned off, the program is cleared.

### To play back in random order (Random play)



#### 1 In stop mode, press ON SCREEN twice.

The menu bar appears on the TV screen.

#### 2 Press ◀▶ to move $\leftarrow$ to RND.

Screen example for Audio CD

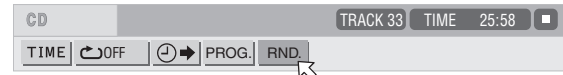

#### 3 Press ENTER.

The unit starts random playback.  
 With an SVCD/Video CD disc, the menu bar is automatically dismissed.  
 During random playback, the [RND] indicator lights up in the display window.  
 After playing all tracks of the disc, the unit stops the disc and exits the random playback mode.

#### To stop and quit random playback

Press ■. The unit stops playback and exits the random playback mode.



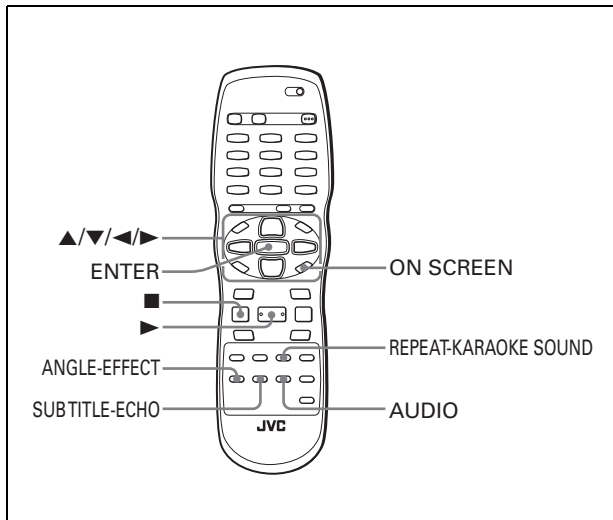

## Repeat playback

### To repeat the current selection or all tracks



For DVD VIDEO: During playback  
For SVCD/Video CD/Audio CD: In any condition except SVCD/Video CD playback with PBC

#### Press REPEAT - KARAOKE SOUND.

If you press REPEAT - KARAOKE SOUND in stop mode, press ► to start playback.

Each time you press REPEAT - KARAOKE SOUND, the repeat mode cycles among All repeat, Repeat 1 and off. The indication on the display window shows the selected repeat mode.

: Repeats the current title for DVD VIDEO or all tracks for SVCD/Video CD/Audio CD.

1: Repeats the current chapter for DVD VIDEO or the current track for SVCD/Video CD/Audio CD.

**No indication:** The repeat mode is off.

A window which indicates the current repeat mode will be displayed on the TV screen. The mode indication on the window is same as the one on the menu bar.  
(Repeat mode example on the TV screen)



### To stop repeat playback

Press ■.

When a DVD VIDEO disc is set, the unit stops playback and quits the repeat mode.

When an SVCD, Video CD or Audio CD disc is set, the unit stops playback but does not quit the repeat mode.

### To quit repeat playback

Press REPEAT - KARAOKE SOUND until the repeat mode indicator goes off in the display window.

#### Hint

When the program playback mode is active with an SVCD, Video CD or Audio CD, the repeat mode changes in the same manner.

Note, however, that in the "" mode the unit repeats all the programmed tracks instead of all tracks on the disc.

### To repeat a desired part (A-B repeat playback)



#### First make sure:

• The unit is in playback mode except SVCD/Video CD playback with PBC.

#### 1 Press ON SCREEN twice.

The menu bar appears on the TV screen.

#### 2 Press ◀▶ to move to , then press ENTER.

The pull-down menu for repeat mode selection appears.

#### 3 Press ▲/▼ to select [A-B].

#### 4 Press ENTER at the beginning of the part you want to repeat (point A).

The pull down menu disappears.

The repeat icon shows A- .

#### 5 Press ENTER at the end of the part you want to repeat (point B).

The repeat icon shows A-B .

The unit locates "A" and starts repeat playback between "A" and "B."

The [] indicator lights in the display window.

### To quit A-B repeat playback

Press ◀▶ to move to A-B , and press ENTER. The A-B repeat mode turns off, then normal playback continues.

#### NOTES

- The A and B points must be set in the same title/track.
- The A-B repeat playback cannot be made when the KARAOKE function is turned on.

## Changing the language, sound and scene angle

### To select the subtitle language (SUBTITLE)



Some DVD VIDEO and SVCD discs contain more than one subtitle language. You can choose a desired one from them.

**Hint**

At the beginning of the part where the subtitles are recorded, appears on the TV screen (except when the [ON SCREEN GUIDE] preference is set to [OFF]).

**1 During playback, press SUBTITLE - ECHO.**

The subtitle selection window appears on the TV screen.

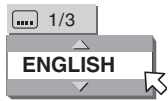

**2 Press ▲/▼ or SUBTITLE - ECHO to select the subtitle.**

Each time you press ▲/▼ or SUBTITLE - ECHO, the subtitle language changes.

**3 Press ENTER.**

Subtitles are displayed in the selected language. The subtitle selection window is dismissed.

**NOTES**

- An SVCD disc can have up to four subtitles. Pressing ▲/▼ cycles through those channels regardless of whether the subtitles are recorded or not.
- The Subtitle selection window will automatically disappear if you do not change the subtitle for several seconds.
- For DVD VIDEO, the selected language may be abbreviated on the TV screen. See "Appendix B: Table of languages and their abbreviations" on page 37.

### To change the audio language or sound (AUDIO)



The audio selection setting allows you to change the audio language of a movie, or to listen to karaoke with or without the vocal.

**Hint**

At the beginning of the part where multiple audio tracks are recorded, appears on the TV screen (except when the [ON SCREEN GUIDE] preference is set to [OFF]).

**1 During playback, press AUDIO.**

The audio selection window appears on the TV screen.

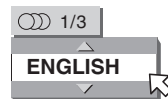

**2 Press ▲/▼ or AUDIO to select the desired audio.**

Each time you press ▲/▼ or AUDIO, the audio changes.

For DVD VIDEO (example)



For SVCD

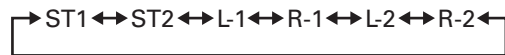

For Video CD

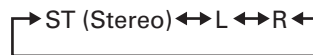

**3 Press ENTER.**

You can hear the selected audio. The audio selection window is dismissed.

**NOTES**

- The audio selection window will automatically disappear if you do not change the audio for several seconds.
- For DVD VIDEO, the selected language may be abbreviated on the TV screen. See "Appendix B: Table of languages and their abbreviations" on page 37.

### To select a scene angle of DVD VIDEO (ANGLE)



You can enjoy a variety of scene angles if the DVD VIDEO disc contains "multi-angle" parts, where multiple cameras were used to shoot the same scene from different angles.

**Hint**

At the beginning of a "multi-angle" part, appears on the TV screen (except when the [ON SCREEN GUIDE] preference is set to [OFF]).

**1 During playback, press ANGLE - EFFECT.**

The angle selection window appears on the TV screen.



**2 Press ▲/▼ or ANGLE - EFFECT to select the desired angle.**

Each time you press ▲/▼ or ANGLE - EFFECT, the angle changes.

**3 Press ENTER.**

You can see the picture from the selected angle. The angle selection window is dismissed.

**NOTE**

The angle selection window will automatically disappear if you do not change the angle for several seconds.

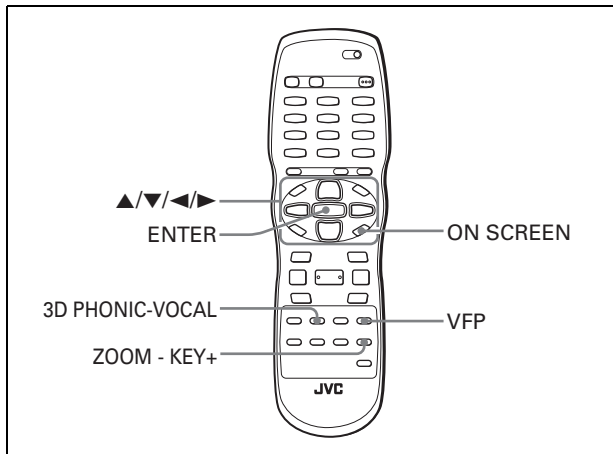

## Special picture/sound effect

### To zoom in pictures



#### 1 During playback or while paused, press ZOOM - KEY+.

Pressing ZOOM - KEY+ causes the unit to zoom in on the image. At the top left of the screen, the information for the current magnification appears for about 5 seconds. Each time you press ZOOM - KEY+, the magnification is doubled (up to 64 times).

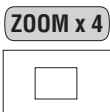

When a picture of a DVD VIDEO disc is viewed on a normal TV screen (4:3, Letter Box), black bars may appear at the top and bottom of the screen. In this case, if you select the "ZOOM x 1.8" mode, the black bars become almost invisible. When a 1:2.35 or 1:1.85 DVD VIDEO source is played back, however, the black bars are visible on the screen.

#### 2 Press ▲/▼/◀/▶ to move the zoomed position.

### To return to the normal playback

Press ENTER.

#### NOTES

- While zoomed, the picture may look coarse.
- When the KARAOKE function is turned on, you cannot zoom in pictures even if the KARAOKE - DVD switch on the remote control unit is set to "DVD."

## To adjust the picture character (VFP)



The VFP (Video Fine Processor) function allows you to adjust the picture character according to the type of programming, picture tone or personal preferences.

#### 1 During playback, press VFP.

The VFP mode selection window appears on the TV screen.

#### 2 Press ◀/▶ to select the desired preset.

Each time you press the button, the VFP mode changes as follows. Set the video type most suitable to the current program or the room conditions.



Selected preset

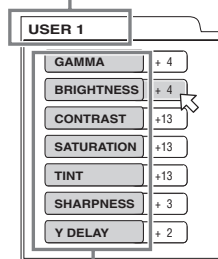

Parameter

[NORMAL]: for watching TV in a general room.

[CINEMA]: for watching a movie software in a room with suppressed light.

[USER 1] [USER 2]: you can adjust parameters that affect the picture character and store the settings as a user preset. See the next step.

#### 3 To define a user setting, press ▲/▼ to select a parameter to be edited from the following.

- **GAMMA**  
Adjust this if the neutral color is bright or dark. The brightness of dark and bright portion is maintained. Available range: -4 (darkest) to +4 (brightest)
- **BRIGHTNESS**  
Adjust this if the picture is bright or dark on the whole. Available range: -16 (darkest) to +16 (brightest)
- **CONTRAST**  
Adjust this if the far and near position is unnatural. Available range: -16 to +16
- **SATURATION**  
Adjust this if the picture is whitish or blackish. Available range: -16 (blackest) to +16 (whitest)
- **TINT**  
Adjust this if the appearance of flesh tone is unnatural. Available range: -16 to +16
- **SHARPNESS**  
Adjust this if the picture is indistinct. Available range: 0 to +3
- **Y DELAY**  
Adjust this if the picture looks separately/overlapped. Available range: -2 to +2

#### 4 Press ENTER.

A window for setting parameters appears.



Selected parameter

#### 5 Press ▲/▼ to adjust the level of the parameter.

The higher value enhances the effect.

#### 6 Press ENTER.

Repeat steps 3 to 6 if you want to set other parameters.

### To dismiss the VFP mode selection window

Press VFP.

#### NOTES

- The window for VFP mode selection and parameter setting disappear if no operation is made for about 10 seconds.
- While zoomed, the VFP function cannot be used.
- When the KARAOKE function is turned on, the VFP function cannot be activated even if the KARAOKE - DVD switch on the remote control unit is set to "DVD."

### To simulate surround sound (3D PHONIC)

#### DVD VIDEO

Using the 3D PHONIC function, you can get a simulated surround effect from your stereo system.

#### 1 During playback, press 3D PHONIC - VOCAL.

The 3D PHONIC window appears on the TV screen.

#### 2 Press ◀▶ to select the desired mode.

Each time you press the button, the 3D PHONIC mode changes as follows:

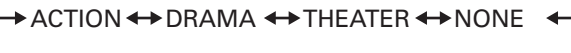

Selected effect mode

- **ACTION**  
Suitable for action movies and sports programs in which the sound source moves.
- **DRAMA**  
Natural and warm sound. You can enjoy movies in a relaxed mood.
- **THEATER**  
You can enjoy sound effects like in a theater.

#### 3 Press ▲/▼ to adjust the effect level.

You can set the effect level from [1] to [5].  
The higher value enhances the effect.

### To dismiss the 3D PHONIC window

Press 3D PHONIC - VOCAL.

#### NOTES

- The 3D PHONIC window disappears if no operation is made for about 10 seconds.
- The 3D PHONIC function works correctly only when playing back a DVD VIDEO disc recorded with Dolby Digital.
- When playing back a DVD VIDEO disc recorded with Dolby Digital that does not contain the rear signal, you can change the 3D PHONIC setting, but you will not be able to achieve a correct 3D effect.
- The 3D PHONIC function does not affect the Dolby Digital bitstream signal from the DIGITAL OUT jack.
- When the 3D PHONIC function is active, the [ANALOG DOWN MIX] setting in the [AUDIO] setting display is not available.
- When the KARAOKE function is turned on, the 3D PHONIC function is deactivated.

## Menu bar functions

### To bring up the menu bar

#### 1 When a disc is inserted, press ON SCREEN.

A status bar for the type of disc inserted will appear on the TV screen.

See page 8 for details about the status bar.

#### 2 Press ON SCREEN again.

A menu bar for the type of disc inserted will appear under the status bar.

(for DVD VIDEO)



(for SVCD)

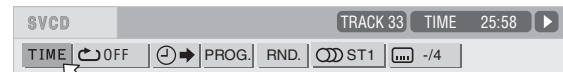

(for Video CD)

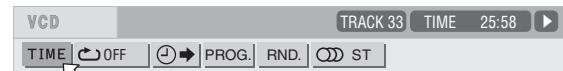

(for Audio CD)

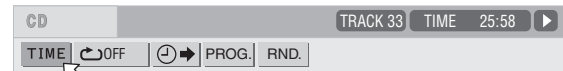

### To dismiss the menu bar and status bar

Press ON SCREEN.

## Basic operation procedure

#### 1 Press ◀▶ to select the icon you want to work with.

The selected icon is pointed by ↖.

#### 2 Press ENTER.

With many icons, an appropriate pull-down window appears, however, there are some exceptions.

#### NOTES

- A mark or text on the menu icon for the function or mode currently selected is shown in green.
- Some functions are not available during playback. (You cannot move ↖ to the associated icon when it is not available.)

### Menu bar functions for DVD VIDEO

#### Time mode selection

During playback, selects the time mode shown in the display window and in the status bar.

Press ENTER to select the time mode from the following.

- TOTAL: Current title elapsed time
- T.REM: Current title remaining time
- TIME: Current chapter elapsed time
- REM: Current chapter remaining time

#### Repeat mode (See also page 14)

Selects the repeat mode during playback.

1. Open the pull-down window.
2. Press ▲/▼ to select the repeat mode from the following.
  - CHAPTER: Current chapter repeat
  - TITLE: Current title repeat
  - A-B: A-B repeat
  - OFF: Repeat mode deactivated
3. Press ENTER to make the selected repeat function active.

#### Time search (See also page 12)

Specifies a time from the beginning of the current title as the point from which to begin playback.

#### Chapter search

During playback, specifies a desired chapter to be played back from.

1. Open the pull-down window.
2. Press numeric buttons (0 to 9) to enter a desired chapter number. (For example, to specify "10," press 1, then 0.)
3. Press ENTER to begin playback from the specified chapter.

#### Audio selection (See also page 15)

During playback, selects the audio language or sound track.

1. Open the pull-down window.
2. Press ▲/▼ to select a desired audio language or sound track.
3. Press ENTER to begin playback with the selected audio.

#### Subtitle selection (See also page 15)

During playback, selects the subtitle language.

1. Open the pull-down window.
2. Press ▲/▼ to select a desired subtitle language.
3. Press ENTER to begin playback with the selected subtitle.

#### Angle selection (See also page 15)

During playback, selects a desired scene angle in a multi-angle part.

1. Open the pull-down window.
2. Press ▲/▼ to select a scene angle.
3. Press ENTER to begin playback with the selected scene angle.

### Menu bar functions for SVCD/Video CD/ Audio CD

#### Time mode selection

Selects the time mode shown in the display window and in the status bar.

Press ENTER to select the time mode from the following.

- TIME: Current track elapsed time
- REM: Current track remaining time (while in stop mode, current track total time)
- TOTAL: Disc elapsed time
- T.REM: Disc remaining time (while in stop mode, disc total time)

#### Repeat mode (See also page 14)

Selects the repeat mode.

1. Open the pull-down window.
2. Press ▲/▼ to select the repeat mode from the following.
  - TRACK: Current track repeat
  - ALL: All track repeat
  - A-B: A-B repeat
  - OFF: Repeat mode deactivated
3. Press ENTER to make the selected repeat function active.

#### Time search (See also page 12)

Specifies a time from the beginning of the disc as the point from which to begin playback.

#### Program playback (See also pages 12 and 13)

While stopped, specifies the playback order of tracks.

#### Random playback (See also page 13)

While stopped, activates random playback.

#### Audio selection (See also page 15)

During SVCD/Video CD playback, selects the audio channel(s).

1. Open the pull-down window.
2. Press ▲/▼ to select a desired audio channel(s).
3. Press ENTER to play back with the selected audio channel(s).

#### Subtitle selection (See also page 15)

During SVCD playback, selects the subtitle.

1. Open the pull-down window.
2. Press ▲/▼ to select a desired subtitle.
3. Press ENTER to begin playback with the selected subtitle.

# MP3 disc playback

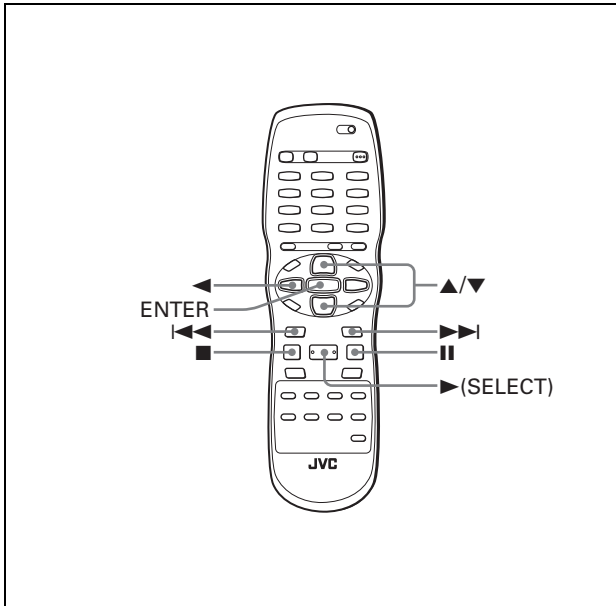

## NOTE



Make sure that the KARAOKE - DVD switch on the remote control unit is set to "DVD" when using the ▲/▼/◀▶ and numeric buttons for controlling the unit.

## Operations

The unit can play back MP3 files on a home recorded CD-R/RW disc or commercially available CD. We refer to a disc that contains MP3 files as an "MP3 disc" in this manual.

## About MP3 discs

On an MP3 disc, each song is recorded as a file (track). Files are sometimes grouped into folders by artists, album, etc.

- Each file is regarded as a track.
- A folder which has one or more files is regarded as a group.
- A folder which does not directly contain any tracks is ignored.
- Files which do not belong to any folder are grouped into "group 1."
- The unit recognizes up to 150 tracks per group, and up to 99 groups per disc. If there are files other than MP3 files, they also count in the 150-file total.

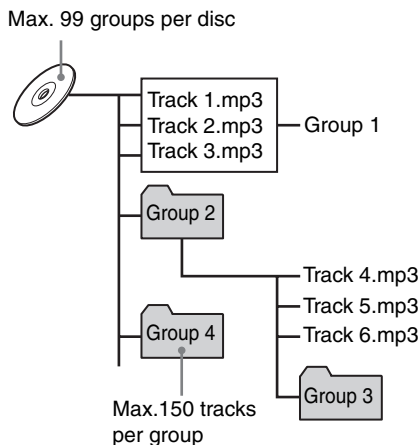

## Notes for making your own MP3 disc using a CD-R/CD-RW disc

- Select "ISO 9660" as the disc format.
- We recommend you to record your material at a 44.1 kHz sampling rate, using the 128 kbps data transfer rate.

## Basic operations

Use the following buttons to control MP3 disc playback.

- ENTER: Starts playback while stopped.  
 ▶(SELECT): Starts playback while stopped or paused.  
 ■: Stops playback.  
 II: Pauses playback.  
 I◀◀/▶▶I: Skips back or forward a track during playback. Selects the previous or next track while stopped.

If you press ▶ during playback, or press ■ to stop playback followed by ▶, the unit starts playback from the beginning of the current track.

## NOTES

- The unit does not support "packet writing (UDF format)" discs.
- The unit does not support the ID3 tag.
- The unit supports discs recorded with multiple sessions.
- Some discs may not play due to disc characteristics or recording conditions.
- Programmed and random playback functions do not work with MP3 discs.
- When an MP3 disc is played back, the KARAOKE function cannot be turned on.
- The unit only can play back tracks with the following file extensions; ".MP3," ".Mp3," ".mp3" and ".mP3."
- Time required for reading the disc contents may vary for different discs, depending on the numbers of groups (folders) and tracks (files) recorded, etc.
- You cannot advance or reverse playback by pressing ▶▶ or ◀◀, or by holding down ▶▶I or I◀◀ during MP3 disc playback.

MP3 disc playback

## Selecting the desired group and track

When inserting an MP3 disc, after the disc contents are read, the MP3 CONTROL display automatically appears on the TV screen. You can specify the desired group/track from the display using the following procedure.

### 1 Make sure that the black (cursor) bar is in the left (group) column.

If it is in the right column, press ◀ to move it to the left column.

### 2 Press ▲/▼ to move the bar to a desired group.

On the right column, tracks in the selected group are shown.

### 3 Press I◀◀/▶▶I to select a desired track, then press ENTER or ▶(SELECT).

or

### Press the numeric buttons to directly specify a desired track number.

To select 5: press 5.

To select 23: press +10, +10, then 3.

To select 40: press +10, +10, +10, then 10.

The unit starts playback from the selected track.



## MP3 disc playback

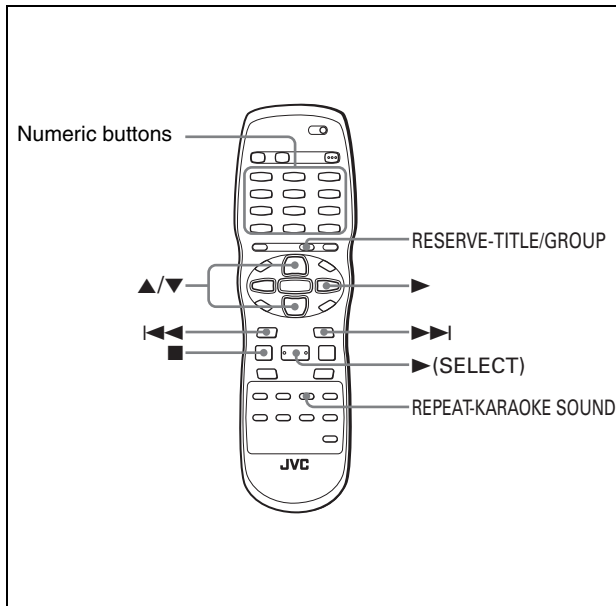

### 2 Press the numeric buttons to specify a desired group number.

To select 5: press 5.

To select 23: press +10, +10, then 3.

To select 40: press +10, +10, +10, then 10.

Specify the group number within several seconds after pressing RESERVE - TITLE/GROUP (i.e. while the display window shows [-]).

The unit starts playback from track 1 of the selected group.

### 3 Press the numeric buttons to specify a desired track number.

The unit starts playback from the specified track.

You can also use ◀◀/▶▶ or ▲/▼ to specify a track, instead of the numeric buttons.

## Repeat playback

### During playback or while stopped, press REPEAT - KARAOKE SOUND.

Each time you press REPEAT - KARAOKE SOUND, the repeat mode changes as follows.

If you press REPEAT - KARAOKE SOUND while stopped, you need to press ENTER or ▶(SELECT) to start repeat playback.

MP3 CONTROL display	Display window	Function
REPEAT TRACK	↻ 1	Repeats the current track.
REPEAT GROUP	↻	Repeats all tracks in the current group.
REPEAT ALL	↻	Repeats all tracks on the disc.
No indication	The repeat mode is off.	

(TV screen)

Selected repeat mode

MP3 CONTROL	REPEAT TRACK	
Group : 01 / 10		Track : 01 / 06 (Total 28)
spring		begonia.mp3
summer		german chamomile.mp3
fall		kiwi fruit.mp3

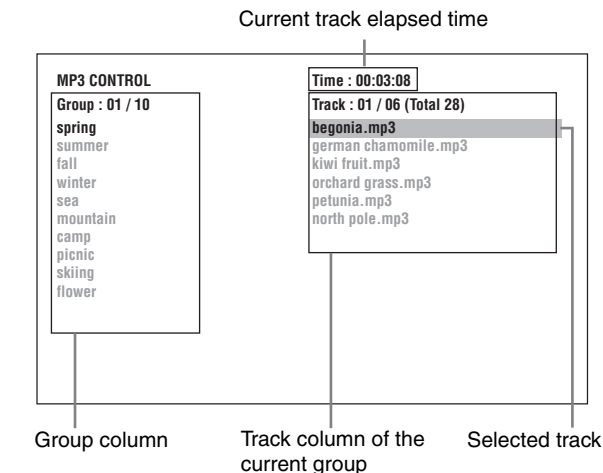

### Hint

You can also select a desired track by pressing ▶ to move the black bar to the right (track) column then using ▲/▼ or ◀◀/▶▶.

### NOTES

- If an MP3 file name includes any 2-byte character, the unit cannot show the file name correctly.
- Only MP3 files are shown on the MP3 CONTROL display.
- The order of groups/tracks shown in the MP3 CONTROL display may differ from the order shown on your personal computer when you set the disc on your computer.

## Direct selection

You can select a desired group directly by specifying the group number.

### 1 During playback or while stopped, press RESERVE - TITLE/GROUP.

[-] is shown in the group display area of the display window.

### To stop repeat playback

Press ■. Note that the repeat mode remains active.

### To quit repeat playback

During playback, press REPEAT - KARAOKE SOUND until no repeat icon is shown on the display window.

While stopped, press REPEAT - KARAOKE SOUND until repeat mode indication on the MP3 CONTROL display goes off.



# KARAOKE operation

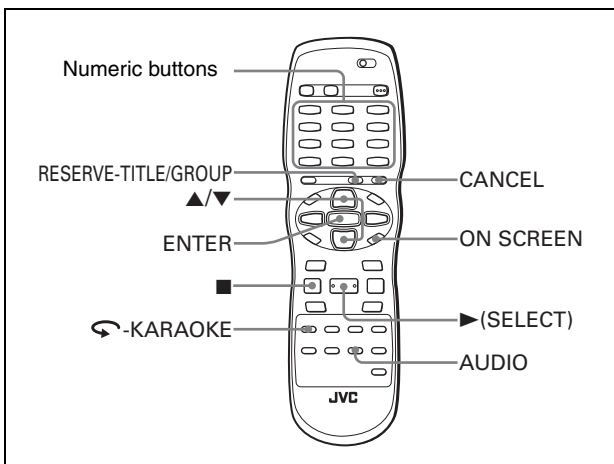

## NOTE



Make sure that the KARAOKE - DVD switch on the remote control unit is set to "KARAOKE" when using the karaoke-related buttons for controlling the unit.

## Preparation

### Turning on the KARAOKE function



Press **KARAOKE**.

The KARAOKE function turns on, the [KARAOKE] indicator lights up on the display window, and the KARAOKE menu appears on the TV screen.

#### TV screen

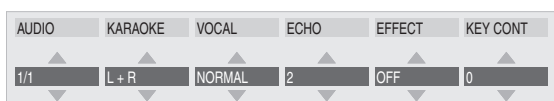

### To turn on and off the KARAOKE menu

Press **ON SCREEN**.  
Each time you press **ON SCREEN**, the KARAOKE menu appears and disappears, while the KARAOKE function remains active.

### To deactivate the KARAOKE function

Press **KARAOKE** again.  
The KARAOKE function is turned off, and the [KARAOKE] indicator goes off.

## NOTES

- During program or random playback, you cannot turn on the KARAOKE function.
- When an MP3 disc is played back, the KARAOKE function cannot be turned on.
- When the KARAOKE menu is displayed on the TV screen, the DVD VIDEO disc picture cannot be manipulated with **▲/▼/◀/▶** on the remote control unit.
- The A-B repeat playback cannot be made when the KARAOKE function is turned on.

## Connecting microphones

Connect microphone(s) to the MIC 1/2 jack(s) on the front panel.

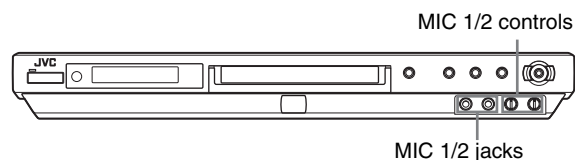

### To adjust the microphone volume

Turn the MIC 1/2 control(s) on the front panel.  
Turning it clockwise raises the level, while turning it counter-clockwise lowers the level.

## NOTES

- When a DVD VIDEO, SVCD, Video CD or Audio CD disc is inserted, you can enjoy the input signal from the MIC 1/2 jacks with the DIGITAL OUT jacks.
- When the KARAOKE mode is turned on, "PCM ONLY" is forcibly applied to the type of the digital output signal, regardless of the [DIGITAL AUDIO OUTPUT] setting in the [AUDIO] preference (see page 28).
- While playback is stopped temporarily or while a DVD VIDEO disc is played in reverse slow motion, the input signal from the MIC jack(s) is not output.

## Reserving songs

You can reserve up to 12 songs to play in the desired order.  
You may reserve the same song more than once.

### Playing back songs reserved



Turn on the KARAOKE function, and proceed as follows:

- 1 Press RESERVE - TITLE/GROUP.**  
The reservation table appears on the TV screen.
- 2 Press the numeric buttons to specify tracks in the desired order.**

To select 5: press 5.  
To select 23: press +10, +10, then 3.  
To select 40: press +10, +10, +10, then 10.

NO	Track
1	5
2	4
3	2
4	3
5	6
6	

### To correct the reservation

Press **▲/▼** to move **↔** to the song to be corrected, then press **CANCEL**. The song is erased and the subsequent reserved songs move up.  
Pressing **■** clears all the reserved songs.

- 3 Press ► (SELECT).**

The [PROG] indicator lights up in the display window.  
The unit starts playback of the first reserved song.  
A song which has started playback is deleted from the reservation table.  
After playing back all reserved songs, the unit stops.

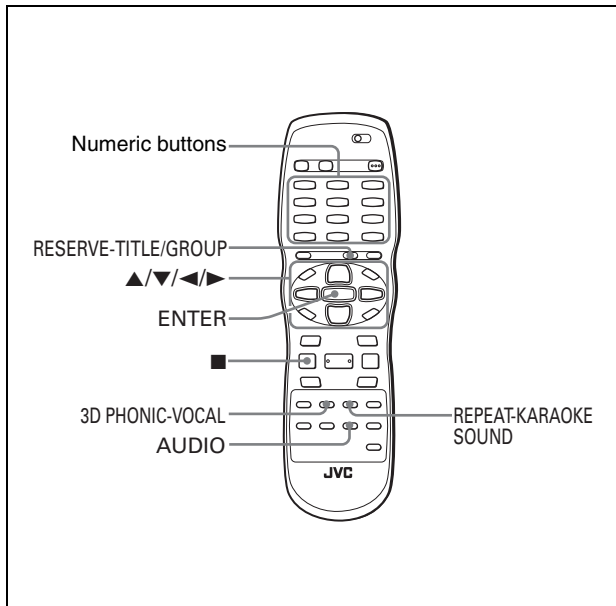

### To turn off and on the reservation table

Press RESERVE - TITLE/GROUP to turn off the reservation table. To turn on the reservation table, for example in order to check the reservation contents, press RESERVE - TITLE/GROUP again.

### To reserve additional songs

Make sure that points the next to the last song in the reservation table, and press the numeric buttons to select the song(s) you want to reserve.

### To insert a song to be reserved

Press to move to the position where you want to insert a song, then press the numeric button to select the song you want to reserve.

#### NOTE

You cannot reserve songs during SVCD/Video CD playback with PBC. To reserve songs, press before operating the above.

## Selecting audio

Most KARAOKE discs have the capability of adding a "guide vocal" or "guide melody" to the KARAOKE accompaniment.

## Selecting audio track (AUDIO)



With most DVD VIDEO or SVCD KARAOKE discs, you can choose an audio track that gives an option such as "with guide vocal," "with guide melody" and "accompaniment only."

### Using the KARAOKE menu

See page 21 for how to turn on the KARAOKE menu.

- 1** Press to move to [AUDIO].
- 2** Press to select the desired audio track to be played back.

#### Example for DVD VIDEO

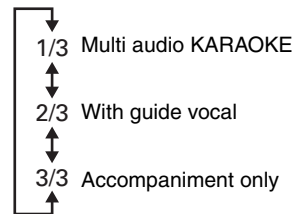

#### Example for SVCD

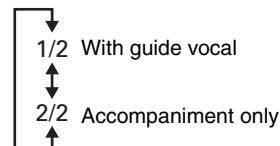

### Using the AUDIO button

You can select an audio track without activating the KARAOKE menu.

#### NOTE

Before using the AUDIO button, be sure to set the KARAOKE - DVD switch on the remote control unit to "DVD."

- 1** Press AUDIO.

The [AUDIO] selection window appears on the TV screen.



- 2** Press to select the desired audio track.
- 3** Press ENTER, or wait until the [AUDIO] selection window goes off.

## Selecting KARAOKE sound (KARAOKE SOUND)



Among KARAOKE DVD VIDEO discs, there are “multi-sound KARAOKE” discs. With such a disc, for example, you can sing along with the other vocal part recorded on a disc.

### Using the KARAOKE menu

See page 21 for how to turn on the KARAOKE menu.

#### NOTES

- When playing back a “multi-sound KARAOKE” disc, [AUDIO] should be set to [1] (see page 22).
- With a DVD VIDEO disc which does not contain “multi-sound KARAOKE,” the KARAOKE SOUND cannot be changed.

- 1 Press **◀/▶** to move **↩** to [KARAOKE].
- 2 Press **▲/▼** to select the desired sound to be played back.

Example for multi-sound KARAOKE DVD VIDEO

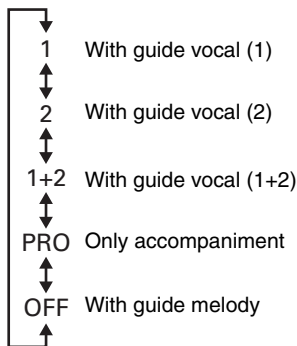

Example for SVCD, Video CD or Audio CD with KARAOKE

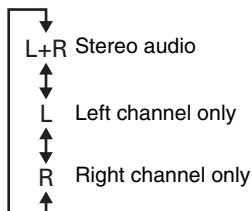

### Using the REPEAT - KARAOKE SOUND button

You can select sound without activating the KARAOKE menu.

- 1 Press **REPEAT - KARAOKE SOUND**.

The [KARAOKE] selection window appears on the TV screen.

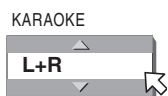

- 2 Press **▲/▼** to select the desired sound.
- 3 Press **ENTER**, or wait until the [KARAOKE] selection window goes off.

## Using convenient functions for practicing KARAOKE (VOCAL)



You can mask a vocal recorded on normal non-KARAOKE discs, or have the guide vocal replace your voice automatically when you stop singing.

### Using the KARAOKE menu

See page 21 for how to turn on the KARAOKE menu.

- 1 Press **◀/▶** to move **↩** to [VOCAL].
- 2 Press **▲/▼** to select the desired function.



[NORMAL]: normal playback.

[MASK]: a vocal recorded on normal non-KARAOKE disc is masked.

[REPLACE]: the guide vocal automatically replaces your voice when you stop singing.

### Using the 3D PHONIC - VOCAL button

You can select a desired function without activating the KARAOKE menu.

- 1 Press **3D PHONIC - VOCAL**.

The [VOCAL] selection window appears on the TV screen.



- 2 Press **▲/▼** to select the desired function.
- 3 Press **ENTER**, or wait until the [VOCAL] selection window goes off.

#### NOTES

- If [KARAOKE] is set to [L] or [R], the vocal mask function does not work correctly.
- With some materials, such as those recorded in monaural and sung by multiple voices, the voice may not be satisfactorily masked.
- When playing back a disc with the multiplex audio or with multi-sound KARAOKE, the guide vocal is not played back at all. With other discs, the voice may not be satisfactorily masked.

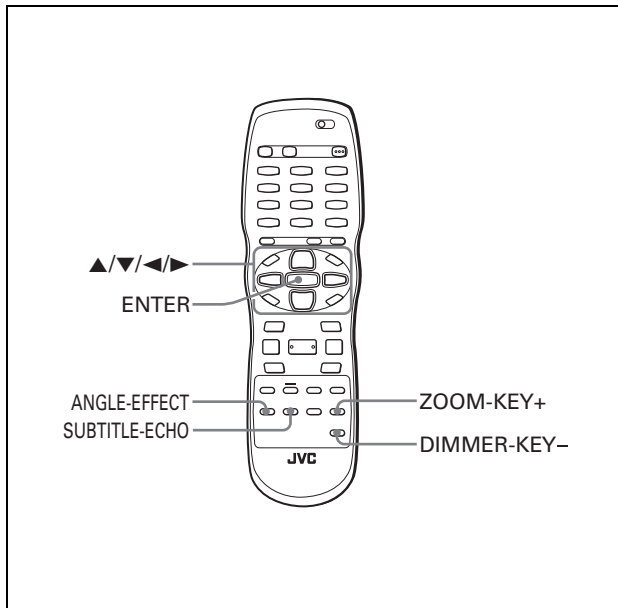

## Adding an effect to your voice

You can add various effects to your voice using the echo and vocal effect functions.

## Adding an echo effect (ECHO)



### Using the KARAOKE menu

See page 21 for how to turn on the KARAOKE menu.

- 1 Press **◀▶** to move **↩** to [ECHO].
- 2 Press **▲/▼** to adjust the echo level.

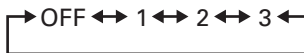

The higher the number, the stronger the echo effect.

### Using the SUBTITLE - ECHO button

You can adjust the echo level without activating the KARAOKE menu.

- 1 Press **SUBTITLE - ECHO**.

The [ECHO] selection window appears on the TV screen.



- 2 Press **▲/▼** to adjust the echo level.
- 3 Press **ENTER**, or wait until the [ECHO] selection window goes off.

#### NOTE

If you select an effect (VOCAL EFFECT) after adjusting the echo level, the echo level will be reset to OFF.

## Adding various effects to the vocal (VOCAL EFFECT)



### Using the KARAOKE menu

See page 21 for how to turn on the KARAOKE menu.

- 1 Press **◀▶** to move **↩** to [EFFECT].
- 2 Press **▲/▼** to select the desired effect.



[FLANGER]: adds a wet, metallic sweeping sound to your voice, similar to some electric guitar sounds.

[CHORUS]: produces a doubling effect on your vocal, as if another person is singing in unison.

### Using the ANGLE - EFFECT button

You can select a desired vocal effect without activating the KARAOKE menu.

- 1 Press **ANGLE - EFFECT**.

The [EFFECT] selection window appears on the TV screen.

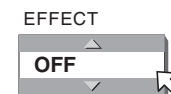

- 2 Press **▲/▼** to select the desired effect.
- 3 Press **ENTER**, or wait until the [EFFECT] selection window goes off.

#### NOTE

If you adjust the echo level after selecting an effect, the effect will be reset to OFF.

## Shifting the musical key



You can shift the musical key of a song recorded on a disc to fit to your voice.

### Using the KARAOKE menu

See page 21 for how to turn on the KARAOKE menu.

- 1** Press ◀▶ to move ↻ to [KEY CONT].
- 2** Press ▲ to raise up the key, and ▼ to drop down the key.

The adjustable range is from -4 to +4.

### Using the ZOOM - KEY+ / DIMMER - KEY- buttons

You can shift the musical key without activating the KARAOKE menu.

- 1** Press ZOOM - KEY+ or DIMMER - KEY-.
- The [KEY CONT] selection window appears on the TV screen.

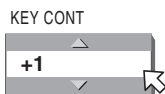

- 2** Press ZOOM - KEY+ /DIMMER - KEY- to raise up or drop down the key.
- 3** Press ENTER, or wait until the [KEY CONT] selection window goes off.

#### NOTES

- The key returns to the normal key after the current song ends.
- You cannot shift the musical key when playing back a disc listed below:
  - Audio CD with DTS
  - DVD with DTS
  - DVD with MPEG Multichannel
  - DVD with 96 kHz linear PCM

# Changing the initial settings

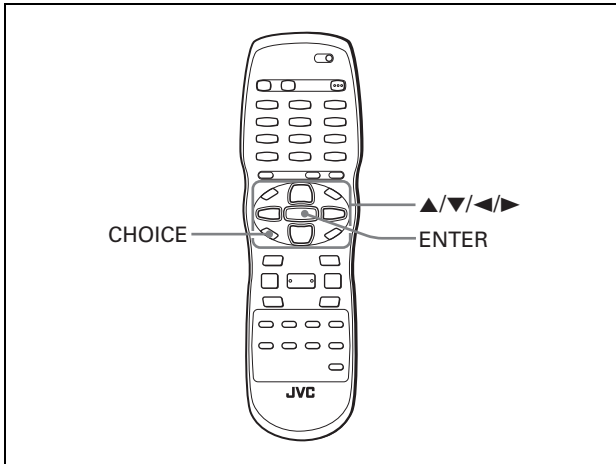

## NOTES



- Make sure that the KARAOKE - DVD switch on the remote control unit is set to "DVD" when using the ▲/▼/◀/▶ and numeric buttons for controlling the unit.
- If the KARAOKE function is turned on, you cannot change the initial settings. Before changing the initial settings, be sure to turn off the KARAOKE function and set the KARAOKE - DVD switch to "DVD."

## Selecting preferences

This section refers to the settings which are already made when you purchase the unit. Read this section when you want to connect this unit to a wide-vision TV set, or when you want to otherwise change the settings according to your preferences and viewing environment.

## About the Preference display

The Preference display consists of the LANGUAGE, PICTURE, AUDIO and OTHERS setting displays, each having setting items.

### LANGUAGE

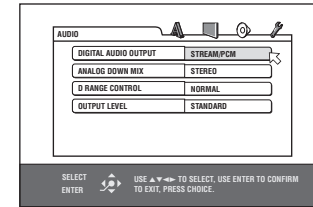
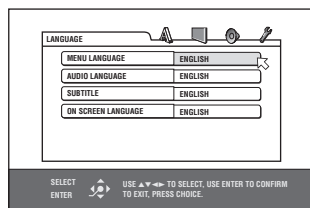

### AUDIO

### OTHERS

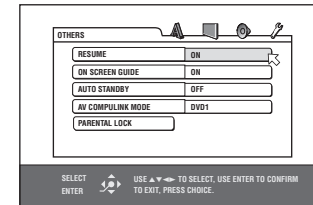

## How to set preferences

### 1 Press CHOICE.

One of the preference on-screen displays appears on the TV screen.

You can see four icons at the top right of the on-screen display for the settings.

🗨️ : LANGUAGE menu

🖼️ : PICTURE menu

🔊 : AUDIO menu

🔧 : OTHERS menu

### 2 Press ◀/▶ to select the appropriate icon.

The appropriate display appears on the TV screen.

### 3 Press ▲/▼ to move 🖱️ to select the item you want to edit.

The color of the selected item changes.

### 4 Press ENTER.

A pull-down menu appears over the selected item.

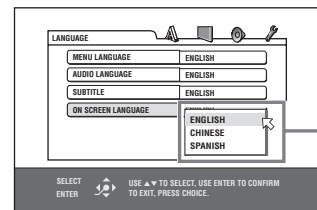

Selected item

### 5 Press ▲/▼ to select from the options then press ENTER.

The selected option is set.

- For details about each setting, see the following.

## To dismiss a preference display

Press CHOICE.

## NOTES

- While an MP3 disc is inserted, you cannot bring up any preference display.
- When a preference display is shown on a wide TV screen, the upper and lower parts of the preference display sometimes may be cut off. If this happens, adjust the picture size control of the TV.

### PICTURE

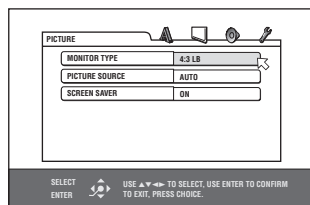

## LANGUAGE menu

### MENU LANGUAGE

You can select the default menu language to be displayed if it is contained on a DVD VIDEO disc.

#### Setting options

**ENGLISH, SPANISH, FRENCH, CHINESE, GERMAN, ITALIAN, JAPANESE, language code from AA to ZU**

- If the disc does not have a menu in the selected language, the disc's default language will be used.
- For details about language codes, see "Appendix B: Table of languages and their abbreviations" on page 37.
- You cannot change the setting during playback.

### AUDIO LANGUAGE

You can select the default audio language to be played if it is contained on a DVD VIDEO disc.

#### Setting options

**ENGLISH, SPANISH, FRENCH, CHINESE, GERMAN, ITALIAN, JAPANESE, language code from AA to ZU**

- If the disc does not have the selected language, the disc's default language will be used.
- For details about language codes, see "Appendix B: Table of languages and their abbreviations" on page 37.
- You cannot change the setting during playback.

### SUBTITLE

You can select the default subtitle language to be displayed if it is contained on a DVD VIDEO disc.

#### Setting options

**OFF, ENGLISH, SPANISH, FRENCH, CHINESE, GERMAN, ITALIAN, JAPANESE, language code from AA to ZU**

- If the disc does not have a subtitle in the selected language, the disc's default language will be used.
- For details about language codes, see "Appendix B: Table of languages and their abbreviations" on page 37.
- You cannot change the setting during playback.

### ON SCREEN LANGUAGE

You can select the on-screen display language of the unit.

#### Setting options

**ENGLISH, CHINESE, SPANISH**

- Some on-screen messages are shown in English regardless of the setting.
- You cannot change the on-screen language shown on the MP3 display.

## PICTURE menu

### MONITOR TYPE

You can select the monitor type to match your TV when you play back DVD VIDEO discs recorded for wide-screen televisions.

#### Setting options

**16:9 NORMAL, 16:9 AUTO, 4:3 LB, 4:3 PS, 16:9 MULTI NORMAL, 16:9 MULTI AUTO, 4:3 MULTI LB, 4:3 MULTI PS**

**[16:9 NORMAL] (Wide television screen):** select when you connect the unit to a wide-screen (16:9) TV whose aspect ratio is fixed to 16:9 (the unit automatically adjusts the screen width of the output signal correctly when playing back a 4:3 source).

If you play a 4:3 DVD VIDEO source using the [16:9 NORMAL] mode, the picture character changes slightly due to the process for converting the picture width.

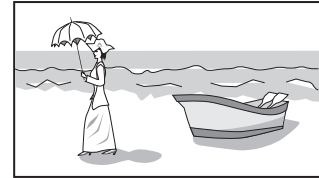

**[16:9 AUTO] (Wide television screen):** select when you connect the unit to a wide-screen (16:9) TV.

**[4:3 LB] (Letter Box conversion):** select when you connect the unit to a normal (4:3) TV.

When playing back a DVD VIDEO disc recorded in wide picture format, the picture is shown with black bars at the top and bottom.



**[4:3 PS] (Pan Scan conversion):** select when you connect the unit to a normal (4:3) TV.

When playing back a DVD VIDEO disc recorded in wide picture format, the picture is zoomed to fill the screen vertically, and the left and right sides of the image are chopped off.

Note, however, that the picture will be shown in the 4:3 LB mode even if you select the 4:3 PS mode depending on the disc.

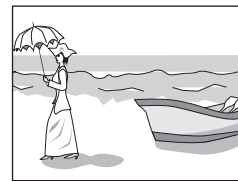

**[16:9 MULTI NORMAL] [16:9 MULTI AUTO]**

**[4:3 MULTI LB] [4:3 MULTI PS]:** These "MULTI" options should be selected when you connect the unit to a TV that supports both the PAL and NTSC systems. If you select one of these options, the unit outputs a PAL or NTSC video signal according to the disc, regardless of the VIDEO SIGNAL SELECTOR setting.

### PICTURE SOURCE

This mode selects whether the content on the disc is processed by field (video source) or by frame (film source). You can obtain optimal picture quality according to the source type to be played back by selecting an appropriate option.

#### Setting options

**AUTO, FILM, VIDEO(NORMAL), VIDEO(ACTIVE)**

**[AUTO]:** select when playing back a disc containing both video and film source materials.

The unit recognizes the picture type (film or video source) of the current disc according to the disc information. Normally, select this option.

**[FILM]:** select when playing back a film source disc.

**[VIDEO(NORMAL)]:** select when playing back a video source disc with relatively a few movements.

**[VIDEO(ACTIVE)]:** select when playing back a video source disc with relatively a lot of movements.



## Changing the initial settings

### SCREEN SAVER

You can set the screen saver function to ON or OFF. (See page 10.)

#### Setting options

ON, OFF

## AUDIO menu

### DIGITAL AUDIO OUTPUT

To connect the unit's digital output to an external device equipped with a digital input, this item must be set correctly.

See "Appendix C: Digital output signal chart" on page 38 for details about the relation between the setting and output signals.

#### Setting options

#### PCM ONLY, DOLBY DIGITAL/PCM, STREAM/PCM

**[PCM ONLY]:** select when you connect the DIGITAL OUT jack of the unit to the linear PCM digital input of other audio equipment.

**[DOLBY DIGITAL/PCM]:** select when you connect the digital input of a Dolby Digital decoder or an amplifier with a built-in Dolby Digital decoder.

When this option is selected, playing back a disc recorded by the MPEG Multichannel format outputs a linear PCM digital signal.

**[STREAM/PCM]:** select when you connect the digital input of an amplifier with a built-in DTS, MPEG Multichannel or Dolby Digital decoder, or the stand-alone unit of such a decoder.

- With some DVD VIDEO discs that are not fully copy-protected, a 20 or 24 bit digital signal may be output.
- A signal recorded with the 96 kHz or higher sampling frequency is output from the DIGITAL OUT jack with the 48 kHz sampling frequency.
- The unit does not provide the DTS decoding function.
- When playing a DVD VIDEO or Audio CD disc with DTS, use a DTS decoder to get correct signals from your speakers.
- DTS-encoded signal is output only from the unit's DIGITAL OUT jacks.
- If the unit is not connected to audio equipment with a DTS decoder, DTS-encoded signal output from the DIGITAL OUT jacks is distorted.

### ANALOG DOWN MIX

To correctly play the audio on a DVD VIDEO disc recorded with surround multichannel audio, you must set this item properly according to your audio system configuration.

(This function does not work when the 3D PHONIC function is activated.)

#### Setting options

#### DOLBY SURROUND, STEREO

**[DOLBY SURROUND]:** select when listening to multichannel surround audio with the unit's analog AUDIO OUT terminals connected to a surround decoder.

**[STEREO]:** select when listening to conventional two-channel stereo audio with the unit's AUDIO OUT terminals connected to a stereo amplifier/receiver or television set, or in case you want to record the audio from a DVD VIDEO disc to MiniDisc, cassette, etc.

### D. RANGE CONTROL

This setting provides optimal audio quality from the analog AUDIO OUT terminals for listening to DVD VIDEO discs recorded in Dolby Digital format, at low or middle volume.

#### Setting options

#### WIDE RANGE, NORMAL, TV MODE

**[WIDE RANGE]:** when selected, audio is played back with the widest dynamic range so that you can enjoy powerful playback sound.

**[NORMAL]:** normally, select this option.

**[TV MODE]:** select if DVD VIDEO disc sound level is lower than TV program sound level. Thus you can hear sound at a lower volume clearly.

### OUTPUT LEVEL

This setting allows you to attenuate the level of the signal output from the unit's analog AUDIO OUT terminals.

#### Setting options

#### STANDARD, LOW

- If the sound output from the speaker is distorted, select [LOW].

## OTHERS menu

### RESUME

You can select the resume playback mode.

See pages 8 and 9 for details about the resume playback function.

#### Setting options

#### ON, OFF, DISC RESUME

**[ON]:** when selected, the unit can resume playback of the disc from the position where playback was last interrupted, if the disc is still in the disc tray.

**[OFF]:** when selected, the resume function is deactivated.

**[DISC RESUME]:** when selected, the unit can resume playback of the last 30 discs played. The unit retains a memory of the interrupted positions of the last 30 discs played, even though they have been removed from the disc tray.

### ON SCREEN GUIDE

The unit can display "on-screen guide" icons or characters on the picture, which show what is happening to the disc or the unit.

Example of "on-screen guide" icons: 

#### Setting options

#### ON, OFF

**[ON]:** when selected, the on-screen guide is activated.

### AUTO STANDBY

When the unit is stopped for more than 30 minutes or 60 minutes, the unit enters standby mode automatically.

#### Setting options

#### 60, 30, OFF

### AV COMPULINK MODE

You must set this item correctly to use the AV COMPULINK system.

#### Setting options

#### DVD1, DVD2, DVD3

- See page 33 for details about the AV COMPULINK function.

## PARENTAL LOCK

When this option is selected, pressing ENTER on the remote control brings up the PARENTAL LOCK display shown below. This allows you to restrict children from playing DVD VIDEO discs.

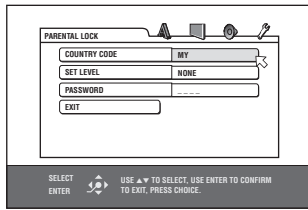

- See this page for details about the parental lock setting.

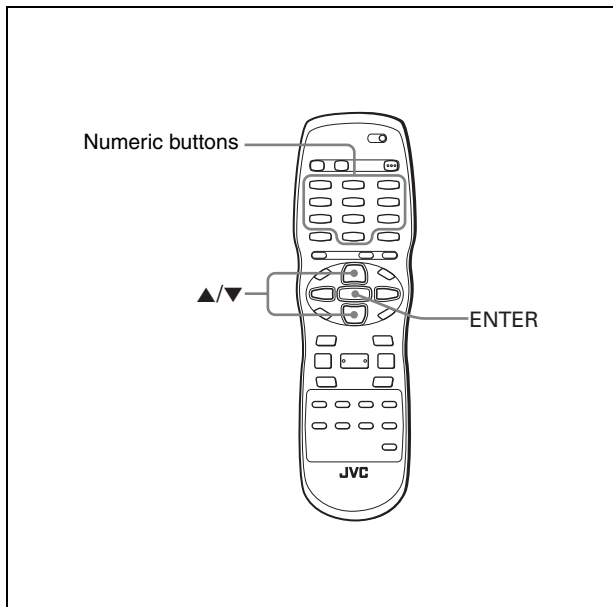

## Limiting playback by children

This function restricts playback of DVD VIDEO discs which contain violent (and other) scenes according to the level set by the user. For example, if a movie which includes violent scenes supports the parental lock feature, such scenes which you do not want to let children view can be cut or replaced with other scenes.

## To set Parental Lock for the first time



- 1 Bring up the OTHERS menu.
- 2 Press ▲/▼ to move to select [PARENTAL LOCK] then press ENTER.  
The Parental Lock on-screen display appears on the TV screen.

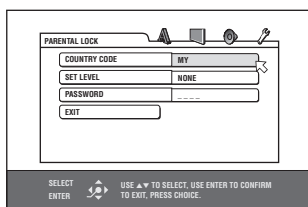

- 3 While is pointing to [COUNTRY CODE], press ENTER to bring up the pull-down menu.

- 4 Press ▲/▼ to select the country code.

Select the code of the country whose standards were used to rate the DVD VIDEO disc content. See "Appendix A: Country/Area code list for Parental Lock" on page 36.

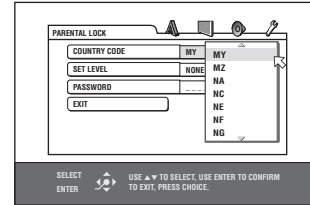

- 5 Press ENTER.

moves to [SET LEVEL].

- 6 Press ENTER to bring up the pull-down menu.

In the pull-down menu, [NONE] and levels [8] to [1] are available. [NONE] does not restrict playback. Level [1] is the strictest level. Discs rated higher than the selected level are restricted.

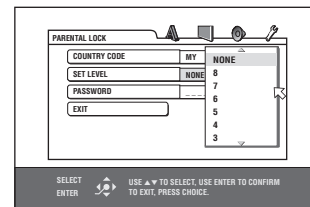

- 7 Press ▲/▼ to select a desired parental lock level, then press ENTER.

moves to [PASSWORD].

- 8 Press the numeric buttons (0 to 9) to enter a 4-digit password.

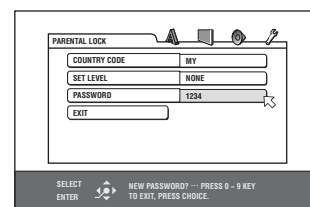

- 9 Press ENTER.

The parental lock feature is set.

moves to [EXIT]. Pressing ENTER again returns to the [OTHERS] menu of the preference display.

### Hint

If you want to change the password at step 8, do it before pressing ENTER.

### To change the settings



You can change the parental lock settings later.



- 1 Bring up the **OTHERS** menu.
- 2 Press **▲/▼** to move  to select **[PARENTAL LOCK]** and press **ENTER**.

The parental lock on-screen display appears on the TV screen.

- 3 While  is pointing to **[PASSWORD]**, press the numeric buttons to enter your current 4-digit password then press **ENTER**.

 moves to **[COUNTRY CODE]** if you enter the correct password.

If you enter a wrong password, "WRONG! RETRY..." appears on the TV screen, and you cannot go to the next step. If you forget your password, enter "8888." The current password is deleted and you can set a new password.

- 4 To change the **[COUNTRY CODE]** or **[SET LEVEL]**, press **ENTER** to bring up the associated pull-down menu when  is pointing to the desired item.
  - 5 Press **▲/▼** to select the desired option then press **ENTER**.
- 6 While  is pointing to **[PASSWORD]**, press the numeric buttons to enter a 4-digit password.
- 7 Press **ENTER**.

If you change the country code, you must reselect the parental lock level.

The password entered in this step becomes the new password. If you want to keep the same password as before, enter the same password.

 moves to **[EXIT]**. Pressing **ENTER** again returns to the **[OTHERS]** menu of the preference display.

#### NOTE

If you enter the wrong password more than 3 times in step 3 above,  moves to **[EXIT]** automatically and **▲/▼** do not work.

### To temporarily release the Parental Lock



If the parental level is set to a strict value, some discs may not play at all.

When you insert such a disc and try to play it, the following parental lock on-screen display appears on the TV screen, asking you whether you want the parental lock to be temporarily released or not.

- 1 Press **▲/▼** to move  to **[TEMPORARY RELEASE]**, then press **ENTER**.

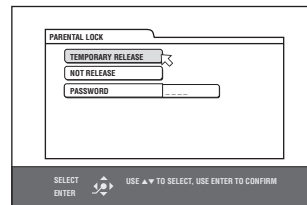

- 2 Press the numeric buttons (0 to 9) to enter your 4-digit password.

The Parental Lock is released, and the unit starts playback. If you enter a wrong password, "WRONG! RETRY..." appears on the TV screen. Enter the correct password.

#### NOTE

When you enter the wrong password 3 times at step 2 above,  moves to **[NOT RELEASE]** automatically and **▲/▼** do not work.

# Additional information

## Names of parts and controls

### Front panel

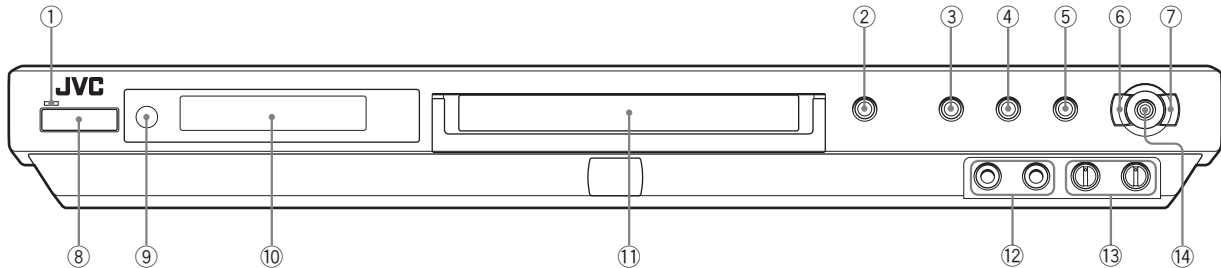

- ① STANDBY indicator (6)
- ② ▲ button (7)
- ③ ■ button (7, 8)
- ④ ► button (7, 9)
- ⑤ || button (8, 9)
- ⑥ ◀◀ button (9, 10)
- ⑦ ▶▶ button (9, 10)
- ⑧ ⏻/⏻ STANDBY/ON button (6)
- ⑨ Remote sensor (5)
- ⑩ Display window (see the illustration below)
- ⑪ Disc tray (7)
- ⑫ MIC 1/2 jacks (21)
- ⑬ MIC 1/2 controls (21)
- ⑭ QUICK PLAYBACK button (9)

### Display window

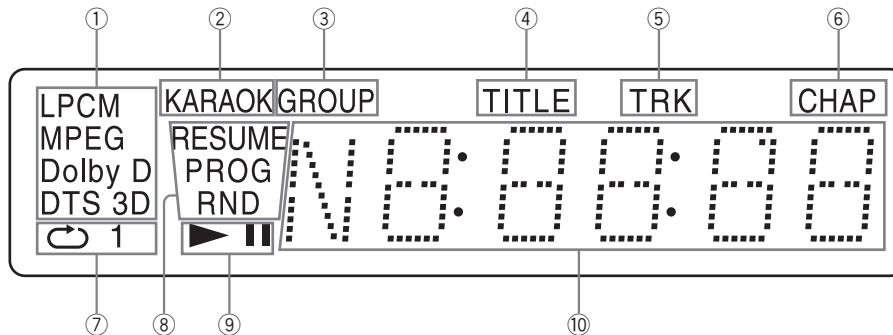

- ① Audio format indicators
- ② KARAOKE indicator
- ③ Group indicator
- ④ Title indicator
- ⑤ Track indicator
- ⑥ Chapter indicator
- ⑦ Repeat mode indicator
- ⑧ Resume/Program/Random indicators
- ⑨ ►(play) / ||(pause) indicators
- ⑩ Multi-information window

Remote control unit

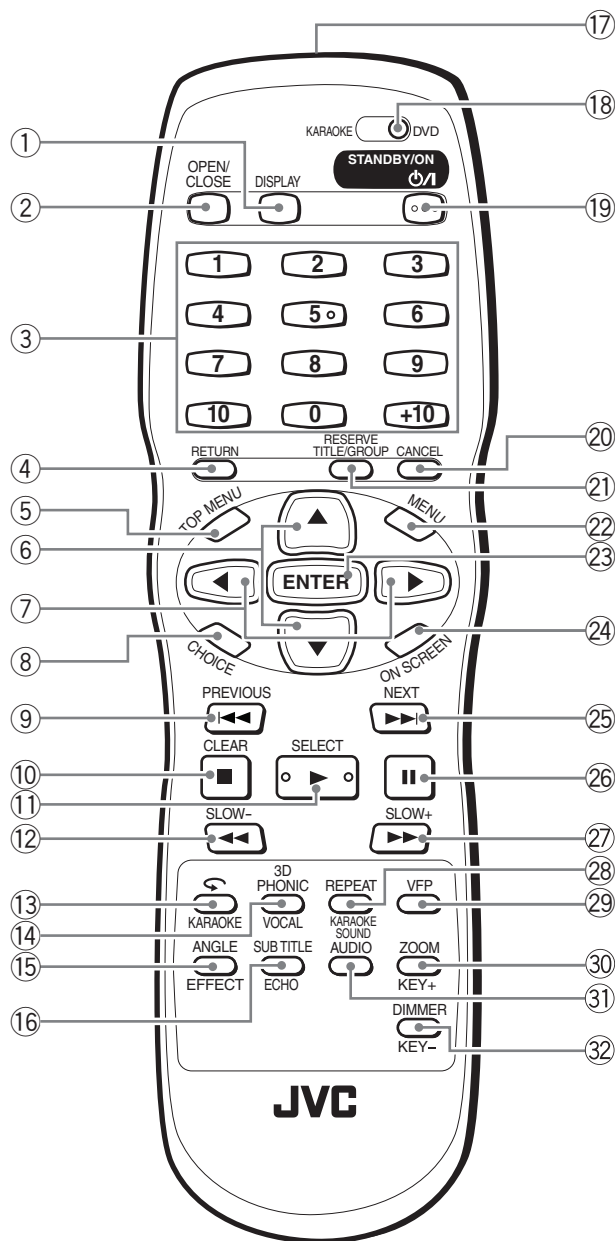

- ① DISPLAY button (8)
- ② OPEN/CLOSE button (7)
- ③ Numeric buttons
- ④ RETURN button (11)
- ⑤ TOP MENU button (11)
- ⑥ Cursor selection (▲ Up, ▼ Down) buttons
- ⑦ Cursor selection (◀ Left, ▶ Right) buttons
- ⑧ CHOICE button (26)
- ⑨ ◀◀/PREVIOUS button (9, 10, 19)
- ⑩ ■/CLEAR button (8, 13, 19)
- ⑪ ▶/SELECT button (7, 9, 19, 21)
- ⑫ ◀◀/SLOW- button (9)
- ⑬ ↻ - KARAOKE button (10, 21)
- ⑭ 3D PHONIC - VOCAL button (17, 23)
- ⑮ ANGLE - EFFECT button (15, 24)
- ⑯ SUBTITLE - ECHO button (15, 24)
- ⑰ Infrared signal window (5)
- ⑱ KARAOKE- DVD- switch (6, 11, 19, 21, 26)
- ⑲ STANDBY/ON ⏻ button (6)
- ⑳ CANCEL button (13, 21)
- ㉑ RESERVE - TITLE/GROUP button (11, 20, 21)
- ㉒ MENU button (11)
- ㉓ ENTER button
- ㉔ ON SCREEN button (8, 12, 17, 21)
- ㉕ ▶▶/NEXT button (9, 10, 19)
- ㉖ || button (8, 19)
- ㉗ ▶▶/SLOW+ button (9)
- ㉘ REPEAT - KARAOKE SOUND button (14, 20, 23)
- ㉙ VFP button (16)
- ㉚ ZOOM - KEY+ button (16, 25)
- ㉛ AUDIO button (15, 22)
- ㉜ DIMMER - KEY- button (7, 25)

## AV COMPU LINK remote control system

The JVC AV COMPU LINK system allows you to enjoy video or audio with the simplest operation. If your video/audio player (such as a DVD player, CD player and VCR) and television or/and amplifier/receiver support the JVC AV COMPU LINK system and are tied with the JVC AV COMPU LINK cable(s), simply starting the player will automatically make all necessary settings on the television and/or amplifier/receiver to allow you to enjoy the playback.

### AV COMPU LINK

#### Connection and setup

Using an AV COMPU LINK cable, connect the AV COMPU LINK terminals of each component to one another.

- The unit's AV COMPU LINK setting is controlled using the OTHERS menu in the preference display. See page 28.
- For information on the connection between a TV and a receiver, refer to the receiver's instructions.

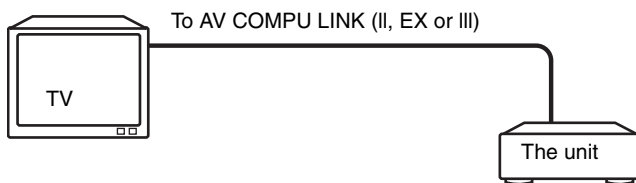

- If you connect the unit to a television via AV COMPU LINK, set the unit's AV COMPU LINK setting as follows.
  - When connecting to the VIDEO-1 input terminal of the television: DVD2
  - When connecting to the VIDEO-2 input terminal of the television: DVD3

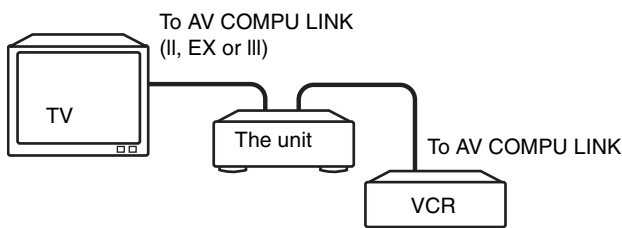

- If you connect the unit to a television and VCR via AV COMPU LINK, set the VCR's Remote Control Code and the unit's AV COMPU LINK setting as follows.
  - When connecting to the VIDEO-1 input terminal of the television:
    - The unit's AV COMPU LINK setting: DVD2
    - VCR's Remote Control Code: B
  - When connecting to the VIDEO-2 input terminal of the television:
    - The unit's AV COMPU LINK setting: DVD3
    - VCR's Remote Control Code: A

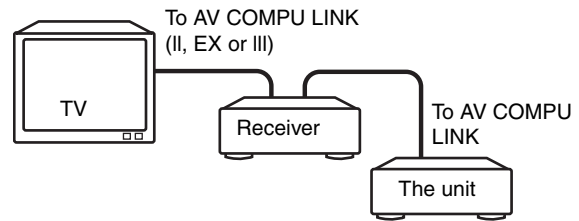

- If you connect the unit to a television and receiver via AV COMPU LINK, set the unit's AV COMPU LINK setting to DVD1.

#### IMPORTANT!

When you make video connection between the unit and another device (such as a receiver and TV) via the composite, S-video or component jacks, as well as AV COMPU LINK connection, see also the instruction manual of the other device.

#### Notes for connection

- If you connect the unit to a receiver via AV COMPU LINK in a system including a Dolby Digital decoder, some functions may not be performed automatically.
- Connect the AUDIO OUT jacks of the unit to the audio input jacks of a receiver indicating "DVD." Otherwise, the system will not work correctly.
- There may be no description about connections to the unit in the instruction manual of a television or VCR. However, a television or VCR with AV COMPU LINK terminals indicating "II," "EX" or "III" can be connected to the unit.

#### Operation

The JVC AV COMPU LINK system allows you to enjoy video and/or audio by simply pressing Play on the source component (the component which plays back the video or audio, such as a DVD player or VCR). You do not even have to switch on power on the TV or receiver.

- 1 Turn on the main power of the television.**
- 2 Insert a disc (or tape) into the source component.**
- 3 Press ► of the source component.**

The following actions are performed automatically:

- Turning on the television power.
- Setting the source of the television to the external input (VIDEO-1 or VIDEO-2).
- Turning on receiver power.
- Setting the source of the receiver to the component which has started playback.

### Troubleshooting

---

#### Power

**Power does not come on.**

- ➔ Power plug is not inserted securely. Plug in securely.

#### Operation

**“REGION CODE ERROR!” is shown on the TV screen.**

- ➔ Region code of the inserted disc does not match the unit.  
Check the region code of the disc printed on the disc jacket.

**Operation is not possible.**

- ➔ Microcomputer malfunction due to lightning or static electricity.  
Turn off the power and unplug the power cord, then connect the power cord again.
- ➔ Moisture condensation caused by a sudden change of temperature or humidity. Turn off the power, then turn it on a few hours later.
- ➔ The disc does not allow the operation, or an unplayable disc is inserted. Check and replace the disc (see page 2).

**[LOCK] is displayed on the display window and the disc tray does not open.**

- ➔ When you press ▲ while pressing down ■ on the unit in standby mode, the tray lock function is activated. The disc tray cannot be opened or closed in this status. To release this status, press ▲ while pressing down ■ on the unit in standby mode.

#### Picture

**Picture is noisy.**

- ➔ The unit is connected to a VCR directly and the copyguard function is activated. Connect the unit so that the picture signal flows directly to the TV.

**Picture is distorted when using COMPONENT VIDEO OUT or S-VIDEO output jack(s).**

- ➔ Both the component connection and S-video connection are made. Disconnect the unused one.

#### Audio

**DVD VIDEO disc playback sound level is lower than TV broadcast sound level.**

- ➔ Set the [D.RANGE CONTROL] preference to [TV MODE] (see page 28).

**Analog audio output is distorted.**

- ➔ Set the [OUTPUT LEVEL] preference to [LOW] (see page 28).

**Sound is abnormal when DTS-encoded source is played back.**

- ➔ Connect audio equipment with a built-in DTS decoder to the unit.
- ➔ Play back a source other than DTS-encoded one.

#### MP3

**No sound comes out.**

- ➔ MP3 disc is recorded with the “packet writing (UDF format).” It cannot be played.

**Files (tracks) are not played in the recorded order.**

- ➔ This unit plays the files in the alphabetic order. So, the playback order can vary.

#### KARAOKE

**The KARAOKE function cannot be turned on.**

- ➔ You cannot turn on the KARAOKE function while playing back an MP3 disc.

**The musical key cannot be shifted.**

- ➔ You cannot shift the musical key when playing back an Audio CD with DTS, or a DVD with DTS, MPEG Multichannel or 96 kHz linear PCM.

**The multichannel playback cannot be made.**

- ➔ The KARAOKE function is turned on.



## Specifications

Specifications and appearance are subject to change without prior notice.

### General

Readable discs	DVD VIDEO, DVD-R (Video format), DVD-RW (Video format), +RW (Video format), SVCD, Video CD, Audio CD (CD-DA), MP3 format, CD-R/RW (CD-DA, SVCD, Video CD, MP3 format)
Video format	NTSC/PAL

### Other

Power requirements	AC 110 V-240 V $\sim$ , 50 Hz/60 Hz
Power consumption	13 W (POWER ON), 0.9 W (STANDBY mode)
Mass	2.1 kg
Dimensions (W × H × D)	435 mm × 53 mm × 248.4 mm

### Video outputs

COMPONENT (pin jacks)	Y Output: 1.0 Vp-p (75 $\Omega$ ) P <sub>B</sub> /P <sub>R</sub> Output: 0.7 Vp-p (75 $\Omega$ )
VIDEO OUT (pin jack)	1.0 Vp-p (75 $\Omega$ )
S-VIDEO OUT (S jack)	Y Output: 1.0 Vp-p (75 $\Omega$ ) C Output: 286 mVp-p (75 $\Omega$ )
Horizontal resolution	500 lines or more

### Audio input

MIC 1/2	10mVrms (8.2 k $\Omega$ )
---------	---------------------------

### Audio outputs

ANALOG OUT (pin jack)	2.0 Vrms (10 k $\Omega$ )
DIGITAL OUT (COAXIAL)	0.5 Vp-p (75 $\Omega$ termination)
DIGITAL OUT (OPTICAL)	-21 dBm to -15 dBm (peak)

### Audio characteristics

Frequency response	CD (sampling frequency 44.1 kHz): 2 Hz to 20 kHz DVD (sampling frequency 48 kHz): 2 Hz to 22 kHz (4 Hz to 20 kHz for DTS and Dolby Digital bitstream signals) DVD (sampling frequency 96 kHz): 2 Hz to 44 kHz
Dynamic range	16 bit: More than 98 dB 20 bit: More than 100 dB 24 bit: More than 100 dB
Wow and flutter	Unmeasurable (less than + 0.002%)
Total harmonic distortion	less than 0.006%

- Manufactured under license from Dolby Laboratories. "Dolby" and the double-D symbol are trademarks of Dolby Laboratories.
- "DTS" and "DTS Digital Out" are trademarks of Digital Theater Systems, Inc.

Appendix A: Country/Area code list for Parental Lock

(for page 29)

AD	Andorra
AE	United Arab Emirates
AF	Afghanistan
AG	Antigua and Barbuda
AI	Anguilla
AL	Albania
AM	Armenia
AN	Netherlands Antilles
AO	Angola
AQ	Antarctica
AR	Argentina
AS	American Samoa
AT	Austria
AU	Australia
AW	Aruba
AZ	Azerbaijan
BA	Bosnia and Herzegovina
BB	Barbados
BD	Bangladesh
BE	Belgium
BF	Burkina Faso
BG	Bulgaria
BH	Bahrain
BI	Burundi
BJ	Benin
BM	Bermuda
BN	Brunei Darussalam
BO	Bolivia
BR	Brazil
BS	Bahamas
BT	Bhutan
BV	Bouvet Island
BW	Botswana
BY	Belarus
BZ	Belize
CA	Canada
CC	Cocos (Keeling) Islands
CF	Central African Republic
CG	Congo
CH	Switzerland
CI	Côte d'Ivoire
CK	Cook Islands
CL	Chile
CM	Cameroon
CN	China
CO	Colombia
CR	Costa Rica
CU	Cuba
CV	Cape Verde
CX	Christmas Island
CY	Cyprus
CZ	Czech Republic
DE	Germany
DJ	Djibouti
DK	Denmark
DM	Dominica
DO	Dominican Republic
DZ	Algeria
EC	Ecuador
EE	Estonia
EG	Egypt
EH	Western Sahara
ER	Eritrea

ES	Spain
ET	Ethiopia
FI	Finland
FJ	Fiji
FK	Falkland Islands
FM	Micronesia (Federated States of)
FO	Faroe Islands
FR	France
FX	France, Metropolitan
GA	Gabon
GB	United Kingdom
GD	Grenada
GE	Georgia
GF	French Guiana
GH	Ghana
GI	Gibraltar
GL	Greenland
GM	Gambia
GN	Guinea
GP	Guadeloupe
GQ	Equatorial Guinea
GR	Greece
GS	South Georgia and the South Sandwich
GT	Guatemala
GU	Guam
GW	Guinea-Bissau
GY	Guyana
HK	Hong Kong
HM	Heard Island and McDonald Islands
HN	Honduras
HR	Croatia
HT	Haiti
HU	Hungary
ID	Indonesia
IE	Ireland
IL	Israel
IN	India
IO	British Indian Ocean Territory
IQ	Iraq
IR	Iran (Islamic Republic of)
IS	Iceland
IT	Italy
JM	Jamaica
JO	Jordan
JP	Japan
KE	Kenya
KG	Kyrgyzstan
KH	Cambodia
KI	Kiribati
KM	Comoros
KN	Saint Kitts and Nevis
KP	Korea, Democratic People's Republic of
KR	Korea, Republic of
KW	Kuwait
KY	Cayman Islands
KZ	Kazakhstan
LA	Lao People's Democratic Republic
LB	Lebanon

LC	Saint Lucia
LI	Liechtenstein
LK	Sri Lanka
LR	Liberia
LS	Lesotho
LT	Lithuania
LU	Luxembourg
LV	Latvia
LY	Libyan Arab Jamahiriya
MA	Morocco
MC	Monaco
MD	Moldova, Republic of
MG	Madagascar
MH	Marshall Islands
ML	Mali
MM	Myanmar
MN	Mongolia
MO	Macau
MP	Northern Mariana Islands
MQ	Martinique
MR	Mauritania
MS	Montserrat
MT	Malta
MU	Mauritius
MV	Maldives
MW	Malawi
MX	Mexico
MY	Malaysia
MZ	Mozambique
NA	Namibia
NC	New Caledonia
NE	Niger
NF	Norfolk Island
NG	Nigeria
NI	Nicaragua
NL	Netherlands
NO	Norway
NP	Nepal
NR	Nauru
NU	Niue
NZ	New Zealand
OM	Oman
PA	Panama
PE	Peru
PF	French Polynesia
PG	Papua New Guinea
PH	Philippines
PK	Pakistan
PL	Poland
PM	Saint Pierre and Miquelon
PN	Pitcairn
PR	Puerto Rico
PT	Portugal
PW	Palau
PY	Paraguay
QA	Qatar
RE	Réunion
RO	Romania
RU	Russian Federation
RW	Rwanda
SA	Saudi Arabia
SB	Solomon Islands
SC	Seychelles

SD	Sudan
SE	Sweden
SG	Singapore
SH	Saint Helena
SI	Slovenia
SJ	Svalbard and Jan Mayen
SK	Slovakia
SL	Sierra Leone
SM	San Marino
SN	Senegal
SO	Somalia
SR	Suriname
ST	Sao Tome and Principe
SV	El Salvador
SY	Syrian Arab Republic
SZ	Swaziland
TC	Turks and Caicos Islands
TD	Chad
TF	French Southern Territories
TG	Togo
TH	Thailand
TJ	Tajikistan
TK	Tokelau
TM	Turkmenistan
TN	Tunisia
TO	Tonga
TP	East Timor
TR	Turkey
TT	Trinidad and Tobago
TV	Tuvalu
TW	Taiwan
TZ	Tanzania, United Republic of
UA	Ukraine
UG	Uganda
UM	United States Minor Outlying Islands
US	United States
UY	Uruguay
UZ	Uzbekistan
VA	Vatican City State (Holy See)
VC	Saint Vincent and the Grenadines
VE	Venezuela
VG	Virgin Islands (British)
VI	Virgin Islands (U.S.)
VN	Vietnam
VU	Vanuatu
WF	Wallis and Futuna Islands
WS	Samoa
YE	Yemen
YT	Mayotte
YU	Yugoslavia
ZA	South Africa
ZM	Zambia
ZR	Zaire
ZW	Zimbabwe

**Appendix B: Table of languages and their abbreviations**

(for pages 15 and 27)

AA	Afar	FA	Persian	KM	Cambodian	OM	(Afan) Oromo	SU	Sundanese
AB	Abkhazian	FI	Finnish	KN	Kannada	OR	Oriya	SV	Swedish
AF	Afrikaans	FJ	Fiji	KO	Korean (KOR)	PA	Panjabi	SW	Swahili
AM	Ameharic	FO	Faroese	KS	Kashmiri	PL	Polish	TA	Tamil
AR	Arabic	FY	Frisian	KU	Kurdish	PS	Pashto, Pushto	TE	Telugu
AS	Assamese	GA	Irish	KY	Kirghiz	PT	Portuguese	TG	Tajik
AY	Aymara	GD	Scots Gaelic	LA	Latin	QU	Quechua	TH	Thai
AZ	Azerbaijani	GL	Galician	LN	Lingala	RM	Rhaeto-Romance	TI	Tigrinya
BA	Bashkir	GN	Guarani	LO	Laothian	RN	Kirundi	TK	Turkmen
BE	Byelorussian	GU	Gujarati	LT	Lithuanian	RO	Rumanian	TL	Tagalog
BG	Bulgarian	HA	Hausa	LV	Latvian, Lettish	RU	Russian	TN	Setswana
BH	Bihari	HI	Hindi	MG	Malagasy	RW	Kinyarwanda	TO	Tongan
BI	Bislama	HR	Croatian	MI	Maori	SA	Sanskrit	TR	Turkish
BN	Bengali, Bangla	HU	Hungarian	MK	Macedonian	SD	Sindhi	TS	Tsonga
BO	Tibetan	HY	Armenian	ML	Malayalam	SG	Sangho	TT	Tatar
BR	Breton	IA	Interlingua	MN	Mongolian	SH	Serbo-Croatian	TW	Twi
CA	Catalan	IE	Interlingue	MO	Moldavian	SI	Singhalese	UK	Ukrainian
CO	Corsican	IK	Inupiak	MR	Marathi	SK	Slovak	UR	Urdu
CS	Czech	IN	Indonesian	MS	Malay (MAY)	SL	Slovenian	UZ	Uzbek
CY	Welsh	IS	Icelandic	MT	Maltese	SM	Samoan	VI	Vietnamese
DA	Danish	IW	Hebrew	MY	Burmese	SN	Shona	VO	Volapuk
DZ	Bhutani	JI	Yiddish	NA	Nauru	SO	Somali	WO	Wolof
EL	Greek	JW	Javanese	NE	Nepali	SQ	Albanian	XH	Xhosa
EO	Esperanto	KA	Georgian	NL	Dutch	SR	Serbian	YO	Yoruba
ET	Estonian	KK	Kazakh	NO	Norwegian	SS	Siswati	ZU	Zulu
EU	Basque	KL	Greenlandic	OC	Occitan	ST	Sesotho		

**Appendix C: Digital output signal chart**

(for page 28)

Disc type	Output		
	PCM ONLY	DOLBY DIGITAL/PCM	STREAM/PCM
DVD with 48 kHz, 16/20/24 bit linear PCM	48 kHz, 16 bit, stereo linear PCM		
DVD with 96 kHz, 16/22/24 bit linear PCM	48 kHz, 16 bit, stereo linear PCM (Down sampling)		
DVD with DTS	No output		DTS bitstream
DVD with Dolby Digital	48 kHz, 16 bit, stereo linear PCM	Dolby Digital bitstream	
DVD with MPEG Multichannel	48 kHz, 16 bit, stereo linear PCM		MPEG bitstream
SVCD/Video CD/Audio CD	44.1 kHz, 16 bit, stereo linear PCM		
Audio CD with DTS	No output		DTS bitstream
CD-R/RW with MP3	No output		
Any disc with KARAOKE mode	48/44.1 kHz, 16 bit, stereo linear PCM		

## Appendix D: Glossary

### Aspect ratio

A ratio which defines the shape of the rectangular picture in a TV. It is the width of the picture relative to the height. A conventional TV picture is 4:3 in aspect ratio.

### Bitstream

The digital form of multichannel audio data (e.g., 5.1-channel) before it is decoded into its various channels.

### Chapter/title

Chapter is the smallest division and title is the largest division on DVD VIDEO. A chapter is a division of a title and similar to a track for Video CD or Audio CD.

### Component video

Video signals with three channels of separate information that makes up the picture. There are some types of component video, such as R/G/B and Y/C<sub>B</sub>(P<sub>B</sub>)/C<sub>R</sub>(P<sub>R</sub>).

### Composite video

A single video signal commonly used in most consumer video products that contains all luminance, color, and synchronization information.

### Dolby Digital (AC3)

A six-channel system consisting of left, center, right, left rear, right rear and LFE (Low-Frequency Effect channel, for use with a sub-woofer) channels. All processing is done in the digital domain. Not all Dolby Digital discs contain six (5.1) channels of information.

### Dolby Surround/Dolby Pro Logic

Dolby Surround records four channels of front and rear audio in two channels in a way that allows a decoder to recover the original four channels for playback. Because the audio is recorded in two channels, it can be played back naturally by a two-channel stereo system.

Dolby Pro Logic introduces directional circuits in decoder-side processing (increasing the level of specific channels and lowering the level of silent channels) for greater spatial perspective, and adds a center speaker used primarily for dialog. The result is enhanced channel separation.

### Down-mix

Internal stereo mix of multichannel surround audio by a DVD player. The down-mix signals are output from analog AUDIO OUT connectors.

### DTS

A Digital Surround audio encoding format configured with six (5.1) channels, similar to Dolby Digital. It requires a decoder, either in the player or in an external receiver. DTS stands for Digital Theater Systems.

Not all DTS discs contain six (5.1) channels of information.

### Dynamic range

The difference between the loudest and softest sounds.

### Linear PCM audio

PCM stands for "pulse code modulation." Linear PCM is the usual method for digitally encoding audio without compression, and is used for the audio tracks on DVD VIDEO discs, Audio CDs, etc.

### MP3

MP3 is an audio data compression format, which stands for MPEG-1 Audio Layer 3. Using MP3, you can achieve a data reduction of about 1:10.

### MPEG

A family of Standards for compressing audio-visual information. "MPEG" standards include MPEG-1, MPEG-2 and MPEG-4. Video CD and MP3 are based on MPEG-1, while DVD is based on MPEG-2. MPEG stands for Moving Picture coding Experts Group.

### MPEG Multichannel

This feature expands the 5.1 channel audio format recorded on the disc to a 7.1 channel format. The further expansion of the 5.1 channel audio makes it easy for you to reproduce the movie theater experience in your own home.

### NTSC (National television system committee)

A black and white and color television system format used in the U.S.A., Canada, Mexico and Japan.

### PAL (Phase Alternation by Line)

A color television system format used extensively in Western Europe.

### PBC

PBC stands for "Playback control" and is a method of controlling disc play for Video CDs (VCD). You are able to interact with the disc through menus.

### S-video

A video signal which improves picture quality over standard composite connections. Used on Super VHS, DVD, high end TV monitors, etc.

### Track

The smallest division on SVCD, Video CD and Audio CD discs.



**JVC**  
VICTOR COMPANY OF JAPAN, LIMITED

## Free Manuals Download Website

<http://myh66.com>

<http://usermanuals.us>

<http://www.somanuals.com>

<http://www.4manuals.cc>

<http://www.manual-lib.com>

<http://www.404manual.com>

<http://www.luxmanual.com>

<http://aubethermostatmanual.com>

Golf course search by state

<http://golfingnear.com>

Email search by domain

<http://emailbydomain.com>

Auto manuals search

<http://auto.somanuals.com>

TV manuals search

<http://tv.somanuals.com>