

# JVC

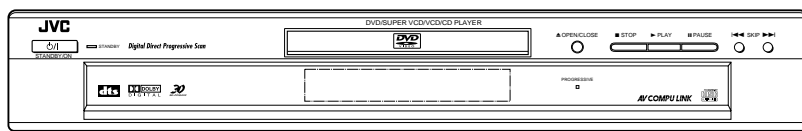

## DVD PLAYER

# XV-S500BK/XV-S502SL



Introduction	2
Getting started	6
Basic operations	12
Advanced operations	22
MP3 disc playback	39
JPEG disc playback	42
Changing the initial settings	47
Additional information	56

## INSTRUCTIONS

### For Customer Use:

Enter below the Model No. and Serial No. which are located on the rear, bottom or side of the cabinet. Retain this information for future reference.

Model No. \_\_\_\_\_

Serial No \_\_\_\_\_

LET0200-002B  
[J/UJ]

# Warnings, Cautions and Others

## Mises en garde, précautions et indications diverses



The lightning flash with arrowhead symbol, within an equilateral triangle is intended to alert the user to the presence of uninsulated "dangerous voltage" within the product's enclosure that may be of sufficient magnitude to constitute a risk of electric shock to persons.



The exclamation point within an equilateral triangle is intended to alert the user to the presence of important operating and maintenance (servicing) instructions in the literature accompanying the appliance.

### For U.S.A.

This equipment has been tested and found to comply with the limits for a Class B digital device, pursuant to part 15 of the FCC Rules. These limits are designed to provide reasonable protection against harmful interference in a residential installation.

This equipment generates, uses and can radiate radio frequency energy and, if not installed and used in accordance with the instructions, may cause harmful interference to radio communications. However, there is no guarantee that interference will not occur in a particular installation. If this equipment does cause harmful interference to radio or television reception, which can be determined by turning the equipment off and on, the user is encouraged to try to correct the interference by one or more of the following measures:

Reorient or relocate the receiving antenna.

Increase the separation between the equipment and receiver.

Connect the equipment into an outlet on a circuit different from that to which the receiver is connected.

Consult the dealer or an experienced radio/TV technician for help.

**WARNING: TO REDUCE THE RISK OF FIRE OR ELECTRIC SHOCK, DO NOT EXPOSE THIS APPLIANCE TO RAIN OR MOISTURE.**

### For Canada/pour le Canada

**CAUTION:** TO PREVENT ELECTRIC SHOCK, MATCH WIDE BLADE OF PLUG TO WIDE SLOT, FULLY INSERT

**ATTENTION:** POUR EVITER LES CHOCS ELECTRIQUES, INTRODUIRE LA LAME LA PLUS LARGE DE LA FICHE DANS LA BORNE CORRESPONDANTE DE LA PRISE ET POUSSER JUSQU'AU FOND

### For Canada/pour le Canada

THIS DIGITAL APPARATUS DOES NOT EXCEED THE CLASS B LIMITS FOR RADIO NOISE EMISSIONS FROM DIGITAL APPARATUS AS SET OUT IN THE INTERFERENCE-CAUSING EQUIPMENT STANDARD ENTITLED "DIGITAL APPARATUS", ICES-003 OF THE DEPARTMENT OF COMMUNICATIONS.

CET APPAREIL NUMERIQUE RESPECTE LES LIMITES DE BRUITS RADIOELECTRIQUES APPLICABLES AUX APPAREILS NUMERIQUES DE CLASSE B PRESCRITES DANS LA NORME SUR LE MATERIEL BROUILLEUR: "APPAREILS NUMERIQUES", NMB-003 EDICTEE PAR LE MINISTRE DES COMMUNICATIONS.

### CAUTION

To reduce the risk of electrical shocks, fire, etc.:

1. Do not remove screws, covers or cabinet.
2. Do not expose this appliance to rain or moisture.

### ATTENTION

Afin d'éviter tout risque d'électrocution, d'incendie, etc.:

1. Ne pas enlever les vis ni les panneaux et ne pas ouvrir le coffret de l'appareil.
2. Ne pas exposer l'appareil à la pluie ni à l'humidité.

### Caution — STANDBY/ON switch!

Disconnect the mains plug to shut the power off completely. The STANDBY/ON  switch in any position does not disconnect the mains line. The power can be remote controlled.

### Attention — Commutateur STANDBY/ON !

Déconnecter la fiche de secteur pour couper complètement le courant.

Le commutateur STANDBY/ON  ne coupe jamais complètement la ligne de secteur, quelle que soit sa position. Le courant peut être télécommandé.

### IMPORTANT FOR LASER PRODUCTS IMPORTANT POUR LES PRODUITS LASER

1. CLASS 1 LASER PRODUCT
2. **DANGER:** Visible laser radiation when open and interlock failed or defeated. Avoid direct exposure to beam.
3. **CAUTION:** Do not open the top cover. There are no user service-able parts inside the Unit; leave all servicing to qualified service personnel.
1. PRODUIT LASER CLASSE 1
2. **ATTENTION:** Radiation laser visible quand l'appareil est ouvert ou que le verrouillage est en panne ou désactivé. Eviter une exposition directe au rayon.
3. **ATTENTION:** Ne pas ouvrir le couvercle du dessus. Il n'y a aucune pièce utilisable à l'intérieur. Laisser à un personnel qualifié le soin de réparer votre appareil.

### CAUTION

- Do not block the ventilation openings or holes. (If the ventilation openings or holes are blocked by a newspaper or cloth, etc., the heat may not be able to get out.)
- Do not place any naked flame sources, such as lighted candles, on the apparatus.
- When discarding batteries, environmental problems must be considered and local rules or laws governing the disposal of these batteries must be followed strictly.
- Do not expose this apparatus to rain, moisture, dripping or splashing and that no objects filled with liquids, such as vases, shall be placed on the apparatus.

### ATTENTION

- Ne bloquez pas les orifices ou les trous de ventilation. (Si les orifices ou les trous de ventilation sont bloqués par un journal un tissu, etc., la chaleur peut ne pas être évacuée correctement de l'appareil.)
- Ne placez aucune source de flamme nue, telle qu'une bougie, sur l'appareil.
- Lors de la mise au rebut des piles, veuillez prendre en considération les problèmes de l'environnement et suivre strictement les règles et les lois locales sur la mise au rebut des piles.
- N'exposez pas cet appareil à la pluie, à l'humidité, à un égouttement ou à des éclaboussures et ne placez pas des objets remplis de liquide, tels qu'un vase, sur l'appareil.

# Table of Contents

<b>Introduction</b>	Page 2
<b>Supplied accessories</b> .....	2
<b>Notes on handling</b> .....	3
Important cautions.....	3
Safety precautions.....	3
<b>About discs</b> .....	4
Playable disc types.....	4
Non-playable discs.....	4
Audio formats.....	4
Disc structure.....	5
Video CDs and SVCDs with Playback Control function.....	5
Care and handling of discs.....	5
<b>Getting started</b>	Page 6
<b>Connections</b> .....	6
Before making any connections.....	6
To connect to a TV.....	6
To connect to a stereo audio amplifier/receiver.....	8
To connect to digital audio device.....	9
To connect the power cord.....	9
<b>Using the remote control unit</b> .....	10
To install batteries in the remote control unit.....	10
Remote sensor.....	10
To use the remote control unit for TV operation.....	11
To control the volume of a JVC's amplifier or receiver.....	11
<b>Basic operations</b>	Page 12
<b>Before operation</b> .....	12
Turning on/off the unit.....	12
The initial setup before using the unit.....	13
<b>Basic playback</b> .....	14
Inserting and removing discs.....	14
To start playback.....	15
To stop playback completely.....	15
To stop playback temporarily.....	15
<b>Resuming playback</b> .....	16
To memorize the interrupted position.....	16
To resume playback.....	17
<b>Variable speed playback</b> .....	18
To advance or reverse playback rapidly while monitoring.....	18
To advance a still picture frame-by-frame.....	18
To playback in slow-motion.....	18
<b>To locate the beginning of the scene or song</b> .....	19
To locate a desired selection using I◀◀ or ▶▶.....	19
To locate a desired selection using the numeric buttons....	19
<b>Other convenient functions</b> .....	20
To check the playback status.....	20
To move back the playback position while DVD VIDEO playback [One touch replay function].....	21
To change the brightness of the display window.....	21
<b>Advanced operations</b>	Page 22
<b>Playing from a specific position on a disc</b> .....	22
To locate a desired scene from the DVD menu.....	22
To locate a desired scene from the menu of the Video CD/SVCD with PBC.....	22
To specify a desired title.....	23
To locate a desired position in the current title or track [Time search].....	23
To locate a desired scene from the display [DIGEST].....	24
<b>Changing the playback order</b> .....	25
To playback in the desired order [Program playback].....	25
To playback in random order [Random playback].....	26
<b>Repeat playback</b> .....	27

To repeat the current selection or all tracks [Repeat playback].....	27
To repeat a desired part [A-B repeat playback].....	28
<b>Changing the language, sound and scene angle</b> .....	29
To select the subtitle language [SUBTITLE].....	29
To change the audio language or sound [AUDIO].....	30
To select a scene angle of DVD VIDEO [ANGLE].....	31
<b>Special picture playback and picture/sound effect</b> .....	32
To display continuous still pictures [STROBE].....	32
To zoom in/out pictures [ZOOM].....	32
To adjust the picture character [VFP].....	33
To simulate surround sound [3D PHONIC].....	34
<b>Menu bar functions</b> .....	35
To bring up the menu bar.....	35
Basic operation procedure.....	35
Menu bar functions for DVD VIDEO.....	36
Menu bar functions for Audio CD/Video CD/SVCD.....	37

<b>MP3 disc playback</b>	Page 39
<b>About MP3 disc</b> .....	39
<b>Operations</b> .....	39
Basic operations.....	39
Selecting the desired Group and Track.....	40
Direct selection.....	41
Repeat playback.....	41

<b>JPEG disc playback</b>	Page 42
<b>About JPEG disc</b> .....	42
<b>Basic operations</b> .....	43
To see a desired picture.....	43
To zoom in/out the picture [ZOOM].....	44
<b>To see pictures continuously [slide-show mode]</b> .....	44
Playback pictures from the beginning of the disc.....	44
Selecting the start point of the slide show.....	45
Repeat function.....	46

<b>Changing the initial settings</b>	Page 47
<b>Selecting preferences</b> .....	47
About the Preference display.....	47
How to set preferences.....	47
LANGUAGE page.....	48
PICTURE page.....	49
AUDIO page.....	50
OTHERS page.....	52
<b>Limiting playback by children</b> .....	53
To set Parental Lock for the first time [PARENTAL LOCK].....	53
To change the settings [PARENTAL LOCK].....	54
To temporarily release the Parental Lock [PARENTAL LOCK].....	55

<b>Additional information</b>	Page 56
<b>Names of parts and controls</b> .....	56
Front panel.....	56
Display window.....	56
Rear panel.....	56
Remote control unit.....	57
<b>AV COMPU LINK remote control system</b> .....	58
Connection and setup.....	58
Operation.....	58
<b>Troubleshooting</b> .....	59
<b>Frequently Asked Questions</b> .....	61
<b>Specifications</b> .....	62
<b>Appendix A: Country code list for Parental Lock</b> .....	63
<b>Appendix B: Glossary</b> .....	64
<b>Appendix C: Index</b> .....	66

## Supplied accessories

- Audio/video cable (Yellow/White/Red) (x 1)

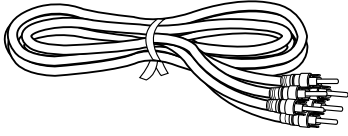

- R6P(SUM-3)/AA(15F) battery (x 2)

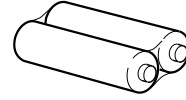

- Component video cable (Red/Green/Blue) (x 1)

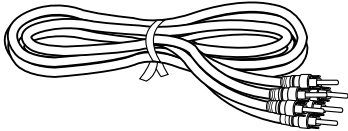

- Instruction manual (x 1)

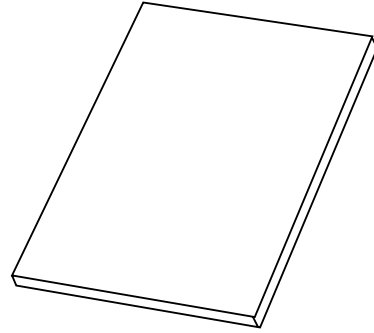

- Remote Control Unit (x 1)

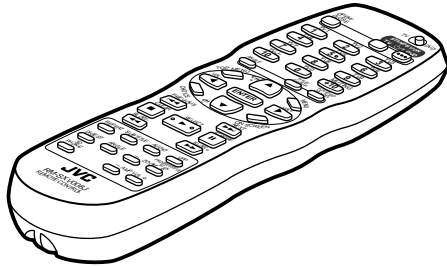

- AC power cord (x 1)

- AC power plug adaptor (x 1)  
(for PX model only)

# Notes on handling

## Important cautions

### Installation of the unit

- Select a place which is level, dry and neither too hot nor too cold (between 5°C and 35°C, 41°F and 95°F).
- Leave sufficient distance between the unit and the TV.
- Do not use the unit in a place subject to vibrations.

### Power cord

- Do not handle the power cord with wet hands!
- A small amount of power (1.3 W, for PX model:2.5W) is always consumed while the power cord is connected to the wall outlet.
- When unplugging the unit from the wall outlet, always pull the plug, not the power cord.

### To prevent malfunction of the unit

- There are no user-serviceable parts inside. If anything goes wrong, unplug the power cord and consult your dealer.
- Do not insert any metallic object into the unit.
- Do not use any non-standard shape disc available on the market, because it may damage the unit.
- Do not use a disc with tape, seals, or paste on it, because damage to the unit may result.

### Note about copyright laws

- Please check the copyright laws in your country before recording from DVD VIDEO, Audio CD, Video CD, SVCD, MP3 and JPEG discs. Recording of copyrighted material may infringe copyright laws.

### Note about the copyguard system

- The DVD VIDEO disc is protected by the copyguard system. When you connect the unit to your VCR (or integrated TV/Video system), the copyguard system activates and the picture may not be played back correctly.

## Safety precautions

### Avoid moisture, water and dust

Do not place the unit in moist or dusty places.

### Avoid high temperatures

Do not expose the unit to direct sunlight or place it near a heating device.

### When you are away

When away on travel or otherwise for an extended period of time, remove the plug from the wall outlet.

### Do not insert foreign objects into the unit

Do not insert wires, hairpins, coins, etc. into the unit.

### Do not block the vents

Blocking the vents may damage the unit.

### Care of the cabinet

When cleaning the unit, use a soft cloth and follow the relevant instructions on the use of chemically-coated cloths. Do not use benzene, thinner or other organic solvents and disinfectants. These may cause deformation or discoloring.

### If water gets inside the unit

Turn off the power switch and remove the plug from the wall outlet, then call the store where you made your purchase. Using the unit in this state may cause a fire or electrical shock.

This product incorporates copyright protection technology that is protected by method claims of certain U.S. patents and other intellectual property rights owned by Macrovision Corporation and other rights owners. Use of this copyright protection technology must be authorized by Macrovision Corporation, and is intended for home and other limited viewing uses only unless otherwise authorized by Macrovision Corporation. Reverse engineering or disassembly is prohibited.

Manufactured under license from Dolby Laboratories. "Dolby" and the double-D symbol are trademarks of Dolby Laboratories.

Confidential unpublished works.



Copyright 1992-1997 Dolby Laboratories. All rights reserved.

Manufactured under license from Digital Theater Systems, Inc. US Pat. No. 5,451,942 and other world-wide patents issued and pending. "DTS", "DTS Digital Surround", are trademarks of Digital Theater Systems, Inc. Copyright 1996 Digital Theater Systems, Inc. All Rights Reserved.

## About discs

### Playable disc types

Playable and non-playable disc types are as follows:

<b>DVD VIDEO</b> 	<b>SVCD</b> 	<b>Video CD</b> 	<b>Audio CD</b> 
---	--	--	--

The DVD Logo is a trademark.

- CD-R and CD-RW discs recorded with the Audio CD, Video CD, SVCD, MP3 or JPEG format can be played back, though some may not be played back because of the disc characteristics or recording condition. Note that unfinalized discs cannot be played back.
- DVD-R discs recorded with the DVD VIDEO format can be played back, though some may not be played back because of the disc characteristics or recording condition. Note that unfinalized disc cannot be played back.
- DVD VIDEO players and DVD VIDEO discs have their own Region Code numbers. This unit can play back only DVD VIDEO discs whose Region Code numbers include "1".

Examples of playable DVD VIDEO discs:



This unit accommodates the NTSC system, also can play back discs recorded with PAL system whose Region Code numbers include "1".

Note that the PAL video signal on disc is converted to an NTSC signal and output.

### Non-playable discs

DVD-ROM, DVD-RAM, DVD-RW, DVD+RW, DVD-AUDIO, CD-ROM, PHOTO CD, CD-EXTRA, CD-G, CD-TEXT, SACD, MIX-MODE CD

- Playing back discs listed as "Non-playable discs" above may generate noise and damage speakers.
- This unit can play back audio signals recorded in CD-G, CD-EXTRA, CD-TEXT and MIX-MODE CD discs.

### Audio formats

There are some audio formats recorded on discs as shown below.

- **Linear PCM**  
Uncompressed digital audio, the same format used on CDs and most studio masters. DVD VIDEO supports 2 channels at sampling rates of 48/96 kHz and quantization of 16/20/24 bits. Audio CD/Video CD is limited to 2 channels, 44.1 kHz at 16 bits.
- **Dolby Digital**  
A surround audio format configured with six channels. Because the "LFE (Low-Frequency Effect for sub-woofer, etc.)" channel, one of the six channels, is an auxiliary channel, this format is called "5.1-channel system". Not all Dolby Digital discs contain six (5.1) channel information.
- **DTS (Digital Theater Systems)**  
A surround audio format configured with six (5.1) channels which is same as Dolby Digital. Because the compression ratio is lower than Dolby Digital, it provides wider dynamic range and better separation. Not all DTS discs contain six (5.1) channel information.

The associated indicator lights up in the display window when playing back a disc.

Indicator	Audio format
LPCM	Linear PCM
DOLBY DIGITAL	Dolby Digital
DTS	DTS (Digital Theater Systems)

Note that, with some formats and/or depending on the unit's "DIGITAL AUDIO OUTPUT" setting, digital audio signals are not always output from the unit's DIGITAL OUT jacks as are recorded on the disc. See "DIGITAL AUDIO OUTPUT" on page 50 for details.

## Disc structure

### (For DVD VIDEO)

A DVD VIDEO disc is comprised of "titles" and each title may be divided into some "chapters". For example, if a DVD VIDEO disc contains some movies, each movie may have its own title number, and each movie may be divided into some chapters. In a DVD VIDEO KARAOKE disc, each song usually has its own title number and does not have chapters.

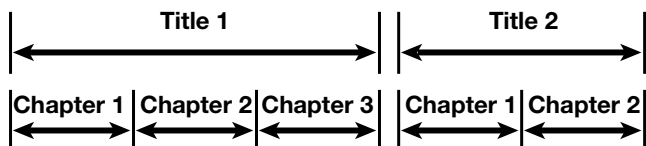

### (For Audio CD/Video CD/SVCD)

An Audio CD, Video CD or SVCD is simply comprised of "tracks."

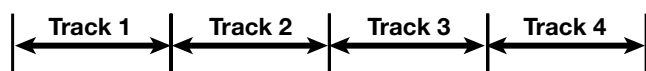

## Video CDs and SVCDs with Playback Control function

### What is Playback Control function?

The Playback Control function, allows you to enjoy menu-driven operation and high-resolution still images which have a resolution four times greater than moving pictures.

- **High-resolution still image display**

You can display high-quality images four times clearer than moving pictures.

- **Menu-driven playback**

A selection menu is displayed when you start playing a Video CD and SVCD disc with the Playback Control feature. The selection menu shows a list of numbers for selection. Some discs may show moving pictures or a divided screen. You can interact with the screen using a menu display to select and play an entry.

See example illustration below about basic feature of menu-driven playback (for details about PBC, see also page 22).

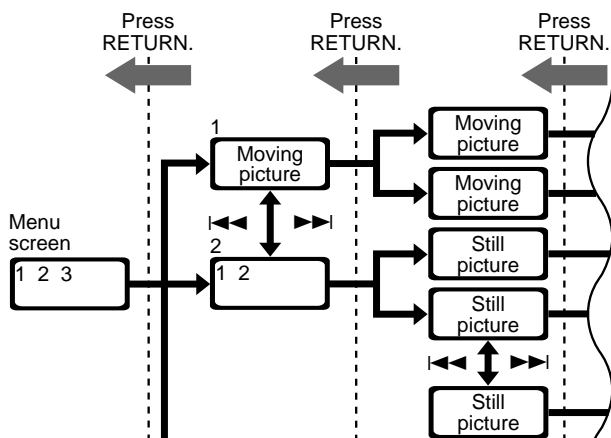

## Care and handling of discs

English

### How to handle discs

When handling a disc, do not touch the surface of the disc. Since discs are made of plastic, they are easily damaged. If a disc gets dirty, dusty, scratched or warped, the images and sound will not be picked up correctly, and such a disc may cause the player to malfunction.

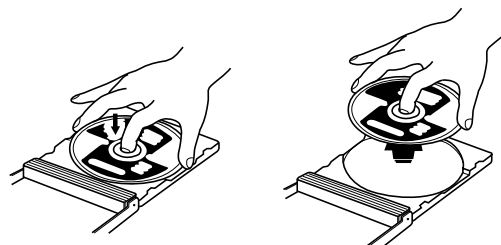

### Label side

Do not damage the label side, stick paper to or use any adhesive on its surface.

### Storage

Make sure that discs are kept in their cases. If discs are piled on top of one another without their protective cases, they can be damaged. Do not put discs in a location where they may be exposed to direct sunlight, or in a place where the humidity or temperature is high. Avoid leaving discs in your car!

### Maintenance of discs

If there are fingerprints or other dirt adhering to a disc, wipe with a soft dry cloth, moving from the center outwards.

If a disc is difficult to clean, wipe with a cloth moistened with water. Never use record cleaners, petrol, alcohol or any anti-static agents.

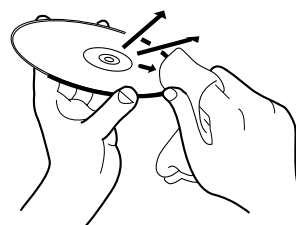

### CAUTION

Sometimes during play images may be garbled or noisy. This is sometimes due to the disc.

## Connections

\*Before using the unit, you have to connect the unit to a TV and/or amplifier.

### Before making any connections

- Do not connect the AC power cord until all other connections have been made.
- Connect VIDEO OUT of the unit directly to the video input of your TV. Connecting VIDEO OUT of the unit to a TV via a VCR may cause a monitor problem when playing back a copy-protected disc. You may also have a monitor problem when connecting the unit to an integrated TV/Video system.

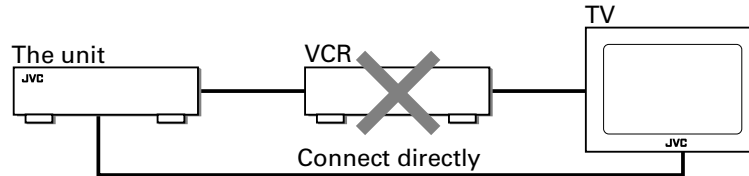

### NOTES

- In the following description, "TV" may be substituted with "monitor" or "projector."
- Terminal names used for other components may be different from those used in the following description.

### To connect to a TV

#### Connection to a conventional TV

You can enjoy playback by simply connecting the unit to a TV.

Connect the unit to a TV equipped with stereo audio input and video input jacks using the supplied audio/video cables.

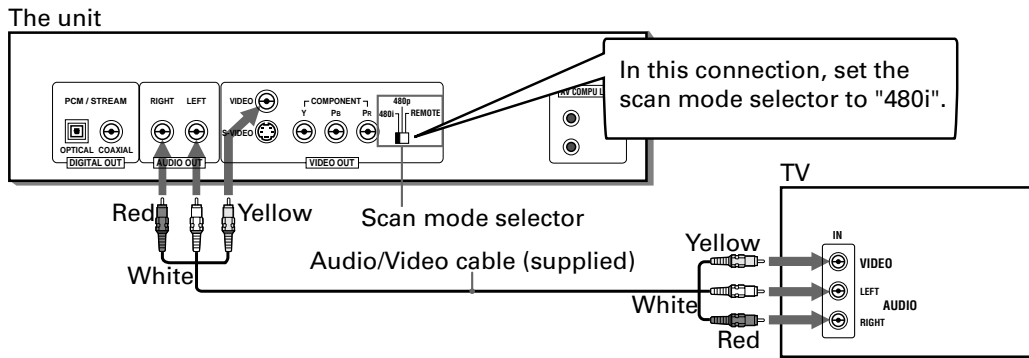

#### Connection to a TV equipped with an S-video jack

If your TV has an S-video input, you can get better picture quality by connecting it with the S-VIDEO output of the unit using the S-video cable instead of connecting the video input of the TV to the VIDEO jack of the unit.

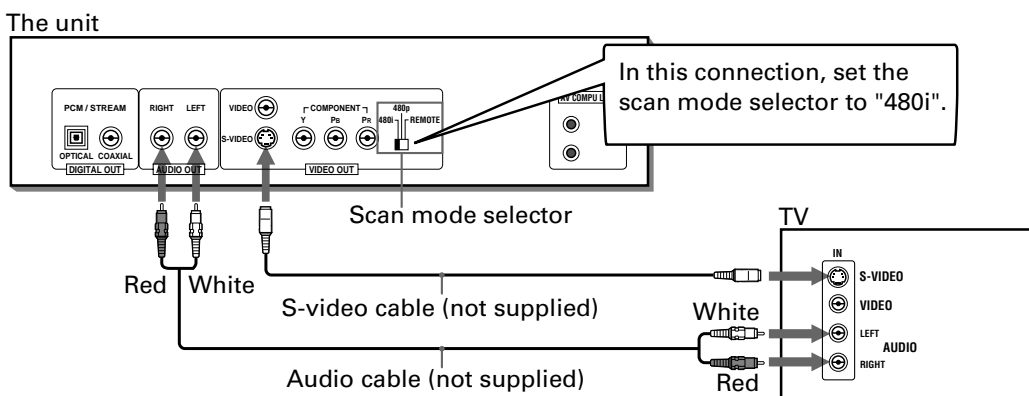



## Connection to a TV equipped with component jacks

You can enjoy high picture quality by connecting the unit's COMPONENT VIDEO OUT jacks to the COMPONENT VIDEO IN jacks of your TV with the video cables.

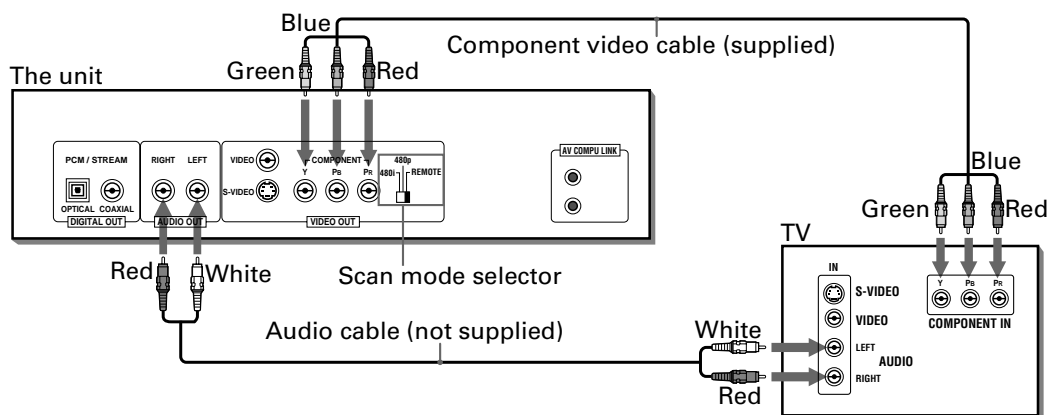

- Connect "Y" to "Y", "P<sub>B</sub>" to "P<sub>B</sub>"(C<sub>B</sub>), "P<sub>R</sub>" to "P<sub>R</sub>"(C<sub>R</sub>) correctly.

The unit supports the Progressive scan system(480p) as well as the conventional Interlace scan system(480i).

If your television or monitor equipped with component jacks supports the progressive video input, you can enjoy a high quality picture by making the Progressive scan mode active.

- **If your television equipped with component jacks does not support the progressive scan mode**

Set the Scan mode selector to "480i".

- **If your television equipped with component jacks supports the progressive scan mode**

Set the Scan mode selector to "480p".

- **If you want to select the scan mode between the interlace and progressive modes (depending on the source condition, or when connecting more than one television etc.)**

You can select the mode from the remote control unit. To do this, set the scan mode selector to "REMOTE".

(See "To make the Progressive scan mode selection active from the remote control unit" on page 8 for details about how to select the scan mode from the remote control unit when the scan mode selector is set to "REMOTE".)

### NOTES

- When the scan mode is set to the progressive mode, the PROGRESSIVE indicator on the front panel is lit. The color of the indicator differs depending on the "PROGRESSIVE MODE" setting on the "PICTURE" preference display and the status of the unit (see pages 8 and 49.)
- When connecting to a TV using the VIDEO or S-VIDEO jack, make sure that the PROGRESSIVE indicator on the front panel is not lit. If it is lit, the VIDEO and S-VIDEO outputs do not feed the correct signals. To turn off the PROGRESSIVE indicator, set the scan mode selector on the rear panel to "480i". Or, while setting the scan mode selector to "REMOTE", make the Progressive scan mode inactive by following the procedure described on page 8.
- When the component video input jacks of the TV is of the BNC type, use an adapter to convert a pin jack to a BNC jack (optional).
- Make "ANALOG DOWN MIX" in the "AUDIO" preferences to "STEREO" (see page 51).
- If your TV has a monaural audio input instead of stereo, you need to use an optional audio cable which converts stereo audio output to monaural.
- To improve audio sound quality, connect the AUDIO OUT jacks to your separate audio equipment. (See the following pages.)
- If your TV has an AV COMPU LINK terminal, you can use the AV COMPU LINK function. See "AV COMPU LINK remote control system" on page 58 for details.

### About SCAN MODE

To display video on the television (monitor) screen, the conventional scanning method is called "Interlaced scan". With this method, only half of the horizontal lines are displayed at a time. So two fields complete a single picture (frame); i.e., the first field, containing all the odd-numbered lines, is displayed followed by the second field, containing all the even-numbered lines.

On the other hand, the Progressive scan system scans all horizontal lines at a time, so you can double the number of pictures compared with the interlaced scan, resulting flicker-free, high-density picture.

Depending on the material source format, DVD VIDEO discs can be classified into two types; film source and video source (note that some DVD VIDEO discs contain both film source and video source). Film sources are recorded as 24-frame-per-second information, while (NTSC) video sources are recorded as 30-frame-per-second (60-field-per-second interlaced) information.

When the unit plays back a film source material, uninterlaced progressive output signals are created using the original information. When a video source material is played back, the unit interleaves lines between the interlaced lines on each to create the interpolated picture and outputs as the progressive signal.

## To make the Progressive scan mode selection active from the remote control unit

The unit supports the Progressive scan system as well as the conventional Interlace scan system. If your television or monitor supports the progressive video input, you can enjoy a high quality picture by making the Progressive scan mode active.

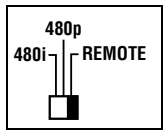

If you want to select the scan mode between the interlace and progressive modes depending on the source condition or when connecting more than one television, you can select the mode from the remote control unit. To do this, set the scan mode selector on the rear panel to "REMOTE" (See page 7).

- When the unit is turned on, and the scan mode selector on the rear panel is set to "REMOTE"

Press and hold down the VFP - PROGRESSIVE SCAN button for a few seconds.

The scan mode switches between the Progressive scan and Interlace scan modes.

- When the scan mode is set to the progressive mode, the PROGRESSIVE indicator on the front panel is lit. Depending on the "PROGRESSIVE MODE" setting on the "PICTURE" preference display and whether the current DVD VIDEO disc is film-source or video-source, the color of the indicator differs, as shown in the table below. (See also pages 7 and 49.)

Setting of PROGRESSIVE MODE	Source type of DVD VIDEO		Note
	Film Source	Video Source	
VIDEO	Red	Red	While stopped in the Progressive scan mode, the PROGRESSIVE indicator is lit in red regardless of the "PROGRESSIVE MODE" selection.
FILM	Green	Green	
AUTO	Green	Red	

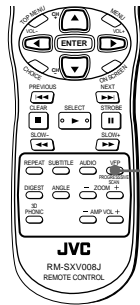

VFP - PROGRESSIVE SCAN

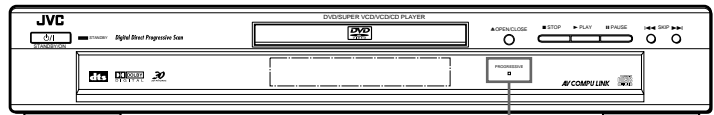

PROGRESSIVE indicator

### NOTES

- There are some progressive TV and High-Definition TV sets that are not fully compatible with the unit, resulting in the unnatural picture when playing back a DVD VIDEO disc in the progressive scan mode. In such a case, use the interlace scan mode. To check the compatibility of your TV set, contact your local JVC customer service center.
- All JVC progressive TV and High-Definition TV sets are fully compatible with the unit (Example : AV-61S902).

## To connect to a stereo audio amplifier/receiver

You can enjoy high-quality audio by connecting the unit's audio output to your amplifier or receiver.

Connect the unit's AUDIO OUT (LEFT/RIGHT) jacks to any line-level inputs (such as AUX, DVD, CD, etc.) of an audio amplifier or receiver.

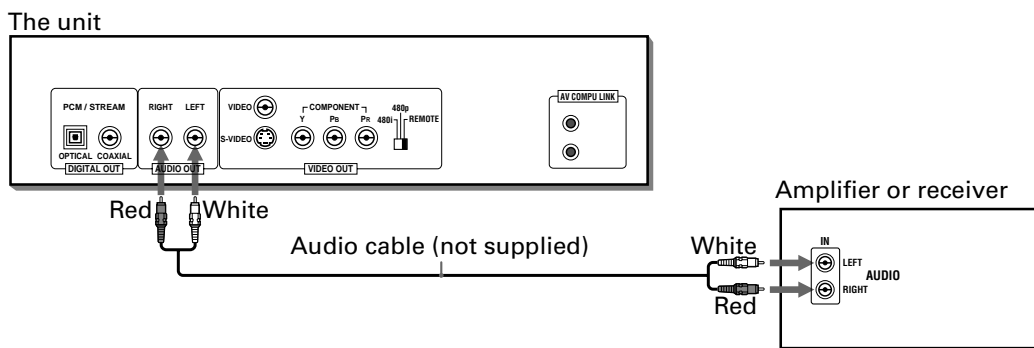

### NOTES

- When using the unit with a stereo amplifier or receiver, set "ANALOG DOWN MIX" in the "AUDIO" preferences to "STEREO" (see page 51).
- If your stereo amplifier or receiver has an AV COMPU LINK terminal, you can use the AV COMPU LINK function. See "AV COMPU LINK remote control system" on page 58 for details

## To connect to digital audio device

You can enhance the sound quality by connecting either of the unit's DIGITAL OUT jacks to the digital input of an amplifier, MD, etc. by using an optical or a coaxial digital cable (optional). The digital audio signal from a disc is directly transferred. If you connect the unit to a Dolby Digital or DTS decoder or an amplifier with a built-in decoder by using an optional digital cable, you can enjoy high-quality surround sound. When you make digital connection, we recommend also to make the analog connection, because, depending on discs, no signal may be output from the DIGITAL OUT.

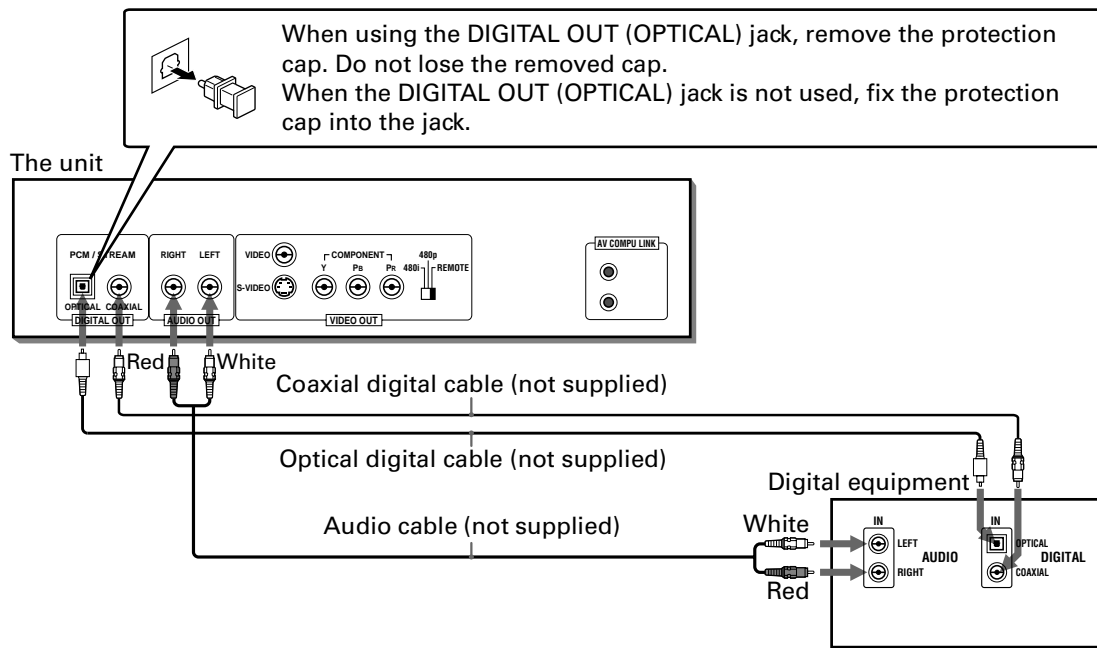

- For digital connection, connect the unit's DIGITAL OUT (OPTICAL or COAXIAL) to the digital input of digital audio device using an optical or a coaxial digital cable.

### NOTES

- When you connect the unit's DIGITAL OUT to a digital audio device, before using, set "DIGITAL AUDIO OUTPUT" in the "AUDIO" preferences correctly according to the connected audio device. If "DIGITAL AUDIO OUTPUT" is not set correctly, loud noise may be generated from speakers, causing damage to them. See "DIGITAL AUDIO OUTPUT" on page 50.
- When you connect the unit's DIGITAL OUT to a Dolby Digital or DTS decoder (or amplifier with a built-in decoder) to enjoy surround sound, the unit's "D. RANGE COMPRESSION" setting in the "AUDIO" preferences is invalid. Make appropriate surround audio settings on the decoder.
- If your digital audio device has an AV COMPU LINK terminal, you can use the AV COMPU LINK function. See "AV COMPU LINK remote control system" on page 58 for details

## To connect the power cord

When all the audio/video connections have been made, insert the smaller plug of the supplied AC power cord to the unit's  $\sim$  AC IN connector, then insert the other end to the wall outlet. Make sure that plugs are inserted firmly. The STANDBY indicator lights in red.

### NOTE (only for PX model)

- Use the supplied AC power plug adaptor when inserting the larger plug to the wall outlet.

### ⚠ Warning

- Disconnect the power cord if you are not going to use the unit for a long time.
- Disconnect the power cord before cleaning the unit.
- Disconnect the power cord before moving the unit.
- Do not connect or disconnect the power cord with wet hands.
- Do not pull the power cord when disconnecting it, as this may damage the cord and cause fire, electric shock, or other accidents.

### ⚠ Caution

- Do not alter, twist or pull the power cord, or put anything heavy on it, which may cause fire, electric shock, or other accidents.
- To prevent any accidents or damage caused by an unsuitable AC power cord, only use the supplied power cord. If the cord is damaged, contact a dealer and get another power cord.

## Using the remote control unit

Using the remote control, you can operate not only all the functions of the unit but also basic functions of your TV and amplifier/receiver.

### To install batteries in the remote control unit

The battery compartment is located on the back of the remote control unit.

- 1 Press down on the point shown by the arrow at the top of the compartment cover, and pull up the cover to open the compartment.



- 2 Place the two supplied R6P (SUM-3)/AA(15F) batteries in the remote control unit according to the polarity markings ("+" and "-") inside the compartment and on the batteries.

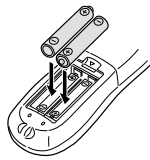

- 3 Place the cover over the compartment, and press down lightly.



The batteries will last about six months with normal use. If the functions of the remote control become erratic, replace the batteries. See below for more information.

### Precautions for the safe use of batteries

Observe the following precautions for the safe use of batteries. If they are used improperly their life will be shortened, they may burst or their contents may leak.

#### Precaution

- Remove the batteries from the remote control if it is not going to be used for a long period of time.
- Remove dead batteries and dispose of them properly.
- Never leave dead batteries lying around, take them apart, mix them with other refuse, or throw them into an incinerator.
- Never touch liquid that has leaked out of a battery.
- Do not mix new and old batteries, or batteries of different types, when replacing them.

### Remote sensor

- Operate the remote control unit while pointing it toward the remote sensor on the unit.
- The remote control unit can be used within a range of about 5 meters from the remote sensor. If you operate the remote control unit from a diagonal position, controllable distance may be shorter.

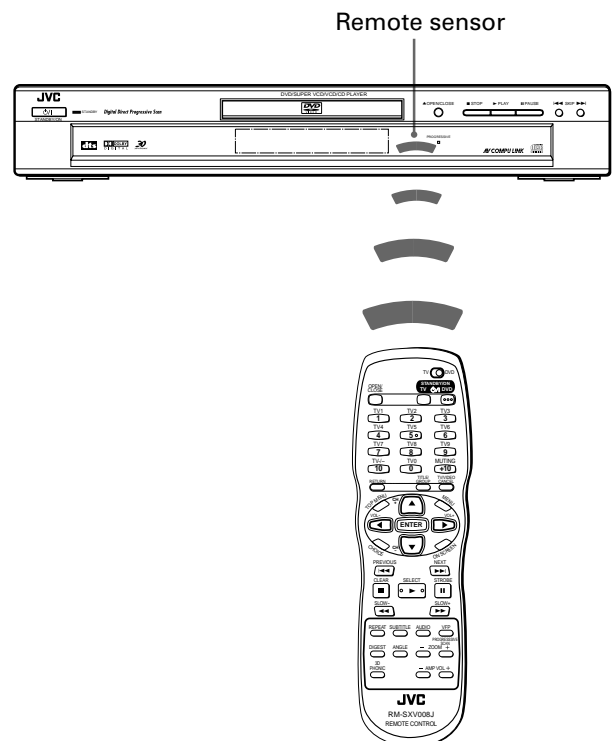

#### NOTE

- If the remote sensor on the unit is exposed to the sunshine or strong light, you may not be able to control the unit from the remote control unit.

## To use the remote control unit for TV operation

You can operate your TV from the remote control unit.

### Setting the remote control signal for operating your TV

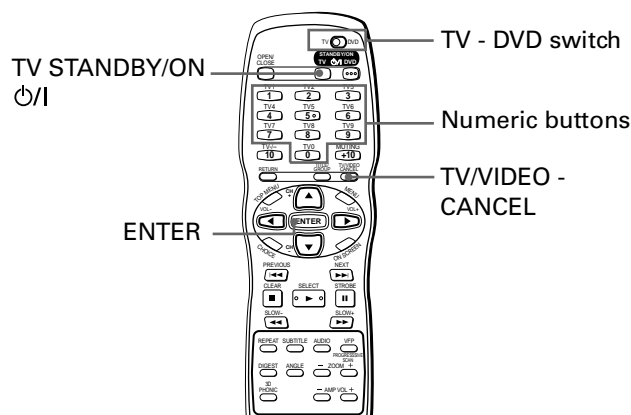

- 1 Set the TV - DVD switch to "TV".
- 2 Hold down TV/VIDEO - CANCEL until step 4 is finished.
- 3 Enter the manufacturer code of your TV listed below by using the numeric buttons (0 through 9).

#### Example:

To enter the manufacturer code "01": Press "0" then "1".



- When the unit is shipped, the manufacturer code is set to "JVC" (01).

- 4 Press ENTER.

#### Manufacturer code list

Manufacturer	No.	Manufacturer	No.
AIWA	36	MIVAR	29
BEIJING	22	NEC	20
CCE	02	NOBLEX	22
CHANGHONG	34	NOKIA	31
DAEWOO	17, 37	PANASONIC	04, 11
FERGUSON	27	PEONY	34, 38, 39
FINLUX	30	PHILCO	10, 17, 21
FUNAI	32	PHILIPS	02
GRADIENTE	15, 20	RCA	05
GRUNDIG	19	SAMSUNG	12, 33, 34, 35
HITACHI	10		
ITT	28	SANYO	13, 16
JINXING	38	SEARS	13
JVC	01, 23, 24, 25	SHARP	06
		SONY	07
KONKA	40	TCL	41
LG (GOLDSTAR)	18	THOMSON	26
MAGNAVOX	02	TOSHIBA	08, 14
mitsubishi	03	ZENITH	09

- 5 Release TV/VIDEO - CANCEL.

- 6 Try to operate the TV by pressing TV STANDBY/ON  $\odot/\text{I}$ .  
If your TV turns on or off, you have successfully set the control signal.

The following buttons can be used for operating the TV.

To use  $\blacktriangle/\blacktriangledown$  (CH-, CH+),  $\blacktriangleleft/\blacktriangleright$  (VOL-, VOL+), TV/VIDEO - CANCEL and numeric buttons for TV control, set the TV - DVD switch to "TV".

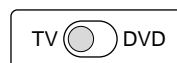

TV 	<b>Turns the TV on or off.</b>
TV/VIDEO CANCEL 	<b>Switches the TV input mode between TV and VIDEO.</b>
TV1 1 ~ TV10 10 TV0 0 	<b>Selects the TV channels directly.</b> * For some TVs, pressing "+10" functions as the "100+", while "10" functions as the ENTER button if your TV requires pressing the ENTER button after selecting a channel number.
MUTING +10 	<b>Mutes the TV sound.</b>
CH+ ▲ CH- ▼ 	<b>Changes the TV channels.</b>
VOL- ◀ VOL+ ▶ 	<b>Adjusts the TV volume.</b>

#### NOTE

- If there is more than one code listed for the manufacturer of your TV, try them one by one until you succeed.

## To control the volume of a JVC's amplifier or receiver

You can control the volume of a JVC's amplifier or receiver by using the AMP VOL +/- buttons on the remote control unit.

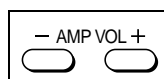

Pressing the + button raises the audio volume of the amplifier or receiver, while pressing the - button lowers the volume.

# Basic operations

In the following description, we assume that the buttons on the remote control unit are mainly used, however, you may use the corresponding buttons on the front panel if available.

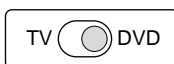

## NOTE



Make sure that the TV - DVD switch on the remote control unit is set to "DVD" when using the ▲/▼/◀/▶ and numeric buttons for controlling the unit.

## Before operation

### Turning on/off the unit

Press DVD STANDBY/ON  on the remote control unit or press STANDBY/ON  on the front panel. The STANDBY indicator on the front panel, which illuminates in red during standby, goes off.

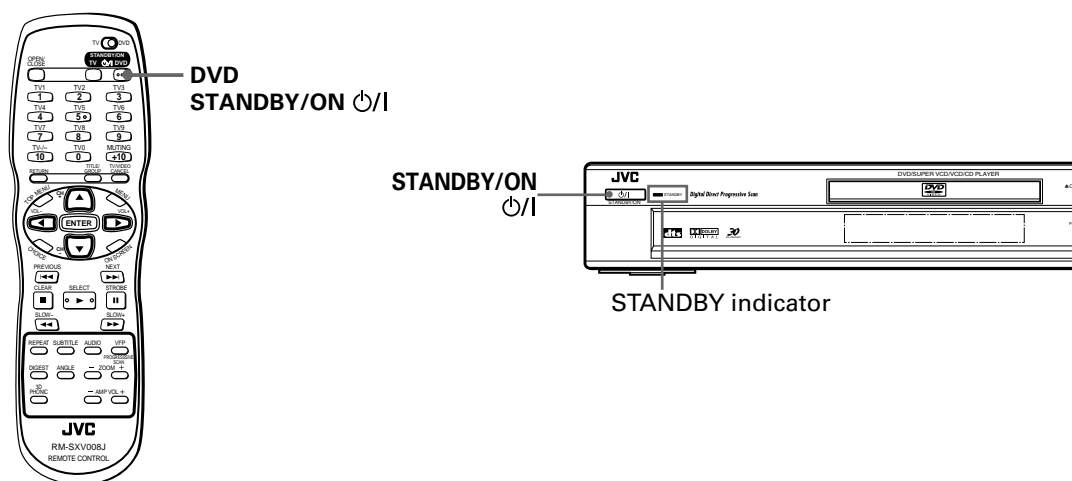

## Hints

- You can turn on the unit by pressing the ► button. In this case, the unit starts playback if the disc is set in the disc tray. If no disc is set, "NO DISC" appears on the display window.
- You can turn on the unit by pressing the ▲ OPEN/CLOSE button on the front panel. In this case, the disc tray opens.

The opening display shown right appears on the TV screen.



The following message may appear at the bottom of the opening display depending on the condition.

- NOW READING: The unit is reading the disc information.
- REGION CODE ERROR!:  
The region code of the DVD VIDEO disc does not match the unit. The disc cannot be played back.
- OPEN: The disc tray is opening.
- CLOSE: The disc tray is closing.
- NO DISC: No disc is loaded.



Message area

## NOTE

- Even if you press the DVD STANDBY/ON  on the remote control unit or STANDBY/ON  on the front panel to turn off the unit, the unit is not disconnected from the AC power source as long as it is connected to the wall outlet. This state is called the standby mode. In this state, the unit consumes a very small amount of power.

## The initial setup before using the unit

We recommend you to set the display language, TV monitor type and digital output before using the unit, depending on circumstances, by following the procedure below.

See "Changing the initial settings" on and after page 47 for details about each setting item.

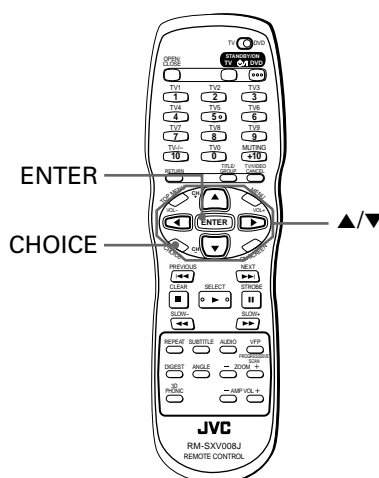

- 1 Press CHOICE for a few seconds to bring up the first page of the DVD PLAYER SET UP display.

The pull-down menu of the "ON SCREEN LANGUAGE" is already open.

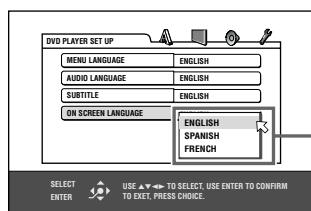

ON SCREEN LANGUAGE selection

- 2 Use ▲/▼ to select a desired language.

You can select the on-screen language for the preference displays, etc. from among English, Spanish and French.

- 3 Press ENTER.

The second page is shown, in which the pull-down menu of the "MONITOR TYPE" is already open.

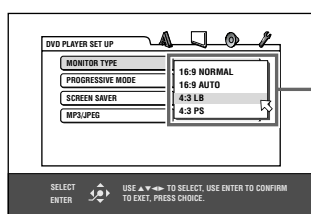

MONITOR TYPE selection

- 4 Use ▲/▼ to select a desired monitor type.

You can select the monitor type according to your TV.

- For the normal (conventional) TV, select "4:3 LB" or "4:3 PS".
- For the wide-screen TV, select "16:9 AUTO" or "16:9 NORMAL".

See page 49 for details about each mode.

- 5 Press ENTER.

The third (final) page is shown, in which the pull-down menu of the "DIGITAL AUDIO OUTPUT" is already open.

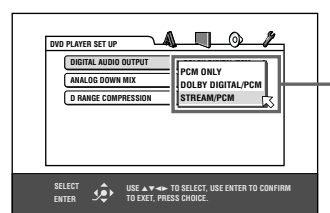

DIGITAL AUDIO OUTPUT selection

- 6 Use ▲/▼ to select a desired digital output signal type.

You must set this item correctly when you connect the unit to an external surround decoder or D/A converter (including an amplifier/receiver with built-in surround decoder or D/A converter). (If you do not connect the unit to such a device, you do not have to set this item.)

- When connecting with a Dolby Digital decoder, select "DOLBY DIGITAL/PCM".
- When connecting with a DTS or MPEG Multichannel decoder, select "STREAM/PCM".
- When connecting with other digital device, select "PCM ONLY".

See page 50 for details.

- 7 Press ENTER.

The TV screen returns to show the opening display.

### NOTES

- This setting may not be necessary except when turning on the power after purchasing the unit.
- You can also set these items, as well as other preferences, by pressing CHOICE briefly to bring up the preference display. See "Changing the initial settings" on and after page 47 for details.

## Basic playback

This section describes basic operations for playback of DVD VIDEO, Audio CD, Video CD and SVCD discs. For MP3 and JPEG disc playback, see the separate chapter on and after pages 39 and 42.

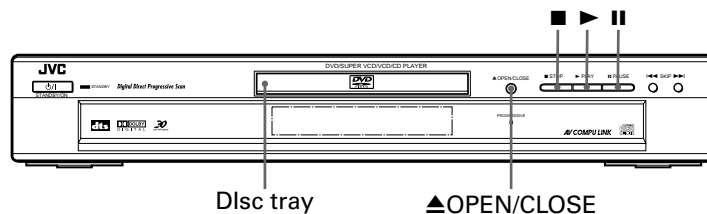
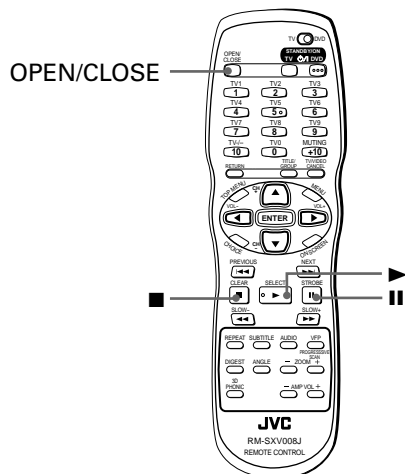

### Inserting and removing discs

- 1 Press **▲** OPEN/CLOSE to open the disc tray.
- 2 Place a disc in the tray.
- 3 Press **▲** OPEN/CLOSE to close the disc tray.

The unit reads the disc information and the opening display appears on the TV screen.



#### If a menu is shown on the TV screen

When inserting a DVD VIDEO, Video CD or SVCD disc, a menu display may be automatically shown on the TV screen. From a menu, you can select a desired item to be played back by following the procedure below.

#### (for DVD VIDEO)

- 1 Use **▲/▼/◀/▶** to select a desired item.
- 2 Press ENTER.

The unit starts playback of the selected item.

#### (for Video CD/SVCD)

- 1 Use the numeric buttons to select a desired item.
- The unit starts playback of the selected item.

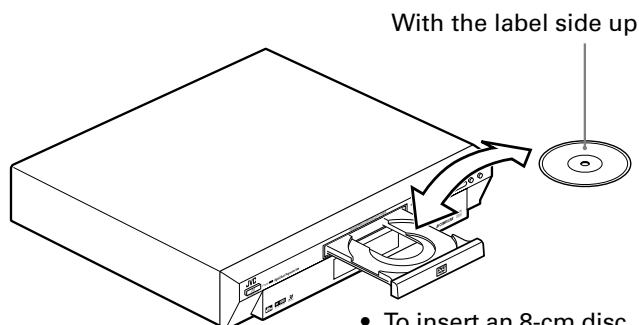

- To insert an 8-cm disc, place it in the inner recess.

### NOTES

- Do not load a non-playable disc. For details about playable and non-playable disc types, see page 4.
- When loading a disc on the tray, be sure to position the disc inside the recess. Otherwise, the disc may be damaged when the tray is closed, or the disc may not be removed from the unit.
- Do not use any stabilizer when playing back a disc.
- With some DVD VIDEO discs, the unit starts playback automatically after inserting the disc.
- If you insert a DVD VIDEO disc whose region code does not match the unit, "REGION CODE ERROR!" is shown in the opening display. For detail about the region code, see page 4.



## To start playback

Available :    

Press .

The unit starts playback from the beginning.



### About screen saver function

- A television monitor screen may be burned out if a static picture is displayed for a long time. To prevent this, the unit automatically activates the screen saver function if a static picture, such as an on-screen display or menu, is displayed for over 5 minutes.
- Pressing any buttons on the unit or the remote control unit will release the screen saver function and return to the previous display.
- You can also turn off the screen saver function (see page 50).

While the screen saver function is not activated













While the screen saver function is activated





### About On-screen guide icons

- When you make an operation, you may see the following icons displayed over the picture for about 3 seconds. These have the following meanings.

You can set the unit not to display these icons above via the preference settings described on page 52.

Icon	Status
	Appears at the beginning of playback mode.
	Appears at the beginning of stop mode.
	Appears at the beginning of pause mode.
	Appears at the beginning of fast forward/backward playback with the current speed. (See page 18.)
	Appears at the beginning of slow-motion playback with the current speed. (See page 18.)
	Appears at the beginning of Repeat playback mode. (See page 27.)
	Appears at the beginning of a scene recorded from multiple angles. (See page 31.)
	Appears at the beginning of a scene recorded with multiple audio languages. (See page 30.)
	Appears at the beginning of a scene recorded with multiple subtitle languages. (See page 29.)
	Appears when the unit does not accept your operation because of disc contents, structure, playback status etc. Note that some operation are occasionally unacceptable even if  is not displayed.

### NOTES

- When the RESUME function is "ON" or "DISC RESUME" and the resume point is memorized, pressing  starts playback from that point instead of the beginning. See page 17.
- During playback, the display window shows the title/chapter or track number being played.
- During DVD VIDEO playback, pressing  moves back the playback position 10 seconds before the current position. See page 21 for details.

## To stop playback completely

Available :    

Press .

The unit stops playback.



- If you press  OPEN/CLOSE during playback, the unit stops playback and opens the disc tray.

## To stop playback temporarily

Available :    

Press .

The unit pauses playback. To resume playback, press .

## Resuming playback

The unit can memorize the position on a disc where you interrupt playback, and resume playback from that position later. There are two resume modes (DISC RESUME and ON) you can set on the preference display. See page 52 for details about how to set the resume mode.



- When purchasing the unit, the resume mode is initially set to "ON".
- You can deactivate the resume mode by setting "RESUME" on the "OTHERS" preference display to "OFF".

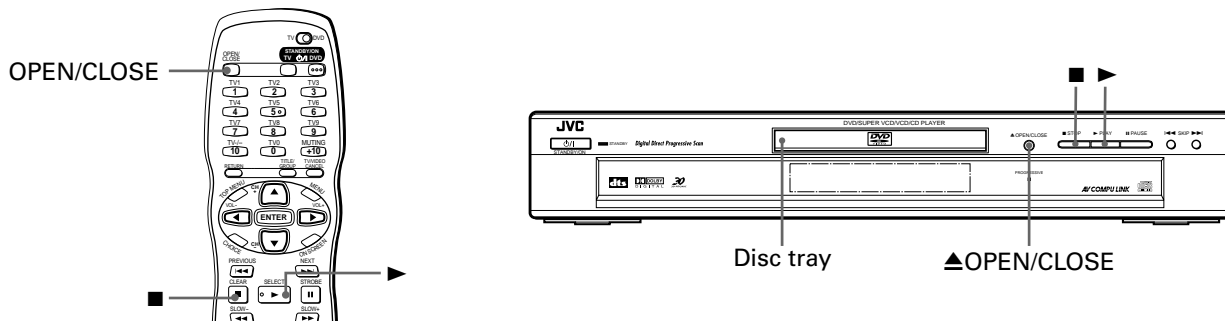

### To memorize the interrupted position

Available :

- During playback

#### When the resume mode is set to "DISC RESUME"

Press ■.

The unit stops playback and memorizes the interrupted position. After pressing ■, the display window on the front panel shows "----RESUME."

In this condition, a memory of the interrupted position is not cleared if you press ▲ OPEN/CLOSE to open the disc tray, or press STANDBY/ON ⏻ (on the front panel) or DVD STANDBY/ON ⏻ (on the remote control unit) to turn off the unit,



- The position interrupted is also memorized by pressing ▲ OPEN/CLOSE, STANDBY/ON ⏻ (on the front panel) or DVD STANDBY/ON ⏻ (on the remote control unit). In this case, "----RESUME" is not shown on the display window.
- If you do not want the disc played to resume playback, press ■ while stopped.
- It memorizes positions for the last 30 discs.
- If you interrupt playback of a disc which you resumed playback, the memory is updated to store the new interrupted position.
- When the unit has already memorized positions for 30 discs, memorizing one more position for a disc automatically erases the oldest memory. On the other hand, if you interrupt playback of a disc which an interrupted position is already memorized, the order of memorized discs may change. In result, when memorizing a new data, the order of memorized discs to be erased also may change.

#### When the resume mode is set to "ON"

Press ■.

The unit stops playback and memorizes the interrupted position.

In this condition, a memory of the interrupted position is not cleared if you press STANDBY/ON ⏻ (on the front panel) or DVD STANDBY/ON ⏻ (on the remote control unit) to turn off the unit,

Note that, if you press ▲ OPEN/CLOSE to open the disc tray, the memory of the interrupted position is cleared,



- The position interrupted is also memorized by pressing STANDBY/ON ⏻ (on the front panel) or DVD STANDBY/ON ⏻ (on the remote control unit).
- If you do not want the disc played to resume playback, press ■ while stopped.

## To resume playback

Available :   

### When the resume mode is set to "DISC RESUME"

- While stopped, or no disc is inserted

#### 1 Press ▲ OPEN/CLOSE to insert a disc whose interrupted position is memorized.

After loading the disc, the display window on the front panel shows "----RESUME."

If a disc for which you want to resume playback is already set in the disc tray, you need not to follow the step 1.

#### 2 Press ►.

The display window shows "RESUME PLAY" and the unit resumes playback from the position you interrupted playback.

The unit keeps the memory for the position on a disc where you interrupted playback, even though you remove the disc from the disc tray and set it back again.

Of course, the unit keeps the memory when the disc remains in the disc tray since the last playback.

- **To play back a disc from the beginning (instead of the interrupted position)**

After loading the disc, press ■ before pressing ► to start playback.

Pressing ■ while the disc is stopped clears the memory for the interrupted position.

Every time you interrupt playback, the position is memorized as the "resuming" point.

### When the resume mode is set to "ON"

- While the disc you interrupted playback last time\* is still on the disc tray (\*By pressing ■ or by turning off the power.)

Press ►.

The unit resumes playback from the position you interrupted playback.



If you press ► then ■, the unit starts playback after the display window shows "RESUME PLAY".

Note that you cannot resume playback if you interrupted playback last time by opening the tray.

- **To play back a disc from the beginning (instead of the interrupted position)**

Carry out any of the followings:

\* Press ■ while stopped, then press ►.

\* Turn on the unit by pressing DVD STANDBY/ON  on the remote control unit or STANDBY/ON  on the front panel then press ►.

#### NOTES

- If you change the "RESUME" setting on the "OTHERS" preference display to "OFF" or "ON" from "DISC RESUME", you cannot resume playback of a disc whose "resuming" position is memorized. However, if you again set "RESUME" to "DISC RESUME", you can resume playback of the disc.
- If you open the tray during RESUME mode is set to ON, the "resuming" point clears.
- The resume function cannot be performed with Audio CD, MP3 and JPEG discs.
- In the case of a Video CD/SVCD disc with PBC function, the unit may resume playback from a point slightly earlier or later than the point you interrupt playback last time.
- The unit may not resume playback exactly from the interrupted point, depending on the point.
- For a double-sided DVD VIDEO disc, the unit regards each side as a different disc. Therefore, when resuming playback of such a disc, make sure to set the disc with the resumed side down.
- When the unit memorizes the interrupted point of a disc, it also memorizes Audio, Subtitle and Angle settings (regardless of whether "RESUME" is set to "DISC RESUME" or "ON").
- If you interrupt playback while the menu for a DVD VIDEO, SVCD or Video CD is shown on the TV screen, the unit may not memorize the interrupted position correctly, regardless of whether the "RESUME" mode is set to "ON" or "DISC RESUME".

## Variable speed playback

You can play back slowly or fast, or advance a picture frame by frame.

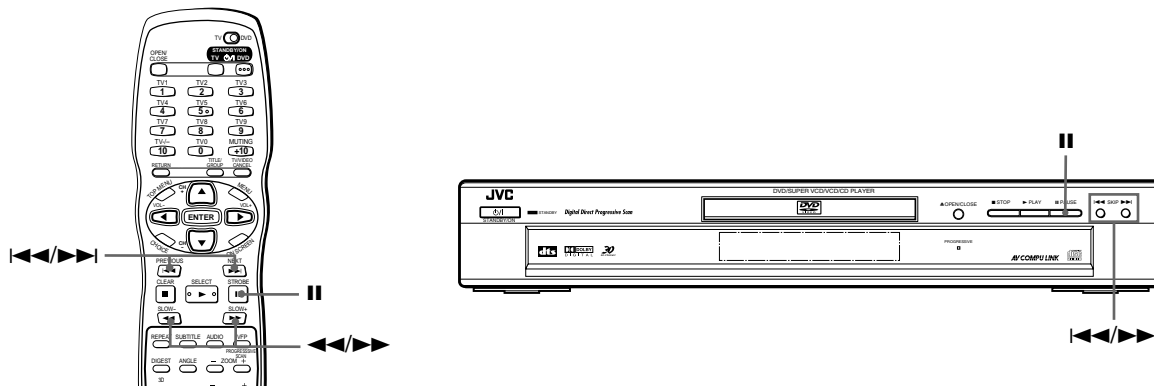

### To advance or reverse playback rapidly while monitoring

Available : **DVD VIDEO** **Audio CD** **Video CD** **Super VCD**

- During playback

#### Method 1 (from the remote control unit only)

Press ◀◀ or ▶▶.

Each press of ◀◀ or ▶▶ increases the playback speed. You can select the speed among 2 x, 5 x, 10 x, 20 x and 60 x the normal speed.

Pressing ▶ returns the unit to normal playback.

#### Method 2

Hold down ◀◀◀ or ▶▶▶.

Holding down ▶▶▶ advances playback rapidly, while holding down ◀◀◀ reverses playback rapidly at 5 times the normal speed. Releasing the button returns the unit to normal playback.

### To advance a still picture frame-by-frame

Available : **DVD VIDEO** **Video CD** **Super VCD**

- While paused (still)

Press ⏸.

Each time you press ⏸, the still picture advances to the next frame.

Pressing ▶ returns to normal playback.

### To playback in slow-motion

Available : **DVD VIDEO** **Video CD** **Super VCD**

You can playback the picture in slow-motion. The speed can be selected among 1/32 x, 1/16 x, 1/8 x, 1/4 x and 1/2 x the normal speed.

- During playback

Press ⏸, then use ◀◀/▶▶.

To play forward slow-motion, press ▶▶, and to play reverse slow-motion (for DVD VIDEO discs only), press ◀◀.

First, the unit plays the slowest speed, and each time you press the button, the playback speed increases.

Pressing ▶ returns to normal playback. Pressing ⏸ pauses slow-motion playback.

#### NOTES

- The sound is muted during slow-motion playback.
- Reverse slow-motion playback is not possible for a Video CD and SVCD.

## To locate the beginning of the scene or song

You can locate the desired title or chapter (for DVD VIDEO), or track (for Audio CD/Video CD/SVCD) from which the unit starts playback.

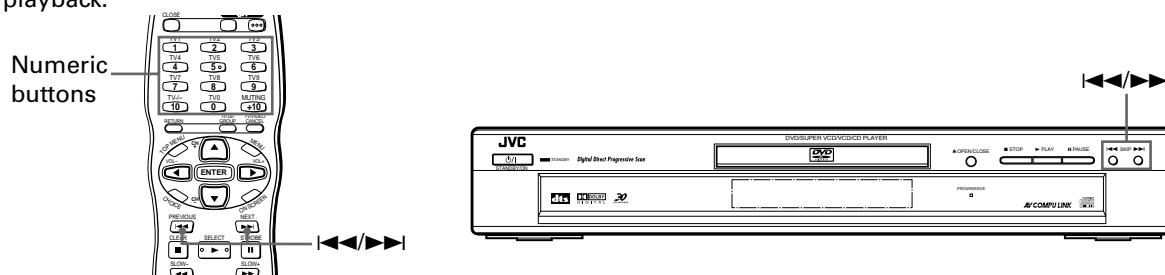

## To locate a desired selection using ◀◀ or ▶▶

Available : **DVD VIDEO** **Audio CD** **Video CD** **Super VCD**

- For DVD VIDEO: During playback
- For Audio CD: During playback or while stopped
- For Video CD/SVCD: During playback without PBC function

Press ◀◀ or ▶▶.

With an Audio CD, Video CD or SVCD, pressing the button skips a track. With a DVD VIDEO disc, pressing the button skips a chapter or title depending on the disc configuration.

The selection number appears in the display window on the front panel.

- To skip forward titles/chapters/tracks, press ▶▶ as many times as required.
- To skip to the beginning of the current track/title/chapter, press ◀◀ once.
- To skip back titles/chapters/tracks, press ◀◀ as many times as required.

### NOTES

- This function may not work with some DVD VIDEO discs.
- This function does not work during Video CD/SVCD playback with PBC function (See pages 5 and 22.)

## To locate a desired selection using the numeric buttons

Available : **DVD VIDEO** **Audio CD** **Video CD** **Super VCD**

- For DVD VIDEO/Audio CD: During playback or while stopped
- For Video CD/SVCD: During playback without PBC function or while stopped

Use the numeric buttons to specify the number.

Depending on the disc type and the unit status, what is specified differs.

Unit status	Disc type	What is specified
While stopped	DVD VIDEO	title or chapter*
	Audio CD/ Video CD/SVCD	track
During playback	DVD VIDEO	chapter
	Audio CD/ Video CD/SVCD	track

\* If a disc contains more than one title, a title is specified. If a disc contains only one title, a chapter is specified.

- To select a number between 1 and 10: Press the corresponding button for the number.
- To select a number higher than 10: Use the +10 button.

Examples:

To select 13: +10 → 3

To select 34: +10 → +10 → +10 → 4

To select 40: +10 → +10 → +10 → 10

The unit starts playback from the beginning of the selection. The selected title, chapter or track number appears in the display window on the front panel.

**NOTES**

- You can also specify the desired title during DVD VIDEO playback. See page 23 for details.
- During DVD VIDEO playback, if a menu is shown on the TV screen, the numeric buttons may be used for selecting an item in the menu.
- When  appears on the TV screen:  
The title, chapter or track you have selected is not contained in the disc.
- This function does not work during Video CD/SVCD playback with PBC function (See pages 5 and 22.)

## Other convenient functions

You can check the playback status, as well as change the brightness of the display window. Also, you can move back the playback position 10 seconds from the current position.

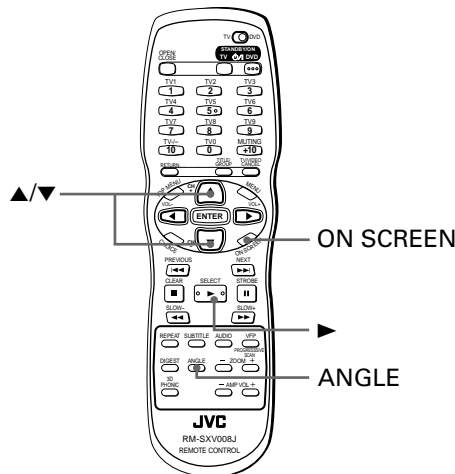

## To check the playback status

Available :    

You can see the current selection number (the title/chapter number for DVD VIDEO or track number for Audio CD/Video CD/SVCD), time information (the track or chapter time while stopped, or the elapsed track or chapter time during playback) and the transport status (stop, playback, pause etc.) on the TV screen.

- During playback or while stopped

Press ON SCREEN.

The playback status bar appears on the TV screen.

(for DVD VIDEO)

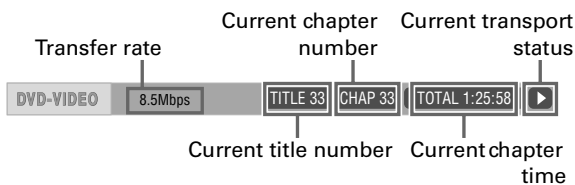

(for Audio CD)

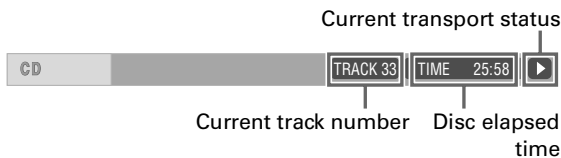



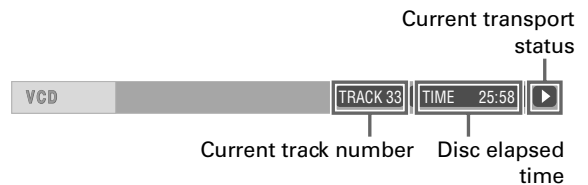

(for Video CD)

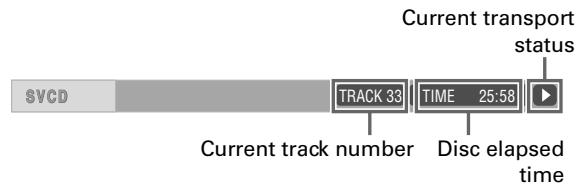

(for SVCD)



The indication on the rightmost of the status bar shows the unit's transport status as follows:

Icon	Status
	Appears in the playback mode.
	Appears in the stop mode.
	Appears in the pause mode.
	Appears in the fast forward/backward playback mode.
	Appears in the slow-motion playback mode.

Note that pressing ON SCREEN again brings up the menu bar under the status bar, from which you can access various functions.

(Example of the menu bar for DVD VIDEO)



See page 35 for details about the menu bar.

#### NOTE

- **To dismiss the status bar:**  
Press ON SCREEN until the status bar is dismissed.

## To move back the playback position while DVD VIDEO playback [One touch replay function]

Available : 

During playback of a DVD VIDEO disc, you can move back the playback position 10 seconds from the current position.

- During DVD VIDEO playback

Press .

The playback position moves back 10 seconds before the current position.

Note that this function works only in the same title, though it works between chapters.

If you press  within 10 seconds from the beginning of a title, playback starts from the beginning of the title.



#### NOTES

- **This function works only with DVD VIDEO discs.**
- **When  appears on the TV screen:**  
Some DVD VIDEO disc may not accept this function because of disc contents.

## To change the brightness of the display window

You can dim the brightness of the display window.

- When no disc is inserted or while stopped

Press  or  while holding down ANGLE.

You can select the brightness of the display window from among three levels.

# Advanced operations

This chapter describes operations for various advanced functions of DVD VIDEO, Audio CD, Video CD and SVCD discs. For MP3 and JPEG disc playback, see the separate chapter on and after pages 39 and 42.

## NOTE



Make sure that the TV - DVD switch on the remote control unit is set to "DVD" when using the ▲/▼/◀/▶, numeric and TV/VIDEO - CANCEL buttons for controlling the unit.

## Playing from a specific position on a disc

You can play a disc from the selected track, title or chapter, or from the specified time.

## To locate a desired scene from the DVD menu

Available :

DVD VIDEO discs generally have their own menus which show the disc contents. These menus contain various items such as titles of movies, names of songs, or artist information, and display them on the TV screen. You can locate a desired scene by using the DVD menu.

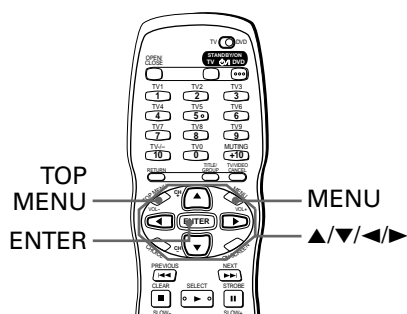

- Whenever a DVD VIDEO disc is loaded

### 1 Press TOP MENU or MENU.

The menu appears on the TV screen.

Example:

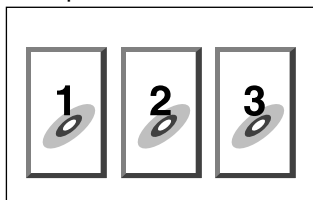

### About DVD menu

Normally, a DVD VIDEO disc which contains more than one title may have a "title" menu which lists the titles. In such a case, the menu appears on the TV screen by pressing the TOP MENU button. Some DVD VIDEO discs may also have a different menu which appears by pressing the MENU button.

See the instructions of each DVD VIDEO disc for its particular menu.

### 2 Use ▲/▼/◀/▶ to select a desired item, then press ENTER.

The unit starts playback of the selected item.



- With some discs, you can also select items by entering the corresponding number using the numeric buttons, which may cause the unit to automatically start playback.

## NOTES

- When appears on the TV screen by pressing TOP MENU or MENU in step 1:  
The disc does not have an appropriate menu. listing the titles.
- The MENU button does not work while stopped.

## To locate a desired scene from the menu of the Video CD/SVCD with PBC

Available :

Some Video CD/SVCD discs support the PBC function. PBC is an abbreviation of "PlayBack Control". A Video CD/SVCD disc recorded with PBC has its own menus, such as a list of the songs of the disc. You can locate a specific scene by using the PBC menu.

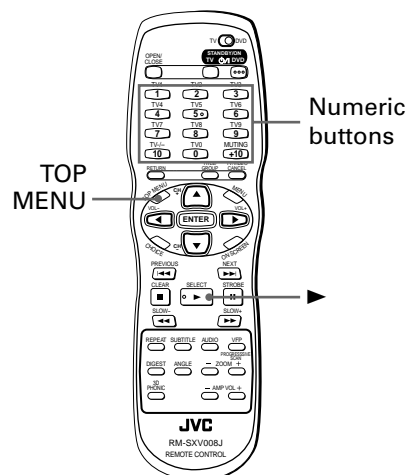

- When a Video CD/SVCD disc with PBC is stopped

### 1 Press ▶ or TOP MENU.

A disc menu appears on the TV screen (The PBC function is activated).

Example:

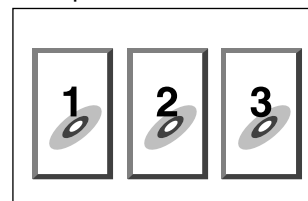

"PBC" is indicated in the display window on the front panel.



## 2 Use the numeric buttons to select the desired item.

- To select a number between 1 and 10:  
Press the corresponding button for the number.
- To select a number higher than 10:  
Use the +10 button.

Examples:

- To select 13: +10 → 3
- To select 34: +10 → +10 → +10 → 4
- To select 40: +10 → +10 → +10 → 10

The unit starts playback of the selected item. You can return to the menu by pressing the RETURN button.

When something like "NEXT" or "PREVIOUS" appears on the TV screen, the unit generally works as follows:

- Pressing ►► advances to the next page.
- Pressing ◀◀ returns to the previous page.
- \* The method of the operation is different depending on the disc.

### Hints

- If you want to playback a PBC-compatible Video CD/SVCD disc without activating the PBC function, start playback by using the numeric buttons instead of ►. (See page 19.)
- To activate the PBC function when a PBC-compatible Video CD/SVCD disc is being played back without the PBC function, carry out any of the followings:  
\* Press TOP MENU or MENU.  
\* Press ■ to stop playback, then Press ►.

## To specify a desired title

Available :

While playing back a DVD VIDEO disc with more than one title, you can specify a desired title to be played using the numeric buttons.

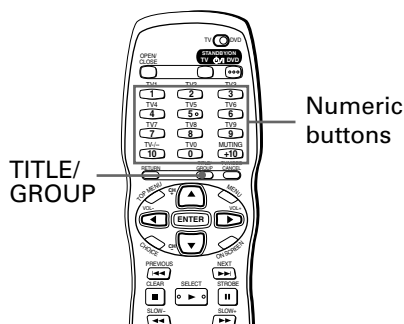

- During playback

### 1 Press TITLE/GROUP.

"--" is shown in the title display area of the display window.

(Example for the indication of display window)

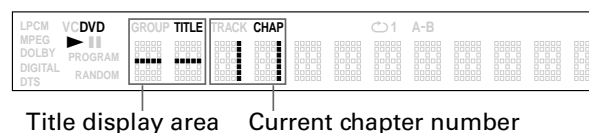

Title display area      Current chapter number

## 2 Use the numeric buttons to specify a title to be played.

- To select a number between 1 and 10:  
Press the corresponding button for the number.
- To select a number higher than 10:  
Use the +10 button.

Examples:

- To select 13: +10 → 3
- To select 34: +10 → +10 → +10 → 4
- To select 40: +10 → +10 → +10 → 10

The unit starts playback from the specified title.

### NOTE

- Some DVD VIDEO discs may not accept this function because of disc contents.

## To locate a desired position in the current title or track [Time search]

Available :

You can play a disc from the desired position by specifying the elapsed time from the beginning of the current title (for DVD VIDEO), or the disc (for Audio CD/Video CD/SVCD) using the time search function.

Note that some DVD VIDEO discs do not contain time information, and the time search function cannot be used.

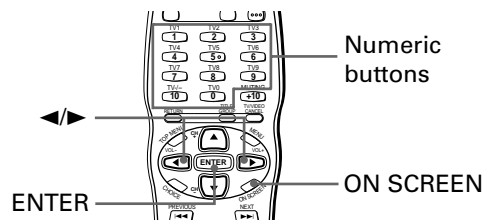

- For DVD VIDEO/AUDIO CD:

During playback or while stopped

- For Video CD/SVCD:

In any condition except Video CD/SVCD playback with PBC

### 1 Press ON SCREEN twice.

The menu bar appears on the TV screen. (See page 35 for details about menu bar.)

### 2 Use ◀/▶ to move [ ] to [ ] , then press ENTER.

The pull-down menu for entering time appears under the [ ] .

(Screen example for DVD VIDEO)

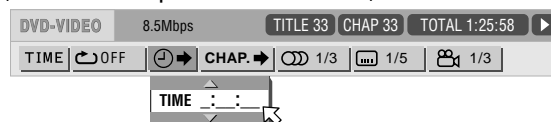

(Screen example for Audio CD)

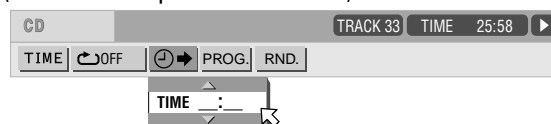

### 3 Use the numeric buttons (0 to 10) to enter the desired time.

The specified time is displayed in the pull-down menu.

#### Hints

- "10" button works as "0" and "+10" button is not used with this function.
- You can specify the time in hour/minute/second format for DVD VIDEO discs, and in minute/second format for Audio and Video CD/SVCD discs.

### 4 Press ENTER.

The unit starts playback from the specified time.

#### • Example (for DVD VIDEO)

To playback from 2(H):34(M):00(S)

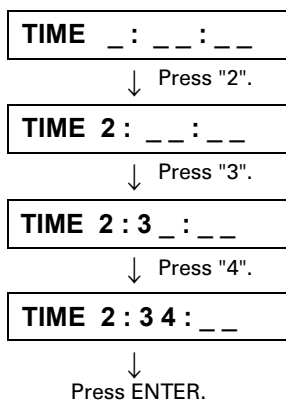

#### • Example (for Audio CD/Video CD/SVCD)

To playback from 23(M):40(S)

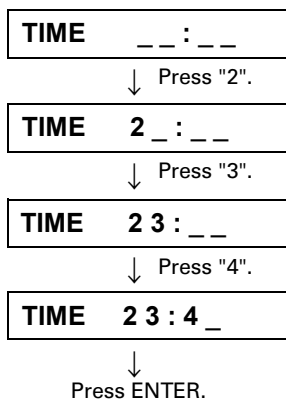

You do not have to press "0" to enter the trailing zeros (for the last two digits in the example above).

#### • When you correct a mistake

Use ◀ repeatedly to move back to the digit where you entered a undesired numeral (the leftmost "-" digit), and reenter the correct time.

(Example for changing "2:35:\_" to "2:34:\_.")

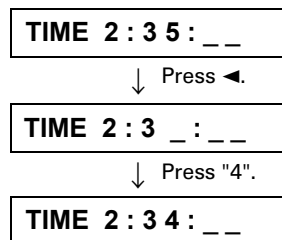

#### NOTES

- **When Ⓞ appears on the TV screen:**  
The time you have selected is not contained on the disc, or the time search function does not work on the disc.  
Also note that the time search function does not work during Video CD/SVCD playback with the PBC function.
- **To dismiss off the menu bar:**  
Press ON SCREEN.
- **The time search function cannot be used during program playback.**

## To locate a desired scene from the display [DIGEST]

Available : **DVD VIDEO** **Video CD** **Super VCD**

The unit can display the opening scene of each title or chapter on a DVD VIDEO or each track of a Video CD/ SVCD. You can select a desired scene from those displayed on the TV screen.

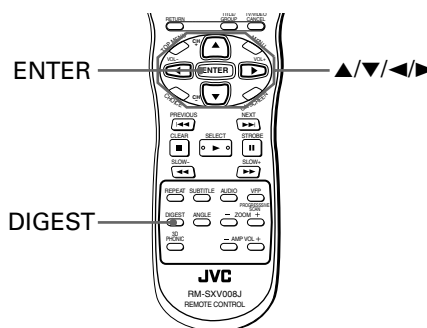

- **For DVD VIDEO:** During playback or while stopped
- **For Video CD/SVCD:** In any condition except Video CD/SVCD playback with PBC

### 1 Press DIGEST.

Up to nine opening scenes are displayed.



Depending on the disc type and whether the disc is being played back or not, the contents shown on the TV screen differ.

Disc type	Unit status	What is displayed
DVD VIDEO	While stopped	The opening scene of each title
	During playback	The opening scene of each chapter in the current title
Video CD/ SVCD	While stopped or during playback	The opening scene of each track

## 2 Use ▲/▼/◀/▶ to move to select the desired scene.

If there are more than 9 scenes, the digest screen will have more than one page. In this case, pressing ▶▶ advances to the next page, while pressing ◀◀ returns to the previous page.



Selected scene

### Hints

- When the lower right scene is selected, pressing ▶ advances to the next page if available. Similarly, when the upper left scene is selected, pressing ◀ returns to the previous page (if available).
- Depending on discs, it may take some time until all scenes of the current page appear on the TV screen. If you want to turn the page, you do not have to wait to press ◀◀ or ▶▶ until all scenes appear.

## 3 Press ENTER.

The unit starts playback from the selected scene.

### NOTE

- With some discs, depending on the contents, it may take some time until all the scenes appear on the screen.

# Changing the playback order

You can play tracks on an Audio CD, Video CD or SVCD in the desired order or in random order.

## To playback in the desired order [Program playback]

Available :   

By programming tracks, you can play up to 99 tracks in any order. You may program the same track more than once.

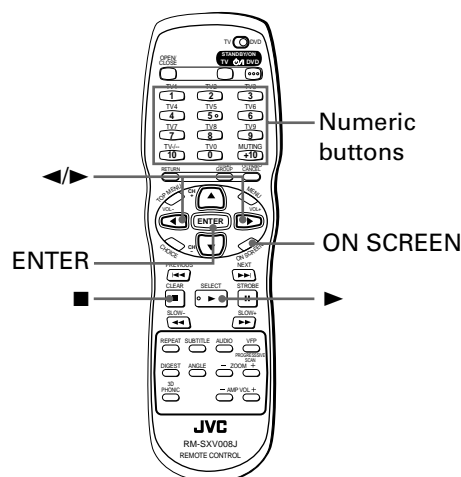

- While stopped

## 1 Press ON SCREEN twice.

The menu bar appears on the TV screen. (See page 35 for details about menu bar.)

## 2 Use ◀/▶ to move to **PROG.**

(Screen example for Audio CD)

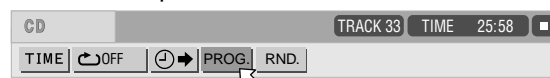

## 3 Press ENTER.

The program table appears instead of the menu bar. The PROGRAM indicator lights in the display window on the front panel.

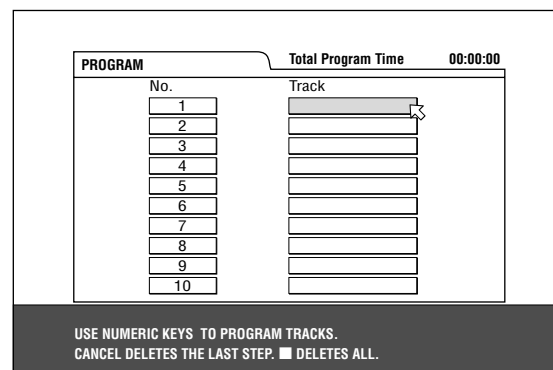

#### 4 Specify tracks in the desired order using the numeric buttons.

- To select a number between 1 and 10: Press the corresponding button for the number.
- To select a number higher than 10: Use the +10 button.

Examples:

- To select 13: +10 → 3
- To select 34: +10 → +10 → +10 → 4
- To select 40: +10 → +10 → +10 → 10

Up to 99 tracks can be programmed. You may select the same track more than once. The total program time is shown at the right top of the program table.

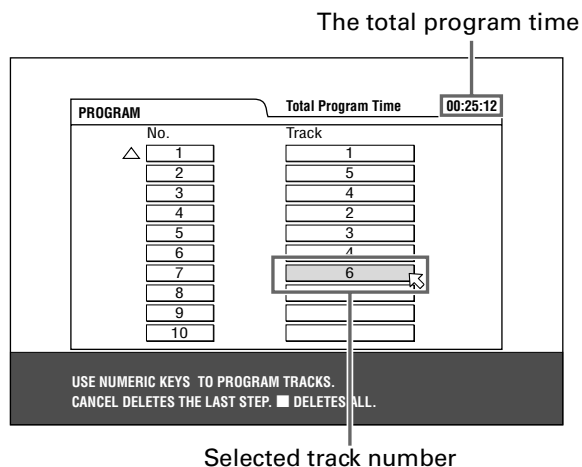

Selected track number

- **If you specify a wrong track**  
Use ▲/▼ to move to the wrong track, then press TV/VIDEO - CANCEL. The track is erased and the subsequent programmed tracks move up.
- **To clear the program while programming**  
Press ■.

#### 5 Press ► to start program playback.

With a Video CD/SVCD disc, the program table is automatically dismissed when the program playback starts. With an Audio CD disc, the program table remains on the TV screen during program playback. However, pressing the ON SCREEN button brings up the status bar. When all of the programmed tracks have finished playback, the unit stops and the program table appears again. Note that the program remains.

- **To check the program contents**  
During playback, press ■. Playback stops and the program table is shown. When the unit is playing back an Audio CD and the program table is not shown, you can bring up the table by carrying out steps 1 through 3. During Video CD/SVCD playback, you cannot see the program table during playback.
- **To quit program playback**  
Press ■. Note that the program remains.

- **To clear the program**  
While stopped and the program table is shown on the TV screen, press ■. All the programmed tracks are erased.
- **To exit the program mode**  
After clearing all programmed tracks, press ON SCREEN. The program table is dismissed and the status bar appears on the TV screen. The PROGRAM indicator in the display window disappears and the unit quits program playback mode.

#### NOTES

- During program playback, you cannot edit the program contents.
- During program playback, pressing ►► skip to the next selection of the program. Pressing ◀◀ returns to the beginning of the current selection.
- To dismiss the program table:  
Press ON SCREEN. The program table is dismissed and the status bar is shown.
- To dismiss the menu bar (and the status bar):  
Press ON SCREEN.

### To playback in random order [Random playback]

Available :

You can play tracks on a disc in random order by using the random function.

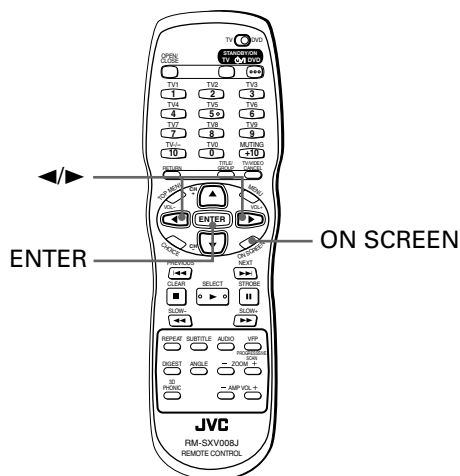

- While stopped
  - 1 Press ON SCREEN twice.  
The menu bar appears on the TV screen. (See page 35 for details about menu bar)
  - 2 Use ◀/▶ to move to **RND.**

(Screen example for Audio CD)

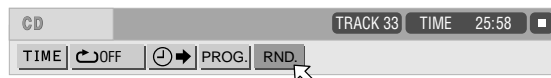

### 3 Press ENTER.

The unit starts random playback.

With a Video CD/SVCD disc, the menu bar is automatically dismissed.

While random playback, the RANDOM indicator lights in the display window on the front panel.

After playing all tracks of the disc, the unit stops the disc and quits the random mode.

#### Hints

- The same track will not be played back more than once during random play.
- During random playback, if you bring up the menu bar and carry out steps 1 through 3 above, the unit cancels the random playback mode and continues playback from the current selection in the recorded order.
- **To stop and quit random playback**  
Press ■. The unit stops playback and quits the random playback mode.

#### NOTE

- **To dismiss the menu bar:**  
Press ON SCREEN.

## Repeat playback

You can repeat playback of the current title or chapter (for DVD VIDEO), or current or all tracks (for Audio CD/Video CD/SVCD).

You can also repeat playback of a desired part.

### To repeat the current selection or all tracks [Repeat playback]

Available : **DVD VIDEO** **Audio CD** **Video CD** **Super VCD**

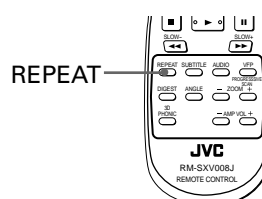

- For DVD VIDEO: During playback or while stopped  
For Audio CD/Video CD/SVCD: In any condition except Video CD/SVCD playback with PBC

### 1 Press REPEAT.

Each time you press REPEAT, the repeat mode switches among All repeat, Repeat 1 and off.

You can see the selected mode by icons in the display window on the front panel as below.

If you press REPEAT while stopped, you need to press ► to start repeat playback.

- ☺: Repeats the current title for DVD VIDEO or all tracks for Audio CD/Video CD/SVCD.
- ☺1: Repeats the current chapter for DVD VIDEO or the current track for Audio CD/Video CD/SVCD.

No indication:

The repeat mode is off.

(Display window)



Repeat mode indicators

On the TV screen, a window for repeat mode indication appears. You can check the current repeat mode from the window.

The mode indication on the window is same as the one on the menu bar. (See pages 36 and 37.)

(Screen example for repeat mode Indication window)



- **To stop repeat playback**

Press ■.

When a DVD VIDEO disc is set, the unit stops playback and quits the repeat mode.

When an Audio CD, Video CD or SVCD disc is set, the unit stops playback but does not quit the repeat mode.

- **To quit repeat playback**

Press REPEAT until the repeat mode indicator goes off in the display window.

**NOTES**

- You can also select the repeat mode via the menu bar. See pages 36 and 37.
- When the program playback mode is active with an Audio CD, Video CD or SVCD, the repeat mode changes in the same manner.  
Note that, however, in the "⏮" mode the unit repeats all the programmed tracks, instead of all tracks on the disc.
- During playback in the title/chapter/track repeat mode, if you skip the title/chapter/track using ⏮/⏭, etc., the destination title/chapter/track is repeated.
- If ⏮ appears when pressing REPEAT during DVD VIDEO playback  
You cannot repeat the title or chapter because of the disc contents.
- Repeat playback function cannot be used during Video CD/SVCD playback with PBC function.

**To repeat a desired part [A-B repeat playback]**

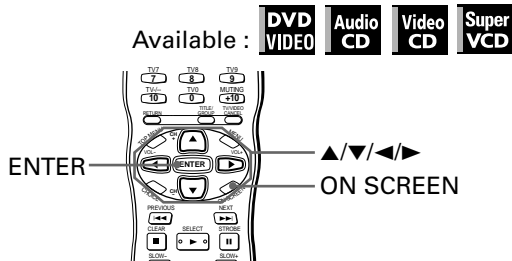

• During playback except Video CD/SVCD playback with PBC

**1** Press ON SCREEN twice.

The menu bar appears on the TV screen. (See page 35 for details about menu bar.)

**2** Use ⏮/⏭ to move to , then press ENTER.

The pull-down menu for repeat mode selection appears under the .

**3** Use ▲/▼ to select "A-B".

Depending on the disc type and unit's status the repeat mode changes as follows:

• During DVD VIDEO playback

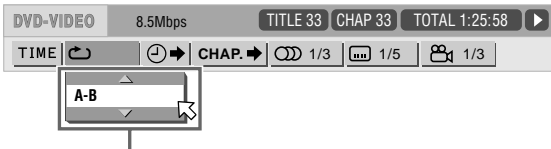

Selected repeat mode

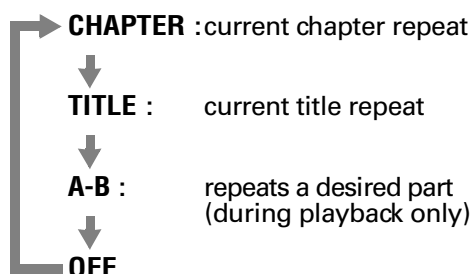

• Audio CD/Video CD/SVCD

(Screen example for Audio CD)

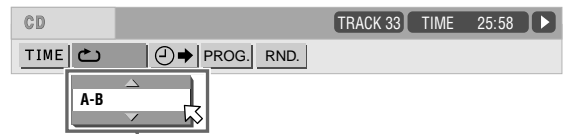

Selected repeat mode

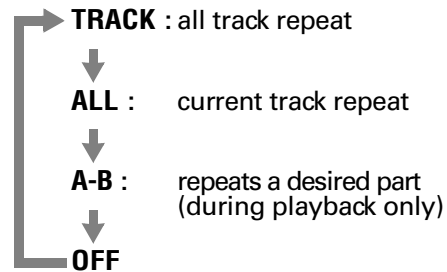

**4** Press ENTER at the beginning of the part you want to repeat (point A).

The pull-down menu turns off.

The repeat icon shows .

(Screen example for DVD VIDEO)



Repeat icon

**5** Press ENTER at the end of the part you want to repeat (point B).

The repeat icon show .

The unit locates "A" and starts repeat playback between "A" and "B".

• To quit A-B repeat playback

Press ENTER. The A-B repeat mode turns off, while the playback continues.



- Selecting "OFF" from the pull-down menu for repeat mode selection, or pressing ⏮/⏭ quits the A-B repeat mode and continues playback.
- You can also stop and quit A-B repeat mode by pressing ■.

**NOTES**

- The A and B points must be set in the same title/chapter/track.
- To dismiss the menu bar:  
Press ON SCREEN.
- If ⏮ appears when pressing ENTER during DVD VIDEO playback  
You cannot repeat the selected portion because of the disc contents.

## Changing the language, sound and scene angle

With some DVD VIDEO discs, you can choose a desired subtitle language and/or audio language/sound, as well as a desired camera angle. Similarly, you can choose a desired audio channel (or channel combination) of a Video CD/SVCD disc, as well as a subtitle channel of an SVCD disc.

### To select the subtitle language [SUBTITLE]

Available :  

Some DVD VIDEO and SVCD discs for movies, guides, etc. contain more than one subtitle language. You can choose a desired one from them.



- At the beginning of the part where the subtitle(s) is(are) recorded,  appears on the TV screen (except when the "ON SCREEN GUIDE" preference is set to "OFF"). See page 52 for details about "ON SCREEN GUIDE" preference.

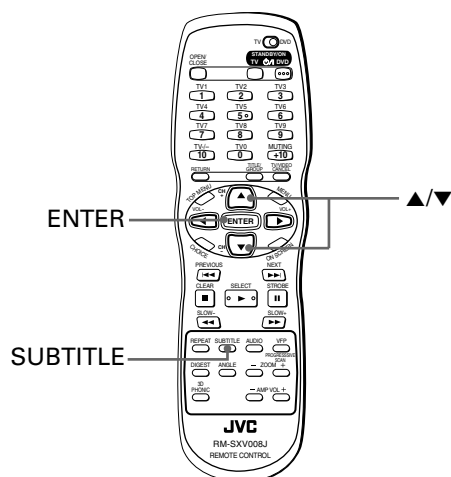

- During DVD VIDEO/SVCD playback (except when the status bar is shown)

### 1 Press SUBTITLE.

The Subtitle selection window appears on the TV screen.

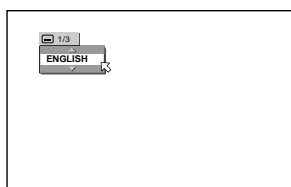

### 2 Use ▲/▼ or SUBTITLE to select the subtitle.

Each time you press ▲/▼ or SUBTITLE, the subtitle language changes.

See the following examples for subtitle selection.

#### • For DVD VIDEO

Pressing ▲/▼ or SUBTITLE cycles among the subtitles recorded on the disc.

Example:

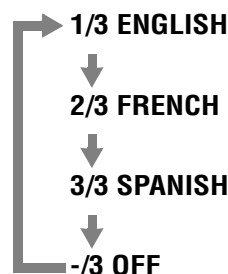

#### • For SVCD

An SVCD disc can have up to four subtitles.

Pressing ▲/▼ cycles among those channels as follows regardless of whether the subtitles are recorded or not.

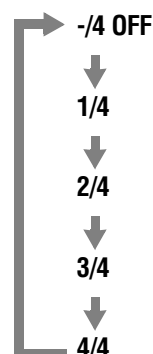

### 3 Press ENTER.

The subtitle in the selected language is shown. The subtitle selection window is dismissed.

#### NOTES

- For DVD VIDEO, the selected language may be abbreviated on the TV screen. See "Table of languages and their abbreviations" on page 48.
- The Subtitle selection window will automatically disappear if you do not change the subtitle for several seconds.
- When  appears on the TV screen (for DVD VIDEO disc):  
You cannot select the subtitle or no subtitle is recorded.
- You can also select the subtitle via the menu bar. See pages 36 and 38.

## To change the audio language or sound [AUDIO]

Available : **DVD VIDEO** **Video CD** **Super VCD**

By audio selection, you can choose the audio language of movies or enjoy KARAOKE with or without the vocal.

### Hints

- At the beginning of the part where multiple audio sounds are recorded,  appears on the TV screen (except when the "ON SCREEN GUIDE" preference is set to "OFF"). See page 52 for details about "ON SCREEN GUIDE" preference.

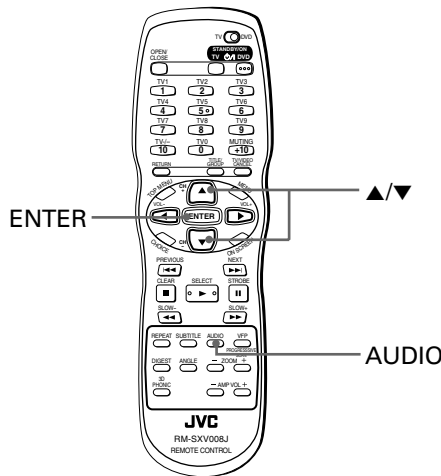

- During playback (except when the status bar is shown)

### 1 Press AUDIO.

The audio selection window appears on the TV screen.

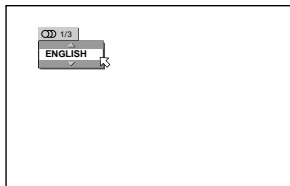

### 2 Use AUDIO or ▲/▼ to select the desired audio.

Each time you press ▲/▼ or AUDIO, the audio changes. See the following examples for audio selection.

#### For DVD VIDEO

Each time you press ▲/▼ or AUDIO, the audio language or sound changes.

Example:

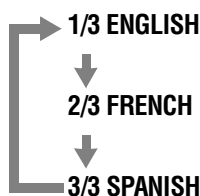

#### For Video CD/SVCD

Each time you press ▲/▼ or AUDIO, the playback audio changes as follows.

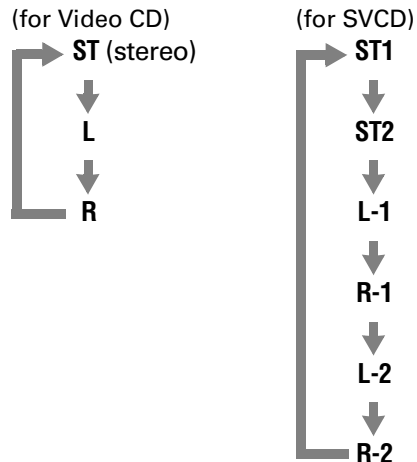

### 3 Press ENTER.

You can hear the selected audio. The audio selection window is dismissed.

#### NOTES

- For DVD VIDEO, the selected language may be abbreviated on the TV screen. See "Table of languages and their abbreviations" on page 48.
- The Audio selection window will automatically disappear if you do not change the audio for several seconds.
- When  appears on the TV screen (for a DVD VIDEO disc): You cannot select the audio.
- If only one audio sound is recorded, you cannot select the audio.
- You can also select the audio via the menu bar. See pages 36 and 38.



## To select a scene angle of DVD VIDEO [ANGLE]

Available : 

You can enjoy a variety of scene angles if the DVD VIDEO disc contains "multi-angle" parts, where multiple cameras were used to shoot the same scene from different angles.



- At the beginning of a "multi-angle" part,  appears on the TV screen (except when the "ON SCREEN GUIDE" preference is set to "OFF"). See page 52 for details about "ON SCREEN GUIDE" preference.

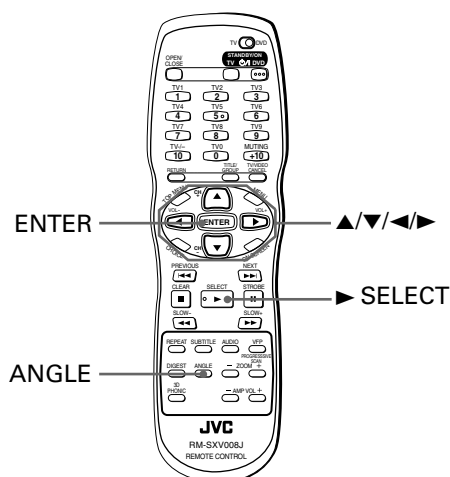

### From Angle selection window

- During DVD VIDEO playback (except when the status bar is shown)

#### 1 Press ANGLE.

The Angle selection window appears on the TV screen.

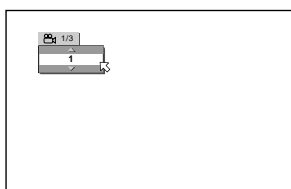

#### 2 Use ANGLE or ▲/▼ to select the desired angle.

Each time you press ANGLE or ▲/▼, the angle changes.

Example:

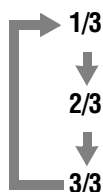

#### 3 Press ENTER.

You can see the picture from the selected angle. The angle selection window is dismissed.

### From the angle list

- During DVD VIDEO playback

#### 1 Press and hold ANGLE for more than 1 second.

Up to nine camera angles recorded on a disc appear on the TV screen.

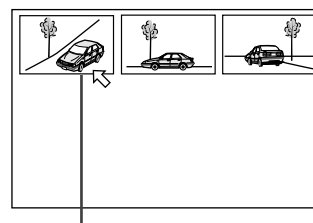

The selected camera angle

#### 2 Use ▲/▼/◀/▶ to select the desired angle.

#### 3 Press ENTER or ▶ SELECT.

The unit starts playback by the selected angle on the full-sized screen.

### NOTES

- The Angle selection window will automatically disappear if you do not change the angle for several seconds.
- When  appears on the TV screen in step 1: The current scene is not recorded from multiple angles.
- During the operation from the angle list display, audio is muted.
- You can also select the angle via the menu bar. See page 37.

## Special picture playback and picture/sound effect

You can see continuous still pictures or zoom in (or out) the picture. You can also adjust the picture character, as well as simulate surround sound using a stereo system.

### To display continuous still pictures [STROBE]

Available : **DVD VIDEO** **Video CD** **Super VCD**

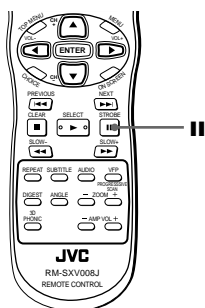

- During playback

**1** At the point you want to view as continuous photographs, press **||**.

The unit pauses playback.

**2** Press and hold **||** for more than 1 second.

Nine same frames (still picture) appear on the TV screen.

You can advance frames one by one by the following step.

**3** Press **||** once.

The picture in the middle on the top row shows an advanced frame from one in the left.

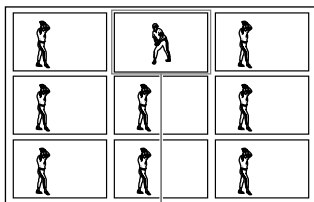

Advanced frame

Each press of **||** advances the frame one by one. Pressing **▶** instead of **||** advances each frame in normal playback speed with a time delay over the whole nine pictures (while the sound is muted).

- To return to the normal screen

Press and hold **||** for more than 1 second.

#### NOTE

- If you press and hold **||** for more than 1 second during playback, nine still pictures also appear but they advance in normal playback speed (while the sound is muted).

### To zoom in/out pictures [ZOOM]

Available : **DVD VIDEO** **Video CD** **Super VCD**

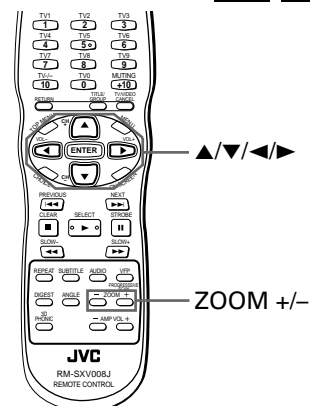

- During playback or while paused

**1** Press ZOOM + or -.

The unit zooms in by pressing ZOOM + or zooms out by pressing ZOOM -.

Each time you press ZOOM +, the magnification is doubled (up to x 1024).

Each time you press ZOOM -, the magnification is halved (down to x 1/8).

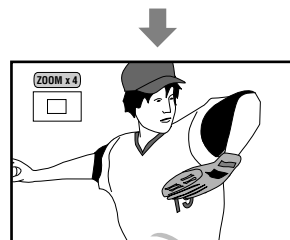
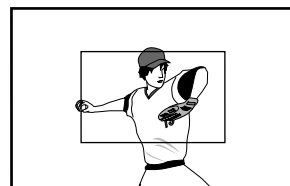

At the top-left of the screen, the information for the current magnification appears. While zoomed in, the indication for the zoomed-in position, which can be moved by operating the next step, appears together.

**2** Use **▲/▼/◀/▶** to move the zoomed position.

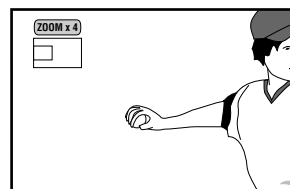

#### NOTES

- To return to normal playback  
Press ENTER.
- While zoomed, the picture may look coarse.

## To adjust the picture character [VFP]

Available :   

The VFP (Video Fine Processor) function allows you to adjust the picture character according to the type of programming, picture tone or personal preferences.

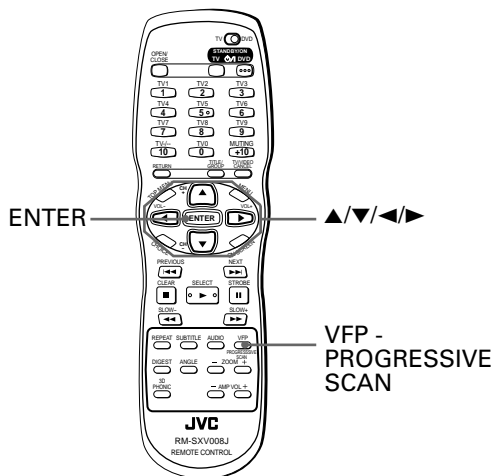

### ● During playback

#### 1 Press VFP - PROGRESSIVE SCAN.

The VFP mode selection window appears on the TV screen.

#### 2 Use ◀▶ to select the desired preset.

Each time you press the button, the VFP mode changes as follows.

Set the video type most suitable to the current program or the room conditions.

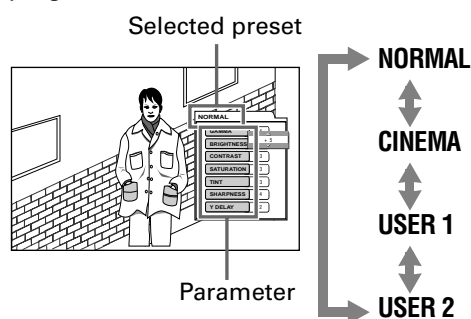

"NORMAL" is suitable for watching TV in a general room. "CINEMA" is suitable for watching a movie software in a room with suppressed light.

They are factory presets and you cannot change parameters for them.

While selecting "USER 1" or "USER 2", you can adjust parameters that affect the picture character and store the settings as the user preset. See the next step.

### 3 To define a user setting, select a parameter to be edited using ▲/▼ from the followings.

- **GAMMA**  
Controls the brightness of a shaded portion without changing the brightness of the entire picture.  
This control is optimum when you adjust the pictures of software which generates subdued black in a bright room.  
The setting range is +4 to -4.
- **BRIGHTNESS**  
Controls the brightness of the screen.  
The setting range is +16 to -16.
- **CONTRAST**  
Controls the contrast of the screen.  
The setting range is +16 to -16.
- **SATURATION**  
Controls the color depth of the screen.  
The setting range is +16 to -16.
- **TINT**  
Controls the tint of the screen.  
Use the appearance of a natural complexion as the guideline.  
The setting range is +16 to -16.
- **SHARPNESS**  
Controls the sharpness of the screen.  
The setting range is +3 to 0.
- **Y DELAY**  
Controls the color gap of the screen.  
The setting range is +2 to -2.

### 4 Press ENTER.

A window for setting parameters appears instead of the VFP mode selection window.

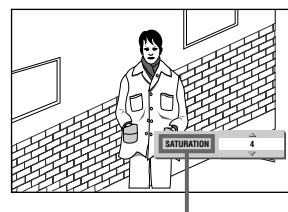

### 5 Adjust the level of the parameter using ▲/▼.

The higher value enhances the effect.

### 6 Press ENTER.

The parameter is set and the VFP mode selection window appears again.

Repeat steps 3 through 6 if you want to set other parameters.

#### NOTES

- The number of setting steps depends on parameters.
- To dismiss the VFP mode selection window:  
Press VFP - PROGRESSIVE SCAN.
- The window for VFP mode selection and parameter setting disappears if no operation is made for about 10 seconds.

## To simulate surround sound [3D PHONIC]

Available : 

Using the 3D PHONIC function, you can get a simulated surround effect from your stereo system.

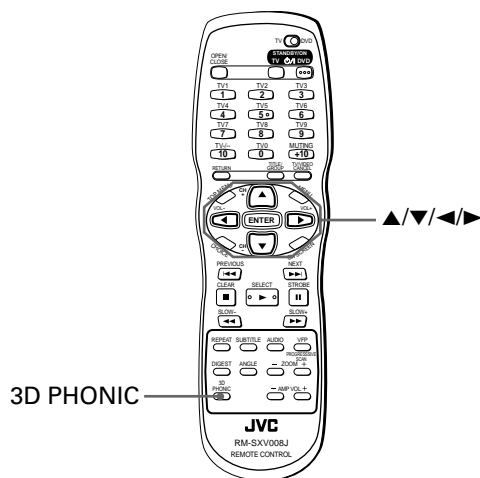

Effect level

**3** Press ▲/▼ to adjust the effect level.

You can select the effect level among "1" through "5".

The higher value enhances the effect.

### NOTES

- To dismiss the 3D PHONIC window: Press 3D PHONIC.
- The 3D PHONIC window disappears if no operation is made for about 10 seconds.
- The 3D PHONIC function works correctly only when playing back a DVD VIDEO disc recorded with the Dolby Digital. With other sources, you cannot get any effect if you press the 3D PHONIC button.
- When playing back a DVD VIDEO disc recorded with the Dolby Digital that does not contain the rear signal, you cannot get a correct 3D PHONIC sound though you can change the 3D PHONIC setting.
- The 3D PHONIC function does not affect the Dolby Digital bitstream signal from the DIGITAL OUT jack.
- When you set the 3D PHONIC function is active, the "ANALOG DOWN MIX" and "D. RANGE COMPRESSION" setting in the "AUDIO" setting display are disabled.

● During playback

**1** Press 3D PHONIC.

The 3D PHONIC window appears on the TV screen.

**2** Select the desired mode by using ◀▶.

Each time you press the button, the 3D PHONIC mode changes as follows:

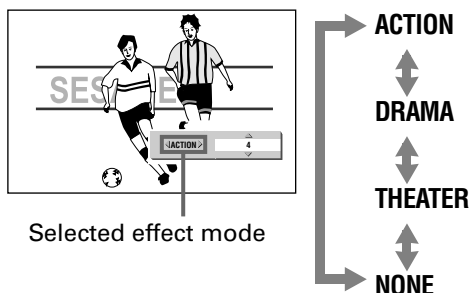

Selected effect mode

- **ACTION**  
Suitable for action movies and sports programs in which sounds dynamically move.
- **DRAMA**  
Natural and warm sound. You can enjoy movies in a relaxed mood.
- **THEATER**  
You can enjoy sound effects like in a major theater in Hollywood.

Advanced operations

## Menu bar functions

This section describes the functions you can perform via the menu bar.

The available menu bar functions differ depending on the disc type.

### To bring up the menu bar

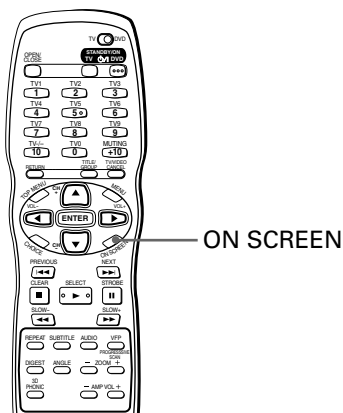

- When a disc is inserted

#### 1 Press ON SCREEN.

The status bar, according to the disc type, appears on the TV screen.  
See page 20 about the status bar.

(Example of the status bar for DVD VIDEO)



#### 2 Press ON SCREEN again.

The appropriate menu bar, according to the disc type, appears together with the status bar. The menu bar includes some icons which indicate the associated functions.

(for DVD VIDEO)



(for Audio CD)

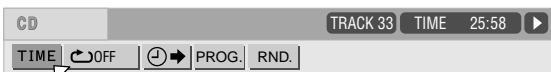

(for Video CD)



(for SVCD)

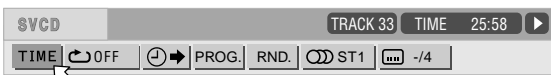

#### NOTE

- To dismiss the menu bar (and status bar):  
Press ON SCREEN.

## Basic operation procedure

English

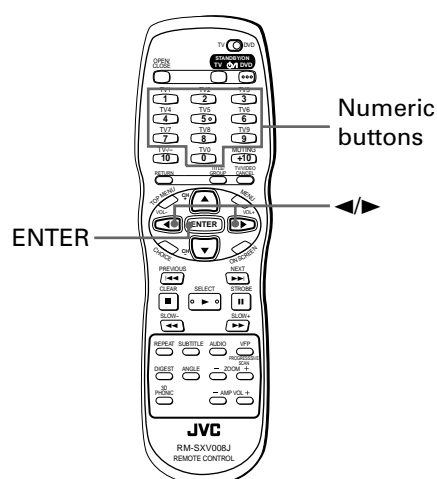

#### 1 Use $\leftarrow/\rightarrow$ to select icon you want to work with.

The selected icon is pointed by  $\leftarrow/\rightarrow$ .

#### 2 Press ENTER.

With many icons, an appropriate pull-down window appears, however, there are some exceptions.

- See the following pages for details about each function.
- Note that some functions are not available during playback. (You cannot move  $\leftarrow/\rightarrow$  to the associated icon when it is not available.)

#### NOTES

- When  $\odot$  appears on the TV screen:  
You cannot use the selected function because of disc contents.
- A mark or text on the menu icon for the function or mode currently selected is shown in blue.

## Menu bar functions for DVD VIDEO

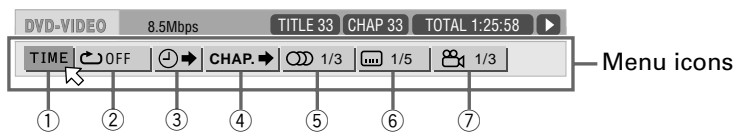

The following table shows the menu bar functions available for DVD VIDEO. Note that, in the description of the operation column, we assume the associated icon is selected.

Selected Icon	Operation	Note
<p>① <b>TIME</b></p> <p><b>Time mode selection</b> (During playback only)</p> <p>Selects the time mode shown in the display window on the front panel and in the status bar.</p>	<p>Press ENTER to select the time mode among the followings.</p> <p><b>TOTAL</b> → <b>T.REM</b> → <b>TIME</b> → <b>REM</b> → Return to initial</p> <ul style="list-style-type: none"> <li>• <b>TOTAL:</b> Current title elapsed time</li> <li>• <b>T.REM:</b> Current title remaining time</li> <li>• <b>TIME:</b> Current chapter elapsed time</li> <li>• <b>REM:</b> Current chapter remaining time</li> </ul>	<ul style="list-style-type: none"> <li>• If the disc has only one title and one chapter, "TOTAL" and "TIME" shows the same value.</li> </ul>
<p>② <b>Repeat mode</b> (During playback only)</p> <p>Select the repeat mode.</p>	<p>1 Press ENTER to open the pull-down window.</p> <p>2 Use ▲/▼ to select the repeat mode among the followings.</p> <p><b>CHAPTER</b> ↔ <b>TITLE</b> ↔ <b>A-B</b> ↔ <b>OFF</b></p> <ul style="list-style-type: none"> <li>• <b>CHAPTER:</b> Current chapter repeat</li> <li>• <b>TITLE:</b> Current title repeat</li> <li>• <b>A-B:</b> Repeats a desired part (A-B repeat)</li> </ul> <p>3 Press ENTER to make the selected repeat function active. (See pages 27 to 29 for details about the Repeat function.)</p>	<ul style="list-style-type: none"> <li>• If you select "OFF" during repeat playback, the unit continues playback without repeating.</li> <li>• For the subsequent operations for the A-B repeat, see page 28.</li> </ul>
<p>③ <b>Time search</b></p> <p>Specifies the elapsed time from the beginning of the current title, from which the unit starts playback.</p>	<p>1 Press ENTER to open the pull-down window.</p> <p>2 Use numeric buttons to enter a desired time.</p> <p>3 Press ENTER to playback from the specified time. (See page 23 for details.)</p>	
<p>④ <b>CHAP.</b></p> <p><b>Chapter search</b> (During playback only)</p> <p>Specifies a desired chapter to be played back from.</p>	<p>1 Press ENTER to open the pull-down window.</p> <p>2 Use numeric buttons to enter a desired chapter number.</p> <ul style="list-style-type: none"> <li>• For example of entering "12", press "1" then "2".</li> </ul> <p>3 Press ENTER to playback from the specified chapter.</p> <ul style="list-style-type: none"> <li>• <b>When the chapter number is incorrect:</b> Overwrite the incorrect number with the correct number.</li> </ul>	<ul style="list-style-type: none"> <li>• The "10" and "+10" buttons are not used in this function.</li> <li>• You can also locate a desired chapter directly by specifying the chapter number using the numeric buttons during playback. See page 19.</li> </ul>
<p>⑤ <b>Audio selection</b> (During playback only)</p> <p>Selects the audio language or sound.</p>	<p>1 Press ENTER to open the pull-down window.</p> <p>2 Use ▲/▼ to select a desired audio language or sound.</p> <p><b>Example:</b> 1/3 ENGLISH ↔ 2/3 FRENCH ↔ 3/3 SPANISH</p> <p>3 Press ENTER to playback with the selected audio. (See page 30 for details about audio selection.)</p>	<ul style="list-style-type: none"> <li>• For DVD VIDEO, the selected language may be abbreviated on the TV screen. See "Table of languages and their abbreviations" on page 48.</li> </ul>
<p>⑥ <b>Subtitle selection</b> (During playback only)</p> <p>Selects the subtitle language.</p>	<p>1 Press ENTER to open the pull-down window.</p> <p>2 Use ▲/▼ to select a desired subtitle language.</p> <p><b>Example:</b> 1/3 ENGLISH ↔ 2/3 FRENCH ↔ 3/3 SPANISH ↔ -/3 OFF</p> <p>3 Press ENTER to playback with the selected subtitle. (See page 29 for details about subtitle selection.)</p>	



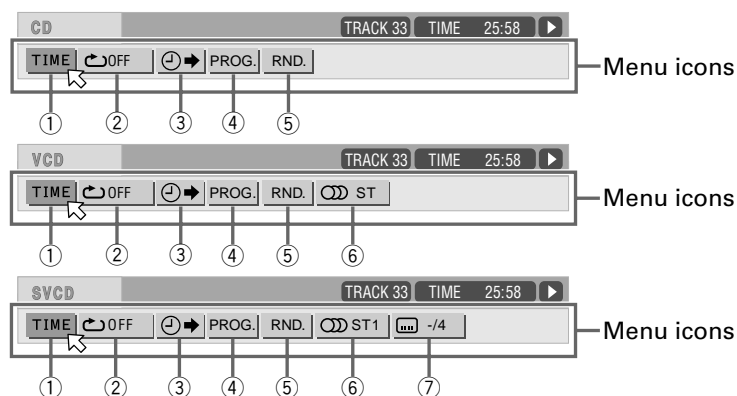

Selected Icon	Operation	Note
⑦  <b>Angle selection</b> (during playback only) Selects a desired scene angle in the multi-angle part.	1 Press ENTER to open the pull-down window. 2 Use ▲/▼ to select a scene angle. <b>Example:</b> 1/3 ↔ 2/3 ↔ 3/3 3 Press ENTER to playback with the selected scene angle. (See page 31 for details about angle selection.)	



## Menu bar functions for Audio CD/Video CD/SVCD



The following table shows the menu bar functions available for Audio CD/Video CD/SVCD.

Note that, in the description of the operation column, we assume the associated icon is selected.

Selected Icon	Operation	Note
①  <b>Time mode selection</b> Selects the time mode shown in the display window on the front panel and in the status bar.	Press ENTER to select the time mode among the followings. <b>TIME</b> ⇒ <b>REM</b> ⇒ <b>TOTAL</b> ⇒ <b>T.REM</b> ⇒ <b>Return to initial</b> <ul style="list-style-type: none"> <li>• <b>TIME:</b> Current track elapsed time</li> <li>• <b>REM:</b> Current track remaining time</li> <li>• <b>TOTAL:</b> Disc elapsed time</li> <li>• <b>T.REM:</b> Disc remaining time</li> </ul>	<ul style="list-style-type: none"> <li>• When you select "REM" while stopped, you can change the track by pressing ◀◀ or ▶▶.</li> <li>• During stopped, "REM" show the recording time of the current track, while "T.REM" show the total time of the disc.</li> </ul>
②  <b>Repeat mode</b> Select the repeat mode.	1 Press ENTER to open the pull-down window. 2 Use ▲/▼ to select the repeat mode among the followings. <b>OFF</b> ↔ <b>TRACK</b> ↔ <b>ALL</b> ↔ <b>A-B</b> ↔ <b>OFF</b> <ul style="list-style-type: none"> <li>• <b>TRACK:</b> Current track repeat</li> <li>• <b>ALL:</b> All track repeat</li> <li>• <b>A-B:</b> Repeats a desired part (A-B repeat)</li> </ul> 3 Press ENTER to make the selected repeat function active. (See pages 27 to 29 for details about the Repeat function.)	<ul style="list-style-type: none"> <li>• If you select "OFF" during repeat playback, the unit continues playback without repeating.</li> <li>• For the subsequent operations for the A-B repeat, see page 28.</li> </ul>
③  <b>Time search</b> (Except during Video CD/SVCD playback with PBC) Specifies the elapsed time from the beginning of the disc, from which the unit starts playback.	1 Press ENTER to open the pull-down window. 2 Use numeric buttons to enter a desired time. 3 Press ENTER to playback from the specified time. (See page 23 for details.)	<ul style="list-style-type: none"> <li>• This function cannot be used during program playback.</li> </ul>
④  <b>Program</b> (While stopped only) Specifies the playback order of tracks.	1 Press ENTER to bring up the program table. 2 Specify tracks in the desired order using the numeric buttons. 3 Press ▶ to start program playback. (See page 25 for details.)	

Selected Icon	Operation	Note
⑤  <b>Random</b> (While stopped only) Activates random playback.	1 Press ENTER to activate random playback. (See page 26 for details.)	<hr/>
⑥  <b>Audio selection</b> (During Video CD/SVCD playback only) Selects the audio channel(s).	1 Press ENTER to open the pull-down window. 2 Use ▲/▼ to select a desired audio channel(s). 3 Press ENTER to playback with the selected audio channel(s). (See page 30 for details about audio selection.)	<hr/>
⑦  <b>Subtitle selection</b> (During SVCD playback only) Selects the subtitle.	1 Press ENTER to open the pull-down window. 2 Use ▲/▼ to select a desired subtitle. 3 Press ENTER to playback with the selected subtitle. (See page 29 for details about subtitle selection.)	<hr/>



# MP3 disc playback

The unit can play back MP3 files on a private CD-R/RW disc or commercial CD. We refer to a disc that contains MP3 file as an "MP3 disc" in this manual. Though available functions with MP3 discs are limited, operations for the available functions are similar to those with Audio CD discs. Note that, if a disc contains both of MP3 and JPEG files, you can only play back files of either type selected by the MP3/JPEG setting in the PICTURE preference display. (See page 50.)

## What is MP3?

"MP3" stands for "MPEG Audio Layer-3", and is the part of the MPEG standard. It can store high quality stereo audio using very little space by only saving the audible sounds and discarding the sounds your ears won't pick up. A CD can store up to around 10 hours of MP3 audio, which is 10 times as much as Audio CD.

### NOTE

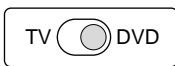

Make sure that the TV - DVD switch on the remote control unit is set to "DVD" when using the ▲/▼/◀/▶ and numeric buttons for controlling the unit.

## About MP3 disc

On an MP3 disc, each material (song) is recorded on a file. Files are sometimes grouped into a folder by artist, album, category, etc. In addition, a folder can be a member of another folder, creating hierarchical folder layers. If you are familiar with a personal computer, you may easily understand the hierarchical file/folder construction of MP3 discs.

This unit simplifies the hierarchical construction of a disc and manages files and folders by "Tracks" and "Groups" in the following manners.

- Each file is regarded as a Track.
- A folder which has one or more files (Tracks) is regarded as a Group.
- A folders' folder which does not manage any file directly is ignored.
- Files which do not belong to any folder are grouped into "Group 1".
- The unit recognizes up to 150 Tracks per Group, and up to 99 Groups per disc. It ignores those exceeding the maximum numbers and cannot play back them. If there is any type of files other than MP3 files in a folder, those files are also counted down from the total number of 150.

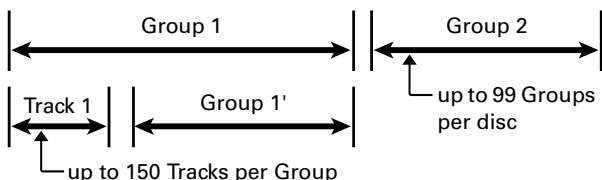

## NOTES for making a private MP3 disc using a CD-R/CD-RW disc:

- Select "ISO 9660" as the disc format.
- Finalize the disc after completing recording.
- We recommend to record a material at 44.1-kHz Fs and at the 128-kbps data transfer rate.

### NOTES

- The unit does not support "packet write" discs.
- The unit does not support the ID3 tag.
- If the disc is recorded with multiple sessions, the unit supports up to five sessions.
- Some discs may not be played back because of the disc characteristics or recording condition.
- The unit does not output a digital audio signal from DIGITAL OUT when playing back a MP3 disc.
- You cannot playback Tracks in the desired (programmed) or random order.
- The unit only can play back Tracks with any of the following file extensions; ".MP3", ".Mp3", ".mp3" and ".mP3".
- Time required for reading the disc contents differs with discs, depending on the numbers of Groups (folders) and Tracks (files) recorded, etc.
- While an MP3 disc is loaded, you cannot bring up any preference display. (See page 47.)

## Operations

### Basic operations

Available : **MP3**

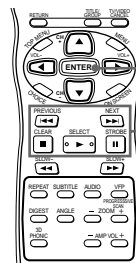

Basic control buttons

The following table shows basic functions of basic control buttons.

Buttons	Functions
	Starts playback while stopped.
	Starts playback while stopped or paused.
	Stops playback.
	Pauses playback.
	Skips back or forward a Track in the Group* during playback. Selects the previous or next Track in the Group* while stopped.

- \*You can skip a Track across a Group.
- If you press ► during playback, or press ■ to stop playback followed by ►, the unit starts playback from the beginning of the current track.
- The ◀/▶ buttons work the same as the ◀◀/▶▶ button.

**NOTES**

- The current Group and Track number are shown on the display window in the following manner.

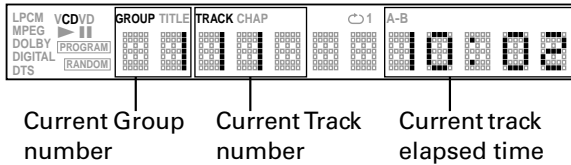

- You cannot advance or reverse playback of an MP3 disc rapidly.
- You cannot see any other time information but the current track elapsed time.

## Selecting the desired Group and Track

Available : **MP3**

When loading an MP3 disc, after the disc contents are read, the MP3 CONTROL display automatically appears on the TV screen.

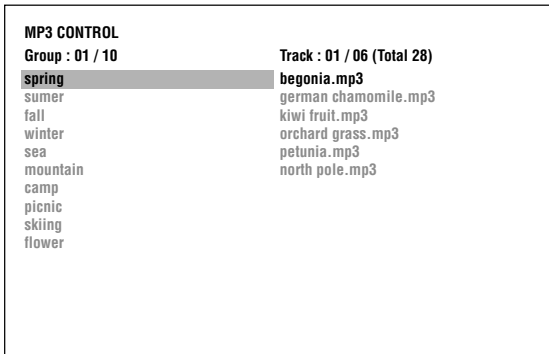

You can specify the desired Group/Track from the display by the following procedure.

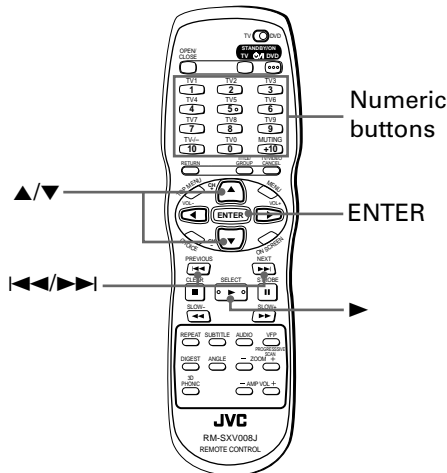

- When the MP3 CONTROL display is shown.

**1** Make sure that the black (cursor) bar is in the left (Group) column.

If it is in the right column, press ◀ to move it to the left column.

**2** Move the bar to a desired Group using ▲/▼.

On the right column, Tracks in the selected Group are shown.

When selecting a Group, Track 1 is initially selected (highlighted).

**3** Select a desired Track using ◀◀/▶▶, then press ENTER or ▶.

or

Use the numeric buttons to directly specify a desired Track number.

- To select a number between 1 and 10: Press the corresponding button for the number.
- To select a number higher than 10: Use the +10 button.

Examples:

To select 13: +10 → 3

To select 34: +10 → +10 → +10 → 4

To select 40: +10 → +10 → +10 → 10

The unit starts playback from the selected Track.

In the MP3 CONTROL display and the display window on the front panel, you can see the current Group and Track numbers, as well as Track elapsed time.

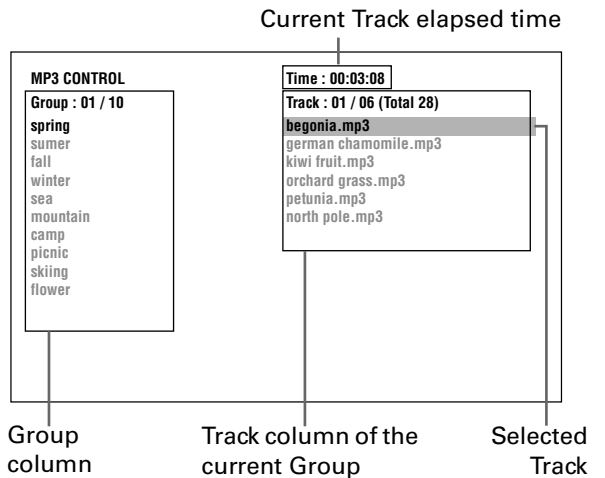

**Hints**

- You can also select a desired Track by pressing ▶ to move the black bar to the right (Track) column then using ▲/▼.

**NOTES**

- If a MP3 file name includes any 2-byte character, the unit may not show the file name correctly.
- Only MP3 files are shown on the MP3 CONTROL display.
- The order of Groups/Tracks shown in the MP3 CONTROL display may differ from the order shown on your personal computer when you set the disc on your computer.

## Direct selection

Available : **MP3**

You can select a desired Group directly by specifying the Group number.

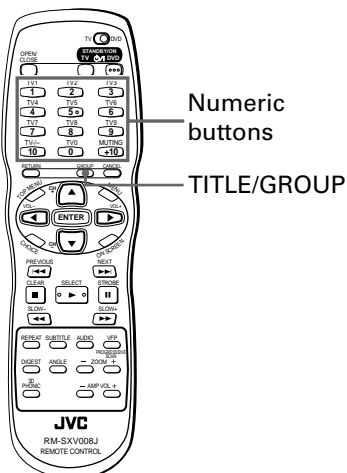

- During playback or while stopped

### 1 Press TITLE/GROUP.

"--" is shown in the Group display area of the display window.

(Example for the indication of window)

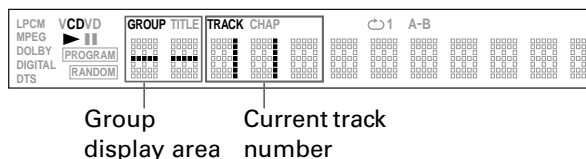

### 2 Use the numeric buttons to specify a desired Group number.

- To select a number between 1 and 10: Press the corresponding button for the number.
- To select a number higher than 10: Use the +10 button.

Examples:

- To select 13: +10 → 3
- To select 34: +10 → +10 → +10 → 4
- To select 40: +10 → +10 → +10 → 10

Specify the Group number within several seconds after pressing TITLE/GROUP (i.e. while the display window shows "--" for the Group number, instead of the current Group number). The unit starts playback from Track 1 of the selected Group.

### 3 Use the numeric buttons to specify a desired Track number.

The unit starts playback from the specified Track. You can also use ◀▶ or ▲▼ for specifying a track, instead of the numeric buttons.

## Repeat playback

Available : **MP3**

You can repeat playback of the current Track, current Group or all MP3 files on the disc.

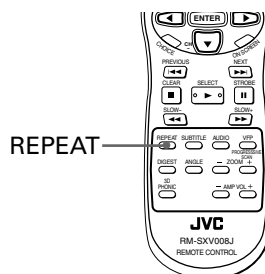

- During playback or while stopped

### 1 Press REPEAT.

Each time you press REPEAT, the repeat mode changes as follows. You can see the current mode via the display window as well as the MP3 CONTROL display.

If you press REPEAT while stopped, you need to press ENTER or ▶ to start repeat playback.

MP3 CONTROL display	Display Window	Function
REPEAT TRACK	↻ 1	Repeats the current Track.
REPEAT GROUP	↻	Repeats all Tracks in the current Group.
REPEAT ALL	↻	Repeats all Tracks on the disc.
No indication		The repeat mode is off.

(TV screen) Selected repeat mode

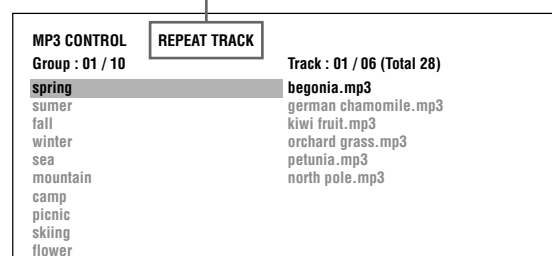

(Display window)

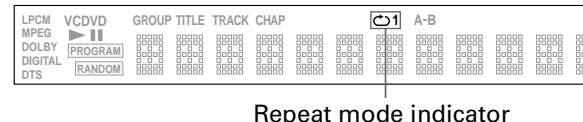

Repeat mode indicator

- **To stop repeat playback**  
Press ■. Note that the repeat mode remains.
- **To quit repeat playback**  
During playback, press REPEAT as many times until no repeat icon is shown on the display window. While stopped, press REPEAT as many times until repeat mode indication on the MP3 CONTROL display goes off.

# JPEG disc playback

The unit can play back JPEG files on a private CD-R/RW disc. We refer to a disc that contains JPEG files as a "JPEG disc" in this manual.

Note that, if a disc contains both of MP3 and JPEG files, you can only play back files of either type selected by the MP3/JPEG setting in the PICTURE preference display (See page 50).

## What is JPEG?

"JPEG" is an abbreviation for the Joint Photographic Experts Group and is an image format that utilizes a compression technique.

There are three sub-types of the JPEG format as follows.

- baseline JPEG: used for digital cameras, web, etc.
- progressive JPEG: used for web
- lossless JPEG: an old type and rarely used now

The unit supports only the baseline JPEG type, therefore, it cannot display pictures of the other types (progressive and lossless). If a JPEG disc contains JPEG files of non-baseline type, the unit recognizes those files as JPEG files, the JPEG CONTROL display and the display window shows the information of the contents (filename, file number, etc.), but you cannot show the still pictures of those files (the TV screen appears only in black.)

## NOTE

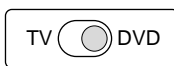

Make sure that the TV - DVD switch on the remote control unit is set to "DVD" when using the ▲/▼/◀/▶, numeric buttons for controlling the unit.

## About JPEG disc

On a JPEG disc, each material (still picture) is recorded on a file. Files may be grouped into a folder by category, etc. In addition, a folder can be a member of another folder, creating hierarchical folder layers. If you are familiar with a personal computer, you may easily understand the hierarchical file/folder construction of JPEG discs. This unit simplifies the hierarchical construction of a disc and manages folders by "Groups" in the following manners.

- A folder which has one or more files is regarded as a Group.
- A folders' folder which does not manage any file directly is ignored.
- Files which do not belong to any folder are grouped into "Group 1".
- The unit recognizes up to 150 files per Group, and up to 99 Groups per disc. It ignores those exceeding the maximum numbers and cannot play back them. If there is any type of files other than JPEG files in a folder, those files are also counted down from the total number of 150.

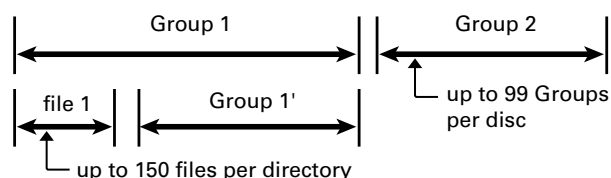

## NOTES for making a private JPEG disc using a CD-R/CD-RW disc:

- Select "ISO 9660" as the disc format.
- Finalize the disc after completing recording.
- We recommend to record a material at "640 x 480" resolution.
- The unit supports only the baseline JPEG type, therefore, it cannot display pictures of the other types (progressive and lossless). If a JPEG disc contains JPEG files of non-baseline type, the unit recognizes those files as JPEG files. the JPEG CONTROL display and the display window shows the information of the contents (filename, file number, etc.), but you cannot show the still pictures of those files (the TV screen appears only in black.)

## NOTES

- The unit does not support "packet write" discs.
- If the disc is recorded with multiple sessions, the unit supports up to five sessions.
- Some disc may not be played back, or take some time to open the whole picture because of the disc characteristics or recording condition.
- You cannot playback files in the desired (programmed) or random order.
- The screen saver function is activated while same picture is displayed for more than 5 minutes except during slide show playback (See page 44.)
- The unit only can play back files with any of the following file extensions; ".jpg", ".jpeg", ".JPG", ".JPEG" and any uppercase and lowercase combination (such as ".Jpg").
- If a JPEG file name includes any 2-byte character, the unit may not show the file name correctly.
- When a picture resolution is more than "640 x 480", it takes some time to open the whole picture.
- Carry out an operation after opening the whole picture. The unit does not accept any operation (Stopping the unit, zooming in/out a picture etc.) while opening the picture.
- Time required for reading the disc contents differs with discs, depending on the numbers of Groups (folders) and files recorded, etc.
- If you play back a non-baseline JPEG file:  
The unit cannot display the still picture of the file. (the TV screen appears only in black.) In this case, other operations (such as stopping playback, selecting a file, etc.) are possible but may take a long time.
- While a JPEG disc is loaded, you cannot bring up any preference display (See page 47.)

# Basic operations

## To see a desired picture

Available : **JPEG**

When loading a JPEG disc, after the disc contents are read, the JPEG CONTROL display automatically appears on the TV screen.

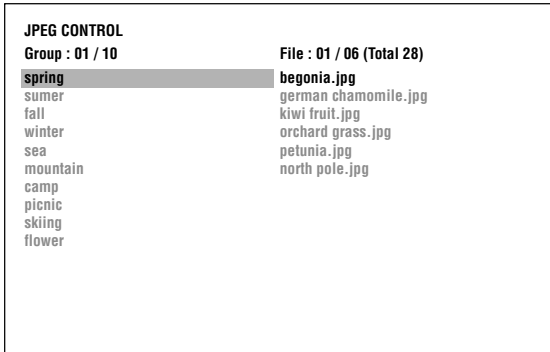

You can select a desired file for playback via this display.

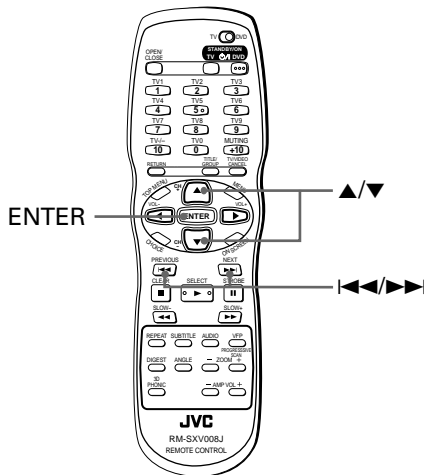

- When the JPEG CONTROL display is shown
  - 1 Make sure that the black (cursor) bar is in the left (Group) column.  
If it is in the right column, press ◀ to move it to the left column.
  - 2 Move the bar to a desired Group using ▲/▼.  
On the right column, files in the selected Group are shown.  
When selecting a Group, file 1 is initially selected (highlighted).

3 Select a desired file using ◀▶▶▶.

4 Press ENTER.

The selected file (still picture) is shown on the TV. In the display window, you can see the current Group and file numbers.

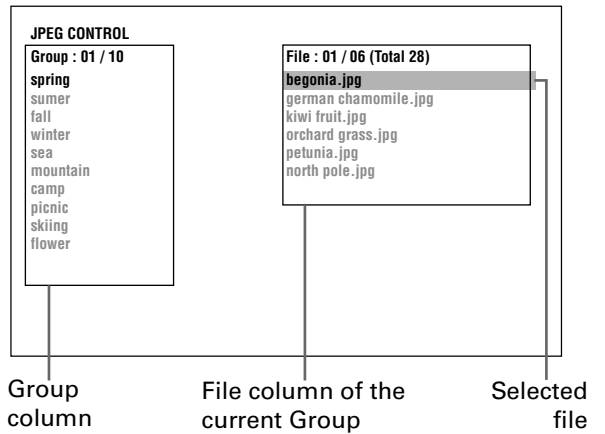

### Hints

- You can also select a desired file by pressing ▶ to move the black bar to the right (file) column then using ▲/▼.
- To return the black bar to the Group column, press ◀.
- **To playback another picture:**  
Use ◀▶▶▶ or ▲/▼ to select the desired picture. You can select a picture in another Group.
- **To dismiss the picture:**  
Press ■ or MENU.  
The TV screen returns to show the JPEG CONTROL display.

### NOTES

- The current Group and file number are also shown on the display window in the following manner.

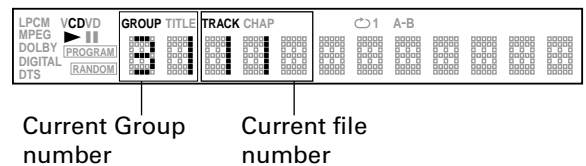

- Only JPEG files are shown on the display window.

## To zoom in/out the picture [ZOOM]

Available : **JPEG**

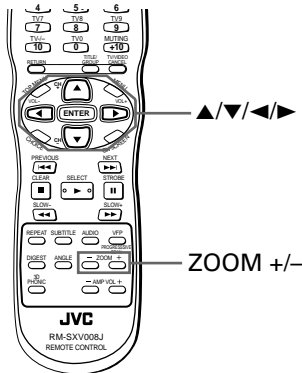

- During JPEG picture is shown on the TV screen

### 1 Press ZOOM + or -.

The unit zooms in by pressing ZOOM + or zooms out by pressing ZOOM -. Each time you press ZOOM +, the magnification is doubled (up to x 1024). Each time you press ZOOM -, the magnification is halved (down to x 1/8).

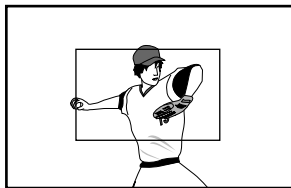

At the top-left of the screen, the information for the current magnification appears. While zoomed in, the indication for the zoomed-in position, which can be moved by operating the next step, appears together.

### 2 Use ▲/▼/◀/▶ to move the zoomed position.

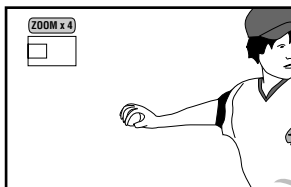

#### NOTES

- Even in the slide-show mode, you can zoom in or out a picture while paused (see the next column).
- To return to normal screen:  
Press ENTER.
- While zoomed, the picture may look coarse.

## To see pictures continuously [slide-show mode]

You can see files (still pictures) one after another automatically in the slide show mode. In this mode, each file (still picture) is shown on the TV for approximately 3 seconds and then automatically changed to the next file one after another.

## Playback pictures from the beginning of the disc

Available : **JPEG**

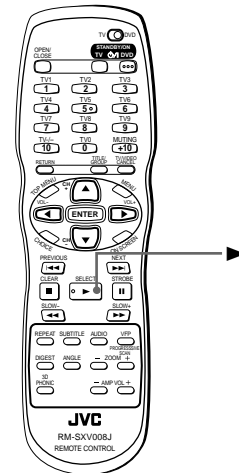

- After inserting a JPEG disc

### 1 Press ▶.

The slide show starts from the beginning of the disc.

#### NOTES

- To stop slide-show playback (to dismiss the picture) in the middle of the slide-show playback:  
Press ■ or MENU.  
The TV screen returns to show the JPEG CONTROL display.  
Pressing ▶ resumes slide show playback from the last picture you opened.
- To keep showing a current picture during the slide show  
Press || or ENTER.  
The picture does not change to the next picture.  
Pressing ▶ resumes the slide show playback from the next picture.
- If a black screen appears continuously in the slide-show playback:  
The file currently played may be non-baseline JPEG file. In this case, select a playable file (a baseline JPEG file) again (e.g., pressing ■ or MENU to open the JPEG CONTROL display, etc.)  
Note that it may take a long time to select another file.

## Selecting the start point of the slide show

Available : **JPEG**

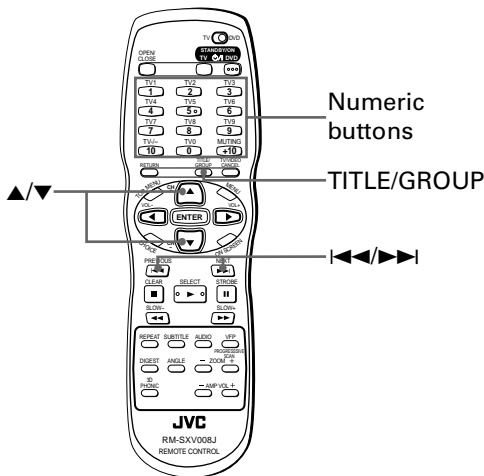

### From the JPEG CONTROL display

● During JPEG CONTROL display is shown

**1** Make sure that the black (cursor) bar is in the left (Group) column.

If it is in the right column, press ◀ to move it to the left column.

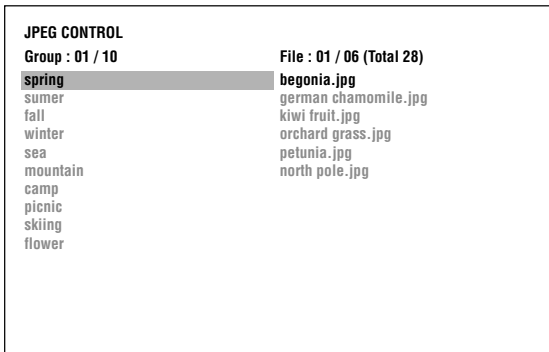

**2** Move the bar to a desired Group using ▲/▼.

On the right column, files in the selected Group are shown.

When selecting a Group, file 1 is initially selected (highlighted).

**3** Select a desired file using ◀▶.

**4** Press ▶.

The slide show starts from the specified file.

## Direct selection

● During playback or while stopped

**1** Press TITLE/GROUP.

"--" is shown in the Group display area of the display window.

(Example for the indication of display window)

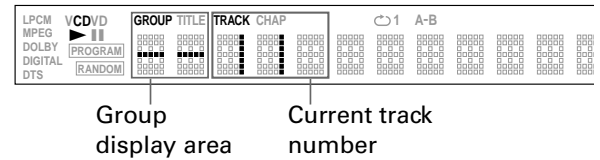

**2** Use the numeric buttons to specify a desired Group number.

- To select a number between 1 and 10:  
Press the corresponding button for the number.
- To select a number higher than 10:  
Use the +10 button.

Examples:

To select 13: +10 → 3

To select 34: +10 → +10 → +10 → 4

To select 40: +10 → +10 → +10 → 10

Specify the Group number within several seconds after pressing TITLE/GROUP (i.e. while the display window shows "--" for the Group number, instead of the current Group number).

**3** Use the numeric buttons to specify a desired Track number.

You can specify the Track number according to the order in the JPEG CONTROL display. You must specify a Track number within 5 seconds after carrying out step 2.

The unit starts slide show playback from the specified Track. If you do not specify a Track number, the unit starts slide show playback from the first Track in the Group.



- You can skip a file in the slide show by using ◀▶ or ▲/▼.
- You can select a file in the current group by using the numeric buttons.

### NOTES

- **To stop slide-show playback (to dismiss the picture) in the middle of the slide-show playback:**  
Press ■ or MENU.  
The TV screen returns to show the JPEG CONTROL display.  
Pressing ▶ resumes slide show playback from the last picture you opened.
- **To keep showing a current picture during the slide show**  
Press || or ENTER.  
The picture does not change to the next picture.  
Pressing ▶ resumes the slide show playback from the next picture.
- **If a black screen appears continuously in the slide-show playback:**  
The file currently played may be non-baseline JPEG file. In this case, select a playable file (a baseline JPEG file) again (e.g., pressing ■ or MENU to open the JPEG CONTROL display, etc.)  
Note that it may take a long time to select another file.

# Repeat function

Available : **JPEG**

In the slide-show mode, you can repeat playback of JPEG files in a Group or on the disc.

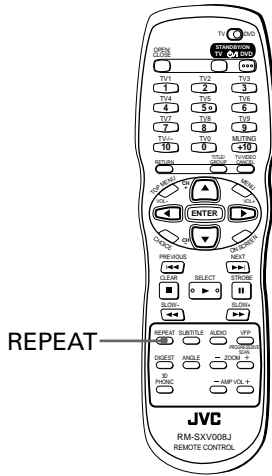

- **To stop repeat playback**  
Press **■**. Note that the repeat mode remains.
- **To quit repeat playback**  
During playback, press REPEAT as many times until no repeat icon is shown on the display window. While stopped, press REPEAT as many times until repeat mode indication on the JPEG CONTROL display goes off.

- During playback or while stopped

## 1 Press REPEAT.

Pressing REPEAT switches the repeat mode. If you press REPEAT while stopped, you need to press **▶** to start repeat playback. The mode is shown in the display window by icons, while on the JPEG CONTROL display by mode names, as follows.

JPEG CONTROL display	Display Window	Function
REPEAT ALL	↻	All tracks on the disc are repeated.
REPEAT GROUP		All Tracks in the current Group are repeated.
No indication		The repeat mode is off.

(TV Screen)

Selected repeat mode

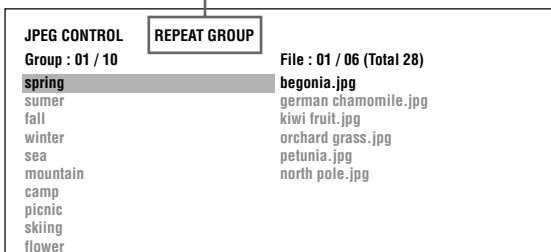

(Display window)



Repeat mode indicator

JPEG disc playback



**NOTE**



Make sure that the TV - DVD switch on the remote control unit is set to "DVD" when using the ▲/▼/◀/▶ and numeric buttons for controlling the unit.

## Selecting preferences

This chapter refers to the settings which are already made when you purchase the unit (when the machine is shipped from the factory). Read this section when you want to connect this machine to a wide-vision TV set or change the settings according to the environment you use this machine.

### About the Preference display

The preference display consists of the LANGUAGE, PICTURE, AUDIO, and OTHERS setting displays, each having setting items.

• **LANGUAGE**

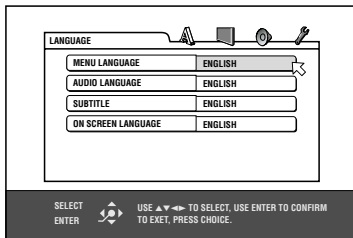

• **PICTURE**

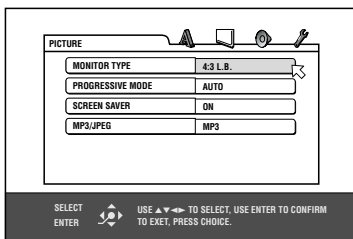

• **AUDIO**

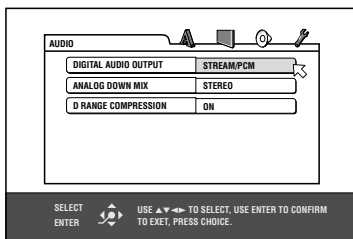

• **OTHERS**

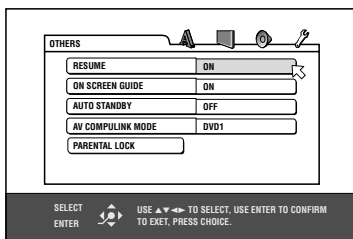

## How to set preferences

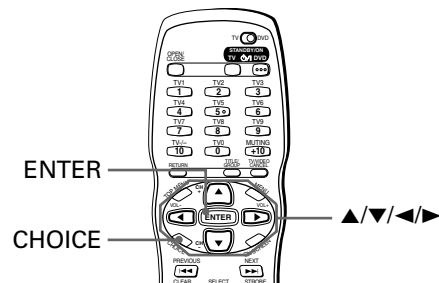

• While stopped

**1** Press CHOICE.

One of the Preference on-screen displays appears on the TV screen.

You can see four icons at the top right of the on-screen display for the settings.

- 🔊 : Setting menu for language
- 🖥️ : Setting menu for pictures
- 🔊 : Setting menu for sound
- 🔧 : Setting menu for the systems, etc.

**2** Select the appropriate icon using ◀/▶.

The appropriate display appears on the TV screen.

**3** Move ⏪ to select the item you want to edit by using ▲/▼.

The color of the selected item changes.

**4** Press ENTER.

The pull-down menu appears over the selected item.

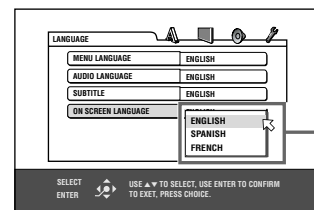

Selected item

**5** Press ▲/▼ to select from options and press ENTER.

The selected option is set.

- For details about each setting, see the following.

**NOTES**

- **To dismiss a preference display:**  
Press CHOICE.
- **While an MP3 or JPEG disc is loaded, you cannot bring up any preference display.**
- **When a preference display is shown on a wide TV screen, the upper and lower parts of the TV picture sometimes may be cut off. In such a case, adjust the picture size control of the TV.**

## LANGUAGE page

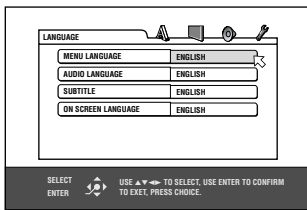

This page allows you to select languages concerning with DVD VIDEO disc playback, as well as the on-screen display language of the unit.

### NOTES

- During playback, you can bring up any page of the preference displays, however, only "ON SCREEN LANGUAGE" can be set on the "LANGUAGE" page.

Menu item	Setting options	Notes/examples
<b>MENU LANGUAGE</b> You can select the default menu language to be displayed if it is contained on a DVD VIDEO disc.	<b>ENGLISH ↔ SPANISH ↔ FRENCH</b> <b>↔ CHINESE ↔ GERMAN ↔</b> <b>ITALIAN ↔ JAPANESE ↔ language code from AA to ZU</b>	<ul style="list-style-type: none"> <li>• If the selected language is not recorded, the disc's default language is selected.</li> <li>• For details about language code, see "Table of languages and their abbreviations" at the bottom of this page.</li> </ul>
<b>AUDIO LANGUAGE</b> You can select the default audio language to be played if it is contained on a DVD VIDEO disc.		
<b>SUBTITLE</b> You can select the default subtitle language to be displayed if it is contained on a DVD VIDEO disc.	<b>OFF ↔ ENGLISH ↔ SPANISH ↔</b> <b>FRENCH ↔ CHINESE ↔ GERMAN</b> <b>↔ ITALIAN ↔ JAPANESE ↔</b> <b>language code from AA to ZU</b>	
<b>ON SCREEN LANGUAGE</b> You can select the on-screen display language of the unit.	<b>ENGLISH ↔ SPANISH ↔ FRENCH</b>	English <input type="text" value="ON SCREEN LANGUAGE"/> <input type="text" value="ENGLISH"/> Spanish <input type="text" value="IDIOMA EN PANTALLA"/> <input type="text" value="ESPAÑOL"/> French <input type="text" value="LANGUE D' ECRAN"/> <input type="text" value="FRANCAIS"/> <ul style="list-style-type: none"> <li>• Some on-screen messages are shown in English regardless of the setting.</li> <li>• You cannot change the on-screen language shown on the MP3 and JPEG CONTROL displays.</li> </ul>

### Table of languages and their abbreviations

AA	Afar	FA	Persian	KM	Cambodian	OM	(Afan) Oromo	SU	Sundanese
AB	Abkhazian	FI	Finnish	KN	Kannada	OR	Oriya	SV	Swedish
AF	Afrikaans	FJ	Fiji	KO	Korean (KOR)	PA	Panjabi	SW	Swahili
AM	Ameharic	FO	Faroese	KS	Kashmiri	PL	Polish	TA	Tamil
AR	Arabic	FY	Frisian	KU	Kurdish	PS	Pashto, Pushto	TE	Telugu
AS	Assamese	GA	Irish	KY	Kirghiz	PT	Portuguese	TG	Tajik
AY	Aymara	GD	Scots Gaelic	LA	Latin	QU	Quechua	TH	Thai
AZ	Azerbaijani	GL	Galician	LN	Lingala	RM	Rhaeto-Romance	TI	Tigrinya
BA	Bashkir	GN	Guarani	LO	Laothian	RN	Kirundi	TK	Turkmen
BE	Byelorussian	GU	Gujarati	LT	Lithuanian	RO	Rumanian	TL	Tagalog
BG	Bulgarian	HA	Hausa	LV	Latvian, Lettish	RU	Russian	TN	Setswana
BH	Bihari	HI	Hindi	MG	Malagasy	RW	Kinyarwanda	TO	Tonga
BI	Bislama	HR	Croatian	MI	Maori	SA	Sanskrit	TR	Turkish
BN	Bengali, Bangla	HU	Hungarian	MK	Macedonian	SD	Sindhi	TS	Tsonga
BO	Tibetan	HY	Armenian	ML	Malayalam	SG	Sangho	TT	Tatar
BR	Breton	IA	Interlingua	MN	Mongolian	SH	Serbo-Croatian	TW	Twi
CA	Catalan	IE	Interlingue	MO	Moldavian	SI	Singhalese	UK	Ukrainian
CO	Corsican	IK	Inupiak	MR	Marathi	SK	Slovak	UR	Urdu
CS	Czech	IN	Indonesian	MS	Malay (MAY)	SL	Slovenian	UZ	Uzbek
CY	Welsh	IS	Icelandic	MT	Maltese	SM	Samoan	VI	Vietnamese
DA	Danish	IW	Hebrew	MY	Burmese	SN	Shona	VO	Volapuk
DZ	Bhutani	JL	Yiddish	NA	Nauru	SO	Somali	WO	Wolof
EL	Greek	JW	Javanese	NE	Nepali	SQ	Albanian	XH	Xhosa
EO	Esperanto	KA	Georgian	NL	Dutch	SR	Serbian	YO	Yoruba
ET	Estonian	KK	Kazakh	NO	Norwegian	SS	Siswati	ZU	Zulu
EU	Basque	KL	Greenlandic	OC	Occitan	ST	Sesotho		

# PICTURE page

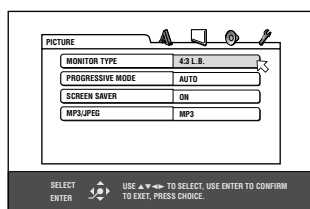

This page allows you to select desired options concerning with a picture or monitor screen.

Menu item	Setting options	Notes/examples
<p><b>MONITOR TYPE</b> You can select the monitor type to match your TV when you playback DVD VIDEO discs recorded for wide screen televisions.</p>	<ul style="list-style-type: none"> <li> <p><b>16:9 NORMAL (Wide Television screen)</b> Should be selected when you connect the unit to a wide-screen (16:9) TV whose aspect ratio is fixed to 16:9 (the unit automatically adjusts the screen width of the output signal correctly when playing back a "4:3" source).</p> </li> <li> <p><b>16:9 AUTO (Wide Television screen)</b> Should be selected when you connect a wide-screen (16:9) TV to the unit.</p> </li> <li> <p><b>4:3 LB. (Letter Box Conversion)</b> Should be selected when you connect a normal (4:3) TV to the unit. When playing back a DVD VIDEO disc recorded by the wide picture format, the picture is shown with black bars at the top and bottom.</p> </li> <li> <p><b>4:3 PS. (Pan Scan Conversion)</b> Should be selected when you connect a normal(4:3) TV to the unit. When playing back a DVD VIDEO disc recorded by the wide picture format, the picture is automatically zoomed and the left and right sides are chopped off.</p> </li> </ul>	<div data-bbox="1058 533 1372 712" style="text-align: center;"> </div> <ul style="list-style-type: none"> <li> <p>If you playback a "4:3" DVD VIDEO source with the "16:9 NORMAL" mode, the picture character slightly changes due to the process for converting the picture width.</p> </li> </ul> <div data-bbox="1058 958 1298 1142" style="text-align: center;"> </div> <div data-bbox="1058 1220 1298 1400" style="text-align: center;"> </div> <ul style="list-style-type: none"> <li> <p>With some discs recorded by the wide picture format, the picture is shown in the 4:3 LB mode even if you select the 4:3 PS mode.</p> </li> </ul>
<p><b>PROGRESSIVE MODE</b> When the unit is in the progressive scan mode, you can select a desired mode from three options. Normally, set to "AUTO".</p>	<ul style="list-style-type: none"> <li> <p><b>VIDEO</b> Suitable for playing back a video source disc.</p> </li> <li> <p><b>FILM</b> Suitable for playing back a film or progressive source disc.</p> </li> <li> <p><b>AUTO</b> Used to playback a disc containing both video and film source materials. The unit recognizes the picture type (film or video source) of the current disc according to the disc information.</p> </li> </ul>	<ul style="list-style-type: none"> <li> <p>When progressive scan mode is active, the PROGRESSIVE indicator is lit. Note that the color of indication changes depending on this setting, source type and the unit's status. (See pages 7 and 8.)</p> </li> <li> <p>Some DVD VIDEO discs may not be played back correctly with the "AUTO" mode. If the playback picture is unclear or noisy with a particular DVD VIDEO disc, try to change the mode</p> </li> </ul>

Menu item	Setting options	Notes/examples
<b>SCREEN SAVER</b> You can select the screen saver function ON or OFF. See page 15 for details about screen saver function.	<ul style="list-style-type: none"> <li>• <b>ON</b> The current picture gets dark.</li> </ul>	
	<ul style="list-style-type: none"> <li>• <b>OFF</b> The screen saver function is off.</li> </ul>	
<b>MP3/JPEG</b> The unit can playback MP3 and JPEG files recorded on a CD-R/CD-RW disc, however, if a disc contains both of MP3 and JPEG files, you can only playback files of either type selected by this menu item.	<ul style="list-style-type: none"> <li>• <b>MP3</b> MP3 files can be played back if a disc contains both of MP3 and JPEG files.</li> </ul>	<ul style="list-style-type: none"> <li>• When a disc contains either MP3 or JPEG files, the unit can play back the files regardless of the setting.</li> </ul>
	<ul style="list-style-type: none"> <li>• <b>JPEG</b> JPEG files can be played back if a disc contains both of MP3 and JPEG files.</li> </ul>	

## AUDIO page

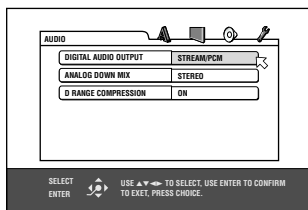

This page allows you to select desired options concerning with audio sound.

Menu item	Setting options	Notes/examples
<b>DIGITAL AUDIO OUTPUT</b> To connect the unit's digital output to an external device equipped with a digital input, this item must be set correctly. See the table below for details about the relation between the setting and output signals.	<ul style="list-style-type: none"> <li>• <b>PCM ONLY</b> Should be selected when you connect the DIGITAL OUT jack of the unit to the linear PCM digital input of other audio equipment.</li> </ul>	<ul style="list-style-type: none"> <li>• When playing a DVD VIDEO or Audio CD disc with DTS, use a DTS decoder to get correct signals from your speakers.</li> <li>• With some DVD VIDEO discs that are not fully copy-protected, a 20 or 24 bit digital signal may be output.</li> <li>• A signal with the 88.2 kHz or more sampling frequency cannot be output from the DIGITAL OUT jack, regardless of the setting (due to the copy protection issue).</li> <li>• MP3 digital audio data cannot be output.</li> </ul>
	<ul style="list-style-type: none"> <li>• <b>DOLBY DIGITAL/PCM</b> Should be selected when you connect the digital input of a Dolby Digital decoder or an amplifier with a built-in Dolby Digital decoder. When this option is selected, playing back a disc recorded by the DTS or MPEG Multichannel format outputs a linear PCM digital signal.</li> </ul>	
	<ul style="list-style-type: none"> <li>• <b>STREAM/PCM</b> Should be selected when you connect the digital input of an amplifier with a built-in DTS, MPEG Multichannel or Dolby Digital decoder, or the stand-alone unit of such a decoder.</li> </ul>	

## Digital output signal chart

Playback discs	Output		
	PCM ONLY	DOLBY DIGITAL/PCM	STREAM/PCM
DVD with 48/44.1 kHz, 16/20/24 bit linear PCM	48/44.1 kHz, 16 bit, stereo linear PCM		
DVD with 96/88.2 kHz, 16/22/24 bit linear PCM	No output		
DVD with DTS	48 kHz, 16 bit, stereo linear PCM		DTS bitstream
DVD with Dolby Digital	48 kHz, 16 bit, stereo linear PCM	Dolby Digital bitstream	
DVD with MPEG Multichannel	48 kHz, 16 bit, stereo linear PCM		MPEG bitstream
Audio CD/Video CD/SVCD	44.1 kHz, 16 bit, stereo linear PCM		
Audio CD with DTS	44.1 kHz, 16 bit, stereo linear PCM		DTS bitstream
CD-R/RW with MP3	No output		

Menu item	Setting options	Notes/examples
<p><b>ANALOG DOWN MIX</b> To playback a DVD VIDEO disc recorded with surround multichannel audio correctly, this setting must be properly made according to your audio system.</p>	<ul style="list-style-type: none"> <li>• <b>DOLBY SURROUND</b> Should be selected when you enjoy multichannel surround audio by connecting the unit's analog AUDIO OUT to a surround decoder.</li> </ul> <hr/> <ul style="list-style-type: none"> <li>• <b>STEREO</b> Should be selected when you enjoy conventional 2-channel stereo audio by connecting the unit's analog AUDIO OUT to a stereo amplifier/receiver or television set, or when you duplicate audio of a DVD VIDEO disc recorded with surround audio to your MD, cassette, etc.</li> </ul>	<ul style="list-style-type: none"> <li>• This function does not work when the 3D PHONIC function is activated. (See page 34.)</li> <li>• This setting affects only the output signal from the analog AUDIO OUT jacks when playing back a DVD VIDEO disc recorded with surround multichannel audio.</li> </ul>
<p><b>D. RANGE COMPRESSION</b> When enjoying a DVD VIDEO disc recorded with the Dolby Digital format at low or middle volume, this setting makes you hear sound comfortably</p>	<ul style="list-style-type: none"> <li>• <b>AUTO</b> Audio is played back with the dynamic range compressed except when playing a disc recorded with Dolby Digital 1- or 2-channel format.</li> </ul> <hr/> <ul style="list-style-type: none"> <li>• <b>ON</b> Audio is always played back with the dynamic range compressed.</li> </ul>	<ul style="list-style-type: none"> <li>• This function works only when playing back a disc recorded with Dolby Digital. The setting is not effective for other discs.</li> <li>• This function does not work when the 3D PHONIC function is activated. (See page 34.)</li> </ul>

## OTHERS page

This page allows you to select desired options concerning with the system.

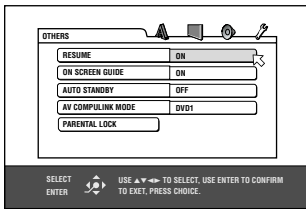

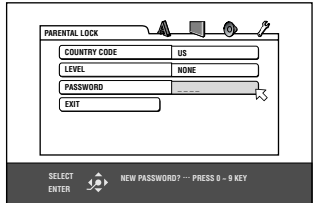
Menu item	Setting options	Notes/examples
<p><b>RESUME</b> You can select the resume playback mode.</p>	<ul style="list-style-type: none"> <li><b>ON</b> The unit can resume playback of the disc from the position you interrupted playback last time if it is still on the tray.</li> <li><b>OFF</b> The resume function is not active.</li> <li><b>DISC RESUME</b> The unit can resume playback of last 30 discs (the unit keeps memory positions even if a disc is removed from the tray).</li> </ul>	<ul style="list-style-type: none"> <li>See page 17 for details about resume playback function.</li> </ul>
<p><b>ON SCREEN GUIDE</b> The unit can display "on-screen guide" icons or characters on the picture, which show what is happening to the disc or the unit.</p>	<ul style="list-style-type: none"> <li><b>ON</b> The on-screen guide will be displayed.</li> <li><b>OFF</b> The on-screen guide will not be displayed.</li> </ul>	<ul style="list-style-type: none"> <li>See page 15 about on-screen guide icons.</li> <li>Examples of "on-screen guide" icons or characters: </li> </ul>
<p><b>AUTO STANDBY</b> When the unit is stopped for more than 30 minutes or 60 minutes, the unit enters standby mode automatically.</p>	<b>OFF ↔ 60 ↔ 30</b>	
<p><b>AV COMPU LINK MODE</b> If you use the AV COMPU LINK system, you must set this item correctly.</p>	<b>DVD 1 ↔ DVD 2 ↔ DVD 3</b>	<ul style="list-style-type: none"> <li>See page 58 for details about AV COMPU LINK function.</li> </ul>
<p><b>PARENTAL LOCK</b> When selecting this option, pressing ENTER on the remote control unit brings up the "PARENTAL LOCK" display shown below, in which you can restrict playback of DVD VIDEO discs for children.</p>	See page 53 for details about the Parental Lock setting.	<p>(PARENTAL LOCK display)</p> 

# Limiting playback by children

This function restricts playback of DVD VIDEO discs which contain violent (and other) scenes according to the level set by the user. For example, if a movie which includes violent scenes supports the parental lock feature, such scenes which you do not want to let children view can be cut or replaced with other scenes. When selecting "PARENTAL LOCK" in the "OTHERS" page of the preference display (see page 52), pressing ENTER on the remote control unit brings up the PARENTAL LOCK sub-page shown below, in which you can make setting for limiting playback.

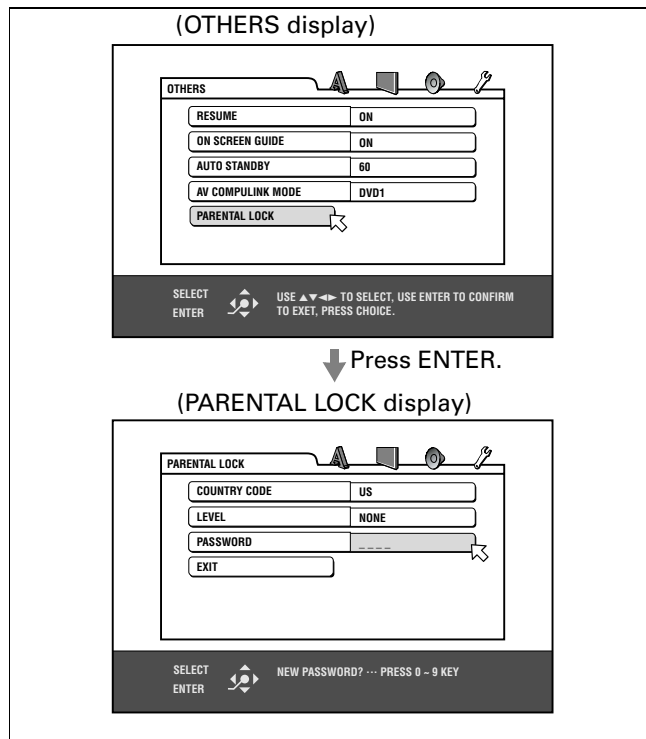

## To set Parental Lock for the first time [PARENTAL LOCK]

Available :

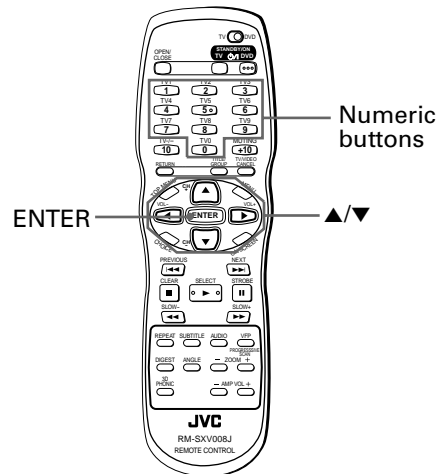

- While the "OTHERS" page of the preference display is shown

1 Use ▲/▼ to move to select "PARENTAL LOCK" and press ENTER.

See page 52 for details about how to bring up the "OTHERS" page.

The Parental Lock on-screen display appears on the TV screen.

points [COUNTRY CODE].

2 While points [COUNTRY CODE], press ENTER to bring up the pull-down menu.

3 Use ▲/▼ to select the country code.

The country code whose standards were applied to rate the DVD VIDEO disc should be selected.

See "Appendix A: Country code list for Parental Lock" on page 63.

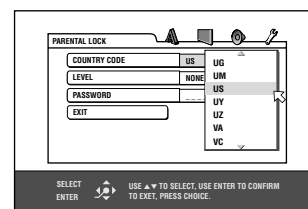

4 Press ENTER.

moves to [SET LEVEL].

**5** While  points [LEVEL], press ENTER to bring up the pull-down menu.

In the pull-down menu, "NONE" and level "1" through "8" are available.

"NONE" does not restrict playback. Level "1" is the strictest level. Discs rated higher than the selected level are restricted.

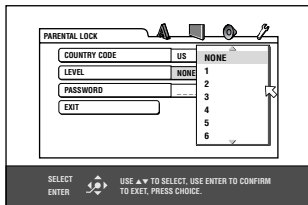

**6** Use ▲/▼ to select a desired parental lock level, then press ENTER.

 moves to [PASSWORD].

**7** Enter your 4-digit password using the numeric buttons (0 to 9).

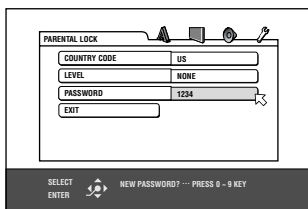

**8** Press ENTER.

The setting is set.

 moves to [EXIT].

Pressing ENTER again returns to the "OTHERS" page of the preference display.

 Hints

- If you enter an undesired password in step 7, reenter the password before pressing ENTER.

## To change the settings [PARENTAL LOCK]

Available : 

You can change the Parental Lock settings later.

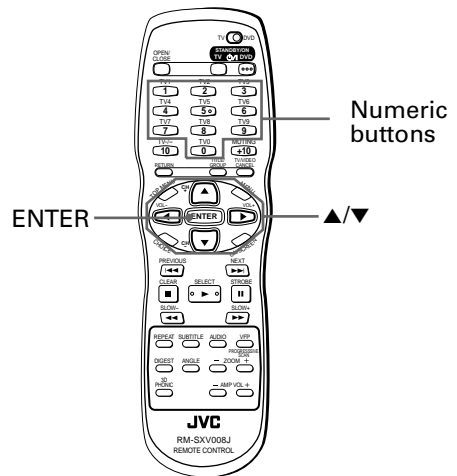

- While the "OTHERS" page of the preference display is shown

**1** Use ▲/▼ to move  to select "PARENTAL LOCK" and press ENTER.

The Parental Lock on-screen display appears on the TV screen.

 points [PASSWORD].

See page 52 for details about how to bring up the "OTHERS" page.

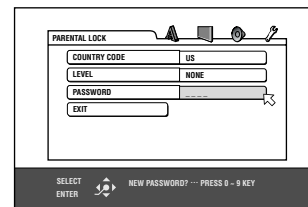

**2** Enter your current 4-digit password using the numeric buttons (0 to 9) and press ENTER.

 moves to [COUNTRY CODE] if you enter the correct password.

If you enter the wrong password, "WRONG! RETRY..." appears on the TV screen, and you cannot go to the next step.



- 3** To change the "COUNTRY CODE" or "LEVEL", press ENTER to bring up the associated pull-down menu while  points the appropriate item.

To select the item to be set, use ▲/▼ when no pull-down menu is shown.

- 4** Use ▲/▼ to select a desired option and press ENTER.

Note that if you change the country code, you must reselect the Parental Lock level.

- 5** While  points [PASSWORD], enter a 4-digit password using the numeric buttons (0 to 9).

The password entered in the above step becomes the new password. If you do not change the password, enter the same password as in the step 2. Even if you want to change only the country code and/or parental level, do not forget to enter the password after changing the country code and/or parental level. Otherwise, the new country code and/or parental level will not become effective.

- 6** Press ENTER.

 moves to [EXIT].

Pressing ENTER again returns to the "OTHERS" page of the preference display.

#### NOTES

- If you enter the wrong password more than 3 times in step 2 above,  moves to [EXIT] automatically and ▲/▼ does not work.
- If you forget your password in step 2  
Enter "8888." The current password is deleted and you can set a new password.

## To temporarily release the Parental Lock [PARENTAL LOCK]

Available : 

When you set the parental level strictly, some discs may not be played back at all. When you insert such a disc and try to play it, the following Parental Lock on-screen display appears on the TV screen, asking you whether you want the Parental Lock to be temporarily released or not.

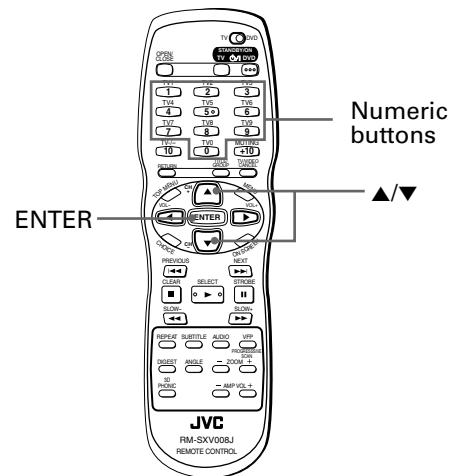

- 1** Use the ▲/▼ to move  to [TEMPORARY RELEASE], then press ENTER.

 moves to the [PASSWORD].

When selecting [NOT RELEASE], press ▲ (OPEN/CLOSE) to remove the disc.

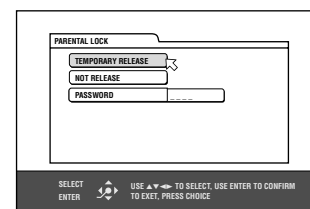

- 2** Enter your 4-digit password using the numeric buttons (0 to 9).

The Parental Lock is released, and the unit starts playback.

If you enter the wrong password, "WRONG! RETRY..." appears on the TV screen.

Enter the correct password.

#### NOTE

- When you enter the wrong password more than 3 times in step 2 above,  moves to [NOT RELEASE] automatically and ▲/▼ do not work.

## Names of parts and controls

Refer to the corresponding pages indicated in ( ) for details.

### Front panel

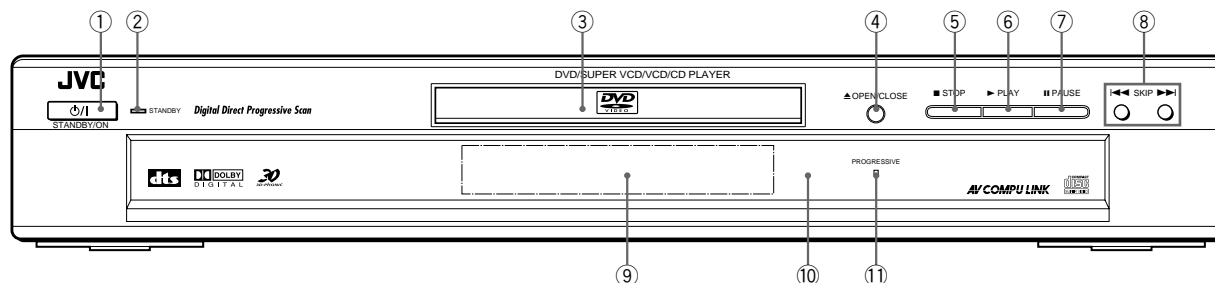

- |                                    |  |
|------------------------------------|--|
| ① STANDBY/ON button (12)           | ⑦    PAUSE button (15, 18)                     |
| ② STANDBY indicator (9, 12)        | ⑧ ◀▶ SKIP buttons (18, 19)                     |
| ③ Disc tray (14, 16, 17)           | ⑨ Display windows (see the illustration below) |
| ④ ▲ OPEN/CLOSE button (14, 16, 17) | ⑩ Remote sensor (10)                           |
| ⑤ ■ STOP button (15, 16, 39)       | ⑪ PROGRESSIVE indicator (12, 49)               |
| ⑥ ▶ PLAY button (15, 17)           |  |

### Display window

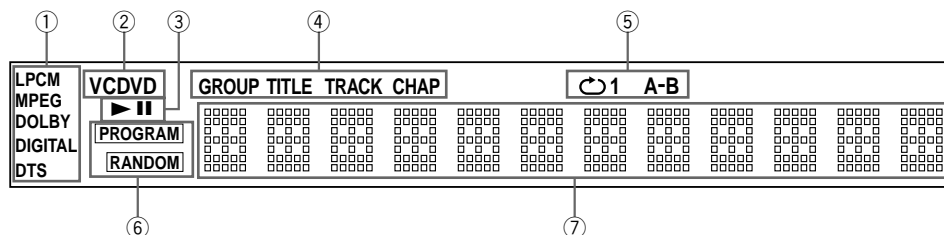

- |  |                                       |
|--|---------------------------------------|
| ① Audio format indicators              | ⑤ Repeat mode indicators (27, 41, 46) |
| ② Disc indicator                       | ⑥ PROGRAM/RANDOM indicators (25, 26)  |
| ③ ▶ (play)/II (pause) indicators       | ⑦ Multi-information window            |
| ④ Group/title/track/chapter indicators |                                       |

### Rear panel

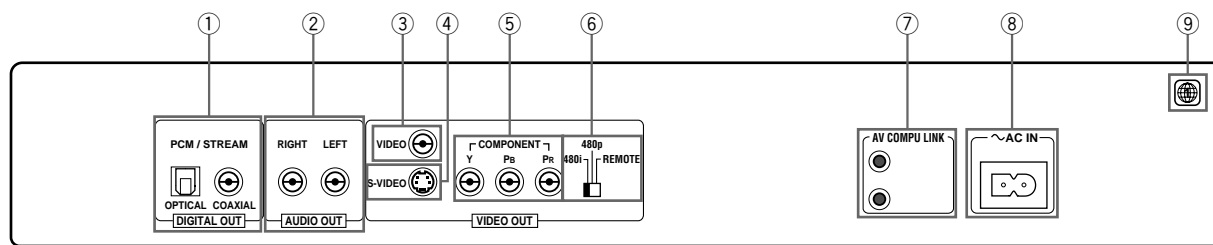

- |   |   |
|---|---|
| ① DIGITAL OUT jacks (OPTICAL/COAXIAL) (9)   | ⑥ Scan mode selector (480i/480p/REMOTE) (6, 7, 8) |
| ② AUDIO OUT jacks (6, 7, 8, 9)              | ⑦ AV COMPU LINK jacks (58)                        |
| ③ VIDEO OUT - VIDEO jack (6)                | ⑧ ~ AC IN connector (9)                           |
| ④ VIDEO OUT - S-VIDEO jack (6)              | ⑨ Region code label (4)                           |
| ⑤ VIDEO OUT - COMPONENT jacks (Y/Pb/Pr) (7) |   |

## Remote control unit

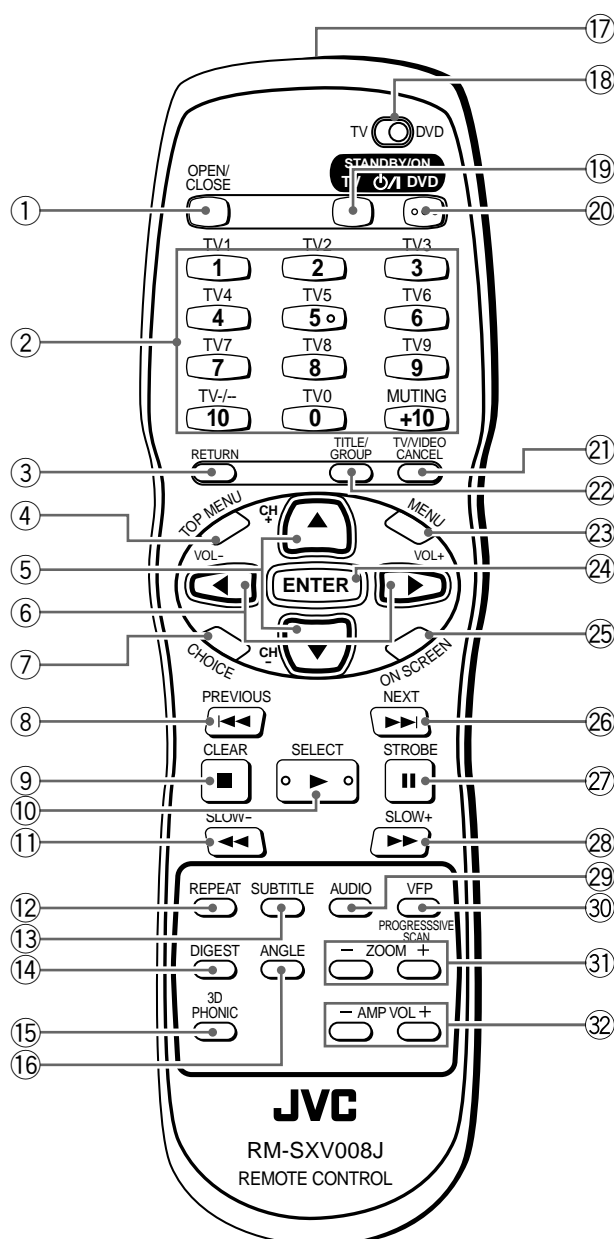

- |   |   |
|---|---|
| ① OPEN/CLOSE button (14, 16, 17)                              | ⑩ ▶/SELECT button (15, 22, 39, 44)      |
| ② Numeric buttons   | ⑪ ◀◀/SLOW- button (18)                  |
| ③ RETURN button (23)  | ⑫ REPEAT button (27, 41, 46)            |
| ④ TOP MENU button (22)  | ⑬ SUBTITLE button (29)                  |
| ⑤ Cursor selection (▲ Up, ▼ Down) - CH (+/-) buttons (11)     | ⑭ DIGEST button (24)                    |
| ⑥ Cursor selection (◀ Left, ▶ Right) - VOL (+/-) buttons (11) | ⑮ 3D PHONIC button (34)                 |
| ⑦ CHOICE button (13, 47)                                      | ⑯ ANGLE button (21, 31)                 |
| ⑧ ◀◀/PREVIOUS button (18, 19, 39, 43)                         | ⑰ Infrared signal-emitting window (10)  |
| ⑨ ■/CLEAR button (15, 16, 26, 39, 46)                         | ⑱ TV STANDBY/ON button (11)             |
| ⑩ ▶/SELECT button (15, 22, 39, 44)                            | ⑲ TV STANDBY/ON button (11)             |
| ⑪ ◀◀/SLOW- button (18)  | ⑳ DVD STANDBY/ON button (12)            |
| ⑫ REPEAT button (27, 41, 46)                                  | ㉑ TV/VIDEO - CANCEL button (11, 22, 26) |
| ⑬ SUBTITLE button (29)  | ㉒ TITLE/GROUP button (23, 41, 45)       |
| ⑭ DIGEST button (24)  | ㉓ MENU button (22)                      |
| ⑮ 3D PHONIC button (34)                                       | ㉔ ENTER button                          |
| ⑯ ANGLE button (21, 31)                                       | ㉕ ON SCREEN button (20, 35)             |
| ⑰ Infrared signal-emitting window (10)                        | ㉖ ▶▶/NEXT button (18, 19, 39, 43)       |
| ⑱ TV STANDBY/ON button (11)                                   | ㉗   /STROBE button (15, 18, 18, 32, 39) |
| ⑲ TV STANDBY/ON button (11)                                   | ㉘ ▶▶/SLOW+ button (18)                  |
| ⑳ DVD STANDBY/ON button (12)                                  | ㉙ AUDIO button (30)                     |
| ㉑ TV/VIDEO - CANCEL button (11, 22, 26)                       | ㉚ VFP - PROGRESSIVE SCAN button (8, 33) |
| ㉒ TITLE/GROUP button (23, 41, 45)                             | ㉛ ZOOM +/- buttons (32, 44)             |
| ㉓ MENU button (22)  | ㉜ AMP VOL +/- buttons (11)              |
| ㉔ ENTER button  |   |
| ㉕ ON SCREEN button (20, 35)                                   |   |
| ㉖ ▶▶/NEXT button (18, 19, 39, 43)                             |   |
| ㉗   /STROBE button (15, 18, 18, 32, 39)                       |   |
| ㉘ ▶▶/SLOW+ button (18)  |   |
| ㉙ AUDIO button (30)   |   |
| ㉚ VFP - PROGRESSIVE SCAN button (8, 33)                       |   |
| ㉛ ZOOM +/- buttons (32, 44)                                   |   |
| ㉜ AMP VOL +/- buttons (11)                                    |   |

# AV COMPU LINK remote control system

The JVC AV COMPU LINK system allows you to enjoy video or audio with the simplest operation. If your video/audio player (such as a DVD player, CD player and VCR) and television or/and amplifier/receiver support the JVC AV COMPU LINK system and are tied with the JVC AV COMPU LINK cable(s), when you simply starting the player, all the necessary settings of the television and/or amplifier/receiver for enjoying playback are automatically performed.



## Connection and setup

Using the AV COMPU LINK cable, connect the AV COMPU LINK terminals of each component to one another.

- The unit's AV COMPU LINK setting is operated in the OTHERS page in the preference display. See page 52 for operation.
- For information on the connection between the TV and the receiver, refer to the receiver's Instructions.

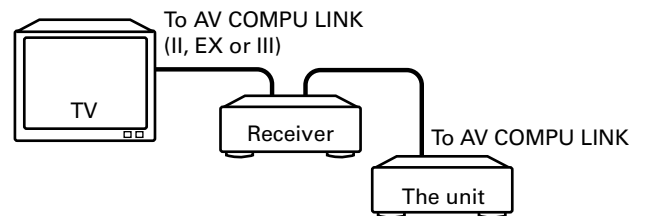

- If you connect the unit to a television and receiver via AV COMPU LINK, set the unit's AV COMPU LINK setting to DVD1.

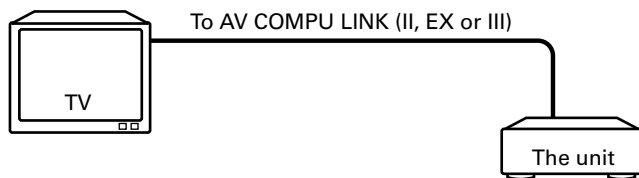

- If you connect the unit to a television via AV COMPU LINK, set the unit's AV COMPU LINK setting as follows.
  - When connecting to VIDEO-1 input terminal of the television: DVD2
  - When connecting to VIDEO-2 input terminal of the television: DVD3

### IMPORTANT!

- When you make video connection between the unit and another device (such as a receiver and TV) via the composite, S-video or component jacks, as well as AV COMPU LINK connection, see also the instruction manual of the other device.

### Notes for connection

- If you connect the unit to a receiver via AV COMPU LINK in a system including a Dolby Digital decoder, some functions may not be performed automatically.
- Connect the AUDIO OUT jacks of the unit to the audio input jacks of a receiver that indicating "DVD". Otherwise, the system will not work correctly.
- There may be no description about connections to the unit in the instruction manual of a television or VCR. However a television or VCR with AV COMPU LINK terminals indicating "II", "EX" or "III" can be connected to the unit.

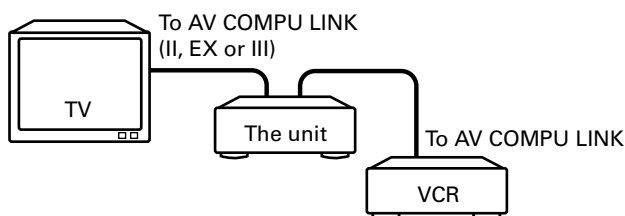

- If you connect the unit to a television and VCR via AV COMPU LINK, set the VCR's Remote Control Code and the unit's AV COMPU LINK setting as follows.
  - When connecting to VIDEO-1 input terminal of the television:  
The unit's AV COMPU LINK setting: DVD2  
VCR's Remote Control Code: B
  - When connecting to VIDEO-2 input terminal of the television:  
The unit's AV COMPU LINK setting: DVD3  
VCR's Remote Control Code: A

## Operation

You can enjoy pictures and/or sound by just putting a source component (which plays back the pictures and/or sound such as a DVD player or VCR) into play mode. You do not have to operate the TV and receiver including not having to perform power switching.

- 1 Turn on the main power of the television.
- 2 Insert a disc (or tape) into the source component.
- 3 Press ► of the source component.

The following actions are performed automatically:

- Turning on the power for the television.
- Setting the source of the television to the external input (VIDEO-1 or VIDEO-2).
- Turning on the power for the receiver.
- Setting the source of the receiver to the component which has started playback.

# Troubleshooting

What appears to be a malfunction may not always be serious. Please go through the following list before requesting service.

POWER		
Symptom	Possible cause	Remedy
Power does not come on.	Power plug is not inserted securely.	Plug in securely.
OPERATION		
Symptom	Possible cause	Remedy
The remote control unit does not work.	Too far from the unit.	More closer to the unit.
	The tip of the remote control unit is not pointed in the right direction.	Point the infrared light- emitting window toward the remote sensor on the front panel. (See page 10.)
	Batteries are exhausted.	Replace the batteries with new ones.
	Battery polarity is incorrect.	Take out the batteries and insert them again in the correct direction.
	The remote control unit is not set for operating your TV.	Set the remote control unit for operating your TV. (See page 12.)
The TV/VIDEO - CANCEL, ▲/▼/◀/▶ or numeric buttons do not work.	The TV - DVD switch is not correctly set.	To control the unit, set the TV - DVD switch to "DVD". To control your TV, set the TV - DVD switch to "TV". (See page 11.)
Operation is not possible.	Microcomputer malfunction due to lightning or static electricity.	Turn off the power and unplug the power cord, then connect the power cord again.
	Moisture condensation caused by a sudden change of temperature or humidity.	Turn off the power, then turn it on a few hours later.
	The disc does not allow the operation. Or a non-playable disc is loaded.	Check and replace the disc. (See page 4.)
When using the TITLE/GROUP button to select a title during DVD VIDEO playback, ⊙ appears on the TV screen and the title cannot be selected.	The disc does not allow the operation because of disc contents.	Try to press ■ and select a title using the numeric buttons on the remote control

<b>PICTURE</b>		
<b>Symptom</b>	<b>Possible cause</b>	<b>Remedy</b>
No picture is displayed on the monitor.	Connection of video cable is incorrect.	Connect the cable correctly.
	Input selection of TV is incorrect.	Select correctly.
	Disc is not playable.	Use a playable disc. (See page 4.)
No picture is displayed on the monitor or the screen is blurred or divided into two parts.	The unit is in the progressive scan mode (i.e. the PROGRESSIVE indicator is lit) though it is connected to a TV via the VIDEO or S-VIDEO jack.	Set the Scan mode selector on the rear panel to "480i", or set it to "REMOTE" and make the Progressive scan mode inactive by using the VFP-PROGRESSIVE SCAN button (see pages 7 and 8).
A picture is noisy or blurred.	The unit is connected to a VCR directly and the copyguard function is activated.	Connect the unit so that the picture signal flows directly to the TV.
	With some discs, a picture may be blurred when setting "PROGRESSIVE MODE" to "FILM" or "AUTO".	Set "PROGRESSIVE MODE" to "VIDEO". (See page 49.)
A picture does not fit the television screen.	MONITOR TYPE is not correctly set.	Select monitor type correctly. (See page 49.)
	Television is not correctly set.	Set the television correctly.
The upper and lower parts of the preference display are cut off when using wide-aspect TV.	It depends on the setting on the TV.	Adjust the TV screen using the control on the TV.
<b>AUDIO</b>		
<b>Symptom</b>	<b>Possible cause</b>	<b>Remedy</b>
No audio is reproduced.	Connection is incorrect.	Check the connection.
	Input selection of amplifier is incorrect.	Select correctly.
No audio is reproduced when playing back a DVD disc recorded with High-sampling (88.2 kHz or more) linear PCM audio using the DIGITAL OUT jack.	The audio signal is not derived from the unit's DIGITAL OUT. (See page 50.)	Use AUDIO OUT when playing back such discs.
Audio volume is low when playing back the unit, compared with the TV or VCR.	The audio level recorded on a DVD VIDEO is lower, compared with TV broadcasting.	Turn up the volume of the TV or amplifier/receiver. Note that you should turn down the volume before switching back to TV broadcasting, to prevent outputting the sudden big sound.
Sound is distorted or noise is generated.	Disc is dirty.	Wipe the disc surface. (See page 5.)

## Frequently Asked Questions

Question	Answer	Ref. page
Can I play back DVD VIDEO and Video CD purchased abroad?	You can play back the DVD VIDEO discs with the Region Code (local code) containing 'ALL' or '1' recorded in the NTSC or PAL system (PAL disc signals are reproduced by converting to the NTSC system). You can also play back the Video CD discs recorded in the NTSC system. Please check the information on each disc jacket.	4
Can I play back a DVD VIDEO disc without any Region Code number?	The Region code indicates the conformity of the disc to the standards. Any DVD VIDEO not conforming to the standards cannot be played back.	4
Can I play back a CD-R/RW disc with still pictures in other than the JPEG format?	No, you cannot play back that disc.	4
Can I play back audio on a disc labeled "Dolby Digital EX"?	Yes, you can play back the disc because Dolby Digital EX is compatible with Dolby Digital. However, to get the maximum performance of Dolby Digital EX, we recommend to connect the DIGITAL OUT jack to a decoder or amplifier/receiver with built-in decoder that supports Dolby Digital EX. In this case, set "DIGITAL AUDIO OUTPUT" on the "AUDIO" preference display to "STREAM/PCM".	50
Can I play back audio on a disc labeled "DTS ES"? Is there any difference in the playback settings between Discrete and Matrix recording systems for DTS ES?	Though you cannot enjoy audio using the analog audio outputs (AUDIO OUT), you can enjoy DTS ES audio by connecting the DIGITAL OUT jack to a decoder or amplifier/receiver with built-in decoder that supports DTS ES. In this case, set "DIGITAL AUDIO OUTPUT" on the "AUDIO" preference display to "STREAM/PCM".	50
Can this unit play back a disc labeled "THX"? What does "THX" mean?	Yes you can. "THX" is a name of the original standard for high quality picture/audio recording and playback established by Lucasfilm Ltd. A disc labeled "THX" is certified that it passed this standard.	—
When files of the MP3 and Audio CD formats are recorded on a same disc, can the unit play back files of both formats?	The disc is of the data CD format, therefore, the unit can play back only files of the MP3 format.	4, 39
Some Dolby Digital discs contain 5.1-ch Surround or Dolby Surround audio data. What is the difference between these two types?	Both are surround sound standards developed by Dolby Laboratories Inc. in the U.S.A. Dolby Surround records 2-channel surround audio information are recorded onto the analog stereo (left and right) channels together with front stereo audio information. When played back, the surround signals are separated by a Dolby Surround or Dolby Pro Logic decoder. Dolby Digital digitally encodes and records up to six channel information for left, right, center, rear left, rear right and LFE (Low-Frequency Effect for Sub-woofer etc.). When played back, a Dolby Digital decoder decodes data and outputs signals separately. Generally, Dolby Digital sounds better.	4
When playing back a DVD VIDEO or Video CD disc, something like mosaic appears on the TV screen. Is this because of a malfunction of the unit?	It is a block noise specific to a motion picture recorded in digital, and is not a malfunction of the unit.	—
The unit does not function as described in this Instruction Manual.	The operation of this unit may occasionally be unacceptable due to the intention of the disc contents creator and/or structural restrictions.	—
Can I record DVD VIDEO data on a video tape?	Most of all DVD VIDEO discs are copy-protected so that you cannot record DVD VIDEO data onto any video tape.	3
Can this unit record data?	No, you cannot.	—

# Specifications

\*Specifications and appearance subject to change without prior notice.

## General

Readable discs: DVD VIDEO, Audio CD, Video CD, SVCD  
Video format: NTSC, 480i (Interlaced scan)/480p (Progressive scan) selectable

## Other

Power requirements: AC 120 V  $\sim$ , 60 Hz\*  
Power consumption: 14 W (POWER ON), 1.3 W (STANDBY mode)  
Mass: 2.6 kg (5.8 lbs)  
Dimensions (W x H x D): 435 mm x 68 mm x 267.5 mm  
(17-3/16 inch x 2-7/8 inch x 10-9/16 inch)

## Video outputs

COMPONENT (pin jacks): Y Output: 1.0 Vp-p (75  $\Omega$ )  
Pb/Pr Output: 0.7 Vp-p (75  $\Omega$ )  
VIDEO OUT (pin jack): 1.0 Vp-p (75  $\Omega$ )  
S-VIDEO OUT (S jack): Y Output: 1.0 Vp-p (75  $\Omega$ )  
C Output: 286 mVp-p (75  $\Omega$ )  
Horizontal resolution: 500 Lines or more

## Audio outputs

ANALOG OUT (pin jack): 2.0 Vrms (10 k $\Omega$ )  
DIGITAL OUT: (COAXIAL): 0.5 Vp-p (75  $\Omega$  termination)  
(OPTICAL): -21 dBm to -15 dBm (Peak)

## Audio characteristics

Frequency response: CD (sampling frequency 44.1 kHz): 2 Hz to 20 kHz  
DVD (sampling frequency 48 kHz): 2 Hz to 22 kHz  
(2 Hz to 20 kHz for DTS and Dolby Digital bitstream signals)  
DVD (sampling frequency 96kHz/88.2 kHz): 2 Hz to 44 kHz  
Dynamic range: 16 bit: More than 98 dB  
20 bit: More than 106 dB  
24 bit: More than 106 dB  
Wow and flutter: Unmeasurable (less than  $\pm$  0.002%)  
Total harmonic distortion: less than 0.002%

**\*Notes for PX model** (Check the specification indication on the rear panel.):  
Power requirements :AC 110V - 240V  $\sim$ , 50Hz/60Hz  
Power consumption :15W (POWER ON), 2.5W (STANDBY mode)



# Appendix A: Country code list for Parental Lock

This list is used for the Parental Lock operation. For details, see page 53.

AD	Andorra	ES	Spain	LB	Lebanon	SA	Saudi Arabia
AE	United Arab Emirates	ET	Ethiopia	LC	Saint Lucia	SB	Solomon Islands
AF	Afghanistan	FI	Finland	LI	Liechtenstein	SC	Seychelles
AG	Antigua and Barbuda	FJ	Fiji	LK	Sri Lanka	SD	Sudan
AI	Anguilla	FK	Falkland Islands	LR	Liberia	SE	Sweden
AL	Albania	FM	Micronesia (Federated States of)	LS	Lesotho	SG	Singapore
AM	Armenia	FO	Faroe Islands	LT	Lithuania	SH	Saint Helena
AN	Netherlands Antilles	FR	France	LU	Luxembourg	SI	Slovenia
AO	Angola	FX	France, Metropolitan	LV	Latvia	SJ	Svalbard and Jan Mayen
AQ	Antarctica	GA	Gabon	LY	Libyan Arab	SK	Slovakia
AR	Argentina	GB	United Kingdom	MA	Morocco	SL	Sierra Leone
AS	American Samoa	GD	Grenada	MC	Monaco	SM	San Marino
AT	Austria	GE	Georgia	MD	Moldova, Republic of	SN	Senegal
AU	Australia	GF	French Guiana	MG	Madagascar	SO	Somalia
AW	Aruba	GH	Ghana	MH	Marshall Islands	SR	Suriname
AZ	Azerbaijan	GI	Gibraltar	ML	Mali	ST	Sao Tome and Principe
BA	Bosnia and Herzegovina	GL	Greenland	MM	Myanmar	SV	El Salvador
BB	Barbados	GM	Gambia	MN	Mongolia	SY	Syrian Arab Republic
BD	Bangladesh	GN	Guinea	MO	Macau	SZ	Swaziland
BE	Belgium	GP	Guadeloupe	MP	Northern Mariana Islands	TC	Turks and Caicos Islands
BF	Burkina Faso	GQ	Equatorial Guinea	MQ	Martinique	TD	Chad
BG	Bulgaria	GR	Greece	MR	Mauritania	TF	French Southern Territories
BH	Bahrain	GS	South Georgia and the South Sandwich	MS	Montserrat	TG	Togo
BI	Burundi	GT	Guatemala	MT	Malta	TH	Thailand
BJ	Benin	GU	Guam	MU	Mauritius	TJ	Tajikistan
BM	Bermuda	GW	Guinea-Bissau	MV	Maldives	TK	Tokelau
BN	Brunei Darussalam	GY	Guyana	MW	Malawi	TM	Turkmenistan
BO	Bolivia	HK	Hong Kong	MX	Mexico	TN	Tunisia
BR	Brazil	HM	Heard Island and McDonald Islands	MY	Malaysia	TO	Tonga
BS	Bahamas	HN	Honduras	MZ	Mozambique	TP	East Timor
BT	Bhutan	HR	Croatia	NA	Namibia	TR	Turkey
BV	Bouvet Island	HT	Haiti	NC	New Caledonia	TT	Trinidad and Tobago
BW	Botswana	HU	Hungary	NE	Niger	TV	Tuvalu
BY	Belarus	ID	Indonesia	NF	Norfolk Island	TW	Taiwan
BZ	Belize	IE	Ireland	NG	Nigeria	TZ	Tanzania, United Republic of
CA	Canada	IL	Israel	NI	Nicaragua	UA	Ukraine
CC	Cocos (Keeling) Islands	IN	India	NL	Netherlands	UG	Uganda
CF	Central African Republic	IO	British Indian Ocean Territory	NO	Norway	UM	United States Minor Outlying Islands
CG	Congo	IR	Iran (Islamic Republic of)	NP	Nepal	US	United States
CH	Switzerland	IS	Iceland	NR	Nauru	UY	Uruguay
CI	Côte d'Ivoire	IT	Italy	NU	Niue	UZ	Uzbekistan
CK	Cook Islands	JM	Jamaica	NZ	New Zealand	VA	Vatican City State (Holy See)
CL	Chile	JO	Jordan	OM	Oman	VC	Saint Vincent and the Grenadines
CM	Cameroon	JP	Japan	PA	Panama	VE	Venezuela
CN	China	KE	Kenya	PE	Peru	VG	Virgin Islands (British)
CO	Colombia	KG	Kyrgyzstan	PF	French Polynesia	VI	Virgin Islands (U.S.)
CR	Costa Rica	KH	Cambodia	PG	Papua New Guinea	VN	Vietnam
CU	Cuba	KI	Kiribati	PH	Philippines	VU	Vanuatu
CV	Cape Verde	KM	Comoros	PK	Pakistan	WF	Wallis and Futuna Islands
CX	Christmas Island	KN	Saint Kitts and Nevis	PL	Poland	WS	Samoa
CY	Cyprus	KP	Korea, Democratic People's Republic of	PM	Saint Pierre and Miquelon	YE	Yemen
CZ	Czech Republic	KR	Korea, Republic of	PN	Pitcairn	YT	Mayotte
DE	Germany	KW	Kuwait	PR	Puerto Rico	YU	Yugoslavia
DJ	Djibouti	KY	Cayman Islands	PT	Portugal	ZA	South Africa
DK	Denmark	KZ	Kazakhstan	PW	Palau	ZM	Zambia
DM	Dominica	LA	Lao People's Democratic Republic	PY	Paraguay	ZR	Zaire
DO	Dominican Republic			QA	Qatar	ZW	Zimbabwe
DZ	Algeria			RE	Réunion		
EC	Ecuador			RO	Romania		
EE	Estonia			RU	Russian Federation		
EG	Egypt			RW	Rwanda		
EH	Western Sahara						
ER	Eritrea						

## Appendix B: Glossary

### 480i/480p

Indicates the number of scan lines and scanning format of an image signal. 480i indicates 480 scanning lines with interlace format, and 480p indicates 480 scanning lines with progressive format.

### Aspect ratio

A ratio which defines the shape of the rectangular picture in a TV. It is the width of the picture relative to the height. The conventional TV picture is 4:3 in aspect ratio.

### Bitstream

The digital form of multichannel audio data (e.g., 5.1-channel) before it is decoded into its various channels.

### Channel, CH

Stereo or multichannel audio consists of "channel" signals. "Stereo" audio consists of left and right channels, while 5.1-channel Dolby Digital consists of six channels (front left, front right, rear left, rear right, center and LFE (Low-Frequency Effect channel for sub-woofer, etc.).

### Chapter

The smallest division on DVD VIDEO. It is a division of a title and similar to a track for Audio CD or Video CD.

### Component video

Video signals with three channels of separate information that makes up the picture. There are some types of component video, such as R/G/B and Y/C<sub>B</sub>(P<sub>B</sub>)/C<sub>R</sub>(P<sub>R</sub>).

### Composite video

A single video signal commonly used in most consumer video products that contains all luminance, color, and synchronization information.

### Dolby Digital (AC3)

A six-channel system consisting of left, center, right, left rear, right rear and LFE (Low-Frequency Effect channel for sub-woofer, etc.) channels. All processing is done in the digital domain.

Not all Dolby Digital discs contain six (5.1) channel information.

### Dolby Surround/Dolby Prologic

Dolby Surround is a five-channel system consisting of left, center, right and left rear, right rear channels. All processing is done in the digital domain.

Dolby Prologic is a four-channel system consisting of left, center, right and rear channel (the single rear channel is usually played through two speakers).

### Downmix

Internal stereo mix of multichannel surround audio by a DVD player. The downmix signals are output from stereo output connectors.

### DTS

A Digital Surround audio encoding format configured with six (5.1) channels, similar to Dolby Digital. It requires a decoder, either in the player or in an external receiver. DTS stands for Digital Theater Systems.

Not all DTS discs contain six (5.1) channel information.

### Dynamic range

The difference between the loudest and softest sounds.

### Dynamic range compression

The dynamic range compression (DRC) reduces the dynamic range so that you can turn down the volume to avoid disturbing others yet still hear the detail of quiet passages.

### Extension

Several letters at the end of a filename. Filename extensions usually follow a period and indicate the type of information stored in the file.

### Finalize

When conducting multisession recording, this means the closing of a session (fixing) by indicating the halting of writing so as to prevent the addition of any more sessions.

### Fs

See "Sampling frequency".

### ID3 tag

The tag embedded in an MP3 file indicating what song, artists, and album it comes from. You can edit these tags.

### Interlace scan

In the conventional video system, a picture is shown on the display monitor in two halves. The Interlace scan system places lines of the second half of the picture in-between lines of the first half of the picture.

### ISO 9660 Format

The most common international standard for the logical format for files and directories on a CD-ROM.

### JPEG

A popular file format for still image compression. JPEG stands for Joint Photographic Experts Group. There are three sub-types of the JPEG format as follows.

- baseline JPEG: used for digital cameras, web, etc.
- progressive JPEG: used for web
- lossless JPEG: an old type and rarely used now

**Letter box**

A type of picture playback with the normal (4:3) TV screen. Black bars are shown at the top and bottom of the image to allow playing of wide-screen (16:9) DVD movie without cutting off any sides of the image on a 4:3 TV.

**Linear PCM audio**

Stands for "pulse code modulation". Linear PCM is the usual digital method without compression, used for audio playback of DVD Video discs, Audio CD discs, etc.

**Menu**

Most DVD VIDEO or Video CD/SVCD discs provide a menu, through which users can select a desired playback material, condition, etc.

**MP3**

MP3 is an audio data reduction format, which stands for MPEG-1 Audio Layer 3. Using MP3, you can achieve a data reduction of about 1:10.

**MPEG**

A family of Standards for compressing audio-visual information. "MPEG" standards include MPEG-1, MPEG-2 and MPEG-4. Video CD and MP3 are based on MPEG-1, while DVD is based on MPEG-2. MPEG stands for Moving Picture coding Experts Group.

**Multisession**

A method of adding data to a CD-R/CD-RW in more than one recording session using the Track-At-Once method.

**NTSC (National television system committee)**

A black & white and color television system format used in U.S.A., Canada, Mexico and Japan.

**Packet Writing**

A method of writing data on a CD-R/CD-RW in small increments. Packets can be of fixed or variable length.

**PAL (Phase Alternation by Line)**

A color television system format used extensively in Western Europe.

**Pan scan**

A type of picture playback with the normal (4:3) TV screen, which is panned and zoomed across the wider movie picture, chopping off the left and right sides.

**Parental lock**

A DVD function that prevents undesired viewing by children depending on disc contents. You need a password to play back a locked disc in the normal condition. Otherwise, undesirable scenes are automatically skipped or replaced with other pictures.

**PBC**

PBC stands for "Playback control" and is a method of controlling disc play for Video CDs (VCD). You are able to interact with the disc through menus.

**Progressive scan**

Progressive scan displays all the horizontal lines of a picture at one time, as a single frame. A progressive-scan DVD player converts the interlaced (480i) video from DVD into progressive (480p) format for connection to a progressive display. It dramatically increases the vertical resolution.

**Region code**

Code identifying a geographic region of compatibility for a DVD.

**Sampling frequency**

The rate at which measurements of an audio signal are taken during A/D and D/A conversion. The measure is samples per second.

**Surround**

An audio system with more than two (left and right) channels, usually including rear channels, etc.

**S-video**

A video signal which improves picture quality over standard composite connections. Used on Super VHS, DVD, high end TV monitors, etc.

**Title**

The largest division on DVD VIDEO.

**Track**

The smallest division on Audio CD, Video CD and SVCD discs.

**Transfer rate**

The rate of transferring digital data. Usually the measure is in baud per second. The DVD system applies variable transfer rate system for high efficiency.

# Appendix C: Index

## Numerics

3D PHONIC .....	34, 51
480i .....	6, 7, 60, 62
480p .....	7, 62

## A

A-B repeat .....	28, 36, 37
Angle .....	15, 17, 29, 31, 37
Audio language .....	15, 29, 30, 36, 48
Auto standby .....	52
AV COMPU LINK .....	7, 8, 9, 52, 58
AV COMPULINK mode .....	52

## C

Chapter .....	5, 19, 20, 21, 24, 25, 27, 28, 36
Chapter search .....	36
Component video .....	2, 7, 58, 62
Copyguard system .....	3
Copy-protected disc.....	6
Country code .....	53, 55, 63

## D

D. range compression .....	9, 51
Digest .....	24, 25
Digital audio output .....	4, 9, 13, 50
Direct selection .....	41
Disc resume .....	15, 16, 17, 52
Dolby .....	3, 58
Dolby Digital .....	4, 9, 13, 34, 50, 51, 58, 62
Down mix .....	7, 8, 51
DTS .....	3, 4, 9, 13, 50, 62
DVD menu .....	22
DVD PLAYER SET UP .....	13

## E

Extension .....	39, 42
-----------------	--------

## F

Finalize .....	4, 39, 42
----------------	-----------

## G

Group .....	39, 40, 41, 42, 43, 45, 46
-------------	----------------------------

## I

ID3 tag .....	39
Initial setting .....	13, 47
Initial setup .....	13
Interlace scan .....	7, 8
ISO 9660 .....	39, 42

## J

JPEG .....	4, 39, 42, 43, 46, 48, 50
JPEG CONTROL .....	43, 44, 45, 46
JPEG disc .....	3, 17, 42, 43, 44, 47

## L

Language code .....	48
Linear PCM .....	4, 50, 60

## M

Macrovision .....	3
Manufacturer code .....	11
Menu .....	5, 13, 14, 15, 20, 22, 23, 36, 37, 47, 48, 49, 50, 51, 52, 53, 54, 55

Menu bar .....	21, 23, 24, 25, 26, 27, 28, 29, 30, 31, 35, 36, 37
Menu language .....	48
Monitor type .....	13, 49, 60
MP3 .....	4, 39, 40, 41, 42, 50
MP3 CONTROL .....	40, 41, 48
MP3 disc .....	3, 17, 39, 47
MPEG .....	13, 39, 50
Multi-angle part .....	31, 37
Multiple session .....	39, 42

## N

NTSC .....	4, 7, 62
------------	----------

## O

One touch replay function .....	21
On-screen guide .....	15, 52
On-screen language .....	13, 48
Opening display .....	12, 13, 14

## P

Packet write .....	39, 42
PAL .....	4
Pan scan .....	49
Parental lock .....	52, 53, 54, 55, 63
Playback control (PBC) .....	5, 17, 19, 20, 22, 23, 24, 27, 28
Preference .....	7, 8, 9, 13, 15, 16, 17, 29, 30, 31, 33, 39, 42, 47, 48, 53, 54, 55, 58, 60
Program (playback) .....	24, 25, 26, 28, 37
Progressive mode .....	7, 8, 49, 60
Progressive scan .....	7, 8, 33, 49, 60, 62

## R

Random (playback) .....	26, 27, 38
Region code .....	4, 12, 14
Repeat (playback) .....	27, 28, 36, 37, 41, 46
Resume (playback) .....	15, 16, 17, 52

## S

Sampling rate .....	4
Scan mode .....	6, 7, 8, 49, 60
Screen saver .....	15, 42, 50
Slide show .....	44, 45
Slide show mode .....	44, 46
Slide show playback .....	44, 45
Slow-motion .....	15, 18, 21
Status bar .....	20, 21, 26, 29, 30, 31, 35, 36, 37
Strobe (playback) .....	32
Subtitle language .....	15, 29, 36
S-video .....	6, 7, 58, 60, 62

## T

Time search .....	23, 24, 36, 37
Transfer rate .....	20, 39
Transport status .....	20, 21

## V

VFP (Video fine processor) .....	8, 33, 60
----------------------------------	-----------

## Z

Zoom (playback) .....	32, 44, 49
-----------------------	------------

# Authorized Service Centers

---

QUALITY **JVC**<sup>®</sup> SERVICE

*HOW TO LOCATE YOUR JVC SERVICE CENTER*

**TOLL FREE: 1 (800) 537-5722**

**<http://www.jvc.com>**

Dear Customer,

In order to receive the most satisfaction from your purchase, please read the instruction booklet before operating the unit. In the event that repairs are necessary, please call 1 (800)537-5722 for your nearest authorized servicer or visit our website at **[www.JVC.com](http://www.JVC.com)**

Remember to retain your Bill of Sale for Warranty Service.

---

## **Do not service the television yourself**

---

### **Caution**

To prevent electrical shock, do not open the cabinet. There are no user serviceable parts inside. Please refer to qualified service personnel for repairs.

### **Accessories**

To purchase accessories for your JVC product, please call toll free: 1 (800)882-2345 or on the web at **[www.JVC.com](http://www.JVC.com)**

---



# LIMITED WARRANTY

CONSUMER VIDEO 1-90

JVC COMPANY OF AMERICA warrants this product and all parts thereof, except as set forth below ONLY TO THE ORIGINAL PURCHASER AT RETAIL to be FREE FROM DEFECTIVE MATERIALS AND WORKMANSHIP from the date of original retail purchase for the period as shown below. ("The Warranty Period")

PARTS	<b>1 YR</b>	LABOR	<b>90 DAYS</b>
-------	-------------	-------	----------------

THIS LIMITED WARRANTY IS VALID ONLY IN THE FIFTY (50) UNITED STATES, THE DISTRICT OF COLUMBIA AND IN COMMONWEALTH OF PUERTO RICO.

**WHAT WE WILL DO:**

If this product is found to be defective, JVC will repair or replace defective parts at no charge to the original owner. Such repair and replacement services shall be rendered by JVC during normal business hours at JVC authorized service centers. Parts used for replacement are warranted only for the remainder of the Warranty Period. All products and parts thereof may be brought to a JVC authorized service center on a carry-in basis except for Television sets having a screen size 25 inches and above which are covered on an in-home basis.

**WHAT YOU MUST DO FOR WARRANTY SERVICE:**

Return your product to a JVC authorized service center with a copy of your bill of sale. For your nearest JVC authorized service center, please call toll free: (800) 537-5722.

If service is not available locally, box the product carefully, preferably in the original carton, and ship, insured, with a copy of your bill of sale plus a letter of explanation of the problem to the nearest JVC Factory Service Center, the name and location of which will be given to you by the toll-free number.

If you have any questions concerning your JVC Product, please contact our Customer Relations Department.

**WHAT IS NOT COVERED:**

This limited warranty provided by JVC does not cover:

1. Products which have been subject to abuse, accident, alteration, modification, tampering, negligence, misuse, faulty installation, lack of reasonable care, or if repaired or serviced by anyone other than a service facility authorized by JVC to render such service, or if affixed to any attachment not provided with the products, or if the model number or serial number has been altered, tampered with, defaced or removed;
2. Initial installation and installation and removal for repair;
3. Operational adjustments covered in the Owner's Manual, normal maintenance, video and audio head cleaning;
4. Damage that occurs in shipment, due to act of God, and cosmetic damage;
5. Signal reception problems and failures due to line power surge;
6. Video Pick-up Tubes/CCD Image Sensor, Cartridge, Stylus (Needle) are covered for 90 days from the date of purchase;
7. Accessories;
8. Batteries (except that Rechargeable Batteries are covered for 90 days from the date of purchase);

There are no express warranties except as listed above.

THE DURATION OF ANY IMPLIED WARRANTIES, INCLUDING THE IMPLIED WARRANTY OF MERCHANTABILITY, IS LIMITED TO THE DURATION OF THE EXPRESS WARRANTY HEREIN.

JVC SHALL NOT BE LIABLE FOR THE LOSS OF USE OF THE PRODUCT, INCONVENIENCE, LOSS OR ANY OTHER DAMAGES, WHETHER DIRECT, INCIDENTAL OR CONSEQUENTIAL (INCLUDING, WITHOUT LIMITATION, DAMAGE TO TAPES, RECORDS OR DISCS) RESULTING FROM THE USE OF THIS PRODUCT, OR ARISING OUT OF ANY BREACH OF THIS WARRANTY. ALL EXPRESS AND IMPLIED WARRANTIES, INCLUDING THE WARRANTIES OF MERCHANTABILITY AND FITNESS FOR PARTICULAR PURPOSE, ARE LIMITED TO THE WARRANTY PERIOD SET FORTH ABOVE.

Some states do not allow the exclusion of incidental or consequential damages or limitations on how long an implied warranty lasts, so these limitations or exclusions may not apply to you. This warranty gives you specific legal rights and you may also have other rights which vary from state to state.

JVC COMPANY OF AMERICA                      1700 Valley Road  
 DIVISION OF JVC AMERICAS CORP.            Wayne, NJ 07470

REFURBISHED PRODUCTS CARRY A SEPARATE WARRANTY, THIS WARRANTY DOES NOT APPLY. FOR DETAILS OF REFURBISHED PRODUCT WARRANTY, PLEASE REFER TO THE REFURBISHED PRODUCT WARRANTY INFORMATION PACKAGED WITH EACH REFURBISHED PRODUCT.

**For customer use:**

Enter below the Model No. which is located either on the rear, bottom or side of the cabinet. Retain this information for future reference.

Model No. :	Serial No. :
Purchase data :	Name of dealer :



## Free Manuals Download Website

<http://myh66.com>

<http://usermanuals.us>

<http://www.somanuals.com>

<http://www.4manuals.cc>

<http://www.manual-lib.com>

<http://www.404manual.com>

<http://www.luxmanual.com>

<http://aubethermostatmanual.com>

Golf course search by state

<http://golfingnear.com>

Email search by domain

<http://emailbydomain.com>

Auto manuals search

<http://auto.somanuals.com>

TV manuals search

<http://tv.somanuals.com>