

JVC

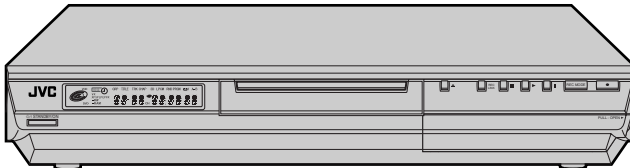

DVD VIDEO RECORDER

DR-M10



G-CODE™ / SHOWVIEW™



Region number of DVD VIDEO

DVD units and DVD VIDEO discs have their own region numbers. This unit can play back DVD VIDEO discs whose region numbers include the unit's region number, which is indicated on the region number symbol on the rear panel.



INSTRUCTIONS

EN

Safety Precautions

The rating plate and the safety caution are on the rear of the unit.

WARNING: DANGEROUS VOLTAGE INSIDE

WARNING: TO PREVENT FIRE OR SHOCK HAZARD, DO NOT EXPOSE THIS UNIT TO RAIN OR MOISTURE.

CAUTION

A UNIT IS A CLASS 1 LASER PRODUCT. HOWEVER THIS UNIT USES A VISIBLE LASER BEAM WHICH COULD CAUSE HAZARDOUS RADIATION EXPOSURE IF DIRECTED. BE SURE TO OPERATE THE UNIT CORRECTLY AS INSTRUCTED.

WHEN THIS UNIT IS PLUGGED INTO THE WALL OUTLET, DO NOT PLACE YOUR EYES CLOSE TO THE OPENING OF THE DISC TRAY AND OTHER OPENINGS TO LOOK INTO THE INSIDE OF THIS UNIT.

USE OF CONTROLS OR ADJUSTMENTS OR PERFORMANCE OF PROCEDURES OTHER THAN THOSE SPECIFIED HEREIN MAY RESULT IN HAZARDOUS RADIATION EXPOSURE.

DO NOT OPEN COVERS AND DO NOT REPAIR YOURSELF. REFER SERVICING TO QUALIFIED PERSONNEL.

CAUTION

- When you are not using the unit for a long period of time, it is recommended that you disconnect the power cord from the mains outlet.
- Dangerous voltage inside. Refer internal servicing to qualified service personnel. To prevent electric shock or fire hazard, remove the power cord from the mains outlet prior to connecting or disconnecting any signal lead or aerial.

IMPORTANT:

- Please read the various precautions on pages 2 and 3 before installing or operating the unit.
- It should be noted that it may be unlawful to re-record pre-recorded tapes, DVDs, or discs without the consent of the owner of copyright in the sound or video recording, broadcast or cable programme and in any literary, dramatic, musical, or artistic work embodied therein.

CLASS 1 LASER PRODUCT

REPRODUCTION OF LABELS

WARNING LABEL INSIDE OF THE UNIT

CAUTION	VISIBLE AND INVISIBLE LASER RADIATION WHEN OPEN. AVOID EXPOSURE TO BEAM. DO NOT STARE INTO BEAM OR VIEW DIRECTLY WITH OPTICAL INSTRUMENTS.
ADVARSEL	SYNLIG OG USYNLIG LASERSTRÅLING VED ÅBNING. UNDGÅ UDSAETTELSE FOR STRÅLING SE IKKE IND I STRÅLEN - HELLER IKKE MED OPTISKE INSTRUMENTER.
ADVARSEL	SYNLIG OG USYNLIG LASERSTRÅLING NÅR DEKSEL ÅPNES. UNDGÅ EKSPONERING FOR STRÅLEN STIRR IKKE INN I STRÅLEN ELLER SE DIREKTE MED OPTISKE INSTRUMENTER.
VARO!	AVATTAESSA OLET ALTTIINA NÄKYVÄÄ JA NÄKYMÄTÖN LASERSÄTEILYLLE. ÄLÄ TUJOTA SÄTEESEEN ÄLÄKÄ KATSO SITÄ OPTISEN LAITTEEN LÄPI.
VARNING	SYNLIG OCH OSYNLIG LASERSTRÅLNING NÅR DENNA DEL ÄR ÖPPNAD. STRÅLEN ÄR FARLIG STIRRA EJ IN I STRÅLEN OCH BETRAKTA EJ STRÅLEN MED OPTISKA INSTRUMENT.



G-CODE™ / SHOWVIEW™

- Manufactured under licence from Dolby Laboratories. "Dolby" and double-D symbol are trademarks of Dolby Laboratories.
- "DTS" and "DTS Digital Out" are trademarks of Digital Theater Systems, Inc.
- G-CODE is a trademark of Gemstar Development Corporation and is registered in the following countries: Australia, China, Hong Kong, Japan, South Korea, New Zealand, and Taiwan. SHOWVIEW is a trademark of Gemstar Development Corporation and is registered in the following countries: Austria, Belgium, Czech Republic, Denmark, Finland, France, Germany, Greece, Hungary, Iceland, Italy, Luxembourg, Netherlands, Norway, Poland, Portugal, Russia, Slovakia, South Africa, Spain, Sweden and Switzerland. The G-CODE/SHOWVIEW system is manufactured under license from Gemstar Development Corporation. G-CODE and SHOWVIEW are different trademarks used to represent the same easy recording feature. However, for simplicity, only the term G-CODE will be used in the instructions. If you use SHOWVIEW system, follow the same steps listed for the G-CODE system.
- This product incorporates copyright protection technology that is protected by method claims of certain U.S. patents and other intellectual property rights owned by Macrovision Corporation and other rights owners. Use of this copyright protection technology must be authorized by Macrovision Corporation, and is intended for home and other limited viewing users only unless otherwise authorized by Macrovision Corporation. Reverse engineering or disassembly is prohibited.

POWER SYSTEM: (DR-M10SAG/SAX only*)

This unit operates on voltage of AC110 – 240 V \sim (Rating), AC90 – 260 Vd (Operating), 50/60 Hz with automatic switching.

* The model number depends on the country where you live. Check the label on the rear of the unit.

The STANDBY/ON ϕ /I button does not completely shut off mains power from the unit, but switches operating current on and off. " ϕ " shows electrical power standby and "I" shows ON.

When the equipment is installed in a cabinet or a shelf, make sure that it has sufficient space on all sides to allow for ventilation (10 cm or more on both sides, on top and at the rear).

When discarding batteries, environmental problems must be considered and the local rules or laws governing the disposal of these batteries must be followed strictly.

Failure to heed the following precautions may result in damage to the unit, remote control or disc.

1. **DO NOT place the unit** —
 - in an environment prone to extreme temperatures or humidity.
 - in direct sunlight.
 - in a dusty environment.
 - in an environment where strong magnetic fields are generated.
 - on a surface that is unstable or subject to vibration.
2. **DO NOT block the unit's ventilation openings or holes.**
(If the ventilation openings or holes are blocked by a newspaper or cloth, etc., the heat may not be able to get out.)
3. **DO NOT place heavy objects on the unit or remote control.**
4. **DO NOT place anything which might spill on top of the unit or remote control.**
(If water or liquid is allowed to enter this equipment, fire or electric shock may be caused.)
5. **DO NOT expose the apparatus to dripping or splashing.**
6. **DO NOT use this equipment in a bathroom or places with water.** Also **DO NOT** place any containers filled with water or liquids (such as cosmetics or medicines, flower vases, potted plants, cups, etc.) on top of this unit.
7. **DO NOT place any naked flame sources, such as lighted candles, on the apparatus.**
8. **AVOID violent shocks to the unit during transport.**

MOISTURE CONDENSATION

Moisture in the air will condense on the unit when you move it from a cold place to a warm place, or under extremely humid conditions—just as water droplets form on the surface of a glass filled with cold liquid. In conditions where condensation may occur, disconnect the unit's power plug from the wall and keep it disconnected for a few hours to let the moisture dry, then turn on the unit.

ATTENTION:**To mobile phone users:**

Using a mobile phone in the vicinity of the unit may cause picture vibration on the TV screen or change the screen to a blue back display.







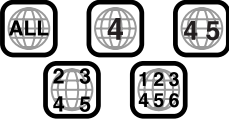

On placing the unit:

Some TVs or other appliances generate strong magnetic fields. Do not place such appliances on top of the unit as it may cause picture disturbance.

SAFETY FIRST	2	EDITING	76
Safety Precautions	2	DV Dubbing	76
DISC INFORMATION	5	Edit From A Camcorder	78
About Discs	5	Edit To Or From Another Recorder	79
INDEX	10	Output/Input Set	80
INSTALLING YOUR NEW UNIT	16	Digital Audio Dubbing	82
Basic Connections	16	REMOTE CONTROL	83
S-VIDEO Connection	17	Remote Control Functions	83
Component Video Connection	18	SYSTEM CONNECTIONS	85
INITIAL SETTINGS	19	Connecting To A Satellite Receiver	85
Auto Set Up	19	Connecting To A Dolby Digital Decoder Or An Amplifier With Built-in DTS	86
Monitor Set	21	SUBSIDIARY SETTINGS	87
Language	22	Mode Set	87
PLAYBACK OPERATIONS	25	Tuner Set	92
Basic Playback	25	Clock Set	96
Playback Features	26	Format A Disc	97
Live Memory Playback	31	Finalise A Disc	98
Using Play Set Up Menu	36	Scan Mode Set	99
Parental Lock	43	Tray Lock	99
RECORDING	47	TROUBLESHOOTING	100
Basic Recording	47	GLOSSARY	104
Recording Features	48	SPECIFICATIONS	105
TIMER RECORDING	51	LIST OF TERMS	106
G-CODE™/SHOWVIEW™ System Setup	51		
G-CODE™/SHOWVIEW™ Timer Programming ...	52		
Manual Timer Programming	54		
On-Disc Timer Programming	56		
Automatic Satellite Programme Recording	61		
NAVIGATION	62		
Library Database DVD Navi	62		
Modify Original Information	65		
Modify Play List Information	68		
Modify Library Information	72		
Playback with MP3/JPEG Navigation	74		

Discs for Playback Only

You can use discs with the following logos for playback only.

<p>DVD VIDEO</p>  <p>(example of region code indications)</p> 	<p>Video CD/Super Video CD</p>    
<p>Audio CD</p>  <p>CD-DA files</p>	<p>CD-R</p>  <p>CD-DA/JPEG/MP3 files</p>
<p>CD-RW</p>  <p>CD-DA/JPEG/MP3 files</p>	<p>CD-ROM</p>  <p>JPEG/MP3 files</p>

- Playback may not be performed depending on the characteristics and condition of the disc used.
- DTS Audio CDs can also be played back (An optional DTS decoder is required).
- MP3 and JPEG discs can be played back on this unit only when they have been recorded in the ISO9660 or Joliet format and finalised.
- JPEG files that can be played back on this unit must conform to JFIF/Baseline process, and the maximum resolution of a JPEG file is 3,840 x 2,160 pixels.
- CD-R/RW discs recorded in music CD format need to be finalised to play on this unit.
- Operation and audio quality of this unit are not guaranteed for discs that do not conform to the Compact Disc specification (CD-DA).
Before you play back a CD, check for the CD logo and read the notes on the package to confirm that it conforms to the Compact Disc specification.
- Depending on the intentions of the author of the software, recording conditions of DVD discs and Video CD/SVCD discs may be restricted. Since this unit plays back discs according to the intentions of the author of the software as indicated on the disc, some functions may not operate as commanded.
- When switching from the first layer to the second layer of double-layered DVD VIDEO discs, the image and sound may be momentarily distorted. This is not a malfunction.
- DVD-AUDIO discs compatible with DVD video players can be played.
- Super Audio CDs (SACD) compatible with conventional CD players can be played.

Unplayable Discs









The following types of discs cannot be played using this unit. Do not attempt to play back any kind of disc that is damaged (cracked, warped, or repaired with adhesive tape) or discs in unusual shapes (heart-shaped, octagonal, or other forms). If such discs are accidentally played back, it may cause noise that can lead to speaker damage.

- CD-ROM discs (including PHOTO-CD and CD-G)
- Discs recorded in Packet Write (UDF) format.
- 1.3-GB double density CDs (DDCD)
- High density CDs (HDCD)

The following discs also cannot be played back.

- Discs whose region numbers do not include the unit's region number, which is indicated on the region number symbol on the rear panel.
- DVD-RAM (2.6 GB/5.2 GB)

Marks of discs in this instruction manual

	Allows operation with a DVD-RAM disc.		Allows operation with a Video CD/Super Video CD (SVCD) disc.
	Allows operation with a DVD-R disc.		Allows operation with an Audio CD disc.
	Allows operation with a DVD-RW disc.		Allows operation with a disc including MP3 files.
	Allows operation with a DVD VIDEO disc.		Allows operation with a disc including JPEG files.

Recording Medium and Format

DVD-RAM

- Recording and erasing can be performed as many times as possible on a disc.
- Editing can be performed after recording, such as deleting unwanted parts.
- While recording, it is possible not only to start playback of a programme currently being recorded, but also to watch another programme previously recorded.

DVD-RW (VR mode)

- Recording and erasing can be performed as many times as possible on a disc.
- Editing can be performed after recording, such as deleting unwanted parts.

DVD-RW (Video mode)

- Can be played back on other DVD players.
- New recording can be performed by erasing all the data on a disc once played back.

DVD-R

- Can be played back on other DVD players.
- Suitable when keeping a recorded disc for a long time.

File Structure of Discs

DVD VIDEO

Typically, DVD VIDEO discs are made up of larger units called "titles". Each title has a number (title number) that can be used to select desired titles. Titles are further divided into units called "chapters". Each chapter has a number (chapter number) that can also be used to select desired chapters. Note that some discs are not divided into titles and chapters.

When you record a programme on a DVD-RAM/RW (VR mode) disc

A single recording session results in a single title (a single chapter). However, chapter marks are automatically inserted when recording is paused, or audio changes from monaural or bilingual to stereo due to commercial breaks, etc. It is also possible to insert chapter marks at desired locations during playback. (☞ pg. 28)

When you record a programme on a DVD-R/RW (Video mode) disc

A single recording session results in a single title (a single chapter). However, chapter marks are automatically inserted when recording is paused, or audio changes due to commercial breaks, etc. It is also possible to insert chapter marks at desired locations during either recording or playback. Once the disc has been finalised, these chapter marks are deleted and new chapter marks are assigned automatically approximately every 5 minutes.

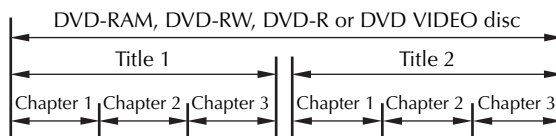

- In Video mode, even before finalising, it is impossible to perform editing operations other than changing the disc name and/or title names and deleting programmes and/or titles.
- After finalising, it is impossible to perform editing operations.

Audio CD/Video CD/SVCD

Typically, Audio CD discs are divided into separate tracks each containing one song. Each track is assigned a number. For example, the third track is Track 3. The same is true for Video CD/SVCD discs.

However, some discs are not divided into tracks.

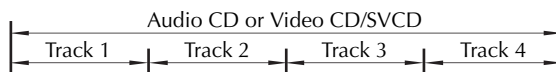

JPEG/MP3 Disc (CD-R/RW/ROM)

MP3/JPEG files put in directories nested in several levels on a disc will be organized as if they were put in single level directories (groups) by the MP3/JPEG Navigation of this unit.
(☞ pg. 74)

File structure of a disc before starting the MP3/JPEG Navigation

Placing a Disc

Opening the disc tray

Press ▲ on the unit or remote control to open the disc tray.

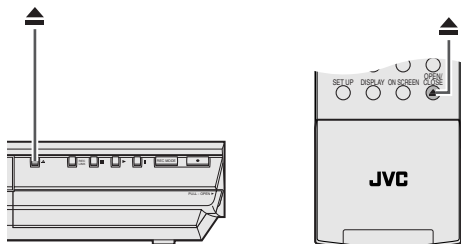

Unit

Remote control

- Pressing the button on the unit or on the remote control again closes the disc tray.
- Use the buttons on the unit or on the remote control to open and close the disc tray.
- Do not block the disc tray with your hand while it is opening or closing as this may result in hardware failure.
- Do not place unplayable discs or any object other than a disc on the disc tray.
- Do not press down strongly on the disc tray or place any heavy objects on it.

Discs without cartridges

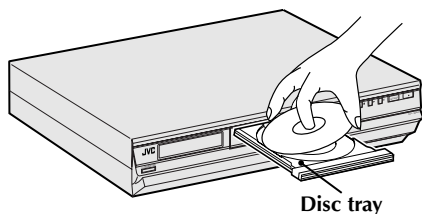

Place the disc on the disc tray with the label side facing up. Since disc size changes depending on the disc to be played back, be sure to correctly align the disc with the grooves for its size. If the disc is not in its groove, it may be scratched or otherwise damaged. To insert an 8 cm disc, place it according to the inner groove.

DVD-RAM discs contained in cartridges

Double-sided discs:

Remove the disc from the cartridge. Align the disc with the grooves on the disc tray as shown in the illustration and insert with the side you wish to play back or record facing down. If you insert the disc with "Side A" facing down, programmes are recorded on the side A.

Single-sided discs:

Remove the disc from the cartridge. Align the disc with the grooves on the disc tray as shown in the illustration and insert with the label side facing up.

Care and Handling of Discs

How to handle discs

When handling a disc, do not touch the surface of the disc. Since discs are made of plastic, they are easily damaged. If a disc gets dirty, dusty, scratched or warped, the images and sound will not be picked up correctly, and such a disc may cause the unit to malfunction.

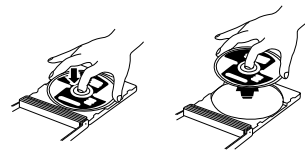

Label side

Do not damage the label side, stick paper to or use any adhesives on its surface.

Recording side

Make sure that discs are not scratched and dirty on the recording side before use. Scratches and dirt on the recording side of a disc may hinder proper playback and recording. Also be careful that a DVD-RAM disc may get scratched or dirt when removed from cartridge then put back in after use.

Storage

Make sure that discs are kept in their cases. If discs are piled on top of one another without their protective cases, they can be damaged. Do not put discs in a location where they may be exposed to direct sunlight, or in a place where the humidity or temperature is high. Avoid leaving discs in your car!

Maintenance of discs

If there are fingerprints or other dirt adhering to a disc, wipe with a soft dry cloth, moving from the centre outwards. If a disc is difficult to clean, wipe with a cloth moistened with water. Never use record cleaners, petrol, alcohol or any anti-static agents.



CAUTION

Sometimes during playback, noise may appear or images may be garbled. This is sometimes due to the disc. (It may not be up to industry standards.) These symptoms are caused by the discs, not by the malfunction of the unit.

FRONT VIEW

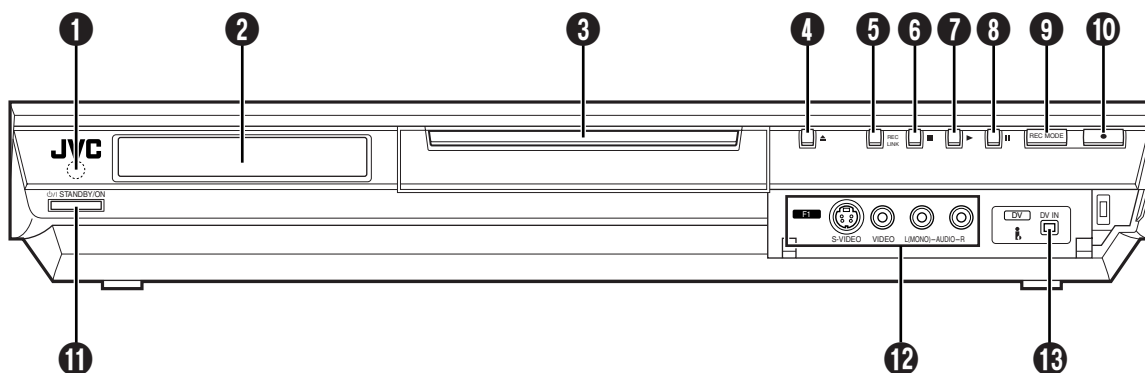

- ❶ Infrared Beam Receiving Window
- ❷ Front Display Panel [pg. 12](#)
- ❸ Disc Tray
- ❹ Open/Close Button (▲) [pg. 9](#)
- ❺ Automatic Satellite Programme Recording Button (REC LINK) [pg. 61](#)
- ❻ Stop Button (■) [pg. 25, 47](#)
- ❼ Play Button (▶) [pg. 25](#)
- ❽ Pause Button (||) [pg. 25](#)

- ❾ Recording Mode Button (REC MODE) [pg. 47](#)
- ❿ Record Button (●) [pg. 47](#)
- ⓫ Standby/On Button (⏻/⏿ (STANDBY/ON)) [pg. 19](#)
- ⓬ S-video/Video/Audio Input Connectors (S-VIDEO/VIDEO/AUDIO (L/R)) [pg. 78](#)
- ⓭ DV Input connector (DV IN (i*)) [pg. 76](#)

* i.Link refers to the IEEE1394-1995 industry specification and extensions thereof. The i logo is used for products compliant with the i.Link standard.

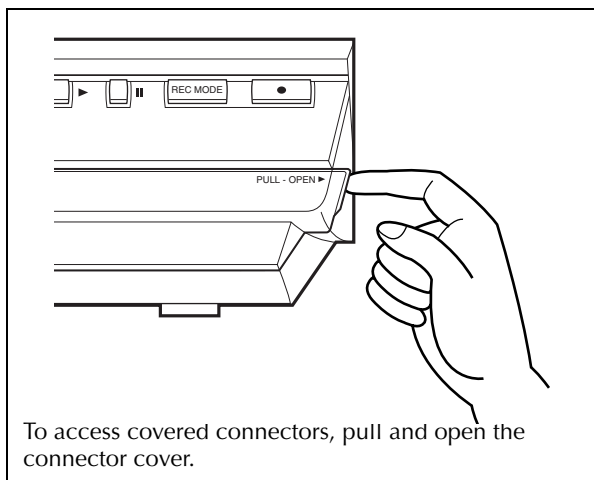

To access covered connectors, pull and open the connector cover.

REAR VIEW

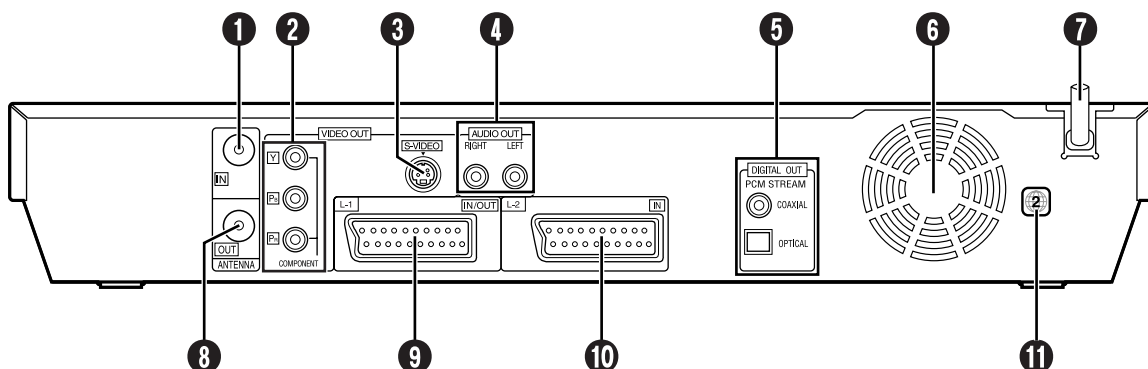

- 1** Antenna Input Connector (ANTENNA IN)
 ☞ pg. 16
- 2** Component Video Output Connectors (COMPONENT VIDEO OUT) ☞ pg. 18
- 3** S-video Output Connector (S-VIDEO OUT)
 ☞ pg. 17
- 4** Audio Output Connectors (AUDIO OUT (RIGHT/LEFT)) ☞ pg. 17
- 5** Digital Audio Output Connectors (DIGITAL OUT (COAXIAL/OPTICAL)) ☞ pg. 82, 86
- 6** Cooling Fan
 - This prevents the temperature from rising inside the unit. Do not remove it.
 - Install the unit so as not to block the area around the fan.
 - The cooling fan on the rear of the unit may be activated even if the unit is turned off in the following cases;
 - In the Automatic Satellite Programme Recording standby mode (☞ pg. 61)

- 7** Mains Power Cord ☞ pg. 16
- 8** Antenna Output Connector (ANTENNA OUT)
 ☞ pg. 16
- 9** L-1 Input/Output Connector (L-1 IN/OUT)*
 ☞ pg. 16, 79, 80, 85
- * This connector can not be used as input connector when using the provided output cable adapter.
- 10** L-2 Input Connector (L-2 IN) ☞ pg. 79, 85
- 11** Region Number Label ☞ pg. 1

Indicator

, the type of the disc is indicated.

g, the disc marks rotate.

earch: Rotate faster than normal playback.

Rotate slower than normal playback.

Inner red ring lights in the same way as normal playback. During Instant Timer Recording (ITR), inner red ring slowly blinks.

Disc marks blink when either recording or playing back.

Disc marks all light.

ed: Disc marks all blink.

pened: Disc marks all light out.

ray: Disc marks all light out.

tor  pg. 97

RW disc is formatted in VR mode.

g Indicator  pg. 52, 54, 56, 59

when a disc set up for On-Disc Timer programming is loaded.

when timer recording other than On-Disc Programming is on stand-by or being ed.

when On-Disc Timer Programming is on by or being executed.

quickly if you press  (TIMER) in the ing cases;

is not loaded.

ck has not been set.



is no programme setting.

4 Recording Mode Indicator (XP/SP/LP/EP/FR)

 pg. 48

Blinks when recording mode is being set.

While "FR" is blinking, the left 3 digits of the Multi Display

( ) indicate setting values ranging from "60" to "480"

After the value has been set, only "FR" lights.

5 Group/Title Indicator (GRP/TITLE)  pg.

"GRP" or "TITLE" lights depending on a disc loaded.

the left 2 digits of the Multi Display () indicate explained below.

"GRP": Total number of groups or groups played back are displayed on

"TITLE": Total number of titles or titles back are displayed on the

6 Track/Chapter Indicator

"TRK" or "CHAP" lights depend on

the 3rd and 4th digits from

indicate the numbers of

"TRK": Total number of

played back are displayed on

"CHAP": Chapter number

of

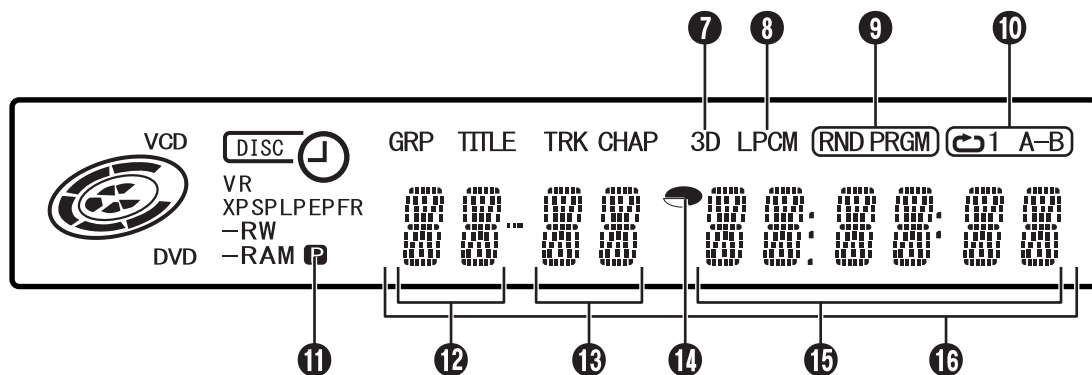

7 Simulated Surround Effect Indicator (3D)

☞ pg. 40

Lights when a simulated surround effect is set to "3D-ON" in Play Set Up menu.

8 Linear PCM Indicator (LPCM)

Lights when "XP MODE REC AUDIO" is set to "LINEAR PCM" (☞ pg. 89) for recording with DVD-RAM, DVD-R and DVD-RW discs, and when Linear PCM audio is played.

9 Random/Programme Playback Mode Indicator (RND/PRGM) ☞ pg. 42

"RND": Lights when Random Playback mode is set. (☞ pg. 42)

"PRGM": Lights when Programme Playback mode is set. (☞ pg. 42)

10 Repeat Mode Indicator (☞/1/A-B) ☞ pg. 38, 39

Select Repeat Playback mode in Play Set Up menu.

"☞": Whole disc is played back repeatedly.

"☞1": A single title/chapter/track is played back repeatedly.

"☞A-B": The selected part (A-B) is played back repeatedly.

No display: Repeat Playback mode is off.

11 Video Output Indicator (P) ☞ pg. 99

No display: Indicates that interlace mode is engaged.

P: Indicates that progressive mode is engaged.

(Example) P lights when video output mode is in progressive mode.

12 Group/Title Number Display ☞ pg. 7, 39

13 Track/Chapter Number Display ☞ pg. 7, 39

14 Remaining Time/Elapsed Time Indicator

☞ pg. 28, 50

Lights when remaining time of DVD-RAM, DVD-R and DVD-RW discs is displayed, and lights out when elapsed time is displayed.

The right 6 digits of the Multi Display (16) indicate elapsed or remaining time of each track.

No display: Indicates elapsed time of the disc.

Displayed: Indicates remaining time of the disc.

15 Remaining Time/Elapsed Time Display

☞ pg. 28, 50

16 Multi Display

Displays clock, received channel, elapsed time, and remaining time.

Also displays status of the unit (NO DISC/OPEN/CLOSE/READING).

ON-SCREEN DISPLAY

When "SUPERIMPOSE" is set to "AUTO" and **ON SCREEN** on the remote control is pressed, various operational indicators appear on the TV screen. To clear the operational indicators, press **ON SCREEN** again.

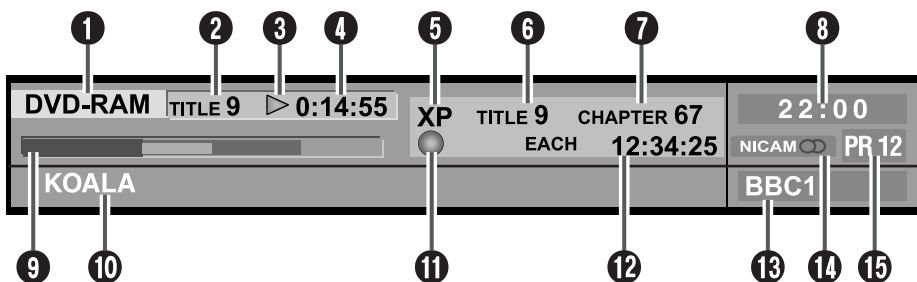

1 Disc Display

Displays the type of the disc loaded on the disc tray.

2 Title Number*

Displays number of the title currently being played back.

3 Playback Operation Status Indicator*

Indicates playback operation status by pictographs.

4 Playback Time*

Displays playback time of the title currently being played back.

5 Recording Mode

Displays recording mode as XP, SP, LP, EP, FR, FR60–FR360, FR420 and FR480. Current recording mode is displayed during recording, and recording mode in which the programme was recorded is displayed during playback. The recording mode is not displayed during play list playback.

6 Title Number

Displays playback title number during playback, and recording title number during recording.

* During Live Memory playback, playback operation status is displayed. During normal playback, the multichannel encoding method is displayed.

7 Chapter Number

Displays playback chapter number during playback, and recording chapter number during recording.

8 Clock Display

9 Bar Meter Display pg. 33

Displays playback point and other information in bar meter.

10 Title Name Display

Displays title name newly registered to the title recorded on DVD-RAM/RW/R discs, or file name of JPEG and MP3 files.

11 Operation Status Indicator

Indicates operation status by pictographs. (Also indicates its speed for forward high-speed search, reverse high-speed search and slow motion.)

12 Time Display

Displays single title playback elapsed time, single track playback elapsed time, single track remaining time, total elapsed time, total remaining time, and other information in turn.

13 Station Name Display

Displays currently selected station name.

14 Audio Display

Displays audio that is being input.

15 Input Display

Displays currently selected input.

REMOTE CONTROL

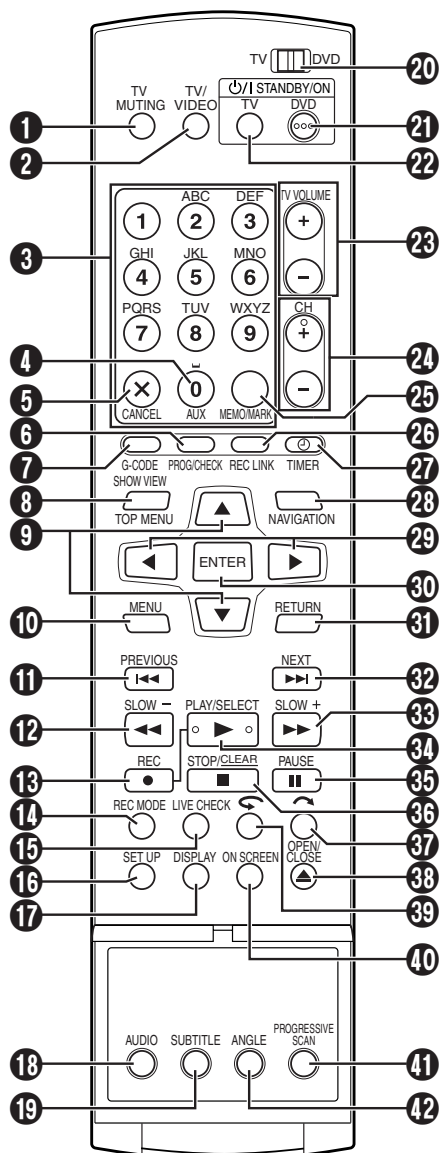

- 12 Reverse Search Button (◀◀) ☞ pg. 27, 34
- Reverse Slow Button (SLOW -) ☞ pg. 27
- 13 Record Button (●) ☞ pg. 47
- 14 Recording Mode Button (REC MODE) ☞ pg. 47
- 15 Live Check Button (LIVE CHECK) ☞ pg. 34
- 16 Set Up Button (SET UP) ☞ pg. 21
- 17 Display Button (DISPLAY) ☞ pg. 28, 49
- 18 Audio Button (AUDIO) ☞ pg. 29
- 19 Subtitle Button (SUBTITLE) ☞ pg. 29
- 20 TV/DVD switch ☞ pg. 19
- 21 DVD STANDBY/ON Button (DVD ⏻/⏻) ☞ pg. 19
- 22 TV STANDBY/ON Button (TV ⏻/⏻) ☞ pg. 84
- 23 TV Volume Button (TV VOLUME +/-) ☞ pg. 84
- 24 Channel Button (CH +/-) ☞ pg. 47
- 25 Memo Button (MEMO) ☞ pg. 64, 71, 75
- Mark Button (MARK) ☞ pg. 28
- 26 Automatic Satellite Programme Recording Button (REC LINK) ☞ pg. 61
- 27 Timer Button (⌚ (TIMER)) ☞ pg. 53, 55
- 28 Navigation Button (NAVIGATION) ☞ pg. 62
- 29 ◀ ▶ Button ☞ pg. 21, 34
- 30 Enter Button (ENTER) ☞ pg. 19
- 31 Return Button (RETURN) ☞ pg. 30, 52
- 32 Forward Skip Button (▶▶) ☞ pg. 26, 34
- Next Button (NEXT) ☞ pg. 30
- 33 Forward Search Button (▶▶) ☞ pg. 27, 34
- Forward Slow Button (SLOW +) ☞ pg. 27
- 34 Play Button (▶) ☞ pg. 25
- Select Button (SELECT)
- 35 Pause Button (||) ☞ pg. 25, 34
- 36 Stop Button (■) ☞ pg. 25, 34, 47, 76
- Clear Button (CLEAR) ☞ pg. 27, 35, 42, 52
- 37 Skip Search Button (↶) ☞ pg. 27, 34
- 38 Open/Close Button (△) ☞ pg. 9
- 39 One Touch Replay Button (↺) ☞ pg. 34, 35
- 40 On-screen Button (ON SCREEN) ☞ pg. 14, 33, 36
- 41 Progressive Scan Button (PROGRESSIVE SCAN) ☞ pg. 99
- 42 Angle Button (ANGLE) ☞ pg. 29

Buttons with a small dot on the left side of the name can also be used to operate your TV. (☞ pg. 84)

- 1 TV Muting Button (TV MUTING) ☞ pg. 84
- 2 TV/VIDEO Button ☞ pg. 49
- 3 Number Keys ☞ pg. 26, 43, 47, 52, 66, 83, 93
- Character Keys ☞ pg. 66
- 4 Auxiliary Button (AUX)
- 5 Cancel Button (X) ☞ pg. 39, 42, 52, 59, 75, 94
- 6 Programme Check Button (PROG/CHECK) ☞ pg. 59
- 7 G-CODE/SHOWVIEW Button ☞ pg. 52
- 8 Top Menu Button (TOP MENU) ☞ pg. 26
- 9 △ ▽ Button ☞ pg. 19
- 10 Menu Button (MENU) ☞ pg. 26
- 11 Reverse Skip Button (◀◀) ☞ pg. 26, 34
- Previous Button (PREVIOUS) ☞ pg. 30

How To Use

The remote control can operate most of your unit's functions, as well as basic functions of TV sets of JVC and other brands. (☞ pg. 83, "Remote Control Functions")

- Point the remote control toward the receiving window.
- The maximum operating distance of the remote control is about 8 m.

NOTES:

- When inserting the batteries, be sure to insert in the correct directions as indicated under the battery cover.
- If the remote control doesn't work properly, remove its batteries, wait for approximately 5 minutes, replace the batteries and then try operating the unit again.

Basic Connections

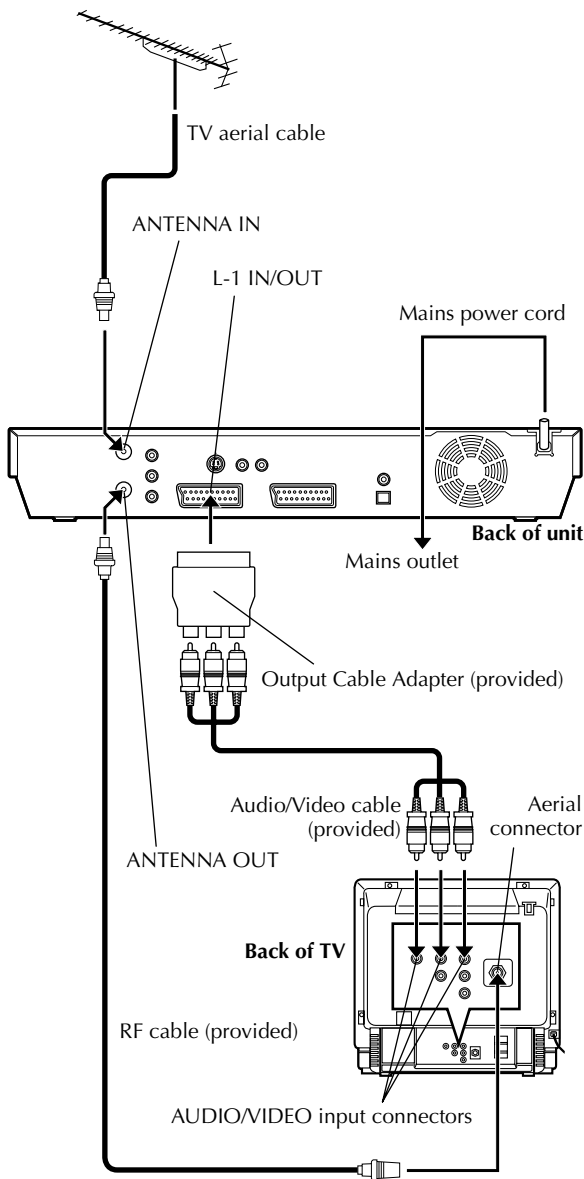

ATTENTION:

An input cable adapter and output cable adapter are provided as accessories. Use these cable adapters when connecting the unit to the TV.

- When you connect L-1 IN/OUT connector to other devices, connect the provided output cable adapter to L-1 IN/OUT connector.
- When you connect L-2 IN connector to other devices, connect the provided input cable adapter to L-2 IN connector.

It's essential that your unit be properly connected.

THESE STEPS MUST BE COMPLETED BEFORE ANY VIDEO OPERATION CAN BE PERFORMED.

1 Check the contents.

Make sure the package contains all of the accessories listed in "SPECIFICATIONS" on page 105.

2 Install the unit.

Place the unit on a stable, horizontal surface.

3 Connect the unit to a TV.

- 1 Disconnect the TV aerial cable from the TV.
- 2 Connect the TV aerial cable to the ANTENNA IN connector on the rear panel of the unit.
- 3 Connect the ANTENNA OUT connector on the rear panel of the unit and the TV's aerial connector with the provided RF cable.
- 4 Connect the L-1 IN/OUT connector on the rear panel of the unit and the TV's audio/video input connectors with an audio video cable via a cable adapter.
 - When you connect to the unit using the provided cable adapter, be sure to set "L-1 OUTPUT" to "SCART VIDEO". (pg. 80) If "L-1 OUTPUT" is set to "SCART S-VIDEO" or "SCART RGB", the image may be distorted.
 - For switching the TV's mode, refer to the instruction manual of your TV.

4 Connect the unit to mains.

Connect the AC plug of the mains power cord into a mains outlet.

- "LOADING" blinks on the front display panel when the AC plug of the mains power cord is connected into a mains outlet, and it takes the unit approximately 50 seconds to be turned on. This is not a malfunction.

Use the conversion plug (provided) depending on the type of your AC WALL outlet.

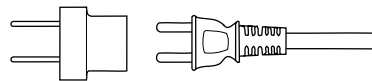

After connection is completed, perform "Auto Set Up" on page 19.

S-VIDEO Connection

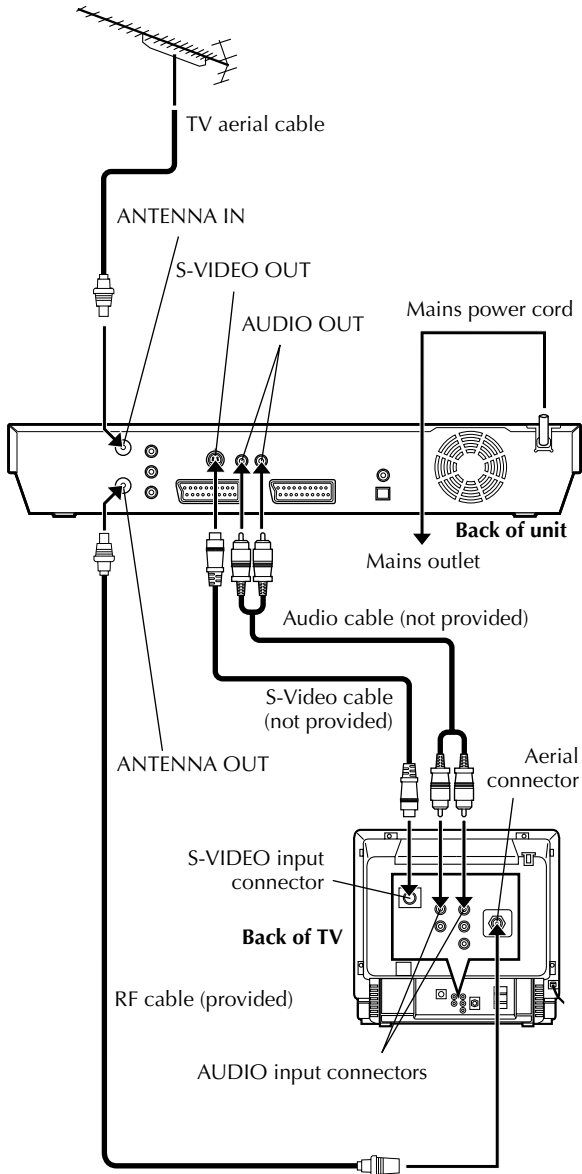

■ To connect to TV's S-VIDEO input and AUDIO input connectors

1 Connect the unit to a TV.

- 1 Connect the aerial, unit and TV as per "Basic Connections". (pg. 16)
- 2 Connect the unit's S-VIDEO OUT connector to the TV's S-VIDEO input connector.
- 3 Connect the unit's AUDIO OUT connectors to the TV's AUDIO input connectors.

2 Connect the unit to mains.

Connect the AC plug of the mains power cord into a mains outlet.

NOTES:

- You can obtain high-quality S-VHS pictures.
- If your TV is not stereo-capable, use the unit's AUDIO OUT connectors to connect to an audio amplifier for Hi-Fi stereo sound reproduction.
- For switching the TV's video input mode, refer to the instruction manual of your television.

After the connection is completed, perform "Auto Set Up" on page 19.

Auto Set Up

The Auto Set Up simplifies installation by guiding you through the procedures of setting the language, clock and tuner channels — simply follow the on-screen menus that appear.

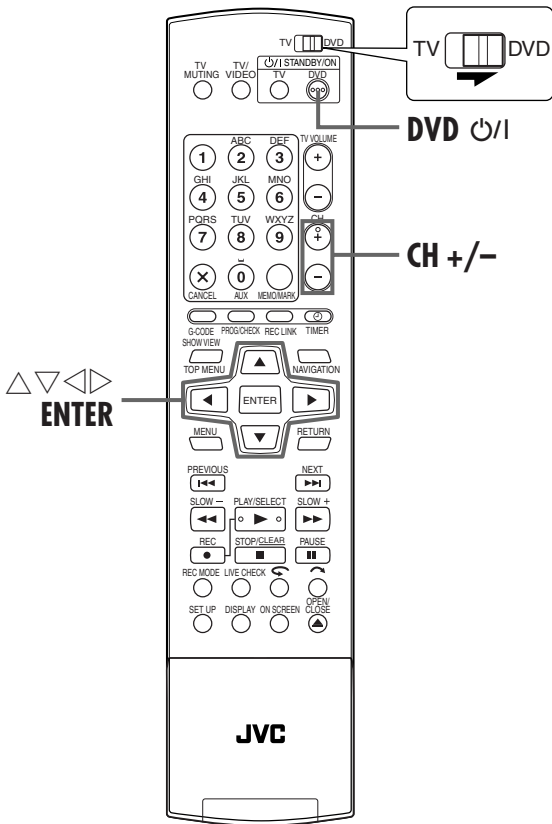
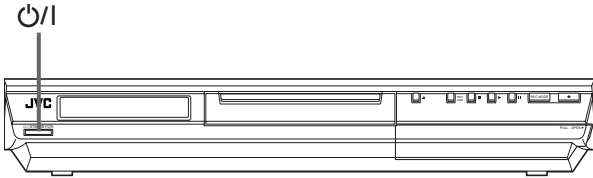

Before starting, make sure of the following:

- The TV aerial cable should be connected to the unit.
- The unit's mains power cord should be connected to a mains outlet.
- Turn on the TV and select the AV mode.
- Slide the TV/DVD switch to DVD.

1 Turn on the unit.

On the unit
Press O/I on the unit.

On the remote control
Press **DVD** O/I on the remote control.
• The Clock Set display appears on the TV screen.

2 Set the date and time.

- 1 Press Δ/∇ to select "YEAR", then press **ENTER**.
- 2 Press Δ/∇ to set the year, then press **ENTER**.

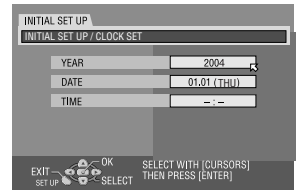

- Repeat the same procedure to set the date and time.
- When you set the time, press and hold Δ/∇ to change the time by 30 minutes.
- When you set the date, press and hold Δ/∇ to change the date by 15 days.
- If the confirmation screen appears, press $\triangleleft/\triangleright$ to select "OK", then press **ENTER**.

3 Select the TV system.

Press Δ/∇ to select the appropriate TV system (refer to the table below).

Major Countries/Areas	TV System
Australia, New Zealand, Kuwait, U.A.E., Indonesia, Singapore, Thailand, Malaysia, Iran, Saudi Arabia, Egypt, Morocco, Lebanon, Iraq	B/G
China, Mongolia, Russia	D/K
Hong Kong	I

4 Perform Auto Channel Set.

Press **ENTER**.

DO NOT press any button on the unit or remote control while Auto Set Up is in progress.

- Receivable channels in your area are automatically assigned to the **CH +/-** buttons, and non-receivable channels are skipped.
- When Auto Set Up is completed, the lowest position number will appear on the front display panel. If "SCAN COMPLETED -NO SIGNAL-" is displayed on the TV screen, make sure that the aerial cable is connected to the unit properly and press **ENTER** on the remote control. The unit will try Auto Set Up again.

ATTENTION:

If you perform Auto Set Up successfully during installation, there's no need to separately perform the Clock Set or Channel Set procedures, but if adjustments become necessary, they can be performed as follows:

- Language setting (☞ pg. 22)
- Tuner setting (☞ pg. 92)
- Clock setting (☞ pg. 96)

NOTES:

- If there is a power cut, or if you press **⏻** or **SET UP** while Auto Set Up is in progress, Auto Set Up will be interrupted; be sure to turn off the unit power once and try again from step **1**.
- If no sound accompanies the picture or the audio sounds unnatural on some channels that have been stored by Auto Set Up, the TV system setting for those channels may be incorrect. Select the appropriate TV system for those channels. (☞ pg. 95, "TV System Selection — When you see the picture but the audio can't be heard or sounds unnatural")

After "Auto Set Up" is completed, perform "Monitor Set" on page 21.

Monitor Set

You can select the monitor type depending on the TV used when you play back DVD VIDEO discs recorded for wide-screen TVs.

- Turn on the unit.
- Turn on the TV and select the AV mode.
- Slide the **TV/DVD** switch to **DVD**.

1 Access the Main Menu screen.

Press **SET UP**.

2 Access the "VIDEO IN/OUT" screen.

1 Press \triangleleft \triangleright to move the arrow to "FUNCTION SET UP", then press **ENTER**.

2 Press \triangleleft \triangleright to move the arrow to "VIDEO IN/OUT", then press **ENTER**.

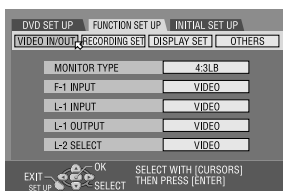

3 Select the desired option.

1 Press \triangle ∇ to select "MONITOR TYPE", then press **ENTER**.

2 Press \triangle ∇ to select the desired option, then press **ENTER**.

4 Complete the setting.

Press **SET UP**.

(The **boldface** settings in the table below indicate the settings at your purchase.)

MONITOR TYPE

4:3LB (Letter Box conversion):

Select this when the aspect ratio of your TV is 4:3 (conventional TV). While viewing a wide screen picture, the black bars appear on the top and the bottom of the screen.

4:3PS (Pan&Scan):

Select this when the aspect ratio of your TV is 4:3 (conventional TV). While viewing a wide screen picture, the black bars do not appear; however, the left and right edges of the pictures will not be shown on the screen.

16:9 AUTO (Wide television conversion):

Select this when the aspect ratio of your TV is 16:9 (wide TV).

16:9 FIX (Wide television conversion):

Select this when the aspect ratio of your TV is fixed to 16:9 (wide TV). The unit automatically adjusts the screen width of the output signal correctly when playing back a picture whose aspect ratio is 4:3.

Pan&Scan/Letter Box

In general, DVD VIDEO disc are produced for a wide-screen TV with 16:9 aspect ratio.

Material with this ratio will not fit to a TV with 4:3 aspect ratio. There are two styles to display the image, "Pan&Scan" (PS) and "Letter Box" (LB).

Pan&Scan

The right and left side of the image are cut off. The image fills the screen.

- The picture will be shown in the "4:3LB" mode depending on the disc even if the "4:3PS" mode is selected.

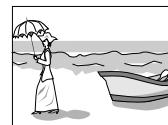

Letter Box

Black bands appear at the top and bottom of the image. The image itself appears in 16:9 aspect ratio.



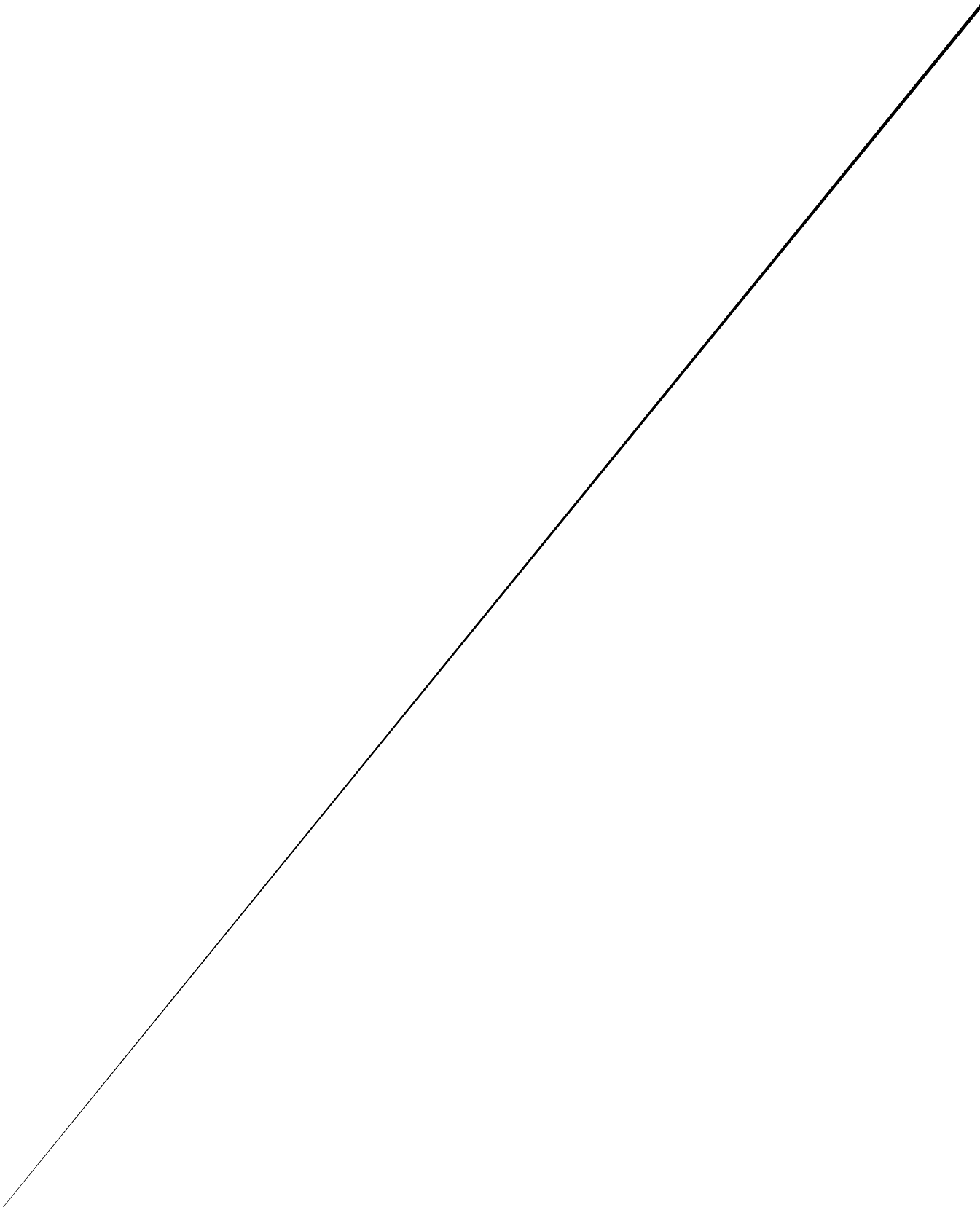

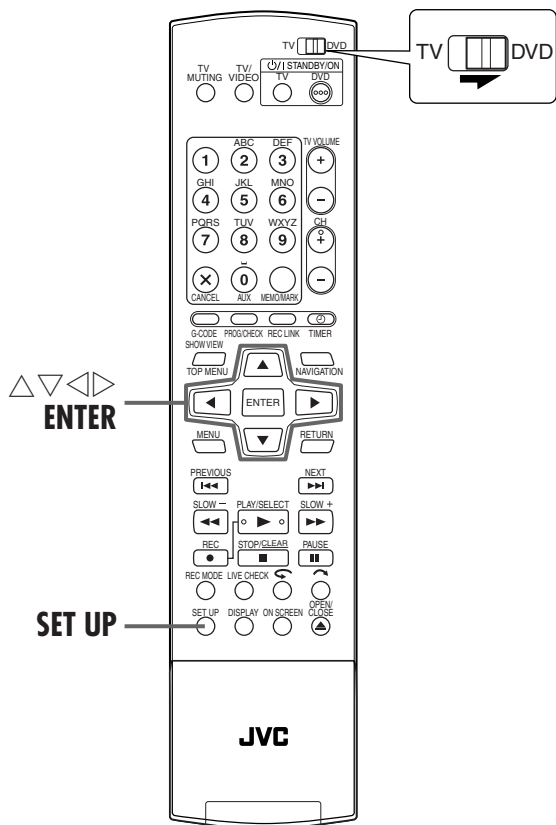

Menu/Audio/Subtitle Language Set

Some DVD discs contain the DVD menu display, audio and subtitles in multiple languages. With these discs, you can set the default language as you like.

- The procedure shows how to set "MENU LANGUAGE" as an example.

1 Access the Main Menu screen.

Press **SET UP**.

2 Access the "LANGUAGE SET" screen.

- 1 Press $\triangleleft \triangleright$ to move the arrow to "DVD SET UP", then press **ENTER**.
- 2 Press $\triangleleft \triangleright$ to move the arrow to "LANGUAGE SET", then press **ENTER**.

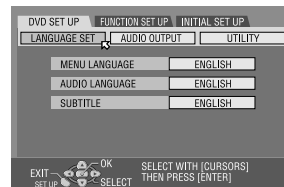

3 Select the desired language.

- 1 Press $\triangle \nabla$ to move the arrow to "MENU LANGUAGE", then press **ENTER**.
 - See "Language Code List" (pg. 24).
- 2 Press $\triangle \nabla$ to select your desired language, then press **ENTER**.

4 Complete the setting.

Press **SET UP**.

NOTE:

When the selected language is not available on the disc, the disc's default menu language is played back.

Language Code List

AA	Afar
AB	Abkhazian
AF	Afrikaans
AM	Ameharic
AR	Arabic
AS	Assamese
AY	Aymara
AZ	Azerbaijani
BA	Bashkir
BE	Byelorussian
BG	Bulgarian
BH	Bihari
BI	Bislama
BN	Bengali, Bangla
BO	Tibetan
BR	Breton
CA	Catalan
CO	Corsican
CS	Czech
CY	Welsh
DZ	Bhutani
EL	Greek
EO	Esperanto
ET	Estonian
EU	Basque
FA	Persian
FJ	Fiji
FO	Faroese
FY	Frisian
GA	Irish
GD	Scots Gaelic
GL	Galician
GN	Guarani
GU	Gujarati
HA	Hausa
HI	Hindi
HR	Croatian
HU	Hungarian
HY	Armenian
IA	Interlingua
IE	Interlingue

IK	Inupiak
IN	Indonesian
IS	Icelandic
IW	Hebrew
JI	Yiddish
JW	Javanese
KA	Georgian
KK	Kazakh
KL	Greenlandic
KM	Cambodian
KN	Kannada
KO	Korean (KOR)
KS	Kashmiri
KU	Kurdish
KY	Kirghiz
LA	Latin
LN	Lingala
LO	Laothian
LT	Lithuanian
LV	Latvian, Lettish
MG	Malagasy
MI	Maori
MK	Macedonian
ML	Malayalam
MN	Mongolian
MO	Moldavian
MR	Marathi
MS	Malay (MAY)
MT	Maltese
MY	Burmese
NA	Nauru
NE	Nepali
OC	Occitan
OM	(Afan) Oromo
OR	Oriya
PA	Panjabi
PL	Polish
PS	Pashto, Pushto
PT	Portuguese
QU	Quechua
RM	Rhaeto-Romance

RN	Kirundi
RO	Rumanian
RU	Russian
RW	Kinyarwanda
SA	Sanskrit
SD	Sindhi
SG	Sangho
SH	Serbo-Croatian
SI	Singhalese
SK	Slovak
SL	Slovenian
SM	Samoan
SN	Shona
SO	Somali
SQ	Albanian
SR	Serbian
SS	Siswati
ST	Sesotho
SU	Sundanese
SW	Swahili
TA	Tamil
TE	Telugu
TG	Tajik
TH	Thai
TI	Tigrinya
TK	Turkmen
TL	Tagalog
TN	Setswana
TO	Tonga
TR	Turkish
TS	Tsonga
TT	Tatar
TW	Twi
UK	Ukrainian
UR	Urdu
UZ	Uzbek
VI	Vietnamese
VO	Volapuk
WO	Wolof
XH	Xhosa
YO	Yoruba
ZU	Zulu

Basic Playback

DVD RAM DVD R DVD RW DVD VIDEO VCD SVCD Audio CD MP3 JPEG

- Turn on the unit.
- Turn on the TV and select the AV mode.
- Slide the TV/DVD switch to DVD.

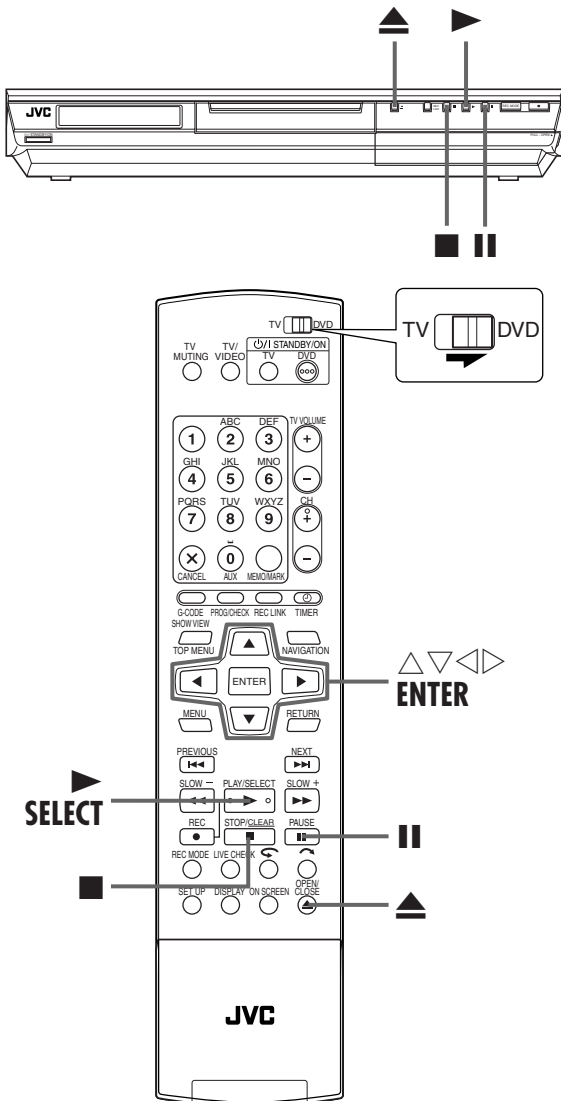

ATTENTION:

- It takes approximately 30 seconds to read a disc depending on the type and condition of the disc since this unit is multi-disc compatible (DVD-RAM, DVD-RW, DVD-R). It may even take several minutes when a disc is dirty, scratched or warped.
- It may take a few seconds to start playback. This is not a malfunction.
- Forward/reverse high-speed search and other operations cannot be performed while playback is stopped.

To play back an MP3/JPEG disc, see "Playback with MP3/JPEG Navigation" (☞ pg. 74).

1 Load a disc.

- 1 Press **▲** to open the disc tray.
- 2 Place the disc on the disc tray.
 - For details, refer to "Placing a Disc" (☞ pg. 9).
- 3 Press **▲** to close the disc tray.
 - Pressing **▶** also closes the disc tray.
 - Playback begins automatically if an auto-playback DVD disc is loaded.

2 Start playback.

Press **▶**.

- If you load a DVD disc whose region code does not match the unit, "REGION CODE ERROR" appears on the TV screen. For details, refer to "Region number of DVD VIDEO" (☞ pg. 1).
- With Video CD/SVCD discs with PBC control or some DVD discs, the menu display may appear on the TV screen after starting playback. In this case, select an item which you want to play back from the menu. Otherwise, the playback cannot go forward. Refer to "Locating a desired scene using the menu of a Video CD/SVCD with PBC" (☞ pg. 30) or "Locating a desired scene using the DVD menu" (☞ pg. 26).
- The Library Database DVD Navi also enables you to search and select the desired programmes. (☞ pg. 62)

3 Pause playback.

Press **⏸**.

- To resume normal playback, press **▶**.

4 Stop playback.

Press **■**.

- When a recordable disc is played, playback stops and a programme received with the unit's tuner resumes on the TV screen.
- When a playback-only disc is played, playback stops and the still image at the time you press **■** remains on the TV screen. Pressing **■** again resumes a programme received with the unit's tuner.
- If **▲** is pressed during playback, playback stops, then the disc tray opens.

NOTE:

When the Library Database DVD Navi screen appears, choose a thumbnail image of the desired programme on the TV screen, then press **SELECT** or **ENTER**. (☞ pg. 64)

Playback Featu

- Turn on the unit.
- Turn on the TV and select the AV mode.
- Slide the **TV/DVD** switch to **DVD**.

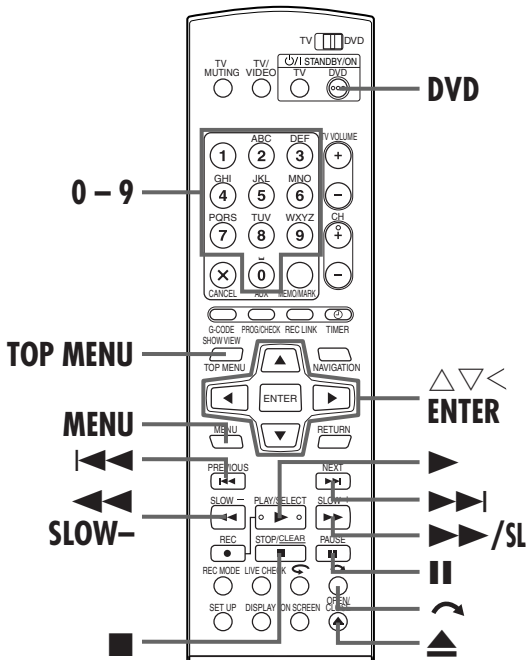

Locating a desired scene using the DVD menu



DVD VIDEO discs may have top menu and disc menu.

Top menu

DVD discs generally have their own menus which show the disc contents. These menus contain various items such as titles of a movie, names of songs, or artist information. You can locate a desired scene by using the top menu displayed on the TV screen. Press **TOP MENU** to access the top menu.

Disc menu

Disc menus include playback data (angle menu, subtitle etc.) specific to each title. Press **MENU** to access the disc menu.

1 Access the DVD menu.

Press **TOP MENU** or **MENU**.

High-Speed Search



During playback, press **▶▶** for forward search, or **◀◀** for reverse high-speed search.

- Each press of the button increases the search speed for each direction.

• To resume normal playback, press **OR**.

During playback, press and hold **▶▶** for 2 or more seconds for forward high-speed search, or **◀◀** for 2 or more seconds for reverse high-speed search.

- Releasing the button resumes normal playback.

Still Picture/Frame-B-Playback



1 Pause during playback.

Press **II**.

2 Activate frame-by-frame playback.

Press **II**.

- Each press of **II** advances the still picture by one frame.

OR

Press **◀▷**.

- Each press of **◀▷** advances/reverses the still picture by one frame.

- Frame-by-frame playback for reverse direction cannot be performed with Video CD/SVCD discs.

- To resume normal playback, press **▶**.

Slow Motion



While paused, press **SLOW -** or **SLOW +**.

- Each press of **SLOW -** or **SLOW +** increases the slow motion speed for each direction (from 1/16 to 1/2 times the normal speed).

- Slow motion for reverse direction cannot be performed with Video CD/SVCD discs.

OR

Press **◀◀** or **▶▶** for 2 or more seconds.

Skip Search

During playback, press **▶▶** for forward skip search, or **◀◀** for reverse skip search.

- Each press initiates an approximately 30-second period of fast-motion playback. Normal playback resumes automatically.

R



speed

for each

more

; and hold

ed search.



fram

re

n

2 Resume playback.

Press **▶** in stop mode. The unit starts playback from the resume point.

NOTES:

- This function works for DVD-R/DVD-RW (video mode) discs. For other types of discs, the function under "ON" setting will be applied even if "RESUME" is set to "DISC RESUME".
- If you stop the playback of a disc for which a resume point has already been memorized, the memory will be updated with the new resume point.
- After the unit has memorized the resume point for 30 discs, remembering a new resume point will cause the unit to delete the oldest memorized point. Stopping playback of a disc for which a resume point is already stored may change the order in which the points are stored. This may potentially change the order in which points are deleted.
- When the unit memorizes a resume point for a disc, it also remembers audio language, subtitle and angle settings.
- This function may not work for some Video CD or SVCD.
- When "RESUME" is changed to "ON" or "OFF", resume points of the discs memorized with "RESUME" set to "DISC RESUME" will be cleared.
- Resume points are memorized for each side of a double-sided disc.

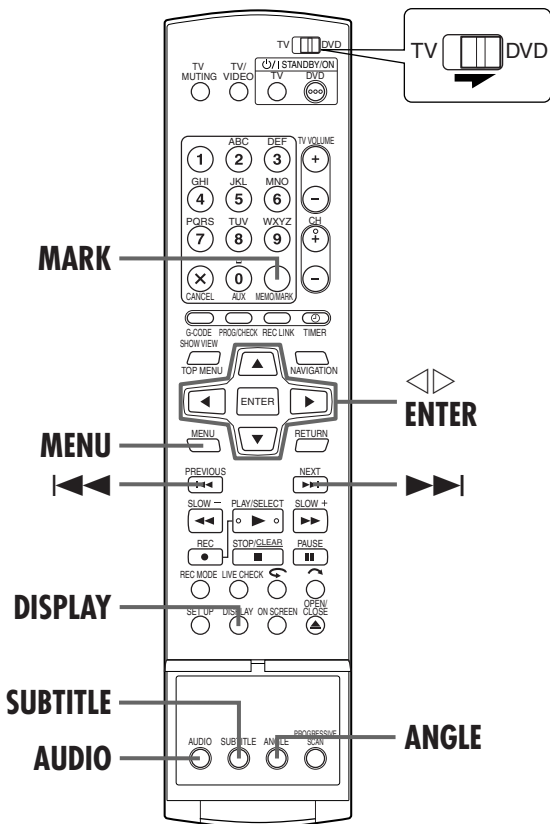

Marking positions to play again later



It is possible to mark positions (up to 999 points) where you want to play back once again later, and start playback from a marked position. Marking onto DVD-RAM/RW/R discs when recording is helpful to locate a start point when you play back the discs later.

1 Mark positions.

During playback, press **MARK** at positions you want to mark.

- "MARK" appears on the TV screen. You can easily locate the marked positions using **◀◀** or **▶▶** when you play back the disc.

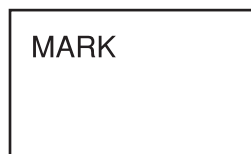

2 Delete the marked positions.

While paused, press **◀◀** or **▶▶** to locate a marked position you want to delete, then press **MARK**.

- Crossed "MARK" appears on the TV screen, and the marked position is deleted.



NOTES:

- When a monaural programme or bilingual programme changes to a stereo programme while recording, a mark signal is automatically recorded.
- When a DVD-R/RW (Video mode) disc is finalised, marked points marked before finalising will be deleted, and programmes will be divided automatically into "chapters" approximately every 5 minutes. (☞ pg. 98, "Finalise A Disc")

Checking the time information



You can change the counter display on the front display panel and TV screen to check disc remaining time (only discs before finalising).

During playback

Each press of **DISPLAY** changes the display as follows:
 Clock time (front display panel only) → Current title elapsed time → Disc remaining time → (back to the beginning)
 • Clock time is displayed only when a recordable disc is played.

In stop mode or during playback

- In FR mode, it is possible to set recording time in detail using **◀▶**. (☞ pg. 50, "Free Rate Function")
- It is not possible to switch the recording mode during playback or while recording.

Switching Time Indication



You can check time information of an audio CD and a Video CD/SVCD on the front display panel and the TV screen. Each press of **DISPLAY** changes the time indication as follows:

During playback

Current track elapsed time → Current track remaining time → Total elapsed time → Total remaining time → (back to the beginning)

In stop mode

0:00 → Playback time of track 1 → 0:00 → Total length of a disc → (back to the beginning)

NOTE:

When a PBC-compatible Video CD/SVCD disc is loaded, deactivate the PBC function. (☞ pg. 30)

ess

on d.
ay disa.
seconds.

discs contain m
n8the3e

NOTE:

It is not possible for DVD-R/DVD-RW (Video mode) disc playback to switch the audio channel. The audio channel is played back as set in "AUDIO REC" (pg. 89).

When you can't switch the audio channel of a bilingual programme

When the unit is connected with a digital audio device using an optional optical cable and "DIGITAL AUDIO OUT" is set to "DOLBY DIGITAL/PCM", it is not possible to switch the audio channel of a bilingual programme recorded on a DVD-RAM or DVD-RW (VR mode) disc. In this case, perform the following steps using the remote control to switch "DIGITAL AUDIO OUT" from "DOLBY DIGITAL/PCM" to "PCM ONLY".

- 1 Press **SET UP** to access the Main Menu screen.
- 2 Press $\triangleleft \triangleright$ to select "DVD SET UP", then press **ENTER**.
- 3 Press $\triangleleft \triangleright$ to select "AUDIO OUTPUT", then press **ENTER**.
- 4 Press $\triangle \nabla$ to select "DIGITAL AUDIO OUT", then press **ENTER**.
- 5 Press $\triangle \nabla$ to select "PCM ONLY", then press **ENTER**. (pg. 88)
- 6 Press **SET UP** to complete the setting.
- 7 Press **AUDIO** to select the desired audio channel.

Playback Control (PBC) Function
— Locating a desired scene using the menu of a Video CD/SVCD with PBC



Some Video CD/SVCD discs support the PBC function. PBC is an abbreviation of "Play Back Control". A Video CD/SVCD disc recorded with PBC has its own menus, such as a list of the songs on the disc. You can locate a specific scene by using the menu.

1 Access the PBC menu.

In stop mode

Press \blacktriangleright .

2 Start playback.

Press the **number keys** to enter the number of the desired scene.

- The unit starts playback of the selected item. "PBC" appears on the front display panel.
- When "NEXT" or "PREVIOUS" appears on the TV screen: Pressing **NEXT** advances to the next page. Pressing **PREVIOUS** returns to the previous page.
- You can return to the menu by pressing **RETURN**.
- The method of the operation is different depending on the disc.

NOTES:

- If you want to playback a PBC-compatible Video CD/SVCD disc without activating the PBC function, start playback in stop mode by using the **number keys**, instead of the \blacktriangleright button, to choose the track, then press **ENTER**.
- To activate the PBC function when a PBC-compatible Video CD/SVCD disc is being played back without the PBC function, press **TOP MENU**, or press \blacksquare then press \blacktriangleright .

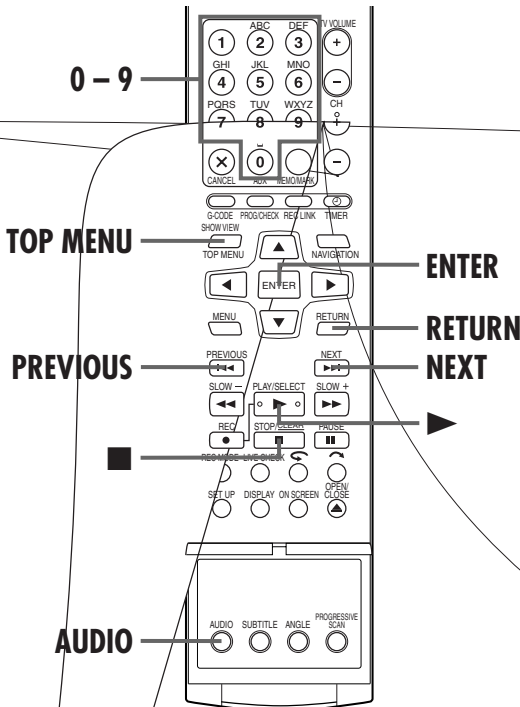

Audio Channel Selection



When you are watching bilingual programmes or playing discs on which you can choose the audio channel.

- When "SUPERIMPOSE" is set to "AUTO", you can confirm on the screen the audio channel you have chosen. (pg. 90)
- Each time you press **AUDIO**, the audio channel changes.

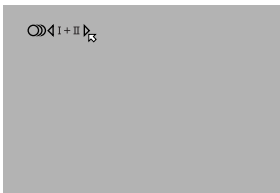

TRACK	USE
On-Screen Display	
$\odot \blacktriangleleft 1 + \text{II} \blacktriangleright \text{PBC}$	For main and sub audio of bilingual programme
$\odot \blacktriangleleft I \blacktriangleright \text{PBC}$	For main audio of bilingual programme
$\odot \blacktriangleleft II \blacktriangleright \text{PBC}$	For sub audio of bilingual programme
$\odot \blacktriangleleft L + R \blacktriangleright \text{PBC}$	For stereo discs
$\odot \blacktriangleleft L \blacktriangleright \text{PBC}$	For audio of left channel
$\odot \blacktriangleleft R \blacktriangleright \text{PBC}$	For audio of right channel

Live Memory Playback

DVD RAM **DVD R** **DVD RW** **DVD VIDEO** **VCD SVCD** **Audio CD** **MP3** **JPEG**

This unit records pictures onto DVD-RAM discs, instead of video tapes, then plays back the pictures recorded on the discs. This makes it possible to achieve high-speed writing and read-out that has not been possible with conventional VCRs, enabling recording and playback simultaneously.

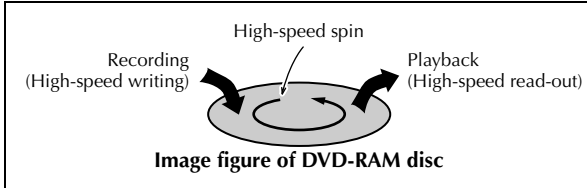

It is called "Live Memory Playback" to start playback of the programme being recorded, with a time-lag between a recording point and a playback point, as shown in the figure below.

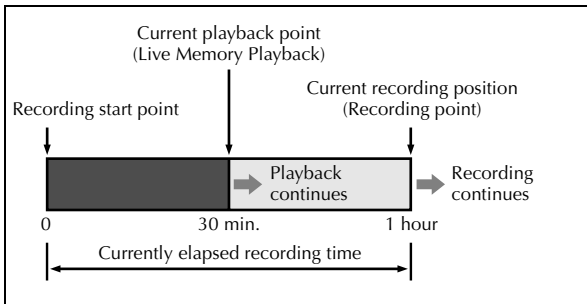

Not only can this unit play back a programme previously recorded while recording or timer recording another programme, but the unit also allows you to play back from the beginning of a programme while continuing to record the same programme.

Recording/playback status display

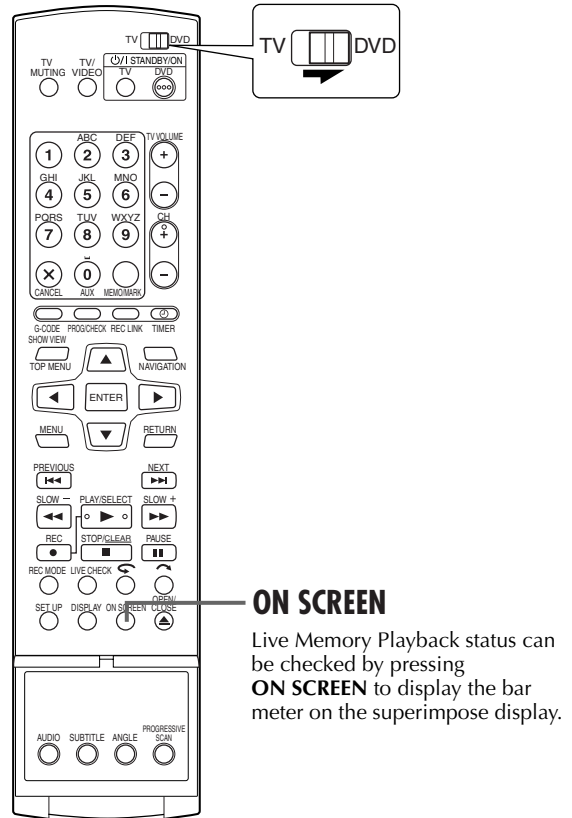

Press **ON SCREEN**. The current status is superimposed on the TV screen.





☞ pg. 62).

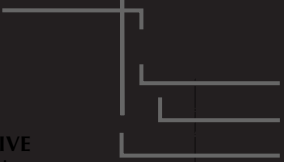

Pressing **LIVE CHECK** during
ve Mémory
Playback allows
you to check the
picture currently
being recorded.

Playback during Live Memory Playback

During recording, you can watch at your will what was previously recorded or is currently being recorded. It is possible to perform various playback operations (forward/reverse high-speed search and variable-speed search) within the range of the orange or red area on the TV screen.

When Memory Playback reaches the point of 30 seconds before the current recording point by forward high-speed search or other operations, the playback position returns to normal playback.

Live Check picture appears by pressing **ON SCREEN**. (pg. 14)
 Live Check picture is displayed on the bottom right corner by pressing **LIVE CHECK**.

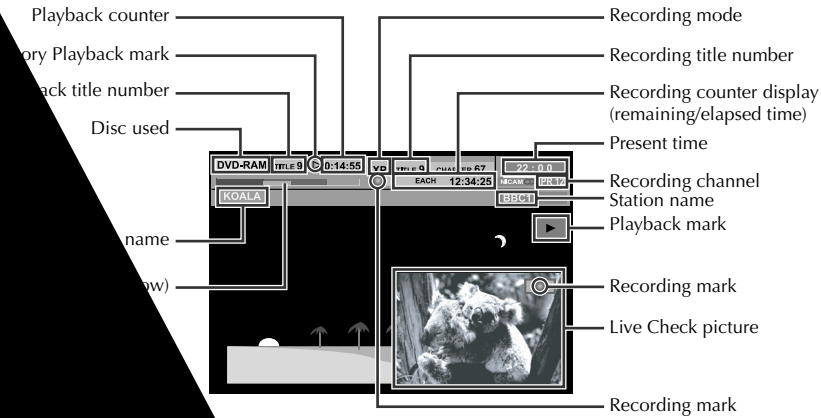

Recording status by the bar meter.

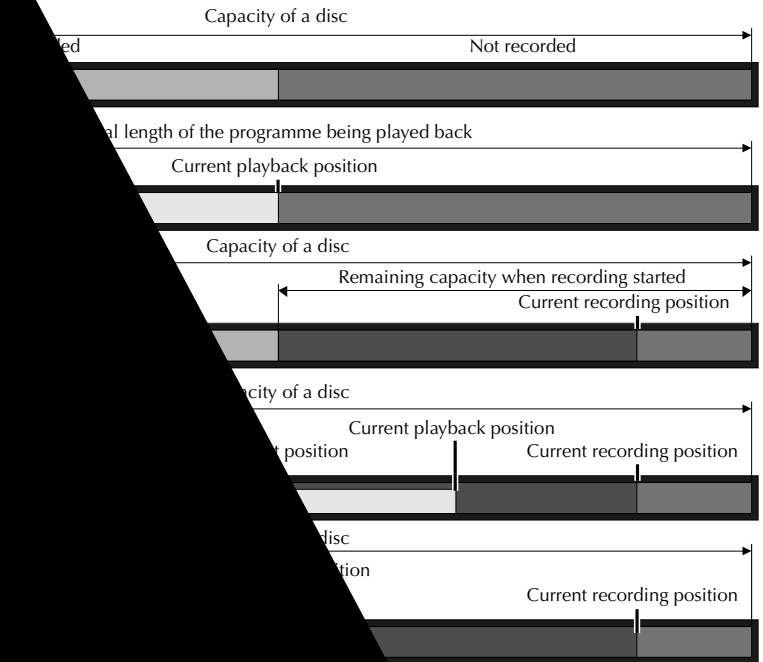

(Playing part)

(Recorded or unplayed part)

Buttons to be used during Live Memory Playback

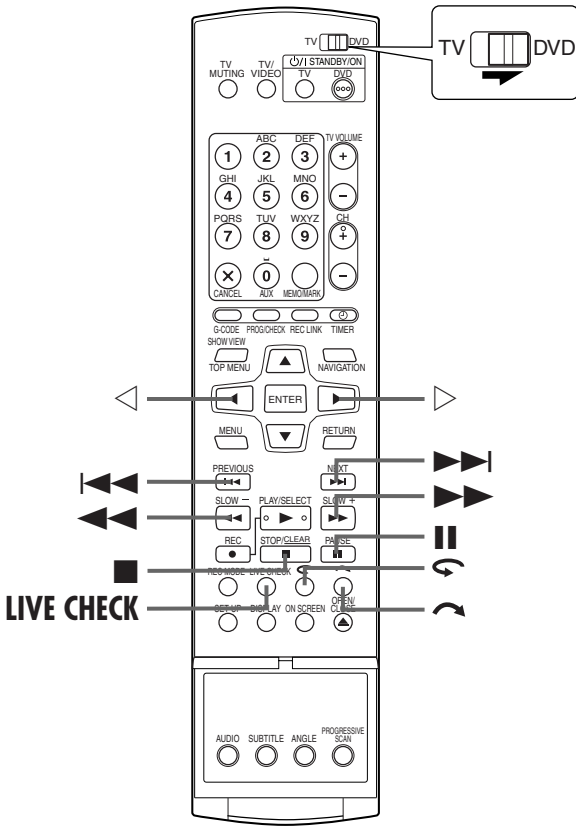

Available buttons

Functions

- Pressing once skips forward to the beginning of the next chapter being played back.
- Pressing down for 2 or more seconds during playback advances playback at 5 times the normal speed while pressed. Releasing the button resumes normal playback.

Available only when paused

- Pressing down for 2 or more seconds advances playback at 1/16 times the normal speed.
- Pressing once skips back to the beginning of the chapter being played back.
- Pressing down for 2 or more seconds during



LIVE CHECK



- Turn on the unit.
- Turn on the TV and select the AV mode.
- Slide the **TV/DVD** switch to **DVD**.

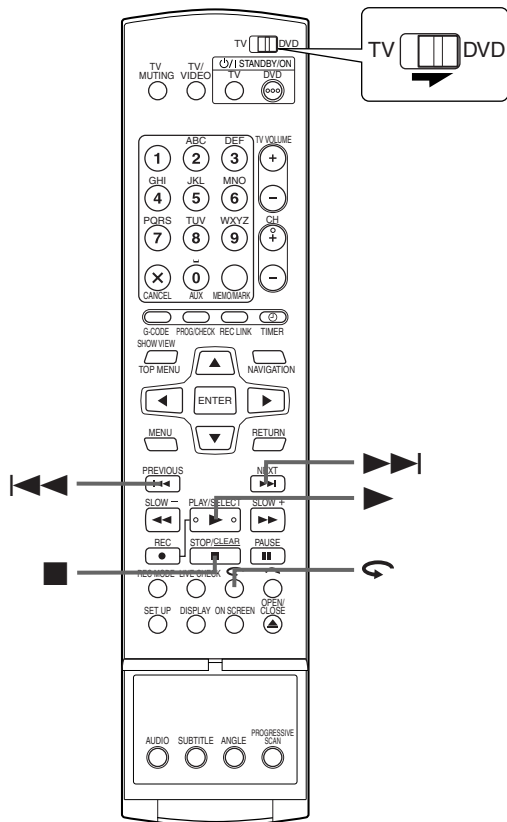

To play back from the beginning of the programme while recording

You can play back a programme you are recording from the beginning while continuing to record or timer record onto a DVD-RAM disc.

1 Start Live Memory Playback.

Press **▶**.

- Playback starts from the beginning of the programme being recorded.
- Pressing **◀◀/▶▶** allows you to locate the desired scenes.

To move back the playback position slightly while recording (One Touch Replay function)

You can move back the playback position while continuing to record or timer record onto a DVD-RAM disc.

1 Start One Touch Replay function.

Press **◀◀**.

- Each press skips back for approximately 7 seconds and resumes playback.
- Pressing while paused skips back for approximately 7 seconds and resumes pause.

To watch a programme previously recorded while recording

You can play back a programme you recorded previously while recording.

1 Start Live Memory Playback.

Press **▶** while recording to establish Live Memory Playback mode.

2 Locate the beginning of the desired programme.

Press **◀◀** or **▶▶**.

NOTE:

To stop playback, press **■**. The programme being recorded is displayed.

Using Play Set Up Menu



Play Set Up Menu allows you to control various playback functions. Some of the functions operated on Navigation Menu can be controlled on Set Up Menu.

Before using Play Set Up Menu

Be sure to clear Library Database DVD Navi screen by pressing **NAVIGATION**.

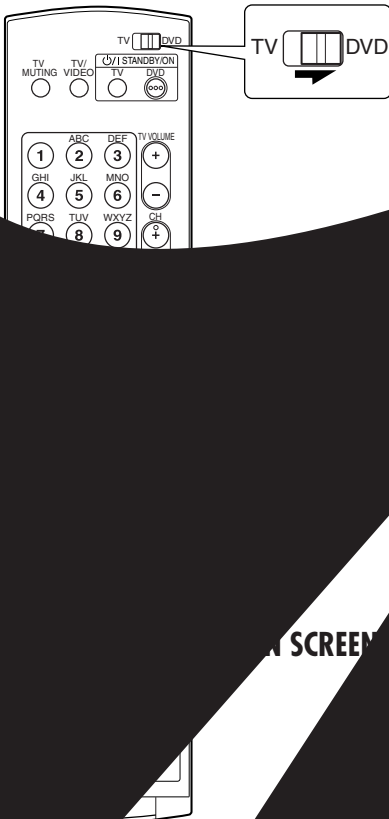

How to Access Play Set Up Menu

Press **ON SCREEN** twice whenever a disc is loaded.

Contents of Play Set Up Menu during playback

DVD VIDEO

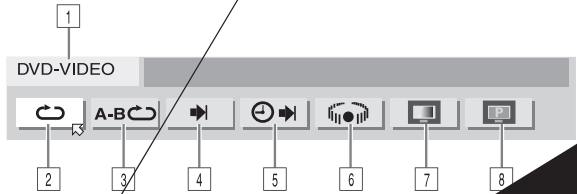

Video CD/SVCD

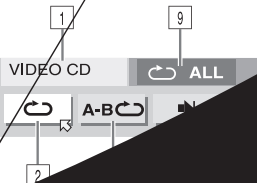

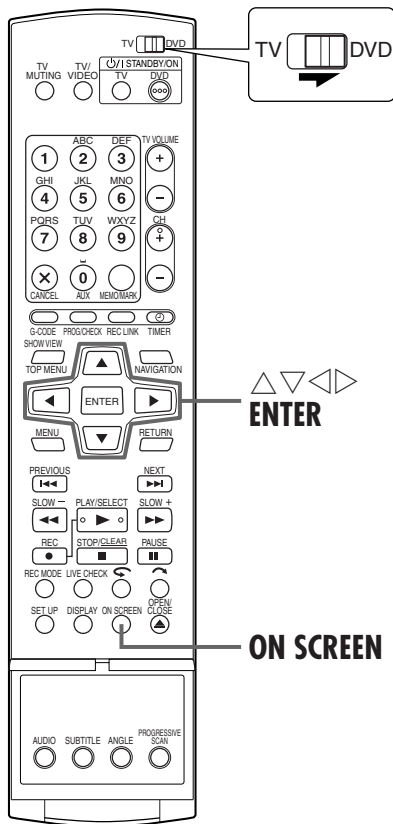

Basic operation on Play Set Up Menu

Example: When selecting Picture Control function of DVD

During playback or while stopped

1 Access Play Set Up Menu.

Press **ON SCREEN** twice.

- The item currently selected is highlighted and pointed by .



2 Select the menu item.

Press  to select "Picture Control", then press **ENTER**.

- The pop-up window appears under the selected item.



3 Select the option.

Press  to select the desired option, then press **ENTER**.

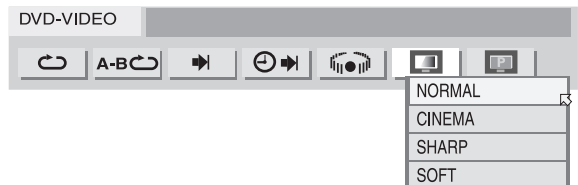

To clear Play Set Up Menu

Press **ON SCREEN**.

NOTE:

See the corresponding pages for details on each menu item.

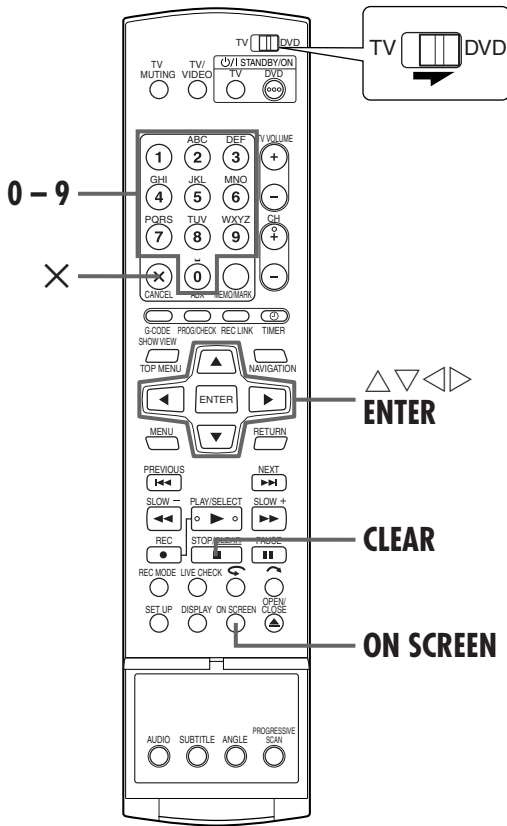

Repeat Playback



You can repeat playback as you like according to the type of disc.

1 Access Play Set Up Menu.

Press **ON SCREEN** twice.

2 Select the menu item.

Press ◀ ▶ to select “⏮”, then press **ENTER**.

- The pop-up window appears under the selected item.



3 Select the repeat mode.

Press ▲ ▼ repeatedly to select the desired Repeat mode, then press **ENTER**.

DVD-RAM/RW/R

OFF:	Repeat playback is not performed.
ALL REPEAT:	The whole disc is played back repeatedly.
TITLE REPEAT:	The current title is played back repeatedly.

DVD VIDEO

OFF:	Repeat playback is not performed.
TITLE REPEAT:	The current title is played back repeatedly.
CHAPTER REPEAT:	The current chapter is played back repeatedly.

Audio CD/Video CD/SVCD/JPEG/MP3

OFF:	Repeat playback is not performed.
ALL REPEAT:	The whole disc is played back repeatedly.
TRACK REPEAT*:	The current track is played back repeatedly.

* “TRACK REPEAT” cannot be selected for JPEG discs.

To clear Play Set Up Menu

Press **ON SCREEN**.

To cancel Repeat Playback

Repeat the above procedure from step 1, select “OFF” in step 3, then press **ENTER**.

NOTES:

- Repeat Playback is not possible for a Video CD/SVCD with PBC function.
- Repeat Playback may not work properly depending on the type of the disc being used.

A-B Repeat Playback



You can repeat the desired part.

During playback

1 Access Play Set Up Menu.

Press **ON SCREEN** twice.

2 Select the menu item.

Press $\triangleleft \triangleright$ to select “**A-B**”.

3 Locate the start point.

Press **ENTER** at the beginning of the desired part you want to repeat (point A).

- The elapsed playing time of the point A appears



4 Locate the end point and start A-B Repeat Playback.

Press **ENTER** at the end of the desired part you want to repeat (point B).

- The elapsed playing time of the point B appears.
- The selected part of the disc (between point A and B) is played repeatedly.



To clear Play Set Up Menu

Press **ON SCREEN**.

To cancel A-B Repeat Playback

Press $\triangleleft \triangleright$ to select “**A-B**”, then press **ENTER**.

NOTES:

- A-B Repeat Playback may not work properly depending on the type of disc being used.
- The subtitles recorded around the A-B point may not appear.
- When the end of the item is reached before the end point is set, Play Set Up Menu disappears from the TV screen. In such a case, repeat the procedure from step 1.
- The point B must be set at least 3 seconds after the point A.
- When playing back a DVD, A-B Repeat Playback is possible only within the same title.
- “**A-B**” cannot be selected during Programme and Random Playback.
- “**A-B**” cannot be selected while stopped.

Locating the beginning of a desired selection



You can locate the beginning of a title, chapter, group or track.

During playback or while stopped

1 Access Play Set Up Menu.

Press **ON SCREEN** twice.

2 Select the menu item.

Press $\triangleleft \triangleright$ to select “**▶**”, then press **ENTER**.

3 Select the desired item.

For DVD-RAM/RW/R, DVD VIDEO

“TITLE SEARCH” or “CHAPTER SEARCH” is selectable. (“TITLE SEARCH” only is selectable while stopped.)

For JPEG, MP3

“GROUP SEARCH” or “TRACK SEARCH” is selectable.

For Video CD/SVCD, Audio CD

“TRACK” is selectable.

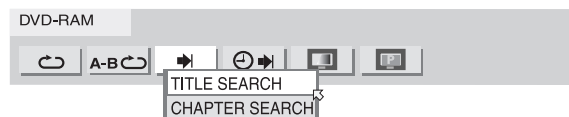

Press $\triangle \nabla$ to select the desired item, then press **ENTER**.

- Skip this step for Video CD/SVCD and Audio CD.

4 Specify the number of the selected item.

Press **number keys** (1–9, 0) to enter the desired item number, then press **ENTER**.

- Playback starts from the selected section.

Examples:

- To select track 5, press the **number key “5”**.
- To select track 15, press the **number key “1”** and “5”.
- To select track 25, press **number key “2”**, then “5”.

If you have specified a wrong selection

Press **X** or **CLEAR** to clear the wrong number, then enter the correct one before you press **ENTER** in this step.

To clear Play Set Up Menu

Press **ON SCREEN**.

NOTES:

- When “**⊗**” is displayed on the TV screen in step 4, the chapter you have selected is not contained in the disc, or chapter search does not work on the disc.
- Before you press **ENTER**, playback may start automatically when you enter the section’s number depending on the disc.
- This function is not possible for a Video CD/SVCD with PBC function.

Time Search



You can play back a disc from the desired point by specifying the elapsed playing time from the beginning of a title (DVD-RAM, DVD-R, DVD-RW and DVD VIDEO) or a disc (Video CD/SVCD and Audio CD).

1 Access Play Set Up Menu.

Press **ON SCREEN** twice.

2 Select the menu item.

Press $\triangleleft \triangleright$ to select “”, then press **ENTER**.

- The pop-up window appears under the selected item.



3 Enter the time.

Use **number keys** (1–9, 0) to enter the time, then press **ENTER**.

- Playback starts from the specified time.

Example:

To play back from a point 12 (minutes): 50 (seconds) elapsed.

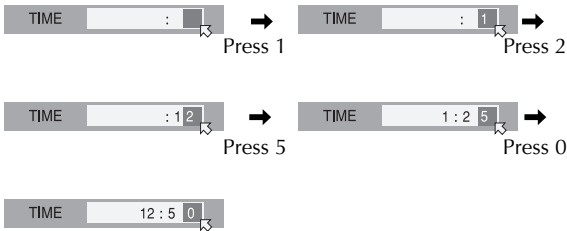

If you have specified a wrong selection,

Press **X** (for the last entered number) or **■** (for whole numbers) to clear the wrong number, then enter the correct one(s) before you press **ENTER** in this step.

To clear Play Set Up Menu

Press **ON SCREEN**.

NOTES:

- When “” is displayed on the TV screen in step 3, you have selected a point that exceeds the recording time of the disc.
- Some DVD VIDEO discs do not contain time information, and it is not possible to use the Time Search function. In such cases, “” is displayed on the TV screen as well.
- This function is not possible for a Video CD/SVCD with PBC function.

Simulated Surround Effect



It is possible to get a simulated surround effect from your stereo system. You can enjoy the virtual surround sound with your 2-channel stereo system.

1 Access Play Set Up Menu.

Press **ON SCREEN** twice.

2 Select the menu item.

Press $\triangleleft \triangleright$ to select “”, then press **ENTER**.

- Above the selected item, “3D-ON” appears and Simulated Surround Effect is activated.
- Each time you press **ENTER**, “3D-ON” appears and disappears alternately.



To cancel the simulated surround effect

Press **ENTER** to clear “3D-ON” from the screen.

NOTES:

- The simulated surround effect works correctly only when playing back a title recorded in multichannels.
- Simulated Surround Effect does not affect the DVD VIDEO bitstream signal from the “DIGITAL AUDIO OUT” connector.
- When Simulated Surround Effect is activated, the settings of “ANALOG AUDIO OUT” and “D. RANGE CONTROL” are disabled. (ⓘ pg. 88)

Adjusting the picture quality



You can obtain optimal picture quality by selecting an appropriate picture mode.

1 Access Play Set Up Menu.

Press **ON SCREEN** twice.

2 Select the menu item.

Press $\triangleleft \triangleright$ to select “”, then press **ENTER**.

- The pop-up window appears under the selected item.



3 Select the desired option.

Press $\triangle \nabla$ to select the desired option, then press **ENTER**.

NORMAL:	Normally select this option.
CINEMA:	Suitable for a movie disc, etc.
SHARP:	Clearer, sharper-edged picture when viewing images with lots of flat, same-coloured surfaces such as cartoons.
SOFT:	Select this option when too much noise appears.

Setting the progressive mode



You can obtain optimal picture quality by selecting whether the content on the disc is processed by field (video source) or by frame (film source).

1 Access Play Set Up Menu.

Press **ON SCREEN** twice.

2 Select the menu item.

Press $\triangleleft \triangleright$ to select “”, then press **ENTER**.

- The pop-up window appears under the selected item.



3 Select the desired option.

Press $\triangle \nabla$ to select the desired option, then press **ENTER**.

AUTO 1:	Used to play a disc containing both video and film source materials. This system recognizes the source type (video or film) of the current disc according to the disc information. Normally select this option.
AUTO 2:	Almost the same as the “AUTO 1”, but the processing of the scenes with movement is different. Select “AUTO 1” or “AUTO 2” to your preference.
FILM:	Suitable for playing back a progressive scanned film source disc.
VIDEO:	Suitable for playing back a video source disc. The outlines on the played back pictures will be soft.

NOTE:

When the progressive mode is set, be sure to set “L-1 OUTPUT” to “COMPONENT”. (☞ pg. 80, “L-1 Output and L-1 Input Setting (L-1 OUTPUT and L-1 INPUT)”) Progressive scan is output only from COMPONENT VIDEO OUT connector.

Parental Lock



This function restricts playback of DVD VIDEO discs which contain violent (and other) scenes according to the level set by the user. For example, if a movie which includes violent scenes supports the parental lock feature, such scenes which you do not want to let children view can be cut or replaced by other scenes.

- Turn on the unit.
- Turn on the TV and select the AV mode.
- Slide the TV/DVD switch to DVD.

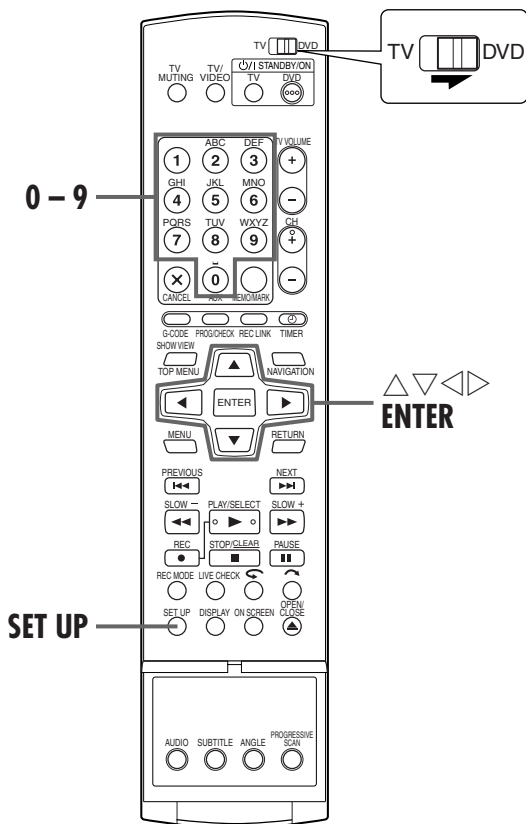

To set Parental Lock for the first time

While stopped

1 Access the "DVD SET UP" screen.

- 1 Press **SET UP**.
- 2 Press $\triangleleft \triangleright$ to select "DVD SET UP", then press **ENTER**.

2 Access the "PARENTAL LOCK" screen.

- 1 Press $\triangleleft \triangleright$ to select "UTILITY", then press **ENTER**.
- 2 Press $\triangle \nabla$ to select "PARENTAL LOCK", then press **ENTER**.

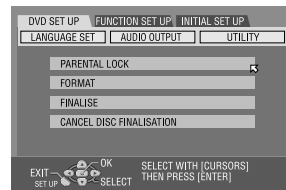

3 Select the desired level.

- 1 Press $\triangle \nabla$ repeatedly to select "PARENTAL LEVEL", then press **ENTER**.
 - 2 Press $\triangle \nabla$ repeatedly to select the desired level, then press **ENTER**.
- The smaller the value of level is, the more restrictive the Parental Lock level becomes.
 - Select "NONE" to cancel the restriction.



4 Enter your password.

Press the **number keys** to enter your desired four-digit number, then press **ENTER**.

- If you made a mistake, enter a correct number again.



5 Select your country code.

- 1 Press $\triangle \nabla$ repeatedly to select "COUNTRY CODE", then press **ENTER**.
 - 2 Press $\triangle \nabla$ repeatedly to select your country code, then press **ENTER**.
- If you do not need to change your country code, jump to 7.
 - See "Country/Area Code List for Parental Lock" (pg. 45).

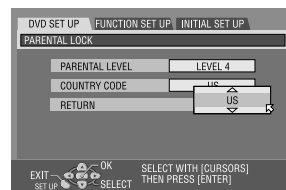

6 Enter your password.

Press the **number keys** to enter the same password as in step 4 above, then press **ENTER**.

7 Complete the setting.

Press **SET UP** twice.

- The normal screen resumes.

NOTE:

Remember your password, or make a note of it.

To change the settings

You can change the Parental lock settings later.

1 Change the level.

- 1 Press \triangle / ∇ repeatedly to select "PARENTAL LEVEL", then press **ENTER**.
- 2 Press \triangle / ∇ repeatedly to select the desired level, then press **ENTER**.

2 Change the country code.

- 1 Press \triangle / ∇ repeatedly to select "COUNTRY CODE", then press **ENTER**.
 - 2 Press \triangle / ∇ repeatedly to select your country code, then press **ENTER**.
- See "Country/Area Code List for Parental Lock" (📖 pg. 45).

3 Enter your password.

Press the **number keys** to enter the same password as in step **4** of "To set Parental Lock for the first time", then press **ENTER**.

4 Complete the setting.

Press **SET UP** twice.

- The normal screen resumes.

NOTE:

If you forget your password, enter "8888" in step **3**.

To temporarily release Parental Lock

When you set the parental lock level strictly, some discs may not be played back at all. When you insert such a disc and try to play it back, the confirmation screen appears on the TV screen, asking you whether you want Parental Lock to be temporarily released or not.

1 Access the password screen.

- 1 Place the disc on the disc tray.
 - If the disc is rated higher than the selected level, the confirmation screen appears.
- 2 Press \triangleleft / \triangleright to select "YES", then press **ENTER**.
 - If you select "NO", you cannot play back that disc.

2

Country/Area Code List for Parental Lock

AD	Andorra	ES	Spain
AE	United Arab Emirates	ET	Ethiopia
AF	Afghanistan	FI	Finland
AG	Antigua and Barbuda	FJ	Fiji
AI	Anguilla	FK	Falkland Islands (Malvinas)
AL	Albania	FM	Micronesia (Federated States of)
AM	Armenia	FO	Faroe Islands
AN	Netherlands Antilles	FR	France
AO	Angola	FX	France, Metropolitan
AQ	Antarctica	GA	Gabon
AR	Argentina	GB	United Kingdom
AS	American Samoa	GD	Grenada
AT	Austria	GE	Georgia
AU	Australia	GF	French Guiana
AW	Aruba	GH	Ghana
AZ	Azerbaijan	GI	Gibraltar
BA	Bosnia and Herzegovina	GL	Greenland
BB	Barbados	GM	Gambia
BD	Bangladesh	GN	Guinea
BE	Belgium	GP	Guadeloupe
BF	Burkina Faso	GQ	Equatorial Guinea
BG	Bulgaria	GR	Greece
BH	Bahrain	GS	South Georgia and the South Sandwich Islands
BI	Burundi	GT	Guatemala
BJ	Benin	GU	Guam
BM	Bermuda	GW	Guinea-Bissau
BN	Brunei Darussalam	GY	Guyana
BO	Bolivia	HK	Hong Kong
BR	Brazil	HM	Heard Island and McDonald Islands
BS	Bahamas	HN	Honduras
BT	Bhutan	HR	Croatia
BV	Bouvet Island	HT	Haiti
BW	Botswana	HU	Hungary
BY	Belarus	ID	Indonesia
BZ	Belize	IE	Ireland
CA	Canada	IL	Israel
CC	Cocos (Keeling) Islands	IN	India
CF	Central African Republic	IO	British Indian Ocean Territory
CG	Congo	IQ	Iraq
CH	Switzerland	IR	Iran (Islamic Republic of)
CI	Côte d'Ivoire	IS	Iceland
CK	Cook Islands	IT	Italy
CL	Chile	JM	Jamaica
CM	Cameroon	JO	Jordan
CN	China	JP	Japan
CO	Colombia	KE	Kenya
CR	Costa Rica	KG	Kyrgyzstan
CU	Cuba	KH	Cambodia
CV	Cape Verde	KI	Kiribati
CX	Christmas Island	KM	Comoros
CY	Cyprus	KN	Saint Kitts and Nevis
CZ	Czech Republic	KP	Korea, Democratic People's Republic of
DE	Germany	KR	Korea, Republic of
DJ	Djibouti	KW	Kuwait
DK	Denmark	KY	Cayman Islands
DM	Dominica	KZ	Kazakhstan
DO	Dominican Republic	LA	Lao People's Democratic Republic
DZ	Algeria	LB	Lebanon
EC	Ecuador		
EE	Estonia		
EG	Egypt		
EH	Western Sahara		
ER	Eritrea		

LC	Saint Lucia
LI	Liechtenstein
LK	Sri Lanka
LR	Liberia
LS	Lesotho
LT	Lithuania
LU	Luxembourg
LV	Latvia
LY	Libyan Arab Jamahiriya
MA	Morocco
MC	Monaco
MD	Moldova, Republic of
MG	Madagascar
MH	Marshall Islands
ML	Mali
MM	Myanmar
MN	Mongolia
MO	Macau
MP	Northern Mariana Islands
MQ	Martinique
MR	Mauritania
MS	Montserrat
MT	Malta
MU	Mauritius
MV	Maldives
MW	Malawi
MX	Mexico
MY	Malaysia
MZ	Mozambique
NA	Namibia
NC	New Caledonia
NE	Niger
NF	Norfolk Island
NG	Nigeria
NI	Nicaragua
NL	Netherlands
NO	Norway
NP	Nepal
NR	Nauru
NU	Niue
NZ	New Zealand
OM	Oman
PA	Panama
PE	Peru
PF	French Polynesia
PG	Papua New Guinea
PH	Philippines
PK	Pakistan
PL	Poland
PM	Saint Pierre and Miquelon
PN	Pitcairn
PR	Puerto Rico
PT	Portugal
PW	Palau
PY	Paraguay
QA	Qatar
RE	Réunion
RO	Romania
RU	Russian Federation
RW	Rwanda

SA	Saudi Arabia
SB	Solomon Islands
SC	Seychelles
SD	Sudan
SE	Sweden
SG	Singapore
SH	Saint Helena
SI	Slovenia
SJ	Svalbard and Jan Mayen
SK	Slovakia
SL	Sierra Leone
SM	San Marino
SN	Senegal
SO	Somalia
SR	Suriname
ST	Sao Tome and Principe
SV	El Salvador
SY	Syrian Arab Republic
SZ	Swaziland
TC	Turks and Caicos Islands
TD	Chad
TF	French Southern Territories
TG	Togo
TH	Thailand
TJ	Tajikistan
TK	Tokelau
TM	Turkmenistan
TN	Tunisia
TO	Tonga
TP	East Timor
TR	Turkey
TT	Trinidad and Tobago
TV	Tuvalu
TW	Taiwan
TZ	Tanzania, United Republic of
UA	Ukraine
UG	Uganda
UM	United States Minor Outlying Islands
US	United States
UY	Uruguay
UZ	Uzbekistan
VA	Vatican City State (Holy See)
VC	Saint Vincent and the Grenadines
VE	Venezuela
VG	Virgin Islands (British)
VI	Virgin Islands (U.S.)
VN	Viet Nam
VU	Vanuatu
WF	Wallis and Futuna Islands
WS	Samoa
YE	Yemen
YT	Mayotte
YU	Yugoslavia
ZA	South Africa
ZM	Zambia
ZR	Zaire
ZW	Zimbabwe

1

[

[

Recording Features

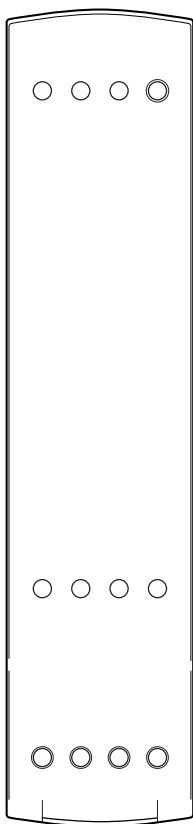
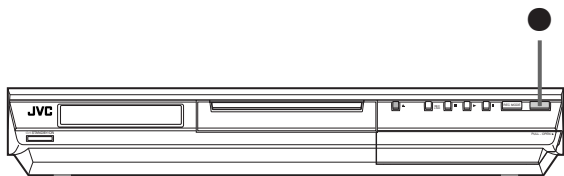

Recording Speed

MPEG2 format is used as recording format. As a guide for picture quality, the "bps" unit is used to represent how much data can be recorded per second. The larger this value is, the better the picture quality becomes but more capacity is required for the recording. Select XP or SP for programmes where quick movement occurs, such as sports programmes, and LP or EP for talk shows, etc. with relatively less movement.

The recording speeds for a 4.7 GB disc are set as follows:

Instant Timer Recording (ITR)

This easy method lets you record for from 30 minutes to 6 hours (selectable in 30-min. increments), and shuts the unit off after recording is finished.

1 Start recording.

Press ● on the unit.

2 Engage the ITR mode.

Press ● again. On the front display panel, "0:30" appears.

3 Set the recording duration.

If you want to record for more than 30 minutes, press ● to extend the time. Each press extends recording time by 30 minutes.

NOTE:

You can only perform ITR using the ● button on the unit's front panel.

Record One Programme While Watching Another

Once recording is in progress, all you need to do is to set the channel controls on the TV for the station you wish to view.

- The programme selected with the TV's channel controls appears on the TV screen while the one selected with the unit's **CH** buttons is recorded on the disc.

Elapsed Recording Time and Disc Remaining Time Indication

During recording, press **DISPLAY** repeatedly until the desired indication appears on the front display panel.

- Each time you press **DISPLAY**, the time indication changes as follows:

Elapsed recording time → Disc remaining time → Clock → (Back to the beginning)

Receiving Stereo and Bilingual Programmes

Your unit is equipped with a Sound-Multiplex decoder (A2) and a Digital stereo sound decoder (NICAM) making reception of stereo and bilingual broadcasts possible.

When the channel is changed, the type of broadcast being received will be displayed on the TV screen for a few seconds.

Type of Broadcast Being Received	On-screen Display
A2 Stereo	
A2 Bilingual	
Regular Monaural	
NICAM Stereo	
NICAM Bilingual	
NICAM Monaural	

NOTES:

- "SUPERIMPOSE" must be set to "AUTO". Otherwise the on-screen displays will not appear. (☞ pg. 90)
- If the quality of stereo sound being received is poor, the broadcast might be received in monaural with better quality.

Selection of the audio channel to be recorded on a disc

When a programme is recorded on a DVD-RAM or DVD-RW disc in VR mode, all audio channels of the receiving programme are recorded on the disc. When you record a programme on a DVD-R or DVD-RW disc in video mode, select the desired audio channel (from among "NICAM 1/MAIN", "NICAM 2/SUB", "MONO") to be recorded on the disc. (☞ pg. 89)

NOTE:

Before playing back a programme recorded in stereo, or a bilingual programme, refer to "Audio Channel Selection" on page 30.

Free Rate Function

To record the entire programme, the unit automatically set the appropriate recording speed depending on the combination of the total time of the programme to be recorded and either the remaining disc space or the specified recording time (from 60 minutes to 480 minutes).

To record the entire programme within the actual remaining disc space

Select "FR (JUST)" in a recording speed selection procedure.

(☞ pg. 53, 55)

- Note that this function is available only for timer programming recording.

To record the entire programme by specifying the desired recording time

Select "FR60–FR360", "FR420" or "FR480" in a recording speed selection procedure. (☞ pg. 47, 53, 55)

To record a 25-min. long daily programme five times just on a same disc for example

Perform "G-CODE"/SHOWVIEW™ Timer Programming" (☞ pg. 52) procedure. Be sure to set the recording speed to "FR125" and set Weekly/Daily Rec Function to "MON–FRI" in step 5 to fit the total recording time to the whole disc space.

NOTES:

- You can programme this unit to timer-record, regar

When the same programme is recorded in SP mode instead of in "FR125", the 5th programme cannot be recorded.

G-CODE™ / SHOWVIEW™ System Setup

The G-CODE timer programming system eliminates the need to input channel, date, start and stop time data when setting the timer record function. Simply key in the G-CODE number for the TV programme you wish to record (found in most TV listings) and the unit's timer is automatically programmed.

You have to set Guide Program numbers, which are assigned to each station for purposes of SHOWVIEW timer programming, for all the stations stored in your unit's memory to get proper results.

Before G-CODE setup you must have performed Auto Set Up (➔ pg. 19).

IMPORTANT

After setting the Guide Program Numbers, channel positions may be incorrect if you stored or skipped channels. In this case, re-perform Guide Program Number setting.

INFORMATION

G-CODE and SHOWVIEW are different trademarks used to represent the same easy recording feature, but only the term G-CODE system will be used in the instructions. If you use the SHOWVIEW system, follow the same instructions listed for the G-CODE system.

- Turn on the unit.
- Turn on the TV and select the AV mode.
- Slide the TV/DVD switch to DVD.

Guide Program Number Set

1 Access the Main Menu screen.

Press **SET UP**.

2 Access the "GUIDE PR" screen.

- 1 Press \triangleleft \triangleright to select "INITIAL SET UP", then press **ENTER**.
- 2 Press \triangleleft \triangleright to select "GUIDE PR", then press **ENTER**.

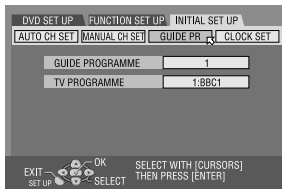

3 Enter the Guide Program number.

- 1 Press \triangle ∇ to select "GUIDE PROGRAMME", then press **ENTER**.
 - 2 Press \triangle ∇ to select the Guide Program number for the desired station as shown in the TV listings. Then press **ENTER**.
- To change the Guide Program number in 10 increments, press and hold \triangle ∇ .

4 Enter the receiving channel position number.

- 1 Press \triangle ∇ to select "TV PROGRAMME", then press **ENTER**.
 - 2 Press \triangle ∇ to select the number of the unit's channel position on which the Guide Program number's broadcast is received by the unit or the satellite receiver. Then press **ENTER**.
- If the satellite broadcast is received on your unit's auxiliary channel "L-2", select "L-2" for the channel position.
 - Repeat steps 3 and 4 as necessary.

5 Complete the setting.

Press **SET UP**.

Guide Program Number

"Guide Program (GUIDE PROGRAMME) number" refers to the assigned TV station numbers, according to broadcast area, for the G-CODE timer recording. The Guide Program numbers can be found in most TV listings.

5 Set the following recording options as required.

- 1 Press ◀▶ to select the desired option.
- 2 Press ▲▼ to select the desired setting, then press ENTER.

“REC MODE” (ⓘ pg. 48, “Recording Speed”) (ⓘ pg. 50, “Free Rate Function”), “DAILY/WEEKLY” (in the right column, “Daily/Weekly Rec Function”), “NAME” (ⓘ pg. 66, “Modify Programme Name”), and “STOP” (To advance/go back the stop time by 30 minutes, press and hold ▲▼).

- VPS/PDC recording is not available with this unit in your country.

6 Access the confirmation screen.

Press ENTER.

7 Complete timer programming.

Press ENTER.

- To programme another timer, repeat steps 2 – 7.
- If “PROGRAM OVERLAPPED” appears on the TV screen, see “When programmes overlap each other” (ⓘ pg. 60).

8 Engage the unit’s timer mode.

Press ⊖ (TIMER). The unit turns off automatically and “⊖” appears on the front display panel.

- To disengage the timer mode, press ⊕ (TIMER) again.

NOTES:

- There may be cases that G-CODE Timer Programming recording function prolongs the stop time of the programming.
- The beginning of a programme may not be recorded. Also, if the 1st programme’s recording stop time and the 2nd programme’s recording start time is the same, the ending of the 1st programme may not be recorded.
- If the copy limited programme is received during timer-recording, the unit enters Record Pause mode. Recording starts again if it is switched to a recordable broadcast during the time you programmed.

Satellite Receiver Users

To timer-record a satellite broadcast using the G-CODE system:

- 1 Perform “G-CODE™/SHOWVIEW™ Timer Programming”.
- 2 Set the satellite receiver to the appropriate channel before the selected programme begins.
- 3 Leave the satellite receiver’s power on.

Daily/Weekly Rec Function

You can record programmes with one of the following weekly/daily timer settings.

WEEKLY	Select to record a weekly programme.
MON-FRI	Select to record a daily programme from Monday through Friday.
MON-SAT	Select to record a daily programme from Monday through Saturday.
SUN-SAT	Select to record a daily programme from Sunday through Saturday.

Manual Timer Programming



You can programme this unit to timer-record as many as 8 programmes.

If you do not know the G-CODE number for the programme you wish to record, use the following procedure to set your unit to timer-record the programme.

Before performing Manual Timer Programming:

- Turn on the unit.
- Turn on the TV and select the AV mode.
- Slide the TV/DVD switch to DVD.
- Make sure that the unit's built-in clock is set properly.

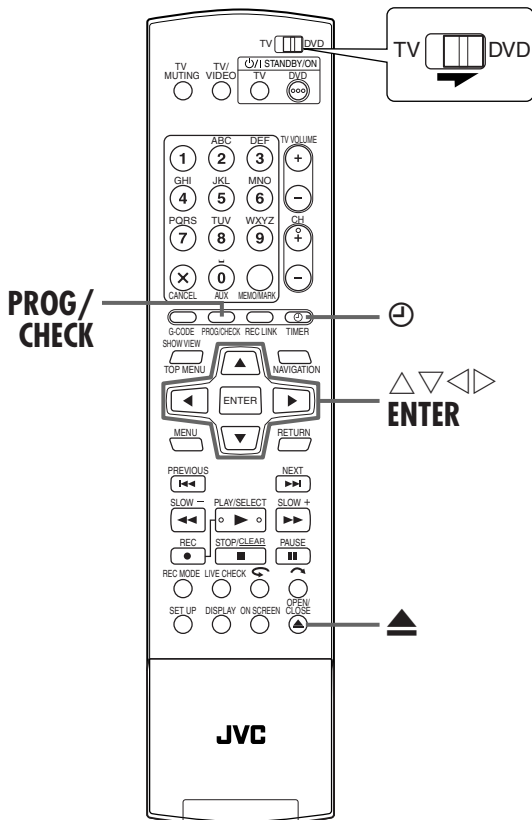

1 Load a disc.

- 1 Press \blacktriangle to open the disc tray.
- 2 Place a recordable disc on the disc tray.
 - For details, refer to "Placing a Disc" (pg. 9).
- 3 Press \blacktriangle to close the disc tray.

2 Access Programme Check screen.

Press **PROG/CHECK**.

- When "PROGRAMME FULL DELETE UNWANTED TIMER PROGRAMME" appears on the TV screen, you need to cancel some of the reserved programmes. (pg. 59)

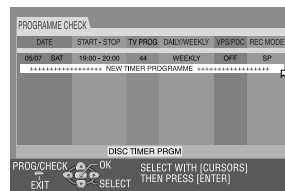

3 Access the programme screen.

Press \triangle / ∇ repeatedly to select "NEW TIMER PROGRAMME", then press **ENTER**.

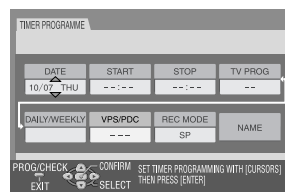

4 Enter the recording date.

Press \triangle / ∇ repeatedly to set the desired date.

- The current date appears on the TV screen. The date you enter appears in its place.

5 Enter the recording start time.

Press \triangle / ∇ to select "START", then press \triangle / ∇ repeatedly to set the desired start time.

- Each press of \triangle / ∇ advances/goes back the start time in 1-min. increments.
- To advance/go back the start time in 30-min. increments, press and hold \triangle / ∇ .

6 Enter the recording stop time.

Press ◀▶ to select "STOP", then press ▲▼ repeatedly to set the desired stop time.

- Each press of ▲▼ advances/goes back the stop time in 1-min. increments.
- To advance/go back the stop time in 30-min. increments, press and hold ▲▼.

7 Enter the channel position.

Press ◀▶ to select "TV PROG", then press ▲▼ repeatedly to select the desired channel.

8 Set the other recording options as required.

Refer to step 5 in "G-CODE™/SHOWVIEW™ Timer Programming" (pg. 52).

9 Access the confirmation screen.

Press ENTER.

10 Complete timer programming.

Press ENTER.

- To programme another timer, repeat steps 2 – 10.

11 Engage the unit's timer mode.

Press ⊖ (TIMER). The unit turns off automatically and "⊖" appears on the front display panel.

- To disengage the timer mode, press ⊖ (TIMER) again.

NOTES:

- The beginning of a programme may not be recorded. Also, if the 1st programme's recording stop time and the 2nd programme's recording start time is the same, the ending of the 1st programme may not be recorded.
- If the copy limited programme is received during timer-recording, the unit enters Record Pause mode. Recording starts again if it is switched to a recordable broadcast during the time you programmed.

Satellite Receiver Users

To timer-record a satellite broadcast using Manual Timer Programming:

- 1 Perform "Manual Timer Programming". Enter "L-2" for the channel position.
- 2 Set the satellite receiver to the appropriate channel before the selected programme begins.
- 3 Leave the satellite receiver's power on.

On-Disc Timer Programming



On-Disc Timer Programming is a function used with discs that are especially intended for a specific programme. The disc is then programmed for a programme you always watch every day or every week. Since older programs are automatically overwritten, a single DVD-RAM/RW (VR mode) disc can be used without worrying about how much recording capacity remains. (pg. 58, "How discs are overwritten")

You can programme each disc to timer-record as many as 8 programmes.

Before performing On-Disc Timer Programming:

- Turn on the unit.
- Turn on the TV and select the AV mode.
- Slide the TV/DVD switch to DVD.
- Make sure that the unit's built-in clock is set properly.

ATTENTION:

If data is recorded on a disc for On-Disc Timer Programming using a unit from another manufacturer, On-Disc Timer Programming may no longer function properly.

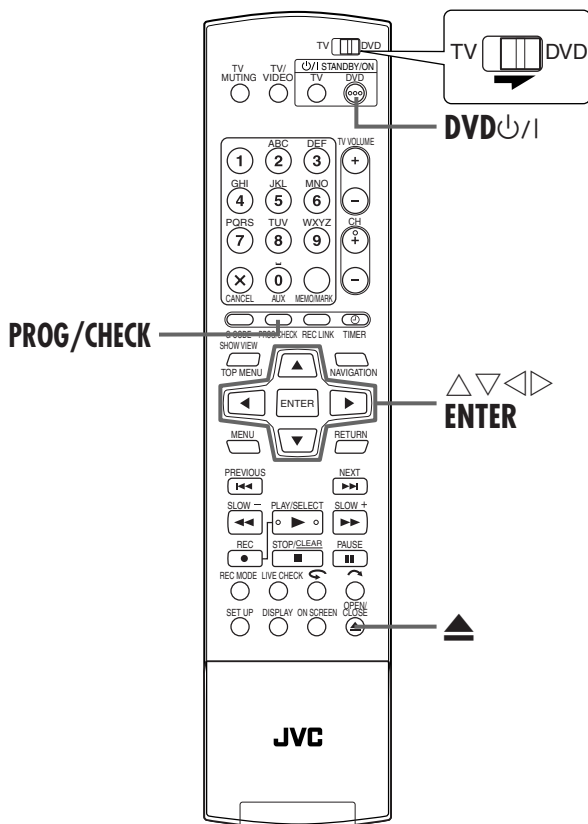

To make the disc for On-Disc Timer Programming

1 Load a disc.

- 1 Press to open the disc tray.
- 2 Place a recordable disc on the disc tray.
 - For details, refer to "Placing a Disc" (pg. 9).
- 3 Press to close the disc tray.

2 Access Programme Check screen.

Press **PROG/CHECK**.

3 Access the programme screen.

When On-Disc Timer Programming is made for the first time on the disc

Press repeatedly to select "DISC TIMER PRGM", then press **ENTER**.

- When some programmes are recorded on the disc, a caution message appears. In such a case, backup the programmes as required, then format the disc before making On-Disc Timer Programming. (pg. 97, "Format A Disc")

When On-Disc Timer Programming has already been made on the disc

Press repeatedly to select "NEW TIMER PROGRAMME", then press **ENTER**.

4 Enter the recording date.

Press repeatedly to set the desired date.

- The current date appears on the TV screen. The date you enter appears in its place.

5 Enter the recording start time.

Press to select "START", then press repeatedly to set the desired start time.

- Each press of advances/goes back the start time in 1-min. increments.
- To advance/go back the start time in 30-min. increments, press and hold .

6 Enter the recording stop time.

Press ◀▶ to select "STOP", then press △▽ repeatedly to set the desired stop time.

- Each press of △▽ advances/goes back the stop time in 1-min. increments.
- To advance/go back the stop time in 30-min. increments, press and hold △▽.

7 Enter the channel position.

Press ◀▶ to select "TV PROG", then press △▽ repeatedly to select the desired channel.

8 Set "DAILY/WEEKLY" option.

Refer to step 5 in "G-CODE™/SHOWVIEW™ Timer Programming" (☞ pg. 52).

- It is necessary to set "DAILY/WEEKLY" option for On-Disc Timer Programming. (☞ pg. 53, "Daily/Weekly Rec Function")

9 Set the other recording options as required.

Refer to step 5 in "G-CODE™/SHOWVIEW™ Timer Programming" (☞ pg. 52).

- You can select XP, SP, LP, EP or FR480 mode for "REC MODE". You cannot select FR (JUST), FR60–FR360 and FR420.

10 Access the confirmation screen.

Press ENTER.

11 Complete timer programming.

Press ENTER.

- To programme another timer, repeat steps 2 – 11.

Satellite Receiver Users

To timer-record a satellite broadcast using the On-Disc Timer Programming function:

- 1 Perform "On-Disc Timer Programming". Enter "L-2" for the channel position.
- 2 Set the satellite receiver to the appropriate channel before the selected programme begins.
- 3 Leave the satellite receiver's power on.

To timer-record the programme with the programmed disc

1 Load the disc.

- 1 Press ▲ to open the disc tray.
- 2 Place the programmed disc on the disc tray.
 - For details, refer to "Placing a Disc" (☞ pg. 9).
- 3 Press ▲ to close the disc tray.

2 Engage the unit's timer mode.

Press DVD ⏻/I. The unit turns off and "DISC" (⏻) appears on the front display panel.

- To disengage the timer mode, press DVD ⏻/I again.

NOTES:

- Even if On-Disc Timer Programming is overlapping with other timer programming, any caution message does not appear. In such a case, recording will be executed in the descending order of the recording start time of the programme.
- On-Disc Timer Programming is not possible on a DVD-RW disc formatted in video mode. (☞ pg. 97, "Format a DVD-RW disc")
- The information of a programme recorded with On-Disc Timer Programming is not stored in the library. (☞ pg. 72)
- The play list is not created for the programmes recorded with On-Disc Timer Programming. (☞ pg. 68)
- Manual Timer Programming is not possible on the On-Disc Timer Programmed disc. (☞ pg. 54)
- Basic Recording is not possible on the On-Disc Timer Programmed disc. (☞ pg. 47)
- The On-Disc Timer Programming function does not work on the unit from other manufactures even if the On-Disc Timer Programmed disc is loaded.
- The beginning of a programme may not be recorded. Also, if the 1st programme's recording stop time and the 2nd programme's recording start time is the same, the ending of the 1st programme may not be recorded.
- If there is a power cut while recording, the recordings before the power cut are not guaranteed.

How discs are overwritten

(Example 1)
To record a 1-hour serial drama every Friday in SP mode

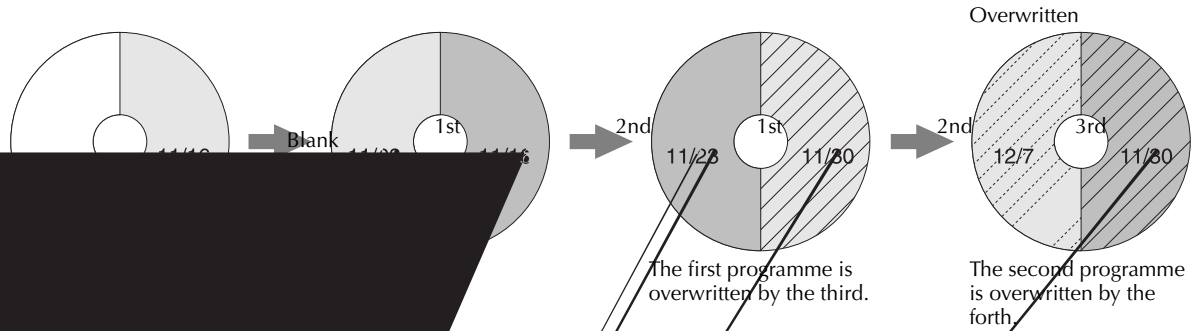

morning in XP mode

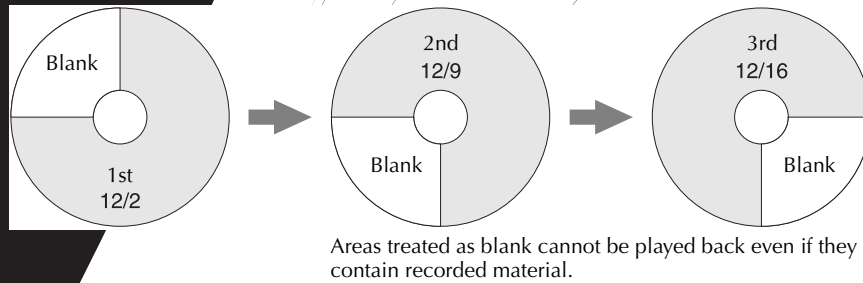
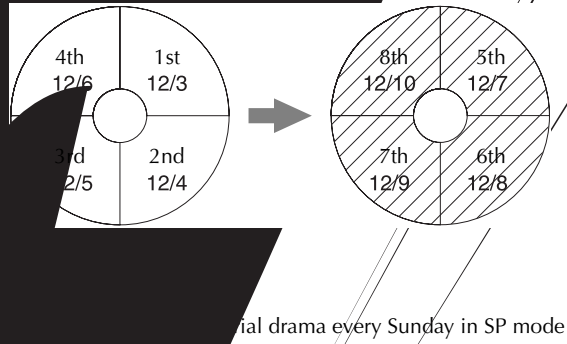

NOTE:

Disc Timer Programming may not always work as these examples.

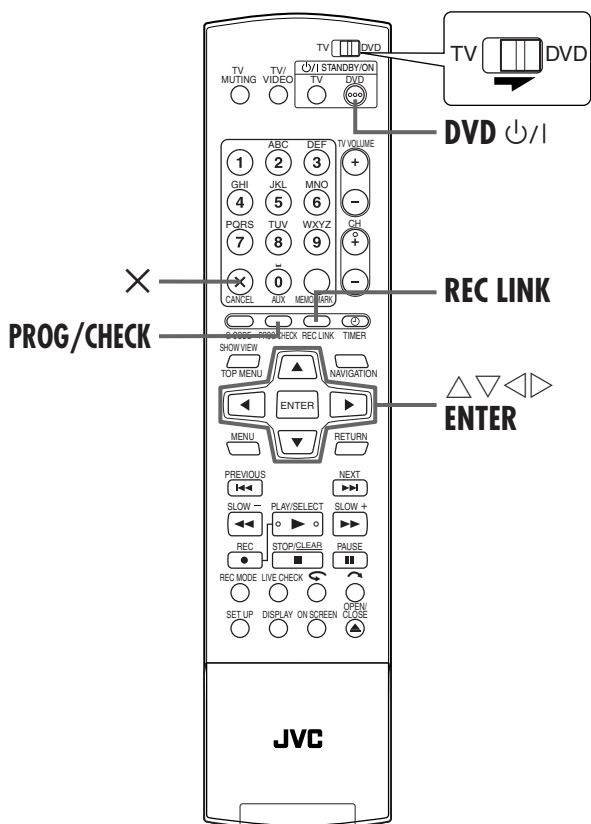

Check, cancel and change programmes

1 Disengage the timer mode.

When “**TIMER**” lights on the front display panel
Press **TIMER**, then press **DVD P/I**.

When “**DISC**” lights on the front display panel
Press **DVD P/I**.

When “**R-LK**” lights on the front display panel
Press **REC LINK**, then press **DVD P/I**.

2 Access Programme Check screen.

Press **PROG/CHECK**.

• To return to the previous screen after you check the programme, press **PROG/CHECK** again.

To cancel the programme
Press $\triangle \nabla$ repeatedly to select a programme to be cancelled, then press X.

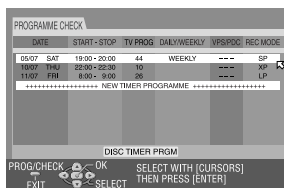

3 Access the programme screen.

Press $\triangle \nabla$ to select the programme, then press **ENTER**.

4 Change a programme.

Change the settings of the desired recording options as required.

- Refer to steps **4** – **9** in “Manual Timer Programming” (pg. 54).

5 Complete timer correction.

Press **PROG/CHECK**.

- The previous screen resumes.

6 Engage the unit's timer mode.

For G-CODE or Manual Timer Programming

Press **TIMER**.

For On-Disc Timer Programming

Press **DVD P/I**.

For Automatic Satellite Programme recording

Press **REC LINK** for 2 seconds or more.

Programme's information on the front display panel

You can check the details of the programmes even when the power is turned off. (It is necessary that the Power Save mode (pg. 90, “POWER SAVE”) is disengaged or the unit is not in timer standby mode.) However, it is not possible to cancel or change the programme's setting.

1 Press **PROG/CHECK**.

- “NEW PROG” or “P-1” (if 8 programmes have already been set) appears.

2 Press $\triangle \nabla$ repeatedly until the desired programme number (“P-1” to “P-8”) appears, then press **ENTER**.

3 Press \triangleright .

- Each time you press \triangleright , the indication changes as follows (the settings in parentheses are examples):

Date (“DATE 08.03SU”) → Start time (“ON 11:00”) → Stop time (“OFF 11:30”) → Channel (“PR 1”) → Weekly/Daily (“MO-FR DAILY”) → Programme number (“P-1”) and Recording speed (SP) → (Back to the beginning)

4 Press **PROG/CHECK** to complete checking.

- The normal display resumes.

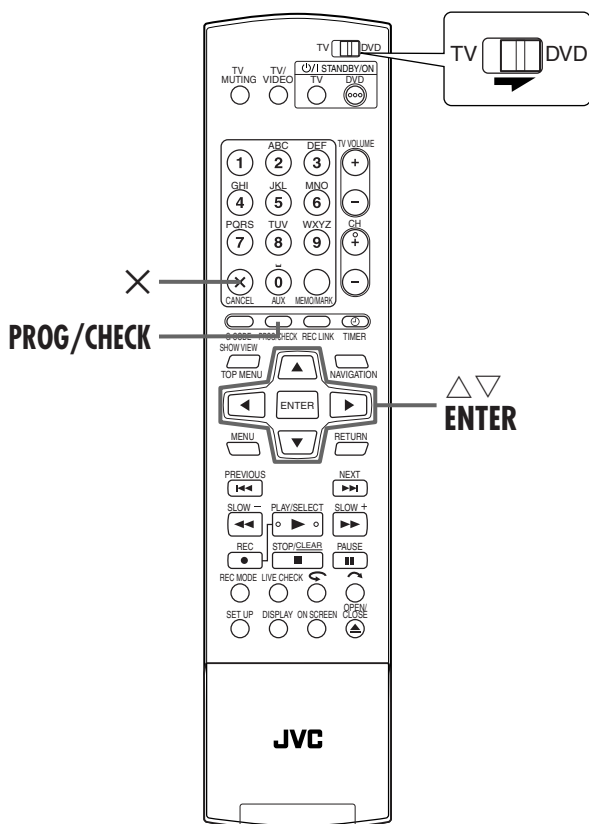

When programmes overlap each other

If "PROGRAM OVERLAPPED" appears, you have another programme overlapping the programme you have just made. Confirm with the arrow on "OK", then press **PROG/CHECK**. Programme Check screen appears and conflicting programmes will be highlighted in pink.

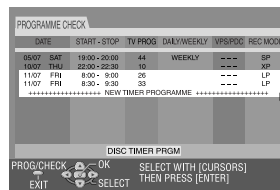

Example: Programme 3 (you have just made) and Programme 4 overlap each other.

1 Confirm the overlapping programmes.

Overlapping programmes appear on the TV screen.

NOTE:

If you do not mind this overlap, press **PROG/CHECK** to finish the timer programme setting. The programme with the lower programme number will be recorded and the other one will not be recorded correctly. If no changes are made for approximately 1 minute, the unit will return to the normal screen.

2 Select the desired programme to be cancelled or changed.

Press $\triangle \nabla$.

To cancel the programme

Press X.

- "THE TIMER PROGRAMMING SETTING WAS CANCELLED" appears on the TV screen for about 5 seconds, then the normal screen resumes.

To change the programme setting

Press **ENTER**.

3 Change the programme setting.

- Refer to steps **4** – **10** in "Manual Timer Programming" (pg. 54).

4 Check if the conflict has been settled.

Press **PROG/CHECK**.

- Programme check screen appears.

5 Engage the unit's timer mode.

- Refer to step **6** in "Check, cancel and change programmes" (pg. 59).

NOTE:

When any overlaps remain after deletion and modification of programmes, Programme Check screen remains showing the conflicting programmes. In such a case, repeat the procedure above until the conflict is solved.

Automatic Satellite Programme Recording



This function allows you to automatically record a satellite programme which is timer-programmed on your external satellite receiver. Connect a satellite receiver to the unit's L-2 IN connector and programme the timer on the satellite receiver. When the signals come into the unit from the satellite receiver, the unit automatically turns on and starts recording.

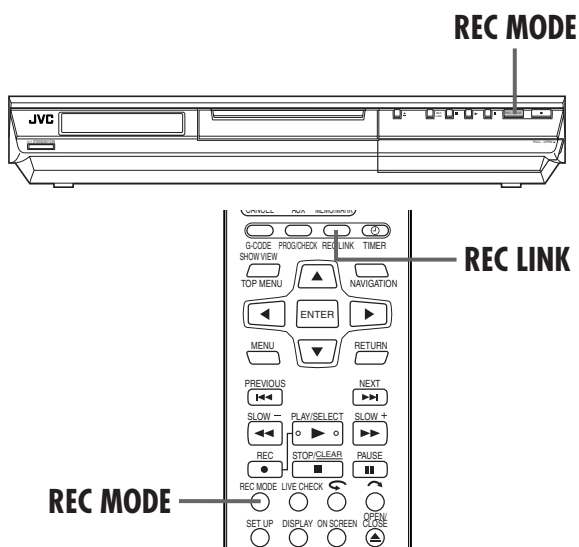

ATTENTION:

- Be sure not to turn on the satellite receiver before the programme is executed; otherwise, the unit will start recording when the satellite receiver's power is turned on.
- If you have connected another appliance other than a satellite receiver to the L-2 IN connector, be sure not to engage the Automatic Satellite Programme Recording mode; otherwise, the unit will start recording when the connected appliance's power is turned on.
- Automatic Satellite Programme Recording and timer-recording cannot be done at the same time.

Before performing the following steps:

- Make sure the satellite receiver is connected to the unit's L-2 IN connector. (☞ pg. 85)
- Programme the timer on the satellite receiver.
- Slide the TV/DVD switch to TV.

1 Select the L-2 SELECT mode.

Set "L-2 SELECT" to "VIDEO"
(☞ pg. 81, "L-2 Select Setting (L-2 SELECT)").

2 Set the recording speed.

Press **REC MODE**.

3 Engage the Automatic Satellite Programme Recording mode.

Press and hold **REC LINK** for about 2 seconds. "R-LK" appears on the front display panel and the unit turns off automatically.

NOTES:

- To disengage the Automatic Satellite Programme Recording mode, press **REC LINK**.
- If the unit's power is off, it is not possible to engage the Automatic Satellite Programme Recording mode.
- In step 3, if "R-LK" blinks quickly on the front display panel even though your satellite receiver's power is off, Automatic Satellite Programme Recording will not work properly with that satellite receiver*. If this is the case, perform "Manual Timer Programming" (☞ pg. 54) to timer-record a satellite programme.
* Some satellite receivers output signals even if the power is off. Automatic Satellite Programme Recording is not possible with those satellite receivers.
- "R-LK" blinks on the front display panel while Automatic Satellite Programme Recording is in progress.
- For timer programming of the satellite receiver, refer to the instruction manual of the satellite receiver.
- Automatic Satellite Programme Recording is not possible if your satellite receiver does not have a timer.
- Pressing the unit's O/I button while Automatic Satellite Programme Recording is in progress turns off the unit's power and disengages the Automatic Satellite Programme Recording mode.
- If there are more than one satellite programmes you wish to record with Automatic Satellite Programme Recording, it is not possible to set different recording speeds for each programme.
- Depending on the type of satellite receiver, the unit may not record a slight portion of the beginning of the programme or may record slightly longer than the actual length of the programme.
- If you engage the Automatic Satellite Programme Recording mode when the satellite receiver's power is on, the unit will not start Automatic Satellite Programme Recording even though "R-LK" blinks on the front display panel. When the satellite receiver shuts off once and is turned back on again, the unit starts recording.
- You can also record a programme from your cable system in the same way if the system has a timer.
- When the Automatic Satellite Programme Recording mode is engaged, or the unit's power is turned off after Automatic Satellite Programme Recording is finished, the unit will not enter the Timer mode even though "AUTO TIMER" is set to "ON" (☞ pg. 91).

Library Database DVD Navi



The following screen appears as the Library Database DVD Navi screen when you press **NAVIGATION**. You can move the arrow to select the desired position on the screen by pressing $\triangle \nabla \triangleleft \triangleright$ on the remote control.

The screenshot shows a menu interface with the following elements:

- 1**: Index (Small still picture of each programme)
- 2**: Names of functions (ORIGINAL, PLAY LIST, LIBRARY)
- 3**: Remaining time (1:35)
- 4**: Current/Total number of programme(s) (3/6)
- 5**: Icons (Indicate the recording situation for each programme.)
- 6**: Recording information for the programme indicated by the arrow (DANCE COUNTRY, 10:00-11:00, PR. 7CH, SP, 60min)
- 7**: Guidance for operations (NAVIGATION, EXIT, OK, SELECT WITH CURSORS THEN PRESS [ENTER])
- 8**: Operational commands (MODIFY, DELETE, EDITING, PROTECT)

- 1 Index
(Small still picture of each programme)
- 2 Names of functions
ORIGINAL (pg. 65)
PLAY LIST (pg. 68)
LIBRARY (pg. 72)
- 3 Remaining time
(Based on the recording speed currently selected)
- 4 Current/Total number of programme(s)
(For example, there are 6 recorded programmes and the programme indicated by the arrow is the 3rd one.)
- 5 Icons
(Indicate the recording situation for each programme.)
- 6 Recording information for the programme indicated by the arrow
- 7 Guidance for operations
- 8 Operational commands

The Icons and their meanings

	This programme is write-protected.
	This programme has stereo sounds.
	This programme has bilingual sounds.
	This programme was recorded with timer recording.

RAM 0001- RAM 0001- RAM

6 PR-33

Scan for Beginning(s) of Programme(s)

- Turn on the TV and select the AV mode.
- Slide the TV/DVD switch to DVD.

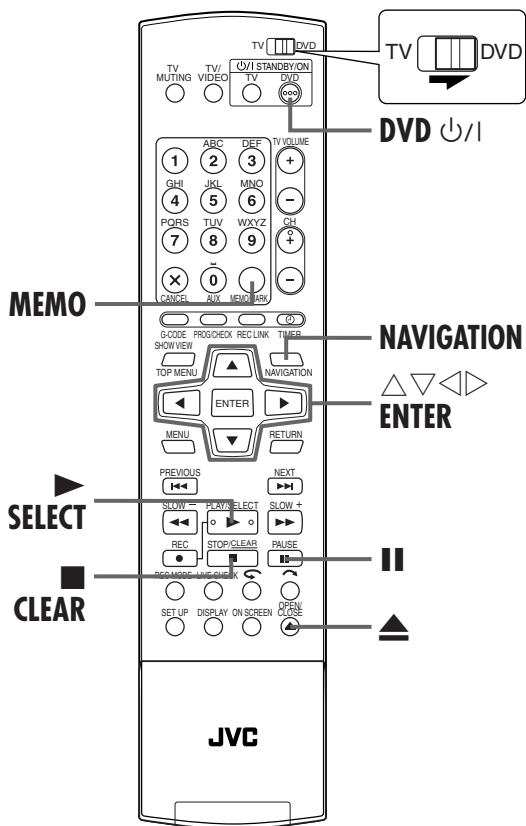

You can scan the beginning of the programme easily with the Library Database DVD Navi.

1 Turn on the unit.

Press **DVD** $\text{\textcircled{P}}$.

2 Load a disc.

- 1 Press \blacktriangle to open the disc tray.
 - 2 Place a recorded disc on the disc tray.
 - 3 Press \blacktriangle to close the disc tray.
- For details, refer to "Placing a Disc" (pg. 9).

3 Access the Index screen.

- 1 Press **NAVIGATION**. The Library Database DVD Navi screen appears.
- 2 Press $\triangle \nabla \triangleleft \triangleright$ to move the arrow to "ORIGINAL", then press **ENTER**.



4 Select the programme(s).

Press $\triangleleft \triangleright$ to move the arrow on the index (small still pictures) of the desired programme.

- When you want the plural programmes to be played back continuously, press **MEMO** after selecting the desired programme. The numbers of the playback order appear on the index. You can select up to 30 programmes.
- When you want to correct the order, move the arrow on the desired index and press **MEMO**. The number disappears and the unit re-numbers the other programmes automatically.
- When you want to cancel the order, press **CLEAR**.

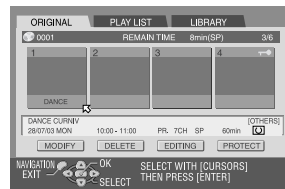

5 Start playback.

Press **ENTER**. Or simply press **SELECT**. The playback starts.

6 Pause playback.

- Press **II**.
- To resume normal playback, press \blacktriangleright .

7 Stop playback.

Press **■**.

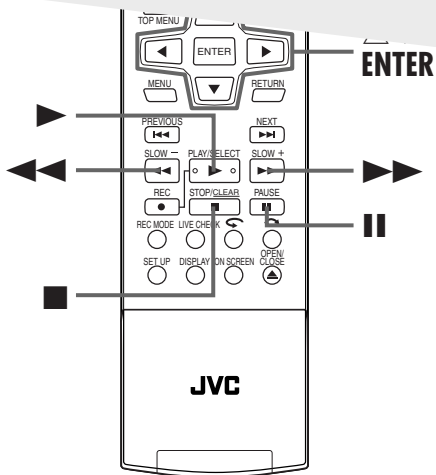

from the programme by pressing the appropriate buttons (◀◀, ▶▶, ▶▶▶, or ||). The pictures of the programme appear on the left window.



- 2 Confirm the arrow is on "REPLACE", then press **ENTER** to register new index. New index appears on the right window.

 - When you press **ENTER** with the arrow on "RETURN" you can return to the previous screen.

6 Return to the normal screen.

Press **NAVIGATION**.

- Press ■ to cancel pause mode after pressing **NAVIGATION**.

Modify Programme Name

Perform steps **1** to **3** of "Modify Index" (☞ pg. 65) before continuing.

1 Access the modify screen.

- Press $\Delta \nabla \triangleleft \triangleright$ to move the arrow to "MODIFY", then press **ENTER**.
- Press $\triangleleft \triangleright$ to move the arrow to "MODIFY NAME". The "MODIFY NAME" screen appears.

2 Enter new name.

Press $\Delta \nabla \triangleleft \triangleright$ to move the arrow to the desired letter or command, then press **ENTER**. Repeat this process to complete the name.

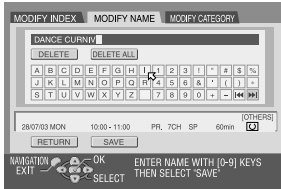

- To correct a letter, press $\Delta \nabla \triangleleft \triangleright$ to move the arrow to "DELETE" or "DELETE ALL", then press **ENTER**.
- You can enter the letters up to 64.
- You can also enter the new name with **number keys**. For example, when you press **2** repeatedly, "A", "B", "C", "a", "b", "c", "2", and then "A" appear by turns. You can use the following buttons.

Number keys: for entering letters, numbers and blank space
 $\triangleleft \triangleright$ **buttons:** for moving the entering or inserting point
■ button: for correcting a letter
 $\triangleleft \triangleleft \triangleright \triangleright$ **buttons:** for changing character tables

3 Register new name.

Press $\Delta \nabla \triangleleft \triangleright$ to move the arrow to "SAVE", then press **ENTER**.

4 Return to the Library Database DVD Navi screen.

Press $\Delta \nabla \triangleleft \triangleright$ to move the arrow to "RETURN", then press **ENTER**. The Library Database DVD Navi screen appears again.

5 Return to the normal screen.

Press **NAVIGATION**.

Modify Category

Perform steps **1** to **3** of "Modify Index" (☞ pg. 65) before continuing.

1 Access the modify screen.

- Press $\Delta \nabla \triangleleft \triangleright$ to move the arrow to "MODIFY", then press **ENTER**.
- Press $\triangleleft \triangleright$ to move the arrow to "MODIFY CATEGORY". The "MODIFY CATEGORY" screen appears.

2 Select new category.

Press $\Delta \nabla \triangleleft \triangleright$ to move the arrow to the desired category, then press **ENTER**.

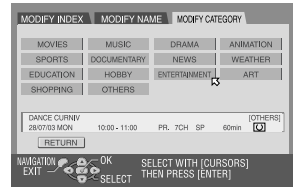

3 Register new category.

Press **ENTER**. The Library Database DVD Navi screen appears again.

4 Return to the normal screen.

Press **NAVIGATION**.

Protect title

You can protect the programme to prevent accidental erasure of the important programme.

Perform steps **1** to **2** of "Modify Index" (☞ pg. 65) before continuing.

1 Select a programme.

Press $\Delta \nabla \triangleleft \triangleright$ to move the arrow to a programme you want to protect, then press ∇ .

2 Protect the programme.

Press $\triangleleft \triangleright$ to move the arrow to "PROTECT", then press **ENTER**.

- "" appears.
- To cancel the protection, repeat **1** - **2** again.

3 Return to the normal screen.

Press **NAVIGATION**.

NOTE:

All the programmes on a disc will be deleted once the disc is formatted even if they are protected titles. (☞ pg. 97)

Delete programme

You cannot record any more with Library Database DVD Navi once the registered programmes on the disc reach 99 programmes. Deleting unnecessary programmes after dubbing (☞ pg. 79, "Edit To Or From Another Recorder") or other operations can increase remaining time and available recording capacity. (For DVD-R discs, although it is possible to delete recorded programmes, available recording capacity does not increase.) The deleted programme is never resumed. Play lists and programme information in the unit's library are also deleted.

Perform steps **1** to **2** of "Modify Index" (☞ pg. 65) before continuing.

1 Select a programme.

Press ◀▶ to move the arrow to select one programme you want to delete, then press ▽.

2 Access the delete screen.

Press △▽◀▶ to move the arrow to "DELETE", then press **ENTER**. The message appears for your confirmation.

3 Confirm the deletion.

Press ◀▶ to select "YES", then press **ENTER**.
 • When you cancel the deletion, select "NO", then press **ENTER**.

4 Return to the normal screen.

Press NAVIGATION.

Delete unwanted part of the programme

You can delete unwanted part of the programme.

Perform steps **1** to **2** of "Modify Index" (☞ pg. 65) before continuing.

1 Select a programme.

Press ◀▶ to move the arrow to select one programme whose unwanted part you want to delete, then press ▽.

2 Access the delete screen.

Press ◀▶ to move the arrow to "EDITING", then press **ENTER**.

3 Start playback.

Press ▶ to start playback. The playback pictures appear in the window on the screen. The elapsed playing time starts counting with the arrow on "IN".

4 Set edit-in and edit-out points.

- Find the point where you want the deletion to begin, then press **ENTER** with the arrow on "IN". The edit-in time is fixed and the elapsed playing time starts counting again.

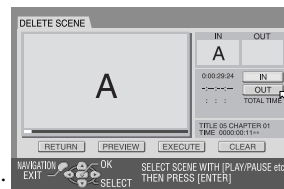

- Find the point where you want the deletion to end, then press **ENTER** with the arrow on "OUT". The edit-out time is fixed.
- Press ◀◀, ▶, ▶▶, ◀◀, ▶▶ or || to find the edit-in and edit-out points.

5 Confirm the deletion.

- Press △▽◀▶ to move the arrow to "PREVIEW", then press **ENTER** to preview the edited programme.
- Press △▽◀▶ to select "EXECUTE", then press **ENTER**.
 - If you do not want to delete the scene, select "CLEAR" and press **ENTER**.
- Press ◀▶ to select "YES", then press **ENTER**.
 - The selected scene is deleted.
 - To cancel the deletion, press ◀▶ to select "NO", then press **ENTER**.

To modify the points

- Press ◀▶ to move the arrow to "CLEAR", then press **ENTER**.
- Repeat step **3** – **5**.

6 Return to the normal screen.

Press NAVIGATION.

NOTES:

- There may be a discrepancy of several seconds between the scene you intend to edit, and the scene which is actually edited.
- Available recording capacity may not match the deleted part after deletion.

Modify Play List Information



- Turn on the TV and select the AV mode.
- Slide the TV/DVD switch to DVD.

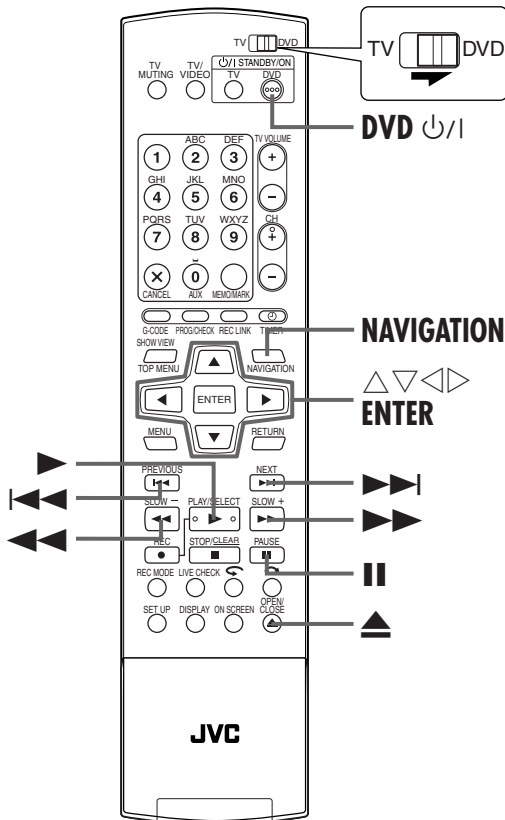

■ Play List

It is a collection of the scenes. A play list can be freely edited and played back without ever changing any original recording data.

Using the random access of a DVD disc (which allows video data to be instantly read no matter where it is on the disc), a play list includes information such as the timer counter for the playback start point and end point, indexes for checking the contents of recorded data, category information, and more. Playback according to a play list you have created allows you to enjoy various combinations of video images from a single programme.

Create Play List

1 Turn on the unit.

Press DVD \uparrow/\downarrow .

2 Load a disc.

- 1 Press \blacktriangle to open the disc tray.
- 2 Place a DVD-RAM or DVD-RW (VR mode) disc that was recorded with this unit on the disc tray.
 - For details, refer to "Placing a Disc" (pg. 9).
- 3 Press \blacktriangle to close the disc tray.

3 Access the Play List screen.

- 1 Press NAVIGATION. The Library Database DVD Navi screen appears.
- 2 Press $\triangle \nabla \triangleleft \triangleright$ to move the arrow to "PLAY LIST", then press ∇ or ENTER.

4 Create a play list.

Press $\triangle \nabla \triangleleft \triangleright$ to move the arrow to "CREATE", then press ENTER.

5 Start playback.

Press \blacktriangleright to start playback. The playback pictures appear in the window on the screen. The elapsed playing time starts counting with the arrow on "IN".

- To locate the beginning of other titles, press $\blacktriangleleft \blacktriangleright$.

6 Set edit-in and edit-out points.

- 1 Find the point where you want the created play list to begin, then press ENTER with the arrow on "IN". The edit-in time is fixed and the elapsed playing time starts counting again.
- 2 Find the point where you want the created play list to end, then press ENTER with the arrow on "OUT". The edit-out time is fixed.
 - Press $\blacktriangleleft, \blacktriangleright, \blacktriangleright\blacktriangleright, \blacktriangleleft\blacktriangleleft, \blacktriangleright\blacktriangleleft$ or \parallel to find the edit-in and edit-out points.
 - The edit-out point must come after the edit-in point.

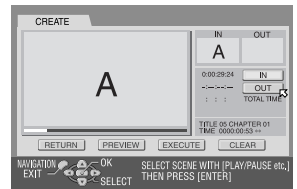

7 Confirm the play list.

- 1 Press $\triangleleft \triangleright$ to move the arrow to "PREVIEW", then press ENTER to preview the play list.
- 2 Press $\triangleleft \triangleright$ to select "EXECUTE", then press ENTER.
 - The play list is created.

To modify the points

- 1 Press $\triangleleft \triangleright$ to move the arrow to "CLEAR", then press ENTER.
- 2 Repeat step 5 – 7.

8 Return to the normal screen.

Press NAVIGATION.

NOTES:

- There may be a discrepancy of several seconds between the scene you intend to edit, and the scene which is actually edited.
- The title, index and category of the play list can be modified in the same way as "ORIGINAL". (☞ pg. 65, "Modify Original Information")
- You can modify the play list that has just been created here by adding, moving, or deleting unwanted parts to create a digest edition, etc.

Add scenes to a play list

Perform steps 1 to 3 of "Create Play List" (☞ pg. 68) before continuing.

1 Select a play list.

Press ◀▶ to move the arrow to the play list to which you wish to add a scene, then press ▽.

2 Access the Editing screen.

- 1 Press ◀▶ to move the arrow to "EDITING", then press ENTER.
- 2 Press ◀▶ to move the arrow to "ADD SCENE".

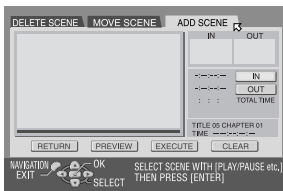

3 Start playback.

Press ► to start playback. The playback pictures appear in the window on the screen. The elapsed playing time starts counting with the arrow on "IN".

- To locate the beginning of other titles, press |◀◀▶▶|.

4 Set edit-in and edit-out points.

- 1 Find the point where you want the added scene to begin, then press ENTER with the arrow on "IN". The edit-in time is fixed and the elapsed playing time starts counting again.
 - 2 Find the point where you want the added scene to end, then press ENTER with the arrow on "OUT". The edit-out time is fixed.
- Press ◀◀, ▶, ▶▶, |◀◀, ▶▶| or || to find the edit-in and edit-out points.

5 Confirm the addition.

- 1 Press ◀▶ to move the arrow to "PREVIEW", then press ENTER to preview approximately 5 seconds before and after the edited scene.
- 2 Press ◀▶ to select "EXECUTE", then press ENTER.
 - The selected scene is added.

To modify the points

- 1 Press ◀▶ to move the arrow to "CLEAR", then press ENTER.
- 2 Repeat step 3 – 5.

6 Return to the normal screen.

Press NAVIGATION.

NOTE:

There may be a discrepancy of several seconds between the scene you intend to edit, and the scene which is actually edited.

Move scenes

Perform steps 1 to 3 of "Create Play List" (☞ pg. 68) before continuing.

1 Select a play list.

Press ◀▶ to move the arrow to a play list into which you wish to move a scene, then press ▽.

2 Access the Editing screen.

- 1 Press ◀▶ to move the arrow to "EDITING", then press ENTER.
- 2 Press ◀▶ to move the arrow to "MOVE SCENE".

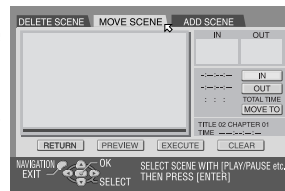

3 Start playback.

Press ► to start playback. The playback pictures appear in the window on the screen. The elapsed playing time starts counting with the arrow on "IN".

- To locate the beginning of other titles, press |◀◀▶▶|.

4 Set edit-in and edit-out points.

- 1 Find the point where you want the moved scene to begin, then press **ENTER** with the arrow on "IN". The edit-in time is fixed and the elapsed playing time starts counting again.
 - 2 Find the point where you want the moved scene to end, then press **ENTER** with the arrow on "OUT". The edit-out time is fixed.
 - 3 Press **▶** to start playback.
 - 4 Find the point where you want the moved scene to be moved, then press **ENTER** with the arrow on "MOVE TO".
- Press **◀◀, ▶, ▶▶, ◀◀, ▶▶▶** or **||** to find the edit-in, edit-out and move-to points.

5 Confirm the move.

- 1 Press **◀▶** to move the arrow to "PREVIEW", then press **ENTER** to preview the part approximately 5 seconds before and after the point to which the scene has been moved.
 - 2 Press **◀▶** to select "EXECUTE", then press **ENTER**.
- The selected scene is moved.

To modify the points

- 1 Press **◀▶** to move the arrow to "CLEAR", then press **ENTER**.
- 2 Repeat step **3** – **5**.

6 Return to the normal screen.

Press **NAVIGATION**.

NOTE:

There may be a discrepancy of several seconds between the scene you intend to edit, and the scene which is actually edited.

Delete unwanted part from play list

Perform steps **1** to **3** of "Create Play List" (pg. 68) before continuing.

1 Select a play list.

Press **◀▶** to move the arrow to a play list from which you wish to delete unwanted parts, then press **▽**.

2 Access the Editing screen.

- 1 Press **◀▶** to move the arrow to "EDITING", then press **ENTER**.
- 2 Press **◀▶** to move the arrow to "DELETE SCENE", then press **ENTER**.



3 Start playback.

Press **▶** to start playback. The playback pictures appear in the window on the screen. The elapsed playing time starts counting with the arrow on "IN".

- To locate the beginning of other titles, press **◀◀▶▶▶**.

4 Set edit-in and edit-out points.

- 1 Find the point where you want the deletion to begin, then press **ENTER** with the arrow on "IN". The edit-in time is fixed and the elapsed playing time starts counting again.
 - 2 Find the point where you want the deletion to end, then press **ENTER** with the arrow on "OUT". The edit-out time is fixed.
- Press **◀◀, ▶, ▶▶, ◀◀, ▶▶▶** or **||** to find the edit-in and edit-out points.

5 Confirm the deletion.

- 1 Press **◀▶** to move the arrow to "PREVIEW", then press **ENTER** to preview the scene approximately 5 seconds before and after the deleted part.
 - 2 Press **◀▶** to select "EXECUTE", then press **ENTER**.
- The selected scene is deleted.

To modify the points

- 1 Press **◀▶** to move the arrow to "CLEAR", then press **ENTER**.
- 2 Repeat steps **3** – **5**.

6 Return to the normal screen.

Press **NAVIGATION**.

NOTE:

There may be a discrepancy of several seconds between the scene you intend to edit, and the scene which is actually edited.

Play back play list

Perform steps **1** to **3** of "Create Play List" (☞ pg. 68) before continuing.

1 Select the play list(s).

Press ◀▶ to move the arrow on the index (small still pictures) of the desired play list.

- When you want the plural play lists to be played back continuously, press **MEMO** after selecting the desired play lists. The numbers of the playback order appear on the index. You can select up to 30 play lists.



- When you want to correct the order, move the arrow on the desired index and press **MEMO**. The number disappears and the unit re-numbers the other play lists automatically.
- When you want to cancel the order, press ■.

2 Start playback.

Press **ENTER**. Or simply press ▶. The playback starts.

3 Pause playback.

Press **II**.

- To resume normal playback, press ▶.

4 Stop playback.

Press ■.

Delete play list

Perform steps **1** to **3** of "Create Play List" (☞ pg. 68) before continuing.

1 Select a play list.

- Press ◀▶ to move the arrow to select one play list you want to delete, then press ∇.
- Press ◀▶ to move the arrow to "DELETE", then press **ENTER**.

2 Confirm the deletion.

Press ◀▶ to select "YES", then press **ENTER**.

- When you cancel the deletion, select "NO", then press **ENTER**.

3 Return to the normal screen.

Press **NAVIGATION**.

NOTE:

Even if a play list is deleted, the programmes recorded on a DVD disc and the library information are not affected at all.

Modify Index

- Perform steps **1** to **3** of "Create Play List" (☞ pg. 68).
- Perform steps **3** to **6** of "Modify Index" (☞ pg. 65).

Modify Programme Title

- Perform steps **1** to **3** of "Create Play List" (☞ pg. 68).
- Perform steps **1** to **5** of "Modify Programme Name" (☞ pg. 66).

Modify Category

- Perform steps **1** to **3** of "Create Play List" (☞ pg. 68).
- Perform steps **1** to **4** of "Modify Category" (☞ pg. 66).

Modify Library Information



Programme information can be registered in the unit's memory for up to 1,300 programmes. It is helpful when finding out on which disc the desired programme is recorded.

- Turn on the TV and select the AV mode.
- Slide the TV/DVD switch to DVD.

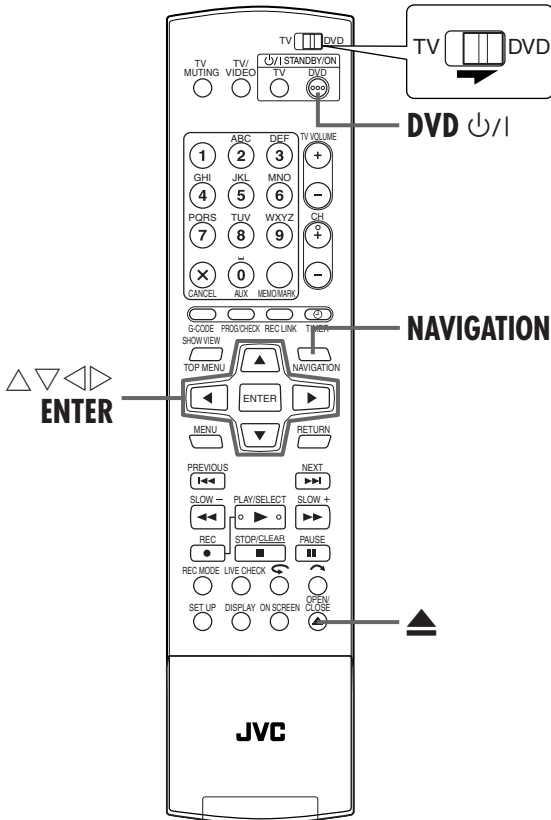

Scan for Programme from library

1 Turn on the unit.

Press DVD \uparrow/\downarrow .

2 Access the library screen.

- 1 Press **NAVIGATION**. The Library Database DVD Navi screen appears.
- 2 Press $\triangle \nabla \triangleleft \triangleright$ to move the arrow to "LIBRARY", then press **ENTER**.

3 Sort the information.

Press $\triangleleft \triangleright$ to move the arrow to the appropriate sort button to sort the information, then press **ENTER**.



"DISC No.": Sort by disc number

"CATEGORY": Sort by category

"DATE": Sort by date

"NAME": Sort by name

- The sorting order can be switched between ascending order and descending order by pressing the sort buttons.

4 Select the programme(s).

Press $\triangleleft \triangleright$ to move the arrow to select the desired programme, then press **ENTER**.

- Playback begins automatically after the selected programme is located.

When the disc that contains the selected programme is not loaded

A screen prompting you to load the designated disc appears. Place the disc whose number is displayed on the screen after pressing **ENTER** to close the prompt screen. Then perform steps **2** to **4**.

5 Return to the normal screen.

Press **NAVIGATION**.

NOTE:

If a disc registered in the library is recorded or modified on DVD units from other manufacturers, it may become impossible to operate properly.

Register disc

1 Turn on the unit.

Press DVD \uparrow /I.

2 Load a disc.

- 1 Press \blacktriangle to open the disc tray.
- 2 Place a disc you want to register on the disc tray.
 - For details, refer to "Placing a Disc" (☞ pg. 9).
- 3 Press \blacktriangle to close the disc tray.

3 Access the library screen.

- 1 Press **NAVIGATION**. The Library Database DVD Navi screen appears.
- 2 Press $\triangle \nabla \triangleleft \triangleright$ to move the arrow to "LIBRARY", then press **ENTER**.

4 Register the disc.

Press $\triangleleft \triangleright$ to move the arrow to "REGISTER", then press **ENTER**.

5 Confirm the registration.

Press $\triangleleft \triangleright$ to select "REGISTER", then press **ENTER**.

6 Return to the normal screen.

Press **NAVIGATION**.

NOTES:

- It is not possible to register discs used for On-Disc Timer Programming. (☞ pg. 56)
- It is not possible to register discs formatted on devices other than JVC's DVD recorders.
- It is not possible to register discs recorded on devices other than JVC's DVD recorders.
- It is not possible to register discs when "SAVE AS LIBRARY" is set to "OFF" in FUNCTION SET UP menu. (☞ pg. 89)

Delete information

1 Turn on the unit.

Press DVD \uparrow /I.

2 Access the library screen.

- 1 Press **NAVIGATION**. The Library Database DVD Navi screen appears.
- 2 Press $\triangle \nabla \triangleleft \triangleright$ to move the arrow to "LIBRARY", then press **ENTER**.

3 Select a programme.

- 1 Press $\triangle \nabla \triangleleft \triangleright$ to move the arrow to the appropriate sort button to sort the information, then press **ENTER**.
- 2 Press $\triangleleft \triangleright$ to move the arrow to a programme you want to delete, then press ∇ .

4 Delete the programme.

Press $\triangle \nabla \triangleleft \triangleright$ to move the arrow to "DELETE", then press **ENTER**.

5 Confirm the deletion.

Press $\triangleleft \triangleright$ to select "DELETE", then press **ENTER**.

6 Return to the normal screen.

Press **NAVIGATION**.

Locating the desired group and tracks

1 Load a disc.

- 1 Press ▲ to open the disc tray.
- 2 Place a disc on the disc tray.
- For details, refer to "Placing a Disc" (☞ pg. 9).
- 3 Press ▲ to close the disc tray.

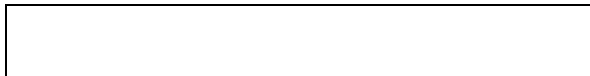

2 Access the MP3/JPEG Navigation screen.

Press **NAVIGATION**. The MP3/JPEG Navigation screen appears.

3 Display the item.

For MP3 Playback

Press ◀▶ to move the arrow to "MP3".

- Only groups which contain MP3 files appear.

For JPEG Playback

Press ◀▶ to move the arrow to "JPEG".

- Only groups which contain JPEG files appear.

4 Select the group.

5 Select the item.

NOTES:

- If you press ► instead of **ENTER** in step 4, the unit starts playback from the first file of the group.
- JPEG files are played back as a slide show at the set intervals.

☞ pg. 2323983566 ☞ DE1512005322299 B61H-2000323389 510920902573399.245 208.9173399.245 c 208.574c399.245 208.2993399.5199208.299 tracks" in the left column before continuing.

DV Dubbing

You can dub programmes from a camcorder or DV equipment connected to the unit with a DV cable. The unit's remote control allows you the limited control of the connected camcorder or DV equipment functions during dubbing.

NOTE:

When you connect a PC to the DV IN connector, we do not assure the normal operation of this unit.

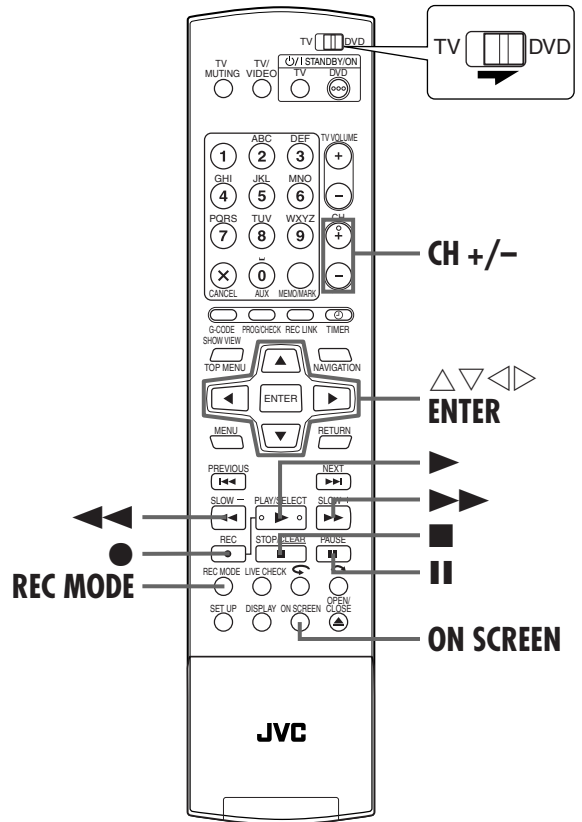
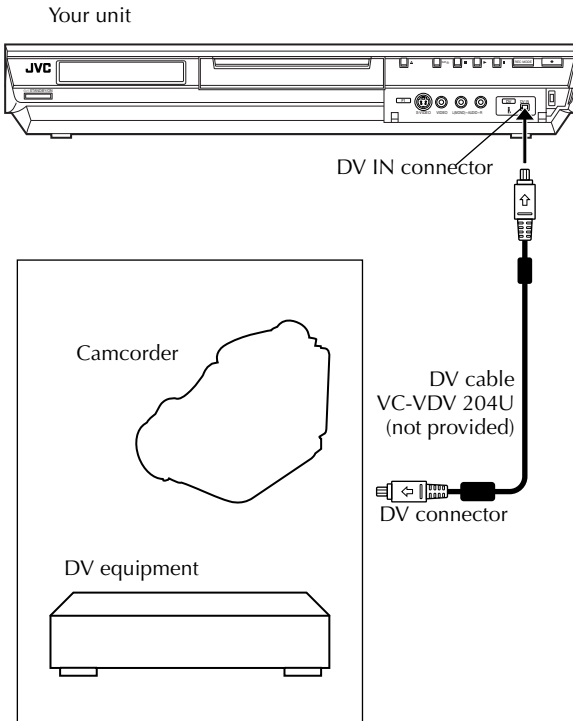

1 Make connections.

Connect a camcorder or DV equipment to the DV IN connector on the unit's front panel.



2 Prepare the unit for dubbing.

1 Load a DVD-RAM/RW/R disc on the unit.

2 Press **CH +/-** to set the channel to "DV DUBBING".

• The "DV DUBBING" controller appears on the TV screen.

• If "DV DUBBING" does not appear on the "DV DUBBING" controller, make sure the DV equipment is connected correctly.

3 Press **< >** to move  to , then press **ENTER**.

4 Press **△ ▽** repeatedly to select the desired sound track, then press **ENTER**.

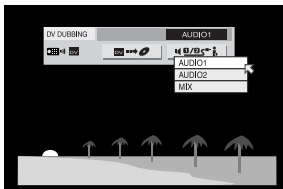

AUDIO 1: Select this to record the original stereo sound played back on the connected DV equipment.

AUDIO 2: Select this to record the dubbed stereo sound played back on the connected DV equipment.

MIX: Select this to record the sound of both "AUDIO 1" and "AUDIO 2".

• Note that this selection is not available when the source programme is recorded in 16BIT (48 kHz) mode.

5 Press **REC MODE** repeatedly until the desired recording speed appears. (☞ pg. 48, "Recording Speed")

3 Prepare the DV equipment for dubbing.

Locate the point from where you want to start dubbing, then stop or pause playback by pressing the following buttons on the remote control:

▶, ▶▶, ◀◀, ■, ||

• To play back in slow speed (1/10 of the normal speed), press **||** to pause playback, then press **◀◀** or **▶▶**.

• To play back frame-by-frame, press **||** to pause playback, then press **||** repeatedly. Each press of **||** advances a frame.

• To change the playback direction, press **◀◀** or **▶▶**.

4 Start dubbing.

Press **< >** to move the arrow to , then press **ENTER**.

• Playback on the external DV equipment and recording on the unit should start simultaneously.

• When the playback from the beginning is not possible, the "DV DUBBING" controller cannot be used. Perform dubbing without using the "DV DUBBING" controller. (☞ right column)

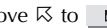
• To pause dubbing, press **< >** to move  to , then press **ENTER**. Both the unit and the external DV equipment pause dubbing. Pressing **||** on the unit also works the same way.

• To clear the "DV DUBBING" controller from the TV screen, press **ON SCREEN**.

5 Stop dubbing.

Press **■** on the remote control.

• Both the unit and the external DV equipment stop dubbing.

NOTES:

• Dubbing copyright guarded programmes is not possible.

• Original DV informations such as the recording date and time are not recorded.

• The superimposed indication during the operation or dubbing is not recorded.

• Only DV format image can be dubbed; MPEG2 format image cannot be dubbed.

Performing dubbing without using the "DV DUBBING" controller

1 Press **CH +/-** to set the channel to "DV DUBBING".

2 Press **REC MODE** repeatedly until the desired recording speed appears.

3 Start playback on the external DV equipment slightly before the actual point from where you wish to start dubbing.

4 Press and hold **●**, then press **▶** on the remote control, or press **●** on the unit.

• Dubbing starts.

5 When the dubbing ends, press **■** on the unit, then stop playback on the external DV equipment.

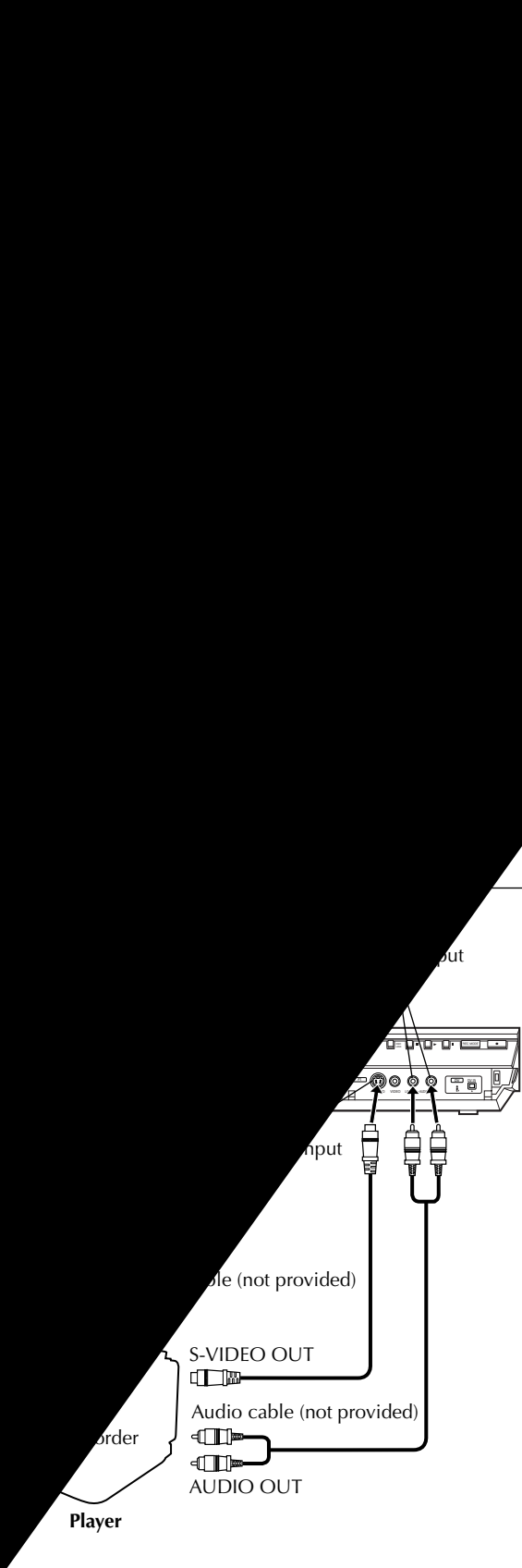

... connector:
 ... OUT and VIDEO
 ... and VIDEO
 ...
 ... output connector:
 ... AUDIO OUT and
 ... the unit's AUDIO and
 ... on the front panel.
 ... recorder, connect its AUDIO OUT
 ... input connector on your unit.

Set the input mode.

... set the channel to "F-1".
 ... to "VIDEO" for the VIDEO input connector,
 ... for the S-VIDEO input connector, depending on
 ... for being used. (☞ pg. 81, "F-1 Input Setting
 ...")

Set the recording speed.

... Press REC MODE repeatedly until the desired recording
 ... speed appears.

4 Prepare the camcorder for dubbing.

Start playback on the camcorder slightly before the actual
 point from where you wish to start dubbing.

5 Start dubbing.

Press and hold ●, then press ► on the remote control, or
 press ● on the unit.

6 Stop dubbing.

Press ■ on the unit, then stop playback on the
 camcorder.

NOTES:

- All necessary cables can be obtained from your dealer.
- Refer to the camcorder's instruction manual for operating
 procedure.
- The quality of dubbed picture becomes poorer than that of the
 original.

Edit To Or From Another Recorder

You can use your unit as the source player or as the recording deck.

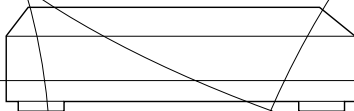
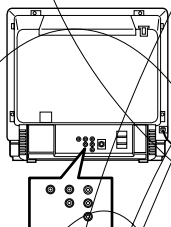
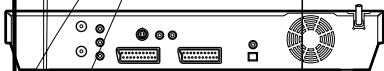
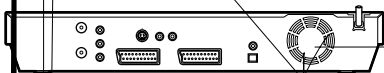
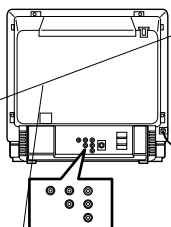

1 Make connections

- 1 When using your unit as the source player:
 - connect its L-1 IN/OUT connector to the recording deck via output cable adapter.
- 2 When using your unit as the recording deck:
 - connect its L-2 IN connector to the source player via input cable adapter.

2 Set the input mode of recording deck.

With this unit, press **CH +/-** to select "L-2".

- When using another recorder as the recording deck, refer to its instruction manual.
- When using the L-2 IN connector, set "L-2 SELECT" to "VIDEO". (☞ pg. 81, "L-2 Select Setting (L-2 SELECT)")

3 Set the recording speed.

Press **REC MODE** repeatedly until the desired recording speed appears.

4 Start the source player.

Engage the Play mode of the source player.

5 Start the recording deck.

Engage the Record mode of the recording deck.

6 Stop dubbing.

Stop recording on the recording deck, then stop playback on the source player.

NOTES:

- All necessary cables can be obtained from your dealer.
- When you use this unit as the source player for editing, be sure to set "SUPERIMPOSE" to "OFF" before starting. (☞ pg. 90)
- If you are using another recorder with S-Video and Audio output connectors, connect its S-Video and Audio output connectors to this unit's S-VIDEO and AUDIO input connectors on the front panel. Then, set the unit's input mode to "F-1" in step 2, and set "F-1 INPUT" to "S-VIDEO". (☞ pg. 81, "F-1 Input Setting (F-1 INPUT)")





Remote Control Functions

Remote 1/2/3/4 Code Switching

The remote control is capable of controlling four JVC video units independently. Each of the units can respond to one of four codes (1, 2, 3 or 4). The remote control is preset to send 3 code signals because your unit is initially set to respond to 3 code signals. You can easily modify your unit to respond to 2, 3 or 4 code signals.

Slide the TV/DVD switch to DVD.

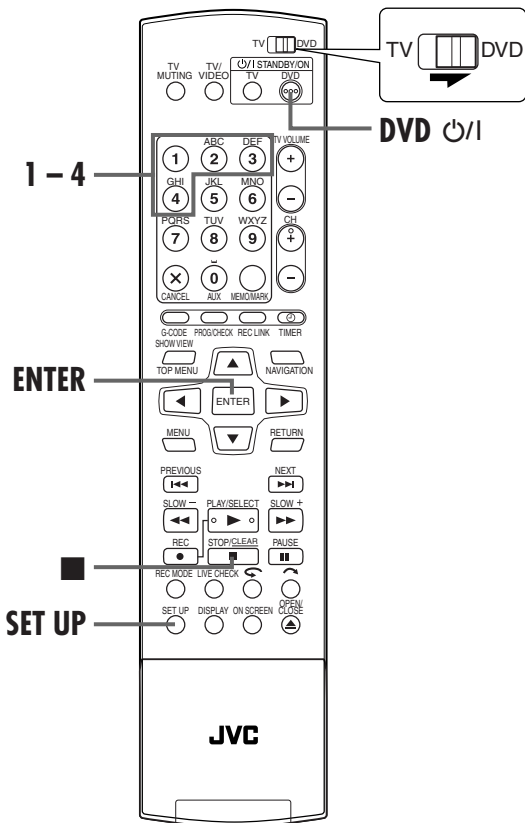
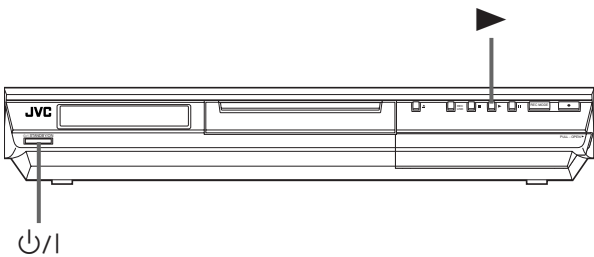

On the remote control

Keep pressing SET UP down during steps 1 - 2.

1 Change the remote control code.

Press the number key "1" for 1, "2" for 2, "3" for 3 or "4" for 4.

2 Set the remote control code.

Press ENTER to set the code.

On the unit

3 Turn off the unit.

Press \odot /I on the unit.

4 Display the code.

Press \blacktriangleright on the unit for over 5 seconds while the unit is turned off.

- The code currently set appears on the front display panel.

5 Change the unit's code.

Press \blacksquare on the remote control.

- The code currently set on the remote control blinks on the front display panel for approximately 5 seconds, and is applied to the unit.

NOTE:

When "POWER SAVE" is set to "ON" (pg. 90), it is not possible to change the remote code.

TV Multi-Brand Remote Control

Your remote control can operate the basic functions of the TV set. In addition to JVC TVs, other manufacturer's TV sets can be controlled.

Before performing the following steps:

- Turn off the TV using its remote control.
- Set the TV/DVD switch to TV.

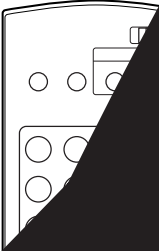

Connecting To A Satellite Receiver

Connect the satellite receiver to the L-2 IN connector, then connect the L-1 IN/OUT connector to the TV's connector via cable adapters.

Make sure that the unit is turned on to view satellite broadcast with this connection.

NOTES:

- Set "L-2 SELECT" to "VIDEO". (☞ pg. 81)
- You can use the Automatic Satellite Programme Recording function (☞ pg. 61) with this connection.
- To record a programme via the satellite receiver, select L-2 mode by pressing **CH +/-** so that "L-2" appears on the front display panel.
- For details, refer to the instruction manual of the satellite receiver.

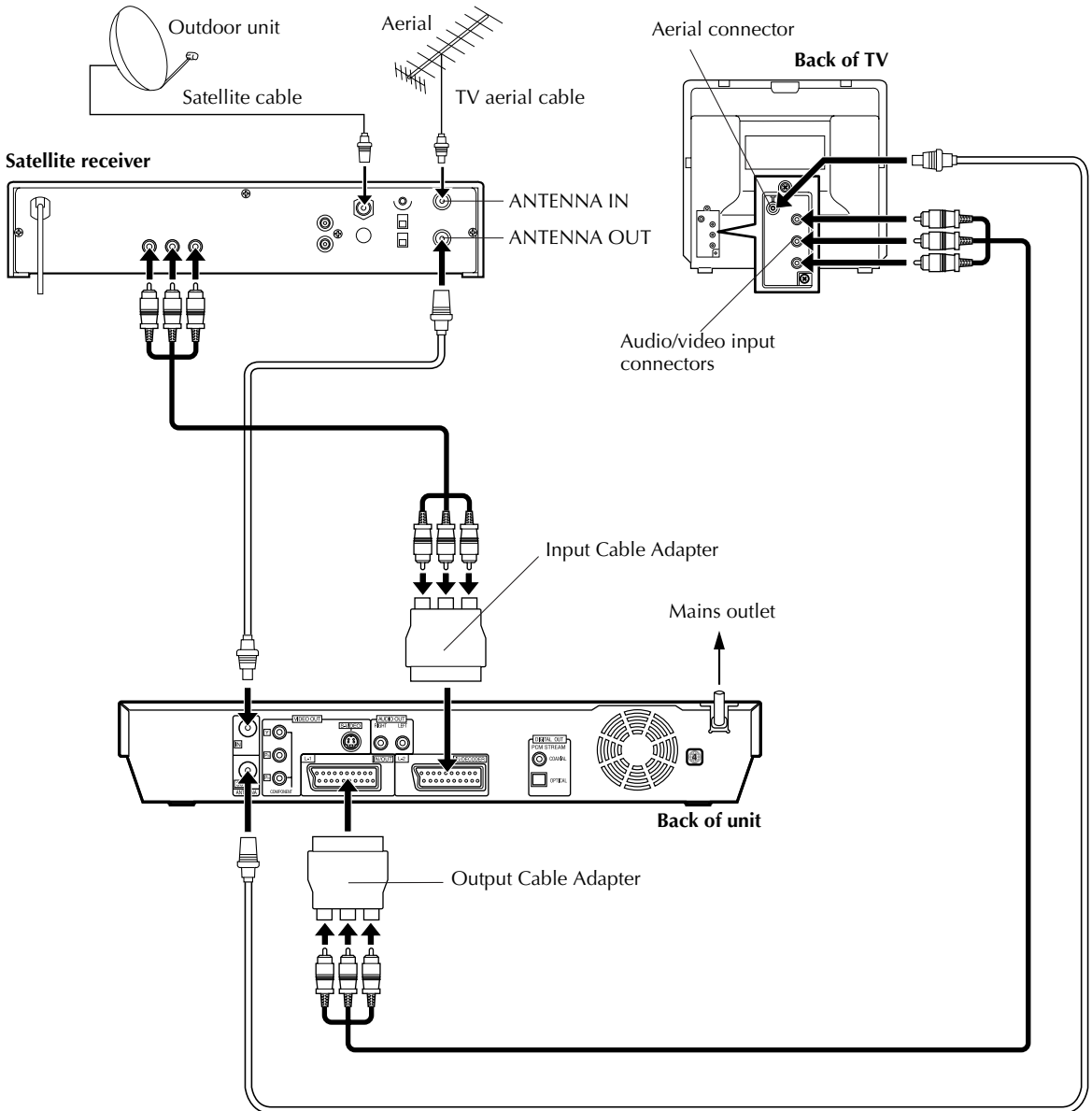

Connecting To A Dolby Digital Decoder Or An Amplifier With Built-in DTS

These instructions enable you to connect your unit to a Dolby Digital decoder or an amplifier with built-in DTS.

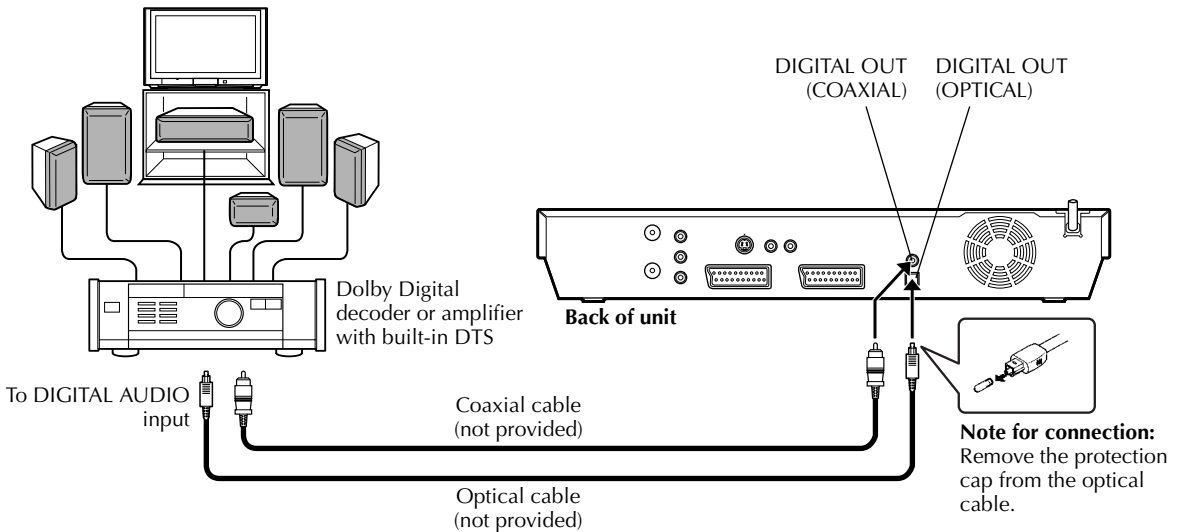

Make connections.

Connect the unit and a Dolby Digital decoder or an amplifier with built-in DTS using either an optional optical cable or an optional coaxial cable.

NOTES:

- For Dolby Digital sound, set "DIGITAL AUDIO OUT" to "DOLBY DIGITAL/PCM". (☞ pg. 88)
- For DTS sound, set "DIGITAL AUDIO OUT" to "STREAM/PCM". (☞ pg. 88)

CAUTIONS:

- This unit has a dynamic range of more than 110 dB with regards to its Hi-Fi audio capability. It is recommended that you check the maximum level if you are going to listen to the Hi-Fi audio signals through a stereo amplifier. A sudden surge in the input level to the speakers may damage them.
- Some speakers and televisions are specially shielded to prevent television interference. If both are of the non-shielded type, do not place the speakers adjacent to the TV set as this can adversely affect the playback picture.

When you can't switch the audio channel of a bilingual programme

When the unit is connected with a digital audio device using an optional optical cable and "DIGITAL AUDIO OUT" is set to "DOLBY DIGITAL/PCM", it is not possible to switch the audio channel of a bilingual programme recorded on a DVD-RAM or DVD-RW (VR mode) disc. In this case, perform the following steps using the remote control to switch "DIGITAL AUDIO OUT" from "DOLBY DIGITAL/PCM" to "PCM ONLY".

- 1 Press **SET UP** to access the Main Menu screen.
- 2 Press **< >** to select "DVD SET UP", then press **ENTER**.
- 3 Press **< >** to select "AUDIO OUTPUT", then press **ENTER**.
- 4 Press **△ ▽** to select "DIGITAL AUDIO OUT", then press **ENTER**.
- 5 Press **△ ▽** to select "PCM ONLY", then press **ENTER**. (☞ pg. 88)
- 6 Press **SET UP** to complete the setting.
- 7 Press **AUDIO** to select the desired audio channel. (☞ pg. 30, "Audio Channel Selection")



AUDIO OUTPUT

(The **boldface** settings in the table below indicate the settings at your purchase.)

<p>■ DIGITAL AUDIO OUT DOLBY DIGITAL/PCM STREAM/PCM PCM ONLY</p>	<p>Set to the appropriate mode according to the type of the device connected to DIGITAL OUT connector.</p> <p>DOLBY DIGITAL/PCM: Select this when you connect the digital input connector of a Dolby Digital decoder or an amplifier with a built-in Dolby Digital decoder.</p> <p>STREAM/PCM: Select this when you connect the digital input connector of an amplifier with a built-in DTS, Dolby Digital, or MPEG multichannel decoder.</p> <p>PCM ONLY: Select this when you connect the linear PCM digital input of other audio equipment (amplifier, MD or DAT deck, etc.).</p>
<p>■ ANALOG AUDIO OUT STEREO DOLBY SURROUND</p>	<p>Select the appropriate setting to accommodate the unit to the connected A/V equipment. This function takes effect when a DVD VIDEO disc is played back.</p> <p>STEREO: Select this when listening to conventional two-channel stereo audio with the unit's AUDIO OUT connectors connected to a stereo amplifier/receiver or TV set, or in case you want to record the audio from a DVD VIDEO disc to a Mini Disc, etc.</p> <p>DOLBY SURROUND: Select this when listening to multichannel surround audio with the unit's AUDIO OUT connectors connected to an amplifier/receiver with a built-in surround decoder or a surround decoder.</p>
<p>■ D. RANGE CONTROL NORMAL WIDE RANGE TV MODE</p>	<p>The dynamic range (the difference between the loudest sound and the quietest one) can be compressed during playback of a programme encoded in Dolby Digital format. This function takes effect when a DVD VIDEO disc recorded in Dolby Digital format is played back at low or middle volume.</p> <p>NORMAL: Normally select this setting to activate this function.</p> <p>WIDE RANGE: Select this to deactivate this function when you enjoy wide dynamic range programme.</p> <p>TV MODE: Select this when you hear the sound through the TV's speaker(s).</p> <p>NOTES:</p> <ul style="list-style-type: none"> • This function takes no effect on programmes other than that recorded in Dolby Digital format. • This function dose not work when Simulated Surround Effect is activated. (☞ pg. 40) • The effect of "NORMAL" and "WIDE RANGE" may not be different depending on discs.
<p>■ OUTPUT LEVEL STANDARD LOW</p>	<p>You can lower the output level of analog audio to accommodate the unit to the connected A/V equipment.</p> <p>STANDARD: Normally select this setting.</p> <p>LOW: The output level of analog audio is lowered.</p>

RECORDING SET

(The **boldface** settings in the table below indicate the settings at your purchase.)

<p>■ SAVE AS LIBRARY OFF ON</p>	<p>When this function is set to "ON", the recording information is automatically stored in the library. For details, refer to "Modify Library Information" (☞ pg. 72).</p>
<p>■ XP MODE REC AUDIO DOLBY DIGITAL LINEAR PCM</p>	<p>You can select the audio format when you record a programme in XP mode. When this function is set to "LINEAR PCM", you can obtain a high-quality audio sound.</p> <p>DOLBY DIGITAL: To record in Dolby Digital format.</p> <p>LINEAR PCM: To record in Linear PCM format.</p>
<p>■ AUDIO REC NICAM 1/MAIN NICAM 2/SUB MONO</p>	<p>You can select the desired NICAM audio channel to be recorded on a DVD-R/RW (Video mode) disc.</p> <p>NICAM 1/MAIN: To record the main language of NICAM audio.</p> <p>NICAM 2/SUB: To record the sub language of NICAM audio.</p> <p>MONO: To record the standard (monaural) sound of NICAM audio.</p> <p>NOTE: This function works only for the NICAM bilingual programme.</p>
<p>■ INPUT COLOUR SYSTEM PAL SECAM</p>	<p>You can play back PAL discs, or record PAL and SECAM signals on this unit. Select the appropriate colour system.</p> <p>PAL: To record PAL signals.</p> <p>SECAM: To record SECAM signals.</p>

DISPLAY SET

(The **boldface** settings in the table below indicate the settings at your purchase.)

<p>■ SUPERIMPOSE OFF AUTO</p>	<p>You can select the modes of indications superimposed on the TV screen.</p> <p>OFF: To turn off superimposed indications.</p> <p>AUTO: To superimpose operational indications for approximately five seconds just after the corresponding operation.</p> <p>NOTES:</p> <ul style="list-style-type: none"> • When you use this unit as the source player for editing, be sure to set "SUPERIMPOSE" to "OFF" before starting. (☞ pg. 79, "Edit To Or From Another Recorder") • When you select "AUTO", during playback, the operation mode indicators may be disturbed depending on the type of disc being used.
<p>■ GREY BACK OFF ON</p>	<p>When this function is set to "ON", the TV screen becomes all grey when receiving a channel not in use.</p> <p>NOTE: When you want to receive an unstable channel with poor signals, set this function to "OFF".</p>
<p>■ DIMMER BRIGHT DIMMED1 DIMMED2 OFF</p>	<p>You can change the brightness of the front display panel and blue lamp of the disc tray.</p> <p>BRIGHT: Normally select this.</p> <p>DIMMED1/DIMMED2: To change the brightness level.</p> <p>OFF: To dim the front display panel.</p>
<p>■ POWER SAVE OFF ON</p>	<p>When this function is set to "ON", you can reduce the power consumption while the unit is turned off.</p> <p>NOTES:</p> <ul style="list-style-type: none"> • During Power Save mode — — the front display panel will be turned off. • Power Save does not work when — — the unit is in the Timer mode. — the unit's power is turned off after timer-recording or Instant Timer Recording. — the Automatic Satellite Programme Recording mode is engaged. (☞ pg. 61) • It takes some time for the unit to complete initialisation after you turn on unit power, with "WAKE UP" blinking on the front display panel.
<p>■ ON SCREEN LANGUAGE</p>	<p>This unit offers you the choice to view on-screen messages in 10 different languages. You can change the language setting manually as required. For details, refer to "On-screen Language Set" (☞ pg. 22).</p>

OTHERS

(The **boldface** settings in the table below indicate the settings at your purchase.)

<p>■ AUTO TIMER OFF ON</p>	<p>When this function is set to "ON", the timer is automatically engaged when the unit power is turned off, and automatically disengaged when the unit is powered back on.</p> <p>NOTE: For safety, when "AUTO TIMER" is set to "OFF", all other functions are disabled while the Timer mode is engaged. To disengage the timer, press ⏸ (TIMER).</p>
<p>■ RESUME ON OFF DISC RESUME</p>	<p>When this function is set to "ON" or "DISC RESUME", you can use the resume function. (📖 pg. 27)</p> <p>ON: You can start playback from the resume point of the placed disc.</p> <p>OFF: You cannot use the resume function.</p> <p>DISC RESUME: The unit retains a memory of the resume points of the last 30 discs played back, even though they have been ejected.</p> <p>NOTE: "DISC RESUME" setting works on DVD VIDEO, VCD, SVCD and already finalised DVD-R/DVD-RW (video mode) discs. For other types of discs, the function under "ON" setting will be applied even if "RESUME" is set to "DISC RESUME".</p>

Tuner Set

- Turn on the unit.
- Turn on the TV and select the AV mode.
- Slide the **TV/DVD** switch to **DVD**.

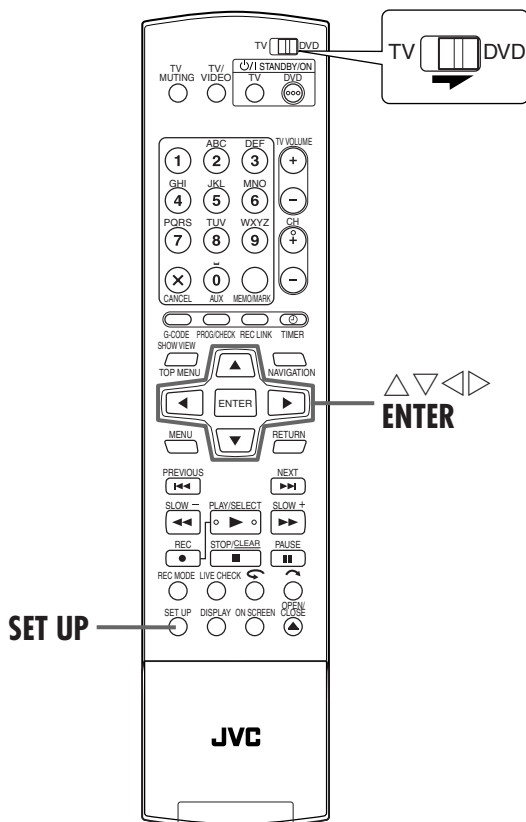

IMPORTANT:

Perform the following steps only if —
 — Auto Channel Set has not been set correctly by Auto Set Up. (pg. 19)
 — you have moved to a different area or if a new station starts broadcasting in your area.

Your unit needs to memorise all necessary stations in channel positions in order to record TV programmes. Auto Channel Set automatically assigns all receivable stations in your area to call them up by using the **CH +/-** buttons without going through any vacant channels.

Auto Channel Set

1 Access the Main Menu screen.

Press **SET UP**.

2 Access the "AUTO CH SET" screen.

- 1 Press **< >** to select "INITIAL SET UP", then press **ENTER**.
- 2 Press **< >** to select "AUTO CH SET", then press **ENTER**.

3 Select the TV system.

Press **△ ▽** to select the appropriate TV system (refer to the table below).

Major Countries/Areas	TV System
Australia, New Zealand, Kuwait, U.A.E., Indonesia, Singapore, Thailand, Malaysia, Iran, Saudi Arabia, Egypt, Morocco, Lebanon, Iraq	B/G
China, Mongolia, Russia	D/K
Hong Kong	I

4 Perform Auto Channel Set.

Press **ENTER**.

- The Auto Set screen appears, and remains on screen while the unit searches for receivable stations. Wait until the TV screen as shown in step 5 appears.

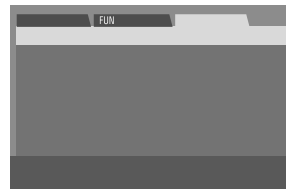

5 View the Confirmation screen.

“SCAN COMPLETED” is displayed on the TV screen. Press “OK”, then the Confirmation screen appears. The confirmation screen lists the channel position number (PR), station channel number (CH) of all stored broadcast stations. The programme currently received on the selected channel position appears behind the confirmation screen. To view the next page, press $\triangle \nabla \triangleleft \triangleright$.

6 Complete the setting.

Press **SET UP**.

- Using the Confirmation screen, you can skip or add channel positions, enter station names and perform other operations. Refer to pages 93 – 95 for the procedures.
- Depending on reception conditions, the stations may not be stored in order.

NOTES:

- Fine tuning is performed automatically during Auto Channel Set. If you want to perform tuning manually, refer to “Fine-Tuning Channels Already Stored” (📖 pg. 95).
- If you perform Auto Channel Set when the aerial cable is not connected properly, “SCAN COMPLETED –NO SIGNAL–” appears on the TV screen in step 5. In such a case, make sure of the aerial connection and press **ENTER**; Auto Channel Set will start again.
- If no sound accompanies the picture or the audio sounds unnatural on some channels that have been stored by Auto Set Up, the TV system setting for those channels may be incorrect. Select the appropriate TV system for those channels. (📖 pg. 95, “TV System Selection — When you see the picture but the audio can’t be heard or sounds unnatural”)

Manual Channel Set

Store channels that were not stored during Auto Set Up (📖 pg. 19) or Auto Channel Set (📖 pg. 92).

1 Access the Main Menu screen.

Press **SET UP**.

2 Access the Confirmation screen.

1 Press $\triangleleft \triangleright$

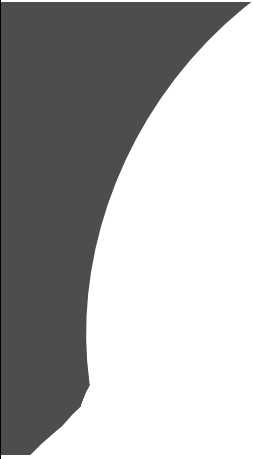

Set Stations

You can set the desired station name.

Perform steps **1** and **2** of "Manual Channel Set" on page 93 to access the Confirmation screen before continuing.

1 Select the channel to set the station name.

Press $\Delta \nabla \triangleleft \triangleright$ to select the channel you want to set the station name, then press **ENTER** twice.

2 Select the character for station name.

Press $\Delta \nabla$ to select "ID", then press **ENTER** twice. ID setting screen appears.

3 Enter the character.

- 1 Press $\triangleleft \triangleright$ to locate the character insertion point.
- 2 Press $\Delta \nabla$ to cycle through the characters (A–Z, 0–9, –, *, +, _ (space)) and stop when the desired character is indicated, then press \triangleright to enter.
- 3 Enter the remaining characters the same way (maximum of 4).
- 4 After entering all characters, press $\triangleleft \triangleright$ to select "OK", then press **ENTER**.

4 Close the Confirmation screen.

Press **SET UP** three times.

NOTE:

The characters available for the station name (ID) are A–Z, 0–9, –, *, +, _ (space) (maximum of 4).

Fine-Tuning Channels Already Stored

Perform steps **1** and **2** of "Manual Channel Set" on page 93 to access the Confirmation screen before continuing.

1 Select the channel to fine-tune.

Press $\Delta \nabla \triangleleft \triangleright$ to select the channel you want to fine-tune, then press **ENTER** twice.

2 Perform fine-tuning.

- 1 Press $\Delta \nabla$ to select "FINE".
- 2 Press $\triangleleft \triangleright$ until the picture appears in its best quality.
 - Repeat steps **1** – **2** as necessary.

3 Close the Confirmation screen.

Press **SET UP** three times.

TV System Selection — When you see the picture but the audio can't be heard or sounds unnatural

Perform steps **1** and **2** of "Manual Channel Set" on page 93 to access the Confirmation screen before continuing.

1 Select the channel.

Press $\Delta \nabla \triangleleft \triangleright$ to select the channel you want to change its TV system, then press **ENTER** twice.

2 Select the TV system.

- 1 Press $\Delta \nabla$ to select "TV SYSTEM", then press **ENTER**.
- 2 Press $\Delta \nabla$ until the appropriate TV system appears, then press **ENTER**.

Major Countries/Areas	TV System
Australia, New Zealand, Kuwait, U.A.E., Indonesia, Singapore, Thailand, Malaysia, Iran, Saudi Arabia, Egypt, Morocco, Lebanon, Iraq	B/G
China, Mongolia, Russia	D/K
Hong Kong	I

3 Close the Confirmation screen.

Press **SET UP** three times.

Clock Set

- Turn on the unit.
- Turn on the TV and select the AV mode.
- Slide the TV/DVD switch to DVD.

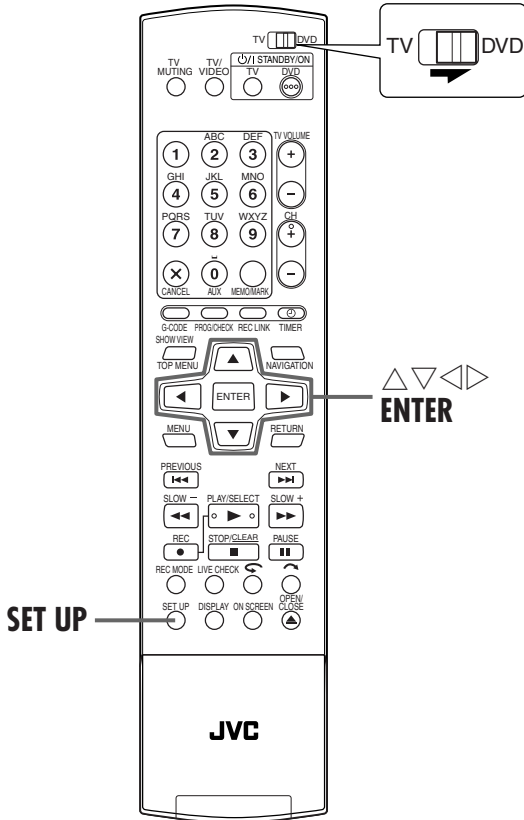

1 Access the Main Menu screen.

Press SET UP.

2 Access the "CLOCK SET" screen.

- 1 Press $\triangleleft \triangleright$ to select "INITIAL SET UP", then press ENTER.
- 2 Press $\triangleleft \triangleright$ to select "CLOCK SET", then press ENTER.

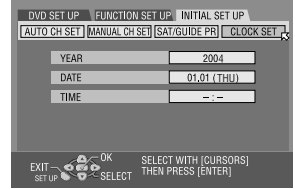

3 Set the date and time.

- 1 Press $\triangle \nabla$ to select "YEAR", then press ENTER.
 - 2 Press $\triangle \nabla$ to set the year, then press ENTER.
- Repeat the same procedure to set the date and time. When you set the time, press and hold $\triangle \nabla$ to change the time by 30 minutes.
 - When you set the date, press and hold $\triangle \nabla$ to change the date by 15 days.

4 Start the clock operation.

Press SET UP.

Format A Disc



Some DVD-RAM/RW discs are unformatted. Format the disc when you use an unformatted disc or you want to delete all recordings and data on the disc.

ATTENTION:

- When a disc is formatted, all recordings and data are erased. It is impossible to restore them.
- Never turn off the unit or disconnect the mains power cord while "NOW FORMATTING..." is displayed on the TV screen.

- Turn on the unit.
- Turn on the TV and select the AV mode.
- Slide the TV/DVD switch to DVD.
- Load a DVD-RAM/RW disc to format.

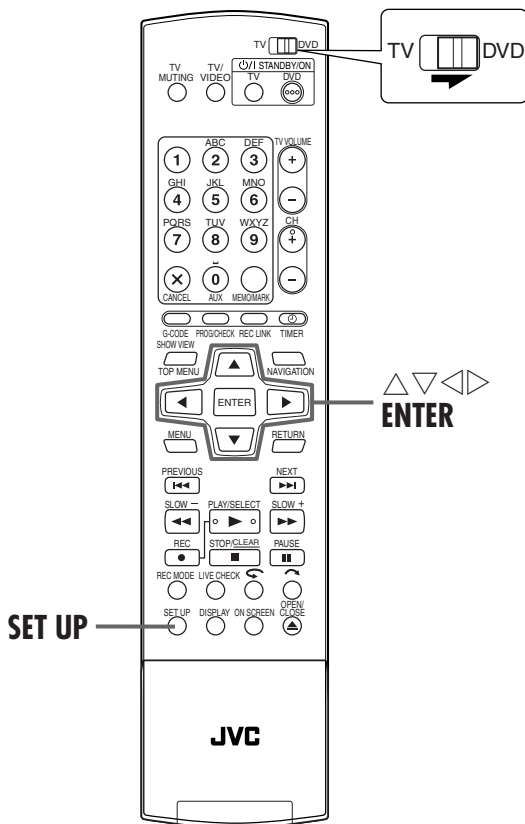

Format a DVD-RAM disc

1 Access the Main Menu screen.

Press **SET UP**.

2 Access the "UTILITY" screen.

- 1 Press $\Delta \nabla \triangleleft \triangleright$ to select "DVD SET UP", then press **ENTER**.
- 2 Press $\triangleleft \triangleright$ to select "UTILITY", then press **ENTER**.

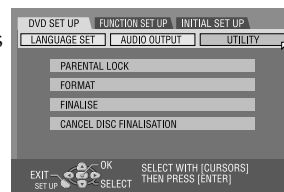

3 Format the disc.

- 1 Press $\Delta \nabla$ to select "FORMAT", then press **ENTER**. Press $\triangleleft \triangleright$ to select "YES", then press **ENTER** when "DISC WILL BE FORMATTED" appears on the TV screen.
- 2 Press $\triangleleft \triangleright$ to select "OK", then press **ENTER** when "DISC FORMATTING WAS SELECTED" appears on the TV screen.

Format a DVD-RW disc

Perform steps **1** to **2** of "Format a DVD-RAM disc" on the above before continuing.

1 Format the disc.

- 1 Press $\Delta \nabla$ to select "FORMAT", then press **ENTER**. Press $\triangleleft \triangleright$ to choose "VR MODE" or "VIDEO MODE", then press **ENTER** when "DISC WILL BE FORMATTED" appears on the TV screen.
 - "VR MODE": To be chosen when you want to record, erase, or edit data on the disc repeatedly.
 - "VIDEO MODE": To be chosen when you want to erase all the data on the disc once played back to record new data, or play the disc on other DVD players.
- 2 Press $\triangleleft \triangleright$ to select "YES", then press **ENTER** when "DISC WILL BE FORMATTED IN VR MODE/VIDEO MODE" appears on the TV screen.

NOTES:

- It is impossible to format Version 1.0 DVD-RW discs in Video mode.
- It is impossible to format DVD-R discs.
- All the programmes on a disc will be deleted once the disc is formatted even if they are protected titles. (pg. 66, "Protect title")



Scan Mode Set

You can select the scan mode from two modes: Interlaced scan mode which is used in the conventional TV system, and Progressive scan mode which enables reproduction of higher-quality images. For details, refer to "GLOSSARY" (☞ pg. 104).

- Turn on the unit.
- Turn on the TV and select the AV mode.
- Slide the **TV/DVD** switch to **DVD**.

ATTENTION:

Your TV needs to be compatible with PAL Progressive.

1 Set the scan mode.

Press **PROGRESSIVE SCAN** for 3 or more seconds.

- Video output indicator (P) lights on the front display panel if Progressive scan mode has been established. (☞ pg. 13)
- Each press of **PROGRESSIVE SCAN** for 3 or more seconds switches the scan mode.

NOTES:

- When the progressive mode is set, be sure to set "L-1 OUTPUT" to "COMPONENT". (☞ pg. 80, "L-1 Output and L-1 Input Setting (L-1 OUTPUT and L-1 INPUT)") Progressive scan is output only from COMPONENT VIDEO OUT connector.
- Interlaced scan mode is the setting at your purchase.
- When Progressive scan mode is engaged, no video signal is output from S-VIDEO OUT connector and L-1 IN/OUT connector.
- Interlaced scan mode might be suitable depending on video material.
- Scan mode cannot be set while menu screen is displayed.

Tray Lock

You can lock the disc tray to prohibit the unwanted disc ejection by children.

- Turn off the unit.

1 Lock the disc tray.

While the unit is turned off, press and hold ■, then press ▲ on the unit. "LOCK" appears on the front display panel.

- If you try to eject the discs, "LOCK" appears and indicates that tray is locked.

To unlock tray

While the unit is turned off, press and hold ■, then press ▲ on the unit. "UNLOCK" appears on the display panel.

Before requesting service for a problem, use this chart and see if you can solve the trouble yourself. Small problems are often easily solved, and this can save you the trouble of sending your unit off for repair.

GENERAL

SYMPTOM	POSSIBLE CAUSE	CORRECTIVE ACTION
1. No power is supplied to the unit.	<ul style="list-style-type: none"> The AC power plug is disconnected from the mains. 	Connect the AC power plug to the mains securely. (☞ pg. 16)
2. The channel cannot be changed.	<ul style="list-style-type: none"> Recording or Live Memory recording is in progress. 	Press II to pause recording, change the channel, then press ▶ to resume recording.
3. The remote control does not operate the unit.	<ul style="list-style-type: none"> The setting of the remote control code is inappropriate. The batteries are discharged. 	Set the same remote control code (1, 2, 3, or 4) on both the unit and the remote control. (☞ pg. 83) Replace the dead batteries with new ones.
4. Dubbing from the external equipment is not possible.	<ul style="list-style-type: none"> The setting of the input channel position is inappropriate. 	Select the input channel position ("F-1" or "L-2") that corresponds to the input terminal connected to the external equipment. (☞ pg. 79)
5. The on-screen display superimposed on the programme played back/received on this unit is recorded when you dub the programme to an external recording equipment.	—	Set "SUPERIMPOSE" to "OFF". (☞ pg. 90)
6. The remote control does not work properly.	<ul style="list-style-type: none"> The batteries are discharged. 	Remove the batteries, wait for 5 minutes or more, then load the batteries again. Replace the dead batteries with new ones.
7. The unit does not operate.	<ul style="list-style-type: none"> There are cases when the operation is prohibited on the disc. Lightning or static electricity may cause malfunction of the unit. 	— Press ⏻ to turn the power off, then press the button again to turn the power on.

PLAYBACK

SYMPTOM	POSSIBLE CAUSE	CORRECTIVE ACTION
1. Images do not appear on the TV screen.	<ul style="list-style-type: none"> The TV is not set to the AV mode. When interlace scanned programme is played back, progressive scan mode is selected. 	Set the TV to the AV mode. Press and hold PROGRESSIVE SCAN until P disappears from the front display panel.
2. Playback does not start or stop immediately after playback is started by pressing ▶ . On the front display panel, "NO DISC" appears.	<ul style="list-style-type: none"> The disc is loaded upside down. A disc not being compatible with the unit is loaded. A dirty disc is loaded. Defective disc is loaded. 	Place the disc on the disc tray with the playback surface facing downward. (☞ pg. 9) Load a playable disc on the unit. (☞ pg. 5, 6) Clean the disc. (☞ pg. 9) Replace the warped or scratched disc with a normal one.
3. Images are blurred or distorted when you start High-Speed Search.	—	Images are blurred or distorted at the point where the playback speed changes and this is not a malfunction of the unit.
4. Playback does not start.	—	Playback does not start for approximately 30 seconds after recording is stopped and this is not a malfunction of the unit.
5. Playback does not start when you select a title or a chapter.	<ul style="list-style-type: none"> The Parental Lock is engaged and the disc is rated higher than the set level. 	Release the Parental Lock temporarily or change the set level. (☞ pg. 44)

9. The disc space does not increase when recorded programmes are cleared.	<ul style="list-style-type: none"> • The PC's data recorded on a DVD-RAM drive cannot be cleared on this unit. 	Format the disc. (When the disc is soiled, wipe the disc with a soft dry cloth before formatting.) (☞ pg. 9, 97)
---	---	--

INITIALIZING

SYMPTOM	POSSIBLE CAUSE	CORRECTIVE ACTION
1. Malfunction occurs on the unit.	—	Press $\psi/1$ to turn off the unit, press and hold $\psi/1$, then press \blacksquare for two seconds or more.
2. The Disc Tray doesn't open.	—	Take out the disc in following ways. <ul style="list-style-type: none"> • connect and disconnect the power cord from the mains outlet. • press and hold the open/close button (\blacktriangle) on the unit until the disc tray opens.(it will take about 30 sec.) • close the disc tray by pressing the open/close button after taking out the disc.(the main power shuts down)

ATTENTION:

This unit contains microcomputers. External electronic noise or interference could cause malfunctioning. In such cases, switch the unit off and unplug the mains power cord. Then plug it in again and turn the unit on. Take out the disc. After checking the disc, operate the unit as usual.

ON-SCREEN MESSAGES

MESSAGE	DESCRIPTION
MEMORY IS FULL NOTHING MORE CAN BE REGISTERED IN THE LIBRARY IF YOU DELETE UNNECESSARY TITLE INFORMATION, YOU CAN THEN REGISTER ADDITIONAL INFORMATION	The memory is full for registration for the Navigation system. The recording cannot be started even though the capacity for the recording is enough. (☞ pg. 67)
AVAILABLE MEMORY IS LOW SOON YOU WILL NO LONGER BE ABLE TO REGISTER INFORMATION IN THE LIBRARY IF YOU DELETE UNNECESSARY TITLE INFORMATION, YOU CAN THEN REGISTER ADDITIONAL INFORMATION	The remaining capacity of the memory is not enough for registration for the Navigation system. The recording cannot be started even though the capacity for the recording is enough. (☞ pg. 67)
DISC NOT REGISTERED IN THE LIBRARY REGISTER DISC?	A disc that is not registered in the library has been inserted. Register the disc as necessary. (☞ pg. 73)
INSERT DISC #XXXX	Appears when a title that has been selected in the library is not contained in the loaded disc. (☞ pg. 72)
CAN NOT RECORD OR MAKE PLAY LIST DELETE UNWANTED TITLES	<ul style="list-style-type: none"> Recording and/or editing cannot be performed with a loaded DVD-RAM disc. The number of titles exceeds 99. The number of play lists exceeds 999.
SET CLOCK BEFORE TIMER PROGRAMMING	To set the timer programme, the clock must be set in advance. (☞ pg. 96)
PROGRAMME FULL DELETE UNWANTED TIMER PROGRAMME	You can programme this unit to timer-record as many as 8 programmes. To programme more, you need to cancel a timer programme already set. (☞ pg. 59)
CAN NOT SET DISC TIMER PROGRAMMING WITH THIS DISC PREPARE A FORMATTED DISC AS DESCRIBED BELOW DVD-RAM DVD-RW (VR MODE)	On-Disc Timer Programming has been attempted when a disc that is not compatible with the function is loaded. (☞ pg. 56)
NO DISC INSERTED	On-Disc Timer Programming has been attempted when a disc is not loaded, or loaded upside down. (☞ pg. 9, 56)
DISC NOT RECORDABLE INSERT RECORDABLE DISC	When a playback-only disc or a finalised disc is loaded, ● has been pressed. (☞ pg. 6, 98)
G-CODE/SHOWVIEW NO. ERROR CONFIRM G-CODE/SHOWVIEW NO. THEN RETRY	An invalid G-CODE number has been input. (☞ pg. 52)
GUIDE PROGRAMME IS NOT SET SELECT CHANNEL YOU WANT TO RECORD	To set the timer programme using the G-CODE system, the Guide Program number must be set in advance. (☞ pg. 51)
CAN NOT SET G-CODE/SHOWVIEW TIMER PROGRAMMING DURING TIMER RECORDING OR INSTANT TIMER RECORDING CANCEL TIMER RECORDING OR INSTANT TIMER RECORDING, THEN ENTER THE G-CODE/SHOWVIEW NO. AGAIN	Appears when you tried to input a G-CODE number during timer recording or instant timer recording.
REGION CODE ERROR CHECK DISC	A disc loaded cannot be played back on this unit since the region number of the disc does not match that of the unit. (☞ pg. 1)
UNREADABLE DISC CHECK DISC	When an incompatible disc is loaded, ► has been pressed. (☞ pg. 6)
COULD NOT FORMAT THE DISC CHECK THE DISC	Formatting is not complete since the disc may be dirty or damaged. Take out the disc, clean it and retry. (☞ pg. 9, 97)
COULD NOT FINALISE THE DISC CHECK THE DISC	Finalising is not complete since the disc may be dirty or damaged. Take out the disc, clean it and retry. (☞ pg. 9, 98)
COULD NOT CANCEL DISC FINALISATION CHECK THE DISC	Cancelling disc finalisation is not complete since the disc may be dirty or damaged. Take out the disc, clean it and retry. (☞ pg. 9, 98)

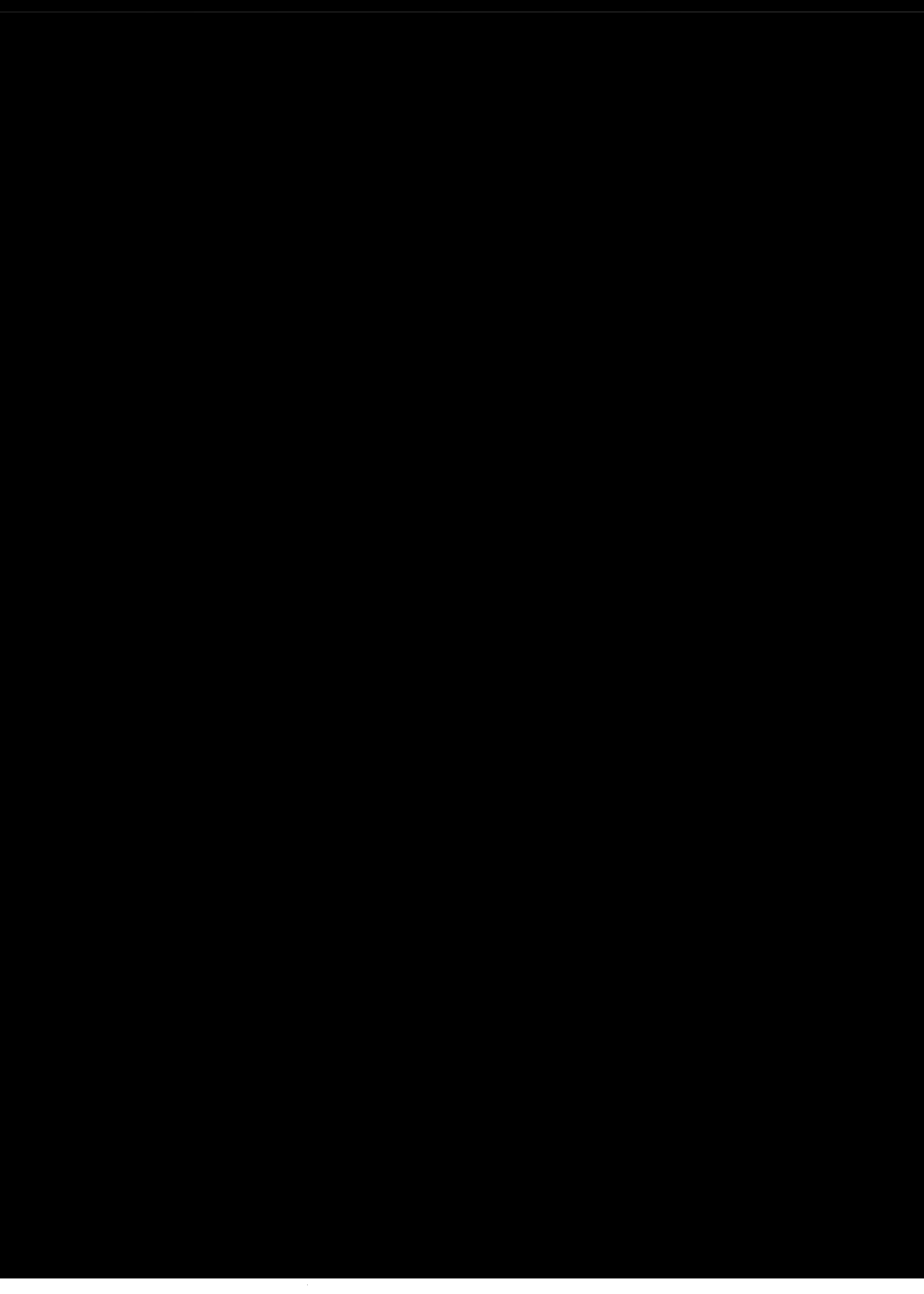

■ Aspect ratio

The ratio of vertical and horizontal sizes of a displayed image. The horizontal vs. vertical ratio of conventional TVs is 4:3, and that of wide-screens is 16:9.

■ Chapter

Refers to individual chapters included in a title.

■ Composite video signal

Refers to video signal comprised of three kinds of signals combined: an image signal made up of luminance and chrominance signals using the frequency multiplication technique; burst signal providing the basis for colour reproduction; and synchronization signal.

■ Component video signal

A video signal system where parts of information necessary for reproducing image signal comprised of the three primary colours of light are transmitted via separate signal lines. Types of signal, such as R/G/B, Y/P_B/P_R, etc., are available.

■ Disc menu

A screen display prepared for allowing selection of images, sounds, subtitles, multiangles, etc. recorded on a DVD disc.

■ Dolby Digital (AC-3)

A six-channel system consisting of left, centre, right, left rear, right rear and LFE (Low-Frequency Effect channel, for use with a sub-woofer) channels. All processing is done in the digital domain.

Not all Dolby Digital discs contain six (5.1) channels of information.

■ Down-mix

Internal stereo mix of multichannel surround audio by a DVD player. The down-mix signals are output from stereo output connectors.

■ DTS

A Digital Surround audio encoding format configured with six (5.1) channels, similar to Dolby Digital. It requires a decoder, either in the player or in an external receiver. DTS stands for Digital Theater Systems.

Not all DTS discs contain six (5.1) channels of information.

■ Interlaced scan

In the conventional video system, a picture is shown on the display monitor in two halves. The Interlaced scan system places lines of the second half of the picture in-between lines of the first half of the picture.

■ JPEG

A still-picture data compression system proposed by the Joint Photographic Expert Group, which features small decrease in image quality in spite of its high compression ratio.

■ Letter box

A method of displaying wide images like movies in the centre of a 4:3 TV screen with no part of the image deleted, by placing black bands on the top and bottom of the screen. This name has resulted from the screen form looking literally like a letter box.

■ Linear PCM (PCM: Pulse Code Modulation)

A system for converting analog sound signal to digital signal for later processing, with no data compression used in conversion.

■ MP3

A file format with a sound data compression system. "MP3" is the abbreviation of Motion Picture Experts Group 1 (or MPEG-1) Audio Layer 3. By using MP3 format, one CD-R/RW can contain about 10 times as much data volume as a regular CD can.

■ MPEG

A family of Standards for compressing audio-visual information. "MPEG" standards include MPEG-1, MPEG-2 and MPEG-4. Video CD/SVCD and MP3 are based on MPEG-1, while DVD is based on MPEG-2. MPEG stands for Moving Picture coding Experts Group.

■ Multiangle

By recording multiple scenes progressing at the same time in a single title, the user can select view angles. This feature is called the multiangle function.

■ Multichannel

DVD is specified to have each sound track constitute one sound field. Multichannel refers to a structure of sound tracks having three or more channels.

■ Multilanguage

When a title is created to cope with multiple languages, it is generally called a multilanguage title.

■ NTSC (National television system committee)

A black and white and colour television system format used in the U.S.A., Canada, Mexico and Japan.

■ PAL (Phase Alternation by Line)

A colour television system format used extensively in Western Europe.

■ Parental Lock

A feature of this system to automatically determine whether or not to reproduce particular DVD software by comparing its parental lock level (a measure of undesirability of scenes, etc. from educational viewpoint) set for the software beforehand with that set on this system by the user; if the software's level is less restrictive than the user-set level, it will be reproduced.

■ Playback control (PBC)

Refers to the signal recorded on Video CD/SVCDs for controlling reproduction. By using menu screens recorded on a Video CD/SVCD that supports PBC, you can enjoy interactive-type software as well as software having a search function.

■ Progressive scan

Progressive scan displays all the horizontal lines of a picture at one time, as a single frame. This system can convert the interlaced video from DVD into progressive format for connection to a progressive display. It dramatically increases the vertical resolution.

■ Region Code

A system for allowing discs to be played back only in the regions designated beforehand. All the countries in the world are grouped into six regions, each region being identified by a specified Region Code (or region number). If the Region Code given to a disc includes a numeral which matches one in the Region Code of a player, the player can play back the disc.

■ Sampling frequency

Frequency of sampling data when analog data is converted to digital data. Sampling frequency numerically represents how many times the original analog signal is sampled per second.

■ Surround

A system for creating three-dimensional sound fields full of realism by arranging multiple speakers around the listener.

■ Transfer rate

The rate of transferring digital data. Usually the measure is in baud per second. The DVD system applies a variable transfer rate system for high efficiency.

GENERAL

Power requirement*

DR-M10SAG/SAX : AC 110 V – 240 V \sim ,
50 Hz/60 Hz

DR-M10SAA2 : AC 220 V – 240 V \sim ,
50 Hz/60 Hz

Power consumption

Power on : 33 W

Power off : 17.6 W

Temperature

Operating : 5°C to 40°C

Storage : -20°C to 60°C

Operating position : Horizontal only

Dimensions (WxHxD)

: 435 mm x 70 mm x 350 mm

Weight : 4.3 kg

VIDEO/AUDIO

Recordable disc : DVD-RAM 12 cm (4.7 GB/9.4 GB)
DVD-RAM 8 cm (1.4 GB/2.8 GB)
DVD-R (12 cm: 4.7 GB, 8 cm: 1.4
GB for General Ver. 2.0)
DVD-RW (4.7 GB for Ver. 1.0/1.1)

Recording format

DVD-RAM : DVD Video Recording format

DVD-R : DVD-Video format

DVD-RW : DVD-Video format, DVD Video
Recording format

Recording time

Maximum 8 hours (with 4.7 GB disc)

(XP) : Approx. 1 hour

(SP) : Approx. 2 hours

(LP) : Approx. 4 hours

(EP) : Approx. 6 hours

(FR) : Approx. 1 hour – 8 hours

Playable disc : DVD-RAM 12 cm (4.7 GB/9.4 GB)
DVD-RAM 8 cm (1.4 GB/2.8 GB)
DVD-R (12 cm: 4.7 GB, 8 cm: 1.4
GB for General Ver. 2.0)
DVD VIDEO, DVD-RW (4.7 GB)
Music CD (CD-DA)
Video CD
Super Video CD (SVCD)
CD-R/RW (CD-DA, Video CD/
SVCD formatted discs)

Audio recording system

: Dolby Digital (2 ch)

Linear PCM (XP mode only)

Video recording compression system

: MPEG2 (CBR/VBR)

Input/Output

S-video input

Y : 0.8 – 1.2 Vp-p, 75 ohms

C : 0.2 – 0.4 Vp-p, 75 ohms

S-video output

Y : 1.0 Vp-p, 75 ohms

C : 0.3 Vp-p, 75 ohms

Video input

: 0.5 – 2.0 Vp-p, 75 ohms (pin jack)

Video output

: 1.0 Vp-p, 75 ohms (pin jack)

Audio input

: -8 dB, 50 kilohms (pin jack)

Audio output

: -8 dB, 1 kilohms (pin jack)

i.Link

: 4-pin for DV input

Component video output

Y : 1.0 Vp-p, 75 ohms

PB/PR : 0.7 Vp-p, 75 ohms

Corresponding to copy protection

Optical : -18 dBm, 660 nm

Coaxial : 0.5 Vp-p, 75 ohms

Corresponding to Dolby Digital and
DTS Digital Surround

Bit stream

Selectable in digital audio output
setting menu

TUNER/TIMER

Signal system : PAL-type colour signal and CCIR
monochrome signal, 625 lines 50
fields

TV channel storage capacity

: 99 positions (+AUX position)

Tuning system : Frequency synthesized tuner

Channel coverage

VHF : (low) 42 MHz – 175 MHz/
(high) 175 MHz – 470 MHz

UHF channels : 470 MHz – 870 MHz

Memory backup time

: Approx. 60 min.

ACCESSORIES

Provided accessories

: RF cable,
Audio/video cable,
Infrared remote control unit,
Input Cable Adapter,
Output Cable Adapter,
Conversion Plug
(DR-M10SAG/SAX only)*,
"R6" battery x 2

* The model number depends on the country where you live.
Check the label on the rear of the unit.

Specifications shown are for SP mode unless otherwise
specified.

E.& O.E. Design and specifications subject to change without
notice.

A		R	
A-B Repeat Playback	39	Random Playback	42
Adjusting the picture quality	41	Recordable/playable discs	5
Angle Selection	29	Recording Medium and Format	7
Audio Channel Selection	30	Recording Resume Function	47
Audio Language/Sound Selection	29	RECORDING SET	89
AUDIO OUTPUT	88	Recording Speed	48
Auto Channel Set	92	Region Number	1
C		Register disc	73
Check, cancel and change programmes	59	Repeat Playback	38
D		Resume Function	27
Delete programme	67	S	
Disc menu	26	Scan Mode Set	99
Discs for Playback Only	6	Select the switching interval of the slide show	42
DISPLAY SET	90	Setting the progressive mode	41
DVD menu	26	Simulated Surround Effect	40
F		Skip Search	27
File Structure of Discs	7	Slow Motion	27
Free Rate Function	50	Still Picture/Frame-By-Frame Playback	27
G		Subtitle Selection	29
Guide Program Number	51	T	
H		Time Search	40
High-Speed Search	27	Top menu	26
I		U	
Instant Timer Recording (ITR)	48	Unplayable Discs	6
L			
Letter Box	21		
Library Database DVD Navi	62		
Live Memory	31		
M			
Manual Channel Set	93		
Marking positions to play again later	28		
Menu/Audio/Subtitle Language Set	23		
O			
On-Disc Timer Programming	56		
One Touch Replay	35		
On-screen Language Set	22		
P			
Pan&Scan	21		
Parental Lock	43		
Play List	68		
Play Set Up Menu	36		
Playback Control (PBC)	30		
Programme Playback	42		

JVC

VICTOR COMPANY OF JAPAN, LIMITED

Free Manuals Download Website

<http://myh66.com>

<http://usermanuals.us>

<http://www.somanuals.com>

<http://www.4manuals.cc>

<http://www.manual-lib.com>

<http://www.404manual.com>

<http://www.luxmanual.com>

<http://aubethermostatmanual.com>

Golf course search by state

<http://golfingnear.com>

Email search by domain

<http://emailbydomain.com>

Auto manuals search

<http://auto.somanuals.com>

TV manuals search

<http://tv.somanuals.com>