

# JVC



## DVD PLAYER & VIDEO CASSETTE RECORDER

# HR-XV32E

**FIRST**  
See  
**AUTO SET UP**  
on **PAGE 10**

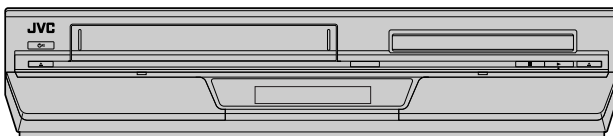

**SHOWVIEW®**

*Hi-Fi* **VHS**  
PAL

**SQPB**

**DVD**  
VIDEO™

**dts**  
DIGITAL OUT

**DOLBY**  
DIGITAL

**COMPACT**  
**disc**  
DIGITAL VIDEO

**COMPACT**  
**disc**  
DIGITAL AUDIO

**COMPACT**  
**disc**  
SUPER VIDEO

**3D**  
3D-PHONIC

## INSTRUCTIONS

LPT0970-001A

**EN**

# Safety Precautions

The rating plate and the safety caution are on the rear of the unit.

**WARNING: DANGEROUS VOLTAGE INSIDE**

**WARNING: TO PREVENT FIRE OR SHOCK HAZARD, DO NOT EXPOSE THIS UNIT TO RAIN OR MOISTURE.**

## CAUTION

- When you are not using the unit for a long period of time, it is recommended that you disconnect the power cord from the mains outlet.
- Dangerous voltage inside. Refer internal servicing to qualified service personnel. To prevent electric shock or fire hazard, remove the power cord from the mains outlet prior to connecting or disconnecting any signal lead or aerial.

## WARNING (VHS deck only)

There are two different types of SECAM colour systems: SECAM-L, used in FRANCE (also called SECAM-West), and SECAM-B, used in Eastern European countries (also called SECAM-East).

1. This unit can also receive SECAM-B colour television signals for recording and playback.
2. Recordings made of SECAM-B television signals produce monochrome pictures if played back on a video recorder of SECAM-L standard, or do not produce normal colour pictures if played back on a PAL video recorder with SECAM-B system incorporated (even if the TV set is SECAM-compatible).
3. SECAM-L prerecorded cassettes or recordings made with a SECAM-L video recorder produce monochrome pictures when played back with this unit.
4. This unit cannot be used for the SECAM-L standard. Use a SECAM-L recorder to record SECAM-L signals.

## IMPORTANT

- Please read the various precautions on pages 2 and 3 before installing or operating the unit.
- It should be noted that it may be unlawful to re-record pre-recorded tapes, DVDs, or discs without the consent of the owner of copyright in the sound or video recording, broadcast or cable programme and in any literary, dramatic, musical, or artistic work embodied therein.

## CAUTION

A DVD/VCR IS A CLASS 1 LASER PRODUCT. HOWEVER THIS DVD/VCR USES A VISIBLE LASER BEAM WHICH COULD CAUSE HAZARDOUS RADIATION EXPOSURE IF DIRECTED. BE SURE TO OPERATE THE UNIT CORRECTLY AS INSTRUCTED.

WHEN THIS DVD/VCR IS PLUGGED INTO THE WALL OUTLET, DO NOT PLACE YOUR EYES CLOSE TO THE OPENING OF THE DISC TRAY AND OTHER OPENINGS TO LOOK INTO THE INSIDE OF THIS DVD/VCR. USE OF CONTROLS OR ADJUSTMENTS OR PERFORMANCE OF PROCEDURES OTHER THAN THOSE SPECIFIED HEREIN MAY RESULT IN HAZARDOUS RADIATION EXPOSURE. DO NOT OPEN COVERS AND DO NOT REPAIR YOURSELF. REFER SERVICING TO QUALIFIED PERSONNEL.

CLASS 1 LASER PRODUCT

REPRODUCTION OF LABELS

WARNING LABEL INSIDE OF THE UNIT

<b>CAUTION:</b> Visible and invisible laser radiation when open and interlock failed or defeated. AVOID DIRECT EXPOSURE TO BEAM.	<b>ADVARSEL:</b> Synlig og usynlig laserstråling når maskinen er åben eller interlocken fejler. Undgå direkte eksponering til stråling.	<b>VARNING :</b> Synlig og osynlig laserstråling når den öppnas och spärren är urkopplad. Betrakta ej strålen.	<b>VARO:</b> Avattaessa ja suojalukitus ohitettuna tai viallisena olet alttina näkyvälle ja näkymättömälle lasersäteilylle. Vältä säteien kohdistumista suoraan itseesi.
	(e)	(d)	(s)

Use only discs marked with the following.



DVD  
(8 cm /12 cm disc)



Video CDs  
(8 cm /12 cm disc)



Audio CDs  
(8 cm /12 cm disc)



Super Video CDs  
(8 cm /12 cm disc)



- Manufactured under license from Dolby Laboratories. "Dolby" and the double-D symbol are trademarks of Dolby Laboratories.
- "DTS" and "DTS Digital Out" are trademarks of Digital Theater Systems, Inc.
- Cassettes marked "VHS" (or "S-VHS") can be used with this video cassette recorder. However, S-VHS recording is not possible with this model.
- This model is equipped with SQPB (S-VHS QUASI PLAYBACK) that makes it possible to play back S-VHS recordings in the SP mode with regular VHS resolution.
- HQ VHS is compatible with existing VHS equipment.
- SHOWVIEW is a registered trademark of Gemstar Development Corporation. The SHOWVIEW system is manufactured under licence from Gemstar Development Corporation.
- This product incorporates copyright protection technology that is protected by method claims of certain U.S. patents and other intellectual property rights owned by Macrovision Corporation and other rights owners. Use of this copyright protection technology must be authorized by Macrovision Corporation, and is intended for home and other limited viewing users only unless otherwise authorized by Macrovision Corporation. Reverse engineering or disassembly is prohibited.

## For Italy:

"It is declared that this product, brand JVC, conforms to the Ministry Decree n. 548 of 28 Aug.'95 published in the Official Gazette of the Italian Republic n. 301 of 28 Dec.'95"

The STANDBY/ON  $\phi$ /I button does not completely shut off mains power from the unit, but switches operating current on and off. " $\phi$ " shows electrical power standby and "I" shows ON.

Video tapes recorded with this unit in the LP (Long Play) mode cannot be played back on a single-speed video recorder. (VHS deck only)

When the equipment is installed in a cabinet or a shelf, make sure that it has sufficient space on all sides to allow for ventilation (10 cm or more on both sides, on top and at the rear.)

When discarding batteries, environmental problems must be considered and the local rules or laws governing the disposal of these batteries must be followed strictly.

LP41077-001A

Failure to heed the following precautions may result in damage to the unit, remote control or video cassette.

1. **DO NOT** place the unit —
  - in an environment prone to extreme temperatures or humidity.
  - in direct sunlight.
  - in a dusty environment.
  - in an environment where strong magnetic fields are generated.
  - on a surface that is unstable or subject to vibration.
2. **DO NOT** block the unit's ventilation openings or holes. (If the ventilation openings or holes are blocked by a newspaper or cloth, etc., the heat may not be able to get out.)
3. **DO NOT** place heavy objects on the unit or remote control.
4. **DO NOT** place anything which might spill on top of the unit or remote control. (If water or liquid is allowed to enter this equipment, fire or electric shock may be caused.)
5. **DO NOT** expose the apparatus to dripping or splashing.
6. **DO NOT** use this equipment in a bathroom or places with water. Also **DO NOT** place any containers filled with water or liquids (such as cosmetics or medicines, flower vases, potted plants, cups, etc.) on top of this unit.
7. **DO NOT** place any naked flame sources, such as lighted candles, on the apparatus.
8. **AVOID** violent shocks to the unit during transport.

#### MOISTURE CONDENSATION

Moisture in the air will condense on the unit when you move it from a cold place to a warm place, or under extremely humid conditions—just as water droplets form on the surface of a glass filled with cold liquid. Moisture condensation on the head drum will cause damage to the tape. In conditions where condensation may occur, keep the unit turned on for a few hours to let the moisture dry.

#### ATTENTION

##### To mobile phone users:

Using a mobile phone in the vicinity of the unit may cause picture vibration on the TV screen or change the screen to a blue back display.

##### On placing the unit:

Some TVs or other appliances generate strong magnetic fields. Do not place such appliances on top of the unit as it may cause picture disturbance.







# Contents

<b>SAFETY FIRST</b>	<b>2</b>
Safety Precautions .....	2
<b>DISC INFORMATION</b>	<b>4</b>
About Discs .....	4
<b>INDEX</b>	<b>6</b>
<b>INSTALLING YOUR NEW UNIT</b>	<b>9</b>
Basic Connections .....	9
<b>INITIAL SETTINGS</b>	<b>10</b>
Auto Set Up .....	10
Preset Download .....	12
Monitor Set (DVD deck) .....	14
Language .....	15
<b>OPERATIONS ON VHS DECK</b>	<b>18</b>
Basic Playback .....	18
Playback Features .....	19
Basic Recording .....	21
Recording Features .....	22
B.E.S.T. Picture System .....	23
SHOWVIEW® Timer Programming .....	24
Express Timer Programming .....	26
Automatic Satellite Programme Recording .....	28
<b>OPERATIONS ON DVD DECK</b>	<b>30</b>
Basic Playback .....	30
Playback Features .....	31
Using the on-screen bar .....	35
Parental Lock .....	44
About MP3 Disc .....	48
MP3 Playback .....	49
About JPEG Disc .....	51
JPEG Playback .....	52
<b>EDITING (VHS DECK)</b>	<b>54</b>
Edit From A Camcorder .....	54
Edit To Or From Another Video Recorder .....	55
Dubbing (from DVD to VHS) .....	56
<b>EDITING (DVD DECK)</b>	<b>57</b>
Digital Audio Dubbing .....	57
<b>REMOTE CONTROL</b>	<b>58</b>
Remote Control Functions .....	58
<b>SYSTEM CONNECTIONS</b>	<b>60</b>
Connecting To A Satellite Receiver .....	60
Connecting/Using A Decoder .....	61
Connecting To A Dolby Digital Decoder or An Amplifier With A Built-in DTS (DVD deck only) .....	61
<b>SUBSIDIARY SETTINGS</b>	<b>62</b>
Mode Set (VHS deck) .....	62
Mode Set (DVD deck) .....	65
Tuner Set .....	68
Video Channel Set .....	73
Clock Set .....	74
Child Lock .....	75
<b>TROUBLESHOOTING</b>	<b>76</b>
<b>SPECIFICATIONS</b>	<b>79</b>
<b>LIST OF TERMS</b>	<b>80</b>

# About Discs

## Playable Discs

You can use discs with the following logos for playback only.

<b>DVD VIDEO</b> 	<b>Video CD/Super Video CD</b>    
<b>Audio CD</b> 	<b>CD-DA files</b>

- The following discs also can be played back.
  - DVD-R/RW discs recorded in DVD VIDEO format and finalized.
  - CD-R/RW discs recorded in Super Video CD, Video CD or Audio CD format and finalized.
  - CD-R/RW discs recorded in MP3 format in accordance with the "ISO 9660" format. (See page 48 for details.)
  - CD-R/RW discs recorded in JPEG format in accordance with the "ISO 9660" format. (See page 51 for details.)
- Discs other than the above cannot be played back.
- Operation and audio quality of this unit are not guaranteed for discs that do not conform to the Compact Disc specification (CD-DA).  
Before you play back a CD, check for the CD logo and read the notes on the package to confirm that it conforms to the Compact Disc specification.
- Depending on the intentions of the author of the software, recording conditions of DVD discs and Video CD discs may be restricted. Since this unit plays back discs according to the intentions of the author of the software as indicated on the disc, some functions may not operate as commanded.
- When switching from the first layer to the second layer of double-layered DVD VIDEO discs, the image and sound may be momentarily distorted. This is not a malfunction.

## Unplayable Discs

The following types of discs cannot be played using this unit. Do not attempt to play back any kind of disc that is damaged (cracked, warped, or repaired with adhesive tape) or discs in unusual shapes (heart-shaped, octagonal, or other forms). If such discs are accidentally played back, it may cause noise that can lead to speaker damage.

- CD-ROM discs (including PHOTO-CD)
- DVD AUDIO discs
- Super Audio CDs (SACD)
- DVD-RW discs recorded in VR format
- DVD-RAM
- Discs which have a region number other than "2"







## Region Number

The world is divided into 6 regions for DVD VIDEO discs. DVD VIDEO discs are assigned a region number to indicate which region they may be played back in. A disc cannot be played back on this unit unless the region number of the disc matches that of the unit. The region number for this unit is "2". Only discs whose region number includes "2" can be played back such as shown below.

Examples of DVD VIDEO labels which can be played back using this unit.









### Marks of discs in this instruction manual

	Allows operation with a DVD VIDEO disc.		Allows operation with a CD-R/RW disc.
	Allows operation with a Video CD disc.		Allows operation with a SVCD disc.
	Allows operation with a disc including MP3 files.		Allows operation with a disc including JPEG files.
	Allows operation with an Audio CD disc.		



## DVD VIDEO Marks

Sometimes marks are printed on a DVD disc and/or on its packaging to indicate information regarding the contents and functions of a disc. Check marks indicating the contents and functions of a disc. Note, however, that in some cases a disc may not include a mark even for a function it supports.

### Marks related to video

	Number of subtitles		Number of angles
	Recorded under the standard 4:3 aspect ratio		Screen includes black bands at top and bottom of image which has a standard 4:3 aspect ratio (letter box)
	Video playback is in Wide video mode (16:9) on wide televisions, but in letter box on televisions with standard 4:3 aspect ratio.		
	Video playback is in Wide video mode (16:9) on wide televisions, but pan and scan is used on televisions with standard 4:3 aspect ratio (either the left or right side of the image is cut-out).		

## Marks related to audio

	Number of audio tracks
	Dolby Digital mark Dolby Laboratories has developed a digital surround system for the home. This mark indicates that you may enjoy 5.1-channel audio (front left and right, center, rear left and right, and a channel for LFE (Low-Frequency Effects)).
	DTS (Digital Theater System) You can enjoy DTS audio if you connect an amplifier with a built-in DTS decoder to the DIGITAL AUDIO OUT connector of the unit.

## File Structure of Discs

### DVD VIDEO

Typically, DVD VIDEO discs are made up of larger units called "titles". Each title has a number (title number) that can be used to select desired titles. Titles are further divided into units called "chapters". Each chapter has a number (chapter number) that can also be used to select desired chapters. Note that some discs are not divided into titles and chapters.

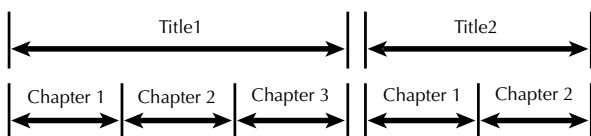

### Audio CD/Video CD

Typically, Audio CD discs are divided into separate tracks each containing one song. Each track is assigned a number. For example, the third track is Track 3. The same is true for Video CD discs.

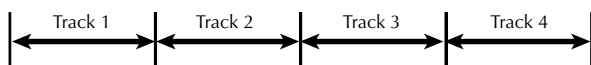

## NOTE:

### Video CD discs that support Playback Control (PBC)

The still image or motion image which follows a menu screen is called a "scene". Each scene has a scene number. For more details, refer to "Locating a desired scene using the menu of a Video CD with PBC" (pg. 31).

## Placing a Disc

### 1 Open the disc tray.

Press  on the DVD deck to open the disc tray.

- Pressing the button again closes the disc tray.
- Do not block the disc tray with your hand while it is opening or closing as this may result in hardware failure.
- Do not place unplayable discs or any object other than a disc in the disc tray.
- Do not press down strongly on the disc tray or place any heavy objects on it.

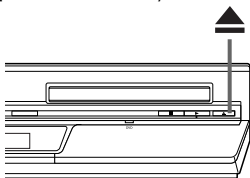

### 2 Place the disc.

Place the disc in the disc tray with the label side facing up.

- Since disc size changes depending on the disc to be played back, be sure to correctly align the disc with the grooves for its size. If the disc is not in its groove, it may be scratched or otherwise damaged.

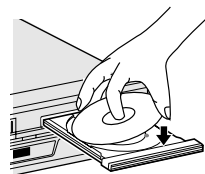

- To insert an 8 cm disc, place it according to the inner groove.

## Care and Handling of Discs

### How to handle discs

When handling a disc, do not touch the surface of the disc.

Since discs are made of plastic, they are easily damaged. If a disc gets dirty, dusty, scratched or warped, the images and sound will not be picked up correctly, and such a disc may cause the unit to malfunction.



### Label side

Do not damage the label side, stick paper to or use any adhesive on its surface.

### Storage

Make sure that discs are kept in their cases. If discs are piled on top of one another without their protective cases, they can be damaged. Do not put discs in a location where they may be exposed to direct sunlight, or in a place where the humidity or temperature is high. Avoid leaving discs in your car!

### Maintenance of discs

If there are fingerprints or other dirt adhering to a disc, wipe with a soft dry cloth, moving from the center outwards.

If a disc is difficult to clean, wipe with a cloth moistened with water. Never use record cleaners, petrol, alcohol or any anti-static agents.



## CAUTION

Sometimes during playback, noise or images may be garbled. This is sometimes due to the disc. (It may not be up to industry standards.)

These symptoms are caused by the discs, not by the malfunction of the unit.

## FRONT VIEW

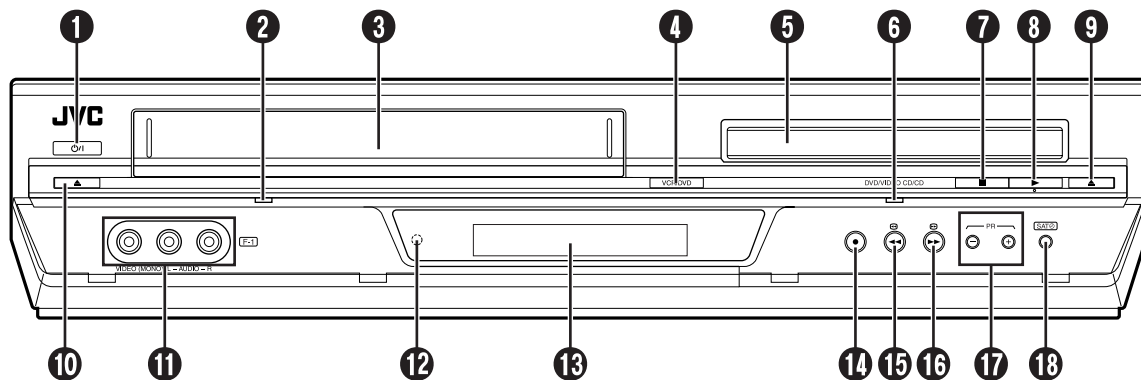

- 1 STANDBY/ON Button (⏻/I) ☞ pg. 10
- 2 VCR Indicator ☞ pg. 18, 21
- 3 Cassette Loading Slot
- 4 VCR/DVD Button ☞ pg. 18, 21, 30
- 5 Disc Tray
- 6 DVD Indicator ☞ pg. 30
- 7 Stop Button (■) ☞ pg. 18, 21, 30
- 8 Play Button (▶) ☞ pg. 18, 30
- 9 DVD Open/Close Button (▲) ☞ pg. 30
- 10 Cassette Eject Button (▲) ☞ pg. 18, 21
- 11 Video/Audio Input Connectors (VIDEO/AUDIO) ☞ pg. 54
- 12 Infrared Beam Receiving Window
- 13 Front Display Panel ☞ pg. 7
- 14 Record Button (●) ☞ pg. 21
- 15 Rewind Button (◀◀) ☞ pg. 18, 19, 32
- 16 Fast Forward Button (▶▶) ☞ pg. 18, 19, 32
- 17 Programme Button (PR +/-) ☞ pg. 21
- 18 Automatic Satellite Programming Button (SATⓈ) ☞ pg. 28

To access covered connectors or buttons, pull and open the cover.

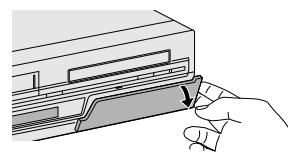

## REAR VIEW

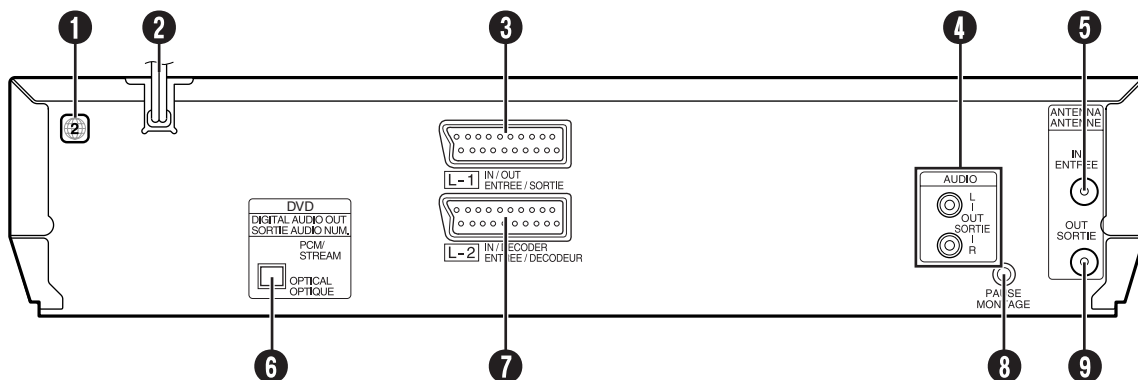

- 1 Region Number Label ☞ pg. 4
- 2 Mains Power Cord ☞ pg. 9
- 3 L-1 Input/Output Connector (L-1 IN/OUT) ☞ pg. 9, 55, 60, 61
- 4 Audio Output Connectors (AUDIO OUT (L/R))
- 5 Antenna Input Connector (ANTENNA IN) ☞ pg. 9
- 6 Digital Audio Output Connector (DIGITAL AUDIO OUT) ☞ pg. 57, 61
- 7 L-2 Input/Decoder Connector (L-2 IN/DECODER) ☞ pg. 55, 60, 61
- 8 Remote Pause Connector (PAUSE) ☞ pg. 54
- 9 Antenna Output Connector (ANTENNA OUT) ☞ pg. 9

## FRONT DISPLAY PANEL

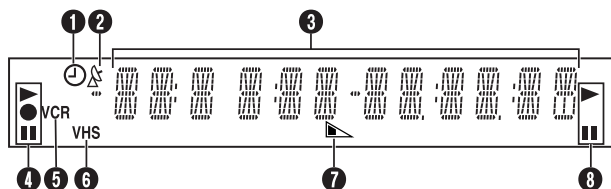

- 1 "Timer" Indicator [↗](#) pg. 25, 26
- 2 Automatic Satellite Programme Recording Indicator (Δ) [↗](#) pg. 28
- 3 Channel/Clock Display  
Mode Display (L-1, L-2, F-1 or SAT\*)  
\* When "L-2 SELECT" is set to "SAT" ([↗](#) pg. 64), "SAT" appears instead of "L-2".  
Counter Display  
Tape Speed (SP/LP) [↗](#) pg. 21  
Multi-information window\*  
\* The current group/title/track/chapter number(s), time and status information.

- 4 VCR Mode Indicator
- 5 VCR Indicator [↗](#) pg. 22
- 6 Cassette Type Indicator
- 7 Tape Remaining Time Indicator [↗](#) pg. 22
- 8 DVD Mode Indicator

## ON-SCREEN DISPLAY (VHS deck)

If you press **--:--** on the remote control when "O.S.D." is set to "ON" ([↗](#) pg. 63), various operational indicators appear on the TV screen.

For On-screen display for DVD deck, refer to "Using the on-screen bar" ([↗](#) pg. 35).

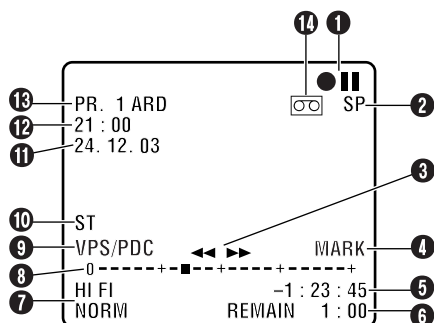

- 1 Operation Mode Indicators
- 2 Tape Speed (SP/LP)
- 3 Tape Direction
- 4 Index Mark Indicator (MARK) [↗](#) pg. 21
- 5 Counter Display
- 6 Tape Remaining Time Indicator [↗](#) pg. 22
- 7 Audio Mode Display [↗](#) pg. 20
- 8 Tape Position Indicator

The tape position indicator appears on the TV screen when you press **◀◀** or **▶▶** from the Stop mode or perform an Index Search. ([↗](#) pg. 19) The position of "■" in relation to "0" (beginning) or "+" (end) shows you where you are on the tape.

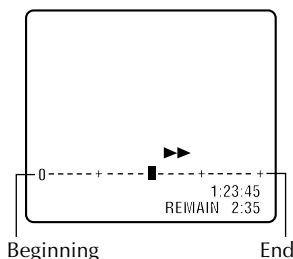

### NOTE:

Depending on the type of tape being used, the tape position indicator may not appear correctly.

- 9 VPS/PDC Indicator [↗](#) pg. 24, 26
- 10 Type of Broadcast [↗](#) pg. 23
- 11 Current Day/Month/Year
- 12 Clock Display
- 13 Channel Position Number and Station Name/Auxiliary Input Indicator (L-1, L-2, F-1 or SAT\*)  
\* When "L-2 SELECT" is set to "SAT" ([↗](#) pg. 64), "SAT" appears instead of "L-2".
- 14 "Cassette Loaded" Mark

## REMOTE CONTROL

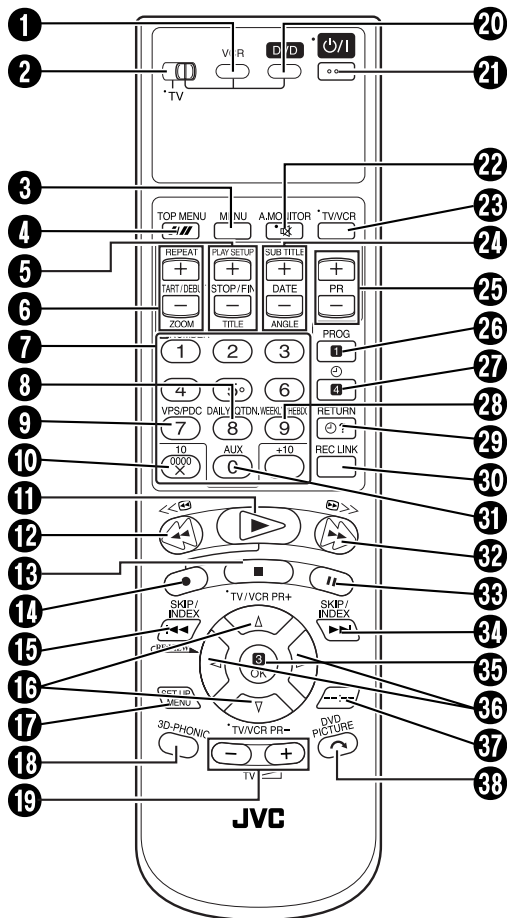

Buttons with a small dot on the left side of the name can also be used to operate your TV. (☞ pg. 59)

### How To Use

The remote control can operate most of your unit's functions, as well as basic functions of TV sets of JVC and other brands. (☞ pg. 59)

- Point the remote control toward the receiving window.
- The maximum operating distance of the remote control is about 8 m.

### NOTES:

- When inserting the batteries, be sure to insert in the correct directions as indicated under the battery cover.
- If the remote control doesn't work properly, remove its batteries, wait a short time, replace the batteries and then try again.

- 1 VCR Button ☞ pg. 18, 21
- 2 TV/VCR/DVD switch ☞ pg. 14
- 3 Menu Button (MENU) ☞ pg. 31
- 4 Auto Tracking Button ☞ pg. 20  
Tape Speed Button (///) ☞ pg. 21  
Top Menu Button (TOP MENU) ☞ pg. 31
- 5 Stop Time Button (STOP +/-) ☞ pg. 26  
Play Set Up Button (PLAY SETUP) ☞ pg. 35  
Title Button (TITLE) ☞ pg. 50, 53
- 6 Start Time Button (START +/-) ☞ pg. 26  
Repeat Button (REPEAT) ☞ pg. 36, 50, 53  
Zooming Button (ZOOM) ☞ pg. 33
- 7 Number Keys ☞ pg. 21, 24, 31, 50, 53
- 8 Daily Button (DAILY) ☞ pg. 25, 27
- 9 VPS/PDC Button ☞ pg. 24, 26
- 10 Reset Button (0000) ☞ pg. 22  
Cancel Button (X) ☞ pg. 27
- 11 Play Button (▶) ☞ pg. 18, 30
- 12 Rewind Button (◀◀) ☞ pg. 18, 19, 32
- 13 Stop Button (■) ☞ pg. 18, 21, 30
- 14 Record Button (●) ☞ pg. 21
- 15 Reverse Skip/Index Button (◀◀) ☞ pg. 19, 31  
Review Button (◀◀VIEW) ☞ pg. 20
- 16 Δ▽ Button ☞ pg. 10  
TV/VCR Programme Button (TV/VCR PR +/-)  
☞ pg. 59
- 17 Set Up Menu Button (SET UP MENU) ☞ pg. 14
- 18 3D-PHONIC Button ☞ pg. 33
- 19 TV Volume Button (TV ◀/▶) ☞ pg. 59
- 20 DVD Button ☞ pg. 30
- 21 STANDBY/ON Button (⏻/⏻) ☞ pg. 10
- 22 TV Muting Button (🔇) ☞ pg. 59  
Audio Monitor Button (A.MONITOR) ☞ pg. 20
- 23 TV/VCR Button ☞ pg. 22
- 24 Date Button (DATE +/-) ☞ pg. 26  
Subtitle Button (SUB TITLE) ☞ pg. 40  
Angle Button (ANGLE) ☞ pg. 41  
\* With this button, you can also adjust the brightness of front display panel and illumination on the unit.  
+ : brightens the display  
- : darkens the display
- 25 Programme Button (PR +/-) ☞ pg. 21
- 26 Programming Button (PROG) ☞ pg. 24, 26
- 27 Timer Button (⌚) ☞ pg. 25, 26
- 28 Weekly Button (WEEKLY) ☞ pg. 25, 27
- 29 Programme Check Button (⊕ ?) ☞ pg. 27  
Return Button (RETURN) ☞ pg. 31
- 30 Automatic Satellite Programming Button (REC LINK)  
☞ pg. 28
- 31 Auxiliary Button (AUX) ☞ pg. 54
- 32 Fast Forward Button (▶▶) ☞ pg. 18, 19, 32
- 33 Pause Button (⏸) ☞ pg. 19, 21, 30
- 34 Forward Skip/Index Button (▶▶) ☞ pg. 19, 31
- 35 OK Button ☞ pg. 11
- 36 ◀ ▶ Button ☞ pg. 14
- 37 Display Button (---) ☞ pg. 22
- 38 Skip Search Button (↻) ☞ pg. 19  
DVD Picture Button (DVD PICTURE) ☞ pg. 34



# Basic Connections

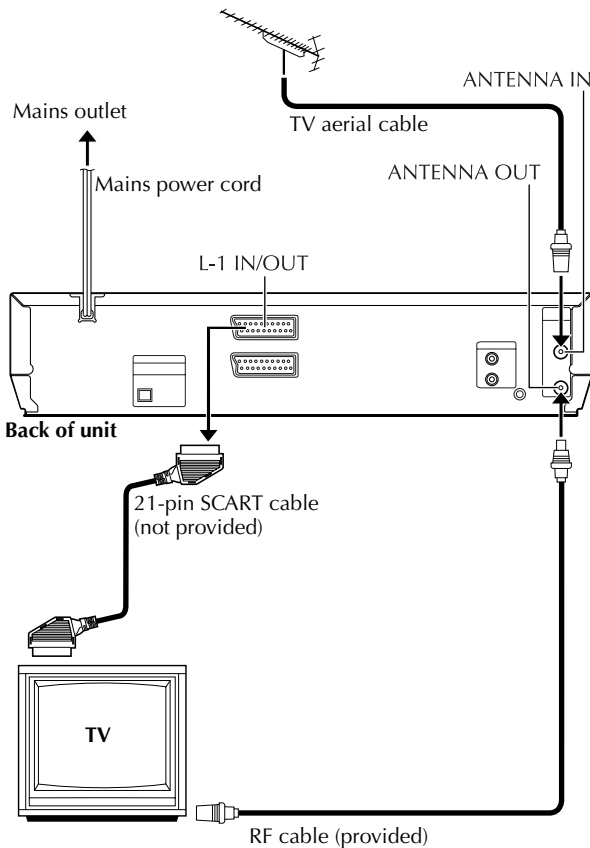

It's essential that your unit be properly connected.

THESE STEPS MUST BE COMPLETED BEFORE ANY VIDEO OPERATION CAN BE PERFORMED.

## 1 Check the contents.

Make sure the package contains all of the accessories listed in "SPECIFICATIONS" on page 79.

## 2 Situate the unit.

Place the unit on a stable, horizontal surface.

## 3 Connect the unit to TV.

The connection method you use depends on the type of TV you have.

### RF Connection

■ To connect to a TV with NO AV input connectors —

- 1 Disconnect the TV aerial cable from the TV.
- 2 Connect the TV aerial cable to the ANTENNA IN connector on the rear panel of the unit.
- 3 Connect the provided RF cable between the ANTENNA OUT connector on the rear panel of the unit and the TV's aerial connector.

### AV Connection

■ To connect to a TV with AV input connectors —

If your TV is equipped with a 21-pin SCART connector, perform AV connection to improve picture quality during tape playback.

- 1 Connect the aerial, unit and TV as per "RF Connection".
- 2 Connect an optional 21-pin SCART cable between the L-1 IN/OUT connector on the rear panel of the unit and the TV's 21-pin SCART connector.

## 4 Connect the unit to mains.

Plug the end of the mains power cord into a mains outlet.

After the connection is completed, perform "Auto Set Up" on page 10.

# Auto Set Up



## Auto Channel Set/Auto Clock Set/ Auto Guide Program Number Set

After the  $\psi/1$  button on the unit or remote control is pressed for the first time to power on the unit, by simply selecting your country\*, the Auto Set Up function sets the tuner channels, clock\*\* and Guide Program numbers automatically.

\* If you live in Belgium (BELGIUM) or Switzerland (SUISSE), you also need to select your language.

\*\* If you live in Hungary (MAGYARORSZÁG), Czech Republic (ČESKÁ REPUBLIKA), Poland (POLSKA) or other countries in Eastern Europe (OTHER EASTERN EUROPE), set the clock manually.

### Before starting, make sure of the following:

- The TV aerial cable should be connected to the unit.
- The unit's mains power cord should be connected to a mains outlet.
- The TV should be set to its AV mode (with AV connection  pg. 9) or UHF channel 36 (with RF connection  pg. 9).
- Slide the TV/VCR/DVD switch to the right.

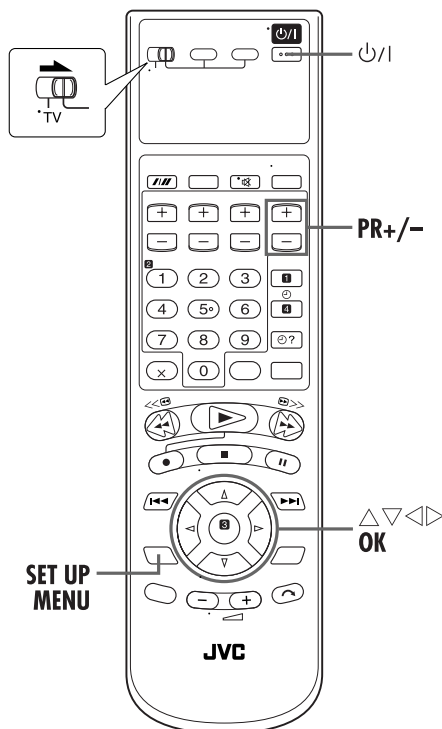

## 1 Turn on the unit.

Press  $\psi/1$  on the unit or remote control. The Country Set display appears on the TV screen.

### NOTE:

If you have connected your TV to the unit with RF connection and the on-screen display appearing on UHF channel 36 looks distorted, perform "Video Channel Set" on page 73.



## 2 Select your country.

Press  $\triangle/\nabla$  to move the highlight bar (pointer) to your country's name.

(Example) DEUTSCHLAND is selected.



### NOTES:

- If you have selected BELGIUM or SUISSE, go to step 3.
- If you have selected MAGYARORSZÁG, ČESKÁ REPUBLIKA, POLSKA or OTHER EASTERN EUROPE, press **OK**. The Clock Set screen appears. Set the clock manually ( pg. 74), then go to step 4.
- If you have selected any other country name, go to step 4.

## 3 Select the language.

Press **OK**. The Language Set display appears on the TV screen.

Press  $\triangle/\nabla$  to move the highlight bar (pointer) to the language of your choice.

(Example) DEUTSCH is selected.



### NOTE:

The selected language is only available on the screen for VHS deck.

Set manually the on-screen language for the DVD deck. ( pg. 16)

## 4 Perform Auto Set Up.

Press **OK**. The AUTO SET/T-V LINK display appears on the front display panel and/or on the TV screen.

### On the front display panel

Press  $\triangle \nabla$  to select "AUTO" and press **OK** or  $\triangleright$ .



### On the on-screen display

Press  $\triangle \nabla$  to move the highlight bar (pointer) to "AUTO SET" and press **OK** or  $\triangleright$ .

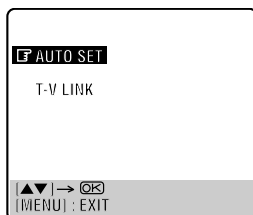

While Auto Set Up is in progress, do NOT press any button on the unit or remote control until the front display panel shows either the display as illustrated in step 5 or "----" as illustrated on page 13.

- If you are using the on-screen display, the AUTO SET screen will appear. As Auto Set Up progresses, the "█" mark on the TV screen moves from left to right.

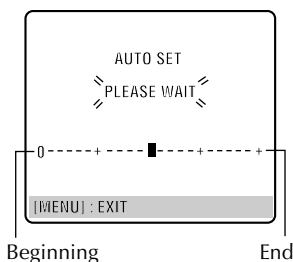

- When you have connected the unit to a TV offering T-V Link via a fully-wired 21-pin SCART cable (pg. 9) and the TV is turned on, the unit automatically performs the Preset Download (pg. 12) even if you select "AUTO" or "AUTO SET" for Auto Set Up function.

## 5 Confirm/Set video channel.

### With RF Connection

The video channel that is shown on the display panel is your video channel. Press **OK**.

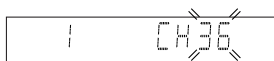

- If you have selected MAGYARORSZÁG, ČESKÁ REPUBLIKA, POLSKA or OTHER EASTERN EUROPE in step 2 on page 10, "2" appears instead of "1".

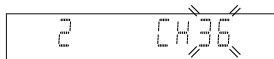

- To view picture signals from the unit, set your TV to the video channel.

### With AV Connection

Press **PR** – until the display panel shows "1 CH --" (or "2 CH --"). Now the video channel is set to off. Then press **OK**.

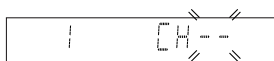

- To view picture signals from the unit, set your TV to its AV mode.

## ATTENTION

Once you have performed Auto Set Up, even if the unit's memory backup has expired, all the stored stations and their Guide Program numbers remain in the unit's memory and the unit will not perform Auto Set Up again. The unit performs only Auto Clock Set when the unit is turned on. If you have moved to a different area, perform each setting as required.

- Video channel setting (for RF connection users) (pg. 73)
- Tuner setting (pg. 68)
- Clock setting (pg. 74)

If a new station starts broadcasting in your area, perform tuner setting (pg. 68) and, if necessary, video channel setting (pg. 73).

## NOTES:

- In areas where no TV station transmits a PDC (Programme Delivery Control) signal, the unit can perform neither Auto Clock Set nor Auto Guide Program Number Set.
- If there is a power cut, or if you press  $\phi/1$  or **SET UP MENU** while Auto Set Up is in progress, Auto Set Up will be interrupted; be sure to turn off the unit power once and try again from step 1.
- Auto Clock Set may not function properly depending on the reception condition.
- If no sound accompanies the picture or the audio sounds unnatural on some channels that have been stored by Auto Set Up, the TV system setting for those channels may be incorrect. Select the appropriate TV system for those channels. (pg. 70, "INFORMATION")

After "Auto Set Up" is completed, perform "Monitor Set (DVD deck)" on page 14.

# Preset Download

## Auto Channel Set by Downloading from TV/Auto Clock Set/Auto Guide Program Number Set

If you have connected the unit to your TV via the AV connection (☞ pg. 9), the unit will automatically perform Preset Download instead of the Auto Set Up in step 4 on page 11. After downloading, the unit sets the clock and Guide Program numbers automatically.

### ATTENTION

You can use this function only with a TV offering T-V Link, etc.\* Be sure to use a fully-wired 21-pin SCART cable.  
\* Compatible with TVs offering T-V Link, EasyLink, Megaloc, SMARTLINK, Q-Link or DATA LOGIC via fully-wired 21-pin SCART cable. The degree of compatibility and available functions may differ by system.

- Slide the TV/VCR/DVD switch to the right.
- Perform steps 1 to 3 of "Auto Set Up" on page 10 before continuing.

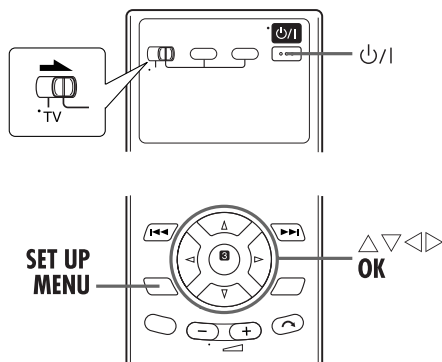

### NOTES:

- For details, refer to the instruction manual of your TV.
- In areas where no TV station transmits a PDC (Programme Delivery Control) signal, the unit can perform neither Auto Clock Set nor Auto Guide Program Number Set.
- If there is a power cut, or if you press  $\text{P}/\text{I}$  or SET UP MENU while downloading or set up is in progress, it will be interrupted; be sure to turn off the unit power once and try again from the beginning.
- Auto Clock Set may not function properly depending on the reception condition.
- On this unit, the characters available for station names (ID) are A-Z, 0-9, -, \*, + and \_ (space). Some names of downloaded stations may differ from those of your TV. (☞ pg. 71)

## 1 Perform Preset Download.

Press **OK**. The AUTO SET/T-V LINK display appears on the front display panel and/or on the TV screen.

### On the front display panel

Press  $\Delta/\nabla$  to select "CH --" and press **OK** or  $\triangleright$ .

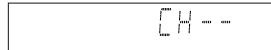

### On the on-screen display

Press  $\Delta/\nabla$  to move the highlight bar (pointer) to "T-V LINK" and press **OK** or  $\triangleright$ .

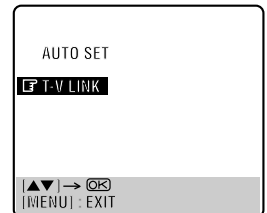

Preset positions on the front display panel increase from "CH 1"; do NOT press any button on the unit or remote control until the front display panel shows clock time, "(CH) 1" or "--:--" as illustrated on page 13.

- If you are using the on-screen display, the T-V LINK screen will appear. Then the GUIDE PROG SET screen will appear during Guide Program Number Set. When Preset Download is completed, "COMPLETED" appears for about 5 seconds, then the normal screen appears.
- If you press any button on the unit or remote control while downloading is in progress, it will be interrupted.

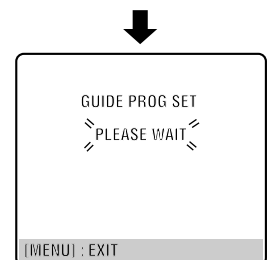
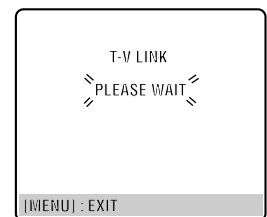

## 2 Set the video channel.

Set the video channel to off manually. (☞ pg. 73)

After "Preset Download" is completed, perform "Monitor Set (DVD deck)" on page 14.

## Results of Auto Set Up/Preset Download appear on the front display panel

**A**  **If both Auto Channel Set and Auto Clock Set have been performed successfully, the correct current time**

is displayed.

Turn on the TV and select its video channel or AV mode, then make sure that all necessary stations have been stored in the unit's memory by using the **PR** button(s).

- If station names (ID –  pg. 72) have also been stored in the unit's memory, the station name will be displayed at the top left corner of the TV screen for about 5 seconds when the unit is tuned to a different station.
- If you want to set the tuner manually such as to add or skip channels, to change channel positions, or to set or change station names, see pages 69 – 72.

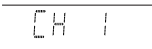

**B**  **If Auto Channel Set has succeeded but Auto Clock Set has not, "CH 1" (channel position) is displayed.**

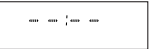
- 1 Turn on the TV and select its video channel or AV mode, then make sure that all necessary stations have been stored in the unit's memory by using the **PR** button(s).
  - If station names (ID –  pg. 72) have also been stored in the unit's memory, the station name will be displayed at the top left corner of the TV screen for about 5 seconds when the unit is tuned to a different station.
  - If you want to set the tuner manually such as to add or skip channels, to change channel positions, or to set or change station names, see pages 69 – 72.
- 2 Perform "Clock Set" on page 74.

**C**  **If both Auto Channel Set and Auto Clock Set have failed, "-:-:-" is displayed.**

Make sure the cables are connected properly and turn off the unit's power once, then turn the unit's power back on again. The Country Set display appears on the TV screen; perform "Auto Set Up" on page 10 or "Preset Download" on page 12 again.

## IMPORTANT

- To check if the Guide Program numbers have been set correctly, perform the SHOWVIEW Timer Programming. ( pg. 24) (VHS deck only)
- In certain reception conditions, station names may not be stored correctly, and auto Guide Program Number Set may not work properly. If the Guide Program numbers are not set properly when you timer-record a TV programme using the SHOWVIEW system, the unit will record a TV programme of a different station. When programming the timer using the SHOWVIEW system, be sure to check the desired channel is selected correctly. ( pg. 24, "SHOWVIEW" Timer Programming") (VHS deck only)
- Your unit memorizes all detected stations even if reception of some of them is poor. You can delete those stations with an unacceptable picture. ( pg. 70, "Delete A Channel")

## INFORMATION

### Language for the on-screen display (VHS deck)

Auto Set Up also selects the language automatically for the on-screen display depending on the Country setting you have made in step **2** on page 10 (unless you have selected BELGIUM or SUISSE), as shown below.

SUOMI	→ SUOMI	ITALIA	→ ITALIANO
PORTUGAL	→ ENGLISH	MAGYARORSZÁG	→ MAGYAR
DEUTSCHLAND	→ DEUTSCH	ESPAÑA	→ CASTELLANO
POLSKA	→ POLSKI	NEDERLAND	→ NEDERLANDS
NORGE	→ NORSK	GREECE	→ ENGLISH
SVERIGE	→ SVENSKA	OTHER WESTERN	→ ENGLISH
DANMARK	→ DANSK	EUROPE	
ÖSTERREICH	→ DEUTSCH	OTHER EASTERN	→ ENGLISH
ČESKÁ	→ ČESTINA	EUROPE	
REPUBLIKA			

If you want to change the language setting manually, see "On-screen Language Set (VHS deck)" on page 15.

### Language for the on-screen display (DVD deck)

Set manually the on-screen language for the DVD deck.

( pg. 16)

### Just Clock

Your unit is equipped with the Just Clock function which provides accurate time keeping through automatic adjustments at regular intervals, by reading data from a PDC signal. If you want to take advantage of this function, simply set it to "ON". ( pg. 75, "Just Clock")

## T-V Link Functions

When you connect the unit to your TV via a fully-wired 21-pin SCART cable ( pg. 9), the following functions are available. You can use these functions only with a TV offering T-V Link, etc.\*

For details, refer to the instruction manual of your TV.

\* *Compatible with TVs offering T-V Link, EasyLink, Megalogic, SMARTLINK, Q-Link or DATA LOGIC via fully-wired 21-pin SCART cable. The degree of compatibility and available functions may differ by system.*

### TV Auto Power On

The TV will turn on and be set to its AV mode automatically whenever you play a tape.

For details, refer to the instruction manual of your TV.

### Unit Auto Standby

You can use your TV's remote control to turn off the unit.

For details, refer to the instruction manual of your TV.

### Direct Rec (VHS deck only)

You can easily start recording the programme that you are watching on your TV. When you use this function, set "DIRECT REC" to "ON". ( pg. 63)

# Monitor Set (DVD deck)

You can select the monitor type depending on the TV used when you play back DVD VIDEO discs recorded for wide-screen TVs.

- Turn on the TV and select the video channel (or AV mode).
- Slide the TV/VCR/DVD switch to the right.

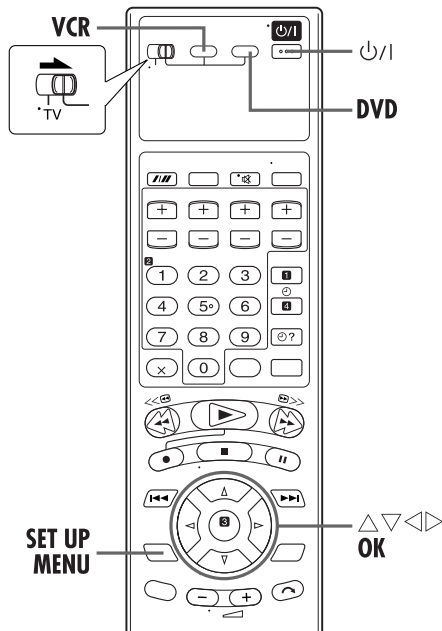

## 1 Turn on the unit.

Press  $\text{P}/\text{I}$ .

## 2 Select the DVD deck.

### On the unit

Press **VCR/DVD** repeatedly so that the DVD indicator lights up.

### On the remote control

Press **DVD** so that the DVD indicator lights up.

## 3 Access the DVD Set Up menu screen.

- 1 Press **SET UP MENU**.
- 2 Press  $\leftarrow \rightarrow$  to select "PICTURE".

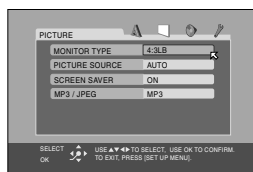

## 4 Select the mode.

Press  $\triangle \nabla$  to move  $\leftarrow \rightarrow$  to "MONITOR TYPE", then press **OK**.

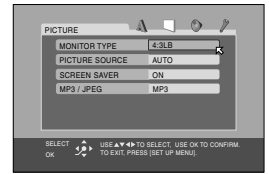

## 5 Select the mode setting.

Press  $\triangle \nabla$  to select the desired setting, then press **OK**.

## 6 Return to the normal screen.

Press **SET UP MENU**.

\* The default setting is **bold** in the table below.

### MONITOR TYPE

#### 16:9 NORMAL (Wide television conversion):

Select this when the aspect ratio of your TV is 16:9 (wide TV).

#### 16:9 AUTO (Wide television conversion):

Select this when the aspect ratio of your TV is fixed to 16:9 (wide TV). The unit automatically adjusts the screen width of the output signal correctly when playing back a picture whose aspect ratio is 4:3.

#### 4:3 LB (Letter Box conversion):

Select this when the aspect ratio of your TV is 4:3 (conventional TV). While viewing a wide screen picture, the black bars appear on the top and the bottom of the screen.

#### 4:3 PS (Pan&Scan):

Select this when the aspect ratio of your TV is 4:3 (conventional TV). While viewing a wide screen picture, the black bars do not appear; however, the left and right edges of the pictures will not be shown on the screen.

### Pan&Scan/Letter Box

In general, DVD VIDEO disc are produced for a wide-screen TV with 16:9 aspect ratio.

Material with this ratio will not fit to a TV with 4:3 aspect ratio. There are two styles to display the image, "Pan&Scan" and "Letter Box".

#### Pan&Scan

The right and left side of the image are cut off. The image fills the screen.

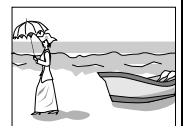

#### Letter Box

Black bands appear at the top and bottom of the image. The image itself appears in 16:9 aspect ratio.



# Language

- Turn on the TV and select the video channel (or AV mode).
- Slide the **TV/VCR/DVD** switch to the right.

## On-screen Language Set (VHS deck)

This VHS deck offers you the choice to view on-screen messages in 13 different languages. Though Auto Set Up selects the language automatically (pg. 13), you can change the language setting manually as required.

### 1 Turn on the unit.

Press **⏻/I**.

### 2 Select the VHS deck.

#### On the unit

Press **VCR/DVD** repeatedly so that the VCR indicator lights up.

#### On the remote control

Press **VCR** so that the VCR indicator lights up.

### 3 Access the Country Set screen.

- 1 Press **SET UP MENU**.
- 2 Press **△▽** to move the highlight bar (pointer) to "AUTO CH SET", then press **OK** or **▷**.



### 4 Select your country.

Press **△▽** to move the highlight bar (pointer) to your country's name, then press **OK** or **▷**.

### 5 Select the language.

Press **△▽** to move the highlight bar (pointer) to the language of your choice.

- You do not have to press **OK**; pressing **OK** enters AUTO SET/T-V LINK screen.



### 6 Return to the normal screen.

Press **SET UP MENU**.

## On-screen Language Set (DVD deck)

This DVD deck offers you the choice to view on-screen messages in 3 different languages. You can change the language setting manually as required.

### 1 Turn on the unit.

Press  $\phi$ /I.

### 2 Select the DVD deck.

#### On the unit

Press **VCR/DVD** repeatedly so that the DVD indicator lights up.

#### On the remote control

Press **DVD** so that the DVD indicator lights up.

### 3 Access the DVD Set Up menu screen.

1 Press **SET UP MENU**.

2 Press  $\triangleleft \triangleright$  to select "LANGUAGE".

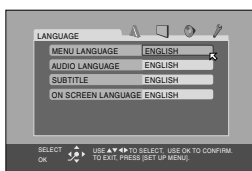

### 4 Select the mode.

Press  $\triangle \nabla$  to move  $\boxtimes$  to "ON SCREEN LANGUAGE", then press **OK**.

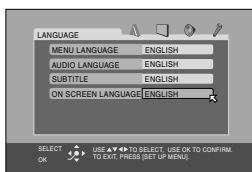

### 5 Select the mode setting.

Press  $\triangle \nabla$  to select the desired setting, then press **OK**.

### 6 Return to the normal screen.

Press **SET UP MENU**.

## Menu/Audio/Subtitle Language Set (DVD deck only)

Some DVD discs contain the DVD menu display, audio, subtitle in multiple languages. With these discs, you can set the default language as you like.

- The procedure shows how to set "MENU LANGUAGE" on the DVD menu screen as an example.

### 1 Turn on the unit.

Press  $\phi$ /I.

### 2 Select the DVD deck.

#### On the unit

Press **VCR/DVD** repeatedly so that the DVD indicator lights up.

#### On the remote control

Press **DVD** so that the DVD indicator lights up.

### 3 Access the DVD Set Up menu screen.

1 Press **SET UP MENU**.

2 Press  $\triangleleft \triangleright$  to select "LANGUAGE".

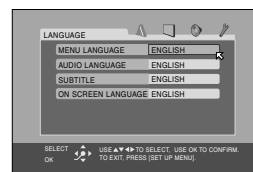

### 4 Select the mode.

Press  $\triangle \nabla$  to move  $\boxtimes$  to "MENU LANGUAGE", then press **OK**.

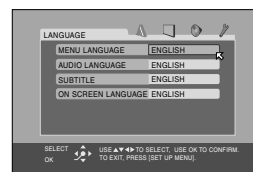

### 5 Select the mode setting.

Press  $\triangle \nabla$  to select the desired setting, then press **OK**.

- See "Language Code List" (☞ pg. 17).

### 6 Return to the normal screen.

Press **SET UP MENU**.

## NOTE:

When the selected language is not available on the disc, the disc's default menu language is played back.



## Language Code List

AA	Afar	IK	Inupiak	RN	Kirundi
AB	Abkhazian	IN	Indonesian	RO	Rumanian
AF	Afrikaans	IS	Icelandic	RU	Russian
AM	Ameharic	IW	Hebrew	RW	Kinyarwanda
AR	Arabic	JI	Yiddish	SA	Sanskrit
AS	Assamese	JW	Javanese	SD	Sindhi
AY	Aymara	KA	Georgian	SG	Sangho
AZ	Azerbaijani	KK	Kazakh	SH	Serbo-Croatian
BA	Bashkir	KL	Greenlandic	SI	Singhalese
BE	Byelorussian	KM	Cambodian	SK	Slovak
BG	Bulgarian	KN	Kannada	SL	Slovenian
BH	Bihari	KO	Korean (KOR)	SM	Samoaian
BI	Bislama	KS	Kashmiri	SN	Shona
BN	Bengali, Bangla	KU	Kurdish	SO	Somali
BO	Tibetan	KY	Kirghiz	SQ	Albanian
BR	Breton	LA	Latin	SR	Serbian
CA	Catalan	LN	Lingala	SS	Siswati
CO	Corsican	LO	Laothian	ST	Sesotho
CS	Czech	LT	Lithuanian	SU	Sundanese
CY	Welsh	LV	Latvian, Lettish	SV	Swedish
DA	Danish	MG	Malagasy	SW	Swahili
DZ	Bhutani	MI	Maori	TA	Tamil
EL	Greek	MK	Macedonian	TE	Telugu
EO	Esperanto	ML	Malayalam	TG	Tajik
ET	Estonian	MN	Mongolian	TH	Thai
EU	Basque	MO	Moldavian	TI	Tigrinya
FA	Persian	MR	Marathi	TK	Turkmen
FI	Finnish	MS	Malay (MAY)	TL	Tagalog
FJ	Fiji	MT	Maltese	TN	Setswana
FO	Faroese	MY	Burmese	TO	Tonga
FY	Frisian	NA	Nauru	TR	Turkish
GA	Irish	NE	Nepali	TS	Tsonga
GD	Scots Gaelic	NL	Dutch	TT	Tatar
GL	Galician	NO	Norwegian	TW	Twi
GN	Guarani	OC	Occitan	UK	Ukrainian
GU	Gujarati	OM	(Afan) Oromo	UR	Urdu
HA	Hausa	OR	Oriya	UZ	Uzbek
HI	Hindi	PA	Panjabi	VI	Vietnamese
HR	Croatian	PL	Polish	VO	Volapuk
HU	Hungarian	PS	Pashto, Pushto	WO	Wolof
HY	Armenian	PT	Portuguese	XH	Xhosa
IA	Interlingua	QU	Quechua	YO	Yoruba
IE	Interlingue	RM	Rhaeto-Romance	ZU	Zulu



# Playback Features

- Turn on the TV and select the video channel (or AV mode).
- Slide the TV/VCR/DVD switch to the right.

## ATTENTION

In the search, still, slow-motion or frame-by-frame playback mode,

- the picture will be distorted.
- the noise bars will appear.
- there may be a loss of colour.
- you cannot hear the sound.

## Still Picture/Frame-By-Frame Playback

### 1 Pause during playback.

Press **II**.

- If there is vertical jitter, press **PR +/-** on the remote control to correct the picture.

### 2 Activate frame-by-frame playback.

Press **II**.

## Slow Motion

During still picture, press and hold **II** for 2 seconds, then release. Press **II** and release again to return to still picture.

- The speed changes for each direction by pressing **◀◀** and **▶▶** repeatedly.

## NOTE:

During slow motion playback, some noise may appear on the TV screen. Press **PR +** or **-** on the remote control to eliminate the noises.

## Variable Speed Search

During playback, press **▶▶** for forward variable speed search, or **◀◀** for reverse variable speed search.

- The speed changes for each direction by pressing **◀◀** and **▶▶** repeatedly.

When pressing **▶▶**:  $+5x \leftrightarrow +7x$

When pressing **◀◀**:  $-1x \leftrightarrow -5x \leftrightarrow -7x$

(Once **◀◀** is pressed, reverse search starts in  $-1x$  normal playback speed. After this process, each press of **◀◀** changes the search speed between  $-5x$  and  $-7x$ .)

## NOTE:

The search speed changes in the same way for SP and LP mode.

To resume normal playback, press **▶**.

## Skip Search

During playback, press **⏮** 1 to 6 times to skip over unwanted sections.

Each press initiates a 30-second period of fast-motion playback. Normal playback resumes automatically.

To resume normal playback during a Skip Search, press **▶**.

## Index Search

Your unit automatically marks index codes at the beginning of each recording. This function gives you quick access to any one of 9 index codes in either direction.

## NOTE:

Before starting, make sure the unit is in the Stop mode.

### Activate Index Search.

Press **◀◀** or **▶▶**. "**◀◀ 1**" or "**▶▶ 1**" is displayed on the TV screen and search begins in the corresponding direction.

- To access index codes 2 through 9, press **◀◀** or **▶▶** repeatedly until the correct index number is displayed.

#### Example:

To locate the beginning of B from the current position, press **◀◀** twice.

To locate the beginning of D from the current position, press **▶▶** once.

- When the specified index code is located, playback begins automatically.

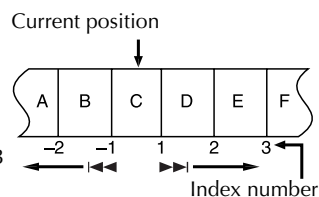

## Next Function Memory

The Next Function Memory "tells" the unit what to do after rewinding. Before continuing, make sure the unit is in the Stop mode.

- For Automatic Start Of Playback  
Press **◀◀**, then press **▶** within 2 seconds.
- For Automatic Power Off  
Press **◀◀**, then press **⏻** within 2 seconds.
- For Automatic Timer Standby  
Press **◀◀**, then press **⌚** within 2 seconds.
- For Automatic Cassette Ejection After Tape Rewind  
Press **◀◀**, then press **⏮** within 2 seconds.

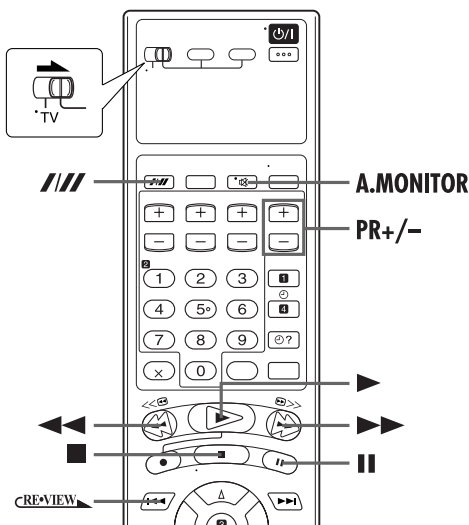

## Instant ReView

Simply by pressing a single button, the unit power comes on, rewinds, and begins playback of the last timer-recorded programme. If you have several programmes recorded, you can easily access any of them.

### NOTE:

Before starting, make sure that the unit is off and that the Timer mode is disengaged.

### Activate Instant ReView.

Press **REVIEW**. The unit power comes on and the unit searches for the index code indicating the start of the last timer-recorded programme. Once it's found, playback begins automatically.

- To watch the first of the 3 programmes, press **REVIEW** three times. The unit searches and begins playback automatically. You can access a programme as far as 9 index codes away from the current tape position.

## Repeat Playback

Your unit can automatically play back the whole tape 100 times repeatedly.

### 1 Start playback.

Press **▶**.

### 2 Activate Repeat Playback.

Press **▶** and hold for over 5 seconds, then release.

- The Play indicator (▶) on the front display panel blinks slowly.
- After playing back a tape 100 times, the unit stops automatically.

### 3 Stop Repeat Playback.

Press **■** at any time.

- Pressing **▶**, **◀**, **▶▶** or **■** also stops Repeat Playback.

## Manual Tracking

Your unit is equipped with automatic tracking control. During playback, you can override this and adjust the tracking manually by pressing the **PR** buttons.

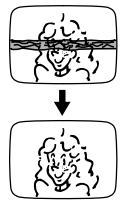

### 1 Override automatic tracking.

During playback, press **///** on the remote control.

### 2 Adjust the tracking manually.

Press **PR +** or **-** on the remote control.

- Press **///** again to return to automatic tracking.

### NOTE:

When a new tape is inserted, the unit enters the automatic tracking mode automatically.

## Soundtrack Selection

Your unit is capable of recording three soundtracks (HI-FI L, HI-FI R and NORM) and will play back the one you select.

### During Playback

Pressing **A.MONITOR** changes the soundtrack as follows:

TRACK	USE
<b>On-Screen Display</b>	
HI FI L ▶ ◀ R	For Hi-Fi stereo tapes
HI FI L ▶	For main audio of Bilingual tapes
HI FI ◀ R	For sub audio of Bilingual tapes
NORM	For audio-dubbed tapes
HI FI NORM	For audio-dubbed tapes

### NOTES:

- "HI-FI L ▶ ◀ R" should normally be selected. In this mode, Hi-Fi stereo tapes are played back in stereo, and the normal audio track is played back automatically for tapes with only normal audio.
- For instructions on recording stereo and bilingual programmes, refer to page 23.
- "O.S.D." must be set to "ON" or the on-screen displays will not appear. (ⓘ pg. 63)

# Basic Recording

- Turn on the TV and select the video channel (or AV mode).
- Slide the TV/VCR/DVD switch to the right.

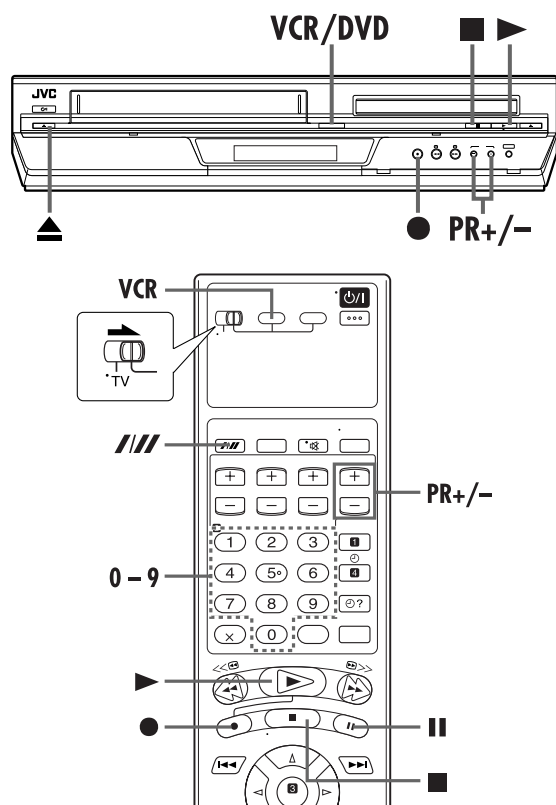

## 1 Load a cassette.

Insert a cassette with the record safety tab intact.

- The unit's power comes on automatically and the counter is reset to 0:00:00.

## 2 Select the VHS deck.

### On the unit

Press **VCR/DVD** repeatedly so that the VCR indicator lights up.

### On the remote control

Press **VCR** so that the VCR indicator lights up.

## 3 Choose a programme.

Press **PR +/-** or the **number keys** to select the channel you wish to record.

## 4 Set the tape speed.

Press **///**. The current setting appears on the front display panel or TV screen. Press **///** again to change the setting while the tape speed is displayed on the TV screen.

## 5 Start recording.

Press and hold **●** and press **▶** on the remote control, or press **●** on the unit.

- If "O.S.D." is set to "ON" (☞ pg. 63), "MARK" blinks on the screen while an index code is being marked.
- When "DIRECT REC" is set to "ON" (☞ pg. 63), if you press any button just after pressing **●** on the unit (or **●** and **▶** on the remote control), the unit may not function properly.

B.E.S.T. takes place at the beginning of both the first SP and the first LP recording after inserting the cassette. (☞ pg. 23)

If "DIRECT REC" is set to "ON", the programme that appears on the TV screen will be recorded. (☞ pg. 63)

## 6 Pause/Resume recording.

Press **||**. Press **▶** to resume recording.

- You can select channel during the Record Pause mode.

## 7 Stop recording.

Press **■**. Then press **▲** on the VHS deck to remove the cassette.

### Recording Resume Function

If there is a power outage during recording, Instant Timer Recording or timer recording (☞ pg. 21, 22, 26), the recording will resume automatically when power is restored to the unit unless the unit's memory backup has expired.

### Accidental erasure prevention

To prevent accidental recording on a recorded cassette, remove its safety tab. To record on it later, cover the hole with adhesive tape.

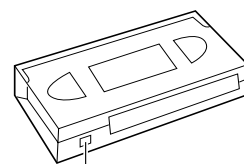

Record safety tab

# Recording Features

- Turn on the TV and select the video channel (or AV mode).
- Slide the TV/VCR/DVD switch to the right.

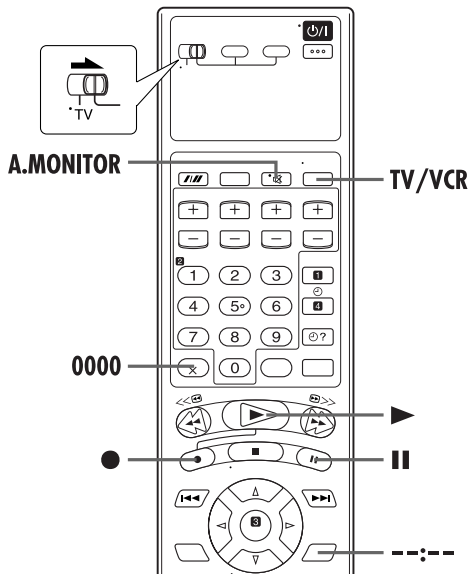

## Record One Programme While Watching Another

If your unit is connected to the TV via the AV connection, press **TV/VCR**. The unit's VCR indicator and the TV broadcast being recorded disappear. Once recording is in progress, all you need to do is to set the channel controls on the TV for the station you wish to view.

- The programme selected with the TV's channel controls appears on the TV screen, while the one selected with the unit's **PR** buttons is recorded on the tape.
- If a decoder is connected to the unit (pg. 61), you can select a scrambled channel as well with the TV channel controls.

### NOTE:

You can also use the DVD deck in the following cases. Before use, be sure to turn on the unit and select the DVD deck.

- During recording
- During timer recording
- During timer standby mode

## Instant Timer Recording (ITR)

This easy method lets you record for from 30 minutes to 6 hours (selectable in 30-min. increments), and shuts the unit off after recording is finished.

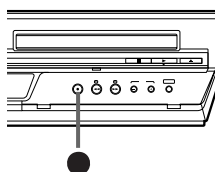

### 1 Start recording.

Press ● on the unit.

### 2 Engage the ITR mode.

Press ● again. "○" blinks and "0:30" appears on the front display panel.

### 3 Set the recording duration.

If you want to record for more than 30 minutes, press ● to extend the time. Each press extends recording time by 30 minutes.

### NOTES:

- You can only perform ITR using the ● button on the unit's front panel.
- Still picture playback stops automatically after 5 minutes to protect the heads.
- When the end of the tape is reached during timer recording, the unit stops and "○" and "▷" blink on the front display panel.
- When the end of the tape is reached during timer recording or Instant Timer Recording, the unit is turned off and "○" and "▷" blink on the front display panel.
- During Instant Timer Recording, any other timer programmed recording won't start even if their start time has come. In such a case, the timer programmed recording starts (if the end time of the timer programmed recording is set after the end of Instant Timer Recording) after the Instant Timer Recording finishes.

## Elapsed Recording Time Indication

### 1 Set the counter display.

Press --:-- until a counter reading appears on the front display panel.



### 2 Reset the counter.

Press **0000** before starting recording or playback.

- The counter is reset to "0:00:00" and shows the exact elapsed time as the tape runs. You can check the exact time of a recording or playback.

## Tape Remaining Time

Press --:-- until the time remaining on the tape appears.

- The front display panel shows the tape remaining time with "▶" displayed.



- By pressing the --:-- button, you can change the display to show the clock time, counter reading or tape remaining time.

### NOTES:



- When you press --:--, the on-screen display appears on the TV screen for 5 seconds, then the displays other than the counter disappears. To clear the counter display, press --:--.
- Depending on the type of tape being used, the tape remaining time reading may not appear right away, or is not correct. "--:--" may sometimes appear, or the display may blink on occasion.

## Receiving Stereo and Bilingual Programmes

Your unit is equipped with a Sound-Multiplex decoder (A2) and a Digital stereo sound decoder (NICAM) making reception of stereo and bilingual broadcasts possible.

When the channel is changed, the type of broadcast being received will be displayed on the TV screen for a few seconds.

Type of Broadcast Being Received	On-screen Display
A2 Stereo	ST
A2 Bilingual	BIL.
Regular Monaural	(none)
NICAM Stereo	ST NICAM
NICAM Bilingual	BIL. NICAM
NICAM Monaural	NICAM

- To listen to a stereo programme, press **A.MONITOR** until "HIFI L  R" appears on the TV screen.
- To listen to a bilingual programme, press **A.MONITOR** until "HIFI L  R" or "HIFI  R" appears on the TV screen.
- To listen to the standard (Regular Monaural) audio while receiving a NICAM broadcast, press **A.MONITOR** until "NORM" appears on the TV screen.

### NOTE:

"O.S.D." must be set to "ON", or the on-screen displays will not appear. (☞ pg. 63)

#### To Record Stereo and Bilingual Programmes (A2)

Stereo programmes are automatically recorded in stereo on the Hi-Fi audio track (with the normal audio track recording mixed L and R channel sound).

- Bilingual programmes are automatically recorded in bilingual on the Hi-Fi audio track. The main soundtrack will be recorded on the normal audio track.

#### To Record NICAM Stereo and Bilingual Programmes

The NICAM audio programme will be recorded on the Hi-Fi audio track, and the standard audio programme will be recorded on the normal audio track.

### NOTES:

- If the quality of stereo sound being received is poor, the broadcast will be received in monaural with better quality.
- Before playing back a programme recorded in stereo, or a bilingual programme, refer to "Soundtrack Selection" on page 20.

## B.E.S.T. Picture System

The B.E.S.T. (Biconditional Equalised Signal Tracking) system checks the condition of the tape in use during playback and recording, and compensates to provide the highest-possible playback and recording pictures. You can set "B.E.S.T." to "ON" or "OFF" to your preference. (☞ pg. 63)

### Playback

The unit assesses the quality of the tape once you initiate playback.

- The unit adjusts the playback picture quality based on the quality of the tape in use.
- B.E.S.T. is active during automatic tracking. "BEST" appears blinking on the front display panel.
- "BEST" only appears at the beginning of automatic tracking. Even though it doesn't appear after that, the B.E.S.T. function is operative.

### Recording

The unit assesses the quality of the tape once you initiate recording.

- The unit spends approximately 7 seconds assessing the condition of the tape, then begins recording.

### ATTENTION

Since the B.E.S.T. system works before recording actually starts, there is a delay of approximately 7 seconds after ● and ► on the remote control are pressed, or ● on the unit is pressed. To make sure you record the desired scene or programme in its entirety, first perform the following steps:

- 1 Press and hold **II** and press ● to engage the Record Pause mode.
- The unit then automatically checks the condition of the tape and, after approximately 7 seconds, re-enters Record Pause mode.
- 2 Press ► to start recording.

If you want to bypass the B.E.S.T. system and begin recording immediately, set "B.E.S.T." to "OFF". (☞ pg. 63)

# SHOWVIEW® Timer Programming

With the SHOWVIEW system, timer programming is greatly simplified because each TV programme has a corresponding code number which your unit is able to recognize.

## Before performing the SHOWVIEW Timer Programming:

- Make sure that the unit's built-in clock is set properly.
- Insert a cassette with the safety tab in place. The unit will come on automatically.
- Turn on the TV and select the video channel (or AV mode).
- Slide the TV/VCR/DVD switch to the right.

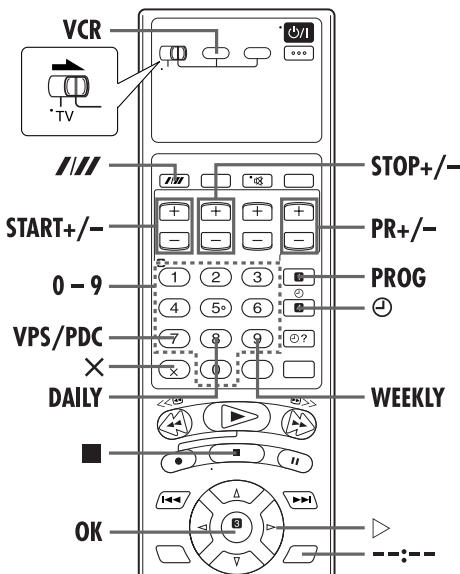

## 1 Select the VHS deck.

### On the unit

Press **VCR/DVD** repeatedly so that the VCR indicator lights up.

### On the remote control

Press **VCR** so that the VCR indicator lights up.

## 2 Access the SHOWVIEW screen.

Press **PROG**.

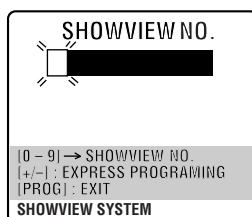

## 3 Enter the SHOWVIEW number.

Press the **number keys** to enter the SHOWVIEW number of a programme you wish to record.

- If you make a mistake, press **X** and input the correct number.

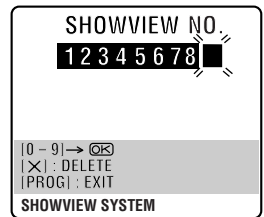

## 4 Access the SHOWVIEW Program screen.

Press **OK**, then the SHOWVIEW Program screen appears (if you're just starting out, "P1" appears).

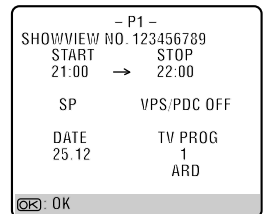

### IMPORTANT

Make sure the channel position number you wish to record is displayed; if not, or "TV PROG" shows "--", press **PR +/-** to input the channel position number on which your unit receives the station, then press **OK** or **▷**.

- If the number you entered is invalid, "ERROR" appears on the TV screen. Press **X** and input a valid SHOWVIEW number.

## 5 Set the tape speed.

Press **///**.

## 6 Set the VPS/PDC mode.

Press **VPS/PDC** (number key "7") to select "ON" or "OFF".

- If "VPS/PDC ON" is displayed on the TV screen, "VPS/PDC" is set to "ON".
  - If "VPS/PDC OFF" is displayed on the TV screen, "VPS/PDC" is set to "OFF".
- ☞ "VPS/PDC Recording" on page 25.



## 7 Return to the normal screen.

Press **PROG** or **OK**. "PROGRAM COMPLETED" appears on the TV screen for about 5 seconds, then the normal screen appears.

- Repeat steps **2** – **7** for each additional programme.

## 8 Engage the unit's timer mode.

Press **⊖**. The unit turns off automatically and "⊖" appears on the front display panel.

- To disengage the timer mode, press **⊖** again.

### NOTES:

- To Change The Stop Time:  
— press **STOP +/-** after pressing **OK** in step **4**. You can compensate for anticipated programme schedule delays.
- To Timer-Record Weekly Or Daily Serials:  
— after pressing **OK** in step **4**, press **WEEKLY** (number key "9") for weekly serials or **DAILY** (number key "8") for daily serials (Monday — Friday). Either "WEEKLY" or "DAILY" appears on the TV screen. Pressing the button again makes the corresponding indication disappear.
- You can programme this unit to timer-record as many as 8 programmes. If you try to programme the unit to record a ninth, "PROGRAM FULL" appears on the TV screen and "FULL" appears on the front display panel. To record the extra programme, you must first cancel any unnecessary programmes. (☞ pg. 27)
- If there is a conflict in the timer schedule and one programme overlaps with another, the programme starting earlier or programme with the lower programme number will be recorded.

### Satellite Receiver Users

To timer-record a satellite broadcast using the SHOWVIEW system:

- 1 Set "L-2 SELECT" to "A/V". (☞ pg. 64)
- 2 Perform steps **1** – **8**.
- 3 Set the satellite receiver to the appropriate channel before the selected programme begins.
- 4 Leave the satellite receiver's power on.

## VPS/PDC Recording

Now available from some TV stations, PDC (Programme Delivery Control) and VPS (Video Programme System) are service designed to assure safe, accurate timer recording. With this system, special code signals are transmitted together with the audio/video signals. These code signals control your unit and have precedence over the advertised times you may have preset into the timer. This means that your unit will start and stop recording when the preset TV programmes actually start and end — even if the broadcast time of a preset TV programme is changed.

### NOTES:

- When you use Express Timer Programming, set the start time (VPS or PDC time) exactly as advertised in the TV listing. A different time than advertised will result in no recording.
- VPS/PDC recording is also possible when a satellite receiver or a cable system is connected to L-2 IN/DECODER connector on your unit.
- VPS/PDC recording is also possible via the L-1 IN/OUT connector.

### How to check if the station being received transmits a VPS/PDC signal

- 1 Press **--:--** until the channel position appears on the front display panel.
- 2 Hold down **START +** for about 5 seconds. "VPS/PDC" appears blinking on the TV screen. If a VPS/PDC signal is detected from the station, "VPS/PDC" will stop blinking. If no VPS/PDC signal is detected from the station, "VPS/PDC" will blink at a slower rate.
- 3 Press **--:--** or **START +** again to return to normal display.

# Express Timer Programming

If you do not know the SHOWVIEW number for the programme you wish to record, use the following procedure to set your unit to timer-record the programme.

## Before performing Express Timer Programming:

- Make sure that the unit's built-in clock is set properly.
- Insert a cassette with the safety tab in place. The unit will come on automatically.
- Turn on the TV and select the video channel (or AV mode).
- Slide the TV/VCR/DVD switch to the right.

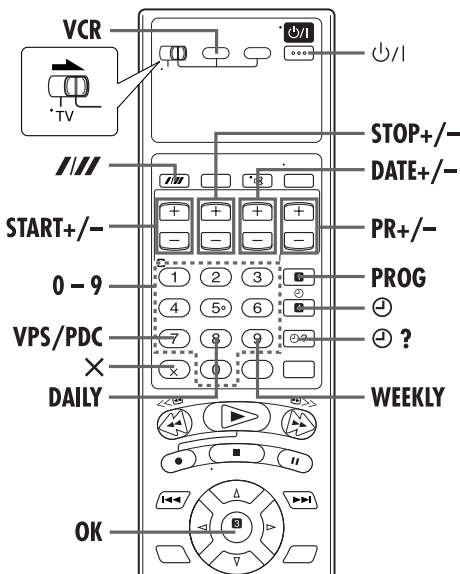

Example: To timer-record the programme from 21:00 to 22:00 on 25th December, on channel 1.

## 1 Select the VHS deck.

### On the unit

Press **VCR/DVD** repeatedly so that the VCR indicator lights up.

### On the remote control

Press **VCR** so that the VCR indicator lights up.

## 2 Access the SHOWVIEW screen.

Press **PROG**.

## 3 Access the Programme screen.

Press **START +/-**. (If you're just starting out, "P1" appears.)

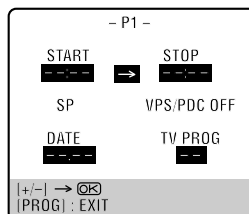

## 4 Enter the programme start time.

Press **START +/-** to enter the time you want recording to start.

- Press and hold **START +/-** to move in 30-minute increments, or press and release repeatedly to move 1 minute at a time.

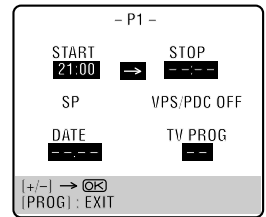

## 5 Enter the programme stop time.

Press **STOP +/-** to enter the time you want recording to stop.

- Press and hold **STOP +/-** to move in 30-minute increments, or press and release repeatedly to move 1 minute at a time.

## 6 Enter the programme date.

Press **DATE +/-**.

- The current date appears on the TV screen. The date you enter appears in its place.

## 7 Enter the channel position.

Press **PR +/-**.

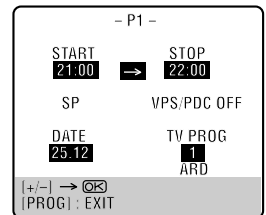

## 8 Set the tape speed.

Press **///**.

## 9 Set the VPS/PDC mode.

Press **VPS/PDC** (number key "7") to select "ON" or "OFF".

- If "VPS/PDC ON" is displayed on the TV screen, "VPS/PDC" is set to "ON".
- If "VPS/PDC OFF" is displayed on the TV screen, "VPS/PDC" is set to "OFF".
- "VPS/PDC Recording" on page 25.

## 10 Return to the normal screen.

Press **PROG** or **OK**. "PROGRAM COMPLETED" appears on the TV screen for about 5 seconds, then the normal screen appears.

- Repeat steps 2 - 10 for each additional programme.

## 11 Engage the unit's timer mode.

Press **⊖**. The unit turns off automatically and "⊖" appears on the front display panel.

- To disengage the timer mode, press **⊖** again.

**To Timer-Record Weekly Or Daily Serials:**

— anytime during steps 1 through 2, press **WEEKLY** (number key "9") for weekly serials or **DAILY** (number key "8") for daily serials (Monday – Friday). Either "WEEKLY" or "DAILY" appears on the TV screen. Pressing the button again makes the corresponding indication disappear.

**NOTES:**

- You can programme this unit to timer-record as many as 8 programmes. If you try to programme the unit to record a ninth, "PROGRAM FULL" appears on the TV screen and "FULL" appears on the front display panel. To record the extra programme, you must first cancel any unnecessary programmes. (☞ "To cancel or change a programme")
- If there is a conflict in the timer schedule and one programme overlaps with another, the programme starting earlier or programme with the lower programme number will be recorded.

**Satellite Receiver Users**

To timer-record a satellite broadcast using Express Timer Programming:

- 1 Set "L-2 SELECT" to "A/V". (☞ pg. 64)
- 2 Perform steps 1 – 11. Enter "L-2" for the channel position in step 7.
- 3 Set the satellite receiver to the appropriate channel before the selected programme begins.
- 4 Leave the satellite receiver's power on.

**Check, cancel and change programmes****1 Disengage the timer mode.**

Press ⊖, then press ⏪/I.

**2 Access the Programme Check screen.**

Press ⊖ ?.

	START	STOP	CH	DATE
1	8:00	10:00	3	24.12
2	10:00	10:45	2	25.12
3	11:30	13:00	1	25.12
4				
5				
6				
7				
8				

⊖ ?] : NEXT

**3 Access the Programme screen.**

Press ⊖ ? again to check more information. Each time you press ⊖ ?, the next programme's information appears.

- P1 -	
START	STOP
8:00	10:00
SP	VPS/PDC OFF
DATE	TV PROG
24.12	3
	WDR

⊖ ?] : NEXT

**To cancel or change a programme****4 Cancel or change a programme.**

Press X to cancel a programme. To change programme settings, press the appropriate button: **START** +/-, **STOP** +/-, **DATE** +/-, **PR** +/-, **VPS/PDC** (number key "7"), **DAILY** (number key "8"), **WEEKLY** (number key "9") and/or **///**.

**5 Return to the normal screen.**

Press ⊖ ? as many times as necessary. If there are still some programmes remaining, go on to step 6.

**6 Return to the timer mode.**

Press ⊖.

**NOTE:**

You can also check the programmes on the front display panel even if the unit's power is off (unless the unit is in the Power Save mode ☞ pg. 64) or the unit is in the Timer mode; however, it is not possible to cancel or change the programmes.

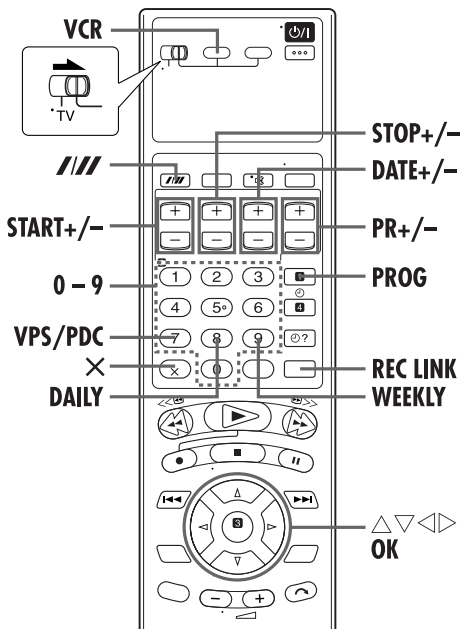

## When programmes overlap each other

If "PROGRAM OVERLAPPED" appears, you have another programme overlapping the programme you have just made. The Programme Check screen appears and conflicting programmes will start blinking.

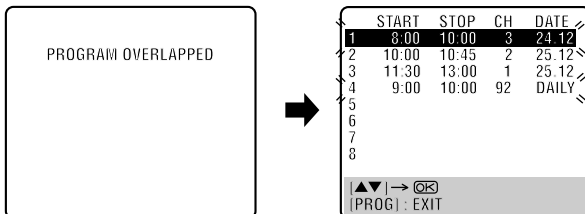

**Example:** Programme 1 (you have just made) and Programme 4 overlap each other.

## 1 Confirm the overlapping programmes.

Overlapping programmes blink on the TV screen.

## 2 Select the programme to modify.

Press  $\Delta$ / $\nabla$ , then press **OK** or  $\triangleright$ .

- You can only select one of the overlapping programmes.

### NOTE:

If you do not mind this overlap, press **PROG** to finish the timer programme setting. The programme with the lower programme number will be recorded and the other one will not be recorded correctly. If no changes are made for approximately 1 minute, the unit will return to the normal screen.

## 3 Cancel or change programme setting.

**To cancel a programme**, press **X** when the Programme screen you do not want is shown. "PROGRAM COMPLETED" appears on the TV screen for about 5 seconds, then the normal screen appears.

**To change a programme**, press the appropriate button: **START +/-**, **STOP +/-**, **DATE +/-**, **PR +/-**, **VPS/PDC** (number key "7"), **DAILY** (number key "8"), **WEEKLY** (number key "9") and/or **///** when the Programme screen on which you want to make changes is shown, then press **OK**. "PROGRAM COMPLETED" appears on the TV screen for about 5 seconds, then the normal screen appears.

### NOTE:

If the overlap is not yet solved, or another overlap occurs with the timer programme setting after making the last correction on a programme, the conflicting programmes will be shown on the Programme Check screen again. Repeat the above steps again until the overlap is solved.

## Automatic Satellite Programme Recording

This function allows you to automatically record a satellite programme which is timer-programmed on your external satellite receiver. Connect a satellite receiver to the unit's L-2 IN/DECODER connector and programme the timer on the satellite receiver. The unit starts or stops recording by the signals input from the satellite receiver. After recording, the unit's power shuts off automatically.

### ATTENTION

- Be sure not to turn on the satellite receiver before the programme is executed; otherwise, the unit will start recording when the satellite receiver's power is turned on.
- If you have connected another appliance other than a satellite receiver to the L-2 IN/DECODER connector, be sure not to engage the Automatic Satellite Programme Recording mode; otherwise, the unit will start recording when the connected appliance's power is turned on.
- Automatic Satellite Programme Recording and timer-recording cannot be done at the same time.

**Before performing the following steps:**

- Make sure the satellite receiver is connected to the unit's L-2 IN/DECODER connector. (☞ pg. 60)
- Programme the timer on the satellite receiver.
- Insert a cassette with the safety tab in place.
- Slide the TV/VCR/DVD switch to the right.

**1 Select the VHS deck.****On the unit**

Press **VCR/DVD** repeatedly so that the VCR indicator lights up.

**On the remote control**

Press **VCR** so that the VCR indicator lights up.

**2 Select the L-2 SELECT mode.**

Set "L-2 SELECT" to "AN" or "SAT". (☞ pg. 64)

- When you select "SAT", refer to "IMPORTANT" on page 60.

**3 Set the tape speed.**

Press **///**.

**4 Engage the Automatic Satellite Programme Recording mode.****On the unit**

Press and hold **SAT** for about 2 seconds.

**On the remote control**

Press and hold **REC LINK** for about 2 seconds.

- The "⏏" and "⏻" indicators light up and the unit turns off automatically.

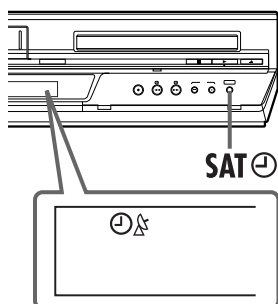
**NOTES:**

- Operations on the DVD deck are not possible when the Automatic Satellite Programme Recording mode is engaged or timer recording is in progress.
- To disengage the Automatic Satellite Programme Recording mode, press **REC LINK**. The "⏏" indicator goes off.
- If the unit's power is off, it is not possible to engage the Automatic Satellite Programme Recording mode.
- In step **4**, if the "⏏" indicator does not light but instead blinks quickly even though your satellite receiver's power is off, Automatic Satellite Programme Recording will not work properly with that satellite receiver\*. If this is the case, perform "Express Timer Programming" (☞ pg. 26) to timer-record a satellite programme.
  - \* Some satellite receivers output signals even if the power is off. Automatic Satellite Programme Recording is not possible with those satellite receivers.
- The "⏏" indicator blinks while Automatic Satellite Programme Recording is in progress.
- For timer programming of the satellite receiver, refer to the instruction manual of the satellite receiver.
- Automatic Satellite Programme Recording is not possible if your satellite receiver does not have a timer.
- Pressing the unit's **⏻** button while Automatic Satellite Programme Recording is in progress turns off the unit's power and disengages the Automatic Satellite Programme Recording mode.
- If there are more than one satellite programmes you wish to record with Automatic Satellite Programme Recording, it is not possible to set different tape speeds for each programme.
- Depending on the type of satellite receiver, the unit may not record a slight portion of the beginning of the programme or may record slightly longer than the actual length of the programme.
- If you engage the Automatic Satellite Programme Recording mode when the satellite receiver's power is on, the unit will not start Automatic Satellite Programme Recording even though the "⏏" and "⏻" indicators blink. When the satellite receiver shuts off once and is turned back on again, the unit starts recording.
- You can also record a programme from your cable system in the same way if the system has a timer.
- The B.E.S.T. system (☞ pg. 23) does not work while Automatic Satellite Programme Recording is in progress.
- Just Clock (☞ pg. 75) does not work when the Automatic Satellite Programme Recording mode is engaged.

# Basic Playback



- Turn on the TV and select the video channel (or AV mode).
- Slide the TV/VCR/DVD switch to the right.

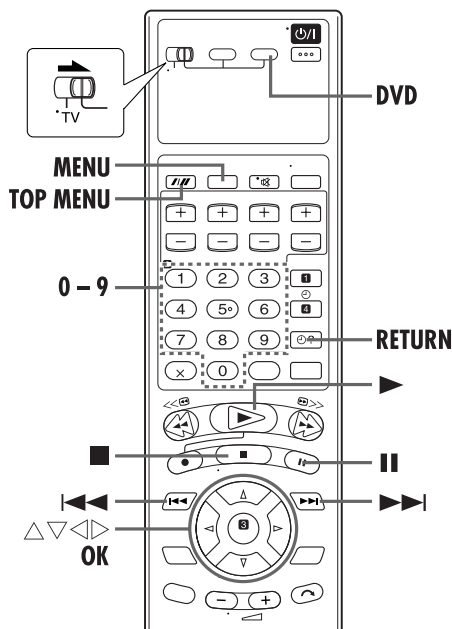
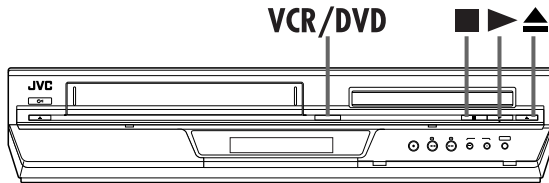

## ATTENTION

- You can not use the DVD deck when the VHS deck is in the Automatic Satellite Programme standby and recording mode.
- You can use the DVD deck when the VHS deck is in the timer standby mode.

To play back an MP3/JPEG disc, see pages 48 – 53.

## 1 Load the disc.

- 1 Press on the DVD deck to open the disc tray.
  - The unit's power comes on automatically.
- 2 Place the disc in the disc tray.
  - For details, refer to "Placing a Disc" ( pg. 5).
- 3 Press on the DVD deck to close the disc tray.
  - Pressing also closes the disc tray.
  - Playback begins automatically if an auto-playback DVD disc is loaded. Although the VHS deck is selected, the DVD deck is selected automatically if the VHS deck is in stop mode.

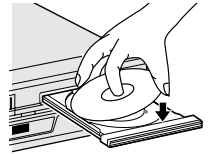

## 2 Select the DVD deck.

### On the unit

Press **VCR/DVD** repeatedly so that the DVD indicator lights up.

### On the remote control

Press **DVD** so that the DVD indicator lights up.

## 3 Start playback.

Press .

Example: DVD VIDEO

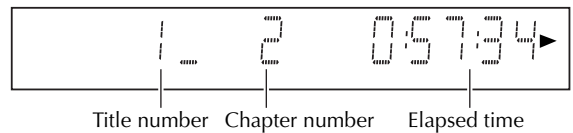

- It may take a few seconds to start playback.
- If you load a DVD disc whose region code does not match the DVD deck, "REGION CODE ERROR!" appears on the TV screen. For details, refer to "Region Number" ( pg. 4).
- With Video CD discs with PBC control or some DVD discs, the menu display may appear on the TV screen after starting playback. In this case, select an item which you want to play back from the menu. Otherwise, the playback cannot go forward. Refer to "Locating a desired scene using the menu of a Video CD with PBC" ( pg. 31) or "Locating a desired scene using the DVD menu" ( pg. 31).

## 4 Pause playback.

Press **II**.

- To resume normal playback, press .

## 5 Stop playback.

Press **■**. Press on the DVD deck to open the disc tray, then remove the disc.

- Pressing resumes playback from the position where you stopped playback. For details, see "Resume Function" on page 32.

## NOTE:

When you press while the unit is turned off, the unit's power comes on and the disc tray opens automatically.

# Playback Features

- Turn on the TV and select the video channel (or AV mode).
- Slide the TV/VCR/DVD switch to the right.

## Playback Control (PBC) Function — Locating a desired scene using the menu of a Video CD with PBC



Some Video CD discs support the PBC function. PBC is an abbreviation of "PlayBack Control." A Video CD disc recorded with PBC has its own menus, such as a list of the songs on the disc. You can locate a specific scene by using the menu.

### 1 Access the PBC menu.

#### In stop mode

Press **▶**.

- Depending on a disc, PBC menu may automatically appear on the TV screen by simply loading a disc on the unit.

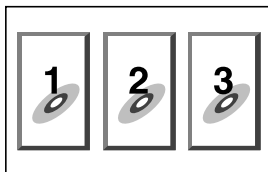

#### During playback

Press **RETURN**.

- "PBC" appears on the front display panel.

### 2 Start playback.

Press the appropriate **number keys**.

- The unit starts playback of the selected item.
- When "NEXT" or "PREVIOUS" appears on the TV screen:
  - Pressing **▶▶** advances to the next page.
  - Pressing **◀◀** returns to the previous page.
- You can return to the menu by pressing **RETURN**.
- The method of the operation is different depending on the disc.

#### NOTES:

- If you want to playback a PBC-compatible Video CD disc without activating the PBC function, start playback by using the **number keys** instead of the **▶** button.
- To activate the PBC function when a PBC-compatible Video CD disc is being played back without the PBC function, press **TOP MENU** or **MENU**, or press **■** (press twice when "RESUME" is set to "ON") then press **▶**.

## Locating a desired scene using the DVD menu



DVD VIDEO discs may have two types of menus; top menu and disc menu.

#### Top menu

DVD discs generally have their own menus which show the disc contents. These menus contain various items such as titles of a movie, names of songs, or artist information. You can locate a desired scene by using the top menu displayed on the TV screen. Press **TOP MENU** to access the top menu.

#### Disc menu

DVD discs have a disc menu to select subtitle and audio language etc. for each title. Press **MENU** to access the disc menu.

### 1 Access the DVD menu.

Press **TOP MENU** or **MENU**.

### 2 Start playback.

Press **△▽◀▶** to select a desired item, then press **OK**.

- It may be possible to select the desired item using the **number keys** depending on the disc.

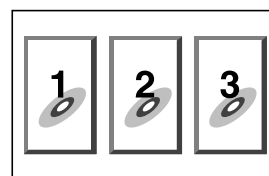

Example:

#### NOTES:

- When "⊗" appears on the TV screen in step 1, the disc does not have a top menu or disc menu.
- Top menu or disc menu may not appear depending on the discs even if it is recorded in DVD VIDEO format and finalized. In that case, press **■** to display the total number of titles on a disc, then press the appropriate **number keys** to select the desired title.

## Locating the start point of the item or skip the item



Press **◀◀** or **▶▶** during playback.

#### Example:

To locate the beginning of item B from the current position, press **◀◀** twice.  
To locate the beginning of item D from the current position, press **▶▶** once.

- When the specified item is located, playback begins automatically.

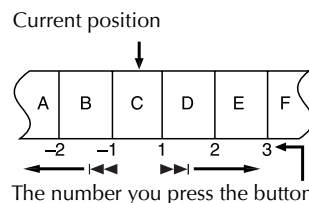

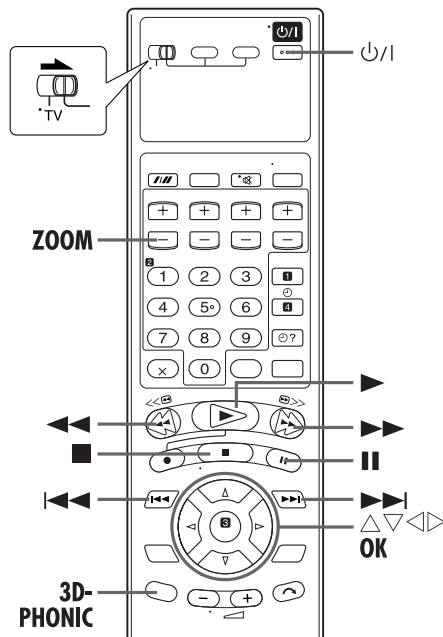

## Variable Speed Search



During playback, press ▶▶ for forward variable speed search, or ◀◀ for reverse variable speed search.

- The more times you press, the faster the playback picture moves.
- To resume normal playback, press ▶.

OR

During playback, press and hold ▶▶ for forward variable speed search, or press and hold ◀◀ for reverse variable speed search.

- While you press and hold the button, the image is played back at 5x speed.
- To resume normal playback, release ◀◀ or ▶▶.

### NOTES:

- Actual speed may be different from that displayed on the TV screen depending on the discs.
- Playback sound is not heard in any variable speed search mode other than in 1.5x speed search mode.
- During 1.5x speed search of a DVD VIDEO disc, you can hear the played back audio converted into Linear PCM format in stereo. In such a case, the pitch and sound quality may change depending on the disc.
- In case of DVD VIDEO discs formatted in DTS format, SVCD or Audio CD discs, playback sound is not heard during 1.5x speed search.
- When switching to 1.5x speed search during variable speed search, first press ▶ to return to normal playback, then press ▶▶.

## Still Picture/Frame-By-Frame Playback



### 1 Pause during playback.

Press II.

### 2 Activate frame-by-frame playback.

Press II to advance a still picture.

- To resume normal playback, press ▶.

## Slow Motion



During playback, press II, then press ◀◀ for reverse slow motion playback, or ▶▶ for forward slow motion playback.

- Each press of ▶▶ changes the playback speed as follows:  
1/32 → 1/16 → 1/4 → 1/2
- Each press of ◀◀ changes the playback speed as follows (only for DVD VIDEO discs):  
-1/32 → -1/16 → -1/4 → -1/2
- To resume normal playback, press ▶.

### NOTES:

- Reverse slow motion playback is possible only with the DVD VIDEO discs.
- This function may not work for some Video CD or SVCD.

## Resume Function



It is possible to memorize the position where you stop playback and resume playback from that position.

- Be sure to set "RESUME" to "ON" or "DISC RESUME". (☞ pg. 67)

### 1 Memorize a resume point.

Press ■ during playback.

- "RESUME STOP" appears on the front display panel.
- The unit enters Resume Stop mode and memorizes the position where you stop playback as the resume point.
- The unit retains a memory of the resume points of the last 30 discs played back, even though they have been ejected if "RESUME" is set to "DISC RESUME". (☞ pg. 67)
- To clear the resume point:  
**When "RESUME" is set to "ON":**
  - Press ■ in stop mode.
  - Press power to turn off the unit.
  - Eject the disc.**When "RESUME" is set to "DISC RESUME":**
  - Set "RESUME" to "OFF". (☞ pg. 67)
  - Press ■ in stop mode.

### 2 Resume playback.

Press ▶. The unit starts playback from the resume point.

- "RESUME PLAY" appears on the front display panel.

### NOTES:

- Resume Function does not work on the Audio CD. It also may not work depending on the discs.



- If you stop the playback of a disc for which an resume point has already been memorized, the memory will be updated with the new resume point.
- After the unit has memorized the resume point for 30 discs, remembering a new resume point will cause the unit to delete the oldest memorized point. Stopping playback of a disc for which a resume point is already stored may change the order in which the points are stored. This may potentially change the order in which points are deleted.
- When the unit memorizes a resume point for a disc, it also remembers audio language, subtitle and angle settings.
- This function may not work for some Video CD or SVCD.

## Zooming



Press **ZOOM** during playback or while paused.

- Each press of **ZOOM** changes the magnification as follows:  
1.8x→4x→8x→16x→32x→64x
- When a 16:9 aspect picture source is displayed on a 4:3 aspect TV (conventional TV) in Letter Box conversion mode, the margins in black shown on top and bottom of the TV screen will be cropped by selecting 1.8x magnification. In such a case, note that both left and right side parts of the picture will also be cropped.
- While zoomed, the picture may look coarse or distorted.

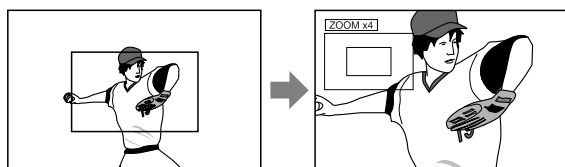

Current magnification

Zoomed-in area

Press  $\Delta$   $\nabla$   $\triangleleft$   $\triangleright$  to move the zoomed-in scene.

- To resume normal playback, press **OK**.

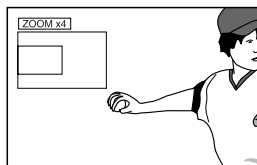

## 3D Phonic



The 3D Phonic function allows you to get a simulated surround effect from your stereo system. You can enjoy vertical surround sound with your 2-channel stereo system.

### 1 Access the selection menu.

Press **3D-PHONIC** during playback.

- The current setting appears on the right bottom corner of the TV screen.

### 2 Select the mode.

Press  $\triangleleft$   $\triangleright$  repeatedly, then press **OK**.

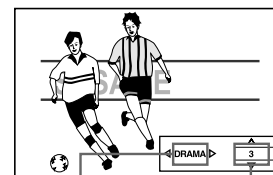

Selected mode

Effect level

- Each time you press  $\triangleleft$   $\triangleright$ , the setting changes as follows:  
NONE→ACTION→DRAMA→THEATER→(Back to the beginning)

NONE:	No effect
ACTION:	Suitable for action movies and sports programmes in which sounds dynamically move.
DRAMA:	Provides natural and warm sound. You can enjoy movies in a relaxed mood.
THEATER:	You can enjoy sound effects like in a major theater.

- The selection menu disappears automatically if you do not change the selection for 10 seconds.

### 3 Select the effect level.

Press  $\Delta$   $\nabla$  to select the desired effect level. (level 1 to 5)

- To resume normal playback, press **3D-PHONIC**.

### NOTES:

- The 3D Phonic function works correctly only when playing back a DVD VIDEO disc recorded in the Dolby Digital format. With other sources, you cannot get any effect if you activate the 3D Phonic function.
- When playing back a DVD VIDEO disc recorded with Dolby Digital that does not contain the rear signal, you cannot get a correct 3D Phonic sound even if you activate the 3D Phonic function.
- The 3D Phonic function does not affect the Dolby Digital bitstream signal from the DIGITAL AUDIO OUT connector.
- When 3D Phonic function is activated, Analog Down Mix and D. Range Control functions are disabled. (pg. 66)

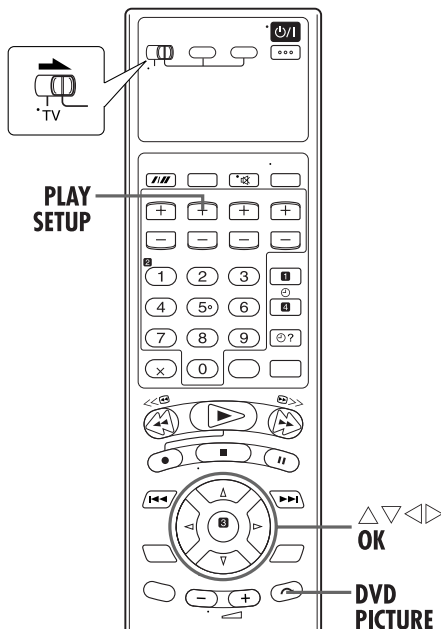

To adjust picture appearance manually

### 3 Access the USER menu.

Press  $\triangleleft \triangleright$  repeatedly to select "USER 1" or "USER 2".

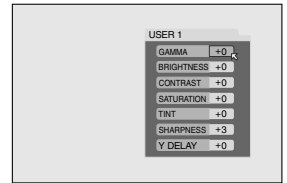

### 4 Select the parameter.

Press  $\triangle \nabla$  repeatedly to select a parameter you want to adjust, then press **OK**.

- Adjust gradually and confirm picture appearance results are as preferred.

<b>GAMMA</b> (-4 to +4):	Controls brightness of neutral tints while maintaining brightness of dark and bright portions.
<b>BRIGHTNESS</b> (-16 to +16):	Controls screen brightness.
<b>CONTRAST</b> (-16 to +16):	Controls screen contrast.
<b>SATURATION</b> (-16 to +16):	Controls screen colour depth.
<b>TINT</b> (-16 to +16):	Controls screen tint.
<b>SHARPNESS</b> (+0 to +3):	Controls screen sharpness.
<b>Y DELAY</b> (-2 to +2):	Controls screen colour gap.

- VFP menu disappears and the following pop-up window appears on the TV screen.

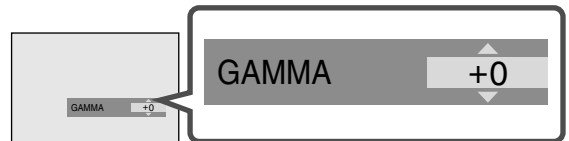

### 5 Adjust the parameter.

Press  $\triangle \nabla$  repeatedly to change the setting, then press **OK**.

- The current VFP settings appear again.

### 6 Adjust the other parameters.

Repeat steps 4 and 5 to adjust other parameters.

**To return to the normal screen**

Press **DVD PICTURE**.

**To activate your setting**

Press **DVD PICTURE**, then press  $\triangleleft \triangleright$  repeatedly to select "USER 1" or "USER 2" that you have changed the parameters.

## VFP function

### — Adjusting the picture quality



The VFP (Video Fine Processor) function enables you to adjust the picture character according to the type of programming, picture tone or personal preference.

#### NOTE:

Before you start operation;  
The VFP setting screen disappears if no operations are done for more than about 10 seconds. If the setting screen disappears before you finish, start from step 1 again.

### 1 Access the VFP setting menu.

Press **DVD PICTURE** during playback.

- The current setting appears on the TV screen.

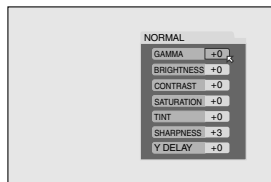

### 2 Select the VFP mode.

Press  $\triangleleft \triangleright$  repeatedly.

- Each time you press  $\triangleleft \triangleright$ , the VFP mode changes as follows:  
NORMAL → CINEMA → USER 1 → USER 2 → (Back to the beginning)

<b>NORMAL:</b>	Select this normally.
<b>CINEMA:</b>	Suitable for movie.
<b>USER 1/ USER 2:</b>	You can adjust parameters that affect picture appearance and store settings. Go to step 3.

#### NOTE:

You cannot adjust the parameters of "NORMAL" and "CINEMA".

# Using the on-screen bar



You can check disc information while the disc is loaded and you can use some functions using the on-screen bar. The on-screen bar allows you the various playback operations.

## How to Access the on-screen bar

Press **PLAY SETUP** twice whenever a disc is loaded.

Example: During DVD VIDEO playback



Example: During Video CD playback

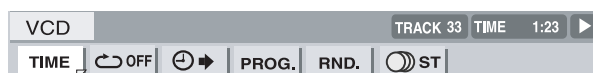

## Contents of the on-screen bar during playback

### DVD

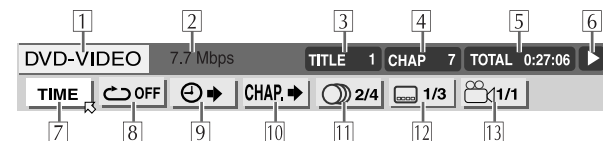

### Video CD

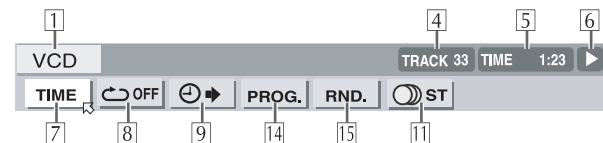

- 1 Disc type
- 2 Current transfer rate (Megabits per second)
- 3 Current title (for DVD)
- 4 Current chapter number (for DVD) or track number (for other type of discs)
- 5 Time information (☞ pg. 36)
- 6 Playback status
  - ▶: appears during playback.
  - ▶▶ / ◀◀: appears during fast forward/reverse.
  - ▶◀ / ◀▶: appears during playback in forward slow-motion/reverse slow-motion.
  - ⏸: appears when paused.
  - : appears when stopped.
- 7 Select this to change time information. (See 5 in the illustration above) (☞ pg. 36)
- 8 Select this for Repeat Playback. (☞ pg. 36)
- 9 Select this for time search function. (☞ pg. 38)
- 10 Select this for chapter search function. (☞ pg. 38)
- 11 Select this to change audio language or channel. (☞ pg. 42, 43)
- 12 Select this to change subtitle language. (☞ pg. 40)
- 13 Select this to change view angle. (☞ pg. 41)
- 14 Select this for Programme Playback. (☞ pg. 39)
- 15 Select this for Random Playback. (☞ pg. 40)

## Basic operation on the on-screen bar

Example: When selecting the Repeat mode of DVD

### During playback or while stopped

#### 1 Access the on-screen bar.

Press **PLAY SETUP** twice. The on-screen bar appears on the TV screen.

- The currently selected item is highlighted.



#### 2 Select the menu item.

Press ◀▶ to move ⏪ to ⏩, then press **OK**. The pop-up window appears under the selected item.

- The current setting appears.



#### 3 Select the option.

Press ▲▼ to select the desired option, then press **OK**.

- Each time you press ▲▼, the options change.

### To clear the on-screen bar

Press **PLAY SETUP**.

### NOTE:

See the corresponding pages for details on each function.

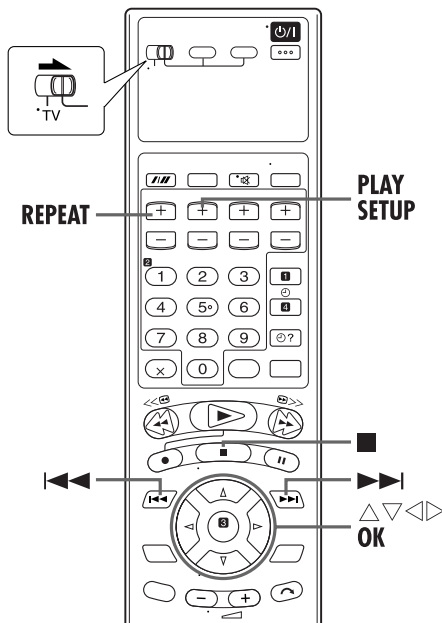

## Change the time information



You can change the time information in the on-screen bar on the TV screen and the front display panel of the unit.

During playback or while stopped

### 1 Access the on-screen bar.

Press **PLAY SETUP** twice. The on-screen bar appears on the TV screen.

### 2 Select the menu item.

Press  $\triangleleft \triangleright$  to move  $\mathbb{R}$  to **TIME**, then press **OK**.

- Each time you press **OK**, the time information changes as follows;

Example: During DVD playback

$\Rightarrow$  **TIME** 0:25:58  $\Rightarrow$  **REM** 0:18:14  $\Rightarrow$  **TOTAL** 1:25:58

$\Rightarrow$  **T.REM** 0:45:41  $\Rightarrow$  (Back to the beginning)

<b>TIME:</b>	Elapsed playing time of current chapter/track
<b>REM:</b>	Remaining time of current chapter/track
<b>TOTAL:</b>	Elapsed time of title/disc
<b>T. REM:</b>	Remaining time of title/disc

**To clear the on-screen bar**

Press **PLAY SETUP**.

## NOTES:

- While playing a Video CD, Audio CD or SVCD, the hour digit indication does not appear.
- While a DVD is stopped, “--:--” appears in the time information display.

## Repeat Playback



You can repeat playback as you like according to the type of disc.

DVD VIDEO: during playback

Audio CD: during playback or in stop mode

Video CD/SVCD: in stop mode or during playback with PBC disactivated

When using the on-screen bar

### 1 Access the on-screen bar.

Press **PLAY SETUP** twice. The on-screen bar appears on the TV screen.

### 2 Select the menu item.

Press  $\triangleleft \triangleright$  to move  $\mathbb{R}$  to  $\mathbb{R}$ , then press **OK**.

- The following pop-up window appears under the selected item.

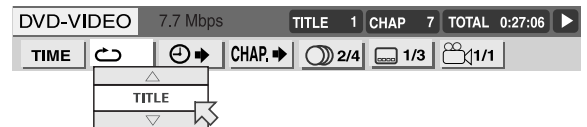

### 3 Select the repeat mode.

Press  $\triangle \nabla$  repeatedly to select the Repeat mode, then press **OK**.

- The mode changes as follows:

**DVD VIDEO**

CHAPTER  $\rightarrow$  TITLE  $\rightarrow$  A-B  $\rightarrow$  OFF  $\rightarrow$  (Back to the beginning)

<b>CHAPTER:</b>	The current chapter is played back repeatedly.
<b>TITLE:</b>	The current title is played back repeatedly.
<b>A-B:</b>	The desired part is played back repeatedly. (pg. 37)
<b>OFF:</b>	Each title and chapter is played back once.

**Video CD/SVCD/CD**

TRACK  $\rightarrow$  ALL  $\rightarrow$  A-B  $\rightarrow$  OFF  $\rightarrow$  (Back to the beginning)

<b>TRACK:</b>	The current track is played back repeatedly.
<b>ALL:</b>	All tracks are played back repeatedly.
<b>A-B:</b>	The desired part is played back repeatedly. (pg. 37)
<b>OFF:</b>	Each track is played back once.

- “A-B” cannot be selected while stopped.

**To clear the on-screen bar**

Press **PLAY SETUP**.

**To cancel Repeat Playback**

Repeat from step **1**, select "OFF" in step **3**, then press **OK**.

**When using the REPEAT button:****1 Access the repeat mode.**

Press **REPEAT** during playback of the item you want to repeat.

- Repeat mode is displayed on the TV.

**2 Select the repeat mode.**

Press **REPEAT** repeatedly to select the desired repeat mode, then press **OK**.

- To stop Repeat Playback, press **■**.
- To cancel Repeat Playback, press **REPEAT** repeatedly until "OFF" appears on the TV screen, then press **OK**.

**NOTES:**

- Repeat Playback is not possible with a Video CD and SVCD with PBC function.
- Repeat Playback may not work properly depending on the type of disc being used.
- You cannot select A-B Repeat Playback by pressing **REPEAT**.

**A-B Repeat Playback**

You can repeat the desired part.

**1 Access the on-screen bar.**

Press **PLAY SETUP** twice. The on-screen bar appears on the TV screen.

**2 Select the menu item.**

Press **<>** to move **↩** to **↻**, then press **OK**.

- The following pop-up window appears under the selected item.

**3 Select the repeat mode.**

Press **△▽** repeatedly to select "A-B".

**4 Select the start point.**

Press **OK** at the beginning of the part you want to repeat (point A).

- The following display appears in the on-screen bar.

**5 Select the end point.**

Press **OK** at the end of the part you want to repeat (point B).

- A-B Repeat Playback starts. The selected part of the disc (between point A and B) is played repeatedly.

**To cancel A-B Repeat Playback**

Repeat from step **1**, select "OFF" in step **3**, then press **OK**.

- You can also cancel Repeat Playback by pressing **◀◀** or **▶▶**.

**To clear the on-screen bar**

Press **PLAY SETUP**.

**NOTES:**

- A-B Repeat Playback may not work properly depending on the type of disc being used.
- The subtitles recorded around point A-B may not appear.
- The end of the item will be set as the "B" point if the end of the item reached before you set the "B" point.
- When playing back a DVD, A-B Repeat Playback is possible only within the same title.
- "A-B" cannot be selected during Programme and Random Playback.
- "A-B" cannot be selected while stopped.

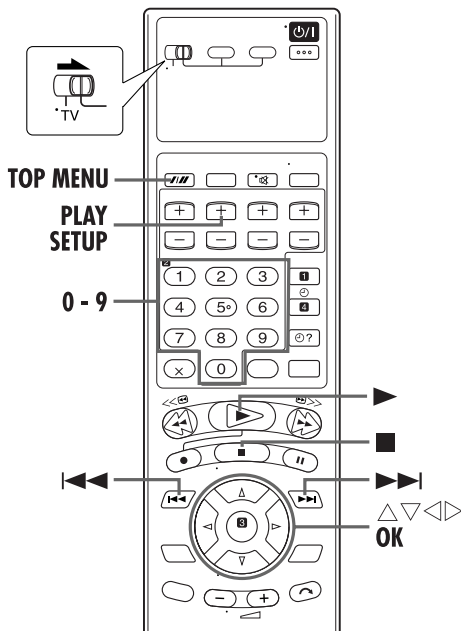

Example:

To play back from a point 2 (hours): 34 (minutes): 08 (seconds) elapsed

TIME \_: \_: \_ → TIME 2: \_: \_ →  
Press 2 Press 3

TIME 2:3 \_: \_ → TIME 2:34: \_ →  
Press 4 Press 0

TIME 2:34:0 \_ → TIME 2:34:08  
Press 8

**If you have specified a wrong selection,**

Press **<** repeatedly until the wrong number is erased, then press **number keys** to enter the correct numbers.

- The unit starts playback from the specified time.

**To clear the on-screen bar**

Press **PLAY SETUP**.

## NOTES:

- When "∞" is displayed on the TV screen in step **3**, you have selected a point that exceeds the recording time of the disc.
- Some DVD VIDEO discs do not contain time information, and it is not possible to use the Time Search function. In such a case, "∞" is displayed on the TV screen as well.
- Time Search does not work while you play back the Video CD or SVCD with the PBC Function.

**Reactivate the Playback Control (PBC) Function**

You can reactivate the PBC function when you play back a PBC-compatible Video CD disc without PBC function.

- Press **TOP MENU** during playback.

## Time Search



You can play back a disc from the desired point by specifying the elapsed time from the beginning of the current title (for DVD VIDEO) or the disc (for Audio CD/Video CD) using the Time Search.

When a PBC-compatible Video CD is played back, be sure to inactivate PBC function before you perform Time search by pressing the **number keys** instead of the **▶** button when you start playback.

### 1 Access the on-screen bar.

Press **PLAY SETUP** twice. The on-screen bar appears on the TV screen.

### 2 Select the menu item.

Press **< >** to move **↔** to **⌂**, then press **OK**.

- The following pop-up window appears under the selected item.

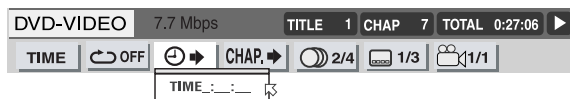

### 3 Select the time.

Press the **number keys** (0-9) to enter the time, then press **OK**.

## Chapter Search



You can start playback the desired chapter using the on-screen bar.

### 1 Access the on-screen bar.

Press **PLAY SETUP** twice. The on-screen bar appears on the TV screen.

### 2 Select the menu item.

Press **< >** to move **↔** to **CHAP. ▶**, then press **OK**.

- The following pop-up window appears under the selected item.



### 3 Select the chapter.

Press the **number keys** (0-10) to enter the desired chapter number, then press **OK**.

- The unit starts playback from the selected chapter.

**Examples:**

- To select track 5, press the **number key "5"**.
- To select track 15, press the **number key "1"** and **"5"**.
- To select track 25, press **number key "2"** and **"5"**.
- It is not possible to use the **number key "+10"**.

**If you have specified a wrong selection**

Enter the appropriate **number keys** again.

**To clear the on-screen bar**

Press **PLAY SETUP**.

**NOTES:**

- When "⊗" is displayed on the TV screen in step **3**, the chapter you have selected is not contained in the disc, or chapter search does not work on the disc.
- Chapter Search starts automatically when you select the desired chapter in step **3** depending on the disc.

## Programme Playback



You can play back up to 99 tracks in the desired order.

### 1 Access the on-screen bar.

Press **PLAY SETUP** twice in stop mode.

### 2 Select the menu item.

- Press  $\triangleleft$   $\triangleright$  to move  $\mathbb{R}$  to **PROG.**, then press **OK**.
- The programme table appears under the on-screen bar.



### 3 Select the tracks in the desired order.

Press the appropriate **number keys** to select the tracks.

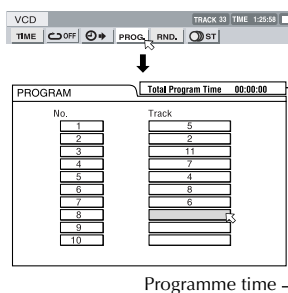
**Examples:**

- To select track 5, press the **number key "5"**.
- To select track 15, press the **number key "+10"** and **"5"**.
- To select track 25, press **number key "+10"** twice, then **"5"**.

**If you have specified a wrong selection**

Press **■**. The last selection programmed is erased.

## 4 Start playback.

Press **▶**. Playback starts in the selected order.

- When all of the programmed tracks have been played back, Programme Playback stops, but the programmed information remains.
- To stop Programme Playback, press **■**.
- To clear all the programmed tracks, press **■** to stop playback and press **PLAY SETUP** to clear the programme table, then press **■** again.
- During Programme Playback, pressing **▶▶** skips to the next selection of the programme. Pressing **◀◀** returns to the beginning of the current selection.

**To clear the programme table**

Press **PLAY SETUP**.

**NOTE:**

Programme Playback may not be possible depending on the type of disc.

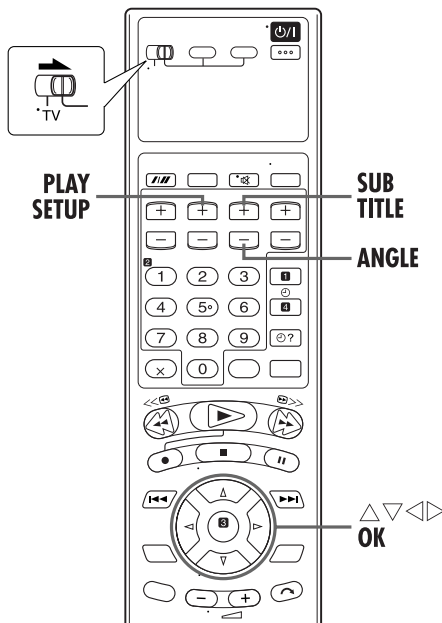

## Random Playback



You can play back all the tracks on the disc in random order.

### 1 Access the on-screen bar.

Press **PLAY SETUP** twice in stop mode.

### 2 Select the menu item.

Press  $\triangleleft \triangleright$  to move  $\mathbb{R}$  to **RND.**, then press **OK**.

- Playback starts in random order.



- To stop and quit Random Playback, press  $\blacksquare$ .
- To cancel Random playback, repeat step **2** during Random Playback. Normal playback resumes at the current point.

#### To clear the on-screen bar

Press **PLAY SETUP**.

### NOTES:

- The same track will not be played back more than once during Random Playback.
- Random playback is canceled when all the tracks have been played back.

## Subtitle Selection



You can select subtitle language.

- During playback

When using the on-screen bar

### 1 Access the on-screen bar.

Press **PLAY SETUP** twice. The on-screen bar appears on the TV screen.

### 2 Select the menu item.

Press  $\triangleleft \triangleright$  to move  $\mathbb{R}$  to  $\text{---}$ , then press **OK**.

- The following pop-up window appears under the selected item.

Example (DVD): "ENGLISH" is selected out of 3 subtitle languages recorded.



### 3 Select the subtitle language.

Press  $\triangle \nabla$  repeatedly to select the desired subtitle language, then press **OK**.

- Each time you press the button, the subtitle language changes.

#### To clear the on-screen bar

Press **PLAY SETUP**.

### NOTES:

- **For DVD VIDEO**  
Some subtitle languages are abbreviated in the pop-up window. See "Language Code List" (pg. 17).
- **For SVCD**  
SVCD can contain up to four subtitles. Pressing **SUB TITLE** changes the subtitles regardless of whether the subtitles are recorded or not. (Subtitles will not change if no subtitle is recorded.)
- When "0" appears on the TV screen in step **3**, subtitle language is not recorded.

When using the **SUB TITLE** button:

### 1 Access the menu.

Press **SUB TITLE**.

- The following pop-up window appears on the TV screen.

Example (DVD): "ENGLISH" is selected out of 3 subtitle languages recorded.

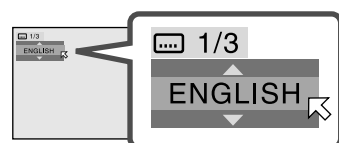



## 2 Select the subtitle language.

Press  $\triangle/\nabla$  or **SUB TITLE** repeatedly to select the desired subtitle language, then press **OK**.

- Each time you press the button, the subtitle language changes.
- The pop-up window disappears if no operation is done for about 5 seconds.

### NOTE:

When "⊗" appears on the TV screen in step **2**, subtitle language is not recorded.

## Angle Selection



You can enjoy a variety of scene angles if the DVD VIDEO disc contains "multi-angle" parts, where multiple cameras were used to shoot the same scene from different angles.

If the disc contains "multi-angle" parts, "Ⓜ" appears on the TV screen at the beginning of the "multi-angle" part when "ON SCREEN GUIDE" is set to "ON".

- During playback

### When using the on-screen bar

## 1 Access the on-screen bar.

Press **PLAY SETUP** twice. The on-screen bar appears on the TV screen.

## 2 Select the menu item.

Press  $\triangle/\nabla$  to move  $\text{Ⓜ}$  to  $\text{Ⓜ}$ , then press **OK**.

- The following pop-up window appears under the selected item.

Example: The first view angle is selected out of 3 view angles recorded.



## 3 Select the view angle.

Press  $\triangle/\nabla$  repeatedly to select the desired view angle, then press **OK**.

- Each time you press the button, the angle of the scene changes.

### To clear the on-screen bar

Press **PLAY SETUP**.

### NOTE:

When "⊗" appears on the TV screen in step **3**, the current scene is not recorded from multiple angles.

### When using the ANGLE button:

## 1 Access the menu.

Press **ANGLE**.

- The following pop-up window appears on the TV screen.

Example: The first view angle is selected out of 3 view angles recorded.

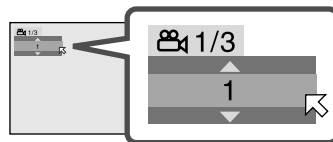

## 2 Select the view angle.

Press  $\triangle/\nabla$  or **ANGLE** repeatedly to select the desired view angle, then press **OK**.

- Each time you press the button, the angle of the scene changes.
- The pop-up window disappears if no operation is done for about 5 seconds.

Example:

1/3 → 2/3 → 3/3 → (Back to the beginning)

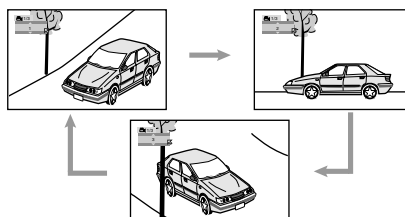

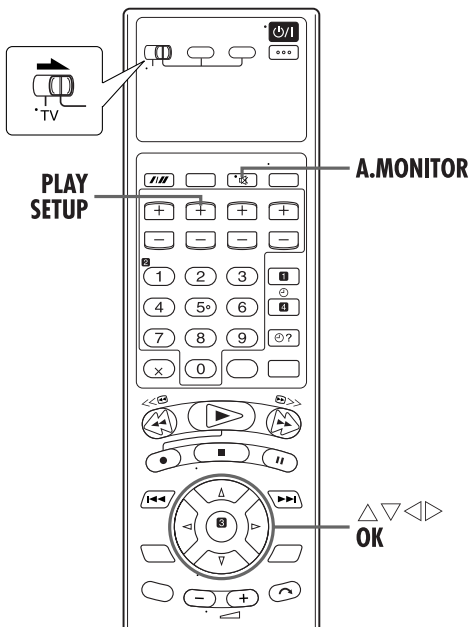

## Audio Language Selection



Some DVD discs contain multiple audio.  
You can select the audio language of movies (DVD VIDEO).  
• During playback

When using the on-screen bar

### 1 Access the on-screen bar.

Press **PLAY SETUP** twice. The on-screen bar appears on the TV screen.

### 2 Select the menu item.

Press  $\triangleleft \triangleright$  to move  $\text{Ⓞ}$  to  $\text{Ⓞ}$ , then press **OK**.  
• The following pop-up window appears under the selected item.

Example: "ENGLISH" is selected out of 4 audio languages recorded.



### 3 Select the audio language.

Press  $\triangle \nabla$  repeatedly to select the desired audio language, then press **OK**.

- Each time you press the button, the audio language changes.

To clear the on-screen bar

Press **PLAY SETUP**.

#### NOTES:

- Some audio languages are abbreviated in the pop-up window. See "Language Code List" (pg. 17).
- If "Ⓞ" appears on the TV, the current scene does not contain plural audio languages.

When using the A.MONITOR button:

### 1 Access the menu.

Press **A.MONITOR**.

- The following pop-up window appears on the TV screen.

Example: "ENGLISH" is selected out of 3 audio languages recorded.

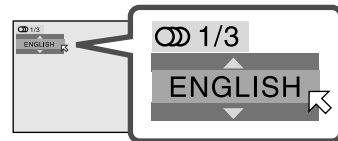

### 2 Select the audio language.

Press  $\triangle \nabla$  or **A.MONITOR** repeatedly to select the desired audio language, then press **OK**.

- Each time you press the button, the audio language changes.
- The pop-up window disappears if no operation is done for about 5 seconds.

#### NOTE:

Some audio languages are abbreviated in the pop-up window. See "Language Code List" (pg. 17).

## Audio Channel Selection



When you play certain karaoke (DVD/Video CD/SVCD), you can enjoy karaoke by selecting the audio channel to play.

- The sound of each audio channel depends on the contents of the disc.
- During playback

When using the on-screen bar

### 1 Access the on-screen bar.

Press **PLAY SETUP** twice. The on-screen bar appears on the TV screen.

### 2 Select the menu item.

Press  $\triangleleft \triangleright$  to move  $\text{⏏}$  to  $\text{Ⓞ}$ , then press **OK**.

- The following pop-up window appears under the selected item.

Example: "ST" (stereo) is selected out of 3 audio channels recorded.

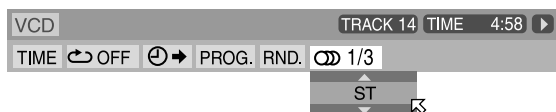

### 3 Select the audio channel.

Press  $\triangle \nabla$  repeatedly to select the desired audio channel, then press **OK**.

- Each time you press the button, the audio channel changes.

**To clear the on-screen bar**

Press **PLAY SETUP**.

When using the **A.MONITOR** button:

### 1 Access the menu.

Press **A.MONITOR**.

- The following pop-up window appears on the TV screen.

Example: "ST" (stereo) is selected out of 3 audio channels recorded.

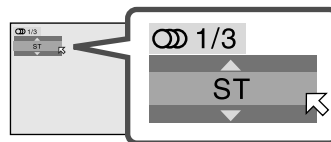

### 2 Select the audio channel.

Press  $\triangle \nabla$  or **A.MONITOR** repeatedly to select the desired audio channel, then press **OK**.

- Each time you press the button, the audio channel changes.
- The pop-up window disappears if no operation is done for about 5 seconds.

**For Video CD**

ST  $\rightarrow$  L  $\rightarrow$  R  $\rightarrow$  (Back to the beginning)

ST:	To listen to normal stereo playback.
L:	To listen to L (left) audio channel only.
R:	To listen to R (right) audio channel only.

**For SVCD**

ST 1  $\rightarrow$  ST 2  $\rightarrow$  L 1  $\rightarrow$  R 1  $\rightarrow$  L 2  $\rightarrow$  R 2  $\rightarrow$  (Back to the beginning)

ST 1/ST 2:	To listen to normal stereo playback of ST 1 or ST 2 channel.
L 1/L 2:	To listen to the L (left) 1 or 2 audio channel.
R 1/R 2:	To listen to the R (right) 1 or 2 audio channel.

# Parental Lock

This function restricts playback of DVD VIDEO discs which contain violent (and other) scenes according to the level set by the user. For example, if a movie which includes violent scenes supports the parental lock feature, such scenes which you do not want to let children view can be cut or replaced with other scenes.

- Turn on the TV and select the video channel (or AV mode).
- Slide the TV/VCR/DVD switch to the right.

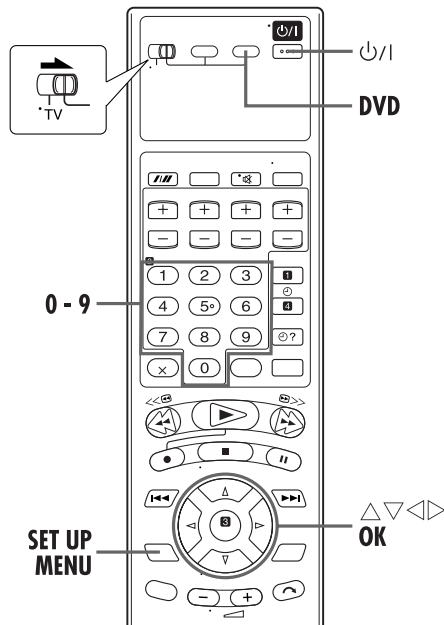

## To set Parental Lock for the first time

### 1 Turn on the unit.

Press **⏻/⏿**.

### 2 Select the DVD deck.

**On the unit**

Press **VCR/DVD** repeatedly so that the DVD indicator lights up.

**On the remote control**

Press **DVD** so that the DVD indicator lights up.

### 3 Access the DVD Set Up screen menu.

- 1 Press **SET UP MENU**.
- 2 Press **◀▶** to select "OTHERS".

### 4 Access the "PARENTAL LOCK" menu.

Press **△▽** repeatedly to move **↔** to "PARENTAL LOCK", then press **OK**.

- The "PARENTAL LOCK" sub-menu appears on the TV screen.
- It is possible to access the "PARENTAL LOCK" menu only in the stop mode when a DVD disc is loaded on the unit.

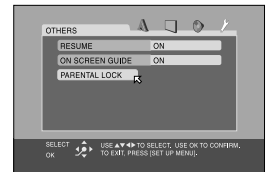

### 5 Access the country code menu.

Press **△▽** repeatedly to move **↔** to "COUNTRY CODE", then press **OK**.

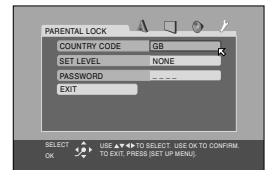

### 6 Select the country code.

Press **△▽** repeatedly to move **↔** to select the country code, then press **OK**.

- See "Country/Area Code List for Parental Lock" (pg. 46).
- The **↔** moves to "SET LEVEL".

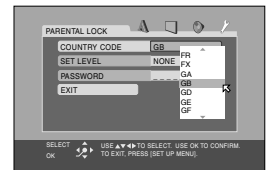

### 7 Select the Level.

Press **OK**, then press **△▽** repeatedly to move **↔** to select the level of restriction, then press **OK**.

- The **↔** moves to "PASSWORD".
- The smaller the value of level is, the more restrictive the Parental Lock level is.
- Select "NONE" to cancel this function.

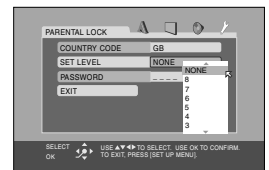

### 8 Enter the password.

Press the **number keys** to enter a 4-digit number as your password, then press **OK**.

- The **↔** moves to "EXIT".

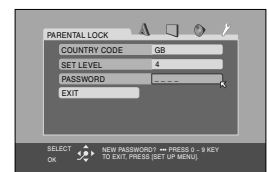

### 9 Return to the OTHERS menu screen.

Press **OK**.

- The "OTHERS" menu resumes.

**To return to the normal screen**  
Press **SET UP MENU**.

## NOTE:

Remember your password, or make a note of it.

## To change the settings

You can change the Parental lock settings later.

### 1 Access the Parental Lock screen.

- 1 Press **SET UP MENU**.
- 2 Press  $\triangleleft \triangleright$  to select "OTHERS".
- 3 Press  $\triangle \nabla$  repeatedly to move  $\rightleftarrows$  to "PARENTAL LOCK", then press **OK**.
  - The "PARENTAL LOCK" sub-menu appears on the TV screen.
  - You can only move  $\rightleftarrows$  to "PASSWORD" or to "EXIT" before you enter your password.

### 2 Enter the password.

Press the appropriate **number keys** to enter a 4-digit password, then press **OK**. If you enter the wrong password, "WRONG! RETRY..." appears at the bottom of the TV screen. Enter the correct password.



### 3 Change the country code.

Press  $\triangle \nabla$  to select the country code, then press **OK**.

- See "Country/Area Code List for Parental Lock" (pg. 46).
- When you change the country code, you must select the set level.

### 4 Change the set level.

Press  $\triangle \nabla$  to select the desired level, then press **OK**.

### 5 Enter your new password.

Press the appropriate **number keys** to enter a 4-digit password, then press **OK**.

- The password entered in this step becomes the new password. If you do not change the password, enter the same password as in the step 2.
- Even if you want to change only the country code and/or set level, do not forget to enter the password after changing the country code and/or the set level. Otherwise, the new country code and/or the set level will not become effective.

### 6 Return to the normal screen.

Press **SET UP MENU**.

#### NOTES:

- When you enter the wrong password more than 3 times in step 2 above, the arrow moves to "EXIT" automatically and  $\triangle \nabla$  do not work.
- If you forget your password, enter "8888" in step 2.

## To temporarily release the Parental Lock

When you set the parental level strictly, some discs may not be played back at all. When you insert such a disc and try to play it back, the following Parental Lock screen appears on the TV screen, asking you whether you want the Parental Lock to be temporarily released or not.

### 1 Access the password screen.

- 1 Place the disc in the disc tray.
  - If the disc rated higher than the selected set level, the following screen appears.
- 2 Press  $\triangle \nabla$  to move  $\rightleftarrows$  to "TEMPORARY RELEASE", then press **OK**.
  - If you select "NOT RELEASE", you cannot play back that disc.

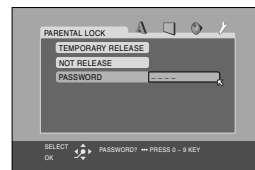

### 2 Enter the password.

Press the appropriate **number keys** to enter a 4-digit password, then press **OK**.

- If you enter the wrong password, "WRONG! RETRY..." appears on the TV screen. Enter the correct password.
- If you enter the correct password, the parental lock is released and the unit starts playback.

#### NOTES:

- When you enter the wrong password more than 3 times in step 2 above, the arrow moves to "NOT RELEASE" automatically and  $\triangle \nabla$  do not work. In such a case, press **OK**, then press  $\blacktriangle$  to remove the disc.
- If you forget your password, enter "8888" in step 2.

## Country/Area Code List for Parental Lock

AD	Andorra	ES	Spain
AE	United Arab Emirates	ET	Ethiopia
AF	Afghanistan	FI	Finland
AG	Antigua and Barbuda	FJ	Fiji
AI	Anguilla	FK	Falkland Islands (Malvinas)
AL	Albania	FM	Micronesia (Federated States of)
AM	Armenia	FO	Faroe Islands
AN	Netherlands Antilles	FR	France
AO	Angola	FX	France, Metropolitan
AQ	Antarctica	GA	Gabon
AR	Argentina	GB	United Kingdom
AS	American Samoa	GD	Grenada
AT	Austria	GE	Georgia
AU	Australia	GF	French Guiana
AW	Aruba	GH	Ghana
AZ	Azerbaijan	GI	Gibraltar
BA	Bosnia and Herzegovina	GL	Greenland
BB	Barbados	GM	Gambia
BD	Bangladesh	GN	Guinea
BE	Belgium	GP	Guadeloupe
BF	Burkina Faso	GQ	Equatorial Guinea
BG	Bulgaria	GR	Greece
BH	Bahrain	GS	South Georgia and the South Sandwich Islands
BI	Burundi	GT	Guatemala
BJ	Benin	GU	Guam
BM	Bermuda	GW	Guinea-Bissau
BN	Brunei Darussalam	GY	Guyana
BO	Bolivia	HK	Hong Kong
BR	Brazil	HM	Heard Island and McDonald Islands
BS	Bahamas	HN	Honduras
BT	Bhutan	HR	Croatia
BV	Bouvet Island	HT	Haiti
BW	Botswana	HU	Hungary
BY	Belarus	ID	Indonesia
BZ	Belize	IE	Ireland
CA	Canada	IL	Israel
CC	Cocos (Keeling) Islands	IN	India
CF	Central African Republic	IO	British Indian Ocean Territory
CG	Congo	IQ	Iraq
CH	Switzerland	IR	Iran (Islamic Republic of)
CI	Côte d'Ivoire	IS	Iceland
CK	Cook Islands	IT	Italy
CL	Chile	JM	Jamaica
CM	Cameroon	JO	Jordan
CN	China	JP	Japan
CO	Colombia	KE	Kenya
CR	Costa Rica	KG	Kyrgyzstan
CU	Cuba	KH	Cambodia
CV	Cape Verde	KI	Kiribati
CX	Christmas Island	KM	Comoros
CY	Cyprus	KN	Saint Kitts and Nevis
CZ	Czech Republic	KP	Korea, Democratic People's Republic of
DE	Germany	KR	Korea, Republic of
DJ	Djibouti	KW	Kuwait
DK	Denmark	KY	Cayman Islands
DM	Dominica	KZ	Kazakhstan
DO	Dominican Republic	LA	Lao People's Democratic Republic
DZ	Algeria	LB	Lebanon
EC	Ecuador		
EE	Estonia		
EG	Egypt		
EH	Western Sahara		
ER	Eritrea		

LC	Saint Lucia
LI	Liechtenstein
LK	Sri Lanka
LR	Liberia
LS	Lesotho
LT	Lithuania
LU	Luxembourg
LV	Latvia
LY	Libyan Arab Jamahiriya
MA	Morocco
MC	Monaco
MD	Moldova, Republic of
MG	Madagascar
MH	Marshall Islands
ML	Mali
MM	Myanmar
MN	Mongolia
MO	Macau
MP	Northern Mariana Islands
MQ	Martinique
MR	Mauritania
MS	Montserrat
MT	Malta
MU	Mauritius
MV	Maldives
MW	Malawi
MX	Mexico
MY	Malaysia
MZ	Mozambique
NA	Namibia
NC	New Caledonia
NE	Niger
NF	Norfolk Island
NG	Nigeria
NI	Nicaragua
NL	Netherlands
NO	Norway
NP	Nepal
NR	Nauru
NU	Niue
NZ	New Zealand
OM	Oman
PA	Panama
PE	Peru
PF	French Polynesia
PG	Papua New Guinea
PH	Philippines
PK	Pakistan
PL	Poland
PM	Saint Pierre and Miquelon
PN	Pitcairn
PR	Puerto Rico
PT	Portugal
PW	Palau
PY	Paraguay
QA	Qatar
RE	Réunion
RO	Romania
RU	Russian Federation
RW	Rwanda

SA	Saudi Arabia
SB	Solomon Islands
SC	Seychelles
SD	Sudan
SE	Sweden
SG	Singapore
SH	Saint Helena
SI	Slovenia
SJ	Svalbard and Jan Mayen
SK	Slovakia
SL	Sierra Leone
SM	San Marino
SN	Senegal
SO	Somalia
SR	Suriname
ST	Sao Tome and Principe
SV	El Salvador
SY	Syrian Arab Republic
SZ	Swaziland
TC	Turks and Caicos Islands
TD	Chad
TF	French Southern Territories
TG	Togo
TH	Thailand
TJ	Tajikistan
TK	Tokelau
TM	Turkmenistan
TN	Tunisia
TO	Tonga
TP	East Timor
TR	Turkey
TT	Trinidad and Tobago
TV	Tuvalu
TW	Taiwan, Province of China
TZ	Tanzania, United Republic of
UA	Ukraine
UG	Uganda
UM	United States Minor Outlying Islands
US	United States
UY	Uruguay
UZ	Uzbekistan
VA	Vatican City State (Holy See)
VC	Saint Vincent and the Grenadines
VE	Venezuela
VG	Virgin Islands (British)
VI	Virgin Islands (U.S.)
VN	Viet Nam
VU	Vanuatu
WF	Wallis and Futuna Islands
WS	Samoa
YE	Yemen
YT	Mayotte
YU	Yugoslavia
ZA	South Africa
ZM	Zambia
ZR	Zaire
ZW	Zimbabwe

## About MP3 Disc

This unit can playback CD discs recorded in the MP3 format (we refer to those discs as MP3 discs in this manual). Operations for MP3 discs are similar to those for Audio CD discs, though there are some restrictions and differences.

### What is MP3?

MP3 is the abbreviation of "MPEG1 Audio Layer 3". MPEG Audio is a compression specification that compresses the audio portion only. This image compression method is used in DVD or Video CD, etc. The audio data has been compressed into about 1/10.

On an MP3 disc, each material (song) is recorded on each Track (file), which usually belongs to a Group (folder).

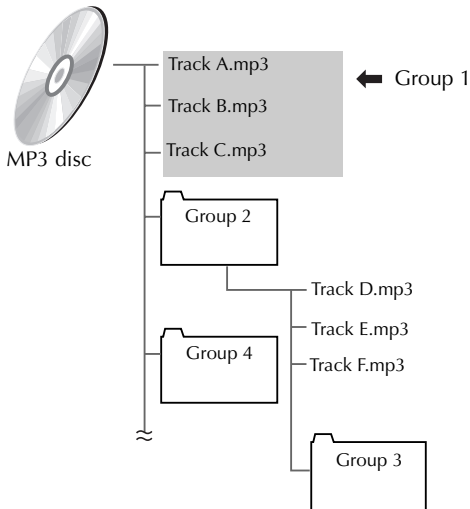

This unit can recognize up to 99 Groups and up to 150 Tracks per Group. If a disc includes more than the Tracks above limit, the unit stops detecting Tracks when the number of detected Tracks reaches the limit and ignores the subsequent Tracks. The unit also ignores any non-MP3 file on the disc.

### NOTES for making a private MP3 disc using a CD-R/CD-RW disc:

- Select "ISO 9660" as the disc format.
- Finalize the disc.

### NOTES:

- Because of the disc characteristics or recording condition, some discs may not be played back or it takes time to start playback.
- The unit does not support "packet writing" discs.
- If there are any Tracks (files) which are stored on a disc directly and do not belong to any Group (directory), the unit recognizes them as belonging to an independent Group.
- The unit plays back Groups/Tracks on an MP3 disc in the alphabetical order.
- For example, if there are three title Groups [one], [two] and [three] on a disc, the playback order is [one], [three] then [two]. Tracks in a Group are played back in the same way.
- Therefore, an MP3 disc on the market may be played back in different order from the order printed on its sleeve.

## MP3 control display

The MP3 control display appears on the TV screen and playback starts when an MP3 disc is loaded.

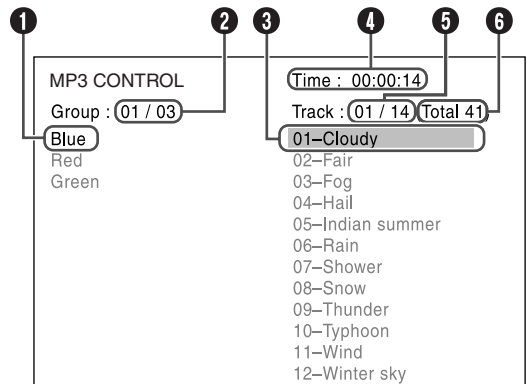

- 1 Current group
- 2 Current group number/Total group number on disc
- 3 Current track
- 4 Elapsed playing time of current track (Elapsed playing time is only shown during playback.)
- 5 Current track number/Total track number in current group
- 6 Total track number on disc



# MP3 Playback

## MP3

You can search and play back desired groups and tracks using the MP3 control display.

- Turn on the TV and select the video channel (or AV mode).
- Slide the **TV/VCR/DVD** switch to the right.

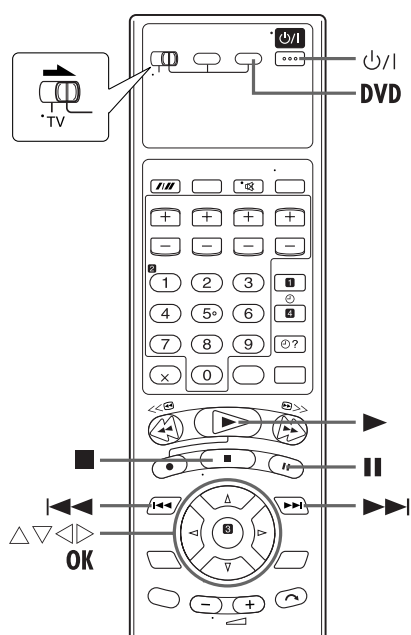
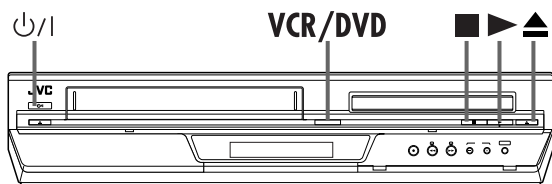

## Using the MP3 control display

### 1 Turn on the unit.

Press **⏻/I**.

### 2 Select the DVD deck.

#### On the unit

Press **VCR/DVD** repeatedly so that the DVD indicator lights up.

#### On the remote control

Press **DVD** so that the DVD indicator lights up.

### 3 Select the mode.

Be sure to set "MP3/JPEG" to "MP3" before loading a disc. (ⓘ pg. 66)

- You cannot access the DVD Set Up screen and "⊗" appears on the TV screen if a disc is already placed.

### 4 Load the disc.

1 Press **▲** on the DVD deck to open the disc tray.

2 Place the MP3 disc in the disc tray.

- For details, refer to "Placing a Disc" (ⓘ pg. 5).

3 Press **▲** on the DVD deck to close the disc tray.

- The MP3 control display appears on the TV screen when an MP3 disc is loaded. (ⓘ pg. 48)

### 5 Select the group.

Press **◀▶** to select the desired group.

### 6 Start playback.

Press **△▽** to select the desired track, then press **OK** or **▶**.

- You can skip a track across a group. Press **▶▶** to skip to the first track of the next group when the last track of the current group is selected.

### 7 Pause playback.

Press **II**.

- To resume normal playback, press **▶**.

### 8 Stop playback.

Press **■**. Press **▲** on the DVD deck to open the disc tray, then remove the disc.

## NOTES:

- **▶**, **■**, **II**, **I◀◀** and **▶▶I** buttons function the same as with Audio CD discs, however, **◀◀** and **▶▶** buttons do not function for MP3 playback.
- Resume playback, Programme playback or Random playback also does not function for MP3 playback.

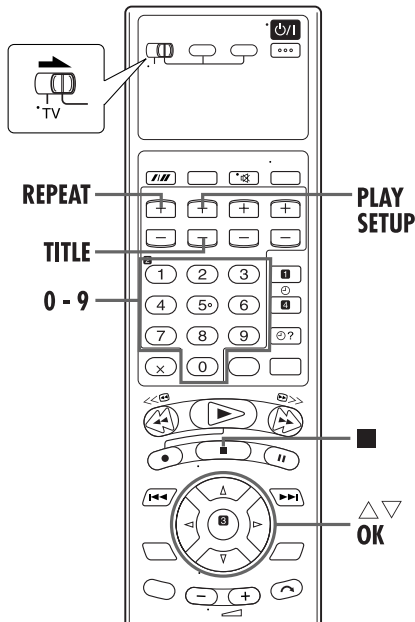

## Group/track selection

### To start playback by specifying the group/track number

- 1 Press **TITLE**.
- 2 Press the **number keys** (0-10, +10) to enter the group number.
- 3 Press the **number keys** (0-10, +10) to enter the track number.

Example:

To select 3: Press 3.

To select 14: Press +10, then 4.

To select 20: Press +10, then 10.

Or press +10 twice, then 0.

To select 24: Press +10, +10, then 4.

To select 110: Press +10 ten times, then 10.

- The entered number appears in the track number indication and playback starts from the track you have specified.

## Repeat Playback

You can repeat playback of the current group, track or all groups.

- While MP3 control display is on the TV:

### 1 Access the repeat mode.

Press **PLAY SETUP** during playback.

- The current repeat mode is displayed on the MP3 control display.

### 2 Select the mode.

Press  $\Delta$ / $\nabla$  to select the desired repeat mode, then press **OK**.

- Each time you press **REPEAT**, the mode changes as follows: TRACK→GROUP→ALL→OFF (No indication)→(Back to the beginning)

TRACK:	The current track is played back repeatedly.
GROUP:	All tracks of the current group are played back repeatedly.
ALL:	All tracks are played back repeatedly.
OFF (No indication):	Each track is played back once.

- To stop Repeat Playback, press ■.
- To cancel Repeat Playback, press **REPEAT** repeatedly until the repeat mode display disappears on the TV screen.
- You can also quit Repeat Playback in the following cases:
  - Press  $\blacktriangle$  to open the disc tray.
  - Turn off the unit.

### To return to the MP3 control display

Press ■.

# About JPEG Disc

This unit can playback CD discs recorded in the JPEG format (we refer to those discs as JPEG discs in this manual). Operations for JPEG discs are similar to those for Audio CD discs, though there are some restrictions and differences.

## What is JPEG?

JPEG is the abbreviation of "Joint Photographic Expert Group". JPEG is a still-picture data compression system.

On a JPEG disc, each still picture is recorded as a file, which usually belongs to a Group (folder).

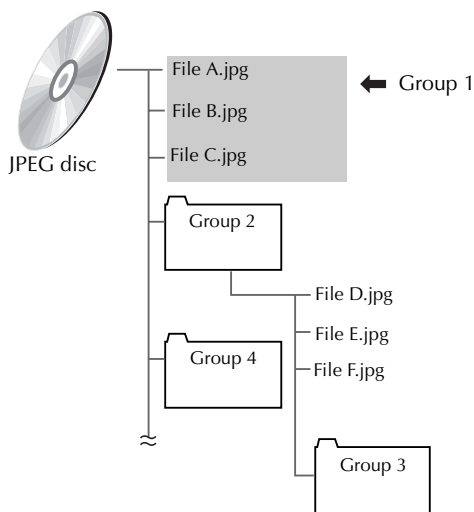

This unit can recognize up to 99 Groups and up to 150 Files per Group.

If a disc includes more than the Files above limit, the unit stops detecting Files when the number of detected Files reaches the limit and ignores the subsequent Files. The unit also ignores any non-JPEG file on the disc.

### NOTES for making a private JPEG disc using a CD-R/CD-RW disc:

- Select "ISO 9660" as the disc format.
- Finalize the disc.

## NOTES:

- We recommend to record a file at 640 x 480 resolution. (If a file has been recorded at a resolution of more than 640 x 480, it will take a longer time to be displayed.)
- This unit can only play back baseline JPEG files\*. Progressive JPEG files\* or lossless JPEG files\* cannot be played back.
  - \* Baseline JPEG format: Used for digital cameras, web, etc.
  - Progressive JPEG format: Used for web.
  - Lossless JPEG format: An old type and rarely used now.
- Some files on a JPEG disc may be played back distortedly.
- Because of the disc characteristics or recording condition, some discs may not be played back or it takes time to start playback.
- The unit does not support "packet writing" discs.
- If there are any Files which are stored on a disc directly and do not belong to any Group (directory), the unit recognized them as belonging to an independent Group.
- The unit plays back Groups/Files on a JPEG disc in the alphabetical order.
- For example, if there are three title Groups [one], [two] and [three] on a disc, the playback order is [one], [three] then [two]. Files in a Group are played back in the same way.
- Therefore, a JPEG disc on the market may be played back in different order from the order printed on its sleeve.

## JPEG control display

The JPEG control display appears on the TV screen and playback starts when a JPEG disc is loaded.

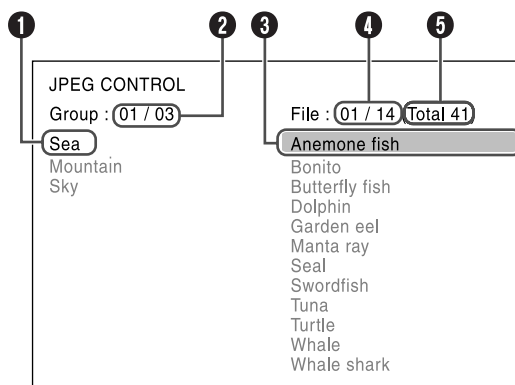

- 1 Current group
- 2 Current group number/Total group number on disc
- 3 Current file
- 4 Current file number/Total file number in current group
- 5 Total file number on disc

# JPEG Playback

## JPEG

You can search and play back desired groups and files using the JPEG control display.

- Turn on the TV and select the video channel (or AV mode).
- Slide the **TV/VCR/DVD** switch to the right.

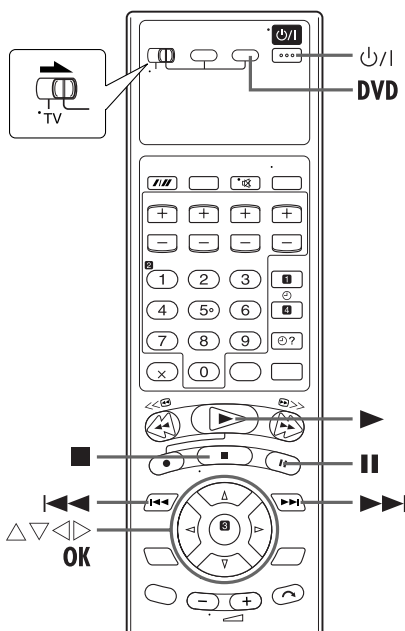
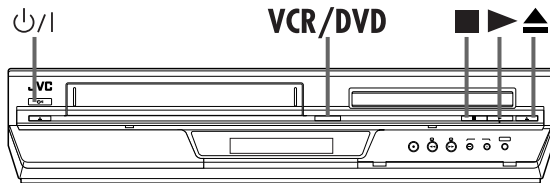

## Using the JPEG control display

### 1 Turn on the unit.

Press **P/I**.

### 2 Select the DVD deck.

#### On the unit

Press **VCR/DVD** repeatedly so that the DVD indicator lights up.

#### On the remote control

Press **DVD** so that the DVD indicator lights up.

### 3 Select the mode.

Be sure to set "MP3/JPEG" to "JPEG" before loading a disc. (☞ pg. 66)

- You cannot access the DVD Set Up screen and "⊗" appears on the TV screen if a disc is already placed.

### 4 Load the disc.

1 Press **▲** on the DVD deck to open the disc tray.

2 Place the JPEG disc in the disc tray.

- For details, refer to "Placing a Disc" (☞ pg. 5).

3 Press **▲** on the DVD deck to close the disc tray.

- The JPEG control display appears on the TV screen when a JPEG disc is loaded. (☞ pg. 51)

### 5 Select the group.

Press **◀▶** to select the desired group.

### 6 Start playback.

Press **△▽** to select the desired file, then press **OK** or **▶**.

- You can skip a file across a group. Press **▶▶|** to skip to the first file of the next group when the last file of the current group is selected.

The slide-show playback starts from the selected file.

- After selecting a file, press **▶** to start slide-show playback from the selected file, or press **OK** to show the selected file.

### 7 Pause playback.

Press **||**.

- To resume normal playback, press **▶**.

### 8 Stop playback.

Press **■**. Press **▲** on the DVD deck to open the disc tray, then remove the disc.

## NOTES:

- **▶**, **■**, **||**, **◀◀** and **▶▶|** buttons function the same as with Audio CD discs, however, **◀◀** and **▶▶** buttons do not function for JPEG playback.
- Resume playback, Programme playback or Random playback also does not function for JPEG playback.

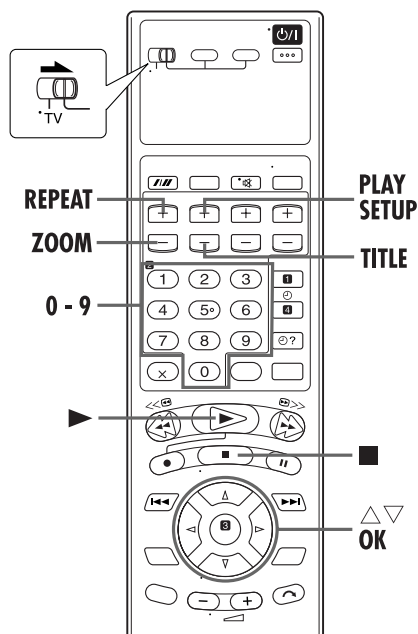

## Group/file selection

To start slide-show playback by specifying the group/file number

- 1 Press **TITLE**.
- 2 Press the **number keys** (0-10, +10) to enter the group number.
- 3 Press the **number keys** (0-10, +10) to enter the file number.

Example:

To select 3: Press 3.

To select 14: Press +10, then 4.

To select 20: Press +10, then 10.

Or press +10 twice, then 0.

To select 24: Press +10, +10, then 4.

To select 110: Press +10 ten times, then 10.

- The slide-show playback starts from the file you have specified.
- To display only the selected file, then press **OK**. To start slide-show playback from that file, press **OK** again.

## Repeat Playback

You can repeat playback of the current group, file or all groups.

- While JPEG control display is on the TV:

### 1 Access the repeat mode.

Press **PLAY SETUP** while the JPEG Control screen is displayed.

- The current repeat mode is displayed on the JPEG control display.

### 2 Select the mode.

Press  $\Delta$ / $\nabla$  to select the desired repeat mode, then press **OK**.

- Each time you press **REPEAT**, the mode changes as follows: GROUP  $\rightarrow$  ALL  $\rightarrow$  OFF (No indication)  $\rightarrow$  (Back to the beginning)

GROUP:	All files of the current group are played back repeatedly.
ALL:	All files are played back repeatedly.
OFF (No indication):	Each file is played back once.

### 3 Start playback.

Press  $\blacktriangleright$ .

- To stop Repeat Playback, press  $\blacksquare$ .
- To cancel Repeat Playback, press **REPEAT** repeatedly until the repeat mode display disappears on the TV screen.
- You can also quit Repeat Playback in the following cases:
  - Press  $\blacktriangle$  to open the disc tray.
  - Turn off the unit.

To return to the JPEG control display

Press  $\blacksquare$ .

## Zooming

Press **ZOOM** during playback.

- When you want to zoom the picture during slide-show playback, first press **II**, then press **ZOOM**.
- For details, refer to "Zooming" (pg. 33).

# Edit From A Camcorder

You can use a camcorder as the source player and your unit as the recording deck.

Slide the **TV/VCR/DVD** switch to the right.

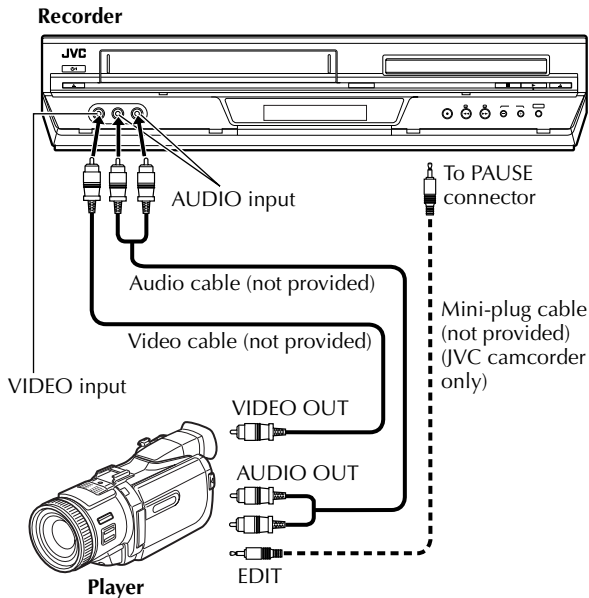

## 1 Make connections.

Connect the camcorder's AUDIO OUT and VIDEO OUT connectors to the unit's front panel AUDIO and VIDEO input connectors.

- When using a monaural camcorder, connect its AUDIO OUT connector to the AUDIO L input connector on your unit.
- When a Master Edit Control-equipped JVC camcorder is used, the camcorder is capable of controlling the unit. Refer to the camcorder's instruction manual for operating procedure.

## 2 Select the VHS deck.

**On the unit**

Press **VCR/DVD** repeatedly so that the VCR indicator lights up.

**On the remote control**

Press **VCR** so that the VCR indicator lights up.

## 3 Set the unit's input mode.

Press **AUX** (number key "0") and/or **PR** to select "F-1".

## 4 Set the edit mode.

See "PICTURE CONTROL" on page 63.

## 5 Engage the Record Pause mode.

Use **▶**, **◀◀**, or **▶▶** to locate the point where you start recording, then press and hold **II** and press **●** to engage the Record Pause mode.

## 6 Start the camcorder.

Engage the Play mode of the camcorder.

## 7 Start the unit.

Press **▶** to engage the Record mode of the unit.

### NOTES:

- All necessary cables can be obtained from your dealer.
- When you select "EDIT" to dub tapes in step 4, be sure to select "AUTO" (or "NORM" when "B.E.S.T." is set to "OFF") after you finish dubbing the tapes.

# Edit To Or From Another Video Recorder

You can use your unit as the source player or as the recording deck.

## 1 When using your unit as the source player:

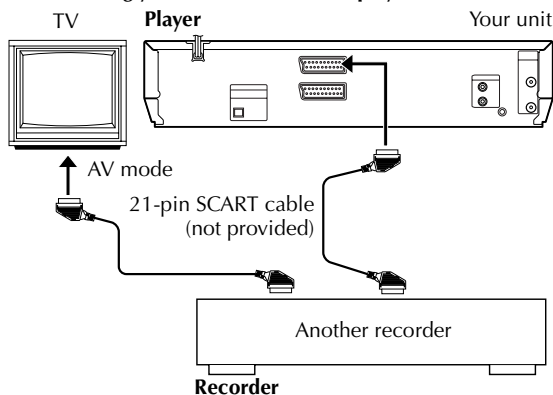

## 2 When using your unit as the recording deck:

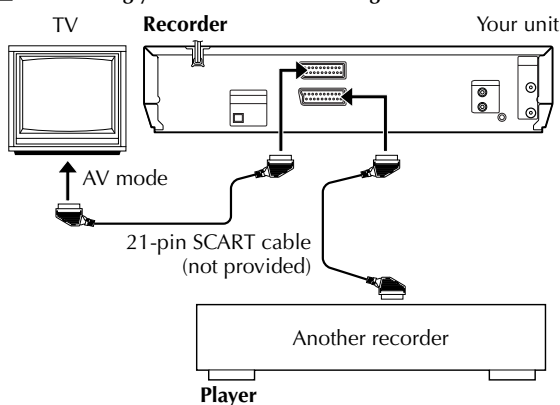

Slide the TV/VCR/DVD switch to the right.

## 1 Make connections.

Connect the player's 21-pin SCART connector to the unit's 21-pin SCART connector as illustrated.

- 1 When using your unit as the source player:
  - connect its L-1 IN/OUT connector to the recording deck.
- 2 When using your unit as the recording deck:
  - connect its L-1 IN/OUT or L-2 IN/DECODER connector to the source player.

## 2 Select the VHS deck.

**On the unit**  
Press **VCR/DVD** repeatedly so that the VCR indicator lights up.

**On the remote control**  
Press **VCR** so that the VCR indicator lights up.

## 3 Set the input mode of recording deck.

With this unit, press **AUX** (number key "0") and/or **PR** to select "L-1" for the L-1 IN/OUT connector, or "L-2" for the L-2 IN/DECODER connector, depending on the connector being used.

- When using another recorder as the recording deck, refer to its instruction manual.
- When using the L-2 IN/DECODER connector, set "L-2 SELECT" to "AV". (☞ pg. 64)

## 4 Set the edit mode.

See "PICTURE CONTROL" on page 63.

## 5 Engage the Record Pause mode of the recording deck.

Locate the point where you start recording, then engage the Record Pause mode.

## 6 Start the source player.

Engage the Play mode of the source player.

## 7 Start the recording deck.

Engage the Record mode of the recording deck.

### NOTES:

- All necessary cables can be obtained from your dealer.
- When you select "EDIT" to dub tapes in step 4, be sure to select "AUTO" (or "NORM" when "B.E.S.T." is set to "OFF") after you finish dubbing the tapes.
- When you use this unit as the source player for editing, be sure to set "O.S.D." to "OFF" before starting. (☞ pg. 63)

# Dubbing

## (from DVD to VHS)

You can dub selected scenes from the DVD disc to a cassette, starting and stopping wherever you wish.

However, it is not possible to dub copy-protected discs.

In such case, "ERROR" appears on the front display panel.

- Turn on the TV and select the video channel (or AV mode).
- Slide the TV/VCR/DVD switch to the right.

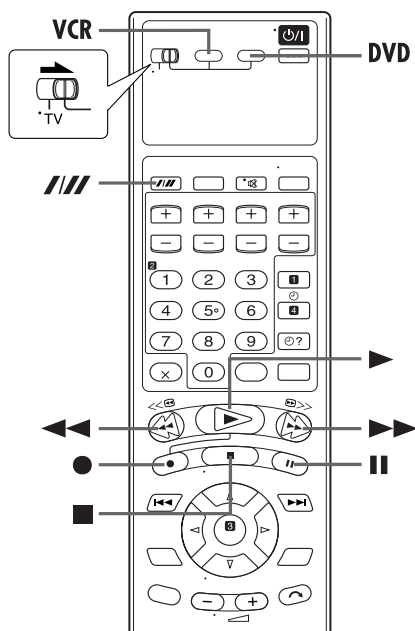

### 3 Prepare the DVD deck for dubbing.

- 1 Press **DVD**.
- 2 Start playback and search for the point where you want to start dubbing by pressing **▶**, **▶▶** or **◀◀**.

### 4 Start dubbing.

A little before the dubbing start point, press and hold **●**, then press **▶** on the remote control.

- "DUB" lights on the front display panel.



### 5 End dubbing.

Press **■**.

- Be sure to press **■** while the VCR indicator lights up on the unit.
- If you press **■** or **▲** with the DVD deck selected, the dubbing stopped, but the opening screen is also recorded.
- When you have finished dubbing, press **DVD** to select the DVD deck and press **■** to stop playback.

#### NOTES:

- Set "ON SCREEN GUIDE" to "OFF" (pg. 67) if you do not want to record the on-screen display for DVD discs during dubbing.
- There may be a discrepancy of several seconds between where you intend editing to start, and where it actually starts.
- The superimposed indication during the operation or dubbing is not recorded.
- Set "PICTURE CONTROL" to "EDIT". (pg. 63)

### 1 Load a cassette and place a disc.

#### For the VHS deck

Insert a cassette with the record safety tab intact.

#### For the DVD deck

- 1 Press **▲** on the DVD deck to open the disc tray.
- 2 Place the disc in the disc tray.
- 3 Press **▲** on the DVD deck to close the disc tray.

### 2 Prepare the VHS deck for dubbing.

- 1 Press **VCR**.
- 2 Press **///** to select recording speed.
- 3 Search for the point where you want to start dubbing by pressing **▶**, **▶▶** or **◀◀** then press **■**.



# Digital Audio Dubbing

- Turn on the TV and select the video channel (or AV mode).
- Slide the TV/VCR/DVD switch to the right.

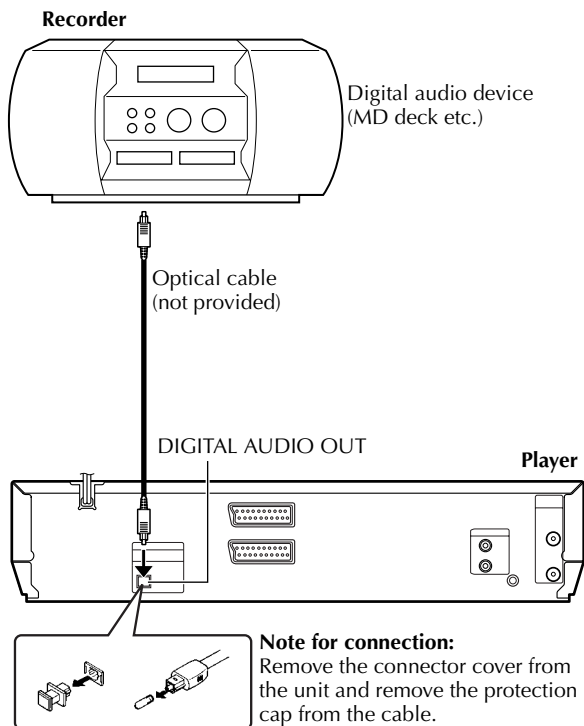

You can dub selected audio from the DVD or Audio CD disc to an MD etc.

However, it is not possible to dub copy-protected discs.

**Example: Dubbing to an MD**

## 1 Make connections.

Connect the optical cable between the unit and the digital audio device.

## 2 Place a disc and load an MD.

**For the DVD deck**

- 1 Press **▲** on the DVD deck to open the disc tray.
- 2 Place the disc in the disc tray.
- 3 Press **▲** on the DVD deck to close the disc tray.

**For the digital audio device**

Insert an MD.

## 3 Prepare the DVD deck for dubbing.

- 1 Press **DVD** and select the audio to be dubbed.
- 2 Search for the point where you want to start dubbing by pressing **▶**, **▶▶** or **◀◀** then press **■**.
- 3 Press **◀◀** a little, then press **▶** to start playback.
- 4 Press **||** to pause playback a little before the start point.

## 4 Prepare the audio device for dubbing.

Select the input mode.

## 5 Start dubbing.

- 1 Press **▶** to start playback on the DVD deck.
- 2 Start recording on the audio device.

## 6 End dubbing.

Stop recording on the audio device. Then press **■** to stop playback on the DVD deck.

### NOTES:

- There may be a discrepancy of several seconds between where you intend editing to start, and where it actually starts.
- You can also dub audio from a Video CD or SVCD. Set "DIGITAL AUDIO OUTPUT" to "PCM ONLY". (pg. 66)

# Remote Control Functions

## Remote A/B/C/D Code Switching

The remote control is capable of controlling four JVC video units independently. Each of the units can respond to one of four codes (A, B, C or D). The remote control is preset to send A code signals because your unit is initially set to respond to A code signals. You can easily modify your unit to respond to B, C or D code signals.

**Before performing the following steps:**  
Slide the TV/VCR/DVD switch to the right.

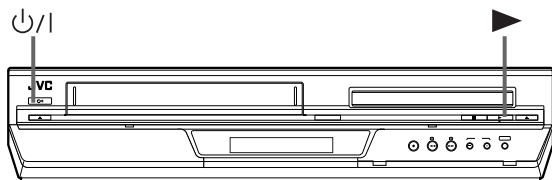
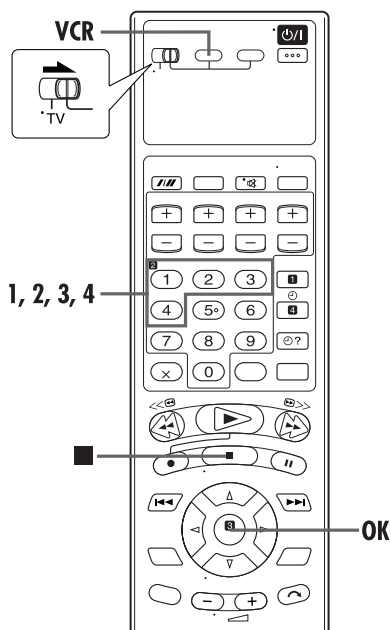

### On the remote control

Keep pressing **VCR** down during steps **1** – **2**.

#### **1** Change the remote control code.

Press the **number key "1"** for A, **"2"** for B, **"3"** for C or **"4"** for D.

#### **2** Set the remote control code.

Press **OK** to set the code.

### On the unit

#### **3** Turn off the unit.

Press **⏻/I**.

#### **4** Display the code.

Press **▶** on the unit for over 5 seconds while the unit is turned off. The code currently set appears on the front display panel.

- If the code displayed on the front display panel is different from the code set on the remote control, go to step **5**.

#### **5** Change the unit's code.

Press **■** on the remote control. The code currently set on the remote control will be applied to the unit.

#### **NOTE:**

When "POWER SAVE" is set to "ON" (pg. 64), it is impossible to change the remote code.

## TV Multi-Brand Remote Control

Your remote control can operate the basic functions of your TV set. In addition to JVC TVs, other manufacturer's TVs can also be controlled.

### Before performing the following steps:

- Turn off the TV using its remote control.
- Slide the **TV/VCR/DVD** switch to the left.

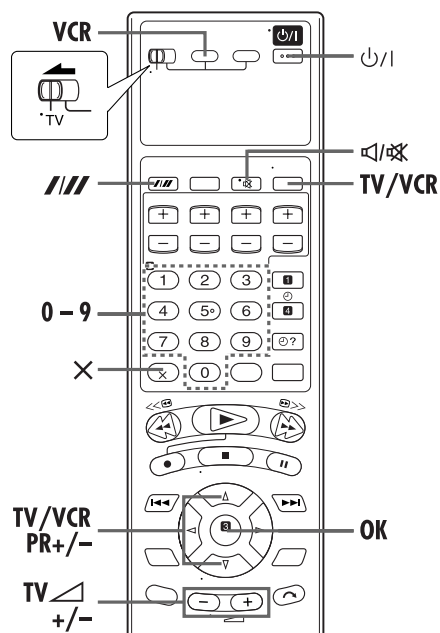

### IMPORTANT

Although the provided remote control unit is compatible with JVC televisions, as well as many other models, it may not work with your TV, or in some instances, may have limited function capability.

### Control Your TV Using Additional Buttons

Use the **number keys**, and the **///** button or **X** button to select the TV's channel.

- With televisions under Code 01, 02, 07, 10, 11, 14, 20, 23, 24, 25, 27, 33 or 35, the **///** button corresponds to the 1-digit/2-digit entry switching button (often labelled - / -) of your TV's remote control.
- With televisions under Code 01, 28, 29 or 34, the **X** button corresponds to the 10 + button of your TV's remote control.

### NOTE:

The way these buttons are used is determined by your TV. Use these buttons as instructed for your TV's remote control.

## 1 Set the TV brand code.

Keep pressing **VCR** down during step **1**.

Enter your TV's brand code using the **number keys**, then press **OK**.

Press **⏻** on the unit's remote control to turn on the TV and try operations (→ step **2**).

- Once you have set the remote control to operate the TV, you do not have to repeat this step until you replace your remote control's batteries.
- Some brands of TVs have more than one code. If the TV does not function with one code, try entering another.

## 2 Operate the TV.

Press the corresponding button: **⏻**, **TV/VCR**, **TV/VCR PR +/-**, **TV  $\triangle$  +/-** (Volume), **🔊** (TV Muting), **number keys**.

- For some brands of TVs, you must press **OK** after having pressed the **number keys**.

BRAND NAME	CODE
JVC	01, 23, 24, 25
BLAUPUNKT	19
BRANDT	26
FERGUSON	27
FINLUX	30
FUNAI	32
LG/GOLDSTAR	18
GRAETZ	28
GRUNDIG	19
HITACHI	10
ITT	28
LUXOR	28
MITSUBISHI	03
MIVAR	29
NEC	20
NOKIA	31
NORDMENDE	26
PANASONIC	11
PHILIPS	02
SABA	26
SALORA	28
SAMSUNG	02, 12, 33, 34, 35
SELECO	28
SHARP	06
SONY	07
TELEAVIA	26
TELEFUNKEN	26
THOMSON	26
TOSHIBA	14

# Connecting To A Satellite Receiver

## Simple Connections

This is an example of a simple connection if your TV has one 21-pin AV input (SCART) connector.

Connect the satellite receiver to the L-2 IN/DECODER connector, then connect the L-1 IN/OUT connector to the TV's connector.

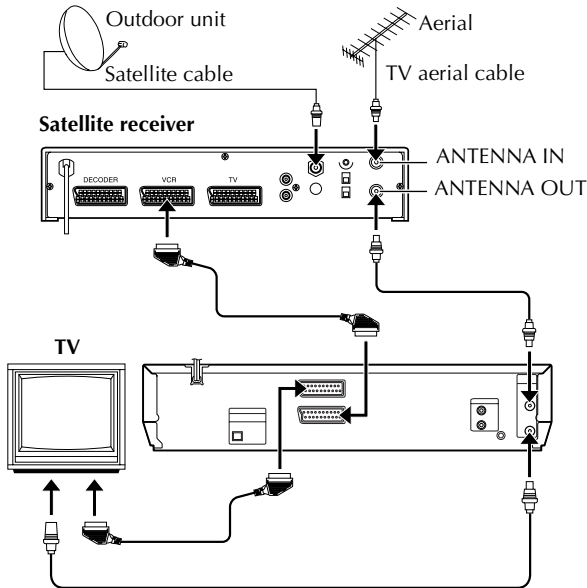

### IMPORTANT

When you set "L-2 SELECT" to "SAT" (☞ pg. 64), it is possible to view a satellite broadcast with the TV set to its AV mode even if the unit is turned off. When the unit is in Stop mode or recording, press **TV/VCR** on the remote control to turn off the VCR indicator on the front display panel.

- If you turn on the unit when the satellite receiver's power is off, nothing appears on the TV screen. In this case, turn on the satellite receiver, or set the TV to its TV mode, or press **TV/VCR** on the remote control to set the unit to the video mode.

### NOTES:

- Set "L-2 SELECT" to "AV". (☞ pg. 64)
- You can use the Automatic Satellite Programme Recording function (☞ pg. 28) with this connection. (VHS deck only)
- To record a programme via the satellite receiver, select L-2 mode by pressing **AUX (number key "0")** and/or **PR** so that "L-2" appears on the front display panel. (VHS deck only)
- For details, refer to the instruction manual of the satellite receiver.

## Perfect Connections

This is an example of recommended connections if your TV has two 21-pin AV input (SCART) connectors.

Connect the decoder to the satellite receiver's connector if you have a decoder, L-1 IN/OUT connector to TV's connector, and L-2 IN/DECODER connector to the satellite receiver and TV.

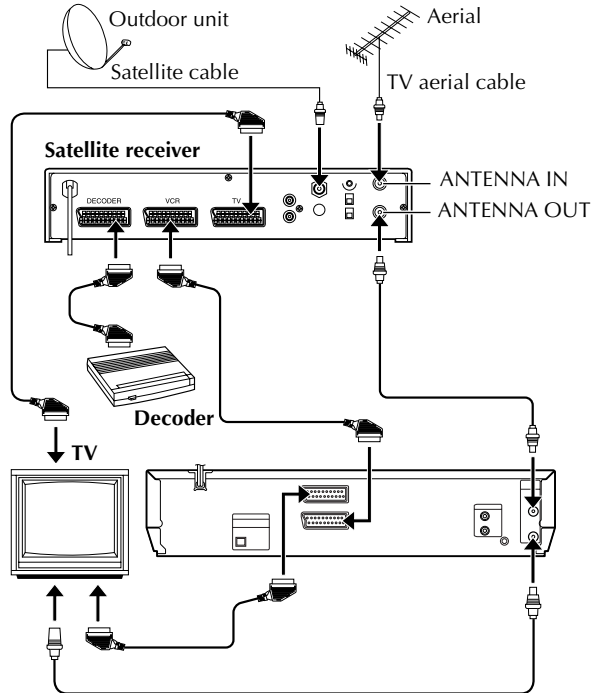

### NOTES:

- Set "L-2 SELECT" to "AV". (☞ pg. 64)
- You can use the Automatic Satellite Programme Recording function (☞ pg. 28) with this connection. (VHS deck only)
- To record a programme via the satellite receiver, select L-2 mode by pressing **AUX (number key "0")** and/or **PR** so that "L-2" appears on the front display panel. (VHS deck only)
- To receive a scrambled broadcast, descramble the signal with the decoder connected to the satellite receiver.
- For details, refer to the instruction manual of the satellite receiver and decoder.

## Connecting/Using A Decoder

The L-2 IN/DECODER connector can be used as an input connector for an external decoder (descrambler). Simply connect a decoder and you can enjoy the variety of programming that is available through scrambled channels.

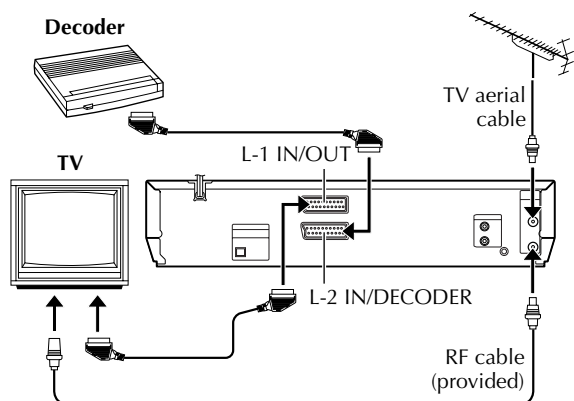

## Connecting To A Dolby Digital Decoder or An Amplifier With A Built-in DTS (DVD deck only)

These instructions enable you to connect your unit to a Dolby Digital Decoder or an amplifier with built-in DTS.

### Make connections.

Connect the optical cable between the unit and the Dolby Digital Decoder or amplifier with a built-in DTS.

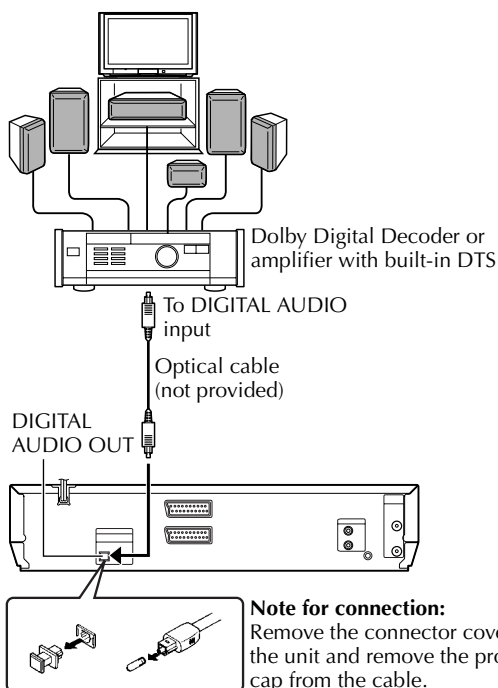

### 1 Select the input mode.

Set "L-2 SELECT" to "DECODER". (☞ pg. 64)

### 2 Connect the decoder.

Connect your unit's L-2 IN/DECODER connector to the decoder's 21-pin SCART connector using a 21-pin SCART cable.

### 3 Set the tuner.

Perform the procedure as described in "When Receiving A Scrambled Broadcast" on page 70.

### NOTES:

- For Dolby Digital sound, set "DIGITAL AUDIO OUTPUT" to "DOLBY DIGITAL/PCM". (☞ pg. 66)
- For DTS sound, set "DIGITAL AUDIO OUTPUT" to "STREAM/PCM". (☞ pg. 66)

### CAUTIONS:

- This unit has a dynamic range of more than 80 dB with regards to its Hi-Fi audio capability. It is recommended that you check the maximum level if you are going to listen to the Hi-Fi audio signals through a stereo amplifier. A sudden surge in the input level to the speakers may damage them.
- Some speakers and televisions are specially shielded to prevent television interference. If both are of the non-shielded type, do not place the speakers adjacent to the TV set as this can adversely affect the video playback picture.

# Mode Set (VHS deck)

You can change various mode settings on the Mode Set screen by following the procedure described below.

- For each mode setting, see pages 63 to 64.

- Turn on the TV and select the video channel (or AV mode).
- Slide the TV/VCR/DVD switch to the right.

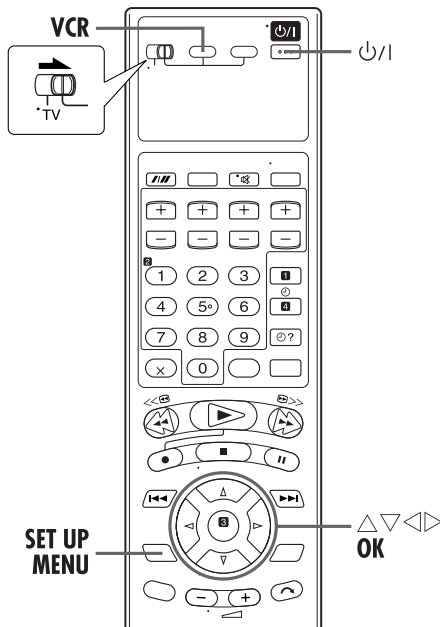

## 1 Turn on the unit.

Press  $\text{power}$ .

## 2 Select the VHS deck.

**On the unit**

Press **VCR/DVD** repeatedly so that the VCR indicator lights up.

**On the remote control**

Press **VCR** so that the VCR indicator lights up.

## 3 Access the Main Menu screen.

Press **SET UP MENU**.

## 4 Access the Mode Set screen.

Press  $\Delta$ / $\nabla$  to move the highlight bar (pointer) to "MODE SET", then press **OK** or  $\triangleright$ .

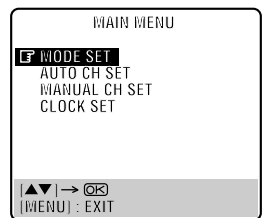

## 5 Select the mode.

Press  $\Delta$ / $\nabla$  to move the highlight bar (pointer) to the item you want to change.

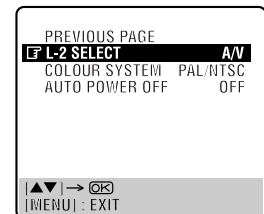
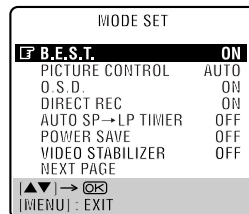

## 6 Select the mode setting.

Press **OK** or  $\triangleright$ .

## 7 Return to the normal screen.

Press **SET UP MENU**.

\* The default setting is **bold** in the table below.

### ■ B.E.S.T. — ON / OFF

You can set the B.E.S.T. (Biconditional Equalised Signal Tracking) system to "ON" or "OFF". (☞ pg. 23)

#### NOTES:

- When watching a tape recorded with "B.E.S.T." set to "ON", it is recommended that you leave B.E.S.T. on during playback as well.
- When watching a rental tape or one recorded on another video recorder, or when using this unit as the player for editing, set B.E.S.T. to your preference.
- The B.E.S.T. system works for both SP and LP modes only after a tape has been inserted and the Record mode is first initiated. It does not work during recording.
- The B.E.S.T. system does not work while Automatic Satellite Programme Recording is in progress. (☞ pg. 28)
- In the case of timer recordings, the B.E.S.T. system works before recording is initiated.
- Once the cassette is ejected, the B.E.S.T. data is cancelled. The next time the cassette is used for recording, B.E.S.T. is re-performed.
- Pressing the unit's ● button while "BEST" is displayed does not start Instant Timer Recording. (☞ pg. 22)

### ■ PICTURE CONTROL— AUTO / EDIT / SOFT

This feature helps you to adjust the playback picture quality according to your preference. Normally select "AUTO".

**AUTO:** Provides the optimised picture benefits of the B.E.S.T. Picture System.

**EDIT:** Minimizes picture degradation during editing (recording and playback).

**SOFT:** Reduces image coarseness when viewing overlaid tapes containing a lot of noise.

#### NOTES:

- When you select "EDIT" or "SOFT", the selected mode will not change until you select another mode.
- When you select "EDIT" to dub tapes, be sure to select "AUTO" after you finish dubbing the tapes.
- When "B.E.S.T." is "OFF", "PICTURE CONTROL" switches automatically from "AUTO" to "NORM".

### ■ O.S.D. — ON / OFF

When this function is set to "ON", various operational indicators appear on the TV screen. Messages appear in the selected language. (☞ pg. 10, 15)

#### NOTES:

- When you use this unit as the source player for editing, be sure to set "O.S.D." to "OFF" before starting.
- During playback, the operation mode indicators may be disturbed depending on the type of tape being used.

### ■ DIRECT REC — ON / OFF

When this function is set to "ON", you can easily start recording the programme that you are watching on your TV. Press and hold ● and press ► on the remote control, or press ● on the unit.

#### NOTES:

- When you use the Direct Rec function, be sure to use a TV offering T-V LINK, etc. and connect a fully-wired 21-pin SCART cable between the unit and the TV. (☞ pg. 9)
- If "DIRECT REC" is set to "OFF", the ● button functions as described in "Basic Recording" (☞ pg. 21).
- During Direct Rec, "—" appears on the front display panel.
- When "DIRECT REC" is set to "ON", if you press any button just after pressing ● on the unit (or ● and ► on the remote control), the unit may not function properly.

### ■ AUTO SP→LP TIMER — ON / OFF

When this function is set to "ON", the unit automatically switches to LP mode to allow complete recording if there is not enough tape to record the entire programme while timer-recording in SP mode.

#### For Example:

Recording a programme of 210 minutes in length onto a 180-minute tape

Approximately 150 minutes	Approximately 60 minutes
SP mode	LP mode
Total 210 minutes	

Make sure you set this function to "ON", before the timer-recording starts.

#### NOTES:

- If you have programmed the unit to timer-record 2 or more programmes, the second programme and those thereafter may not fit on the tape if you set "AUTO SP→LP TIMER" to "ON". In this case, make sure the mode is not engaged, then set the tape speed manually during timer programming.
- In order to ensure that the recording fits on the tape, this feature may leave a slight non-recorded section at the end of the tape.
- There may be some noise and sound disturbance at the point on the tape where the unit switches from SP to LP mode.
- The Auto SP→LP Timer feature is not available during ITR (Instant Timer Recording), and the feature will not work properly with any tapes longer than E-180, or with some tapes of shorter lengths.
- If you perform timer recording with both VPS/PDC and the Auto SP→LP Timer activated, and the programme goes beyond its originally scheduled length, there may be times when the programme cannot be recorded in its entirety.

**POWER SAVE — ON / OFF**

When this function is set to "ON", you can reduce the power consumption while the unit is turned off.

**NOTES:**

- During Power Save mode:
  - the front display panel will be turned off.
  - the Just Clock function (☞ pg. 75) does not work.
  - the picture may be distorted momentarily when you turn on/off the unit.
- Power Save does not work when:
  - the unit is in the Timer mode.
  - the unit's power is turned off after timer-recording or Instant Timer Recording.
  - the Automatic Satellite Programme Recording mode is engaged. (☞ pg. 28)
  - "L-2 SELECT" is set to "DECODER" or "SAT". (☞ pg. 64)

**VIDEO STABILIZER — ON / OFF**

When this function is set to "ON", you can automatically correct vertical vibration in the picture when playing back unstable recordings made on another recorder.

**NOTES:**

- When you finish viewing a tape, be sure to set this function to "OFF".
- Regardless of the setting, this function has no effect during recording and during special effects playback.
- The on-screen display may jitter vertically when this function is set to "ON".
- To watch recordings with close-caption, set this function to "OFF".

**L-2 SELECT — A/V / DECODER / SAT**

Set "L-2 SELECT" to the appropriate mode depending on the type of appliance connected to the unit's L-2 IN/DECODER connector.

**A/V:** To use this unit as the recording deck with the player connected to the L-2 IN/DECODER connector, or to use the satellite receiver connected to the L-2 IN/DECODER connector.

**DECODER:** To use a decoder connected to the L-2 IN/DECODER connector.

**SAT:** To view a satellite programme with the TV set while the unit is turned off. (☞ pg. 60)

**NOTES:**

- If you have a satellite receiver or a decoder connected to the L-2 IN/DECODER connector, be sure to set "L-2 SELECT" back to the appropriate mode after editing.
- If you are not connecting a satellite receiver or a decoder to the L-2 IN/DECODER connector, leave "L-2 SELECT" set to "A/V".
- When "L-2 SELECT" is set to "SAT", "SAT" appears on the TV screen or front display panel instead of "L-2".

**COLOUR SYSTEM — PAL/NTSC / MESECAM**

You can play back PAL, NTSC and MESECAM tapes, or record PAL and SECAM\* signals on this unit. Select the appropriate colour system.

\* SECAM signals will be recorded as MESECAM on this unit; MESECAM is the designation for tapes with SECAM signals that have been recorded on a MESECAM-compatible PAL video cassette recorder.

**PAL/NTSC:** To record PAL signals, or play back a PAL or NTSC tape.

**MESECAM:** To record SECAM signals, or play back a MESECAM tape.

**NOTES:****About NTSC Playback**

- Some TVs shrink the picture vertically and place black bars at the top and bottom of the TV screen. This is not a malfunction on the part of either the unit or the TV.
- The picture may roll up and down. This can be corrected using the V-HOLD control found on some TVs. (This cannot be corrected if the TV does not have a V-HOLD control.)
- The counter and tape remaining time readings will be incorrect.
- During search, still, or frame-by-frame playback, the picture will be distorted, and there may be a loss of colour.
- Depending on the type of TV, the top and bottom portions of superimposed displays may be cut off during NTSC playback.

**AUTO POWER OFF — 3H / OFF**

When this function is set to "3H", the unit is turned off automatically if no operation is done within 3 hours. "AUTO POWER OFF IN 3 MIN" appears on the screen 3 minutes before the unit is turned off.



# Mode Set (DVD deck)

You can change various mode settings on the Mode Set screen by following the procedure described below.

- For each mode setting, see pages 66 to 67.

<b>LANGUAGE</b>	MENU LANGUAGE (pg. 16) AUDIO LANGUAGE (pg. 16) SUBTITLE (pg. 16) ON SCREEN LANGUAGE (pg. 16)
<b>PICTURE</b>	MONITOR TYPE (pg. 14) PICTURE SOURCE (pg. 66) SCREEN SAVER (pg. 66) MP3/JPEG (pg. 66)
<b>AUDIO</b>	DIGITAL AUDIO OUTPUT (pg. 66) ANALOG DOWN MIX (pg. 66) D. RANGE CONTROL (pg. 66) OUTPUT LEVEL (pg. 66)
<b>OTHERS</b>	RESUME (pg. 67) ON SCREEN GUIDE (pg. 67) PARENTAL LOCK (pg. 44)

- Turn on the TV and select the video channel (or AV mode).
- Slide the **TV/VCR/DVD** switch to the right.

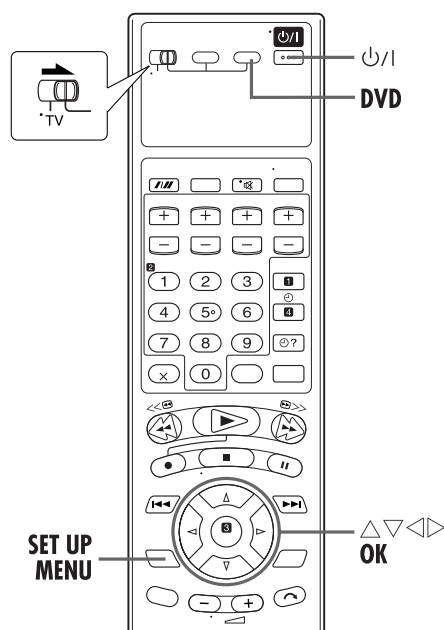

- The procedure shows how to set "RESUME" to "ON" on the DVD Set Up menu screen as an example.

## 1 Turn on the unit.

Press **p/i**.

## 2 Select the DVD deck.

### On the unit

Press **VCR/DVD** repeatedly so that the DVD indicator lights up.

### On the remote control

Press **DVD** so that the DVD indicator lights up.

## 3 Access the DVD Set Up menu screen.

1 Press **SET UP MENU**.

2 Press **◀▶** to select "OTHERS".

- Each time you press the button, the setup menus change as follows;

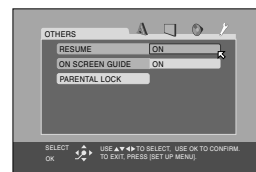

**LANGUAGE** → **PICTURE** → **AUDIO** → **OTHERS**  
→ (Back to the beginning)

## 4 Select the mode.

Press **△▽** to move **RESUME** to "RESUME", then press **OK**.

## 5 Select the mode setting.

Press **△▽** to select "ON", then press **OK**.

## 6 Return to the normal screen.

Press **SET UP MENU**.

\* The default setting is **bold** in the table below.

## Picture Settings

### ■ MONITOR TYPE —

16:9 NORMAL / 16:9 AUTO / **4:3 LB** / 4:3 PS

You can select the monitor type depending on the TV used when you play back DVD VIDEO discs recorded for wide-screen TVs. For more details, refer to "Monitor Set (DVD deck)" (pg. 14).

### ■ PICTURE SOURCE —

VIDEO (NORMAL) / VIDEO (ACTIVE) / FILM / **AUTO**

You can obtain optimal picture quality by selecting whether the content on the disc is processed by field (video source) or by frame (film source).

Normally set to "AUTO".

**VIDEO (NORMAL)**: Suitable for playing back a video source disc with relatively a few movements.

**VIDEO (ACTIVE)**: Suitable for playing back a video source disc with relatively a lot of movements.

**FILM**: Suitable for playing back a film or progressive source disc.

**AUTO**: Used to play back a disc containing both video and film source materials. This unit recognizes the picture type (film or video source) of the current disc according to the disc information.

- If the playback picture is unclear or noisy, or the oblique lines of the picture are rough, try to change to other modes.

### ■ SCREEN SAVER — ON / OFF

The TV screen may be burned out if a static picture is displayed for a long time. When this function is set to "ON", the unit automatically activates the screen saver function if a static picture, such as an on-screen display or menu is displayed for over 5 minutes.

### NOTE:

This function is not available for Audio CDs and MP3 discs.

### ■ MP3/JPEG — MP3 / JPEG

You can select files to play back, when both MP3 files and JPEG files are recorded on a disc.

**MP3**: Select this to play back MP3 files.

**JPEG**: Select this to play back JPEG files.

### NOTE:

You cannot access the DVD Set Up screen and "⊙" appears on the TV screen if a disc is already placed.

## Audio Settings

### ■ DIGITAL AUDIO OUTPUT —

PCM ONLY / DOLBY DIGITAL/PCM / **STREAM/PCM**

Set to the appropriate mode according to the type of the device connected to DIGITAL AUDIO OUT connector on the rear of unit.

It is not necessary to set this mode when you connect no device to the DIGITAL AUDIO OUT connector.

**PCM ONLY**: Select this when you connect the unit's DIGITAL AUDIO OUT connector to the linear PCM digital input connector of another audio device.

**DOLBY DIGITAL/PCM**: Select this when you connect the unit's DIGITAL AUDIO OUT connector to the digital input connector of a Dolby Digital decoder or an amplifier with a built-in Dolby Digital decoder.

**STREAM/PCM**: Select this when you connect the unit's DIGITAL AUDIO OUT connector to the digital input connector of an amplifier with a built-in DTS, Dolby Digital, or MPEG multichannel decoder.

### ■ ANALOG DOWN MIX — DOLBY SURROUND / STEREO

Set to the appropriate mode according to your audio system when you play back a DVD VIDEO disc recorded with surround multichannel audio. This setting affects only the analogue audio output signal from the AUDIO OUT connectors when playing back a DVD VIDEO disc recorded with surround multichannel audio.

**DOLBY SURROUND**: Select this when you enjoy multichannel surround audio by connecting the unit's analogue AUDIO OUTPUT connectors (DVD) to a surround decoder or an internal amplifier.

**STEREO**: Select this when you enjoy conventional 2-channel stereo audio by connecting the unit's analogue AUDIO OUTPUT connectors (DVD) to a stereo amplifier/receiver or TV, or when you dub audio of a DVD VIDEO disc recorded with surround audio to your MD, cassette, etc.

### NOTE:

The "ANALOG DOWN MIX" function does not work when the 3D Phonic function is activated. (pg. 33)

### ■ D. RANGE CONTROL —

WIDE RANGE / **NORMAL** / TV MODE

The dynamic range (the difference between the loudest sound and the quietest one) can be compressed during playback of a programme encoded in Dolby Digital format.

This function takes effect when a DVD VIDEO disc recorded in Dolby Digital format is played back at low or middle volume.

**WIDE RANGE**: Select this to inactivate this function when you enjoy wide dynamic range programme.

**NORMAL**: Normally select this setting to activate this function.

**TV MODE**: Select this when you hear the sound through the TV's speaker(s).

### NOTES:

- This function works only when playing back a disc recorded with Dolby Digital format. The setting is not effective for other discs.
- This function does not work when the 3D Phonic function is activated. (pg. 33)

### ■ OUTPUT LEVEL — STANDARD / LOW

You can lower the output level of analog audio to accommodate the unit to the connected A/V equipment.

**STANDARD**: Normally select this.

**LOW**: The output level of analog audio is lowered.

Playback discs	Output		
	STREAM/PCM	DOLBY DIGITAL/PCM	PCM ONLY
DVD VIDEO with 48 kHz, 16/20/24 bit linear PCM	48 kHz, 16 bit linear PCM		
DVD VIDEO with DTS	DTS bitstream	44.1 kHz, 16 bit stereo linear PCM	
DVD VIDEO with Dolby Digital	Dolby Digital bitstream		48 kHz, 16 bit stereo linear PCM
Audio CD/Video CD	44.1 kHz, 16 bit stereo linear PCM		
Audio CD with DTS	DTS bitstream	44.1 kHz, 16 bit stereo linear PCM	
MP3 disc	Linear PCM		

## NOTES:

- The unit is not equipped with the DTS decoding function.
- When you play back a DVD VIDEO or Audio CD disc with DTS, use a DTS decoder to get correct signals from your speakers. Never use the unit's analog output connectors, which output incorrect signals that may damage your speakers.
- If you connect the analog outputs and digital outputs simultaneously, be sure to select the source of the amplifier correctly, or set the level control of the amplifier connected to the analog outputs to minimum.

## Others Settings

### ■ RESUME — ON / OFF / DISC RESUME

When this function is set to "ON", you can use the resume function. (☞ pg. 32)

**ON:** You can start playback from the resume point of the placed disc.

**OFF:** You cannot use the resume function.

**DISC RESUME:** The unit retains a memory of the resume points of the last 30 discs played back, even though they have been ejected.

### NOTE:

This function is not available for Audio CDs and MP3 discs.

### ■ ON SCREEN GUIDE — ON / OFF

When this function is set to "ON", the unit can display "on-screen guide" icons or characters which show the conditions of the unit or disc.

# Tuner Set

## IMPORTANT

Perform the following steps only if —  
 — Auto Channel Set has not been set correctly by Auto Set Up or by Preset Download. (pg. 10, 12)  
 — you have moved to a different area or if a new station starts broadcasting in your area.

Your unit needs to memorize all necessary stations in channel positions in order to record TV programmes. Auto Channel Set automatically assigns all receivable stations in your area to call them up by using the **PR** buttons without going through any vacant channels.

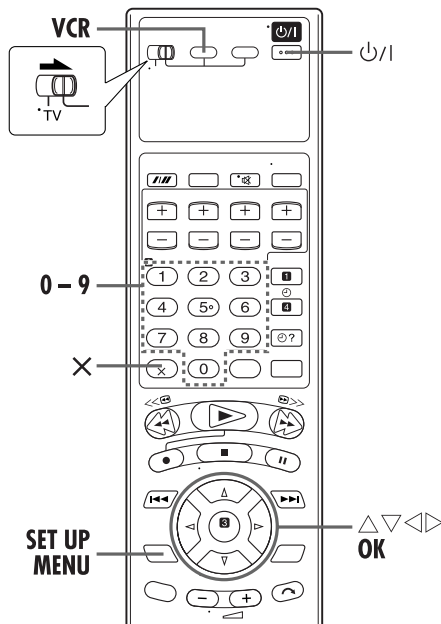

- Turn on the TV and select the video channel (or AV mode).
- Slide the TV/VCR/DVD switch to the right.

## Auto Channel Set

### 1 Turn on the unit.

Press **P/I**.

### 2 Select the VHS deck.

**On the unit**

Press **VCR/DVD** repeatedly so that the VCR indicator lights up.

**On the remote control**

Press **VCR** so that the VCR indicator lights up.

### 3 Access the Main Menu screen.

Press **SET UP MENU**.

### 4 Access the Auto Channel Set screen.

Press  $\Delta$ / $\nabla$  to move the highlight bar (pointer) to "AUTO CH SET", then press **OK** or  $\triangleright$ .

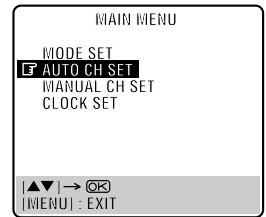

### 5 Select your country.

Press  $\Delta$ / $\nabla$  to move the highlight bar (pointer) to your country's name, then press **OK** or  $\triangleright$ .

### 6 Select the language.

Press  $\Delta$ / $\nabla$  to move the highlight bar (pointer) to the language of your choice.

### 7 Perform Auto Channel Set.

Press **OK** twice.

- When you have connected the unit to a TV offering T-V Link via a fully-wired 21-pin SCART cable (pg. 9), the unit automatically performs the Preset Download and the T-V LINK screen will appear. (pg. 12)
- The Auto Set screen appears, and remains on screen while the unit searches for receivable stations.

As Auto Channel Set progresses, the "█" mark on the TV screen moves from left to right. Wait until the TV screen as shown in step 8 appears.

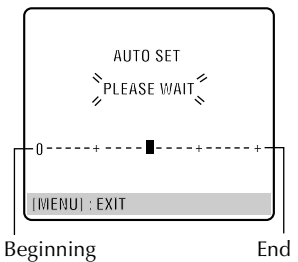

### 8 View the Confirmation screen.

After "SCAN COMPLETED" is displayed on the TV screen for about 5 seconds, the Confirmation screen looking like the one to the right appears. The stations your unit located appear on the Confirmation screen —

channel positions (PR), channels (CH) and station names (ID — pg. 72). The blueback screen and the programme currently being broadcast by the blinking station appear alternately for 8 seconds each. To view the next page, use the  $\Delta$ / $\nabla$ / $\triangleleft$ / $\triangleright$  button on the remote control.

• The stations located in the selected country appear at the top of the list.  
 • The Guide Program numbers will also be set automatically during Auto Channel Set.

SPR	CH	ID	PR	CH	ID
01	25	ARD	08	C26	E-SP
02	C08	SKY1	09	55	WEST
03	10	ZDF	10	C24	SAT1
04	C65	RAI1	11	C23	OSF
05	C31	BBC1	12		---
06	C32	BBC2	13		---
07	C33	3SAT	14		---

Navigation:  $\Delta$ / $\nabla$ / $\triangleleft$ / $\triangleright$  : EDIT,  $\rightarrow$  [X] : DELETE, [MENU] : EXIT

### 9 Return to the normal screen.

Press **SET UP MENU**.

- Using the Confirmation screen, you can skip or add channel positions, enter station names and perform other operations. Refer to pages 69 – 71 for the procedures.
- Depending on reception conditions, the stations may not be stored in order, and the station names may not be stored correctly.
- For information on scrambled broadcasts, refer to page 70.

## IMPORTANT

- In certain reception conditions, station names may not be stored correctly, and Auto Guide Program Number Set may not work properly. If the Guide Program numbers are not set properly when you timer-record a TV programme using the SHOWVIEW system, the unit will record a TV programme of a different station. When programming the timer using the SHOWVIEW system, be sure to check the desired channel is selected correctly. (☞ pg. 24, "SHOWVIEW" Timer Programming") (VHS deck only)
- Your unit memorizes all detected stations even if reception of some of them is poor. You can delete those stations with an unacceptable picture. (☞ pg. 70, "Delete A Channel")

## NOTES:

- Fine tuning is performed automatically during Auto Channel Set. If you want to perform tuning manually, refer to page 71.
- If you perform Auto Channel Set when the aerial cable is not connected properly, "SCAN COMPLETED –NO SIGNAL–" appears on the TV screen in step 8. When this happens, make sure of the aerial connection and press **OK**; Auto Channel Set will take place again.
- If no sound accompanies the picture or the audio sounds unnatural on some channels that have been stored by Auto Set Up, the TV system setting for those channels may be incorrect. Select the appropriate TV system for those channels. (☞ pg. 70, "INFORMATION")

## Manual Channel Set

Store channels that were not stored during Auto Set Up (☞ pg. 10), Preset Download (☞ pg. 12) or Auto Channel Set (☞ pg. 68).

### 1 Access the Main Menu screen.

Press **SET UP MENU**.

### 2 Access the Confirmation screen.

Press  $\Delta \nabla$  to move the highlight bar (pointer) to "MANUAL CH SET", then press **OK** or  $\triangleright$ . The Confirmation screen appears.

### 3 Select the channel position.

Press  $\Delta \nabla \triangleleft \triangleright$  until an open position in which you want to store a channel begins blinking, then press **OK**. The Manual Channel Set screen appears.

- The blueback screen and the programme currently being broadcast by the selected channel appear alternately for 8 seconds each.

(Example) To store in position 12.

PR	CH	ID	PR	CH	ID
01	25	ARD	08	C26	E-SP
02	C08	SKY1	09	55	WEST
03	10	ZDF	10	C24	SAT1
04	C65	RAI1	11	C23	OSF
05	C31	BBC1	12	---	---
06	C32	BBC2	13	---	---
07	C33	3SAT	14	---	---

$\blacktriangle \blacktriangleright \blacktriangleleft \blacktriangleleft$   
 $\rightarrow$  [OK] : EDIT  
 $\rightarrow$  [X] : DELETE  
 [MENU] : EXIT

### 4 Select the band.

Press  $\Delta \nabla$  to change the band between CH (regular) and CC (cable), then press  $\triangleright$ .

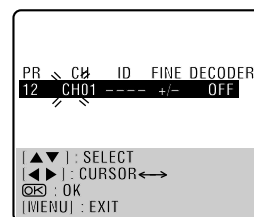

### 5 Input the channel.

Press the **number keys** to input the channel number you want to store.

- Input "0" before any single number entries.
- To input the registered station name (ID – ☞ pg. 72), press  $\Delta \nabla$  until "----" (ID setting) begins blinking, then press  $\Delta \nabla$ .
- For fine tuning adjustment, press  $\triangleright$  until "+/-" begins blinking, then press  $\Delta \nabla$ . While tuning, "+" or "-" appears.
- When storing a channel that sends scrambled broadcasts, press  $\triangleright$  until "OFF" (Decoder setting) blinks, then press  $\Delta \nabla$  to set "DECODER" to "ON" ("OFF" is the default setting).
- When "L-2 SELECT" is set to "AV" or "SAT", the "DECODER" setting cannot be changed. (☞ pg. 64)

### 6 Enter new channel information.

Press **OK** and the Confirmation screen appears.

- Repeat steps 3 – 6 as necessary.

### 7 Close the Confirmation screen.

Press **SET UP MENU**.

- To change positions, see "Change Station Channel Position" (☞ pg. 70).
- If you wish to set station names other than the ones registered in your unit, see "Set Stations (B)" (☞ pg. 71).

## ATTENTION

Guide Program numbers are not set when channels are stored manually. (☞ pg. 24, "SHOWVIEW" Timer Programming")

## Delete A Channel

Perform steps **1** and **2** of "Manual Channel Set" on page 69 to access the Confirmation screen before continuing.

### 1 Select the item.

Press  $\Delta \nabla \triangleleft \triangleright$  until the item you want to delete begins blinking.

### 2 Delete a channel.

Press X.

- The item directly beneath the cancelled one moves up one line.
- Repeat steps **1** and **2** as necessary.

### 3 Close the Confirmation screen.

Press SET UP MENU.

## Change Station Channel Position

Perform steps **1** and **2** of "Manual Channel Set" on page 69 to access the Confirmation screen before continuing.

### 1 Select the item.

Press  $\Delta \nabla \triangleleft \triangleright$  until the item you want to move begins blinking. Then press OK and the station name (ID) and its channel (CH) number begin blinking.

### 2 Select the new position.

Press  $\Delta \nabla \triangleleft \triangleright$  to move the station to the new channel position, then press OK.

Example: If you moved the station in position 4 to position 2, the stations originally in positions 2 and 3 each move down one space.

PR	CH	ID	PR	CH	ID
01	25	ARD	08	C26	E-SP
02	C08	SKY1	09	55	WEST
03	10	ZDF	10	C24	SAT1
04	C65	RAI1	11	C23	OSF
05	C31	BBC1	12	C25	ESPM
06	C32	BBC2	13	---	---
07	C33	3SAT	14	---	---

➔

PR	CH	ID	PR	CH	ID
01	25	ARD	08	C26	E-SP
02	C65	RAI1	09	55	WEST
03	C08	SKY1	10	C24	SAT1
04	10	ZDF	11	C23	OSF
05	C31	BBC1	12	C25	ESPM
06	C32	BBC2	13	---	---
07	C33	3SAT	14	---	---

- Repeat steps **1** and **2** as necessary.

### 3 Close the Confirmation screen.

Press SET UP MENU.

## When Receiving A Scrambled Broadcast

### 1 Select the decoder mode.

Set "L-2 SELECT" to "DECODER". (☞ pg. 64)

### 2 Access the Confirmation screen.

Perform steps **1** and **2** of "Manual Channel Set" on page 69.

### 3 Select the position.

Press  $\Delta \nabla \triangleleft \triangleright$  to select the channel position broadcasting scrambled programmes, then press OK twice.

### 4 Change the decoder setting.

Press  $\triangleright$  until "OFF" (decoder setting) begins blinking, and set it to "ON" by pressing  $\Delta \nabla$ .

### 5 Return to the Confirmation screen.

Press OK.

- Repeat steps **3** – **5** as necessary.

### 6 Close the Confirmation screen.

Press SET UP MENU.

## INFORMATION

If you live in Eastern Europe, "TV SYSTEM" setting appears instead of "DECODER" setting on the Manual Channel Set screen. When you can see the picture but can hear no audio, select appropriate TV system (D/K or B/G). Normally, TV programmes are broadcasted as follows.

For Eastern Europe : D/K

For Western Europe : B/G

- 1 Select a country in Eastern Europe in step **5** on page 68.
- 2 Press  $\triangleright$  until the TV system (D/K or B/G) starts blinking on the Manual Channel Set screen in step **4** on page 69.
- 3 Press  $\Delta \nabla$  to select appropriate TV System (D/K or B/G).

## Set Stations (A)

Set station names that are registered in your unit.

Perform steps **1** and **2** of "Manual Channel Set" on page 69 to access the Confirmation screen before continuing.

### 1 Select the item.

Press  $\Delta \nabla \triangleleft \triangleright$  until the item you want begins blinking.

### 2 Access the Manual Channel Set screen.

Press **OK** twice.

### 3 Select the new station.

Press  $\triangleright$  until the station name (ID) begins blinking, then press  $\Delta \nabla$  until the new station's name (ID) you want to store begins blinking. Registered station names (see pg. 72) appear as you press  $\Delta \nabla$ .

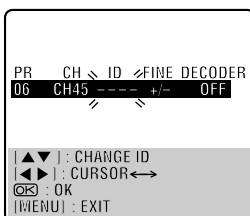

### 4 Switch the stations.

Press **OK**.

- The Confirmation screen appears.
- Repeat steps **1** – **4** as necessary.

### 5 Close the Confirmation screen.

Press **SET UP MENU**.

## Set Stations (B)

Set station names other than the ones registered in your unit.

Perform steps **1** and **2** of "Manual Channel Set" on page 69 to access the Confirmation screen and then perform steps **1** and **2** of "Set Stations (A)" above before continuing.

### 1 Select the character for station name.

Press  $\triangleright$  until the first letter of the station name begins blinking.

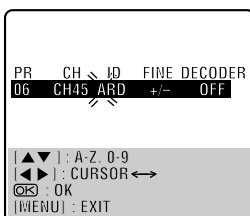

### 2 Enter the new character.

Press  $\Delta \nabla$  to cycle through the characters (A–Z, 0–9, –, \*, +, \_ (space) ) and stop when the desired character is indicated, then press  $\triangleright$  to enter. Enter the remaining characters the same way (maximum of 4). After entering all characters, press **OK**.

- The Confirmation screen appears.
- If you make a mistake, press  $\triangleleft$  until the incorrect character begins blinking. Then enter the correct character by pressing  $\Delta \nabla$ .

### 3 Close the Confirmation screen.

Press **SET UP MENU**.

#### NOTE:

The characters available for the station name (ID) are A–Z, 0–9, –, \*, +, \_ (space) (maximum of 4).

## Fine-Tuning Channels Already Stored

Perform steps **1** and **2** of "Manual Channel Set" on page 69 to access the Confirmation screen before continuing.

### 1 Select the channel to fine-tune.

Press  $\Delta \nabla \triangleleft \triangleright$  until the channel you want to tune begins blinking.

### 2 Access the Manual Channel Set screen.

Press **OK** twice. The Manual Channel Set screen appears.

### 3 Perform tuning.

Press  $\triangleright$  until "+/–" begins blinking, then press  $\Delta \nabla$  until the picture is its clearest. Then press **OK**.

- The Confirmation screen appears.
- Repeat steps **1** – **3** as necessary.

### 4 Close the Confirmation screen.

Press **SET UP MENU**.

## TV Station And ID List

\* The "ID" abbreviation is what is shown on-screen in lieu of the station name. The "ID" abbreviation is listed in the Confirmation screen and is displayed on the TV screen when the unit is tuned to a different station.

ID*	STATION NAME	ID*	STATION NAME	ID*	STATION NAME
1000	TV1000	JIM	JIM TV	SHOW	SHOW
3SAT	3SAT	JSTV	JSTV	SIC	SOCIEDADE
9LIV	9LIVE	KA2	KA2	SKY	SKY CHANNEL
AB3	AB3	KAB1	KABEL1	SKYN	SKY NEWS
ADLT	ADULT	KAN2	KANAL2	SPEK	SPEKTRUM
ANIM	Animal Planet	KAN5	KANAL5	SPRT	SPORT
ANT3	ANTENA3	KBH	Kbh. Kanal	SRTL	SUPER RTL
ARD	ARD	KIKA	Kinder kanal	STAR	STAR-TV
ARTE	ARTE	LA7	LA7	SVT1	SVT1
ATV	ATV	LIB	Liberty TV	SVT2	SVT2
B1	BERLIN 1	LOCA	LOCAL	SV24	News
BBC	BBC GROUP	M6	M6	SWR	SUEDWEST3
BBC1	BBC1	MBR	MBR	TCC	TCC
BBC2	BBC2	MCM	MCM	TCM	TCM
BBCW	BBC WORLD	MDR	MDR	TELE	TELE
BIO+	TV BIO+	MOVE	MOVIE	TELE5	TELE5
BLOO	BLOOMBERG	MTV	MTV	TF1	TF1
BR3	BAYERN3	MTV1	MTV1	TM	TM
C+	CANAL PLUS	MTV2	MTV2	TMC	TELEMONTECARLO
C1	PORTUGUSES	MTV3	MTV3	TMF	TMF
C9	C9	NGEO	NGEO	TNT	TNT INT
CAN5	CANALES	N24	News 24	TRT	TRT INT
CANV	KETNET CANVAS	N3	NORD3	TSI1	TSI
CANZ	KANAAL Z	N-TV	N-TV	TSI2	TSI2
CH4	CHANNEL4	NBC	NBC SUPER	TSR1	TSR
CH5	CHANNEL5	NDR	NDR	TSR2	TSR2
CHLD	CHILD	NED1	NED1	TV1	BRTN TV1
CINE	CINEMA	NED2	NED2	TV2	TV2
CLUB	TELECLUB	NED3	NED3	TV2Z	TV2 Z
CMT	CMT	NET5	Net 5	TV3	TV3
CNN	CNN	NEWS	NEWS	TV3+	TV3 plus
CSUR	ANDALUCIA	NICK	NICKELODEON	TV4	TV4
CT1	CT 1	NOVA	NOVA TV	TV5	TV5
CT2	CT 2	NRK1	NRK	TV6	TV6
DISC	DISCOVERY	NRK2	NRK2	TV8	TV8
DK1	TV Denmark 1	ODE	ODEON	TVE1	TVE1
DK2	TV Denmark 2	ORF1	ORF1	TVE2	TVE2
DK4	Denmark 4	ORF2	ORF2	TVG	TV GALICIA
DR1	DR TV	PHOE	PHOENIX	TVI	TV INDEPENDENT
DR2	DR2	POLS	POLST	TVN	TV NORGE
DSF	DSF	PREM	PREMIERE	TV24	TVN24
DUNA	DUNA TV	PRIM	PRIMA TV	TVP1	TVP1
ETB1	ETB1	PRO7	PRO7	TVP2	TVP2
ETB2	ETB2	RAI1	RAI1	TV P	TV Polonia
ETV	Game/Shop/Music	RAI2	RAI2	V8	V8
EUNW	EURO NEWS	RAI3	RAI3	VCR	VIDEO
EURO	EURONEWS	RET4	RETE4	VH-1	VH-1
EUSP	EUROSPORTS	RTB1	TELE21	VIT	VIT
FEMM	FEMMAN	RTB2	RTBF 2	VIVA	VIVA
FILM	FILM	RTL	RTL	VIV2	VIVA2
FNET	FILMNET	RTL2	RTL2	VMTV	VIDEO MUSIC
FR2	France2	RTL4	RTL4	VOX	VOX
FR3	France3	RTL5	RTL5	VSAT	VIASAT3
FR5	France5	RTL7	RTL7	VT4	VT4
GALA	GALAVISION	RTLK	RTL KLUB	VTM	VTM
HBO	HBO	RTP	RTP	WDR3	West3
HR3	HESSEN3	RTV4	RTV4	WRLD	WRLD
HSEU	HSEU	SAT1	SAT1	YLE1	YLE1
INFO	INFO-KANAL	SBS6	SBS	YLE2	YLE2
ITA1	ITALIA1	SERV	Service	YORN	YORIN
ITA7	ITALIA7	SF1	SF1	ZDF	ZDF
ITV1	ITV	SF2	SF2	ZTV	ZTV



# Video Channel Set

Video channel (RF output channel) is the channel on which your TV receives picture and sound signals from the unit through the RF cable.

## IMPORTANT

- Perform the following steps only if —
- Video Channel Set has not been done correctly by the Auto Set Up function (☞ pg. 10),
  - interference appears in the TV picture after you have moved to a different area or a new station has started broadcasting in your area.
  - you change the connection between your unit and TV from RF connection to AV connection, or vice versa.

**If you have connected the unit to your TV via the AV connection (☞ pg. 9), since you do not need the video channel you have to set the video channel to off.**  
**If you have connected the unit to your TV via the RF connection (☞ pg. 9), you have to set the correct video channel.**

### Before performing the following steps:

- Make sure there is no cassette inserted in the unit.
- Press **VCR/DVD** on the unit or **VCR** on the remote control so that the VCR indicator lights up, then press **⏻** to turn off the unit.

## 1 Access the Video Channel Set mode.

Hold down **■** on the unit until the front display panel shows the following.

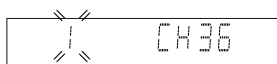

## 2 Set the RF output system.

The blinking number on the display indicates the RF output system of your country.

- If you have selected **MAGYARORSZÁG, ČESKÁ REPUBLIKA, POLSKA** or **OTHER EASTERN EUROPE** for the country setting (☞ pg. 10, 15), press **△▽** to set to "2".
- For other countries, set to "1". Then press **OK**.  
(1: B/G 2: D/K)

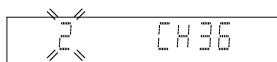

## 3 Set the video channel.

### With AV Connection

Press **PR -** until the front display panel shows "1 CH --" (or "2 CH --").

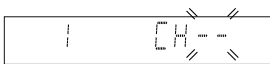

- Now the video channel is set to off.

### With RF Connection

Press **PR +** or **-** to set the unit to a vacant channel between 22 and 69 which is not occupied by any local station in your area.

(Example) If channel 50 is available in your area



Then set your TV to UHF channel 50.

- If the two vertical white bars appear clearly on the TV screen as shown to the right, go to step **4**.
- If the two vertical white bars do not appear clearly, re-set the unit to another vacant channel and try again.

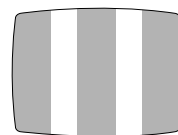

## NOTES:

- If you set the unit to a channel which is occupied by a local station or has neighbouring channels that are occupied by local stations, the picture reception quality will be affected and some interference noise will appear on the TV screen. Be sure to select a vacant channel which has no broadcast on neighbouring channels.
- If you cannot obtain the two vertical white bars clearly with any channel between 22 and 69, consult your JVC dealer.

## 4 Exit the Video Channel Set mode.

Press **OK** on the remote control.

### With AV Connection

To view picture signals from the unit, set your TV to its AV mode.

### With RF Connection

The channel on which the TV screen in step **3** appears clearly is your video channel.

To view picture signals from the unit, set your TV to the video channel.

# Clock Set

- Turn on the TV and select the video channel (or AV mode).
- Slide the TV/VCR/DVD switch to the right.

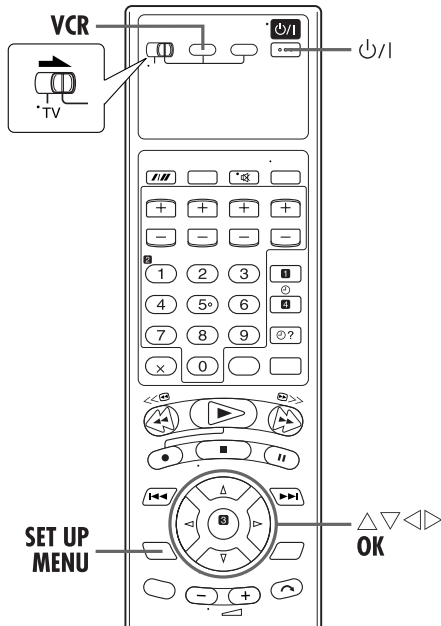

## IMPORTANT

If you performed Auto Set Up (pg. 10) or Preset Download (pg. 12), without ever having set the clock previously, the unit's built-in clock is also set automatically. Perform the following steps only if —  
—Auto Clock Set has not been performed correctly by Auto Set Up or Preset Download.  
**OR**  
—you want to change the Just Clock setting. (pg. 75, "Just Clock")

### 1 Turn on the unit.

Press P/I.

### 2 Select the VHS deck.

**On the unit**  
Press VCR/DVD repeatedly so that the VCR indicator lights up.

**On the remote control**  
Press VCR so that the VCR indicator lights up.

### 3 Access the Main Menu screen.

Press SET UP MENU.

### 4 Access the Clock Set screen.

Press  $\Delta$ / $\nabla$  to move the highlight bar (pointer) to "CLOCK SET", then press **OK** or  $\triangleright$ . The Clock Set screen appears.

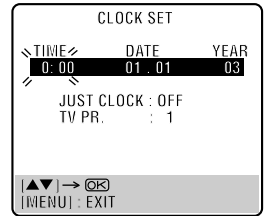
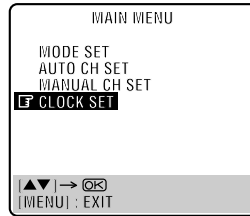

## NOTE:

When you have selected MAGYARORSZÁG, ČESKÁ REPUBLIKA, POLSKA or OTHER EASTERN EUROPE for the country setting (pg. 10, 15), you cannot use the Just Clock function. Skip steps 6 and 7.

### 5 Set the date and time.

Press  $\Delta$ / $\nabla$  to set the time, then press **OK** or  $\triangleright$ . The "DATE" display begins blinking. Repeat the same procedure to set the date and year.

- When you set the time, press and hold  $\Delta$ / $\nabla$  to change the time by 30 minutes.
- When you set the date, press and hold  $\Delta$ / $\nabla$  to change the date by 15 days.

### 6 Set Just Clock.

The default setting is "OFF". Set as desired by pressing  $\Delta$ / $\nabla$ , then press **OK** or  $\triangleright$ .

- For the Just Clock function, refer to "Just Clock" on page 75.
- If you set it to "OFF", you can disregard the next step as you won't be able to receive regular clock adjustments.

### 7 Set the source channel position for clock data.

The unit is preset to receive clock setting and adjustment data from channel position 1.

Press  $\Delta$ / $\nabla$  to set the channel position to the number representing the station transmitting clock setting data, then press **OK** or  $\triangleright$ .

### 8 Start the clock operation.

Press SET UP MENU.

**Just Clock**

The Just Clock function provides accurate time keeping through automatic adjustments at regular intervals, by reading data from a PDC signal.

The Just Clock option can be set "ON" or "OFF" at the Clock Set screen (the default setting is "OFF"). Press **OK** until the Just Clock setting begins blinking, then press  $\Delta$ / $\nabla$  to change the setting.

**IMPORTANT:** If you turn off Just Clock, the accuracy of your unit's built-in clock may be reduced, which could adversely affect timer recording. We recommend you to keep Just Clock on. In cases where the clock setting data from a PDC signal is incorrect, however, you are advised to keep Just Clock set to "OFF".

**NOTES:**

- Just Clock (when set to "ON") adjusts the unit's built-in clock every hour, except for 23:00, 0:00, 1:00 and 2:00.
- Just Clock is not effective when:
  - the unit's power is on.
  - the unit is in the Timer mode. (VHS deck only)
  - a difference of more than 3 minutes exists between the built-in clock's time and the actual time.
  - the unit is in the Automatic Satellite Programme Recording mode. (pg. 28) (VHS deck only)
  - the unit is in the Power Save mode. (pg. 64) (VHS deck only)
  - "L-2 SELECT" is set to "SAT". (pg. 64) (VHS deck only)
- If Just Clock is set to "ON", the unit's clock is automatically adjusted at the start/end of Summer Time.
- Just Clock may not function properly depending on the reception condition.

# Child Lock

- Turn on the TV and select the video channel (or AV mode).
- Slide the **TV/VCR/DVD** switch to the right.

You can disable the unit's operation.

## 1 Set the Child Lock.

Press and hold  $\psi$ /I on the remote control for more than 10 seconds while the unit is turned on. The unit turns off, and "CL" appears on the front display panel.



- To release the child lock, press and hold  $\psi$ /I on the remote control until the unit turns on.

**NOTES:**

- When the child lock function is in use, keep the remote control out of the children's reach.
- Timer recording programmes will be performed even if the child lock function is activated.

Before requesting service for a problem, use this chart and see if you can repair the trouble yourself. Small problems are often easily corrected, and this can save you the trouble of sending your unit off for repair.

## POWER

### No power is supplied to the unit.

- The mains power cord is disconnected.
- Connect the mains power cord.

### The remote control won't function.

- The batteries are discharged.
- Replace the dead batteries with new ones.

## TAPE TRANSPORT (VHS deck)

### During recording, the tape does not run. "●" lights up on the front display panel.

- The unit is in the Record Pause mode.
- Press ► to resume recording.

### The tape will not rewind or fast-forward.

- The tape is already fully rewound or fast-forwarded.
- Check the cassette.

## PLAYBACK (VHS deck)

### The VHS deck can not be operated.

- The VHS deck is not selected.

#### On the unit

→ Press **VCR/DVD** repeatedly so that the VCR indicator lights up.

#### On the remote control

→ Press **VCR** so that the VCR indicator lights up.

### The playback picture does not appear while the tape is running.

- If you are using the RF connection,
  - the TV receiver's channel selector is not set to the video channel.
  - the unit's video channel has not been correctly set.
- If you are using the RF connection,
  - set the TV receiver to the video channel.
  - perform "Video Channel Set" (☞ pg. 73).
- If you are using the AV connection, the TV receiver is not set to the AV mode.
- If you are using the AV connection, set the TV to its AV mode.

### Noise appears during visual search.

- This is normal.

### Noise appears during normal playback.

- The automatic tracking mode is engaged.
- Try manual tracking. (☞ pg. 20)

### The playback picture is blurred or interrupted while TV broadcasts are clear or "USE CLEANING CASSETTE" message appears on the screen.

- The video heads may be dirty.
- Use a dry cleaning cassette ECL-3F, or consult your JVC dealer.

### Breaks are noticeable in Hi-Fi soundtrack.

- The automatic tracking mode is engaged.
- Try manual tracking. (☞ pg. 20)

## PLAYBACK (DVD deck)

### The button does not work.

- The operation is prohibited on the placed disc.

### The DVD deck can not be operated.

- The DVD deck is not selected.

#### On the unit

→ Press **VCR/DVD** repeatedly so that the DVD indicator lights up.

#### On the remote control

→ Press **DVD** so that the DVD indicator lights up.

### "⊘" appears on the TV screen.

- The operation is prohibited on the placed disc.

### "REGION CODE ERROR!" appears on the TV screen.

- The disc's region number does not match that of the unit.
- Use the discs whose region number includes "ALL" or "2". (☞ pg. 4)

### The disc cannot be played back.

- The disc's region number does not match that of the unit.
- Use the discs whose region number includes "ALL" or "2". (☞ pg. 4)
- This type of disc cannot be played back.
- See "Unplayable Discs" (☞ pg. 4).
- The disc is not placed properly.
- Remove the disc, then place the disc properly in the disc tray. (☞ pg. 5, "Placing a Disc")
- The Parental Lock is engaged, and the placed disc is rated higher than the set level.
- Release the Parental Lock temporarily (☞ pg. 45), or change the set level (☞ pg. 45).

### The language is not played back as you set.

- The disc does not contain the language you set.

**Changing audio/subtitle language is not possible.**

- The disc does not contain audio/subtitles in multiple languages.
- With some discs, the language should be set on the top menu. (☞ pg. 31)

**The subtitles do not appear on the TV screen.**

- The disc does not contain subtitles.
- The subtitle display is set to off.
- Set the subtitles display to on. (☞ pg. 40)
- A-B Repeat Playback is in progress. (☞ pg. 37)
- The subtitles recorded around point A-B may not appear.

**Angle cannot be changed.**

- The scene is not recorded from multiple angles.

**MP3 Playback (DVD deck)****A disc cannot be played.**

- No MP3 files are recorded to the disc.
- Replace the disc.
- MP3 files do not have the correct file extension in their file names.
- Add correct file extension (for example .mp3, .MP3 or any uppercase and lowercase combination such as ".Mp3") to their file names.
- MP3 files are not recorded in a format compliant with ISO 9660 Level 1 or 2.
- Replace the disc. (Record MP3 files using a compliant application.)
- The different types of files are recorded to the disc.
- The disc which contains the different types of files may not be played because of its disc characteristics or recording conditions.

**Not MP3 files but JPEG files are played.**

- The MP3/JPEG setting is set to "JPEG".
- When both MP3 files and JPEG files are recorded to a disc, set "MP3/JPEG" to "MP3" to play MP3 files. (☞ pg. 66)

**The MP3 control display appears on the TV screen, but no operation can be performed.**

- No MP3 files or JPEG files are recorded to the disc, or the disc is an unplayable disc (such as CD-ROM).
- Replace the disc.

**JPEG Playback (DVD deck)****A disc cannot be played.**

- No JPEG files are recorded to the disc.
- Replace the disc.
- JPEG files do not have the correct file extension in their file names.
- Add correct file extension (.jpg, .jpeg, .JPG, .JPEG or any uppercase and lowercase combination such as ".Jpg") to their file names.
- JPEG files are not recorded in a format compliant with ISO 9660 Level 1 or 2.
- Replace the disc. (Record JPEG files using a compliant application.)

**Not JPEG files but MP3 files are played back.**

- The MP3/JPEG setting is set to "MP3".
- When both MP3 files and JPEG files are recorded to a disc, set "MP3/JPEG" to "JPEG" to play JPEG files. (☞ pg. 66)

**RECORDING (VHS deck)****Recording cannot be started.**

- There is no cassette loaded, or the cassette loaded has had its record safety tab removed.
- Insert a cassette, or using adhesive tape, cover the hole where the tab was removed.

**TV broadcasts cannot be recorded.**

- "L-1", "L-2" or "F-1" has been selected as the input mode.
- Set to the desired channel.

**Tape-to-tape editing is not possible.**

- The source (another video recorder, camcorder) has not been properly connected.
- Confirm that the source is properly connected.
- All necessary power switches have not been turned on.
- Confirm that all units' power switches are turned on.
- The input mode is not correct.
- Set the input mode to "L-1", "L-2" or "F-1".

**Camcorder recording is not possible.**

- The camcorder has not been properly connected.
- Confirm that the camcorder is properly connected.
- The input mode is not correct.
- Set the input mode to "L-1", "L-2" or "F-1".

**"●" and "▶" on the front display panel won't stop blinking.**

- The end of the tape was reached during recording.
- The programme may not have been recorded in its entirety. Next time make sure you have enough time on the tape to record the entire programme.

## TIMER RECORDING (VHS deck)

### Timer recording won't work.

- The clock and/or the timer have been set incorrectly.  
→ Re-perform the clock and/or timer settings.
- The timer is not engaged.  
→ Press **⏸** and confirm that "⏸" is displayed on the front display panel.

### Timer programming is not possible.

- Timer recording is in progress.  
→ Timer programming can't be performed while a timer recording is in progress. Wait until it finishes.

### "⏸" on the front display panel won't stop blinking.

- The timer is engaged but there's no cassette loaded.  
→ Load a cassette with the record safety tab intact.

### "⏸", "●" and "▶" on the front display panel won't stop blinking.

- The loaded cassette has had its record safety tab removed.  
→ Remove the cassette and cover the hole with adhesive tape, or insert a cassette with the record safety tab intact.
- The end of the tape was reached during timer recording.  
→ The programme may not have been recorded in its entirety. Next time make sure you have enough time on the tape to record the entire programme.

### "⏸" blinks for 10 seconds and the Timer mode is disengaged.

- ⏸ has been pressed when there are no programs in memory, or the timer record information has been programmed incorrectly.  
→ Check the programmed data and re-program as necessary, then press ⏸ again.

### The SHOWVIEW system does not timer-record properly.

- The unit's channel positions have been set incorrectly.  
→ Refer to "SHOWVIEW" Timer Programming" (ⓘ pg. 24) and re-perform the procedure.

### "●" and "▶" on the front display panel won't stop blinking.

- The end of the tape was reached during Instant Timer Recording.  
→ The programme may not have been recorded in its entirety. Next time make sure you have enough time on the tape to record the entire programme.

### "⏸", "●" and "▶" on the front display panel won't stop blinking.

- The loaded cassette has had its record safety tab removed.  
→ Remove the cassette and cover the hole with adhesive tape, or insert a cassette with the record safety tab intact.
- The end of the tape was reached during Automatic Satellite Programme Recording.  
→ The programme may not have been recorded in its entirety. Next time make sure you have enough time on the tape to record the entire programme.

## OTHER PROBLEMS

### The image of the TV broadcast appears distorted on the TV screen.

- The unit is left turned on and the DVD deck is selected.  
→ Turn off the unit, or press **VCR** to select the VHS deck, then press **TV/VCR** so that the VCR indicator disappears from the front display panel.

### Whistling or howling is heard from the TV during camcorder recording.

- The camcorder's microphone is too close to the TV.  
→ Position the camcorder so its microphone is away from the TV.
- The TV's volume is too high.  
→ Turn the TV's volume down.

### When scanning channels, some of them are skipped over.

- Those channels have been designated to be skipped.  
→ If you need the skipped channels, restore them. (ⓘ pg. 69)

### The channel cannot be changed.

- Recording is in progress.  
→ Press **II** to pause the recording, change channels, then press **▶** to resume recording.

### Channel settings that were made manually seem to have changed or disappeared.

- After the manual settings were made, Auto Channel Set was performed.  
→ Perform manual setting again.

### No channels are stored in the unit's memory.

- The TV aerial cable was not connected to the unit when Auto Set Up was performed.  
→ Turn off the unit once and connect the TV aerial cable to the unit properly, then turn on the unit again. Then perform Auto Set Up again. (ⓘ pg. 10)
- The fully-wired 21-pin SCART cable was not connected between the TV and the unit when Preset Download was performed.  
→ Turn off the unit once and connect the fully-wired 21-pin SCART cable to the unit properly, then turn on the unit again. Then perform Preset Download again. (ⓘ pg. 12)

## ATTENTION

This unit contains microcomputers. External electronic noise or interference could cause malfunctioning. In such cases, switch the unit off and unplug the mains power cord. Then plug it in again and turn the unit on. Take out the cassette. After checking the cassette, operate the unit as usual.

**GENERAL**

Power requirement : AC 220 V – 240 V~, 50 Hz/60 Hz  
 Power consumption  
     Power on : 26 W  
     Power off : 6.0 W  
 Temperature  
     Operating : 5°C to 40°C  
     Storage : –20°C to 60°C  
 Operating position : Horizontal only  
 Dimensions (WxHxD)  
     : 435 mm x 93 mm x 272 mm  
 Weight : 4.4 kg  
 Format : VHS PAL standard  
 Maximum recording time  
     (SP) : 240 min. with E-240 video cassette  
     (LP) : 480 min. with E-240 video cassette

**VIDEO/AUDIO (VHS deck)**

Signal system : PAL-type colour signal and CCIR monochrome signal, 625 lines  
                     50 fields  
 Recording system : DA4 (Double Azimuth) head helical scan system  
 Signal-to-noise ratio: 45 dB  
 Horizontal resolution : 250 lines  
 Frequency range : 70 Hz to 10,000 Hz (Normal audio)  
                     20 Hz to 20,000 Hz (Hi-Fi audio)  
 Input/Output : 21-pin SCART connectors:  
                     IN/OUT x 1, IN/DECODER x 1  
                     RCA connectors:  
                     VIDEO IN x 1, AUDIO IN x 1,  
                     AUDIO OUT x 1

**VIDEO/AUDIO (DVD deck)**

Signal system : PAL  
 Applicable disc : DVD (12 cm, 8 cm)  
                     CD (12 cm, 8 cm)  
 Audio characteristics  
     DVD : 4 Hz – 22 KHz  
 Frequency response  
     CD : 4 Hz – 20 KHz  
 S/N Ratio : 90 dB  
 Wow and flutter : Below Measurable Level  
 Dynamic range : 90 dB  
 Output  
     Audio : (RCA) 2 Vrms, 1 Kohm  
     Digital Audio : –21 dBm to –15 dBm (peak)

**TUNER/TIMER (VHS deck)**

TV channel storage capacity : 99 positions (+AUX position)  
 Tuning system : Frequency synthesized tuner  
 Channel coverage : VHF 47 MHz – 89 MHz/  
                     104 MHz – 300 MHz/  
                     302 MHz – 470 MHz  
                     UHF 470 MHz – 862 MHz  
 Aerial output : UHF channels 22 – 69 (Adjustable)  
 Memory backup time : Approx. 10 min.

**ACCESSORIES**

Provided accessories : RF cable,  
                             Infrared remote control unit,  
                             “R6” battery x 2

Specifications shown are for SP mode unless otherwise specified.  
 E.& O.E. Design and specifications subject to change without notice.

<b>A</b>	
A-B Repeat Playback .....	37
About Discs	
JPEG .....	51
MP3 .....	48
Placing a Disc .....	5
Playable Discs .....	4
Region Number .....	4
Unplayable Discs .....	4
Angle Selection .....	41
Audio Channel Selection .....	43
Audio Language Selection .....	42
Auto Channel Set .....	68
Auto Set Up .....	10
Automatic Satellite Programme Recording .....	28
<b>C</b>	
Change Station Channel Position .....	70
Chapter Search .....	38
Check, cancel and change programmes .....	27
Child Lock .....	75
Clock Set .....	74
Connecting To A Dolby Digital Decoder or An Amplifier	
With A Built-in DTS .....	61
Connecting To A Satellite Receiver .....	60
Connecting/Using A Decoder .....	61
<b>D</b>	
Delete A Channel .....	70
Digital Audio Dubbing .....	57
Disc menu .....	31
Dubbing (from DVD to VHS) .....	56
<b>E</b>	
EDITING (DVD DECK)	
Digital Audio Dubbing .....	57
EDITING (VHS DECK)	
Dubbing (from DVD to VHS) .....	56
Edit From A Camcorder .....	54
Edit To Or From Another Video Recorder .....	55
Elapsed Recording Time Indication .....	22
Express Timer Programming .....	26
<b>F</b>	
Fine-Tuning Channels Already Stored .....	71
<b>G</b>	
Group/file selection .....	53
Group/track selection .....	50
<b>I</b>	
INDEX .....	6
Index Search .....	19
Instant ReView .....	20
Instant Timer Recording (ITR) .....	22
<b>J</b>	
JPEG control display .....	51
Just Clock .....	13, 75
<b>L</b>	
Language .....	15
Language Code List .....	17
Menu/Audio/Subtitle Language Set	
(DVD deck only) .....	16
On-screen Language Set (DVD deck) .....	16
On-screen Language Set (VHS deck) .....	15
Letter Box .....	14
Locating the start point of the item or skip the item ....	31
<b>M</b>	
Manual Channel Set .....	69
Manual Tracking .....	20
Mode Set (DVD deck)	
ANALOG DOWN MIX .....	66
AUDIO LANGUAGE .....	16
D. RANGE CONTROL .....	66
DIGITAL AUDIO OUT .....	66
MENU LANGUAGE .....	16
MONITOR TYPE .....	14, 66
MP3/JPEG .....	66
ON SCREEN GUIDE .....	67
ON SCREEN LANGUAGE .....	16
OUTPUT LEVEL .....	66
PICTURE SOURCE .....	66
RESUME .....	67
SCREEN SAVER .....	66
SUBTITLE .....	16
Mode Set (VHS deck)	
AUTO POWER OFF .....	64
AUTO SP→LP TIMER .....	63
B.E.S.T. ....	23, 63
COLOUR SYSTEM .....	64
DIRECT REC .....	63
L-2 SELECT .....	64
O.S.D. ....	63
PICTURE CONTROL .....	63
POWER SAVE .....	64
VIDEO STABILIZER .....	64
Monitor Set (DVD deck)	
MONITOR TYPE .....	14
MP3 control display .....	48
<b>N</b>	
Next Function Memory .....	19



<b>O</b>		
OPERATIONS ON DVD DECK .....	30 – 53	
OPERATIONS ON VHS DECK .....	18 – 29	
<b>P</b>		
Pan&Scan .....	14	
Parental Lock		
Country/Area Code List .....	46	
To change the settings .....	45	
To set Parental Lock for the first time .....	44	
To temporarily release the Parental Lock .....	45	
Playback (DVD deck) .....	30 – 40	
Playback (JPEG) .....	52 – 53	
Playback (MP3) .....	49 – 50	
Playback (VHS deck) .....	18 – 20	
Playback Control (PBC) Function .....	31, 38	
Preset Download .....	12	
Programme Playback .....	39	
<b>R</b>		
Random Playback .....	40	
Record One Programme While Watching Another ....	22	
Recording .....	21 – 23	
Recording Resume Function .....	21	
Region Number .....	4	
Remote Control Functions .....	58	
Repeat Playback .....	20, 36, 50, 53	
Resume Function .....	32	
<b>S</b>		
Set Stations (A) .....	71	
Set Stations (B) .....	71	
SHOWVIEW® Timer Programming .....	24	
Skip Search .....	19	
Slow Motion .....	19, 32	
Soundtrack Selection .....	20	
Still Picture/Frame-By-Frame Playback .....	19, 32	
Subtitle Selection .....	40	
<b>T</b>		
Tape Position Indicator .....	7	
Tape Remaining Time .....	22	
Time Search .....	38	
Timer Recording .....	24 – 29	
Top menu .....	31	
Tuner Set .....	68 – 72	
T-V LINK .....	13	
TV Station And ID List .....	72	
<b>V</b>		
Variable Speed Search .....	19, 32	
VFP function .....	34	
Video Channel Set .....	73	
VPS/PDC Recording .....	25	
<b>W</b>		
When programmes overlap each other .....	28	
When Receiving A Scrambled Broadcast .....	70	
<b>Z</b>		
Zooming .....	33, 53	
	3D Phonic .....	33





EN

HR-XV32E

**JVC**  
VICTOR COMPANY OF JAPAN, LIMITED

## Free Manuals Download Website

<http://myh66.com>

<http://usermanuals.us>

<http://www.somanuals.com>

<http://www.4manuals.cc>

<http://www.manual-lib.com>

<http://www.404manual.com>

<http://www.luxmanual.com>

<http://aubethermostatmanual.com>

Golf course search by state

<http://golfingnear.com>

Email search by domain

<http://emailbydomain.com>

Auto manuals search

<http://auto.somanuals.com>

TV manuals search

<http://tv.somanuals.com>