

JVC

VHS SQPB

4 HEAD

19µm HEAD

Hi-Fi



WMA MP3 JPEG

DVD/CD PLAYER
Hi-Fi STEREO
VIDEO CASSETTE
RECORDER
USER'S GUIDE

For model:
HR-XVC21UJ

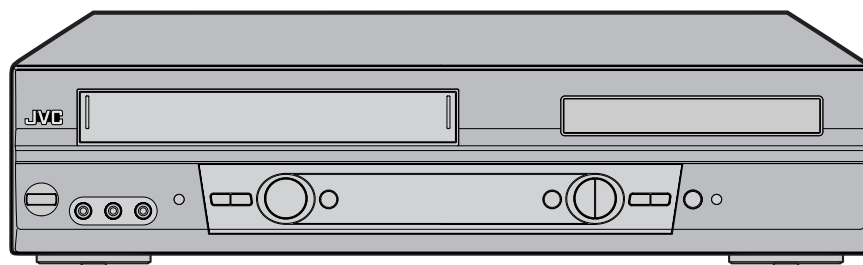

For Customer Use:

Enter below the Model No. and Serial No. which are located on the rear of cabinet.
Retain this information for future reference.

Model No. _____



Serial No. _____

Dear Customer,

Thank you for purchasing the JVC DVD player video cassette recorder. Before use, please read the safety information and precautions to ensure safe use of your new DVD/VCR.

CAUTIONS

WARNING: DANGEROUS VOLTAGE INSIDE
WARNING: TO PREVENT FIRE OR SHOCK HAZARD, DO NOT EXPOSE THIS UNIT TO RAIN OR MOISTURE.

The POWER  button does not completely shut off mains power from the unit, but switches operating current on and off.
“” shows electrical power standby and “I” shows ON.

This unit is produced to comply with Standard IEC 60065.

POWER SYSTEM:
This set operates on voltage of AC 110 – 220V~, 50/60 Hz with automatic switching.

Use the conversion plug (provided) depending on the type of your AC WALL outlet.

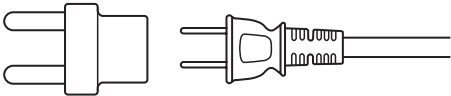

The rating plate and safety caution are on the rear of the unit.

IMPORTANT:
It may be unlawful to record or play back copyrighted material without the consent of the copyright owner.

CAUTION:
THIS DIGITAL VIDEO PLAYER EMPLOYS A LASER SYSTEM.

TO ENSURE PROPER USE OF THIS PRODUCT, PLEASE READ THIS USER'S GUIDE CAREFULLY AND RETAIN FOR FUTURE REFERENCE. SHOULD THE UNIT REQUIRE MAINTENANCE, CONTACT A JVC AUTHORIZED SERVICE CENTER.

USE OF CONTROLS, ADJUSTMENTS OR THE PERFORMANCE OF PROCEDURES OTHER THAN THOSE SPECIFIED HEREIN MAY RESULT IN HAZARDOUS RADIATION EXPOSURE.

TO PREVENT DIRECT EXPOSURE TO LASER BEAM, DO NOT TRY TO OPEN THE ENCLOSURE. VISIBLE LASER RADIATION MAY BE PRESENT WHEN THE ENCLOSURE IS OPENED. DO NOT STARE INTO BEAM.

CAUTION

- When you are not using the DVD/VCR for a long period of time, it is recommended that you disconnect the power cord from the AC outlet.
- Dangerous voltage inside. Refer internal servicing to qualified service personnel. To prevent electric shock or fire hazard, remove the power cord from the AC outlet prior to connecting or disconnecting any signal lead or aerial.
- Changes or modifications not approved by JVC could void user's authority to operate the equipment.



- Cassettes marked “VHS” (or “S-VHS”) can be used with this DVD/VCR. However, S-VHS recording is not possible with this model.
- This model is equipped with SQPB (S-VHS QUASI PLAYBACK) that makes it possible to play back S-VHS recordings with regular VHS resolution.
- HQ VHS is compatible with existing VHS equipment.

CAUTION
A DVD/VCR IS A CLASS 1 LASER PRODUCT. HOWEVER THIS DVD/VCR USES A VISIBLE LASER BEAM WHICH COULD CAUSE HAZARDOUS RADIATION EXPOSURE IF DIRECTED. BE SURE TO OPERATE THE UNIT CORRECTLY AS INSTRUCTED. WHEN THIS DVD/VCR IS PLUGGED INTO THE WALL OUTLET, DO NOT PLACE YOUR EYES CLOSE TO THE OPENING OF THE DISC TRAY AND OTHER OPENINGS TO LOOK INTO THE INSIDE OF THIS DVD/VCR.

USE OF CONTROLS OR ADJUSTMENTS OR PERFORMANCE OF PROCEDURES OTHER THAN THOSE SPECIFIED HEREIN MAY RESULT IN HAZARDOUS RADIATION EXPOSURE.

DO NOT OPEN COVERS AND DO NOT REPAIR YOURSELF. REFER SERVICING TO QUALIFIED PERSONNEL.

When the equipment is installed in a cabinet or a shelf, make sure that it has sufficient space on all sides to allow for ventilation (10 cm or more on both sides, on top and at the rear).

When discarding batteries, environmental problems must be considered and the local rules or laws governing the disposal of these batteries must be followed strictly.

Failure to heed the following precautions may result in damage to the DVD/VCR, Remote or video cassette.

1. DO NOT place the DVD/VCR ...
 - ... in an environment prone to extreme temperatures or humidity.
 - ... in direct sunlight.
 - ... in a dusty environment.
 - ... in an environment where strong magnetic fields are generated.
 - ... on a surface that is unstable or subject to vibration.
2. DO NOT block the DVD/VCR's ventilation openings or holes.
(If the ventilation openings or holes are blocked by a newspaper or cloth, etc., the heat may not be able to get out.)
3. DO NOT place heavy objects on the DVD/VCR or Remote.
4. DO NOT place anything which might spill on top of the DVD/VCR or Remote.
(If water or liquid is allowed to enter this equipment, fire or electric shock may be caused.)
5. DO NOT expose the apparatus to dripping or splashing.
6. DO NOT use this equipment in a bathroom or places with water. Also DO NOT place any containers filled with water or liquids (such as cosmetics or medicines, flower vases, potted plants, cups, etc.) on top of this unit.
7. DO NOT place any naked flame sources, such as lighted candles, on the apparatus.
8. AVOID violent shocks to the DVD/VCR during transport.

MOISTURE CONDENSATION

Moisture in the air will condense on the DVD/VCR when you move it from a cold place to a warm place, or under extremely humid conditions—just as water droplets form on the surface of a glass filled with cold liquid. Moisture condensation on the head drum will cause damage to the tape. In conditions where condensation may occur, keep the DVD/VCR's power turned on for a few hours to let the moisture dry.

How to use the Remote

Before use, insert two AAA size batteries into the Remote with the polarity (\oplus and \ominus) matched correctly as indicated on the battery compartment or on the lid.

- Point the Remote toward the remote sensor on the target component.
- The maximum operating distance of the remote control is about 5 m.

NOTE:

If the Remote does not work properly, remove its batteries, wait for a few seconds, replace the batteries and then try again.

Video heads cleaning

The heads get dirty in the following cases:

- in an environment prone to extreme temperature or humidity.
- in a dusty environment
- flaw, dirt or mold on video tapes
- continuous usage for a long time

Use a dry cleaning cassette — TCL-2 — when:

- Rough, poor picture appears while a tape is played back.
- The picture is unclear or no picture appears.

* This product incorporates copyright protection technology that is protected by method claims of certain U.S. patents and other intellectual property rights owned by Macrovision Corporation and other rights owners. Use of this copyright protection technology must be authorized by Macrovision Corporation or other rights owners and is intended for home and other limited viewing uses only unless otherwise authorized by Macrovision Corporation or other rights owners. Reverse engineering or disassembly is prohibited.

* Manufactured under license from Dolby Laboratories. "Dolby" and the double-D symbol are trademarks of Dolby Laboratories. Confidential unpublished works. © 1992-1997 Dolby Laboratories, Inc. All rights reserved.

* "DTS" and "DTS Digital Out" are trademarks of Digital Theater Systems, Inc.

* Certain audio features of this product manufactured under license from Desper Products, Inc. Spatializer and the circle-in-square device are trademarks owned by Desper Products, Inc.

* Unauthorized recording of copyrighted television programs, films, video cassettes and other materials may infringe the rights of copyright owners and be contrary to copyright laws.

Features

DVD/CD Player/Video Cassette Recorder

- **DVD/CD player with Video Cassette Recorder** - Unique space saving design combines a DVD/CD player and a Hi-Fi Video cassette recorder. The DVD disc has much more capacity, but is the same size as the audio CD disc. Picture quality is higher than Super VHS. Audio quality is higher than audio CD.
- **High Quality Picture** - More than 500 lines (VCR mode: 230 lines) of Horizontal Resolution. It exceeds Super VHS (400 lines) or Laser Disc (430 lines) in resolution.

VCR Section

- **Stereo/SAP Reception** - This VCR is designed to receive stereo and separate audio program (SAP) broadcasts where available.
- **SQPB** - Tapes recorded in the S-VHS system can be played back simply on this VCR.
- **4 Video Heads** - Provides optimal picture quality for special effects playback.
- **19µm HEAD** - For superior picture quality even in EP mode, 19micron width technology helps to avoid crosstalk and boost EP picture quality to near SP levels. With precision technology, ghosts and color beats are virtually eliminated.
- **Hi-Fi Stereo Sound** - With a frequency response of 20 to 20,000 Hz and a dynamic range of better than 90dB, this VCR provides a level of excellence that rivals compact discs.
- **Instant Timer Recording (ITR)** - Simply by pressing the REC and PLAY buttons, the VCR can be programmed for up to 6 hours of recording with an immediate start.
- **Skip Search** - When the SKIP SEARCH button is pressed during playback, the VCR will automatically search forward in 30 seconds increments to a maximum of 3 minutes with each press of the SKIP SEARCH button, and then return to normal playback.

DVD Section

- **Compatible with a wide range of DVD audio outputs**
 - Digital Audio Jack (Optical or Coaxial):**
 - When a component with a built-in Dolby Digital decoder is connected, Dolby Digital sound can produce the effect of being in a movie theater or a concert hall.
 - Surround standard different from Dolby Digital. This format is already in use in many theaters. By connecting this unit to a DTS decoder or an AV amplifier with a built-in DTS decoder, the DTS audio of DVD discs recorded in this format can be enjoyed. However, audio will not be output from the analog audio output jacks.
 - The MPEG audio of DVD discs recorded in this format can be enjoyed.
 - The Linear PCM sound of a 48 kHz/16 bit through 96 kHz/24 bit exceeds audio CD sound.
- **Surround audio** - This DVD equipped with a "SPATIALIZER N-2-2". It can produce the effect of being in a cinema or a concert hall.
- **Multi-Language** - Since this DVD matches with 124 language-subtitles/-soundtracks, you can enjoy selecting a favorite one. (You can not select the language that is not recorded on the disc.)
- **Multi-Angle** - Pictures of Sports or a Live Concert are recorded with many cameras. When you play such a disc, you can change the angles during playback. (If a Multi-Angle is not recorded on the disc, you can not change the angle.)
- **Repeat Playback** - You can repeat chapter, track, title, sides or material between two selected points.
- **Program/Random Playback (CD)** - You can play back tracks in programmed or random-selected sequences.
- **Zoom** - You can zoom in on the selected subject on the screen during playback.
- **Video Aspect Ratio** - You can change the aspect ratio of the screen for your monitor/television on a suitable disc.
- **Parental Control** - You can limit the playback of scenes or sounds of adult DVD discs which have a parental level rating.
- **MP3/WMA/JPEG file Compatibility** - This DVD can play back MP3/WMA/JPEG file recorded on the CD-R/RW and FUJICOLOR CD and Kodak Picture CD formats.

Before using your unit

| | |
|-------------------------------------|----|
| Features | 4 |
| Contents | 5 |
| Parts and functions | 6 |
| Display | 7 |
| Remote control | 8 |
| TV multi-brand remote control | 10 |
| Control four JVC VCRs | 11 |
| Basic connections | 12 |
| CATV (CABLE TV) connections | 14 |
| Playback connections | 16 |

Setting up the VCR section

| | |
|---|----|
| Setting the video channel | 18 |
| Setting the language | 18 |
| Tuner setting | 19 |
| To ADD/DELETE channels | 20 |
| Noise elimination | 20 |
| Auto clock setting | 21 |
| Manual clock setting | 23 |
| Loading and Unloading a cassette tape | 24 |

Tape playback operation

| | |
|---------------------------------|----|
| Cassette tape playback | 25 |
| Special playback | 26 |
| ZERO RETURN function | 27 |
| Video Index Search system | 27 |

Recording

| | |
|-------------------------------------|----|
| Recording a TV program | 28 |
| Instant Timer Recording (ITR) | 30 |
| Timer recording | 31 |

Advanced function of VCR section

| | |
|---|----|
| Stereo recording and playback | 33 |
| Second Audio Program (SAP) | 33 |
| Duplicating a video tape | 34 |
| Duplicating a disc material onto a video tape | 34 |

Disc Playback operation

| | |
|------------------------------------|----|
| Disc | 35 |
| Setting setup language | 36 |
| Playback procedure | 37 |
| Special playback | 38 |
| Zooming | 39 |
| Locating desired scene | 39 |
| Repeat playback | 40 |
| Program playback (CD) | 41 |
| Random playback (CD) | 41 |
| MP3/WMA/JPEG playback | 42 |
| Setting the JPEG Interval | 44 |
| Setting the Select Files | 45 |
| Zooming (JPEG CD) | 46 |
| Changing angles (JPEG CD) | 46 |
| Marking desired scenes | 47 |
| Changing soundtrack language | 48 |
| Karaoke playback | 48 |
| Subtitles | 49 |
| Changing angles | 49 |
| Title selection | 49 |
| DVD menu | 49 |

Advanced Function of DVD section

| | |
|---|----|
| Parental control | 50 |
| Temporary disabling of rating level by DVD disc | 51 |
| Setting menu language | 52 |
| Setting subtitle language | 53 |
| Setting audio soundtrack language | 54 |
| Setting surround sound | 54 |
| Setting the aspect ratio of TV screen | 55 |
| Setting on screen display | 56 |
| Status display of disc | 56 |
| Dynamic Range Control | 57 |
| Language code list | 58 |

Additional information

| | |
|------------------------------------|----|
| Problems and troubleshooting | 59 |
| Video head cleaning | 60 |
| Specifications | 61 |

Parts and functions

Front

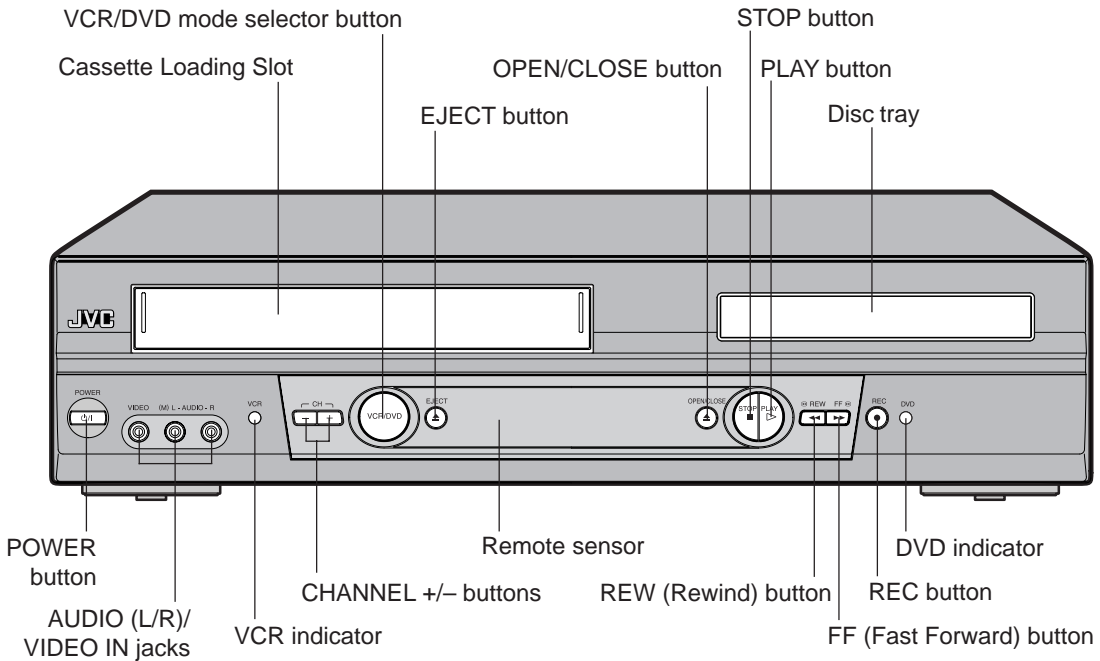

Rear

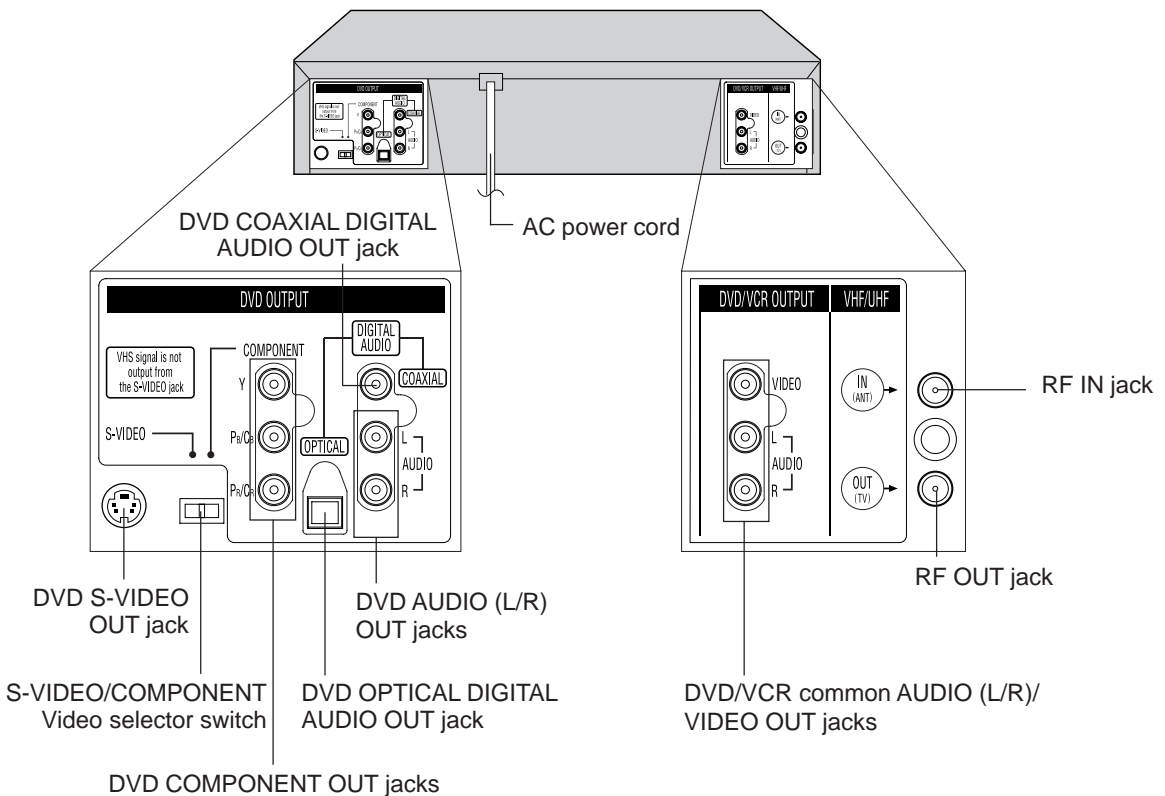

Display window

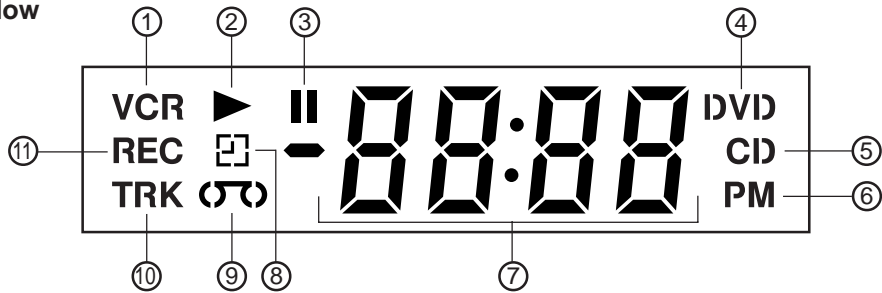

| No. | Display | Description |
|-----|---------|---|
| ① | VCR | VCR mode |
| ② | ▶ | Playback (lights) / Auto resume (flashes) |
| ③ | ⏸ | Still picture |
| ④ | DVD | DVD disc is inserted. |
| ⑤ | CD | CD is inserted. |
| ⑥ | PM | Display for afternoon (lights out in the morning) |
| ⑦ | 10 : 00 | Clock display (colon [:] flashes) |
| | 01 : 00 | Counter display by hour/minute at VCR/DVD / by minute/second at CD |
| | 2 | Track number display for CD |
| | CH02 | TV channel display for VCR |
| | C036 | CATV channel display |
| | Err | Error display |
| | L | External input display |
| | Pbc | Playback Control (Video CD) |
| ⑧ | ⏮ | Timer recording display |
| ⑨ | ⏮ | Video tape is in the unit |
| ⑩ | TRK | Track display for CD |
| ⑪ | REC | Normal recording display (flashes during Instant Timer Recording - ITR) |

Explanation for On-Screen-Symbol (DVD):

- | | | |
|---------------------------------------|------------------------------|---------------------------|
| ▶ Playback | ⏮ Open or Close the tray | 🔊 Angle |
| ■ Stop | ⏮ Auto resume | 🔍 Zoom |
| ⏸ Still picture | ⏮▶▶▶ Direction button's mark | 🔒 Parental level locked |
| ⏮▶▶▶ Frame advanced playback | ⏮▶▶▶ A-B A-B repeat | 🔓 Parental level unlocked |
| ▶▶▶ Forward slowmotion | ⏮▶▶▶ Subtitle language | 📺 Screen size: Letter box |
| ▶▶▶ Fast Forward playback | ⏮▶▶▶ Soundtrack language | 📺 Screen size: Pan scan |
| ◀▶▶ Review playback | 🔊 Output sound for Video-CD | 📺 Screen size: Wide |
| ▶▶▶ Skip chapter to forward direction | 🎤 Karaoke vocal setting | 🚫 Shows prohibited act |
| ◀▶▶ Skip chapter to reverse direction | | |

NOTE:

Some discs may be displayed wrong or e.g. chapter number, playback time, etc. may not be displayed.

Remote control



TV Multi-Brand Remote Control

This Remote can control some functions (TV POWER, NUMBER(0-9), INPUT, TV VOL +/-, TV CH +/- and ENTER) of a remote controllable TV of JVC and the brands listed on page 10 by slide TV/VCR/DVD switch to TV.

(The POWER button on the upper right is not effective for the TV.)

NOTES:

- It's not possible to operate a unit not equipped with a remote sensor.
- When you operate the VCR or DVD, the TV/VCR/DVD switch must be slid to VCR/DVD again. Otherwise the DVD/VCR may not operate properly.
- Since this unit is combined type of DVD and VCR, the remote code of DVD is individual. So please note that the DVD-keys on the RCU of the other JVC RECEIVER/TV is not effective for this unit.

| | | Page |
|-------------------|--|----------------------|
| TV/VCR/DVD switch | Switch to operate TV or VCR or DVD | 18,36 |
| POWER | Power on/off | 18 |
| DVD MENU | Display menu of DVD software | 49 |
| MARKER | Locating desired scene | 47 |
| RETURN | Remove DVD set up menu | 36,51 |
| OPEN/CLOSE | Open or Close the tray | 37 |
| DISPLAY | Change the front Display mode | 27 |
| SUBTITLE | Set Subtitle of a DVD disc | 49 |
| A.TRK | Digital AUTO TRACKING | 26 |
| ANGLE | Change playback angle of a DVD disc | 46,49 |
| C. RESET | Reset the counter to 00:00 | 27 |
| SEARCH MODE | Index for DVD | 39 |
| ZERO RETURN | Stop the tape when the counter reaches 00:00 | 27 |
| PLAY MODE | Select playback mode | 40,41 |
| SP/EP | Sets the tape speed for recording | 28,30 |
| ZOOM | Zoom (DVD/VCD) | 39,46 |
| TITLE | Select title of a DVD disc | 49 |
| REPEAT A-B | Repeat playback between A and B (DVD/CD) | 40 |
| 0-9 | Direct channel selection of TV | 20,28 |
| | Input setting | 39,41 |
| | Enter a password | 50,51 |
| TIMER | Set the unit to start recording at a preset time. | 31,32 |
| TV/VCR | Switches between TV and VCR | 18,29 |
| TV POWER | Turn the connected TV on or off | 8 |
| INPUT | Switch the connected TV to external mode | 8 |
| TV VOL +/- | Adjust the connected TV's volume | 8 |
| REW | Rewind/Review playback | 25,26,38 |
| PLAY | Playback | 25,37 |
| FF | Fast Forward/Forward search playback | 25,26,38 |
| REC | Recording | 28,30,34 |
| STOP | Stop | 25,37 |
| PAUSE | Still picture/Recording pause on/off | 26,29,34,38 |
| SKIP ◀▶ | Skip chapter to forward or reverse direction | 38,43 |
| INDEX ◀▶▶ | Search for the INDEX mark of a tape | 27 |
| TV/VCR CH +/- | Select channel of the connected TV or VCR | 8,28,30,34 |
| ▲ / ▼ | Cursor buttons | |
| SET -/+ | Setting buttons | 31,32 |
| | Manual tracking buttons in playback mode | 26 |
| | Cursor buttons - To move Up in the VCR menu you press the ▶. To move Down in the VCR menu you press the ◀. | |
| ENTER | Enter information in the menu | |
| SELECT | Select option in the menu | |
| SET UP MENU | Display menu of setup | 18,19,36,44-45,52-56 |
| CANCEL | Delete Timer program | 32 |
| | Cancel input data in the setting mode | 23,31,39,41 |
| OSD | Display VCR or DVD operation status | 29,56 |
| A.MONITOR | Switches sound between mono and stereo | 33 |
| | Change sound track language of DVD | 48 |
| SLOW | Slowmotion playback | 26,38 |
| SKIP SEARCH | Skip the unwanted short material of a tape | 26 |

Inserting Batteries

- 1 Open the battery compartment cover in the direction of the arrow.

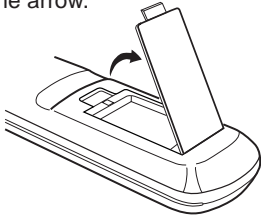

- 2 Install two "AA" batteries (supplied), paying attention to the polarity diagram in the battery compartment.

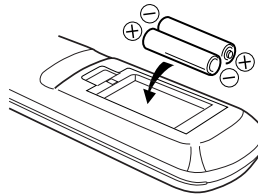

- 3 Replace the compartment cover.

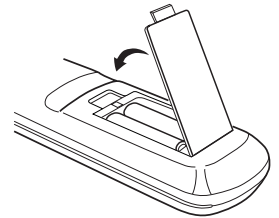

Battery precautions

The precautions below should be followed when using batteries in this device:

1. Use only the size and type of batteries specified.
2. Be sure to follow the correct polarity when installing the batteries as indicated in the battery compartment. Reversed batteries may cause damage to the device. To avoid a potential short circuit, insert the "-" end first.
3. Do not mix different types of batteries together (e.g. Alkaline and Carbon-zinc) or old batteries with fresh ones.
4. If the device is not to be used for a long period of time, remove the batteries to prevent damage or injury from possible battery leakage.
5. Do not try to recharge batteries not intended to be recharged; they can overheat and rupture. (Follow battery manufacturer's directions.)

Remote control basics

- Press **POWER** to turn the DVD/VCR on or off.
- Make sure **TV/VCR/DVD** switch is set to VCR/DVD.
- Tap **VCR CH +** or **VCR CH -** to move through the channels one channel at a time.
- The **VCR CH +/-** and **SET +/-** are also used to navigate on-screen menu system.
- You can directly access specific channels using **Number keys** pad.
- Each press of **VCR** or **DVD**, switches the screen between the VCR screen (VCR mode) and the DVD screen (DVD mode).

Operation

- Aim the remote control at the remote sensor and press control buttons to operate.
- Operate the remote control within 30° angle on either side of the remote sensor, up to a distance of Approx. 5 meters.

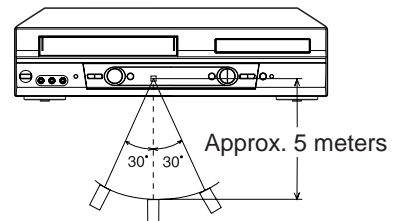

TV multi-brand remote control

The DVD/VCR's remote control can control several functions on JVC remote control TVs and on the brands of remote control TVs listed below.



Preparation:

- Turn the power off the TV using the TV's remote control.
- Make sure **TV/VCR/DVD** switch has been slid to TV.

1 Press and hold **VCR** on the remote control until you finish the step 2.

2 Enter your TV's brand code using the **Number keys**, then press **ENTER**.

- Once you have set the remote control to operate the TV, you don't have to repeat this step until you replace your remote control's batteries.
- PANASONIC has two codes. If the TV does not function with one code, try entering the other.

3 First, press **TV POWER** on the remote to see if the TV's power goes on as it should. If it does, try other operations.

- The **TV POWER**, **TV CH+/-**, **TV VOL+/-**, **ENTER**, **INPUT** and **Number keys** on the remote can all be used to operate the TV. *For some brands of TV, you must press **ENTER** after having pressed the **Number keys**.

| TV BRAND NAME | BRAND CODE |
|---------------|------------|
| JVC | 01 |
| MAGNAVOX | 02 |
| MITSUBISHI | 03 |
| PANASONIC | 04, 11 |
| RCA | 05 |
| SHARP | 06 |
| SONY | 07 |
| TOSHIBA | 08 |
| ZENITH | 09 |
| HITACHI | 10 |
| SAMSUNG | 12 |
| SANYO | 13 |
| SEARS | 13 |

NOTE:

Depending on the type of TV, there may be cases where some or all functions cannot be operated using the remote control.

Control four JVC VCRs

The remote control is capable of controlling four JVC VCRs independently; one set to respond to your remote control's A code control signals and the other set to respond to B, C, D code control signals. The remote control is preset to send A code signals because your DVD/VCR is initially set to respond to A code signals. You can easily modify your DVD/VCR to respond to the other code signals.

Preparation:

Make sure **TV/VCR/DVD** switch has been slid to VCR/DVD.

- 1 Press and hold **VCR** on the remote control until you finish the step 2.
- 2 Press one of the following buttons to enter the desired code, then press **ENTER**.

- 1: sets the remote control code to "A"
- 2: sets the remote control code to "b"
- 3: sets the remote control code to "C"
- 4: sets the remote control code to "d"



- 3 To turn off the unit, press **POWER** on the front panel.

- 4 Press **PLAY** on the front panel for 5 seconds. The current setting code of the unit appears on the display.



- 5 Press **STOP** on the remote control. The new code is transmitted to the unit and blinks for about 4 seconds on the display, then the clock time appears.

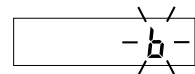

- 6 Press **POWER** on the remote control. When the unit is turned on, the setting is complete. If the unit is NOT turned on, repeat from step 1.

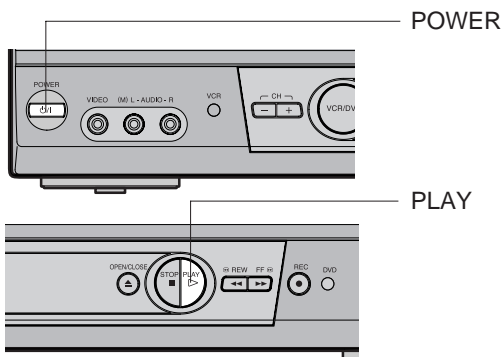

Basic connections

If you are using an antenna system, follow these instructions. If you are a cable (CATV) subscriber, skip ahead to page 14 for the proper connections.

ANTENNA TO DVD/VCR CONNECTION

The DVD/VCR must be connected "between" the antenna and the TV. First, disconnect the antenna from the TV and connect it to the DVD/VCR. Then connect the DVD/VCR to the TV. Below are 3 common methods of connecting an antenna system to a DVD/VCR. Find the type of antenna system you are using and follow the connection diagram.

1

Combination VHF/UHF Antenna with 75 ohm Coaxial Cable

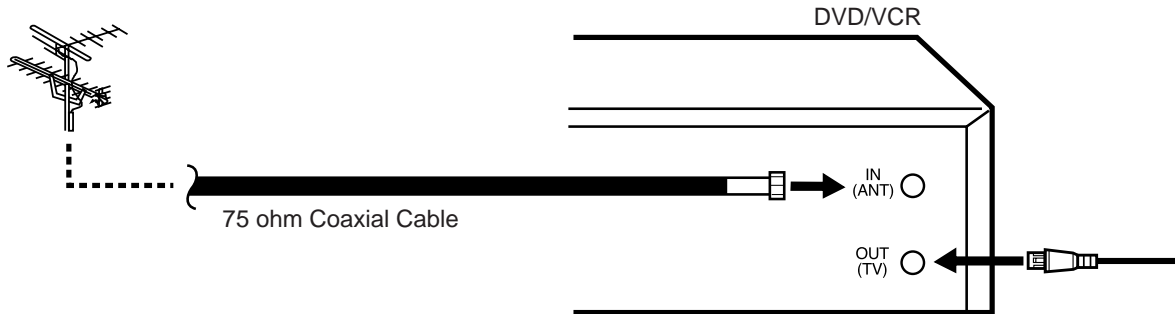

2

Combination VHF/UHF Antenna with 300 ohm Twin Lead (Flat) Wire

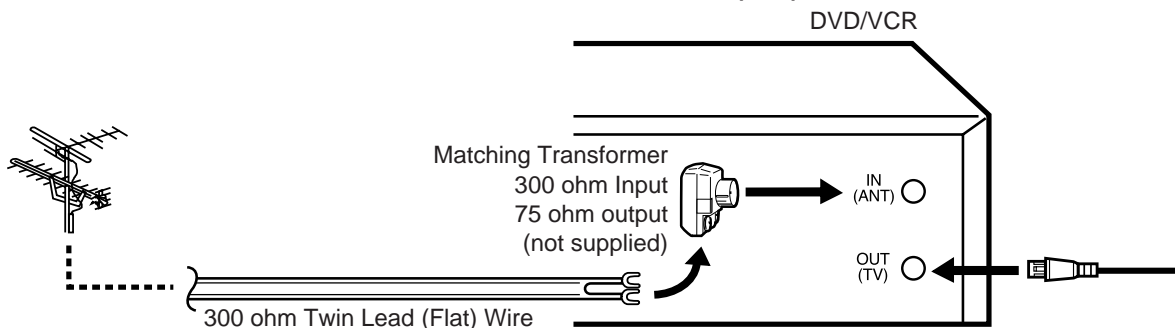

3

Separate VHF and UHF Antennas

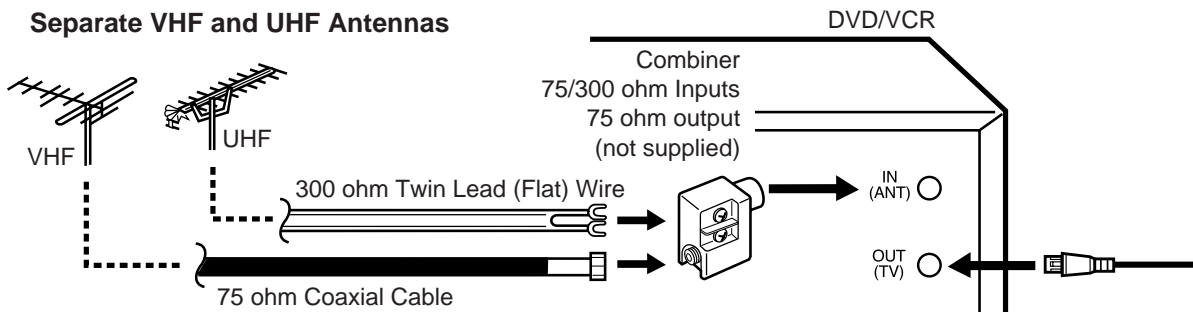

NOTE: If both VHF and UHF antennas have 300 ohm twin lead (flat) wires, use a combiner having two 300 ohm inputs and one 75 ohm output.

- NOTES:**
- A clear picture will not be obtained by the DVD/VCR unless the antenna signal is good. Connect the antenna to the DVD/VCR properly.
 - For better quality recording, an indoor antenna or a telescopic antenna is not recommended. The use of an outdoor type antenna is required.
 - If you are not sure about the connection, please refer to qualified service personnel.

DVD/VCR TO TV CONNECTION

After you have connected the antenna to the DVD/VCR, you must connect the DVD/VCR to the TV. Below are 3 common methods of connecting your DVD/VCR to a TV. Find the type of TV you are using and follow the connection diagram.

This DVD/VCR has a single 75 ohm output for connection to a TV. If your TV has separate VHF and UHF antenna inputs (numbers 2 and 3 below), use a splitter to connect the DVD/VCR to the TV for VHF and UHF reception.

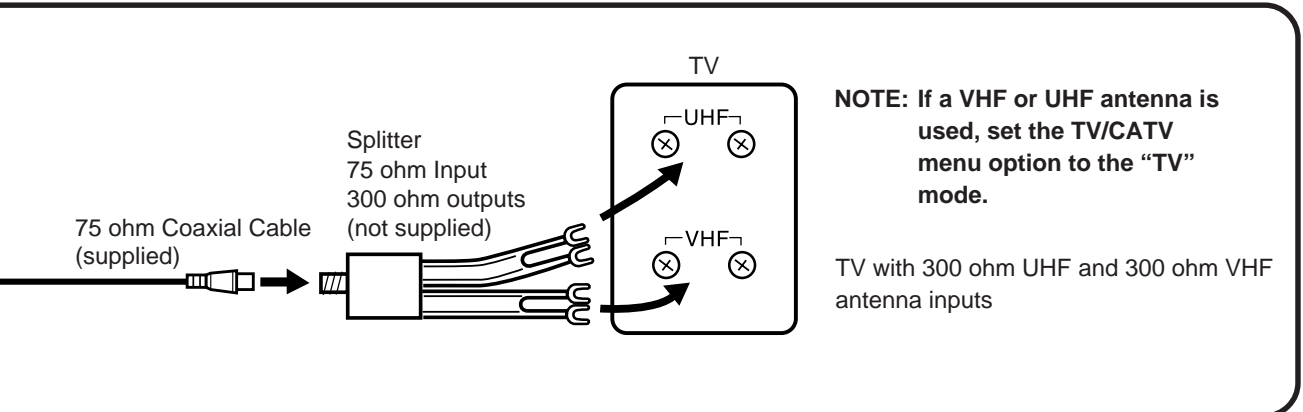
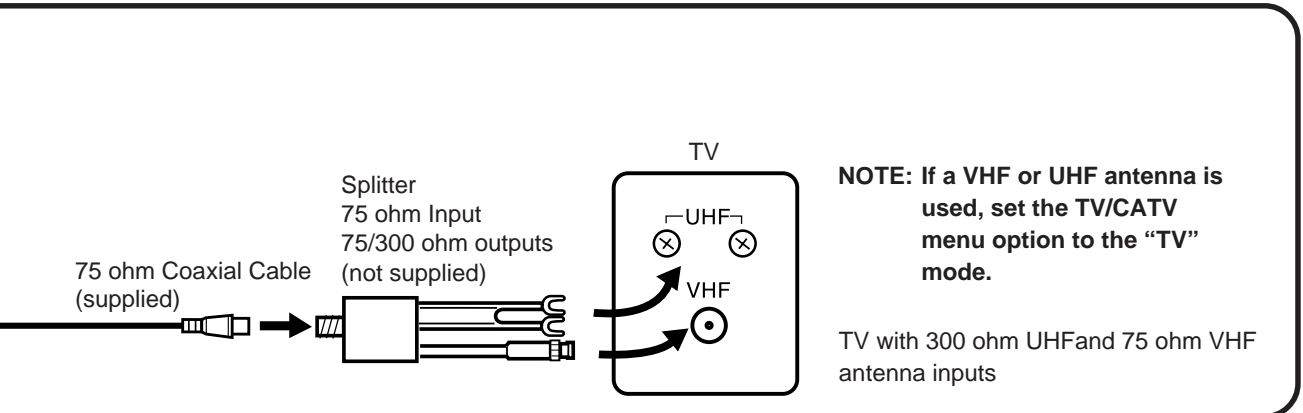
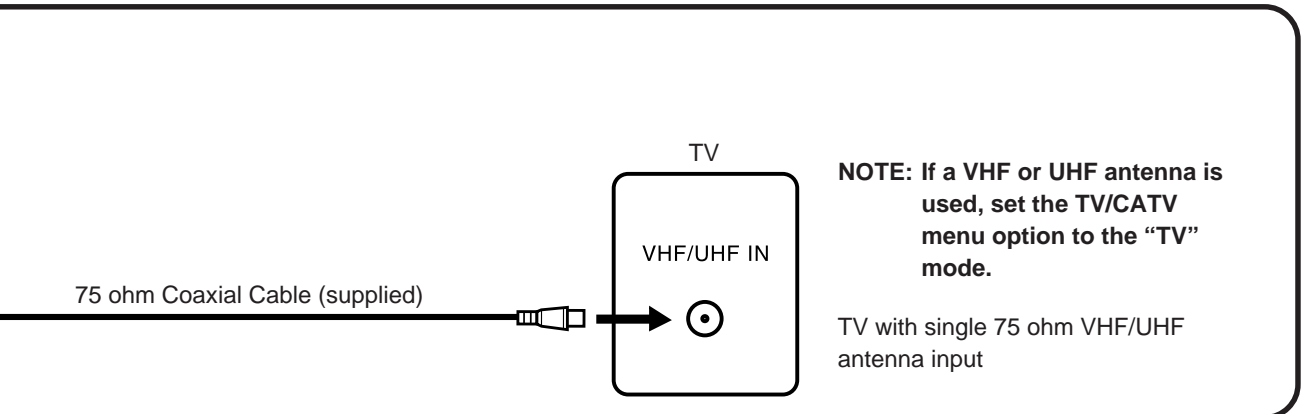

CATV (CABLE TV) connections

Many cable companies offer services permitting reception of extra channels including pay or subscription channels. This DVD/VCR has an extended tuning range and can be tuned to most cable channels without using a cable company supplied converter box, except for those channels which are intentionally scrambled. If you subscribe to a special channel which is scrambled, you must have a descrambler box for proper reception.

1

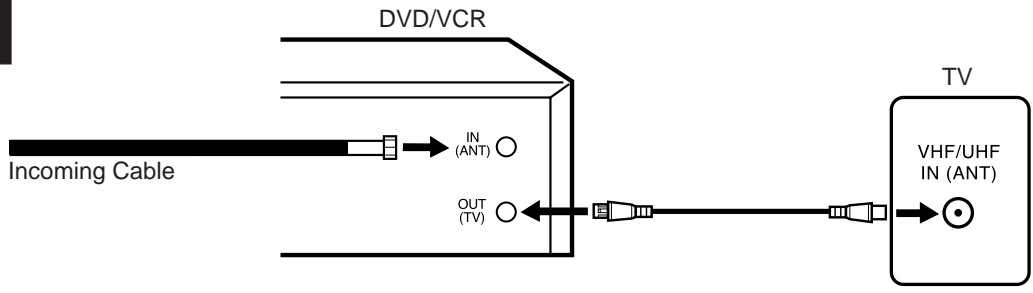

DVD/VCR

IN (ANT)

OUT (TV)

Incoming Cable

TV

VHF/UHF IN (ANT)

ALLOWS:

- * Recording of nonscrambled channels.
- * Use of the programmable timer.
- * Recording of one channel while watching another.

2

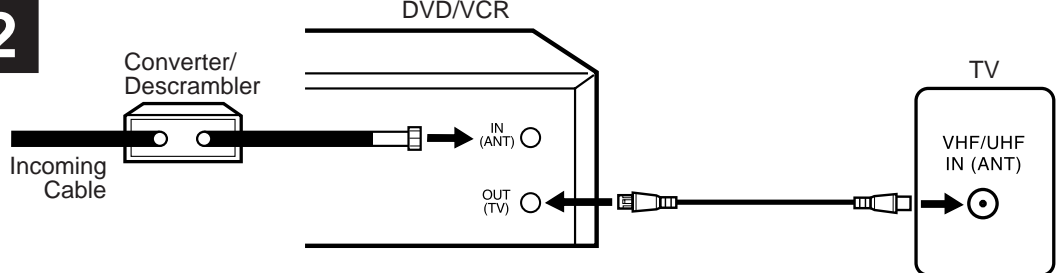

DVD/VCR

IN (ANT)

OUT (TV)

Incoming Cable

Converter/Descrambler

TV

VHF/UHF IN (ANT)

ALLOWS:

- * Recording of channels through the converter box (scrambled and unscrambled).
- * Using the programmable timer to record only the channel selected at the converter box.

PREVENTS:

- * Recording one channel while watching another.
- * Using the DVD/VCR tuner to select channels.

NOTE:

To record from converter/descrambler, DVD/VCR tuner must be tuned to the converter output channel, usually channel 3 or 4.

3

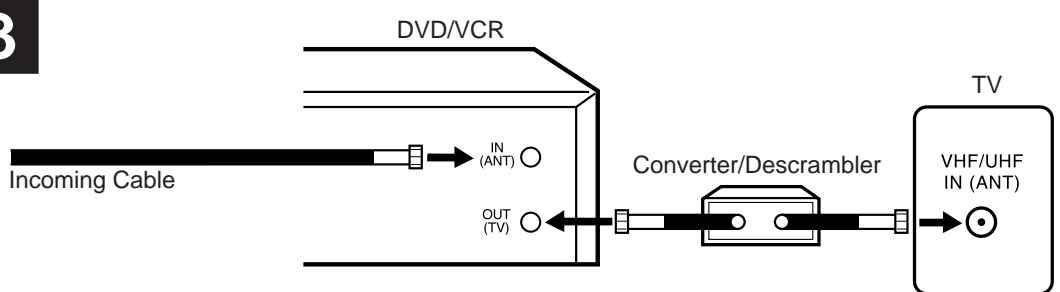

DVD/VCR

IN (ANT)

OUT (TV)

Incoming Cable

Converter/Descrambler

TV

VHF/UHF IN (ANT)

ALLOWS:

- * Recording of nonscrambled channels.
- * Use of the programmable timer.
- * Recording an unscrambled channel while watching any channel selected at the converter box.

PREVENTS:

- Recording scrambled channels.

NOTE:

If you are playing a tape or using the tuner built into the DVD/VCR, the converter must be set to the video channel output of the DVD/VCR (either 3 or 4).

NOTE: Whenever a Converter/Descrambler box is placed before the DVD/VCR, you must tune the DVD/VCR to the output of the Converter/Descrambler box, usually channel 3 or 4.

CATV (CABLE TV) connections

IMPORTANT: Make sure the TV/CATV menu option is set to the "CATV" mode.

This DVD/VCR cannot receive scrambled programs since it does not contain a descrambler. In order to receive scrambled programs, your existing descrambler must be used. Descrambler boxes are available from cable companies. Consult your local cable company for more information concerning connection to their descrambler equipment. There are many ways to connect your DVD/VCR to a cable system. Below are six common methods of connection.

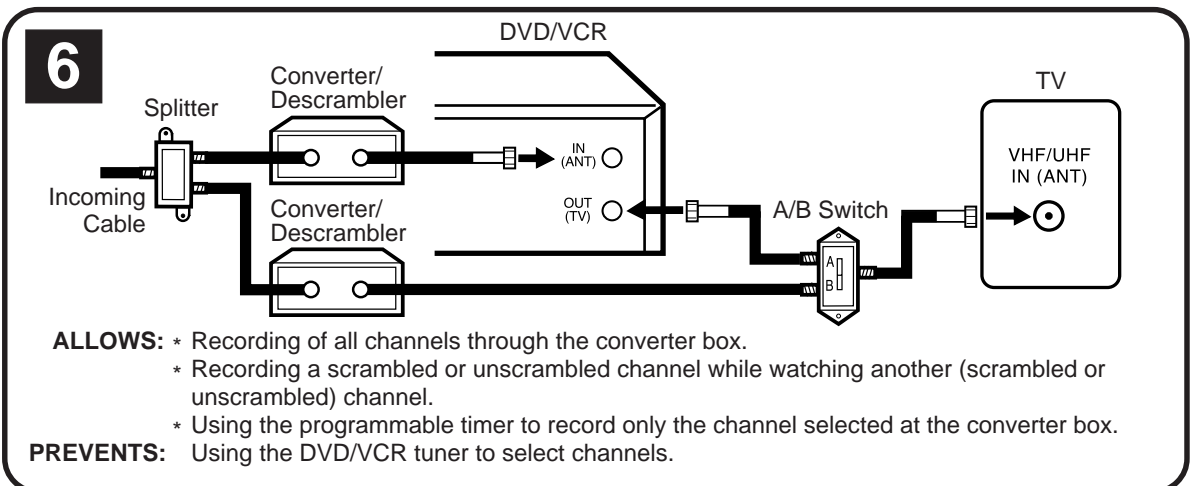
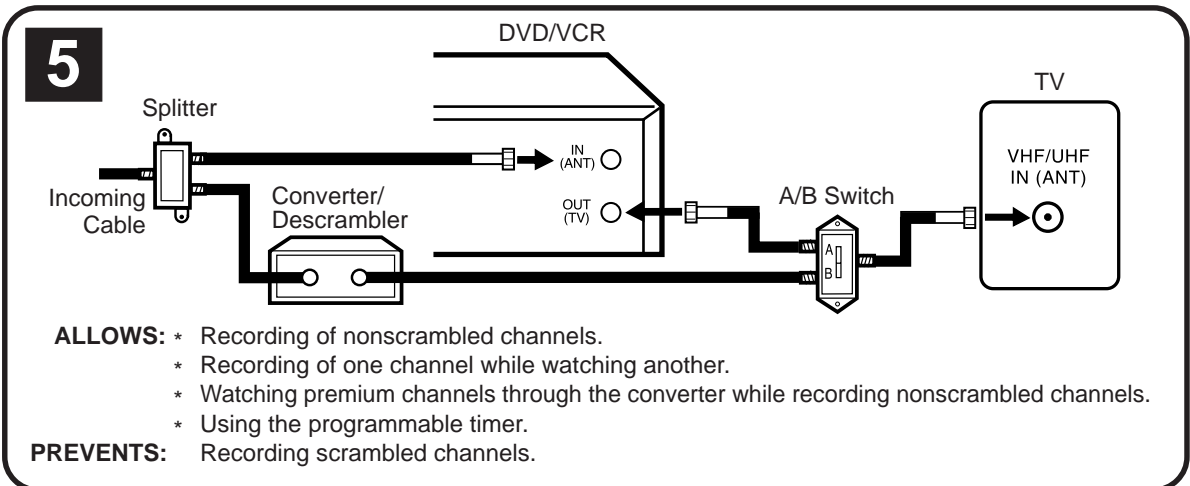
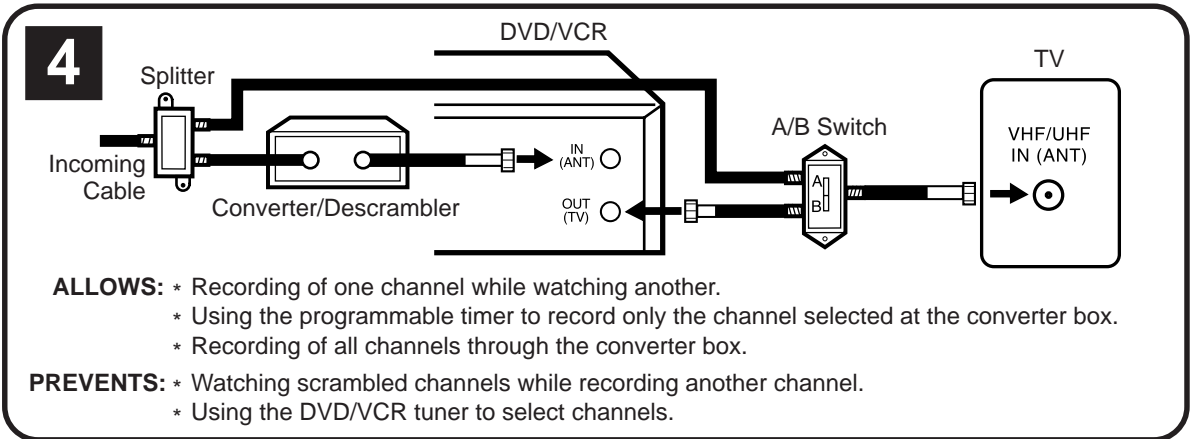

Playback connections

The exact arrangement you use to interconnect various video and audio components to the DVD/VCR is dependent on the model and features of each component. Check the Owner's Manual provided with each component for the location of video and audio inputs and outputs.

Connect to a TV with Audio/Video Output

You can enjoy playback by simply connecting the unit to a TV.

Connect the unit to a TV equipped with stereo audio input and video input jacks using the supplied audio/video cable.

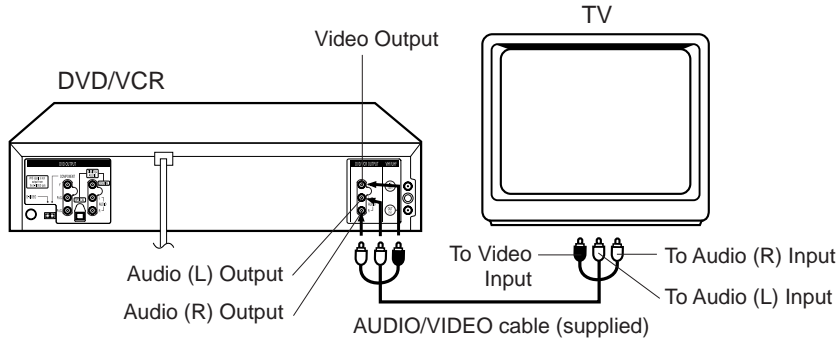

Connect to a TV with S-Video Output (for DVD/CD playback)

If your TV has an S-VIDEO input, you can get better quality by connecting it with the S-VIDEO output of the unit using the S-video cable instead of connecting the video input of the TV to the VIDEO jack of the unit.

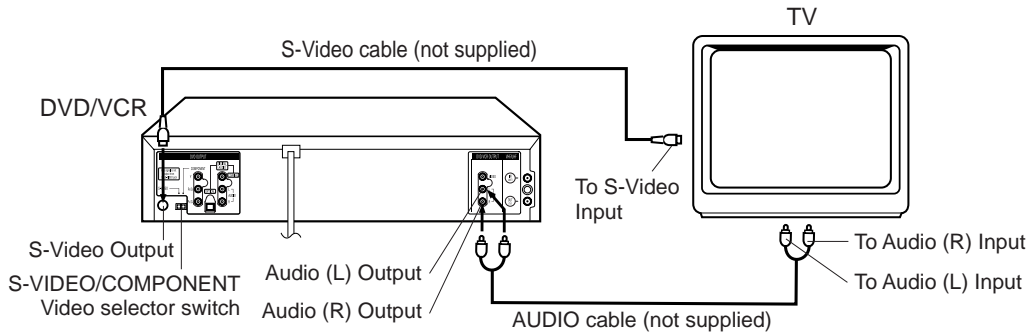

Connect to a TV with Component Video Output (for DVD/CD playback)

You can enjoy high picture quality by connecting the unit's COMPONENT VIDEO OUT jacks to the COMPONENT VIDEO IN jacks of your TV with the COMPONENT video cables (not supplied).

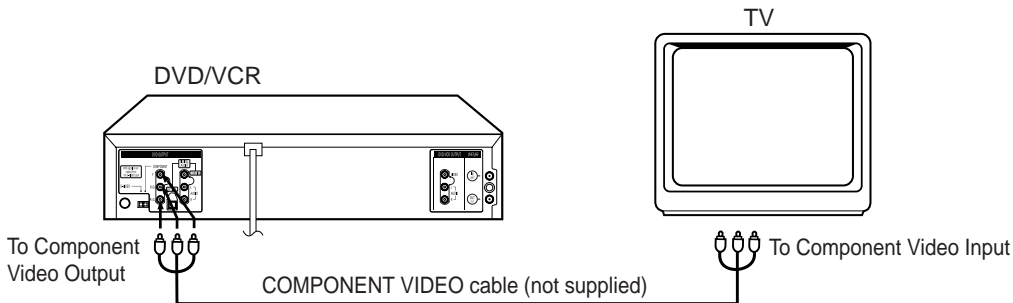

NOTES:

- When you connect to a TV with S-video jack or component jacks, set the S-VIDEO/COMPONENT Video selector switch to the desired position. And also you must select the corresponding video input on your TV.
- When the component video input jacks on the TV is of the BNC type, use an adapter to convert a pin jack to a BNC jack (optional).

Connect to a Stereo Amplifier with Audio Output

You can enjoy high-quality audio by connecting the unit's audio output to your amplifier. Connect the unit's AUDIO OUT jacks to any line-level inputs (such as AUX, DVD, CD, etc.) of an audio amplifier.

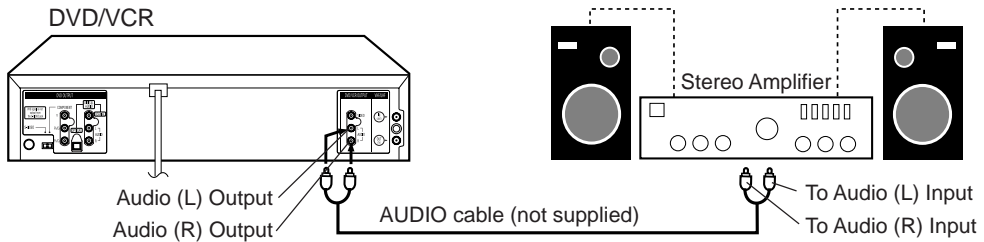

Connect to an AV Amplifier with built-in digital surround

If you are using an Amplifier with a built-in digital surround as follows, you can enjoy the various audio systems such as Dolby Digital and DTS by using the Optical or Coaxial Digital Output.

Use this connection to connect an:

- AV amplifier with built-in *Dolby Digital decoder
- AV amplifier with built-in *DTS decoder

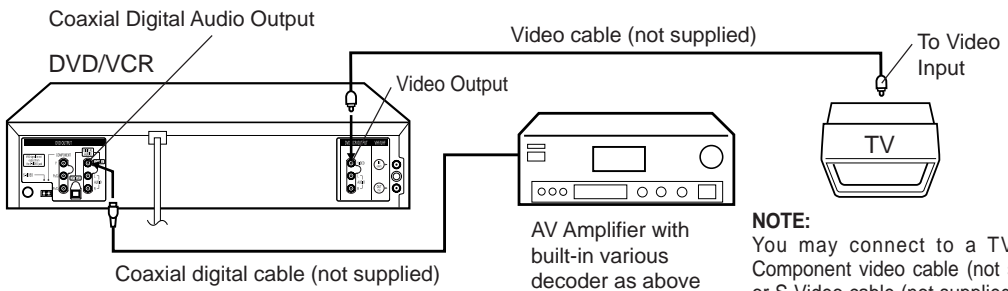

NOTE:
You may connect to a TV with a Component video cable (not supplied) or S-Video cable (not supplied) instead of a video cable (not supplied).

Connecting the optical digital cable

You may connect to an AV Amplifier with an **Optical digital cable (not supplied)** instead of a Coaxial digital cable.

When you connect the optical digital cable (not supplied), remove the dust protection cap from the rear panel. When not using the optical digital cable, attach the dust protection cap to protect against dust.

NOTES:

- The OPTICAL, COAXIAL, AUDIO L/R, S-VIDEO and COMPONENT jacks are useful only for DVD section. The VHS signal is output only from the composite jack (DVD/VCR VIDEO OUTPUT) and UHF/VHF OUT.
- When you make the connections above, do not set DOLBY DIGITAL to DOLBY DIGITAL or DTS to ON on the AV Amplifier. If you do, a loud noise will suddenly come out from the speakers, affecting your ears or causing the speakers to be damaged.
- Caution for the **optical** digital audio output connector: Do not connect to an amplifier (with an optical digital input connector) which does not contain a Dolby Digital or DTS decoder. Otherwise, any attempt to play DVDs may cause such a high level of noise that it may be harmful to your ears and damage your speakers.
- DTS audio will be output only from the COAXIAL or OPTICAL output. To hear DTS audio, DTS-Decoder is necessary.
- When playing DTS-encoded CDs, only noise will be heard from the speakers or analogue stereo outputs.
- Some DTS decoders which do not support DVD-DTS interface may not work properly with the unit.

Setting the video channel/Setting the language

Setting the Video Channel

To view playback of a recorded tape, or to watch a program selected by the VCR's channel selector, the TV must be set to channel 3 or 4 (video channel).



NOTES:

- If the unit does not operate properly, or No key operation (by the unit and/or the remote control): Static electricity, etc., may affect the player's operation. Disconnect the AC power cord once, then connect it again.
- If no buttons are pressed for more than 60 seconds, the MENU screen will return to normal TV operation automatically.
- Both the VCR and the DVD have their own menu options (See page 36).

When a TV is connected with the 75 ohm coaxial cable only.

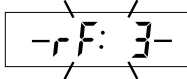
- 1 Press and hold **3** or **4** on the remote for 3 seconds in standby mode. The video channel will start to flash for 3 seconds in the display window. 
- 2 Press **POWER** to turn on the DVD/VCR.
- 3 Slide **TV/VCR/DVD** switch to VCR/DVD. Then press **VCR** to select the VCR mode. The VCR indicator on the front panel will light.
- 4 Turn ON the TV and set to CH 3 or 4 to correspond with the channel selected in step 1.
- 5 Press **TV/VCR** to select the VCR position. The VCR indicator will appear in the display window.
- 6 Select any channel to receive a TV station in your area. The channel number will appear on the screen for about 4 seconds.

For a push-button TV tuner

If CH 3 or 4 corresponding to the video channel cannot be tuned on your TV, proceed as follows: set the VCR 3/4 channel selector and the TV to CH 3 or 4, play back a prerecorded tape and tune the TV to receive a sharp color picture from the video cassette recorder. Refer to your TV owner's manual for details.

Setting the language

You can choose from three different languages (English, French and Spanish) for the on-screen displays.

- 1 Press **SET UP MENU**. The VCR menu screen will appear. Press **◀** or **▶** to select "SYSTEM SETUP", then press **ENTER**. If you use the unit for the first time and press **SET UP MENU**, instead of the main menu screen on the right the "SYSTEM SETUP" menu screen in step 2 may appear.
- 2 Press **◀** or **▶** to select the "LANGUAGE" option, then press **ENTER**.
- 3 Press **◀** or **▶** to select the desired language: English (ENGLISH), Spanish (ESPAÑOL) or French (FRANCAIS), then press **ENTER**.

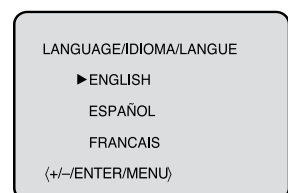
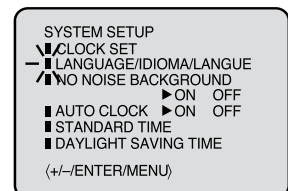
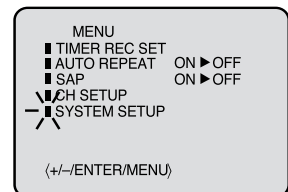

- 4 Press **SET UP MENU** until the MENU screen is cleared.

Tuner setting

This DVD/VCR is equipped with a channel memory feature which allows channels to skip up or down to the next channel set into memory, skipping over unwanted channels. Before selecting channels, they must be programmed into the DVD/VCR's memory. In addition to normal VHF and UHF channels, this DVD/VCR can receive up to 113 Cable TV channels. To use this DVD/VCR with an antenna, set the TV/CATV menu option to the TV mode. When shipped from the factory, this menu option is in the CATV mode.



NOTE:
You can not select "CH SETUP" if you set the channel to "L".

Preparation:

- Turn ON the TV and set it to the video input mode.
- Make sure **TV/VCR/DVD** switch has been slid to VCR/DVD. Then press **VCR** to select the VCR mode. (The VCR indicator will light.)

TV/CATV Selection

1 Press **SET UP MENU**. The VCR menu screen will appear. Press **◀** or **▶** to select "CH SETUP", then press **ENTER**.

2 Press **◀** or **▶** to select the "TV/ CATV" option.

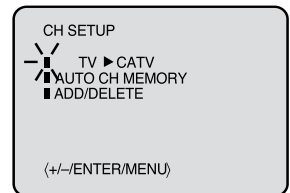

3 Then press **ENTER** to select the TV or CATV mode. The arrow indicates the selected mode.

TV - VHF/UHF channels
CATV - CABLE TV channels

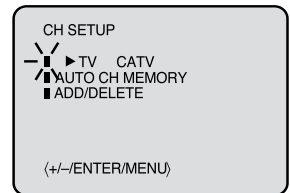

4 Press **SET UP MENU** until the menu screen is cleared.

Setting channels automatically

The VCR can receive a maximum of 181 channels by presetting the channels into memory.

1 Repeat above step 1 and press **◀** or **▶** to select "AUTO CH MEMORY".

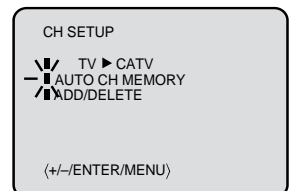

2 Then press **ENTER**. The auto tuning will start. The channel display will count up and when finished, the screen returns to normal.

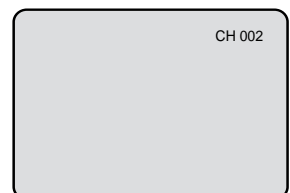

To ADD/DELETE channels/Noise elimination

To ADD/DELETE channels

You can add the channels you want or delete the channels you do not want manually.



Preparation:

- Turn ON the TV and set it to the video input mode.
- Make sure **TV/VCR/DVD** switch has been slid to VCR/DVD. Then press **VCR** to select the VCR mode. (The VCR indicator will light.)

- 1 Repeat the step 1 on page 19. Then press ◀ or ▶ to select the "ADD/DELETE" option and press **ENTER**.

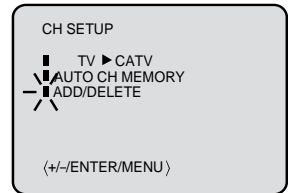

2 To Add or Delete desired channels

- 1 Press **Number keys** or ◀/▶ to select a channel number you want to add or delete.

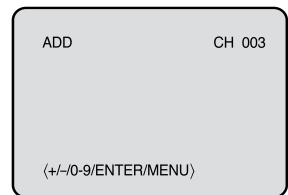

- 2 **To add channels**
Press **ENTER** until "ADD" appears on the screen to set to add the unmemorized channel.

To delete channels

Press **ENTER** until "DELETE" appears on the screen to set to delete the channel from memory. The channel number will blink.

- 3 Repeat 1 to 2 to add or delete other channel.

3 Press **SET UP MENU** until the menu screen is cleared.

Noise elimination

When you don't want to receive a weak signal broadcast, the Blue back screen can be obtained by selecting the **NO NOISE BACKGROUND "ON"**. When the unit is shipped from the factory, the **NO NOISE BACKGROUND** is set to the "ON".

- 1 Repeat the step 1 on page 18 and press ◀ or ▶ to select "NO NOISE BACKGROUND".

- 2 Press **ENTER** to select the "ON" position.

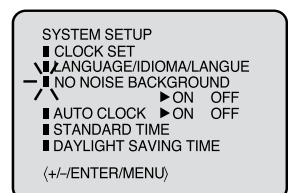

- 3 Press **SET UP MENU** until the menu screen is cleared.

Auto clock setting

The Auto Clock feature enables the automatic clock setting and updating, and also to set the Time Zone and Daylight Saving Time by receiving XDS (Extended Data Service) information carried on the channel signal.



NOTES:

- After Auto Clock setting, in some case the clock may display the other time zone's. You can correct the clock by selecting your Time Zone setting above.
- When the clock is not set or you set the clock manually, Time Zone setting is not available.

Preparation:

- You must set the antenna connection before the AC cord plug is inserted into the AC outlet.
- Make sure the AUTO CH MEMORY (on page 19) is done.

Auto clock setting

WAIT 30 MINUTES! when the power switch is off, after the connections of the antenna and the power plug. Because the Auto Clock setting feature is activate. After the clock is set automatically, you may have to set the Time Zone and Daylight Saving Time. Press **POWER** to turn on the DVD/VCR after the Auto Clock operation completed.

- When shipped from factory, the AUTO CLOCK option is set to ON position.
- The Auto Clock setting will be performed at 6:00 AM, 12:00 PM and 6:00 PM everyday when the DVD/VCR is turned off. If you turn the DVD/VCR on during Auto Clock setting, the clock is not set.
- With cable box connection, if the Auto Clock Setting is unsuccessful, please select the PBS channel carrying the XDS information, then turn the DVD/VCR off. After 30 minutes, turn the DVD/VCR on, and if the clock is not set automatically, set the clock manually (see page 23).

Time Zone setting (STANDARD TIME)

In the rare event that you live within broadcast range of two stations in two different time zones, the DVD/VCR may recognize the wrong station for the Auto Clock setting.

To correct the situation:

Preparation:

- Turn ON the TV.
- When a TV is connected with an audio/video cable, select the video input mode on the TV.
- When a TV is connected only with an antenna cable, set to the video channel 3 or 4. Then select VCR position with **TV/VCR**.
- Make sure **TV/VCR/DVD** switch has been slided to VCR/DVD. Then press **VCR** to select the VCR mode. (The VCR indicator will light.)

1 Press **SET UP MENU**. The VCR menu screen will appear. Press **◀** or **▶** to select the "SYSTEM SETUP" menu, then press **ENTER**.

2 Press **◀** or **▶** to select the "STANDARD TIME" option, then press **ENTER**.

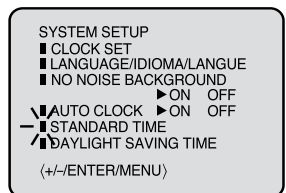

3 Press **◀** or **▶** to select your Time Zone, then press the **ENTER**.

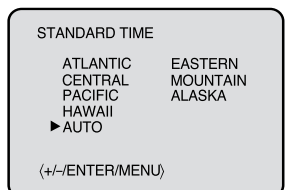

4 Press **SET UP MENU** until the MENU screen is cleared.

Auto clock setting

Daylight Saving Time setting

You can set the Daylight Saving Time automatically or manually.

Preparation:

- Turn ON the TV.
- When a TV is connected with an audio/video cable, select the video input mode on the TV.
- When a TV is connected only with an antenna cable, set to the video channel 3 or 4. Then select VCR position with **TV/VCR**.
- Make sure **TV/VCR/DVD** switch has been slid to VCR/DVD. Then press **VCR** to select the VCR mode. (The VCR indicator will light.)



- 1 Repeat the step 1 on page 21 and press ◀ or ▶ to select “DAYLIGHT SAVING TIME”, then press **ENTER**.

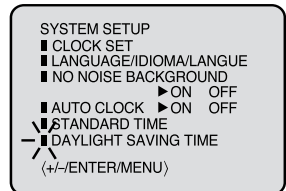

- 2 Press ◀ or ▶ to select one of the options, then press **ENTER**.

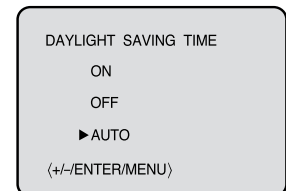

- ON:** for manual setting
(forward one hour)
- OFF:** for manual setting
(back one hour)
- AUTO:** for automatic setting
(read XDS in the signal)

When you want to set the Daylight Saving Time manually, on the first Sunday in April you set to “ON”, and on the last Sunday in October you set to “OFF”.

- 3 Press **SET UP MENU** until the menu screen is cleared.

NOTES:

- When shipped from factory, the DAYLIGHT SAVING TIME option is set to “AUTO” position.
- When the clock is not set, Daylight Saving Time setting is not available.
- When there is no Daylight Saving Time in your area, always select “OFF” position in step 2.

Manual clock setting

You must set the date and time manually for timer recordings and Daylight Saving Time if the Auto Clock process did not set them correctly.



NOTE:

After a power failure or disconnection of the power, the timer settings will be lost. In this case, reset the present time.

Preparation:

- Turn ON the TV and set to the video input mode.
- Make sure **TV/VCR/DVD** switch has been slid to VCR/DVD. Then press **VCR** to select the VCR mode. (The VCR indicator will light.)

EXAMPLE: Setting the clock to "8:30 AM" October, 26 (SUN), 2003.

1 Press **SET UP MENU**. The VCR menu screen will appear.

2 Press **◀** or **▶** to select the "SYSTEM SETUP" menu, then press **ENTER**.

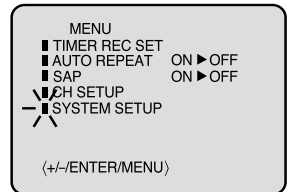

3 Press **◀** or **▶** to select the "CLOCK SET" option, then press **ENTER**.

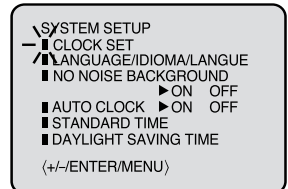

4 Press **◀** or **▶** to set the month, then press **ENTER** button.

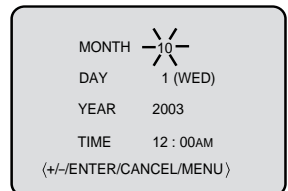

To make corrections any time during the process

Press **CANCEL** repeatedly until the item you want to change blinks, then press **◀** or **▶**.

5 Set the day, year and time as in step 4.

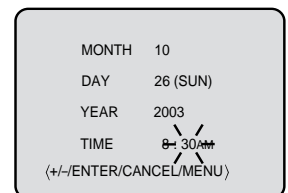

6 After setting the clock, date and time starts functioning automatically.

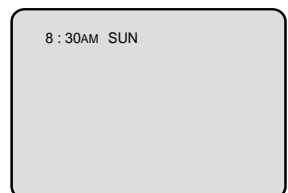

Loading and Unloading a cassette tape

Use only video cassette tapes marked **VHS** and **S-VHS**.

SQP/B

- Cassettes marked "VHS" (or "S-VHS") can be used with this video cassette recorder. However, S-VHS recording is not possible with this model.
- This model is equipped with SQPB (S-VHS QUASI PLAYBACK) that makes it possible to play back S-VHS recordings with regular VHS resolution.
- HQ VHS is compatible with existing VHS equipment.

Loading

Push the center of the tape until it is automatically inserted.

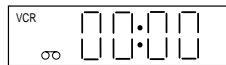
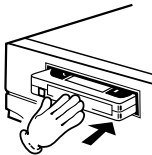

Insert the cassette tape with its labeled side facing up and the erase prevention tab positioned at your left. An inverted cassette tape cannot be inserted.

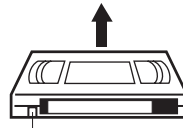

Erase prevention tab

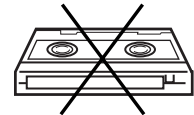

Automatic power ON

When you insert a cassette tape the VCR power will turn ON automatically.

Automatic playback

When loading a cassette tape without an erase prevention tab, playback will start automatically.

Unloading

1 Press **EJECT** on the unit.



2 Remove the cassette tape.

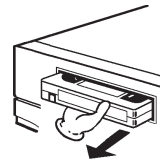

Automatic tape eject

This VCR will automatically rewind the tape when the tape has ended. And when the tape is rewinded to its beginning, the cassette tape will be ejected automatically.

To prevent accidental erasure

Remove the erase prevention tab with a screwdriver.



To record again

Cover the hole with a piece of adhesive tape.

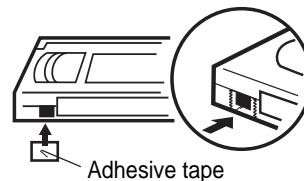

Tape speed and maximum recording time

| Tape Speed | Video cassette tape | | | | |
|--------------------|---------------------|---------|-------------|---------|-------------|
| | T-160 | T-120 | T-90 | T-60 | T-30 |
| SP (Standard Play) | 2-2/3 hours | 2 hours | 1-1/2 hours | 1 hour | 30 minutes |
| EP (Extended Play) | 8 hours | 6 hours | 4-1/2 hours | 3 hours | 1-1/2 hours |

Cassette tape playback

Preparation:

- Turn ON the TV and set to the video input mode.
- Make sure **TV/VCR/DVD** switch has been slid to VCR/DVD. Then press **VCR** to select the VCR mode. (The VCR indicator will light.)



- 1 Load a prerecorded tape (When loading a cassette tape without the erase prevention tab, playback will start automatically).

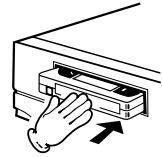

2 To start playback

Press **PLAY**.

Playback will start.

“▶” will appear on the screen for about 4 seconds.



To stop playback

Press **STOP** once.

The tape will stop but remain fully loaded and ready to play.

“■” will appear on the screen for about 4 seconds.



To rewind the tape or forward it rapidly

Stop the playback or recording with **STOP**.

To rewind the tape:

Press **REW**.

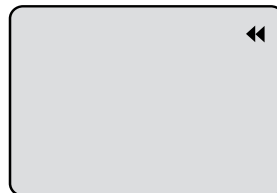

To forward the tape:

Press **FF**.



To stop the tape-winding, press **STOP**. To switch to playback directly (without **STOP**), press **PLAY**.

Forward/Reverse picture search mode

When the tape is being winded, you can switch to picture search mode (see next page). To do this, press **REW** or **FF** and hold it down. The unit will resume the tape winding as soon as the button is released.

NOTES:

- This VCR selects the playback tape speed SP or EP automatically.
- The Cassette tape and DVD disc can be played back simultaneously. If you press **VCR** or **DVD**, the tape playback and DVD playback alternate with each other on the screen.

Special playback

Picture Search

Reverse picture search function

Press **REW** x 1 or x 2 during the playback.

Forward picture search function

Press **FF** x 1 or x 2 during the playback.

To return to playback: Press **PLAY**.

Still Picture

Press **PAUSE** during playback. To resume normal playback: Press **PLAY**.

Slow Motion

During playback press **SLOW**.

To return to playback: Press **PLAY** or **SLOW**.

Slow tracking and vertical lock adjustment

If noise bars appear in the picture during slow motion, press the **SET +** or **-** to reduce the noise bars. If the still picture jitters excessively, press **SET +** or **-** to stabilize the still picture.

Frame by Frame picture

Press **PAUSE** during playback.

Press **SLOW** one by one: The picture advances frame by frame.

To return to playback: Press **PLAY** or **PAUSE**.

Adjusting tracking condition

Automatic tracking adjustment

Whenever you insert a tape and start playback, automatic tracking starts working and continuously analyzes the signal to enable optimum picture quality during playback.

Manual tracking adjustment

If automatic tracking cannot eliminate noises well during playback, press **SET +/-** to eliminate the noises. "MANUAL TR." will appear. Press it briefly for a fine adjustment, or press and hold for a coarse adjustment.

- Press **A.TRK** to reactivate automatic tracking again. "AUTO TR." will appear.

NOTES:

- The audio output is muted during **SPEED SEARCH**, **STILL**, **FRAME ADVANCE** and **SLOW MOTION**.
- During picture search mode there will be noise bars which are caused by the system.
- The Special Playback will automatically change to playback after approx. 5 minutes to protect the video tape against excessive wear.

Repeat playback

The entire video tape will be played until its end. The tape will then automatically rewind to the beginning and the playback will be repeated.

- 1 Press **SET UP MENU**. Press **◀** or **▶** to select "AUTO REPEAT".

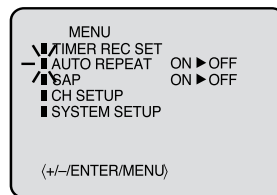

- 2 Then press **ENTER** to select "ON" or "OFF". If "ON" is selected, the playback will be repeated endlessly.

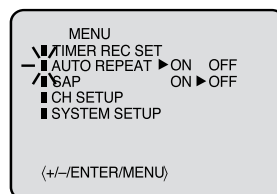

- 3 Press **SET UP MENU** until the menu screen is cleared. If you press **OSD**, "⌂" will appear on the screen.

- 4 To start the playback, press **PLAY**. The playback will be repeated endlessly.

To cancel repeat mode:

Follow the above step 1, then press **ENTER** to select the "OFF" position. Press **SET UP MENU** to return to the TV.

Skip Search

Each time you press **SKIP SEARCH** while a tape is playing, the unit will fast-forward ahead 30 seconds on the tape. You may press the button up to six times in a row to move 180 seconds (three minutes) ahead.

- For example: 1 press: 30 seconds of tape
2 presses: 60 seconds of tape
3 presses: 90 seconds of tape

ZERO RETURN function/Video Index Search system



ZERO RETURN function

This function makes tape-rewinding stop at the counter 00:00:00 position automatically.

1 Press OSD.

The counter display shows the tape running time during playback or recording.

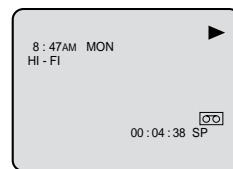
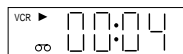

2 Press C. RESET at the desired tape position. The counter display will be reset to the "00:00:00" position (e.g. the beginning of recording).

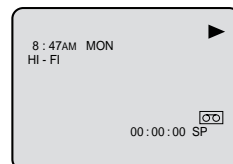
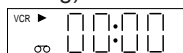

3 Press STOP when playback or recording is finished. Press ZERO RETURN.

The tape will be rewinded or fast forwarded and automatically stop at the "00:00:00" position.

The DISPLAY-button

Press DISPLAY. The clock and tape counter alternate with each other in the display.

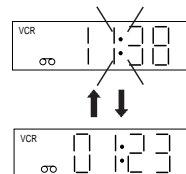

NOTES for Counter Display:

- If you rewind the tape beyond "00:00:00", a minus sign ("-") will be displayed in front of the time counter.
- When you load a tape, the counter will reset to "00:00:00".
- The counter does not function on nonrecorded (blank) sections of the tape. When you rewind, fast forward or play tapes through blank sections, the counter stops.

NOTES for Video Index Search system:

- When you record an INDEX mark at the very beginning of the tape, the mark may not be found.
- During INDEX search, the tape may stop and begin to play at a slightly different location.
- INDEX may not function properly with old or worn out video tapes.
- INDEX marks may not be found if it is extremely close to the point where the search began.
- In recording, if you stop recording temporarily, the INDEX mark is not recorded on the tape.

Video Index Search system

This function enables you to locate the beginning of any recording made on the VCR.

Recording an INDEX MARK

The Index Search function automatically records an INDEX mark on the tape whenever a recording is initiated.

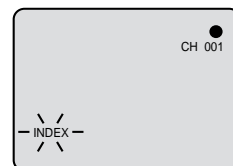

Index Search

Press INDEX ►► or ◀◀ during stop or play mode.

For Succeeding programs: Press INDEX ►►.
For Preceding programs: Press INDEX ◀◀.
(Additional press increases the INDEX NO. up to 9.)

When the INDEX ►► or ◀◀ is pressed, the unit starts searching the INDEX NO. selected and finds the portion, then playback starts automatically.

To stop the Index Search, press STOP.



►► or ◀◀ is displayed

INDEX NO. (up to 9)

Recording a TV program

Recording and viewing the same TV program



NOTES:

- If the erase prevention tab is removed, the tape will eject when both the **REC** and **PLAY** are pressed for recording.
- If you wish to watch the DVD playback during the normal recording on VCR, press **DVD** to change to DVD mode and perform the DVD playback (see page 37).

Preparation:

- Turn ON the TV and set it to the video input mode.
- Make sure **TV/VCR/DVD** switch has been slid to VCR/DVD. Then press **VCR** to select the VCR mode. (The VCR indicator will light.)

- 1 Load a cassette tape with the erase prevention tab intact. The VCR will automatically turn on.

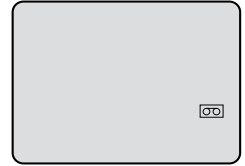

- 2 Press **SP/EP** to select the desired tape speed SP or EP. The tape counter and "SP" or "EP" will appear on the screen for about 4 seconds.

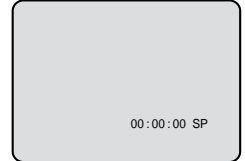

- 3 Set the TV/CATV option to the appropriate position (see page 19).

TV - VHF/UHF channels
CATV - CABLE TV channels

- 4 Press **Number keys** or **VCR CH +/-** to select the channel to be recorded.

TV mode direct channel selection -

All channels can be instantly selected by using two buttons. (for example, to select channel 2, press "0", then "2". If you press only "2", channel selection will be delayed for two seconds.) For channels 10 and above, press the 2 digits in order.

CATV mode direct channel selection -

- 1-9 Press **0** twice and then **1-9** as required. Example: To select 2, Press "002".
- 10-12 Press **0** first and then the remaining 2 digits in order from left to right. Example: Press **012** for "12".
- 13-99 Press 2 digits in order. Example: Press **22** for "22".
- 100-125 Press the 3 digits in order. Example: Press **110** for "110".

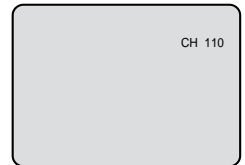

VHF/UHF/CATV CHANNELS

| TV | CATV |
|--------------|---|
| VHF 2-13 | VHF 2-13 |
| UHF 14-69 | STD/HRC/IRC 14-36 (A) (W) 37-59 (AA) (WW) 60-85 (AAA) (ZZZ) 86-94 (86) (94) 95-99 (A-5) (A-1) 100-125 (100)(125) 01 (5A) |

- 5 On the VCR, press **REC**. Or on the Remote, while holding **REC**, press **PLAY**. "●" will appear on the screen for about 4 seconds and "REC" will appear on the display.

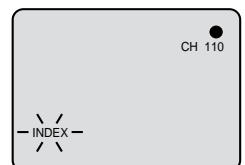

Recording a TV program



To stop recording

Press **STOP** to stop recording.
 “■” will appear on screen for about 4 seconds.

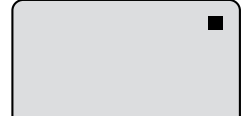

To stop recording temporarily

Press **PAUSE** to avoid recording unwanted material. Press again to continue the recording.
 “●||” will appear on screen for about 4 seconds.



NOTES:

- The pause function will be released after 5 minutes to prevent damage to the tape or the VCR. The VCR will change to the STOP mode.
- You can select a recording channel in the recording pause mode.

Recording one program while watching another

While the VCR is recording, press **TV/VCR** to select the TV position. The “VCR” will go off and recording will continue.

Select the TV channel you want to watch by using the TV channel selector. If the connected TV is JVC's, use **TV CH +/-** after slide **TV/VCR/DVD** switch to TV.

NOTE:

Some CATV hookups do not permit viewing one channel while recording another. See pages 14,15.

To Display VCR operation Status

Press **OSD**. The clock, day of the week and more information will be indicated.

While watching TV

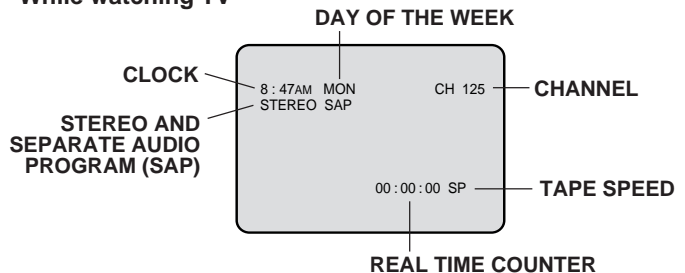

While operating a tape

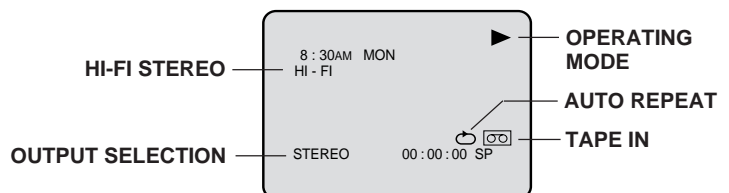

Auto Rewind feature

This VCR will automatically rewind the tape when the tape has ended (except during ITR and TIMER REC). It will also eject the tape.

To cancel the display: Press **OSD** until all indicators disappear.

Instant Timer Recording (ITR)

The Instant Timer Recording feature provides a simple and convenient way to make a timed recording.



NOTE:

If you wish to watch the DVD playback during the ITR, press **DVD** to change to DVD mode and perform the DVD playback (see page 37).

Preparation:

- Turn ON the TV and set it to the video input mode.
- Make sure **TV/VCR/DVD** switch has been slid to VCR/DVD. Then press **VCR** to select the VCR mode. (The VCR indicator will light.)

Example: Instant Timer Recording for 30 minutes.

- 1 Load a cassette tape with the erase prevention tab intact. The VCR will automatically turn on.



- 2 Press **SP/EP** to select the desired tape speed SP or EP. The tape counter and "SP" or "EP" will appear on the screen for about 4 seconds.



- 3 Set the TV/CATV option to the appropriate position (see page 19).

TV - VHF/UHF channels
CATV - CABLE TV channels

- 4 Press **Number keys** or **VCR CH +/-** to select the channel to be recorded.

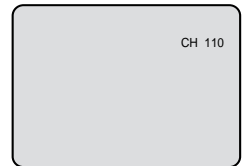

- 5 Press **REC** on the VCR or while holding **REC**, press **PLAY** on the Remote to begin recording. Press **REC** on the VCR again to stop recording after 30 minutes. Each additional press of **REC** will increase recording time as shown in the chart below, up to a maximum of 6 hours. The ITR and recording time will appear on the screen for about 4 seconds. And, REC will keep blinking in the display.

| Press | Recording time | Press | Recording time |
|---------|----------------|----------|----------------|
| once | NORMAL REC | 6 times | 3:00 |
| twice | 0:30 | 7 times | 4:00 |
| 3 times | 1:00 | 8 times | 5:00 |
| 4 times | 1:30 | 9 times | 6:00 |
| 5 times | 2:00 | 10 times | NORMAL REC |

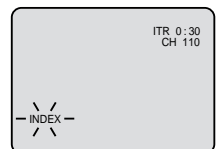

To cancel ITR

Press **STOP** or turn off the power. "■" will appear on screen for about 4 seconds.

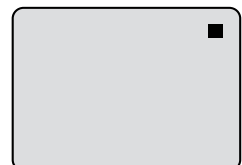

Timer recording

Timer recording can be programmed on-screen with the remote control. The built-in timer allows automatic unattended recording of up to 8 programs within 1 month.



NOTES:

- If the clock symbol (⌚) blinks when the timer recording ended, the TV program has not been completely recorded because of an insufficient tape supply. In this case, press **TIMER** to cancel the timer program or press **EJECT** to remove the cassette tape.
- During timer recording standby mode, the VCR mode cannot be selected. To use the VCR, press **TIMER** at first, then press **VCR** to change to VCR mode. After you use the VCR, press **TIMER** again to put the VCR into timer recording standby mode.
- If you press **TIMER** during timer recording, the recording operation will be interrupted. If you press **TIMER** again within the programmed time, the recording operation will start again.
- After a power failure or disconnection of the power plug, all programmed recording settings and time display will be lost upon resumption of power. In this case, reset the clock (see pages 21-23) and reprogram any timer recordings.

Preparation:

- Make sure **TV/VCR/DVD** switch has been slid to VCR/DVD. Then press **VCR** to select the VCR mode.
- Load a cassette tape with the erase prevention tab intact.
- Press **OSD** to verify time and date are correct (see page 29).

Example: Program a timer recording for the 26th day, channel 125 (CATV), 11:00 - 11:30 PM on timer program number 1 (Tape speed: EP).

1 Press **SET UP MENU**. Select the **TIMER REC SET** option, then press **ENTER**.

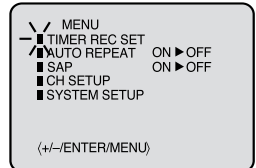

2 Press **SET +** or **-** to select one of the program line, then press **ENTER**.

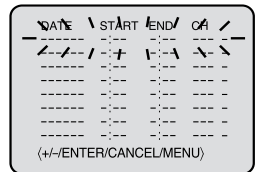

3 Press **SET +** or **-** to select the date, then press **ENTER**.

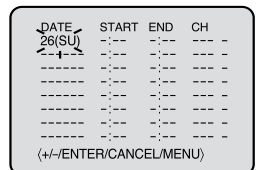

4 Set the **start time**, **end time**, **channel** and **tape speed** as in step 3.

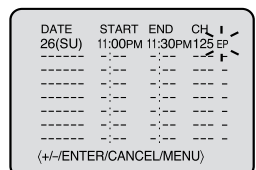

NOTES:

- If the programmed start time is over the present time, the program will be canceled after pressed **ENTER**.
- Press **CANCEL** to move cursor backward for correction.
- To record from external source set the channel to "L". "L" will appear next to CH 125 (or 69).

5 To enter other programs, repeat step 2 through 4.

- To return to the normal screen, press **SET UP MENU** twice.

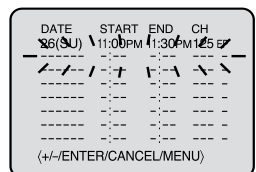

6 Press **TIMER**. The clock symbol (⌚) will appear on the display and the VCR stands by for recording. At the same time, VCR mode will change to DVD mode automatically. You can use DVD even if the VCR is in the timer recording mode. If you do not use the DVD, turn the power off. The timer recording will start at 5 seconds before the time you predetermined.

NOTES:

- If the clock symbol (⌚) does not appear on the display in spite of the pressing of **TIMER**, the cassette may not have been loaded yet (see page 24).
- If the cassette is ejected in spite of the pressing of **TIMER**, the erase prevention tab of the cassette may have been removed (see page 24).

Timer-recording

Timer recording special case

Weekly (e.g. WKL-TU: each Tuesday) or daily (e.g. MO-SA: Monday to Saturday) timer recording

Follow the procedure of timer recording on the previous page. At picture 3 press **SET +** or **-** repeatedly until the desired setting appears. Then press **ENTER**.

When you press **SET -** repeatedly, the indicator at DATE will change as follows, in this case the today is Friday.

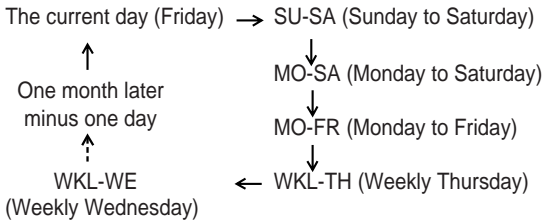

| DATE | START | END | CH |
|-------------------------|-------|-----|-----|
| WKL-WE | --- | --- | --- |
| --- | --- | --- | --- |
| --- | --- | --- | --- |
| --- | --- | --- | --- |
| --- | --- | --- | --- |
| --- | --- | --- | --- |
| --- | --- | --- | --- |
| --- | --- | --- | --- |
| (+/-/ENTER/CANCEL/MENU) | | | |

In case timer programs-overlap

- Do not overlap timer programs as portions of the conflicting programs will be lost. The first recording time has priority over the next recording time as shown in the diagram below.

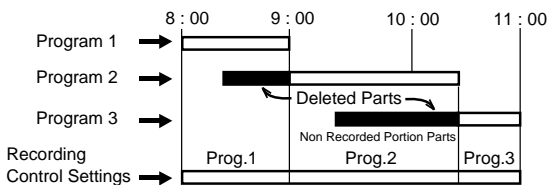

NOTES:

- The daily/weekly recording can be made continuously until the recording is canceled or the tape reaches the end.
- During timer recording the automatic rewinding mechanism does not function.

Confirmation / Cancellation of the timer recording

- If the timer has been activated, press **TIMER** to deactivate the timer. The clock symbol (⌚) will disappear. Then press **VCR** to change to VCR mode.

2 To confirm timer program:

At picture 1 on the previous page select the "TIMER REC SET" option and press **ENTER**.

Then the timer program list as right will appear on the screen.

| DATE | START | END | CH |
|-------------------------|---------|---------|--------|
| 26(SU) | 11:00PM | 11:30PM | 125 EP |
| --- | --- | --- | --- |
| --- | --- | --- | --- |
| --- | --- | --- | --- |
| --- | --- | --- | --- |
| --- | --- | --- | --- |
| --- | --- | --- | --- |
| --- | --- | --- | --- |
| (+/-/ENTER/CANCEL/MENU) | | | |

3 To cancel timer program:

Press **SET +** or **-** to select the unnecessary program, then press **CANCEL** to cancel the program.

| DATE | START | END | CH |
|-------------------------|-------|-----|-----|
| --- | --- | --- | --- |
| --- | --- | --- | --- |
| --- | --- | --- | --- |
| --- | --- | --- | --- |
| --- | --- | --- | --- |
| --- | --- | --- | --- |
| --- | --- | --- | --- |
| --- | --- | --- | --- |
| (+/-/ENTER/CANCEL/MENU) | | | |

- Press **SET UP MENU** repeatedly until the TV-picture appears.

NOTES:

- If there are other timer record programs remaining, **TIMER** must be pressed to reactivate the timer, otherwise the remaining timer record programs will be ignored.
- You cannot confirm the timer program during timer recording operation.
- You can also correct the programmed setting in program confirm mode.

At step 2 above, press **ENTER** to enter the program input mode. Then press **ENTER** repeatedly until the item you wish to correct blinks. Then correct the data with **SET +** or **-**.

Then press **SET UP MENU** repeatedly until the TV-picture appears.

| DATE | START | END | CH |
|-------------------------|---------|---------|--------|
| 26(SU) | 11:00PM | 11:30PM | 125 EP |
| --- | --- | --- | --- |
| --- | --- | --- | --- |
| --- | --- | --- | --- |
| --- | --- | --- | --- |
| --- | --- | --- | --- |
| --- | --- | --- | --- |
| --- | --- | --- | --- |
| (+/-/ENTER/CANCEL/MENU) | | | |

Stereo recording and playback/Second Audio Program (SAP)

Stereo Recording and Playback

The VHS Hi-Fi audio system permits high fidelity recording of MTS STEREO TV broadcasts.

When a MTS STEREO broadcast is received, the word "STEREO" will appear on the screen for about 4 seconds and the program can be viewed or recorded in stereo.

The Hi-Fi STEREO recording procedure is the same as for normal recordings.

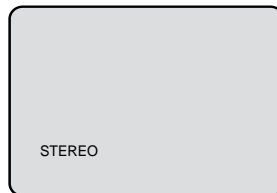

NOTE:

When using a CATV system, stereo TV programs may be transmitted over a mono cable channel. In this case the word "STEREO" will not appear and the sound will be in mono.

Output selection

When viewing an MTS STEREO TV program, or playing a prerecorded VHS Hi-Fi STEREO videotape, press **A.MONITOR** to select how the audio will be heard through the speakers. Normally set to the Hi-Fi STEREO position, this button can be set to the MONO position if the stereo broadcast or videotape audio is of poor quality. The "R" and "L" positions allow the audio from the Right or Left Hi-Fi channel to be heard over both TV speakers. This button has no effect when viewing a MONO videotape or TV program. Each time when you press the button, OUTPUT SELECTION display appears on the screen for several seconds. Refer to the chart below.

| OUTPUT SELECTION | SOUND HEARD ON BOTH SPEAKERS |
|------------------|------------------------------|
| STEREO | STEREO |
| L ch | LEFT CHANNEL AUDIO |
| R ch | RIGHT CHANNEL AUDIO |
| MONO | MONO |

Second Audio Program (SAP)

Your VCR is fitted with a SAP broadcast system which enables you to switch to a second audio program when viewing a selected channel.

This function applies only when the program is broadcast in multi-languages through the SAP broadcast system.

- 1 Press **SET UP MENU**. Then press ◀ or ▶ to select "SAP".
- 2 Then press **ENTER** to select "ON".

Then press **SET UP MENU** until the menu screen is cleared.

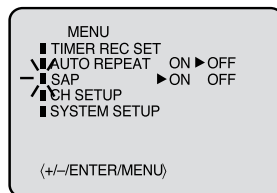

NOTES:

- When playing back a tape that is not recorded in Hi-Fi stereo mode, the audio will automatically be monaural.
- When listening to a VHS Hi-Fi video tape or MTS broadcast through the VHF/UHF jack (Audio/Video cable not connected), the sound will be monaural.

Listening to SAP

When the VCR is turned on or a channel selection is made, make certain the letters "SAP" appears on the screen for about 4 seconds. This means that the "Second Audio Program" broadcasting is available.

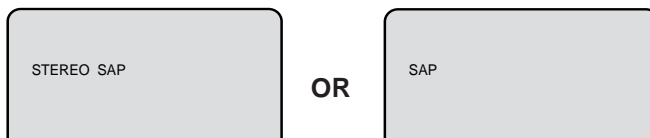

Duplicating a video tape/Duplicating a disc material onto a video tape

Duplicating a video tape

If you connect the VCR to another VCR or camcorder, you can duplicate a previously recorded tape. Make all connections before turning on the power.

- 1 Load a blank cassette tape with the erase prevention tab intact into the recording VCR. Load a previously recorded tape into the playback VCR or CAMCORDER.
- 2 Press **SP/EP** to select the desired tape speed SP or EP. It is recommended that you set the speed to the SP mode on the recording VCR for best results.
- 3 Press **VCR CH +** or **-** to select AUDIO/VIDEO input position. "L" will appear in the display. 
- 4 Press **REC** on the recording VCR or on the Remote. While holding **REC**, press **PLAY**. Then press **PAUSE**.
- 5 Press **PLAY** button on the playback VCR or CAMCORDER, then press **PAUSE** button.
- 6 Press **PAUSE** on both the VCRs simultaneously to begin the duplicating process.

Connection with second VCR

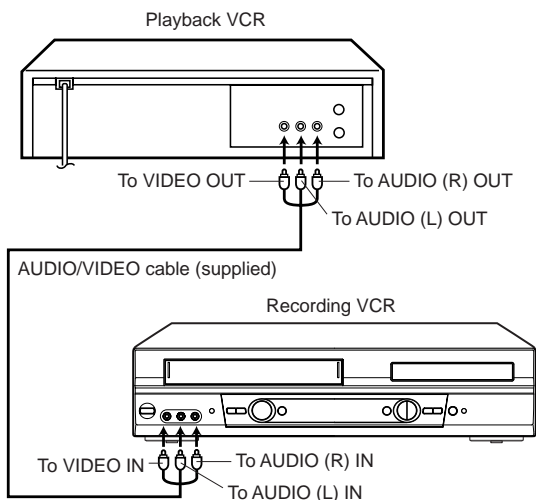

Connection with Camcorder

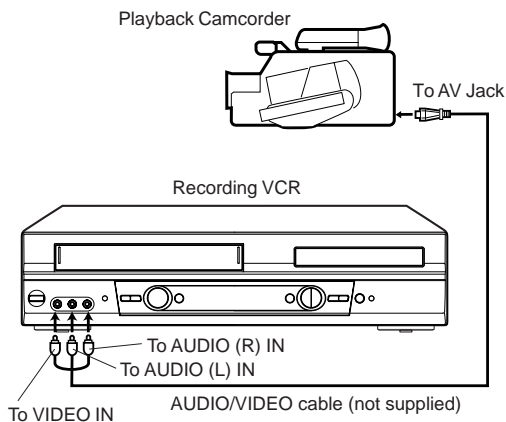

For duplicating a previously recorded tape from a camcorder, follow the camcorder manufacturer's instructions. A typical camcorder dubbing hookup is shown above.

Duplicating a disc material onto a video tape

You can record disc material in DVD, Video CD, Audio CD, etc. onto a video tape with this DVD/VCR only. If the DVD disc has a Copy-guard feature, the duplicating is not possible. A symbol mark "Ⓢ → Ⓢ" will appear on the screen for approx. 4 seconds. See page 37 for more information about the DVD playback.

Preparation:

- Load a cassette tape with the erase prevention tab intact.
- Select the tape speed (SP or EP) in the VCR mode.
- Load a disc you wish to duplicate.





- 1 Press **DVD** to select the DVD mode. (The DVD indicator will light.)
- 2 Press **PLAY** to start the disc playback.

- 3 During disc playback, press **REC** on the VCR or while holding **REC**, press **PLAY** on the Remote. The duplicating will start.

NOTE:

You can set the duplicating time using the ITR-function. At step 3 above press **REC** repeatedly until the desired duplicating time appears on the screen (see page 30).

The following types of discs can be played on this unit.

| Disc type and logo mark | Recorded content | Disc size |
|--|-----------------------------|------------------|
| DVD Video  | Audio + Video | 5 inches (12 cm) |
| | | 3 inches (8 cm) |
| Video CD  | | 5 inches (12 cm) |
| | | 3 inches (8 cm) |
| Audio CD  | Audio | 5 inches (12 cm) |
| | | 3 inches (8 cm) |
| CD-R/CD-RW   | CD-DA/JPEG/ MP3/WMA file | 5 inches (12 cm) |
| | | 3 inches (8 cm) |

- This unit can play back FUJICOLOR CD and Kodak Picture CD formats.
- DVD-ROM, SVCD, CVD, Photo CD, etc. cannot be played.
- Some CD-R/RWs can not be played back depending on the recording conditions.
- This unit is to be used exclusively with the NTSC color system. PAL and SECAM system discs cannot be used with this unit.

Region Number

Region number (Regional restriction code) is built-in to the unit and DVD video discs. Region number "1" or "ALL" of DVD video discs can be used on this unit.



Title

When two or more movies are recorded on a disc, the disc is divided into two or more sections. Each section is called a "TITLE".

Chapter

The titles can be subdivided into many sections. Each section is called a "CHAPTER".

Video CD/Audio CD Track

A Video CD or Audio CD can contain several items. These are assigned to the tracks.

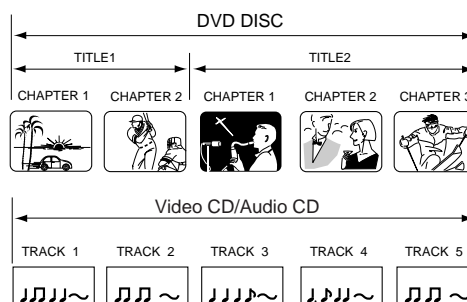

Removing Disc from Case

Be sure to hold the edge of disc. Do not touch the surface of the disc. Pick up the disc gently from the case.

- Do not scratch the disc.
- Do not get dirt on the surface of the disc.
- Do not stick a label or adhesive tape on the disc.
- Do not drop or bend the disc.

Storing Disc

- Store the disc in the case to avoid risk of scratches, dirt or damage.
- Do not leave disc exposed to direct sunlight or in hot or humid places.

Cleaning Disc

Wipe the disc with a clean, dry cloth from center to edge.

- Do not wipe the disc round.
- Do not use liquid or aerosol cleaners.

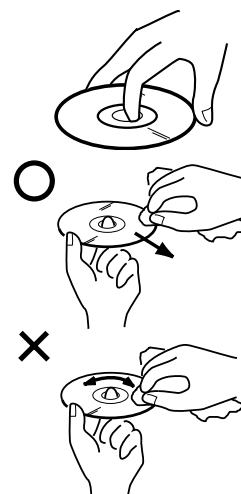

Setting setup language

The setup language can be selected.



Preparation:

- Turn ON the TV and set it to the video input mode.
- Make sure **TV/VCR/DVD** switch has been slid to VCR/DVD.
- When using an amplifier, switch on the amplifier.

- 1 Press **DVD** to select the DVD mode. (The DVD indicator will light.)
“Reading” and then “No Disc” will appear on the screen. (If a DVD disc has already loaded, the playback will start automatically.)



- 2 Press **SET UP MENU** in the stop mode. The **SETUP MENU** of DVD will appear on the screen. Then press ◀ or ▶ to select “Other”.

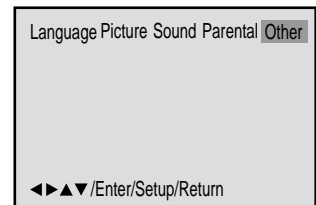

- 3 Press **ENTER** to select “OSD Language”.

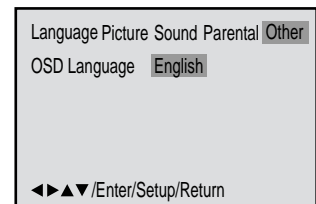

- 4 Press ▶ and then press ▲ or ▼ to select desired language (e.g. English), then press **ENTER**.

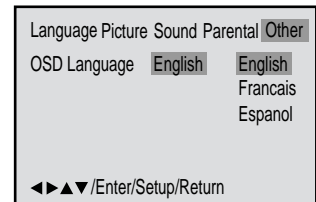

NOTE: To make the **SETUP** screen disappear, press **SET UP MENU** (or **RETURN**).

If the DVD/VCR does not operate properly: Static electricity, etc., may affect the player's operation. Disconnect the AC power cord once, then connect it again.

Playback procedure



Preparation:

- Turn ON the TV and set it to the video input mode.
- Make sure **TV/VCR/DVD** switch has been slid to VCR/DVD. Then press **DVD** to select the DVD mode. (The DVD indicator will light.)

- 1 Press **OPEN/CLOSE**.
The disc tray will open.



- 2 Place a disc onto the tray.
Hold the disc, position it with the printed label side up, align it with the guides, and place it in its proper position.

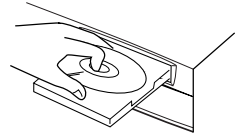

- 3 Press **OPEN/CLOSE** or **PLAY**.
The disc tray closes automatically.
On the screen, ▲ changes to "Reading" and then playback will commence.

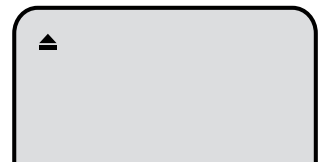

- A menu screen may appear on the TV screen, if the disc has a menu feature. In this case, press ▲, ▼, ◀, ▶ or **ENTER** to operate a menu feature.

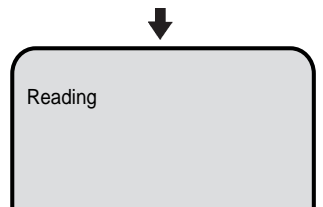

- 4 Press **STOP** to end playback.
 - The DVD/VCR memorizes the stopped point, depending on the disc. "■" appears on the screen for approx. 4 seconds. "▶" keep blinking in the display until the playback is stopped completely. Press **PLAY** to resume playback (from the scene point).
 - If you press **STOP** again ("■" appears on the screen) or unload the disc, the DVD/VCR will clear the stopped point.

- 5 Then press **OPEN/CLOSE**.
The disc tray opens.
Remove the disc and press **POWER**.
The disc tray closes automatically and DVD/VCR turns off.

NOTES:

- If a non-compatible disc is loaded, "Incorrect Disc", "Region Code Error" or "Parental Error" will appear on the TV screen according to the type of loaded disc. In this case, check your disc again (see pages 35 and 50).
- Some discs may take a minute or so to start playback.
- A "Prohibition" symbol may appear at the upper left of the screen. This symbol means either the feature you tried is not available on the disc, or the DVD/VCR can not access the feature at this time. This does not indicate a problem with the DVD/VCR.
- When you set a single-faced disc label downwards (ie. the wrong way up) and press **OPEN/CLOSE** or **PLAY**, "Reading" will appear and remain on the screen for approx. 30 seconds and then it will change to "Incorrect Disc".
- Some playback operations of DVDs may be intentionally fixed by software producers. Since this DVD/VCR plays DVDs according to the disc contents the software producers designed, some playback features may not be available. Also refer to the instructions supplied with the DVDs.
- When playing DTS-encoded Audio CDs, excessive noise will be heard from the analog stereo outputs. To avoid possible damage to the audio system, the consumer should take proper precautions when the analog stereo outputs of the DVD/VCR are connected to an amplification system.

Special playback

Note: There may be a slight delay between pressing the button and the function activation.



NOTE:

The unit is capable of holding a still video image or On screen display image on your television screen indefinitely. If you leave the still video image or On screen display image displayed on your TV for an extended period of time, you risk permanent damage to your television screen. Projection televisions are very susceptible.

Fast Forward Playback

Press **FF** during normal playback.

Each press of **FF** will increase the speed of the search ►► (x2), ►►►► (x4), ►►►►►► (x8), ►►►►►►►► (x20).

- To resume normal playback, press **PLAY**.

Review Playback

Press **REW** during normal playback.

Each press of **REW** will increase the speed of the search ◀◀ (x2), ◀◀◀◀ (x4), ◀◀◀◀◀◀ (x8), ◀◀◀◀◀◀◀◀ (x20).

- To resume normal playback, press **PLAY**.

Still Playback

Press **PAUSE** during normal playback.

To resume normal playback, press **PLAY**.

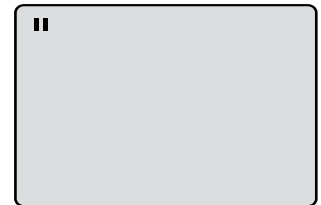

Frame Advance

Press **PAUSE** during still playback. One frame is advanced each time you press **PAUSE**.

To resume normal playback, press **PLAY**.



Slow-motion Playback

Press **SLOW** during normal playback or still playback.

Each press of **SLOW** will change the speed of the slow x1/2, x1/4, x1/6, x1/7.

- To resume normal playback, press **PLAY**.
- To resume the still playback, press **PAUSE**.

Locating a chapter or track

Press **SKIP** ◀◀ or ►► repeatedly to display the chapter or track number you want.

Playback starts from the selected chapter or track.

To locate succeeding chapters or tracks.

Playback starts from the beginning of the current chapter or track. When you press twice, playback starts from the beginning of the preceding chapter or track.

Zooming/Locating desired scene



Preparation:

- Turn ON the TV and set it to the video input mode.
- Make sure **TV/VCR/DVD** switch has been slid to VCR/DVD. Then press **DVD** to select the DVD mode. (The DVD indicator will light.)

Zooming

This unit will allow you to zoom in on the frame image. You can then make selections by switching the position of the frame.

- 1 Press **ZOOM** during playback. The center part of the image will be zoomed in. Each press of **ZOOM** will change the ZOOM **Q** 1 (x 1.3), **Q** 2 (x 1.5) and **Q** 3 (x 2.0).

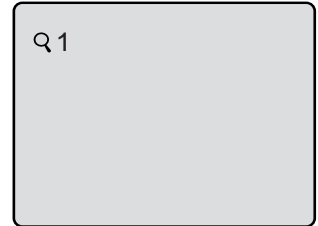

- 2 Press **▲/▼** or **◀/▶** to view a different part of the frame. You may move the frame from the center position to UP, DOWN, LEFT or RIGHT direction.
- 3 In the zoom mode press **ZOOM** repeatedly to return to a 1:1 view (**Q** Off).

Locating desired scene

Use the title, chapter and time recorded on the disc to locate the desired point to play back.

To check the title, chapter and time, press **OSD** (see page 56).

- 1 Press **SEARCH MODE** during playback or stop mode.

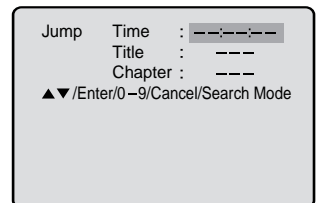

- 2 Press **▲** or **▼** to select the "Time", "Title" or "Chapter".
- 3 Press **Number keys** to change the number.

- If you input a wrong number, press **CANCEL**.
- Refer to the package supplied with the disc to check the numbers.

- 4 Press **ENTER**. Playback starts.

- When you change the title, playback starts from Chapter 1 of the selected title.
- Some discs may not work in the above operation.

NOTES:

- You can use the Pause, Slow, Search or Skip feature in the zoom mode.
- In case of the Video-CD playback with PBC, the SEARCH MODE does not work.

Repeat playback



NOTES:

- Some discs may not work with the repeat operation.
- In A-B repeat mode, subtitles near point A or B may not appear.
- A-B repeat playback is not available in multi-angle scenes.
- You may not be able to set A-B Repeat, depending on the scenes of the DVD.
- A-B repeat does not work with an interactive DVD, MP3/WMA/JPEG-CD and Video-CD with PBC.

Preparation:

- Turn ON the TV and set it to the video input mode.
- Make sure **TV/VCR/DVD** switch has been slid to VCR/DVD. Then press **DVD** to select the DVD mode. (The DVD indicator will light.)

Repeat playback of Title, Chapter and Track

- 1 Press **PLAY MODE** during playback or stop mode.

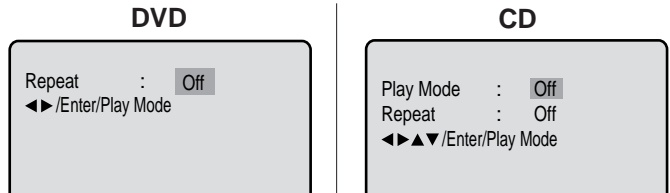

- 2 Press **ENTER** once or twice to select "Chapter" or "Title".
In case of CD, at first press ▼ to select "Repeat" and then press **ENTER** once or twice to select "Track" or "All".

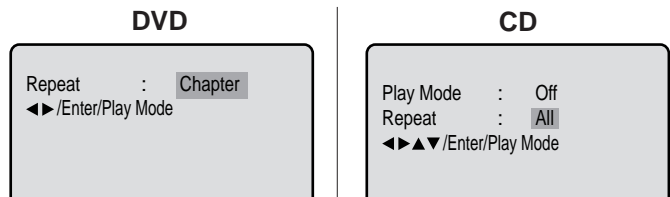

- 3 Press **PLAY MODE** again to make the screen disappear.
 - Press **PLAY** to start Repeat playback.
 - To resume normal playback, select Repeat "Off".

A-B Repeat Playback

A-B repeat playback allows you to repeat material between two selected points.

- 1 Press **REPEAT A-B** during playback.
The start point is selected.

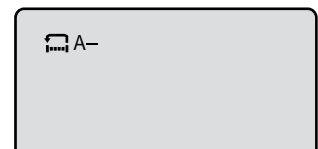

- 2 Press **REPEAT A-B** again.
The end point is selected. Playback starts at the point that you selected. Playback stops at the end point, returns to Point A automatically, then starts again.

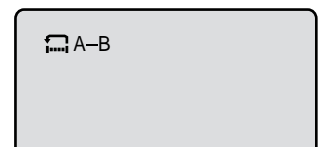

To resume normal playback press **REPEAT A-B** again.
"◀▶ Off" appears on the screen.

Program playback/Random playback (CD)

Preparation:

- Turn ON the TV and set it to the video input mode.
- Make sure **TV/VCR/DVD** switch has been slid to VCR/DVD. Then press **DVD** to select the DVD mode. (The DVD indicator will light.)



Program playback

You can arrange the order of tracks on the disc.

- 1 Press **PLAY MODE** in the stop mode.

```
Play Mode : Off
Repeat    : Off
◀▶▶▶/Enter/Play Mode
```

- 2 Press **ENTER** repeatedly until the Program table as right appears.

```
Play Mode : Program
Repeat    : Off
1 --- 4 --- 7 --- 10 ---
2 --- 5 --- 8 --- 11 ---
3 --- 6 --- 9 --- 12 ---
Clear    Program Playback
◀▶▶▶/Enter/0-9/Cancel/Play Mode
```

- 3 **Example:** In case you wish to program in order of 7, 3, 11: Enter as **7 ▼, 3 ▼, 11.**

If you input a wrong number, press **CANCEL**.

```
Play Mode : Program
Repeat    : Off
1 7-- 4 --- 7 --- 10 ---
2 3-- 5 --- 8 --- 11 ---
3 11- 6 --- 9 --- 12 ---
Clear    Program Playback
◀▶▶▶/Enter/0-9/Cancel/Play Mode
```

- 4 Press **▲/▼** or **◀/▶** to select "Program Playback" and press **ENTER**.

The program you selected will begin to playback in the order set. To return to normal playback, select "Play Mode: Off" at step 2 above.

```
Play Mode : Program
Repeat    : Off
1 7-- 4 --- 7 --- 10 ---
2 3-- 5 --- 8 --- 11 ---
3 11- 6 --- 9 --- 12 ---
Clear    Program Playback
◀▶▶▶/Enter/0-9/Cancel/Play Mode
```

Random playback

- 1 Press **PLAY MODE** in the stop mode.

```
Play Mode : Off
Repeat    : Off
◀▶▶▶/Enter/Play Mode
```

- 2 Press **◀/▶** to select "Random".

```
Play Mode : Random
Repeat    : Off
◀▶▶▶/Enter/Play Mode
```

- 3 Press **PLAY**. Random playback will start.

NOTES:

- To cancel program playback, select "Clear" at step 4 and press **ENTER**.
- The program is cancelled when you open the disc tray or turn the power off.
- In playing back the Video CD with PBC, you can not set Program playback and Random playback.

MP3/WMA/JPEG playback

This player can play back the MP3/WMA/JPEG-data which has been recorded on CD-R or CD-RW. To produce the MP3/WMA/JPEG-data, you need a Windows-PC with CD-ROM drive and a MP3/WMA/JPEG-encoding Software (not supplied).

The Apple-HFS-System can not be played.

MP3/WMA/JPEG CD information

Limitations on MP3/WMA/JPEG CD playback

- MP3/WMA/JPEG CD is the disc that is standardized by ISO9660, its file name must include 3-digits extension letters, "mp3", "wma", "jpg".
- The directory and file names of the MP3/WMA/JPEG CD must be correspond to the ISO standardized files.
- This unit can read 200 files per disc. If one directory has more than 200 files, it reads up to 200 files, the remaining files will be omitted.
- The unit is able to recognize up to a maximum of 50 directories per disc.
- MP3/WMA CDs cannot be used for playback for the purpose of recording.
- If the CD has both audio tracks and MP3/WMA/JPEG files, only audio tracks are played.
- It may take more than one minute for this unit to read MP3/WMA/JPEG files depending on its structure.
- Music recorded by "Joliet Recording Specification" can be played back, the file name is displayed (within 16 letters) on the screen Long file names will be condensed.
- The music files recorded by "Hierarchical File System" (HFS) cannot be played.
- The unit can play back baseline and progressive JPEG files.

Limitations on display

- The maximum number for display is 16 letters. Available letters for display are the following: capital or small alphabets of A through Z, numbers of 0 through 9, and _ (under score).
- Other letters than those above are replaced in hyphen.

Notes on MP3/WMA/JPEG files

To play back MP3/WMA/JPEG CD in the recorded order,

1. Use MP3/WMA/JPEG software that records data alphabetically or numerically.
2. Name each file including two-digit or three-digit number (e.g. "01" "02" or "001" "002").
3. Refrain from making too many sub-folders.

CAUTION:

- Some MP3/WMA/JPEG CDs can not be played back depending on the recording conditions.
- The CD-R/RW that has no music data or non-MP3/WMA/JPEG files can not be played back.

Preparation:

- Turn ON the TV and set it to the video input mode.
- Make sure **TV/VCR/DVD** switch has been slid to VCR/DVD. Then press **DVD** to select the DVD mode. (The DVD indicator will light.)

MP3/WMA CD playback

1 Press **OPEN/CLOSE**.
The disc tray will open.
Place a disc on which MP3 or WMA files have been recorded onto the tray.

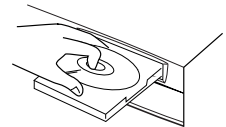

2 Press **OPEN/CLOSE** or **PLAY**. The disc tray closes automatically. On the TV-screen, "Reading" will appear. Reading will take as much time as the number of file.

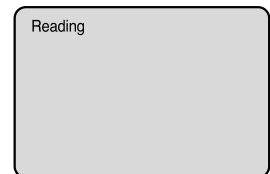

3 A file menu screen will appear on the TV screen.

Press **◀/▶** to select folder.

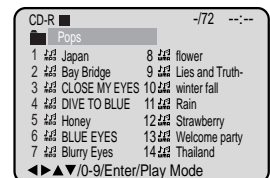

4 Press **▲/▼** or **◀/▶** or **Number keys** to select the desired file.

- In case the folder includes more than 15 files, press **◀** or **▶** to display next file list.

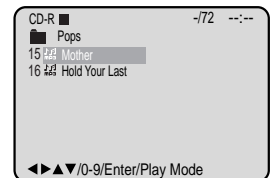
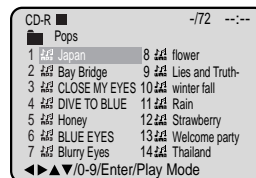

- When **PLAY** has been pressed after displaying the file menu, or when the disc tray has been closed after pressing **PLAY** in step 2, playback begins automatically starting from the first file. In this case, if the first file is an MP3/WMA file, only MP3/WMA files are played back in order. If the first file is a JPEG file, the first JPEG file is played back.

5 Press **ENTER**.
The selected file starts playing back.

6 Press **STOP** to end playback.

- The unit records the stopped point. "■" appears on the screen. Press **PLAY** to resume playback (from the scene point).
- If you press **STOP** again or unload the disc, the unit will clear the stopped point.

NOTES:

- During MP3/WMA/JPEG-Playback, you can not use SEARCH, A-B Repeat functions.
- You can use Repeat (Track or All), Random functions and Program playback for MP3/WMA/JPEG CD Playback (see pages 40 and 41).
- In the case of a CD containing a mixture of MP3, WMA and JPEG files, the files are played back by selecting them from the file menu.



About file menu

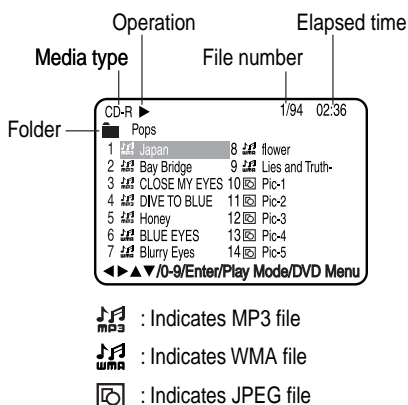

NOTE:
The picture menu is displayed when the FUJICOLOR CD or the Kodak Picture CD are played. To display the file menu press **TITLE**.

Preparation:

- Turn ON the TV and set it to the video input mode.
- Make sure **TV/VCR/DVD** switch has been slid to VCR/DVD. Then press **DVD** to select the DVD mode. (The DVD indicator will light.)

JPEG CD playback

- 1 Press **OPEN/CLOSE**.
The disc tray will open.
Place a disc on which JPEG files have been recorded onto the tray.
- 2 Press **OPEN/CLOSE** or **PLAY**.
The disc tray closes automatically. On the TV-screen, "Reading" will appear. Reading will take as much time as the number of file.

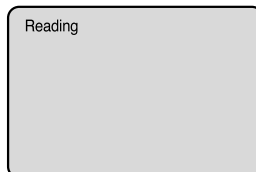
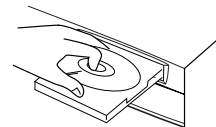

- 3 A file menu screen will appear on the TV screen.
Press **◀/▶** to select folder.

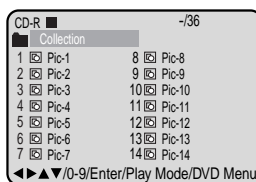

- 4 Press **▲/▼** or **◀/▶** or **Number keys** to select the desired file.

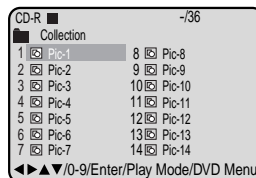

To display a picture menu, press **DVD MENU**. (To return to a file menu, press **TITLE**.)

Press **▲/▼** or **◀/▶** to select the desired file.

- To display next list, press **SKIP ▶▶/◀◀**.

- When **PLAY** has been pressed after displaying the file menu, or when the disc tray has been closed after pressing **PLAY** in step 2, playback begins automatically starting from the first file. In this case, if the first file is a JPEG file, the first JPEG file is played back. If the first file is an MP3/WMA file, only MP3/WMA files are played back in order.



- 5 Press **ENTER**.
The selected picture appears on the TV screen.

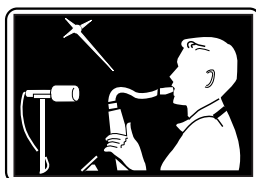

- 6 Press **STOP** to end playback.
The file menu appears on the TV screen.
If you want to watch the other file, repeat steps 4-5.

Setting the JPEG Interval



Preparation:

- Turn ON the TV and set it to the video input mode.
- Make sure **TV/VCR/DVD** switch has been slid to VCR/DVD. Then press **DVD** to select the DVD mode. (The DVD indicator will light.)

Setting the JPEG Interval

You can continuously play back all JPEG files automatically.

- 1 Press **SET UP MENU** in the stop mode.
Press **◀/▶** to select "Picture", then press **ENTER**.

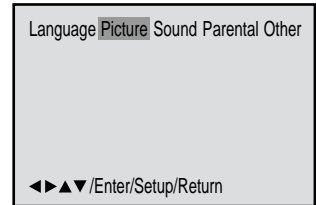

- 2 Press **▲** or **▼** to select "JPEG Interval".

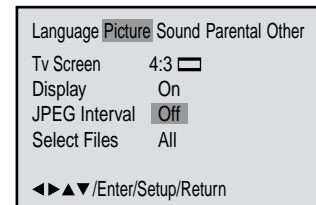

- 3 Press **ENTER**.
Press **◀** or **▶** to select your desired time.

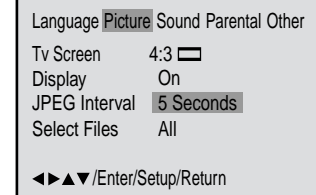

Off:

Plays back one file at a time.

5 Seconds:

Plays back images in the form of a slide show at 5 second intervals.

10 Seconds:

Plays back images in the form of a slide show at 10 second intervals.

15 Seconds:

Plays back images in the form of a slide show in 15 second intervals.

- 4 To make SETUP screen disappear, press **SET UP MENU**.

Setting the Select Files

When playing back a CD containing a mixture of MP3, WMA and JPEG files, only MP3/WMA or JPEG files can be displayed on the file menu.



Preparation:

- Turn ON the TV and set it to the video input mode.
- Make sure **TV/VCR/DVD** switch has been slid to VCR/DVD. Then press **DVD** to select the DVD mode. (The DVD indicator will light.)

- 1 Press **SET UP MENU** in the stop mode.
Press ◀/▶ to select "Picture", then press **ENTER**.

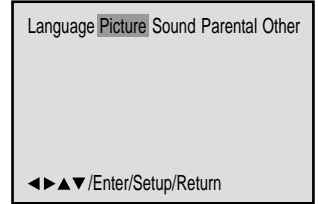

- 2 Press ▲ or ▼ to select "Select Files".

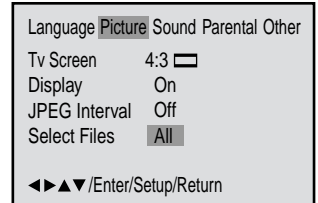

- 3 Press **ENTER**.
Press ◀ or ▶ to select your desired file type.

All:

Displays all files.

Music Only:

Displays only MP3/WMA files.

Pictures Only:

Displays only JPEG files.

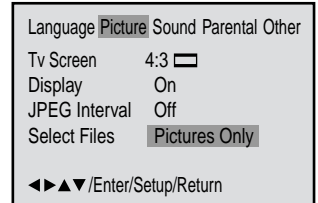

- 4 To make SETUP screen disappear, press **SET UP MENU**.

Zooming/Changing angles (JPEG CD)



Preparation:

- Turn ON the TV and set it to the video input mode.
- Make sure **TV/VCR/DVD** switch has been slid to VCR/DVD. Then press **DVD** to select the DVD mode. (The DVD indicator will light.)

Zooming

This unit will allow you to zoom in on the JPEG image.

- 1 Press **ZOOM** during playback.
Enlarged JPEG images are displayed.
You can make the images even larger by repeatedly pressing **ZOOM**.

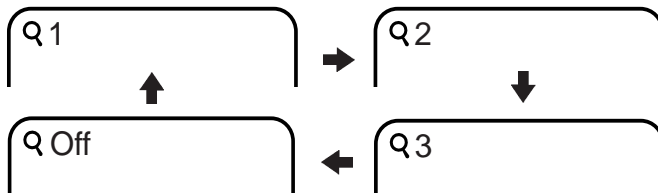

- 2 In the zoom mode, press **ZOOM** repeatedly to return to a 1:1 view (Q Off).

Changing angles

You can display JPEG images rotating at 90 degree intervals.

- 1 Press **ANGLE** during playback.
Images are rotated 90 degrees to the right.

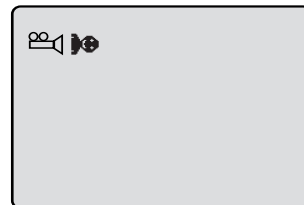

- 2 Press **ANGLE** repeatedly until the desired angle is selected.
Pressing **ANGLE** four times returns the image to its original angle.
 - Images are displayed at the same angle until the disc is removed.

Marking desired scenes

The unit stores the points that you want to watch again up to 3 points. You can resume playback from each scene.



NOTES:

- Some discs may not work with the marking operation.
- The marking is canceled when you open the disc tray or turn the power off.
- Some subtitles recorded around the marker may fail to appear.

Preparation:

- Turn ON the TV and set it to the video input mode.
- Make sure **TV/VCR/DVD** switch has been slid to VCR/DVD. Then press **DVD** to select the DVD mode. (The DVD indicator will light.)

Marking the scenes

1 Press **MARKER** during playback.

```
Marker 1 : ** : ** : **
Marker 2 : ** : ** : **
Marker 3 : ** : ** : **
▲▼/Enter/Cancel/Marker
```

2 Select the blank Marker using ▲/▼. Then press **ENTER** at the desired scene.

```
Marker 1 : 00 : 27 : 54
Marker 2 : ** : ** : **
Marker 3 : ** : ** : **
▲▼/Enter/Cancel/Marker
```

- Repeat this procedure to set the other 2 scenes.

3 Press **MARKER** to remove this display.

Returning to the scenes

1 Press **MARKER** during playback or stop mode.

```
Marker 1 : 00 : 27 : 54
Marker 2 : 01 : 16 : 25
Marker 3 : 02 : 08 : 31
▲▼/Enter/Cancel/Marker
```

2 Press ▲/▼ to select the Marker 1-3.

```
Marker 1 : 00 : 27 : 54
Marker 2 : 01 : 16 : 25
Marker 3 : 02 : 08 : 31
▲▼/Enter/Cancel/Marker
```

3 Press **ENTER**. Playback starts from the marked scene.

To cancel the mark

1 Press **MARKER**.

2 Press ▲/▼ to select the Marker 1-3.

3 Press **CANCEL**. To remove this display, press **MARKER**.

Changing soundtrack language/Karaoke playback



NOTES:

- The vocal output feature is used during playback of Dolby Digital (multi-channel) recorded DVD KARAOKE discs. This feature allows you to turn off vocal audio tracks, or restore them for background accompaniment.
- When playing Karaoke, connect appropriate audio equipment such as an amplifier to the DVD/VCR.

Preparation:

- Turn ON the TV and set it to the video input mode.
- Make sure **TV/VCR/DVD** switch has been slid to VCR/DVD. Then press **DVD** to select the DVD mode. (The DVD indicator will light.)

Changing soundtrack language

You can select the language when you play a multilingual disc.

- 1 Press **A.MONITOR** during playback. The current soundtrack language will appear.

2/8 Fra Dolby Digital
Spatializer Off

- 2 Press **A.MONITOR** repeatedly until the desired language is selected. The on-screen display will disappear after a few seconds.

1/8 Eng Dolby Digital
Spatializer Off

In case of VIDEO CD playback

Audio type changes as follows each time you press **A.MONITOR**.



Karaoke playback

When playing back a DVD KARAOKE disc, you can turn the vocal on or off.

- 1 Press **A.MONITOR** during DVD KARAOKE disc playback.
- 2 Press **▲** or **▼** to select Karaoke vocal setting.
- 3 Press **◀** or **▶** to select "On" or "Off".

1/8 Eng Dolby Digital
Spatializer Off

1/8 Eng Dolby Digital
Off

On: The primary vocal is output when it is recorded on the disc.

Off: The primary vocal is not output.

Subtitles/Changing angles/Title selection/DVD menu



NOTES:

- If the desired language is not heard after pressing the SUBTITLE button several times, the language is not recorded on the disc.
- Changing soundtrack or subtitle language is cancelled when you open the disc tray. The initial default language or available language will be heard and seen if the disc is played back again.
- Depending on the DVD you may be unable to turn on, turn off, or change the subtitles, even if they are recorded on the disc. While playing the DVD, the subtitle may change while opening or closing the disc tray, or while changing the title.
- In some cases, the subtitle language is not changed to the selected one immediately.
- Depending on the DVD, you may not be able to change the angles even if multi-angles are recorded on the disc, or you may be unable to select the title, and a "title menu" may simply be called a "menu" or "title" in the instructions supplied with the disc.

Preparation:

- Turn ON the TV and set it to the video input mode.
- Make sure **TV/VCR/DVD** switch has been slid to VCR/DVD. Then press **DVD** to select the DVD mode. (The DVD indicator will light.)

Turning the Subtitles On and Off

When playing back a disc recorded with subtitles, you can turn the subtitles on or off.

Press **SUBTITLE** during playback until "Off" appears.



Changing the subtitle language

You can select the language when playing back a disc recorded with multi-lingual subtitles.

Press **SUBTITLE** repeatedly during playback until your desired language appears.

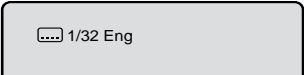

The on-screen display will disappear after a few seconds.

Changing Angles

When playing back a disc recorded with multi-angle facility, you can change the angle that you are viewing the scene from.

1 Press **ANGLE** during playback. The current angle will appear.



2 Press **ANGLE** repeatedly until the desired angle is selected.

Title Selection

Two or more titles are recorded on some discs. If the title menu is recorded on the disc, you can select the desired title.

1 Press **TITLE** during playback. Title menu appears on the screen.

- Press **TITLE** again to resume playback at the scene when you pressed **TITLE**.

2 Press **▲/▼** or **◀/▶** to select the desired title.

3 Press **ENTER** or **PLAY**. The playback of the selected title will start.

DVD Menu

Some DVDs allow you to select the disc contents using the menu.

When you play back these DVDs, you can select the subtitle language and sound-track language, etc. using the DVD menu.

1 Press **DVD MENU** during playback. The DVD menu appears on the screen.

- Press **DVD MENU** again to resume playback at the scene when you pressed **DVD MENU**.

2 Press **▲/▼** or **◀/▶** to select the desired item.

3 Press **ENTER**. The menu continues to another screen. Repeat steps 2 and 3 to set the item completely.

Temporary disabling of rating level by DVD disc

Depending on the DVD disc, the disc may try to temporarily cancel the rating level that you have set. It is up to you to decide whether to cancel the rating level or not.



Preparation:

- Turn ON the TV and set to the video input mode.
- Make sure **TV/VCR/DVD** switch has been slid to VCR/DVD. Then press **DVD** to select the DVD mode. (The DVD indicator will light.)

- 1 Load a DVD disc and press **OPEN/CLOSE** or **PLAY** (see page 37).

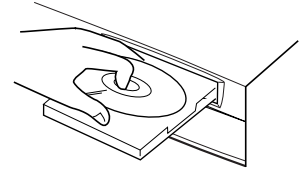

- 2 If the DVD disc has been designed to temporarily cancel the Rating level, the screen which follows the "Reading" screen will change, depending on which disc is played. If you select "YES" with **ENTER** key, "Your disc exceeds the parental control level 1." (e.g.) screen will then appear.



Your disc exceeds the parental control level 1.

Parental Control Level
Cancel Picture
▲▼/Enter/Return

- 3 If you wish to cancel the set rating level temporarily, select "Parental Control Level" with ▲ or ▼, then press **ENTER**. If the 4-digits password at step 3 on page 50 has been set, the password entering screen will appear as shown in step 4 below. Alternatively, if the password has not been set, playback will commence. If you don't know (or have forgotten) the password, select "Cancel Picture". The setting screen will disappear. Press **OPEN/CLOSE** to remove the disc.

- 4 Enter the password with **Number buttons (0-9)**. Then press **ENTER**.

If you interrupt the entering, press **RETURN**.

Please enter the 4 – digit password

Enter/0 – 9/Cancel/Return

- 5 Playback will commence if the entered password was correct.

NOTE:

This temporary cancellation of rating level will be kept until the disc is ejected. When the disc is ejected, the original rating level will be set again automatically.

Setting menu language

You can select the language of the disc menu messages of DVDs.



Preparation:

- Turn ON the TV and set to the video input mode.
- Make sure **TV/VCR/DVD** switch has been slid to VCR/DVD. Then press **DVD** to select the DVD mode. (The DVD indicator will light.)

- 1 Press **SET UP MENU** in the stop mode. Press **◀** or **▶** to select "Language".

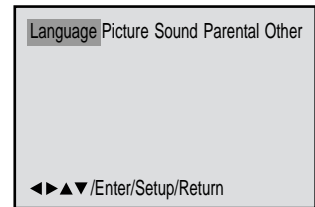

- 2 Press **ENTER**. Then press **▲** or **▼** to select "Menu".

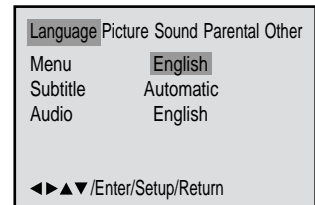

- 3 Press **ENTER**. Press **▲** or **▼** to select your desired language, then press **ENTER**.

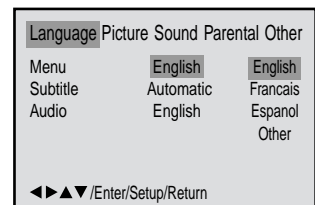

English, Francais, Espanol:

The selected language is the first-priority Menu language.

Other:

Other language can be selected (See the Language code list on page 58).

- 4 To make SETUP screen disappear, press **SET UP MENU**.

Setting subtitle language

The same subtitle language can always be selected even if you replace the disc or turn the power off.



NOTE:

If the selected language is not recorded on the disc, the first-priority language is selected.

Preparation:

- Turn ON the TV and set to the video input mode.
- Make sure **TV/VCR/DVD** switch has been slid to VCR/DVD. Then press **DVD** to select the DVD mode. (The DVD indicator will light.)

- 1 Press **SET UP MENU** in the stop mode. Press ◀ or ▶ to select "Language".

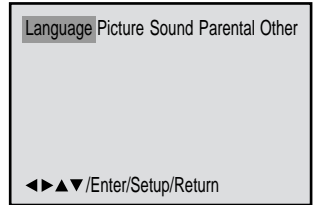

- 2 Press **ENTER**. Then press ▲ or ▼ to select "Subtitle".

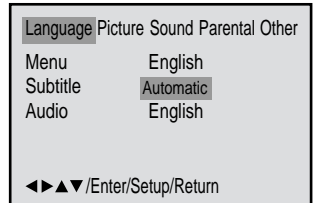

- 3 Press **ENTER**. Press ▲ or ▼ to select your desired language, then press **ENTER**.

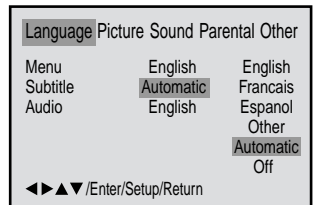

English, Francais, Espanol:

The subtitle is displayed with the selected language if it is recorded on the disc.

Other:

If you want to select another language, enter the language code (see the language code list on page 58).

Automatic:

- The unit will automatically select the same language in the AUDIO setting.
- When the unit selects the same language as the AUDIO, the subtitles will not appear during playback.
- When you do not use the same language as the AUDIO, the subtitles will appear during playback.

Off:

Subtitles do not appear.

- 4 To make SETUP screen disappear, press **SET UP MENU**.

Setting audio soundtrack language/Setting surround sound

Setting audio soundtrack language

The same audio soundtrack language can always be selected by your unit even if you replace the disc or turn the power off.



NOTES:

- If the selected language is not recorded on the disc, the original language will be heard.
- The "SPATIALIZER N-2-2" is effective only for the sound of disc.

Preparation:

- Turn ON the TV and set to the video input mode.
- Make sure **TV/VCR/DVD** switch has been slid to VCR/DVD. Then press **DVD** to select the DVD mode. (The DVD indicator will light.)

- 1 Press **SET UP MENU** in the stop mode.
Press ◀ or ▶ to select "Language".

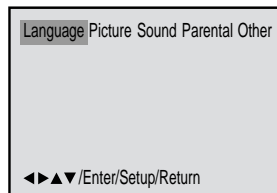

- 2 Press **ENTER**.
Then press ▲ or ▼ to select "Audio".

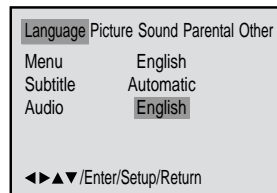

- 3 Press **ENTER**.
Press ▲ or ▼ to select your desired Audio Language, then press **ENTER**.

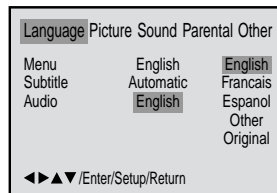

English, Francais, Espanol:

The language you have selected will play if it is recorded on the disc.

Other:

If you want to select another language, enter the language code (See the Language code list on page 58).

Original:

The unit will select the first priority language of each disc.

- 4 To make SETUP screen disappear, press **SET UP MENU**.

Setting surround sound

This DVD/VCR equipped with a "SPATIALIZER N-2-2". It can produce the effect of being in a cinema or a concert hall.

- 1 During disc playback press **A. MONITOR**.



- 2 Press ▶ to select "On".

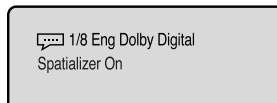

To cancel Surround mode:

Follow the right steps 1~2, then press ▶ to select the "Off" position.

Setting the aspect ratio of TV screen

You can select the aspect ratio for your TV.



NOTE:

If the DVD disc is not formatted in the pan & scan style, it displays 4:3 style.

Preparation:

- Turn ON the TV and set to the video input mode.
- Make sure **TV/VCR/DVD** switch has been slid to VCR/DVD. Then press **DVD** to select the DVD mode. (The DVD indicator will light.)

- 1 Press **SET UP MENU** in the stop mode.
Press ◀ or ▶ to select "Picture".

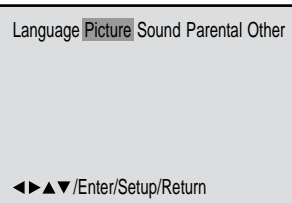

- 2 Press **ENTER**, then press ▲ or ▼ to select "Tv Screen".

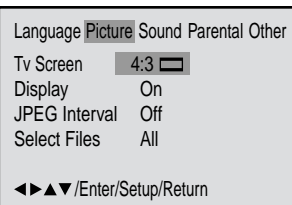

- 3 Press **ENTER**.
Press ▲ or ▼ to select your desired screen type, then press **ENTER**.

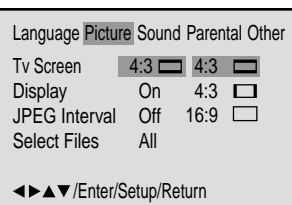

You have the following screen sizes to choose from:

4:3 Letter box:

Select this mode when connecting to a conventional TV. When playing back a wide screen-DVD disc, it displays the wide picture with black bands at the top and bottom of screen.

4:3 Pan scan:

It displays the wide picture on the whole screen with left and right edges automatically cut off.

16:9 Wide:

Select this mode when connecting to a wide-screen TV. A wide screen picture is displayed full size.

- 4 To make SETUP screen disappear, press **SET UP MENU**.

Setting on screen display/Status display of disc

On screen display can be switched on or off when you press the buttons.



Preparation:

- Turn ON the TV and set to the video input mode.
- Make sure **TV/VCR/DVD** switch has been slid to VCR/DVD. Then press **DVD** to select the DVD mode. (The DVD indicator will light.)

1 Press **SET UP MENU** in the stop mode.

Press ◀ or ▶ to select "Picture".

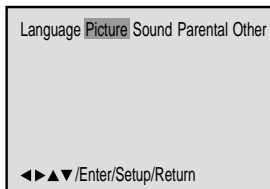

2 Press **ENTER**, then press ▲ or ▼ to select "Display".

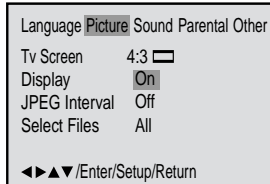

3 Press **ENTER** to select "On" or "Off".

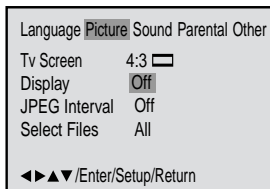

On: On screen displays appears when you press the any buttons (factory setting).

Off: On screen displays do not appear when you press any buttons except **SET UP MENU**, **SEARCH MODE**, **PLAY MODE**, **MARKER** and **OSD**.

4 To make SETUP screen disappear, press **SET UP MENU**.

Status display of disc

Each press of **OSD**, the status display of the disc will appear on the screen and change as follows.



To make status display disappear, press **OSD** again.

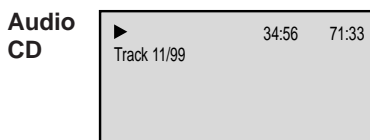
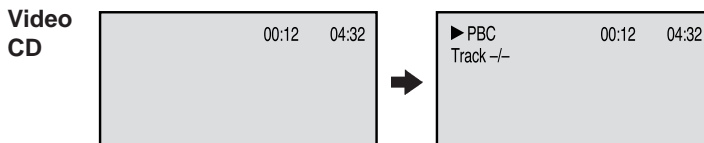

When you playback the CD disc, the status display will appear on the screen and continue displaying.

Dynamic Range Control

DRC (Dynamic Range Control) enables you to control the dynamic range so as to achieve a suitable sound for your equipment.



NOTES:

- This function works only during playback of Dolby Digital recorded discs.
- The level of Dynamic Range Reduction may differ depending on DVD video disc.

Preparation:

- Turn ON the TV and set to the video input mode.
- Make sure **TV/VCR/DVD** switch has been slid to VCR/DVD. Then press **DVD** to select the DVD mode. (The DVD indicator will light.)

- 1** Press **SET UP MENU** in the stop mode.
Press ◀ or ▶ to select "Sound".

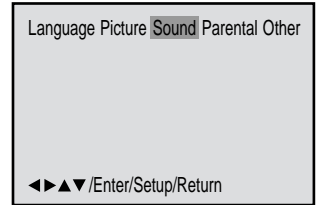

- 2** Press ▼ or **ENTER** to select "DRC".

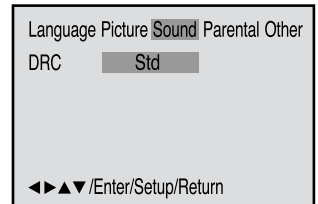

- 3** Press ▶ or **ENTER**, then press ▲ or ▼ to select desired setting.

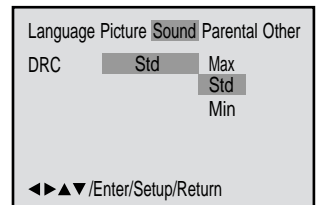

- Max:** Full dynamic range is increased.
Std: Full dynamic range is maintained.
Min: Dynamic range is reduced.

Language code list

Enter the appropriate code number for the initial settings "Menu", "Subtitle" and/or "Audio" (see pages 52-54).

| LanguageName | Code | LanguageName | Code | LanguageName | Code | LanguageName | Code |
|-----------------|------|------------------|------|----------------|------|--------------|------|
| Abkhazian | 1112 | Fiji | 1620 | Lingala | 2224 | Singhalese | 2919 |
| Afar | 1111 | Finnish | 1619 | Lithuanian | 2230 | Slovak | 2921 |
| Afrikaans | 1116 | French | 1628 | Macedonian | 2321 | Slovenian | 2922 |
| Albanian | 2927 | Frisian | 1635 | Malagasy | 2317 | Somali | 2925 |
| Amharic | 1123 | Galician | 1722 | Malay | 2329 | Spanish | 1529 |
| Arabic | 1128 | Georgian | 2111 | Malayalam | 2322 | Sundanese | 2931 |
| Armenian | 1835 | German | 1415 | Maltese | 2330 | Swahili | 2933 |
| Assamese | 1129 | Greek | 1522 | Maori | 2319 | Swedish | 2932 |
| Aymara | 1135 | Greenlandic | 2122 | Marathi | 2328 | Tagalog | 3022 |
| Azerbaijani | 1136 | Guarani | 1724 | Moldavian | 2325 | Tajik | 3017 |
| Bashkir | 1211 | Gujarati | 1731 | Mongolian | 2324 | Tamil | 3011 |
| Basque | 1531 | Hausa | 1811 | Nauru | 2411 | Tatar | 3030 |
| Bengali; Bangla | 1224 | Hebrew | 1933 | Nepali | 2415 | Telugu | 3015 |
| Bhutani | 1436 | Hindi | 1819 | Norwegian | 2425 | Thai | 3018 |
| Bihari | 1218 | Hungarian | 1831 | Oriya | 2528 | Tibetan | 1225 |
| Breton | 1228 | Icelandic | 1929 | Panjabi | 2611 | Tigrinya | 3019 |
| Bulgarian | 1217 | Indonesian | 1924 | Pashto, Pushto | 2629 | Tonga | 3025 |
| Burmese | 2335 | Interlingua | 1911 | Persian | 1611 | Turkish | 3028 |
| Byelorussian | 1215 | Irish | 1711 | Polish | 2622 | Turkmen | 3021 |
| Cambodian | 2123 | Italian | 1930 | Portuguese | 2630 | Twi | 3033 |
| Catalan | 1311 | Japanese | 2011 | Quechua | 2731 | Ukrainian | 3121 |
| Chinese | 3618 | Javanese | 2033 | Rhaeto-Romance | 2823 | Urdu | 3128 |
| Corsican | 1325 | Kannada | 2124 | Romanian | 2825 | Uzbek | 3136 |
| Croatian | 1828 | Kashmiri | 2129 | Russian | 2831 | Vietnamese | 3219 |
| Czech | 1329 | Kazakh | 2121 | Samoan | 2923 | Volapük | 3225 |
| Danish | 1411 | Kirghiz | 2135 | Sanskrit | 2911 | Welsh | 1335 |
| Dutch | 2422 | Korean | 2125 | Scots Gaelic | 1714 | Wolof | 3325 |
| English | 1524 | Kurdish | 2131 | Serbian | 2928 | Xhosa | 3418 |
| Esperanto | 1525 | Laothian | 2225 | Serbo-Croatian | 2918 | Yiddish | 2019 |
| Estonian | 1530 | Latin | 2211 | Shona | 2924 | Yoruba | 3525 |
| Faroese | 1625 | Latvian, Lettish | 2232 | Sindhi | 2914 | Zulu | 3631 |

Problems and troubleshooting

Use the following check list for troubleshooting when you have problems with your unit. Consult your local dealer or service outlet if problems persist.

Be sure all connections are properly made when using with other units.

| SYMPTOMS | POSSIBLE SOLUTIONS | PAGE |
|--|--|---|
| DVD/VCR | | |
| DVD/VCR does not operate. | <ul style="list-style-type: none"> • Make sure the power cord is plugged in. • Try another AC outlet. • Power is off, check fuse or circuit breaker. • Unplug unit, then plug it back in. • Select the DVD or VCR mode before operating. • Make sure TV/VCR/DVD switch has been slid to VCR/DVD. | <p>–</p> <p>–</p> <p>–</p> <p>–</p> <p>18,36</p> <p>18,36</p> |
| No picture. | <ul style="list-style-type: none"> • Antenna connection is not correct or antenna cable is disconnected. • The video channel is not in the correct position or the TV is not set to the video channel 3 or 4. • Check the unit is connected correctly. • The video input selector of the TV is not set to VIDEO. Set to VIDEO (or equivalent). • Channel is set to the external mode. | <p>12~15</p> <p>18</p> <p>12~17</p> <p>–</p> <p>–</p> |
| No sound. | <ul style="list-style-type: none"> • Check the unit is connected correctly. • Check the input selector of the amplifier is set properly. • The unit is in the Special playback mode. | <p>12~17</p> <p>–</p> <p>26,38</p> |
| The remote control does not function. | <ul style="list-style-type: none"> • Aim the remote control at the remote sensor. • Operate within Approx. 5 Meters or reduce the light in the room. • Clear the path of the beam. • The batteries are weak. Replace the batteries. • Check the batteries are inserted correctly. • Check the frequency code is set correctly. | <p>9</p> |
| The DVD-keys on the RCU of the other JVC RECEIVER/TV is not effective. | <ul style="list-style-type: none"> • This is not a defect. Since this unit is combined type of DVD and VCR, the remote code of DVD is individual. | <p>10,11</p> |
| No CATV reception | <ul style="list-style-type: none"> • Check all CATV connections. • Station or CATV system problems, try another station. | <p>14,15</p> |
| No POWER but a picture appears on the TV screen. | <ul style="list-style-type: none"> • During the Auto Clock operation, a video signal can be put out. Please set the clock with Manual clock setting or wait until the Auto Clock operation completed. | <p>23</p> |
| VCR | | |
| TV recording does not work. | <ul style="list-style-type: none"> • The erase prevention tab of the video cassette is broken off. • The unit is in the external input mode. | <p>24,28</p> |
| Timer recording does not work. | <ul style="list-style-type: none"> • The time is not set correctly. • The recording start/end time is not set correctly. • The TIMER has not been pressed (⏸ is not lit). | <p>21,23</p> <p>31</p> <p>31</p> |
| Noise bars on screen. | <ul style="list-style-type: none"> • Tracking adjustment beyond range of automatic tracking circuit. Try Manual tracking adjustment. • Video heads are dirty. • The tape is worn or damaged. | <p>26</p> <p>60</p> <p>–</p> |
| DVD | | |
| Display is not shown in your language. | <ul style="list-style-type: none"> • Select proper language in the menu options. | <p>36</p> |
| Playback doesn't start. | <ul style="list-style-type: none"> • No disc is inserted. • The disc may be dirty. Clean up the disc. • The unit cannot play DVD-ROMs, etc. | <p>37</p> <p>35</p> <p>35</p> |

Problems and troubleshooting/Video head cleaning

| SYMPTOMS | POSSIBLE SOLUTIONS | PAGE |
|--|---|-------|
| Stopping playback, search, slow-motion play, repeat play, or program play, etc. cannot be performed. | • Some discs may not do some of the functions. | – |
| No picture. | • The S-VIDEO/COMPONENT selector is not set correctly. | 16 |
| No 4:3 (16:9) picture. | • The setup does not match your TV. | 55 |
| No on-screen display. | • Select Display On. | 56 |
| No surround sound. | • The setup does not match your stereo system. | 17 |
| The unit or remote operation key is not functioning. | • Turn off the unit and unplug the AC power cord for several minutes, then replug it. | – |
| Playback does not start when the title is selected. | • Check the Parental setup. | 50 |
| Audio soundtrack and/or subtitle language is not changed when you play back a DVD. | • Multilingual language is not recorded on the DVD disc. | 53,54 |
| No subtitle. | • Some discs have no subtitles. • Subtitles are cleared. Press SUBTITLE. | 49 |
| Angle cannot be changed. | • Multi-angles are not recorded on the DVD disc. | 49 |
| ✎ appears on the screen. | • The function is prohibited with the unit or the disc. | 37 |

Video head cleaning

Video head clogging

The video heads are the means by which the DVD/VCR reads the picture from the tape during playback. In the unlikely event that the heads become dirty enough to be clogged, no picture will be played back. This can easily be determined if, during playback of a known good tape, there is good sound, but no picture (picture is extremely snowy). If this is the case, have the DVD/VCR checked by qualified service personnel.



Good Picture



Snowy Picture

NOTES: • DO NOT ATTEMPT TO CLEAN THE VIDEO HEADS OR SERVICE THE UNIT BY REMOVING THE REAR COVER.

- Video heads may eventually wear out and should be replaced when they fail to produce clear pictures.
- To help prevent video head clogging, use only good quality VHS tapes. Discard worn out tapes.

Note

Auto Clock Setting

The XDS signals are carried only by certain broadcast television stations (for example, the signal is carried by most Public Broadcasting Service stations). You must be able to receive a station carrying the XDS signal to use the Auto Clock Setting to set your DVD/VCR's internal clock. If you live in an area that does not broadcast XDS signals, you must set the clock manually. Please see page 23 for instructions on how to manually set your DVD/VCR's clock.

GENERAL

| | |
|---------------------------|--|
| Power supply: | 110-220 V, 50/60 Hz |
| Power consumption: | Operation: 18 W Stand by: 3 W |
| Weight: | 7.9 lbs (3.6 kg) |
| Dimensions: | Width : 16-15/16 inches (430 mm) Height : 3-7/8 inches (99 mm) Depth : 9-13/16 inches (249 mm) |
| Inputs/Outputs: | |
| Video: | In: 1 Vp-p/75 ohm Out: 1 Vp-p/75 ohm |
| Audio: | In: -8 dBm/50 k ohm Out: -8 dBm/1 k ohm |
| Antenna: | UHF/VHF IN/OUT: 75 ohm coaxial |
| Hi-Fi Frequency Response: | 20 Hz to 20,000 Hz |
| Hi-Fi Dynamic Range: | More than 90 dB |

VCR section

| | |
|--------------------|--|
| Video Head: | 4 Rotary Heads |
| Audio Track: | Hi-Fi Sound - 2 Tracks / MONO Sound - 1 Track |
| Tuner: | 181 Channel Freq. Synthesized VHF 2-13 UHF 14-69 CATV 14-36 (A)-(W) 37-59 (AA)-(WW) 60-85 (AAA)-(ZZZ) 86-94 (86)-(94) 95-99 (A-5)-(A-1) 100-125 (100)-(125) 01 (5A) |
| RF Channel Output: | Channel 3 or 4, Switchable |
| F.FWD/REW Time: | Approx. 1 minute 48 seconds (with T-120 Cassette Tape) (at + 25°C) |

DVD section

| | |
|-----------------------|---|
| Signal system: | NTSC |
| Applicable disc: | DVD (12 cm, 8 cm), CD (12 cm, 8 cm) |
| Audio characteristics | |
| Frequency response: | DVD: 4 Hz - 22 kHz CD: 4 Hz - 20 kHz |
| S/N Ratio: | 90 dB |
| Harmonic distortion | 0.02% |
| Wow and flutter: | Less than 0.01% Wrms |
| Dynamic range: | More than 90 dB |
| Output: | Video : (RCA) 1 Vp-p/75 ohm Audio : (RCA) -12 dBm/1k ohm Digital Audio : 0.5 Vp-p 75 ohm |
| Pickup: | CD : Wavelength: 775 - 805 nm Maximum output power: 0.5 mW DVD : Wavelength: 640 - 660 nm Maximum output power: 1.0 mW |

ACCESSORIES:

Remote control x 1
Batteries (2 x AA)
75 ohm Coaxial Cable x 1
AUDIO/VIDEO Cable x 1
Conversion plug x 1



J2C50801A

03/07 U



Printed in Thailand
0703-AH-OR-OR

Free Manuals Download Website

<http://myh66.com>

<http://usermanuals.us>

<http://www.somanuals.com>

<http://www.4manuals.cc>

<http://www.manual-lib.com>

<http://www.404manual.com>

<http://www.luxmanual.com>

<http://aubethermostatmanual.com>

Golf course search by state

<http://golfingnear.com>

Email search by domain

<http://emailbydomain.com>

Auto manuals search

<http://auto.somanuals.com>

TV manuals search

<http://tv.somanuals.com>