

JVC

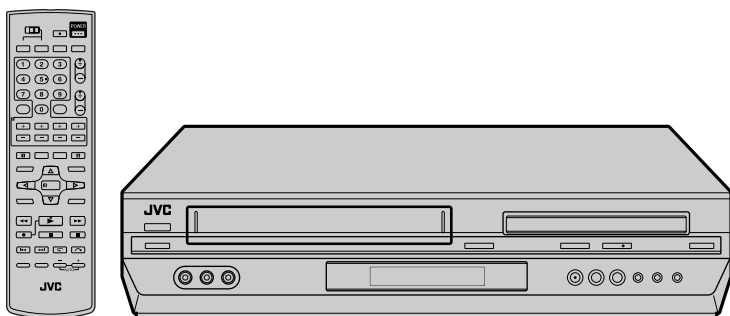

DVD PLAYER & VIDEO CASSETTE RECORDER

HR-XVC24S



Hi-Fi

VHS

SQPB

DVD
VIDEO

dtc
2.0+DIGITAL OUT

DOLBY
DIGITAL

COMPACT
disc
DIGITAL VIDEO

COMPACT
disc
DIGITAL AUDIO

COMPACT
disc
SUPER VIDEO

INSTRUCTIONS

For Customer Use:

Enter below the Model No. and
Serial No. which are located on the
rear of cabinet. Retain this
information for future reference.

Model No. _____

Serial No. _____

LPT0926-001A

Dear Customer,

Thank you for purchasing the JVC DVD player & VHS video cassette recorder. Before use, please read the safety information and precautions to ensure safe use of your new unit.

CAUTIONS

CAUTION
RISK OF ELECTRIC SHOCK
DO NOT OPEN



CAUTION: TO REDUCE THE RISK OF ELECTRIC SHOCK,
DO NOT REMOVE COVER (OR BACK).
NO USER-SERVICEABLE PARTS INSIDE.
REFER SERVICING TO QUALIFIED SERVICE PERSONNEL.



The lightning flash with arrowhead symbol, within an equilateral triangle, is intended to alert the user to the presence of uninsulated "dangerous voltage" within the product's enclosure that may be of sufficient magnitude to constitute a risk of electric shock to persons.



The exclamation point within an equilateral triangle is intended to alert the user to the presence of important operating and maintenance (servicing) instructions in the literature accompanying the appliance.

WARNING:

TO PREVENT FIRE OR SHOCK HAZARD, DO NOT EXPOSE THIS UNIT TO RAIN OR MOISTURE.

CAUTION:

This unit should be used with AC 120V \sim , 60Hz only. To prevent electric shocks and fire hazards, DO NOT use any other power source.

CAUTION:

TO PREVENT ELECTRIC SHOCK, MATCH WIDE BLADE OF PLUG TO WIDE SLOT, FULLY INSERT.

ATTENTION:

POUR ÉVITER LES CHOCS ÉLECTRIQUES, INTRODUIRE LA LAME LA PLUS LARGE DE LA FICHE DANS LA BORNE CORRESPONDANTE DE LA PRISE ET POUSSER JUSQU'AU FOND.

Note to CATV system installer:

This reminder is provided to call the CATV system installer's attention to Article 820-40 of the NEC that provides guidelines for proper grounding and, in particular, specifies that the cable ground shall be connected to the grounding system of the building, as close to the point of cable entry as practical.

CAUTION:

Changes or modifications not approved by JVC could void user's authority to operate the equipment.

CAUTION:

THIS PRODUCT USES A LASER SYSTEM.
USE OF CONTROLS OR ADJUSTMENTS OR PERFORMANCE OF PROCEDURES OTHER THAN THOSE SPECIFIED HEREIN MAY RESULT IN HAZARDOUS RADIATION EXPOSURE.
DO NOT OPEN COVERS AND DO NOT REPAIR YOURSELF. REFER SERVICING TO QUALIFIED PERSONNEL.

CLASS 1 LASER PRODUCT
REPRODUCTION OF LABELS
WARNING LABEL INSIDE OF THE UNIT

CAUTION - VISIBLE OR INVISIBLE LASER RADIATION WHEN OPEN.
DO NOT STARE INTO BEAM.
ATTENTION - RAYONNEMENT LASER VISIBLE OU INVISIBLE EN CAS D'OUVERTURE.
NE PAS REGARDER DANS LE FAISCEAU. LP41077-002A

Declaration of Conformity

Model Number: HR-XVC24S
Trade Name: JVC
Responsible Party: JVC Americas Corp.
Address: 1700 Valley Road Wayne, N.J. 07470
Telephone Number: 973-317-5000

This device complies with Part 15 of FCC Rules.

Operation is subject to the following two conditions:

(1) This device may not cause harmful interference, and (2) this device must accept any interference received, including interference that may cause undesired operation.

This equipment has been tested and found to comply with the limits for a Class B digital device, pursuant to Part 15 of the FCC Rules. These limits are designed to provide reasonable protection against harmful interference in a residential installation. This equipment generates, uses, and can radiate radio frequency energy and, if not installed and used in accordance with the instructions, may cause harmful interference to radio communications. However, there is no guarantee that interference will not occur in a particular installation. If this equipment does cause harmful interference to radio or television reception, which can be determined by turning the equipment off and on, the user is encouraged to try to correct the interference by one or more of the following measures:

Reorient or relocate the receiving antenna.

Increase the separation between the equipment and receiver.

Connect the equipment into an outlet on a circuit different from that to which the receiver is connected.

Consult the dealer or an experienced radio/TV technician for help.

IMPORTANT PRODUCT SAFETY INSTRUCTIONS

Electrical energy can perform many useful functions. But improper use can result in potential electrical shock or fire hazards. This product has been engineered and manufactured to assure your personal safety. In order not to defeat the built-in safeguards, observe the following basic rules for its installation, use and servicing.

ATTENTION

Follow and obey all warnings and instructions marked on your product and its operating instructions. For your safety, please read all the safety and operating instructions before you operate this product and keep this booklet for future reference.

INSTALLATION

1. Grounding or Polarization

(A) Your product may be equipped with a polarized alternating-current line plug (a plug having one blade wider than the other). This plug will fit into the power outlet only one way. This is a safety feature.

If you are unable to insert the plug fully into the outlet, try reversing the plug. If the plug should still fail to fit, contact your electrician to replace your obsolete outlet. Do not defeat the safety purpose of the polarized plug.

(B) Your product may be equipped with a 3-wire grounding-type plug, a plug having a third (grounding) pin. This plug will only fit into a grounding-type power outlet. This is a safety feature.

If you are unable to insert the plug into the outlet, contact your electrician to replace your obsolete outlet. Do not defeat the safety purpose of the grounding-type plug.

2. Power Sources

Operate your product only from the type of power source indicated on the marking label. If you are not sure of the type of power supply to your home, consult your product dealer or local power company. If your product is intended to operate from battery power, or other sources, refer to the operating instructions.

3. Overloading

Do not overload wall outlets, extension cords, or integral convenience receptacles as this can result in a risk of fire or electric shock.

4. Power Cord Protection

Power supply cords should be routed so that they are not likely to be walked on or pinched by items placed upon or against them, paying particular attention to cords at plugs, convenience receptacles, and the point where they exit from the product.

5. Ventilation

Slots and openings in the cabinet are provided for ventilation. To ensure reliable operation of the product and to protect it from overheating, these openings must not be blocked or covered.

- Do not block the openings by placing the product on a bed, sofa, rug or other similar surface.
- Do not place the product in a built-in installation such as a bookcase or rack unless proper ventilation is provided or the manufacturer's instructions have been adhered to.

6. Wall or Ceiling Mounting

The product should be mounted to a wall or ceiling only as recommended by the manufacturer.

ANTENNA INSTALLATION INSTRUCTIONS

1. Outdoor Antenna Grounding

If an outside antenna or cable system is connected to the product, be sure the antenna or cable system is grounded so as to provide some protection against voltage surges and built-up static charges. Article 810 of the National Electrical Code, ANSI/NFPA 70, provides information with regard to proper grounding of the mast and supporting structure, grounding of the lead-in wire to an antenna discharge unit, size of grounding connectors, location of antenna discharge unit, connection to grounding electrodes, and requirements for the grounding electrode.

2. Lightning

For added protection for this product during a lightning storm, or when it is left unattended and unused for long periods of time, unplug it from the wall outlet and disconnect the antenna or cable system. This will prevent damage to the product due to lightning and power-line surges.

3. Power Lines

An outside antenna system should not be located in the vicinity of overhead power lines or other electric light or power circuits, or where it can fall into such power lines or circuits. When installing an outside antenna system, extreme care should be taken to keep from touching such power lines or circuits as contact with them might be fatal.

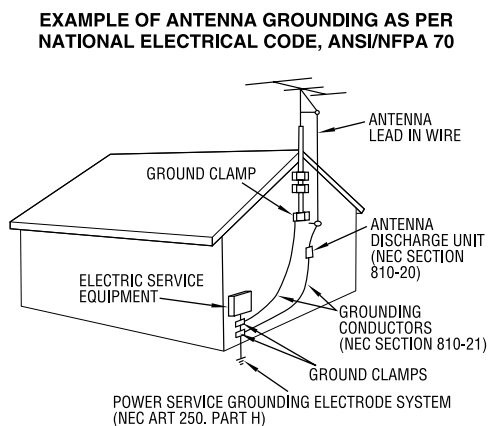

NEC – NATIONAL ELECTRICAL CODE

USE

1. Accessories

To avoid personal injury:

- Do not place this product on an unstable cart, stand, tripod, bracket, or table. It may fall, causing serious injury to a child or adult, and serious damage to the product.
- Use only with a cart, stand, tripod, bracket, or table recommended by the manufacturer or sold with the product.
- Use a mounting accessory recommended by the manufacturer and follow the manufacturer's instructions for any mounting of the product.
- Do not try to roll a cart with small casters across thresholds or deep-pile carpets.

2. Product and Cart Combination

A product and cart combination should be moved with care. Quick stops, excessive force, and uneven surfaces may cause the product and cart combination to overturn.

PORTABLE CART WARNING
(Symbol provided by RETAC)



3. Water and Moisture

Do not use this product near water—for example, near a bath tub, wash bowl, kitchen sink or laundry tub, in a wet basement, or near a swimming pool and the like.

4. Object and Liquid Entry

Never push objects of any kind into this product through openings as they may touch dangerous voltage points or short-out parts that could result in a fire or electric shock. Never spill liquid of any kind on the product.

5. Attachments

Do not use attachments not recommended by the manufacturer of this product as they may cause hazards.

6. Cleaning

Unplug this product from the wall outlet before cleaning. Do not use liquid cleaners or aerosol cleaners. Use a damp cloth for cleaning.

7. Heat

The product should be situated away from heat sources such as radiators, heat registers, stoves, or other products (including amplifiers) that produce heat.

SERVICING

1. Servicing

If your product is not operating correctly or exhibits a marked change in performance and you are unable to restore normal operation by following the detailed procedure in its operating instructions, do not attempt to service it yourself as opening or removing covers may expose you to dangerous voltage or other hazards. Refer all servicing to qualified service personnel.

2. Damage Requiring Service

Unplug this product from the wall outlet and refer servicing to qualified service personnel under the following conditions:

- When the power supply cord or plug is damaged.
- If liquid has been spilled, or objects have fallen into the product.
- If the product has been exposed to rain or water.
- If the product does not operate normally by following the operating instructions. Adjust only those controls that are covered by the operating instructions as an improper adjustment of other controls may result in damage and will often require extensive work by a qualified technician to restore the product to its normal operation.
- If the product has been dropped or damaged in any way.
- When the product exhibits a distinct change in performance—this indicates a need for service.

3. Replacement Parts

When replacement parts are required, be sure the service technician has used replacement parts specified by the manufacturer or which have the same characteristics as the original part. Unauthorized substitutions may result in fire, electric shock or other hazards.

4. Safety Check

Upon completion of any service or repairs to this product, ask the service technician to perform safety checks to determine that the product is in safe operating condition.

HOW TO USE THIS INSTRUCTION MANUAL

- All major sections and subsections are listed in the Table Of Contents on page 6. Use this when searching for information on a specific procedure or feature.
- The Index on pages 9 – 12 lists frequently-used terms, and the number of the page on which they are used or explained in the manual. This section also illustrates the controls and connections on the front and rear panel, the front display panel and the remote control.
- The  mark signals a reference to another page for instructions or related information.
- Operation buttons necessary for the various procedures are clearly indicated through the use of illustrations at the beginning of each major section.

BEFORE YOU INSTALL YOUR NEW UNIT . . .

. . . please read the sections/literature listed below.

- "CAUTIONS" on page 2
- "IMPORTANT PRODUCT SAFETY INSTRUCTIONS" on pages 3 – 4

DSS™ is an official trademark of DIRECTV, Inc., a unit of GM Hughes Electronics. DISH Network™ is a trademark of EchoStar Communications Corporation.



- Manufactured under license from Dolby Laboratories. “Dolby” and the double-D symbol are trademarks of Dolby Laboratories.
- “DTS” and “DTS 2.0 + Digital Out” are trademarks of Digital Theater Systems, Inc.
- Cassettes marked “VHS” (or “S-VHS”) can be used with this unit. However, S-VHS recording is not possible with this model.
- This model is equipped with SQPB (S-VHS QUASI PLAYBACK) that makes it possible to play back S-VHS recordings with regular VHS resolution.
- HQ VHS is compatible with existing VHS equipment.
- This product incorporates copyright protection technology that is protected by U.S. patents and other intellectual property rights. Use of this copyright protection technology must be authorized by Macrovision, and is intended for home and other limited viewing uses only unless otherwise authorized by Macrovision. Reverse engineering or disassembly is prohibited.

When the equipment is installed in a cabinet or a shelf, make sure that it has sufficient space on all sides to allow for ventilation (10 cm or more on both sides, on top and at the rear.)

When discarding batteries, environmental problems must be considered and the local rules or laws governing the disposal of these batteries must be followed strictly.

Failure to heed the following precautions may result in damage to the unit, Remote or video cassette.

1. **DO NOT place the unit —**
 - in an environment prone to extreme temperatures or humidity.
 - in direct sunlight.
 - in a dusty environment.
 - in an environment where strong magnetic fields are generated.
 - on a surface that is unstable or subject to vibration.
2. **DO NOT block the unit’s ventilation openings or holes.**
(If the ventilation openings or holes are blocked by a newspaper or cloth, etc., the heat may not be able to get out.)
3. **DO NOT place heavy objects on the unit or Remote.**
4. **DO NOT place anything which might spill on top of the unit or Remote.**
(If water or liquid is allowed to enter this equipment, fire or electric shock may be caused.)
5. **DO NOT expose the apparatus to dripping or splashing.**
6. **DO NOT use this equipment in a bathroom or places with water. Also DO NOT place any containers filled with water or liquids (such as cosmetics or medicines, flower vases, potted plants, cups, etc.) on top of this unit.**
7. **DO NOT place any naked flame sources, such as lighted candles, on the apparatus.**

8. **AVOID violent shocks to the unit during transport.**

MOISTURE CONDENSATION

Moisture in the air will condense on the unit when you move it from a cold place to a warm place, or under extremely humid conditions—just as water droplets form in the surface of a glass filled with cold liquid. Moisture condensation on the head drum will cause damage to the tape. In conditions where condensation may occur, keep the unit turned on for a few hours to let the moisture dry.

ATTENTION

To mobile phone users:

Using a mobile phone in the vicinity of the unit may cause picture vibration on the TV screen or change the screen to a blue back display.

On placing the unit:







Some TVs or other appliances generates strong magnetic fields. Do not place such appliance on top of the unit as it may cause picture disturbance.

DISC INFORMATION	7	EDITING (VCR DECK)	52
About Discs	7	Edit From A Camcorder	52
INDEX	9	Edit To Or From Another Video Recorder	53
INSTALLING YOUR NEW UNIT	13	Dubbing (from DVD to VCR)	54
Basic Connections	13	EDITING (DVD DECK)	55
Component Video Connection (DVD deck only)	14	Digital Audio Dubbing	55
Scan Mode Set (DVD deck only)	15	REMOTE	56
INITIAL SETTINGS	16	Remote Control Functions	56
Plug & Play Set	16	Connecting To A Dolby Digital Decoder or An Amplifier With A Built-in DTS (DVD deck only)	57
Monitor Set (DVD deck)	17	SUBSIDIARY SETTINGS	58
Language	18	Mode Set (VCR deck)	58
Clock Set	22	Mode Set (DVD deck)	61
Tuner Set	24	Child Lock	64
OPERATIONS ON VCR DECK	26	TROUBLESHOOTING	65
Basic Playback	26	QUESTIONS AND ANSWERS	70
Playback Features	27	SPECIFICATIONS	71
Basic Recording	31	LIST OF TERMS	72
Recording Features	32		
Express Timer Programing	34		
Satellite Auto Recording	39		
OPERATIONS ON DVD DECK	40		
Basic Playback	40		
Playback Features	41		
Using the on-screen bar	47		
MP3/JPEG Files Playback	49		

About Discs





Playable Discs

You can use discs with the following logos for playback only.

DVD VIDEO 	Video CD/Super Video CD  
Audio CD CD-DA files 	 

- The following discs also can be played back.
 - DVD-R/-RW discs recorded in DVD VIDEO mode and finalized.
 - CD-R/RW discs recorded in Video CD, SVCD (Super Video CD), or Audio CD format and finalized.
 - CD-R/RW discs written in MP3 or JPEG in accordance with the "ISO 9660" format. (See page 49 for details.)
- This unit can also play back audio signals recorded in MIX-MODE CD, CD-G, CD-EXTRA, and CD TEXT.
- The image may be sometimes poor or noisy due to defects in the disc itself.
- With some discs, operations may not be possible.

Marks of discs in this instruction manual

	Allows operation with a DVD VIDEO disc.		Allows operation with a Video CD disc.
	Allows operation with a SVCD disc.		Allows operation with an Audio CD disc.

Unplayable Discs

The following types of discs cannot be played using this unit.

- CD-ROM discs (including PHOTO-CD)
- DVD AUDIO discs
- Super Audio CDs (SACD)
- DVD-RW discs recorded in VR mode
- DVD-RAM discs
- DVD-ROM discs

In addition, this unit does not play:

- Unfinalized discs
- Discs of irregular shape or discs with tape, seals, or paste on either the label side or playback side. Playing back these discs may damage the unit.

The Non-DVD side of a "DualDisc" does not comply with the "Compact Disc Digital Audio" standard. Therefore, the use of Non-DVD side of a DualDisc on this product may not be recommended.

Region Number

The world is divided into 6 regions for DVD VIDEO discs. DVD VIDEO discs are assigned a region number to indicate which region they may be played back in. A disc cannot be played back on this unit unless the region number of the disc matches that of the unit. The region number for this unit is "1." Only discs whose region number includes "1" can be played back such as shown below.





Examples of DVD VIDEO labels which can be played back using this unit.





DVD VIDEO Marks

Sometimes marks are printed on a DVD disc and/or on its packaging to indicate information regarding the contents and functions of a disc. Check marks indicating the contents and functions of a disc. Note, however, that in some cases a disc may not include a mark even for a function it supports.

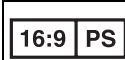
Marks related to video

	Number of subtitles		Number of angles
	Recorded under the standard 4:3 aspect ratio		Screen includes black bands at top and bottom of image which has a standard 4:3 aspect ratio (letter box)
	Video playback is in Wide video mode (16:9) on wide televisions, but in letter box on televisions with standard 4:3 aspect ratio.		
	Video playback is in Wide video mode (16:9) on wide televisions, but pan and scan is used on televisions with standard 4:3 aspect ratio (either the left or right side of the image is cut-out).		

Marks related to audio

	Number of audio tracks
	Dolby Digital mark Dolby Laboratories has developed a digital surround system for the home. This mark indicates that you may enjoy 5.1-channel audio (front left and right, center, rear left and right, and a channel for LFE (Low-Frequency Effects)).
	DTS (Digital Theater System) You can enjoy DTS audio if you connect an amplifier with a built-in DTS decoder to the DIGITAL AUDIO OUT connector of the unit.

File Structure of Discs

DVD VIDEO

Typically, DVD VIDEO discs are made up of larger units called "titles." Each title has a number (title number) that can be used to select desired titles. Titles are further divided into units called "chapters." Each chapter has a number (chapter number) that can also be used to select desired chapters. Note that some discs are not divided into titles and chapters.

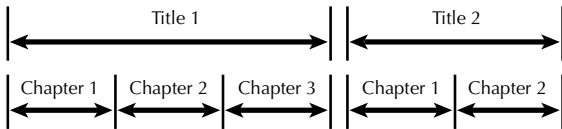

Audio CD/Video CD

Typically, Audio CD discs are divided into separate tracks each containing one song. Each track is assigned a number. For example, the third track is Track 3. The same is true for Video CD discs.

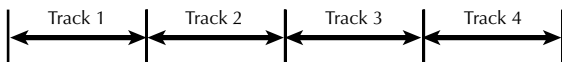

NOTE:

Video CD discs that support Playback Control (PBC)

The still image or motion image which follows a menu screen is called a "scene." Each scene has a scene number. For more details, refer to "Locating a Desired Scene Using the Menu of the Video CD with Playback Control (PBC) Function" (pg. 41).

Placing a Disc

1 Open the disc tray.

Press **▲ OPEN/CLOSE** on the DVD deck to open the disc tray.

- The unit's power comes on automatically.
- Do not block the disc tray with your hand while it is opening or closing as this may result in hardware failure.
- Do not place unplayable discs or any object other than a disc in the disc tray.
- Do not press down strongly on the disc tray or place any heavy objects on it.

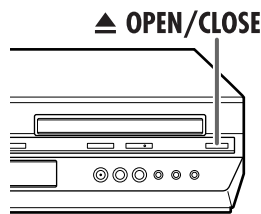

2 Place the disc.

Place the disc in the disc tray with the label side facing up.

- Since disc size changes depending on the disc to be played back, be sure to correctly align the disc with the grooves for its size. If the disc is not in its groove, it may be scratched or otherwise damaged.
- To insert an 8 cm disc, place it according to the inner groove.

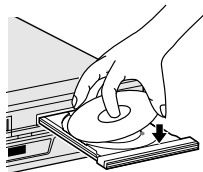

3 Press **▲ OPEN/CLOSE** on the DVD deck to close the disc tray.

- Pressing **▶ PLAY** also closes the disc tray.
- Playback begins automatically if an auto-playback DVD disc is loaded. Although the VHS deck is selected, the DVD deck is selected automatically (except when the VHS deck is in the timer mode or the Automatic Satellite Programme Recording mode.)

Care and Handling of Discs

How to handle discs

When handling a disc, do not touch the surface of the disc. Since discs are made of plastic, they are easily damaged. If a disc gets dirty, dusty, scratched or warped, the images and sound will not be picked up correctly, and such a disc may cause the unit to malfunction.

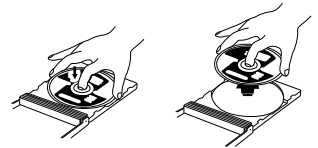

Label side

Do not damage the label side, stick paper to or use any adhesive on its surface.

Storage

Make sure that discs are kept in their cases. If discs are piled on top of one another without their protective cases, they can be damaged. Do not put discs in a location where they may be exposed to direct sunlight, or in a place where the humidity or temperature is high. Avoid leaving discs in your car!

Maintenance of discs

If there are fingerprints or other dirt adhering to a disc, wipe with a soft dry cloth, moving from the center outwards. If a disc is difficult to clean, wipe with a cloth moistened with water. Never use record cleaners, petrol, alcohol or any anti-static agents.



Front View

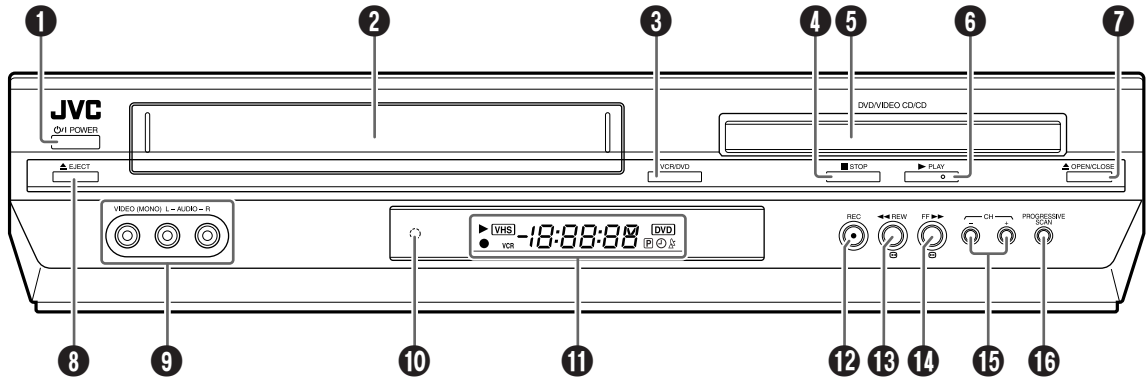

- ❶ Power Button (POWER) ☞ pg. 15, 17, 29, 56
- ❷ VHS Cassette Loading Slot
- ❸ VCR/DVD Button ☞ pg. 26, 31, 40, 50
- ❹ Stop Button (■ STOP) ☞ pg. 26, 31, 40, 50
- ❺ Disc Tray ☞ pg. 8
- ❻ Play Button (▶ PLAY) ☞ pg. 26, 31, 40, 50, 56
- ❼ DVD Open/Close Button (▲ OPEN/CLOSE)
☞ pg. 8, 40, 50
- ❽ VHS Eject Button (▲ EJECT) ☞ pg. 26, 29, 31
- ❾ Video/Audio Input Connectors (VIDEO/AUDIO)
☞ pg. 52
- ❿ Remote Sensor
- ⓫ Front Display Panel ☞ pg. 10
- ⓬ Record Button (● REC) ☞ pg. 31, 32
- ⓭ Rewind Button (◀◀ REW) ☞ pg. 26, 27, 42
- ⓮ Fast Forward Button (FF ▶▶) ☞ pg. 26, 27, 42
- ⓯ Channel Button (CH +/-) ☞ pg. 27, 31, 32
- ⓰ Progressive Scan Button (PROGRESSIVE SCAN)
☞ pg. 15

Rear View

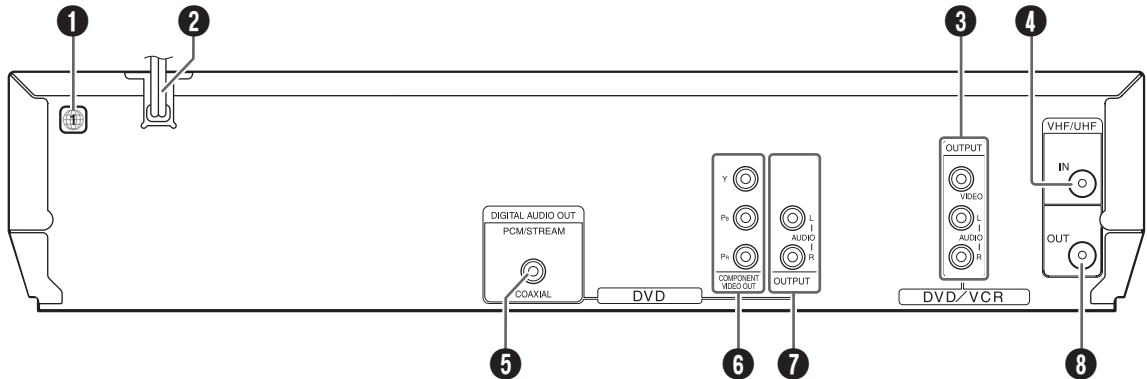

- ❶ Region Number Label ☞ pg. 7
 - ❷ AC Power Cord ☞ pg. 13, 14
 - ❸ Audio/Video Output Connectors (AUDIO/VIDEO OUTPUT) ☞ pg. 13, 14, 53
 - ❹ Antenna Input Connector (VHF/UHF IN) ☞ pg. 13, 14
 - ❺ Digital Audio Output Connector (DIGITAL AUDIO OUT)* ☞ pg. 55
 - ❻ Component Video Output Connectors (COMPONENT VIDEO OUT)* ☞ pg. 14
 - ❼ Audio Output Connectors (AUDIO OUTPUT (L/R))*
 - ❽ Antenna Output Connector (VHF/UHF OUT) ☞ pg. 13, 14
- * These connectors are only for DVD deck.

Front Display Panel

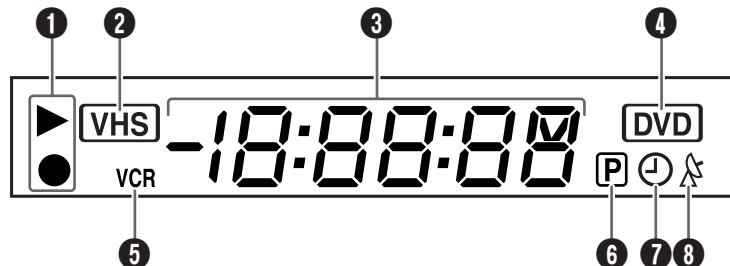

- ❶ Operation Mode Indicators
- ❷ VHS Indicator*
* Lights up when selecting the VCR deck by pressing VCR/DVD on the unit or VCR on the Remote.
- ❸ Channel/Clock
Auxiliary Input Mode Display (F-1) (VCR deck only)
Counter Display (VCR deck)
Tape Speed (SP/EP) (VCR deck only)
Multi-information window** (DVD deck)
**The current group/title/track/chapter number(s), time and status information.
- ❹ DVD Indicator
- ❺ VCR Indicator ☞ pg. 32
- ❻ Progressive Mode Indicator ☞ pg. 15
- ❼ "Timer" Indicator (VCR deck only) ☞ pg. 35, 39
- ❽ Satellite Auto Recording Indicator (⏏) (VCR deck only) ☞ pg. 39

On-Screen Display (VCR deck)

If you press **ON SCREEN** on the Remote when "SUPERIMPOSE" is set to "ON" (☞ pg. 59), various operational indicators appear on the TV screen.

For On-screen display for DVD deck, refer to "Using the on-screen bar" (☞ pg. 47).

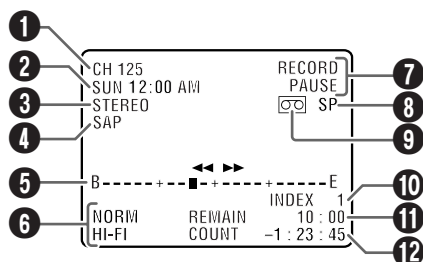

❶ Channel Position Number/Auxiliary Input Indicator (F-1)

❷ Day/Clock Display

❸ Stereo Program Indicator ☞ pg. 33

❹ SAP Indicator ☞ pg. 33

❺ Tape Position Indicator

The tape position indicator appears on the TV screen when you press **REW** (◀◀) or **FF** (▶▶) from the Stop mode or perform an Index Search. (☞ pg. 28) The position of "■" in relation to "B" (beginning) or "E" (end) shows you where you are on the tape.

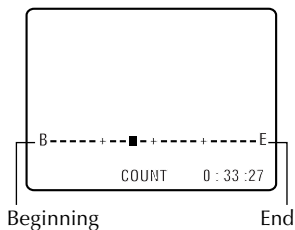

NOTE:

Depending on the type of tape being used, the tape position indicator may not appear correctly.

❻ Audio Mode Display ☞ pg. 30

❼ Operation Mode Indicators

❽ Tape Speed (SP/EP)

❾ "Cassette Loaded" Mark

❿ Index number ☞ pg. 28

⓫ Tape Remaining Time Indicator ☞ pg. 33

⓬ Counter Display

To recall an indication

❶ Press **ON SCREEN**.

- All indications corresponding to the current status are displayed for 5 seconds. After that, the counter information and RECORD/PAUSE if in the Record Pause mode, remain on the screen.

❷ Press **ON SCREEN** again to clear the display.

- The RECORD/PAUSE indication remains on the screen.

Remote

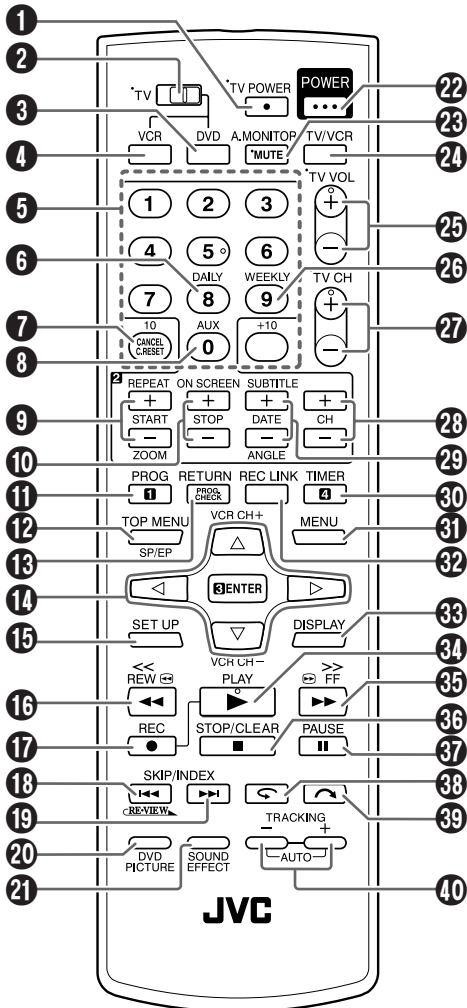

Buttons with a small dot on the left side of the name (TV POWER (●/|), TV/VCR, TV VOL+/-, TV CH +/-, MUTE) can also be used to operate a JVC's TV after setting the TV/VCR/DVD switch to the left.

- 1 TV Power Button (TV POWER) ☞ See above.
- 2 TV/VCR/DVD switch ☞ pg. 15, 17, 18, 26, 31, 40, 50
- 3 DVD Button ☞ pg. 17, 19, 40, 50, 61
- 4 VCR Button ☞ pg. 18, 22, 24, 26, 31, 58
- 5 Number Keys
- 6 Daily Button (DAILY) ☞ pg. 35
- 7 Cancel Button (CANCEL) ☞ pg. 37
Reset Button (C.RESET) ☞ pg. 33
- 8 Auxiliary Button (AUX) ☞ pg. 52
- 9 Start Time Button (START +/-) ☞ pg. 34
Repeat Button (REPEAT) ☞ pg. 43, 51
Zooming Button (ZOOM) ☞ pg. 42, 51
- 10 Stop Time Button (STOP +/-) ☞ pg. 34
On-Screen Button (ON SCREEN) ☞ pg. 11, 47
- 11 Programming Button (PROG) ☞ pg. 34
- 12 SP/EP Button ☞ pg. 31, 35, 39
Top Menu Button (TOP MENU) ☞ pg. 41

- 13 Program Check Button (PROG. CHECK) ☞ pg. 36
Return Button (RETURN) ☞ pg. 41
 - 14 Δ▽ Button
◁▷ Button
ENTER Button
VCR Channel Button (TV/VCR CH +/-)
 - 15 Set Up Button (SET UP) ☞ pg. 17, 18, 19, 20, 22, 24, 58, 61
 - 16 Rewind Button (◀◀ REW) ☞ pg. 26, 27, 42
 - 17 Record Button (● REC) ☞ pg. 31, 32
 - 18 Reverse Skip/Index Button (◀◀ SKIP/INDEX) ☞ pg. 28, 41, 50
Review Button (◀◀ C.REVIEW ▶)
 - 19 Forward Skip/Index Button (▶▶ SKIP/INDEX) ☞ pg. 28, 41, 50
 - 20 DVD Picture Button (DVD PICTURE) ☞ pg. 46
 - 21 Sound Effect Button (SOUND EFFECT) ☞ pg. 46
 - 22 Power Button (POWER) ☞ pg. 15, 17, 29, 56
 - 23 TV Muting Button (MUTE) ☞ See the left column
Audio Monitor Button (A.MONITOR) ☞ pg. 30, 45
 - 24 TV/VCR Button ☞ pg. 32, left column
 - 25 TV Volume Button (TV VOL+/-) ☞ See the left column
 - 26 Weekly Button (WEEKLY) ☞ pg. 35
 - 27 TV Channel Button (TV CH +/-) ☞ See the left column
 - 28 Channel Button (CH +/-) ☞ pg. 31
 - 29 Date Button (DATE +/-) ☞ pg. 34
Subtitle Button (SUBTITLE) ☞ pg. 44
Angle Button (ANGLE) ☞ pg. 45
 - 30 Timer Button (TIMER) ☞ pg. 35
 - 31 Menu Button (MENU) ☞ pg. 41
 - 32 Satellite Auto Recording Button (REC LINK) ☞ pg. 39
 - 33 Display Button (DISPLAY) ☞ pg. 33, 40
 - 34 Play Button (▶ PLAY) ☞ pg. 26, 31, 40, 50
 - 35 Fast Forward Button (FF ▶▶) ☞ pg. 26, 27, 42
 - 36 Stop Button (■ STOP) ☞ pg. 26, 31, 40, 50
Clear Button* (CLEAR)
- *Does not function with this unit.*
- 37 Pause Button (|| PAUSE) ☞ pg. 27, 31, 40, 42, 50
 - 38 One Touch Replay Button (↶) ☞ pg. 29, 42
 - 39 Skip Search Button (↶) ☞ pg. 28
 - 40 Tracking Button (TRACKING +/-) ☞ pg. 30

How To Use

Before use, insert two AA size batteries into the Remote with the polarity (⊕ and ⊖) matched correctly as indicated on the battery compartment or on the lid.

The Remote can operate most of your unit's functions, as well as basic functions of TV sets of JVC. (☞ See the left column)

- Point the Remote toward the remote sensor.
- The maximum operating distance of the remote control is about 8 m.

NOTE:

If the Remote doesn't work properly, remove its batteries, wait a short time, replace the batteries and then try again.

Basic Connections

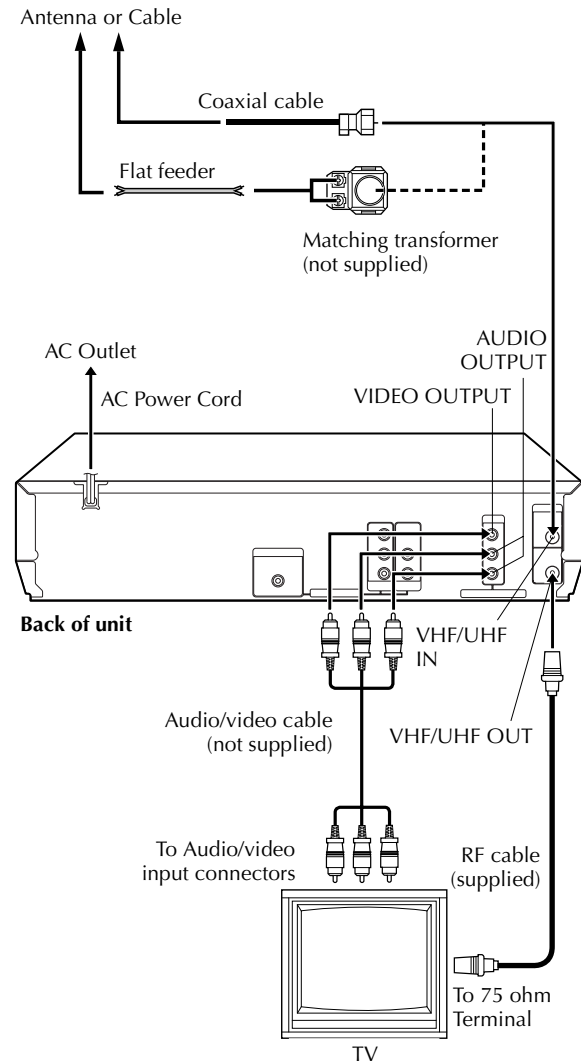

It's essential that your unit be properly connected.

THESE STEPS MUST BE COMPLETED BEFORE ANY VIDEO OPERATION CAN BE PERFORMED.

1 Check the contents.

Make sure the package contains all of the accessories listed in "SPECIFICATIONS" on page 71.

2 Situate the unit.

Place the unit on a stable, horizontal surface.

3 Connect the unit to TV.

The connection method you use depends on the type of TV you have.

RF Connection

- To connect to a TV with NO AV input connectors —

 - 1 Disconnect the TV antenna from the TV.
 - 2 Connect the TV antenna cable to the VHF/UHF IN connector on the rear panel of the unit.
 - 3 Connect the supplied RF cable between the VHF/UHF OUT connector on the rear panel of the unit and the TV's antenna terminal.

AV Connection

- To connect to a TV with AV input connectors —

 - 1 Connect the antenna, unit and TV as per "RF Connection."
 - 2 Connect an optional audio/video cable between the AUDIO/VIDEO OUTPUT connectors on the rear panel of the unit and the TV's audio/video input connectors.

 - Set your TV to AV mode.
 - For switching the TV's mode, refer to the instruction manual of your television.
 - To obtain high-quality pictures, you can also use the Component Video Connection. (DVD deck only) (☞ pg. 14)

4 Connect the unit to power source.

- Plug the end of the AC power cord into an AC outlet. This unit performs Plug & Play Set automatically. (☞ pg. 16)
- The clock and tuner channels will automatically be set when the antenna is connected and when the AC power cord is first connected to an AC outlet. (If "AUTO" and the channel indicator are displayed on the front display panel before the unit is powered on, the clock and tuner channels are being set automatically. Wait for the time to be displayed on the front display panel before turning on the unit.)

5 Set the VCR channel.

- The VCR channel is the channel on which you can watch the picture from the unit on the TV when only using RF connection.
- With RF connection, set the VCR channel to "3 CH" or "4 CH."
- The VCR channel is preset to "3 CH." Set to "4 CH" if the Channel 3 is used for broadcasting in your area.
- With AV connection, set the VCR channel to "- CH" (off). To set the VCR channel, perform the following steps:

Before performing the following steps:

- Make sure there is no cassette inserted in the unit.
- Make sure the unit is turned on, then press **VCR/DVD** on the unit or **VCR** on the Remote so that the VHS indicator lights up on the front display panel.

- 1 Press **POWER** to turn off the unit, then press **STOP** on the unit for more than 5 seconds. "3 CH" appears on the front display panel.
- 2 Press **CH +/-** on the Remote to select "3 CH," "4 CH" or "- CH" (off), then press **ENTER**.

Component Video Connection

(DVD deck only)

ATTENTION

Be sure to connect the unit's VIDEO OUTPUT (DVD/VCR) connector to the TV's VIDEO input connector.

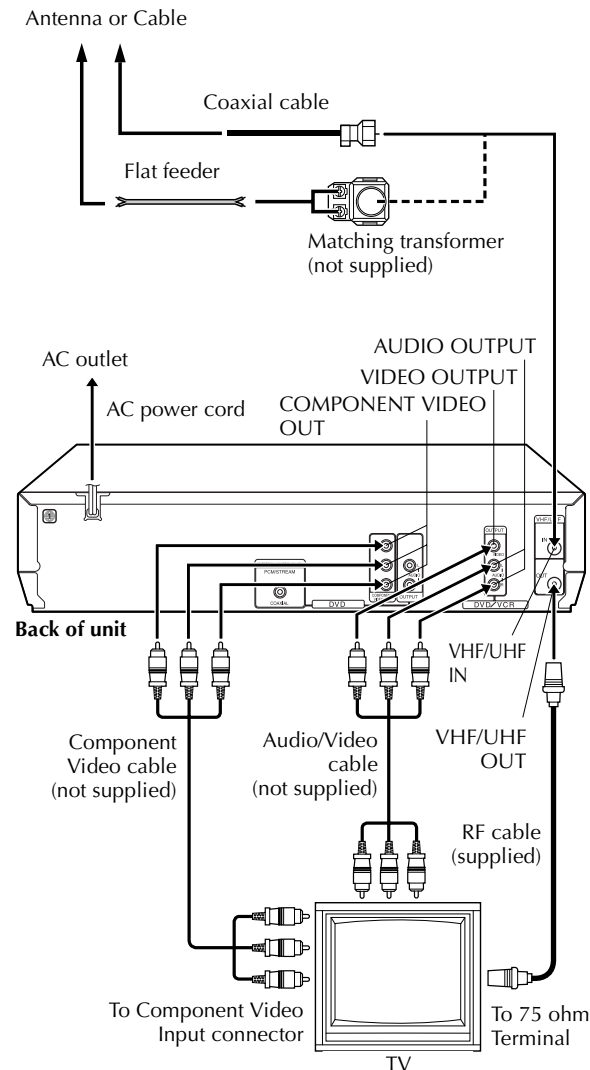

- To connect to a TV with component video input connectors . . .

1 Connect the unit to TV.

- 1 Connect the antenna, unit and TV as per "AV Connection." (☞ pg. 13)
- 2 Connect the unit's COMPONENT VIDEO OUT connectors to the TV's component video input connectors.

2 Connect the unit to power source.

Plug the end of the AC power cord into an AC outlet. This unit performs Plug & Play Set automatically. (☞ pg. 16)

- The clock and tuner channels will automatically be set when the antenna is connected and when the AC power cord is first connected to an AC outlet. (If "AUTO" and the channel indicator are displayed on the front display panel before the unit is powered on, the clock and tuner channels are being set automatically. Wait for the time to be displayed on the front display panel before turning on the unit.)

3 Set the VCR channel to off.

Before performing the following steps:

- Make sure there is no cassette inserted in the unit.
- Make sure the unit is turned on, then press **VCR/ DVD** on the unit or **VCR** on the Remote so that the VHS indicator lights up on the front display panel.

- 1 Press **POWER** to turn off the unit, then press **STOP** on the unit for more than 5 seconds. "3 CH" appears on the front display panel.
- 2 Press **CH +/-** on the Remote to select "- CH" (off), then press **ENTER**.

NOTES:

- You can obtain high-quality component video pictures.
- If your TV is not stereo-capable, use the unit's AUDIO OUTPUT connectors to connect to an audio amplifier for Hi-Fi stereo sound reproduction.
- To operate the unit with your TV using the Component Video connection, set your TV to its AV mode. You can also use the **TV/VCR** button on the unit's Remote to set JVC TV to the AV mode. For switching the TV's mode, refer to the instruction manual of your television.
- By using the component video connection, you can view the images in the progressive mode. For switching to the progressive mode, refer to "Scan Mode Set (DVD deck only)" (☞ pg. 15).

Scan Mode Set

(DVD deck only)

This unit supports the progressive scan system (eg. 480p*) as well as the conventional interlaced scan system (eg. 480i*).

If your TV equipped with component video connectors supports the progressive video input, you can enjoy a high quality picture by setting the progressive scan mode to active.

- Refer also to the instruction manuals supplied with your TV.
- If your TV equipped with component video connectors does not support the progressive video input, do not change the scan mode to the "PROGRESSIVE."

* 480p and 480i indicate the number of scanning lines and scanning format of an image signal.

- 480p indicates 480 scanning lines with progressive format.
- 480i indicates 480 scanning lines with interlaced format.

- Turn on the TV and select the VCR channel (or AV mode).
- Slide the TV/VCR/DVD switch on the Remote to the right.

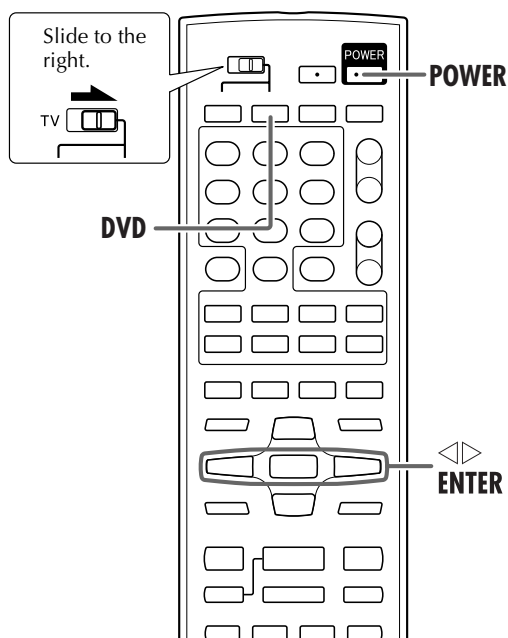
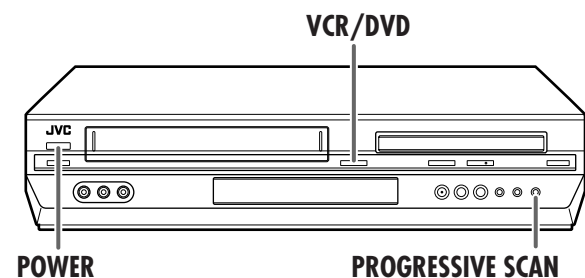

1 Turn on the unit.

Press **POWER**.

2 Select the DVD deck.

On the unit

Press **VCR/DVD** repeatedly so that the DVD indicator lights up on the front display panel.

On the Remote

Press **DVD** so that the DVD indicator lights up on the front display panel.

3 Switch the mode.

- 1 Press and hold **PROGRESSIVE SCAN** on the unit for more than 3 seconds. The current scan mode blinks on the front display panel.
- 2 While the current scan mode blinks, press $\triangleleft \triangleright$ to select "ProGr" (for the progressive scan mode) or "IntEr" (for the interlaced scan mode), then press **ENTER**.
 - If the current scan mode stops blinking before you make the setting, start from step 1 again.

NOTE:

When the progressive scan mode is selected, the Progressive mode indicator (P) lights up on the front display panel.

Plug & Play Set

Auto Clock Set/Auto Tuner Set

ATTENTION

- If you use a cable box, Plug&Play will not function; set the clock and tuner channels separately. (☞ pg. 22 – 24)
- Depending on areas or reception conditions, the unit may not receive the Auto clock setting data from the PBS channel. If this function is taking a considerable amount of time, it may be necessary to perform the Semiauto or Manual Clock Set procedure.

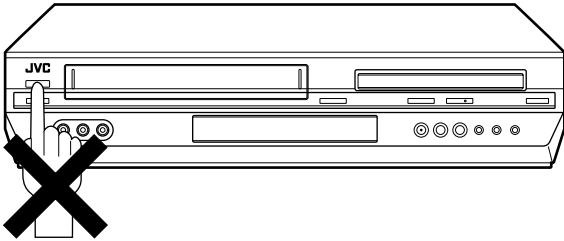

This unit sets the clock and tuner channels automatically when AC power cord is first connected to an AC outlet. The antenna cable must be connected for the Plug & Play setting.

The time and date can be set automatically by the clock setting data transmitted from one of the regular TV broadcast channels. We call this TV channel the “host channel” and it is a PBS channel in your area.

1 Perform Plug & Play setup.

Connect the antenna cable to the unit. (☞ pg. 13) Then connect the AC power cord to an AC outlet. Do not turn on the unit.

The clock and tuner channels will be set automatically.

NOTES:

- Auto Clock Set is performed first. “AUTO” blinks on the front display panel during Auto Clock Set.
- Auto Channel Set is performed next. Auto Channel Set scans all the channels that are receivable by your unit. During Auto Channel Set, the channel numbers are displayed as they are scanned and set.
- When Plug & Play setting has been complete successfully, the correct clock time is displayed. If you perform Plug & Play setting successfully, there is no need to perform “Clock Set” (☞ pg. 22) and “Tuner Set” (☞ pg. 24). If, however, you want to add or delete channels, refer to “Manual Channel Set” (☞ pg. 25).



During Initial Auto Clock Set
“AUTO” blinks.



During Auto Channel Set
The channel numbers are displayed as they are scanned and set.



Plug&Play Completed
The current time is displayed.

* If an incorrect clock time or “--:--” appears on the front display panel, see “What to do if Plug & Play setting failed” below.

INFORMATION

- If “AUTO CLOCK” is set to “ON” (☞ pg. 23), the clock will be adjusted automatically by the host channel every hour (except 11:00 PM, midnight, 1:00 AM and 2:00 AM) using the incoming PBS channel clock setting data. (This automatic clock adjustment can only be performed when the unit is turned off. The clock will be adjusted just on these hours — on the time displayed on the front display panel, not on the actual real time.) The default setting of “AUTO CLOCK” is “ON”. (☞ pg. 23)
- If the memory backup fails, because a power outage occurs or because the AC power cord is unplugged, Plug & Play will be performed when power is restored to the unit.

What to do if Plug & Play setting failed

- If an incorrect time is displayed on the front display panel, you may be receiving the clock setting data of a PBS channel from an adjacent time zone, or an incorrect PBS channel from a cable TV system. In this case, perform “Semiauto Clock Set” (☞ pg. 23) or “Manual Clock Set” (☞ pg. 23).
- If “--:--” appears on the front display panel, your antenna cable may not be connected to the unit or there may not be a Host PBS signal available in your area. Ensure that the antenna cable is connected correctly. Then turn on and off the unit; the Plug & Play setting will be automatically reactivated. If Plug & Play setting is not performed though the antenna cable is connected correctly, perform “Manual Clock Set” (☞ pg. 23) and “Auto Channel Set” (☞ pg. 24) or “Manual Channel Set” (☞ pg. 25).

Monitor Set

(DVD deck)

You can select the monitor type depending the TV used when you play back DVD VIDEO discs recorded for wide-screen TVs.

- Turn on the TV and select the VCR channel (or AV mode).
- Slide the TV/VCR/DVD switch on the Remote to the right.

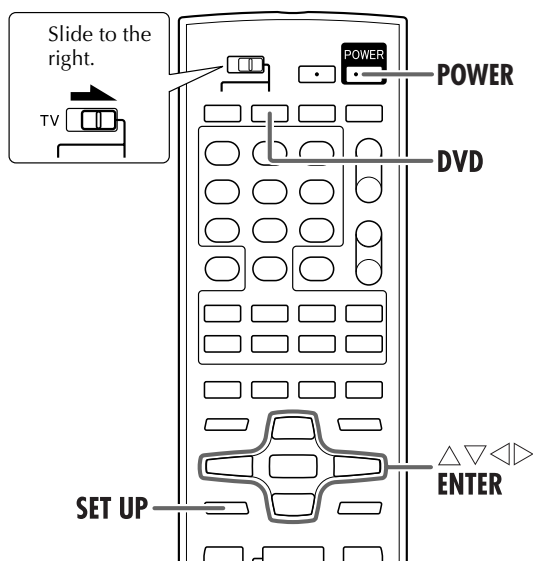

4 Select the mode.

Press \triangle / ∇ to move the highlight to "MONITOR TYPE," then press **ENTER**.

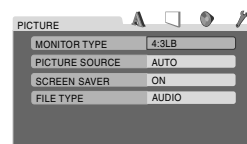

5 Select the mode setting.

Press \triangle / ∇ to select the desired setting, then press **ENTER**.

6 Return to the normal screen.

Press **SET UP**.

* The default setting is **bold** in the table below.

MONITOR TYPE

16:9 (Wide television conversion):

Select this when the aspect ratio of your TV is fixed to 16:9 (wide TV). The unit automatically adjusts the screen width of the output signal correctly when playing back a picture whose aspect ratio is 4:3.

4:3 LB (Letter Box conversion):

Select this when the aspect ratio of your TV is 4:3 (conventional TV). While viewing a wide screen picture, the black bars appear on the top and the bottom of the screen.

4:3 PS (Pan&Scan):

Select this when the aspect ratio of your TV is 4:3 (conventional TV). While viewing a wide screen picture, the black bars do not appear; however, the left and right edges of the pictures will not be shown on the screen.

Pan&Scan/Letter Box

In general, DVD VIDEO disc are produced for a wide-screen TV with 16:9 aspect ratio.

Material with this ratio will not fit to a TV with 4:3 aspect ratio. There are two styles to display the image, "Pan&Scan" (PS) and "Letter Box" (LB).

Pan&Scan

The right and left side of the image are cut off. The image fills the screen.



Letter Box

Black bands appear at the top and bottom of the image. The image itself appears in 16:9 aspect ratio.



1 Turn on the unit.

Press **POWER**.

2 Select the DVD deck.

On the unit

Press **VCR/DVD** repeatedly so that the DVD indicator lights up on the front display panel.

On the Remote

Press **DVD** so that the DVD indicator lights up on the front display panel.

3 Access the DVD Set Up menu screen.

- 1 Press **SET UP**.
- 2 Press \triangleleft / \triangleright to select "PICTURE."

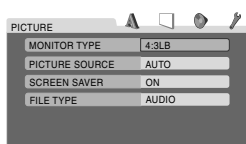

Language

- Turn on the TV and select the VCR channel (or AV mode).
- Slide the **TV/VCR/DVD** switch on the Remote to the right.

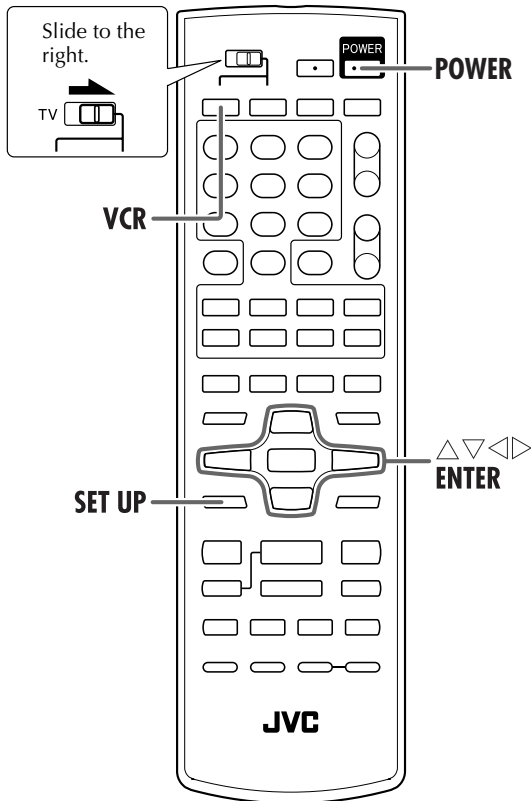

On-screen Language Set (VCR deck)

This VCR deck offers you the choice to view on-screen messages in 3 different languages.

1 Turn on the unit.

Press **POWER**.

2 Select the VCR deck.

On the unit

Press **VCR/DVD** repeatedly so that the VHS indicator lights up on the front display panel.

On the Remote

Press **VCR** so that the VHS indicator lights up on the front display panel.

3 Access the Main Menu screen.

Press **SET UP**.

4 Access the Initial Set screen.

Press \triangle ∇ to move the highlight bar (arrow) to "INITIAL SET," then press **ENTER** or \triangleright .

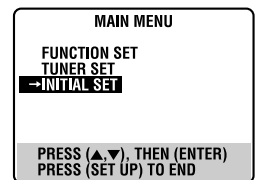

5 Select the language.

Press \triangle ∇ to move the highlight bar (arrow) to "LANGUAGE," then press **ENTER** or \triangleright repeatedly until the desired language is selected.

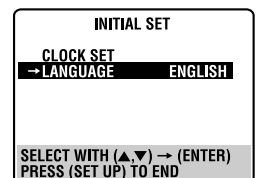

6 Return to the normal screen.

Press **SET UP**.

- Turn on the TV and select the VCR channel (or AV mode).
- Slide the **TV/VCR/DVD** switch on the Remote to the right.

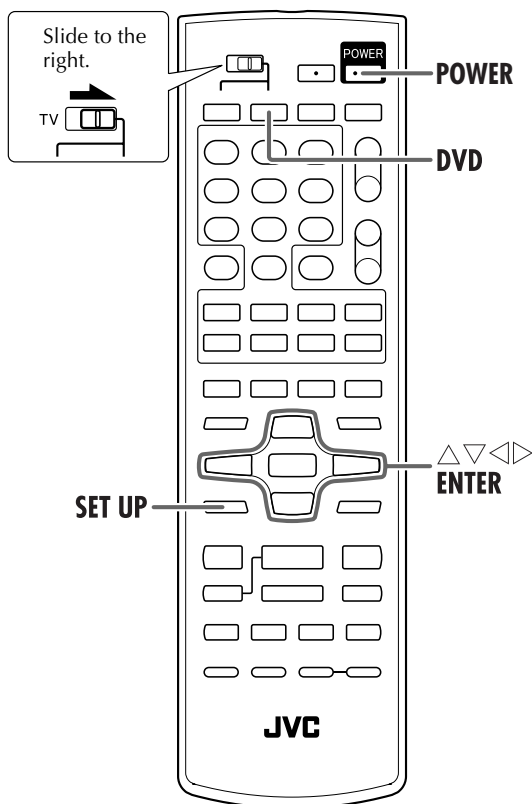

On-screen Language Set (DVD deck)

This DVD deck offers you the choice to view on-screen messages in 3 different languages. You can change the language setting manually as required.

1 Turn on the unit.

Press **POWER**.

2 Select the DVD deck.

On the unit

Press **VCR/DVD** repeatedly so that the DVD indicator lights up on the front display panel.

On the Remote

Press **DVD** so that the DVD indicator lights up on the front display panel.

3 Access the DVD Set Up menu screen.

- 1 Press **SET UP**.
- 2 Press **◀ ▶** to select "▲ LANGUAGE."

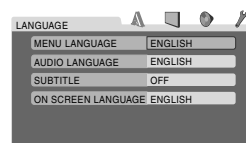

4 Select the mode.

Press **△▽** to move the highlight to "ON SCREEN LANGUAGE," then press **ENTER**.

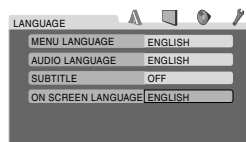

5 Select the mode setting.

Press **△▽** to select the desired setting, then press **ENTER**.

6 Return to the normal screen.

Press **SET UP**.

- Turn on the TV and select the VCR channel (or AV mode).
- Slide the **TV/VCR/DVD** switch on the Remote to the right.

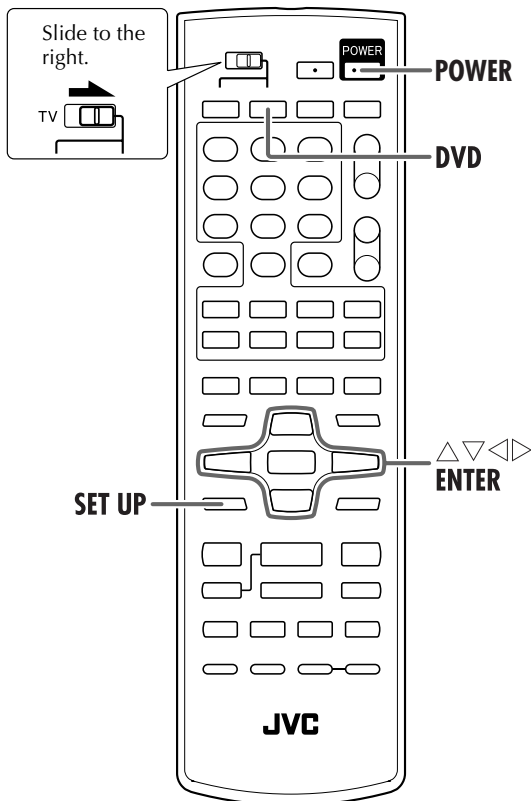

Menu/Audio/Subtitle Language Set (DVD deck only)

Some DVD discs contain the DVD menu display, audio, subtitle in the multiple languages. With these discs, you can set the default language as you like.

- The procedure shows how to set "MENU LANGUAGE" on the DVD Set Up menu screen as an example.

1 Turn on the unit.

Press **POWER**.

2 Select the DVD deck.

On the unit

Press **VCR/DVD** repeatedly so that the DVD indicator lights up on the front display panel.

On the Remote

Press **DVD** so that the DVD indicator lights up on the front display panel.

3 Access the DVD Set Up menu screen.

- 1 Press **SET UP**.
- 2 Press **◀ ▶** to select "▲ LANGUAGE."

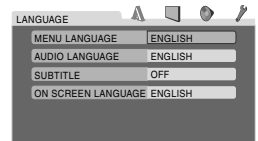

4 Select the mode.

Press **▲▼** to move the highlight to "MENU LANGUAGE," then press **ENTER**.

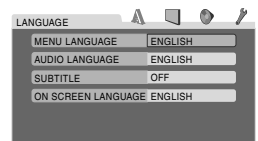

5 Select the mode setting.

Press **▲▼** to select the desired setting, then press **ENTER**.

- See "Language Code List" (pg. 21).

6 Return to the normal screen.

Press **SET UP**.

NOTE:

When the selected language is not available on the disc, the disc's default menu language is played back.

Language Code List

AA	Afar	IK	Inupiak	RN	Kirundi
AB	Abkhazian	IN	Indonesian	RO	Rumanian
AF	Afrikaans	IS	Icelandic	RU	Russian
AM	Ameharic	IW	Hebrew	RW	Kinyarwanda
AR	Arabic	JI	Yiddish	SA	Sanskrit
AS	Assamese	JW	Javanese	SD	Sindhi
AY	Aymara	KA	Georgian	SG	Sangho
AZ	Azerbaijani	KK	Kazakh	SH	Serbo-Croatian
BA	Bashkir	KL	Greenlandic	SI	Singhalese
BE	Byelorussian	KM	Cambodian	SK	Slovak
BG	Bulgarian	KN	Kannada	SL	Slovenian
BH	Bihari	KO	Korean (KOR)	SM	Samoaian
BI	Bislama	KS	Kashmiri	SN	Shona
BN	Bengali, Bangla	KU	Kurdish	SO	Somali
BO	Tibetan	KY	Kirghiz	SQ	Albanian
BR	Breton	LA	Latin	SR	Serbian
CA	Catalan	LN	Lingala	SS	Siswati
CO	Corsican	LO	Laothian	ST	Sesotho
CS	Czech	LT	Lithuanian	SU	Sundanese
CY	Welsh	LV	Latvian, Lettish	SV	Swedish
DA	Danish	MG	Malagasy	SW	Swahili
DZ	Bhutani	MI	Maori	TA	Tamil
EL	Greek	MK	Macedonian	TE	Telugu
EO	Esperanto	ML	Malayalam	TG	Tajik
ET	Estonian	MN	Mongolian	TH	Thai
EU	Basque	MO	Moldavian	TI	Tigrinya
FA	Persian	MR	Marathi	TK	Turkmen
FI	Finnish	MS	Malay (MAY)	TL	Tagalog
FJ	Fiji	MT	Maltese	TN	Setswana
FO	Faroese	MY	Burmese	TO	Tonga
FY	Frisian	NA	Nauru	TR	Turkish
GA	Irish	NE	Nepali	TS	Tsonga
GD	Scots Gaelic	NL	Dutch	TT	Tatar
GL	Galician	NO	Norwegian	TW	Twi
GN	Guarani	OC	Occitan	UK	Ukrainian
GU	Gujarati	OM	(Afan) Oromo	UR	Urdu
HA	Hausa	OR	Oriya	UZ	Uzbek
HI	Hindi	PA	Panjabi	VI	Vietnamese
HR	Croatian	PL	Polish	VO	Volapuk
HU	Hungarian	PS	Pashto, Pushto	WO	Wolof
HY	Armenian	PT	Portuguese	XH	Xhosa
IA	Interlingua	QU	Quechua	YO	Yoruba
IE	Interlingue	RM	Rhaeto-Romance	ZU	Zulu

Clock Set

- Turn on the TV and select the VCR channel (or AV mode).
- Slide the TV/VCR/DVD switch on the Remote to the right.

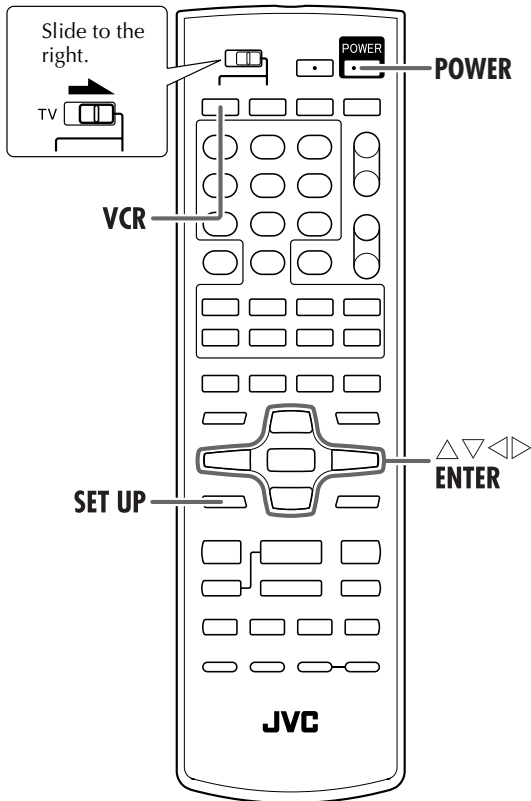

Perform clock setting only if the clock has not been set correctly by the Plug&Play setting.

Preparations

1 Turn on the unit.

Press **POWER**.

2 Select the VCR deck.

On the unit

Press **VCR/DVD** repeatedly so that the VHS indicator lights up on the front display panel.

On the Remote

Press **VCR** so that the VHS indicator lights up on the front display panel.

3 Access the Main Menu screen.

Press **SET UP**.

4 Access the Initial Set screen.

Press $\Delta \nabla$ to move the highlight bar (arrow) to "INITIAL SET," then press **ENTER** or \triangleright .

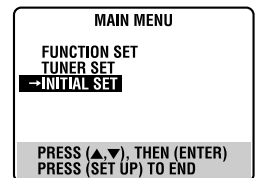

5 Access the Clock Set screen.

Press $\Delta \nabla$ to move the highlight bar (arrow) to "CLOCK SET," then press **ENTER** or \triangleright .

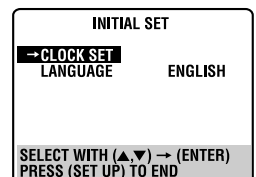

Semiauto Clock Set

You can change the host channel/D.S.T. (Daylight Saving Time)/time zone setting manually. First follow steps **1** to **5** in "Preparations" (☞ pg. 22), then go to the following steps.

NOTE:

The time set previously will be erased when "AUTO CLOCK," "HOST CH," "D.S.T." or "TIME ZONE" setting is changed.

1 Set "AUTO CLOCK" to "ON".

Press **ENTER** or **▷** repeatedly to move the highlight bar to "AUTO CLOCK," then press **△▽** so that "ON" is selected.

```

CLOCK SET
TIME  DATE  YEAR
--:--AM 1/1  05
AUTO CLOCK: ON
HOST CH  : AUTO (CATV)
D.S.T.   : AUTO
TIME ZONE : AUTO
PRESS (▲▼), THEN (ENTER)
PRESS (SET UP) TO END
  
```

2 Select the host channel.

You can either select "AUTO" or enter a PBS channel number.

Press **ENTER** or **▷** to move the highlight bar to "HOST CH," then press **△▽** repeatedly until "AUTO" or the desired PBS channel number is selected.

NOTE:

Some PBS channels do not transmit clock setting data.

3 Select the D.S.T. mode.

Press **ENTER** or **▷** to move the highlight bar to "D.S.T.," then press **△▽** repeatedly until the desired setting is selected.

AUTO: Select if you want to adjust your VCR's clock automatically by the incoming signal from the host channel. Be sure to select the correct time zone manually in step **4**.

ON: Adjustment will be made by the built-in clock itself.

OFF: Select when Daylight Saving Time does not apply to you.

4 Select the time zone.

Press **ENTER** or **▷** to move the highlight bar to "TIME ZONE," then press **△▽** repeatedly until "AUTO" or the desired time zone is selected. Each time you press the button, the time zone changes as follows:

↔AUTO↔ATLANTIC↔EASTERN↔CENTRAL↔
MOUNTAIN↔PACIFIC↔ALASKA↔HAWAII↔
(back to the beginning)

NOTE:

If an incorrect time is displayed by the Plug & Play function, you may be receiving the clock setting data of a PBS channel from an adjacent time zone or from an incorrect PBS channel from a cable TV system. If you selected "AUTO" for the host channel in step **2**, be sure to select the correct time zone manually.

5 Complete the Semiauto Clock Set.

Press **SET UP** to return to normal screen.

IMPORTANT

Turn off the unit after performing Semiauto Clock. "AUTO" will appear on the front display panel while the clock is being set. The current clock time will appear automatically when the clock setting is complete.

AUTO DAYLIGHT SAVING TIME

This function enables automatic adjustment of the unit's clock at the start and end of Daylight Saving Time.

With Auto DST activated, —

- on the first Sunday of April at 2:00 AM, the clock is adjusted to 3:00 AM.
- on the last Sunday of October at 2:00 AM, the clock is adjusted to 1:00 AM.

Manual Clock Set

First follow steps **1** to **5** in "Preparations" (☞ pg. 22), then go to the following steps.

1 Set time, date and year.

Press **△▽** until the desired time appears, then press **ENTER** or **▷**. Set the date and year in the same way.

- Holding **△▽** changes the time in 30-minute intervals, or changes the date in 15-day intervals.

```

CLOCK SET
TIME  DATE  YEAR
--:--AM 1/1  05
AUTO CLOCK: ON
HOST CH  : AUTO (CATV)
D.S.T.   : AUTO
TIME ZONE : AUTO
PRESS (▲▼), THEN (ENTER)
PRESS (SET UP) TO END
  
```

2 Select D.S.T. mode.

Press **ENTER** or **▷** to move the highlight bar to "D.S.T.," then press **△▽** to select the desired setting.

ON: Adjustment will be made by the built-in clock itself.

OFF: Select when Daylight Saving Time does not apply to you.

```

CLOCK SET
TIME  DATE  YEAR
1:00AM 12/24 05 FRI
AUTO CLOCK: OFF
D.S.T. : ON
PRESS (▲▼), THEN (ENTER)
PRESS (SET UP) TO END
  
```

3 Start clock.

Press **SET UP** and normal screen appears.

To make corrections any time during the process

Press **ENTER** or **▷** repeatedly until the item you want to change blinks, then press **△▽**.

- Turn on the TV and select the VCR channel (or AV mode).
- Slide the **TV/VCR/DVD** switch on the Remote to the right.

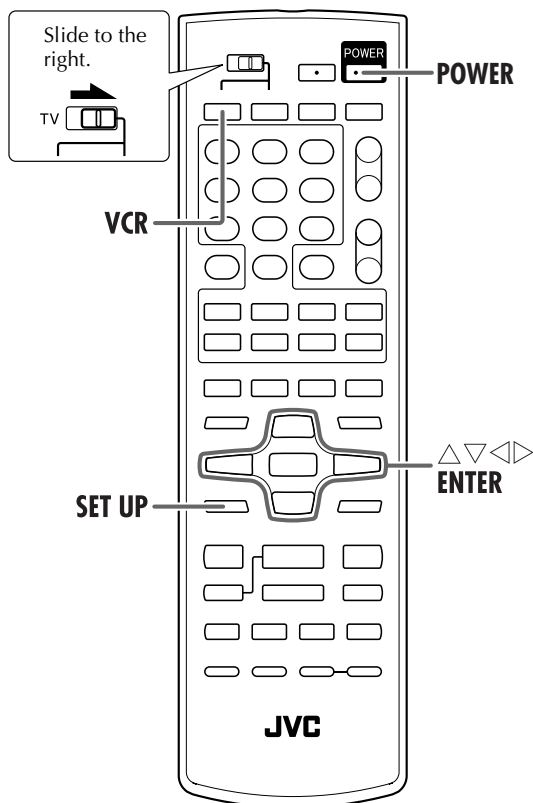

Manual Channel Set

You can add the channels you want or delete the channels you do not want manually.

1 Turn on the unit.

Press **POWER**.

2 Select the VCR deck.

On the unit

Press **VCR/DVD** repeatedly so that the VHS indicator lights up on the front display panel.

On the Remote

Press **VCR** so that the VHS indicator lights up on the front display panel.

3 Access the Main Menu screen.

Press **SET UP**.

4 Access the Tuner Set screen.

Press \triangle / ∇ to move the highlight bar (arrow) to "TUNER SET," then press **ENTER** or \triangleright .

5 Access the Manual Channel Set screen.

Press \triangle / ∇ to move the highlight bar (arrow) to "MANUAL CHANNEL SET," then press **ENTER** or \triangleright .

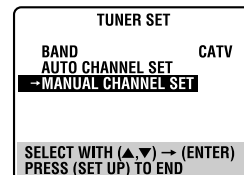

6 Add or skip the desired channels.

To add channels

- 1 Press the **number keys** to input a channel number you want to add.
- 2 Press **ENTER** or \triangleright to set to "ADD."
- 3 Repeat **1** to **2** to add other channels.

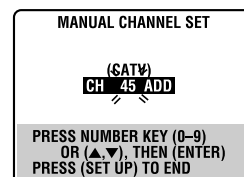

To skip channels

- 1 Press \triangle / ∇ or the **number keys** to select a channel number you want to skip.
- 2 Press **ENTER** or \triangleright to set to "SKIP."
- 3 Repeat **1** and **2** to skip other channels.

7 Return to the normal screen.

Press **SET UP**.

Basic Playback

- Turn on the TV and select the VCR channel (or AV mode).
- Slide the TV/VCR/DVD switch on the Remote to the right.

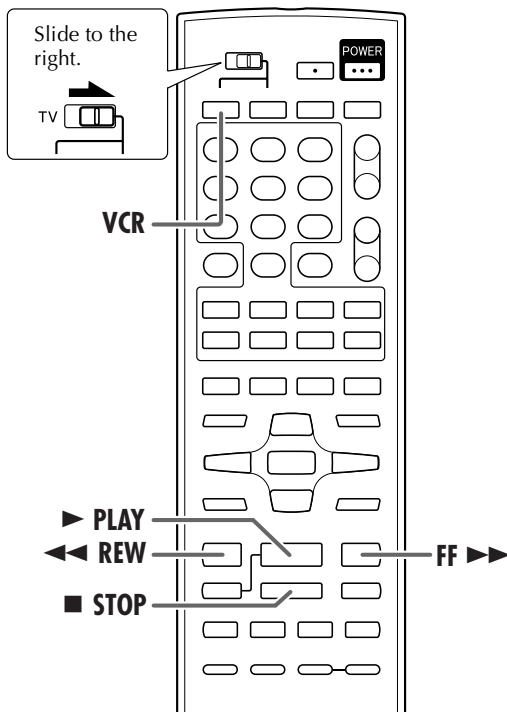
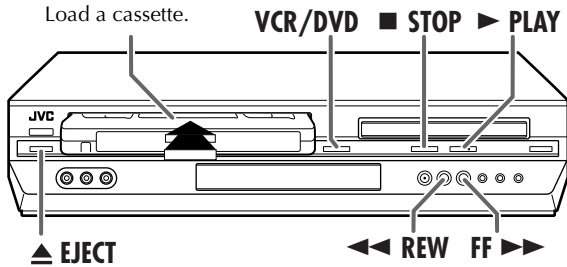

Clean the video heads using a dry cleaning cassette — ECL-3F — when:

- Rough, poor picture appears while a tape is played back.
- The picture is unclear or no picture appears.
- "USE CLEANING CASSETTE" appears on the screen (only with "SUPERIMPOSE" set to "ON"). (pg. 59)

NOTE:

- The heads get dirty in the following cases:
- in an environment prone to extreme temperature or humidity
 - in a dusty environment
 - flaw, dirt or mold on video tapes
 - continuous usage for a long time

1 Load a cassette.

Make sure the window side is up, the rear label side is facing you and the arrow on the front of the cassette is pointed toward the unit.

- Do not apply too much pressure when inserting.
- If the record safety tab has been removed, playback begins automatically. Although the DVD deck is selected, the VCR deck is selected automatically.
- The unit's power comes on automatically and the counter is reset to 0:00:00.

2 Select the VCR deck.

On the unit

Press **VCR/DVD** repeatedly so that the VHS indicator lights up on the front display panel.

On the Remote

Press **VCR** so that the VHS indicator lights up on the front display panel.

3 Find the program start point.

If the tape is advanced past the start point, press **REW**. To go forward, press **FF**.

4 Start playback.

Press **PLAY**.

5 Stop playback.

Press **STOP**. Then press **EJECT** on the VCR deck to remove the cassette.

Usable cassettes

Full-Size VHS

T-30 (ST-30**)
T-60 (ST-60**)
T90
T-120 (ST-120**)
T-160 (ST-160**)
ST-210**

Compact VHS*

TC-20 (ST-C20**)
TC-30 (ST-C30**)
TC-40 (ST-C40**)

* Compact VHS camcorder recordings can be played on this unit. Simply place the recorded cassette into a VHS Cassette Adapter and it can be used just like any full-sized VHS cassette.

** This unit can record on regular VHS and Super VHS cassettes. However, it will record regular VHS signals only.

- S-VHS recording is not possible with this unit.
- This unit is equipped with SQPB (S-VHS QUASI PLAYBACK) that lets you watch tapes recorded in the S-VHS format with regular VHS resolution.
- SQPB does not deliver Super VHS resolution.

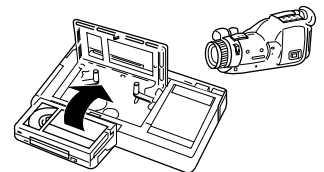

Playback Features

- Turn on the TV and select the VCR channel (or AV mode).
- Slide the TV/VCR/DVD switch on the Remote to the right.

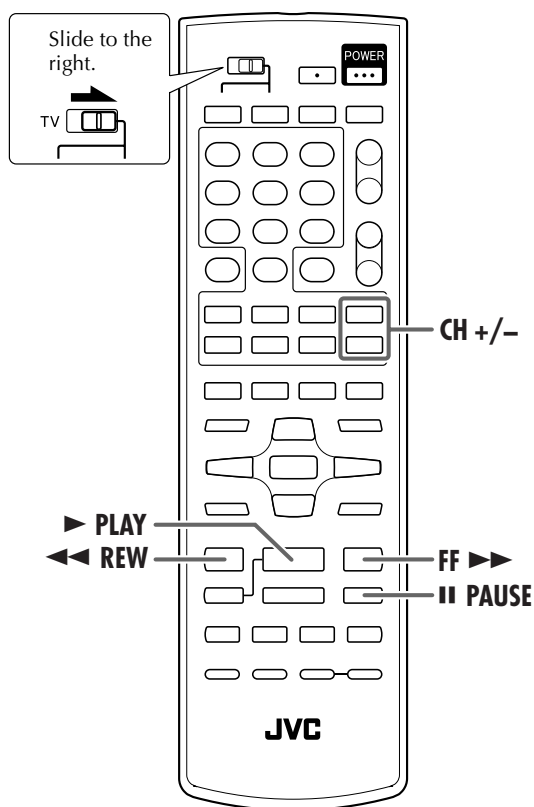
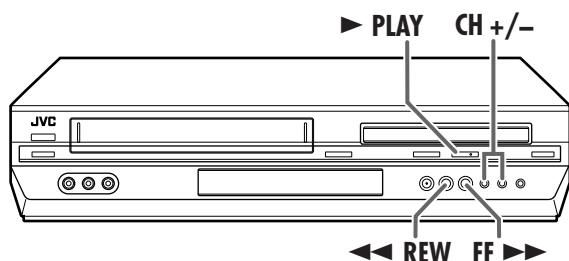

ATTENTION

In the search, still, slow-motion or frame-by-frame playback mode,

- the picture will be distorted.
- the noise bars will appear.
- there may be a loss of color.
- you cannot hear the sound.

Still Picture/Frame-By-Frame Playback

1 Pause during playback.

Press **II PAUSE**.

- If there is vertical jitter, press **CH +/-** on the Remote or on the unit to correct the picture.

2 Activate frame-by-frame playback.

Press **II PAUSE** to advance a still picture.

Slow Motion

1 Pause during playback.

Press **II PAUSE**.

2 Activate slow motion playback.

Press and hold **II PAUSE** for 2 seconds, then release.

Press **II PAUSE** and release again to return to still picture.

NOTE:

During slow motion playback, some noise may appear on the TV screen. Press **CH +** or **-** on the Remote or on the unit to eliminate the noises.

Variable Speed Search

During playback, press **FF ►►** for forward variable speed search, or **◄◄ REW** for reverse variable speed search.

- The speed changes for each direction by pressing **◄◄ REW** and **FF ►►** repeatedly.

When pressing **FF ►►**:

(SP): +5x ↔ +7x

(EP): +11x ↔ +21x

When pressing **◄◄ REW**:

Once **◄◄ REW** is pressed, reverse search starts in -1x normal playback speed. After this process, each press of **◄◄ REW** changes the search speed between -5x and -7x in SP mode, -11x and -21x in EP mode.

(SP): -1x ↔ -5x ↔ -7x

(EP): -1x ↔ -11x ↔ -21x

To resume normal playback, press **► PLAY**.

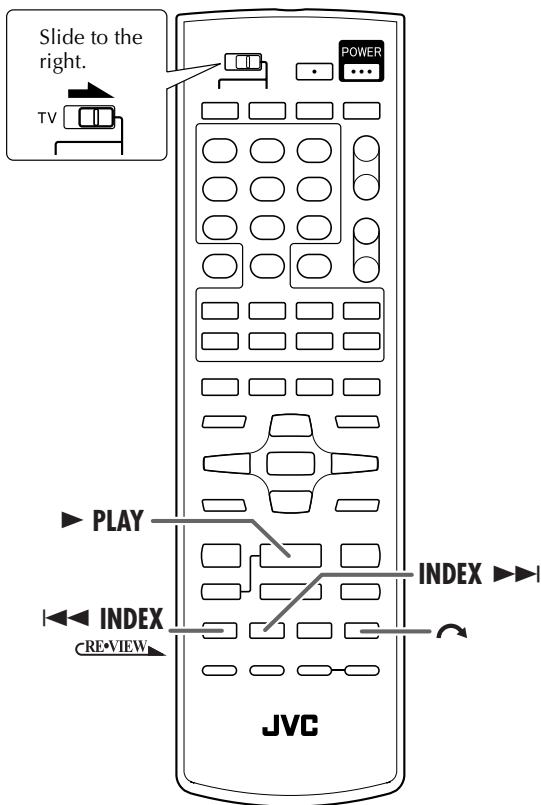

Index Search

Your unit automatically marks index codes at the beginning of each recording. This function gives you quick access to any one of 9 index codes in either direction.

NOTE:

Before starting, make sure the unit is in the Stop mode.

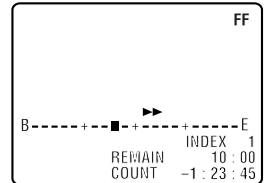

Activate Index Search.

Press **INDEX** or **INDEX**. "INDEX -1" or "INDEX 1" is displayed on the TV screen and search begins in the corresponding direction.

- To access index codes 2 through 9, press **INDEX** or **INDEX** repeatedly until the correct index number is displayed.

Example:

To locate the beginning of B from the current position, press **INDEX** twice.

To locate the beginning of D from the current position, press **INDEX** once.

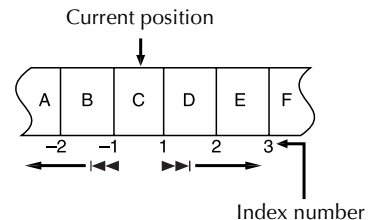

- When the specified index code is located, playback begins automatically.

Instant ReView

Simply by pressing a single button, the unit power comes on, rewinds, and begins playback of the last timer-recorded program. If you have several programs recorded, you can easily access any of them.

NOTE:

Before starting, make sure that the unit is off and that the Timer mode is disengaged.

Activate Instant ReView.

Press **REVIEW**. The unit power comes on and the unit searches for the index code indicating the start of the last timer-recorded program. Once it's found, playback begins automatically.

- To watch the first of the 3 programs, press **REVIEW** three times. The unit searches and begins playback automatically. You can access a program as far as 9 index codes away from the current tape position.

Skip Search

During playback, press **SKIP** 1 to 6 times to skip over unwanted sections.

Each press initiates a 30-second period of fast-motion playback. Normal playback resumes automatically.

To resume normal playback during a Skip Search, press **PLAY**.

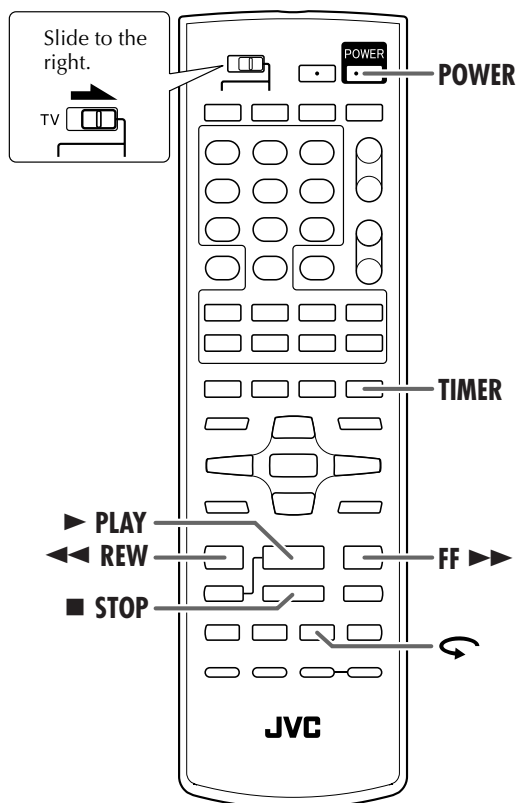
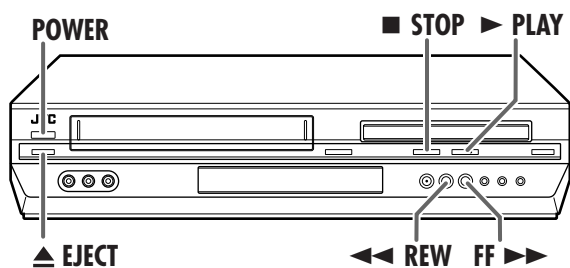

Next Function Memory

The Next Function Memory "tells" the unit what to do after rewinding. Before continuing, make sure the unit is in the Stop mode.

- a- For Automatic Start Of Playback
Press ◀◀ REW, then press ▶ PLAY within 2 seconds.
- b- For Automatic Power Off
Press ◀◀ REW, then press POWER within 2 seconds.
- c- For Automatic Timer Standby
Press ◀◀ REW, then press TIMER within 2 seconds.
- d- For Automatic Cassette Ejection After Tape Rewind
Press ◀◀ REW, then press ▲ EJECT within 2 seconds.

Repeat Playback

Your unit can automatically play back the whole tape 100 times repeatedly.

1 Start playback.

Press ▶ PLAY.

2 Activate Repeat Playback.

Press ▶ PLAY and hold for over 5 seconds, then release.

- The Play indicator (▷) on the front display panel blinks slowly.
- After playing back a tape 100 times, the unit stops automatically.

3 Stop Repeat Playback.

Press ■ STOP at any time.

- Pressing ▶ PLAY, ◀◀ REW, FF ▶▶ or || PAUSE also stops Repeat Playback.

One Touch Replay

Press ↶ during playback.

Pressing ↶ once moves the playback position back to about 7 seconds before the current position. You can press ↶ up to 4 times each One Touch Replay.

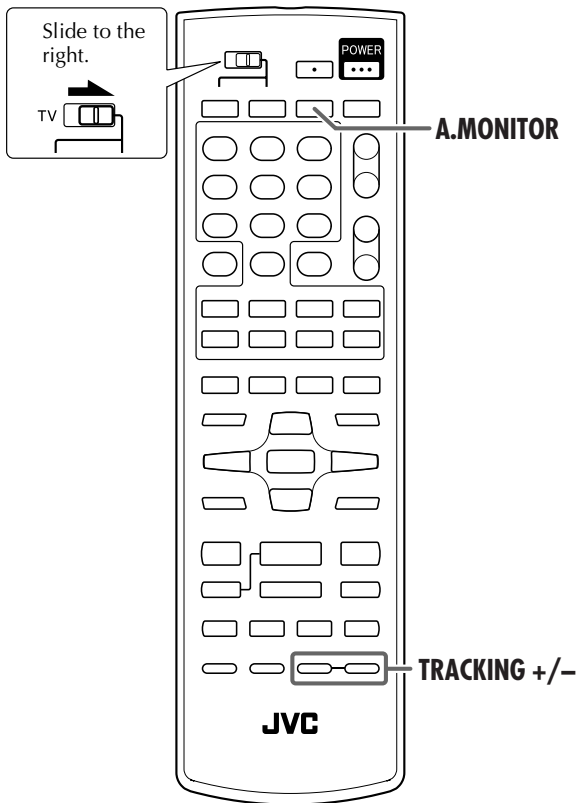

Manual Tracking

Your unit is equipped with automatic tracking control. During playback, you can override this and adjust the tracking manually by pressing the **TRACKING +/-** buttons.

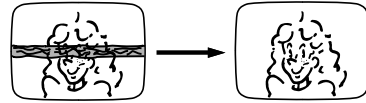

1 Override automatic tracking.

During playback, press **TRACKING +** and **-** at the same time.

2 Adjust the tracking manually.

Press **TRACKING +** or **-** to adjust picture.

- Press **TRACKING +** and **-** at the same time again to return to automatic tracking.

NOTE:

When a new tape is inserted, the unit enters the automatic tracking mode automatically.

Soundtrack Selection

Your unit is capable of recording three soundtracks (HI-FI L, HI-FI R and NORM) and will play back the one you select.

During Playback

Pressing **A.MONITOR** changes the soundtrack as follows:

- You can also select the soundtrack on the Function Set screen. (☞ pg. 60)

TRACK	USE
On-Screen Display	
HI-FI	Hi-Fi sound is played back
HI-FI L	Sound on the left Hi-Fi channel is played back
HI-FI R	Sound on the right Hi-Fi channel is played back
NORM	Sound on the normal track is played back
NORM HI-FI	Both sounds on the Hi-Fi track and normal track are mixed and played back

NOTES:

- "HIFI" should normally be selected. In this mode, Hi-Fi stereo tapes are played back in stereo, and the normal audio track is played back automatically for tapes with only normal audio.
- "SUPERIMPOSE" must be set to "ON" or the on-screen displays will not appear. (☞ pg. 59)

Basic Recording

- Turn on the TV and select the VCR channel (or AV mode).
- Slide the TV/VCR/DVD switch on the Remote to the right.

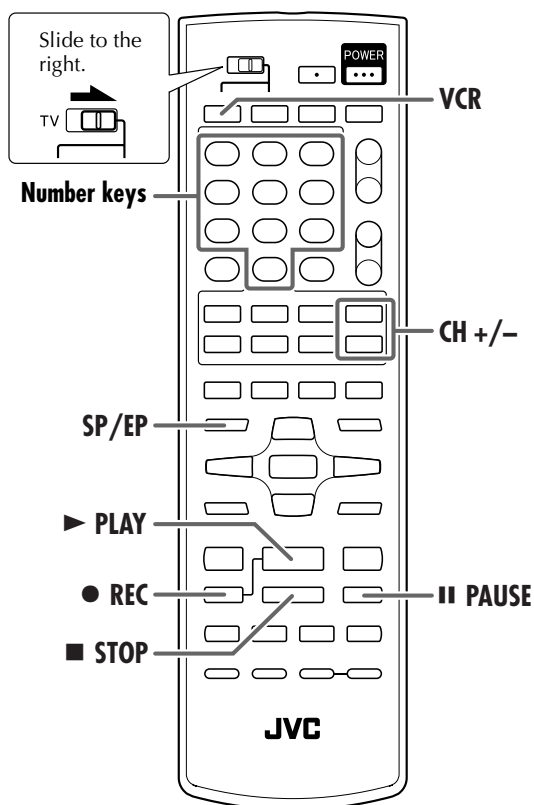
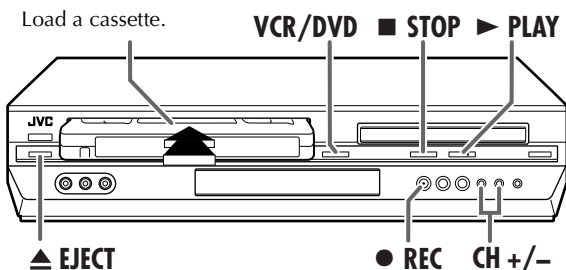

1 Load a cassette.

Insert a cassette with the record safety tab intact.

- The unit's power comes on automatically and the counter is reset to 0:00:00.

2 Select the VCR deck.

On the unit

Press **VCR/DVD** repeatedly so that the VHS indicator lights up on the front display panel.

On the Remote

Press **VCR** so that the VHS indicator lights up on the front display panel.

3 Choose a program.

Press **CH +/-** or the **number keys** to select the channel you wish to record.

4 Set the tape speed.

Press **SP/EP**. The current setting appears on the front display panel or TV screen. Press **SP/EP** again to change the setting while the tape speed is displayed on the TV screen.

5 Start recording.

Press and hold ● **REC** and press ► **PLAY** on the Remote, or press ● **REC** on the unit.

6 Pause/Resume recording.

Press || **PAUSE**. Press ► **PLAY** to resume recording.

- You can select channel during the Record Pause mode.

7 Stop recording.

Press ■ **STOP**. Then press ▲ **EJECT** on the VCR deck to remove the cassette.

Accidental erasure prevention

To prevent accidental recording on a recorded cassette, remove its safety tab. To record on it later, cover the hole with adhesive tape.

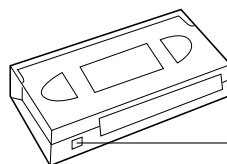

Record safety tab

NOTE:

When the end of the tape is reached during recording, the unit stops and "O" and "▷" blink on the front display panel.

Recording Features

- Turn on the TV and select the VCR channel (or AV mode).
- Slide the TV/VCR/DVD switch on the Remote to the right.

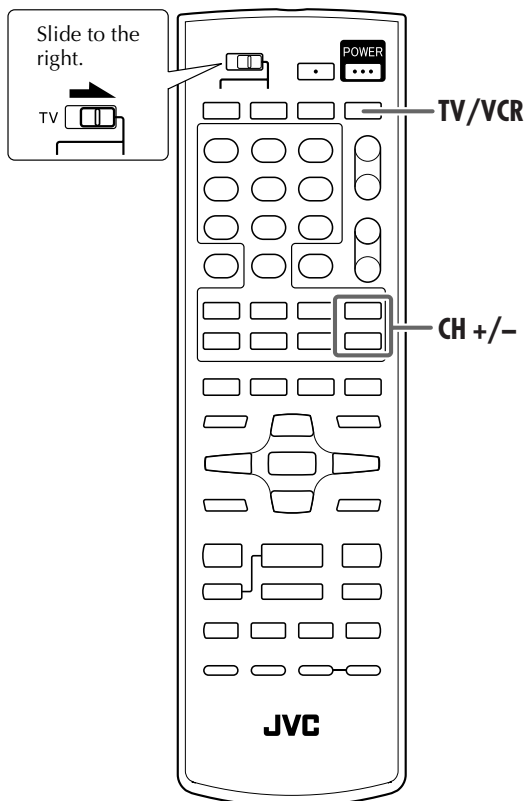
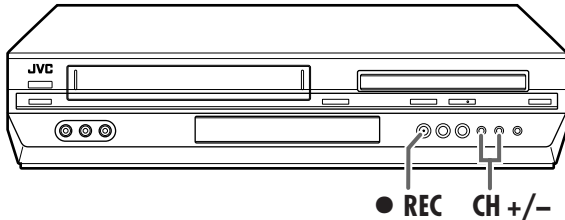

Record One Program While Watching Another

If your unit is connected to the TV via the AV connection, press **TV/VCR**. The VCR indicator on the front display panel and the TV broadcast being recorded disappear. Once recording is in progress, all you need to do is to set the channel controls on the TV for the station you wish to view.

- The program selected with the TV's channel controls appears on the TV screen, while the one selected with the unit's **CH** buttons is recorded on the tape.

NOTE:

You can also use the DVD deck in the following cases. Before use, be sure to turn on the unit and select the DVD deck.

- During recording
- During timer recording
- During timer standby mode

Instant Timer Recording (ITR)

This easy method lets you record for from 30 minutes to 6 hours (selectable in 30-min. increments), and shuts the unit off after recording is finished.

1 Start recording.

Press **REC** on the unit.

2 Engage the ITR mode.

Press **REC** again. "○" blinks and "0:30" appears on the front display panel.

3 Set the recording duration.

If you want to record for more than 30 minutes, press **REC** to extend the time. Each press extends recording time by 30 minutes.

NOTES:

- You can only perform ITR using the **REC** button on the unit's front panel.
- Still picture playback stops automatically after 5 minutes to protect the heads.
- When the end of the tape is reached during Instant Timer Recording or timer recording, the unit is turned off and "○" and "▷" blink on the front display panel.
- During Instant Timer Recording, any other timer programmed recording won't start even if their start time has come. In such a case, the timer programmed recording starts (if the end time of the timer programmed recording is set after the end of Instant Timer Recording) after the Instant Timer Recording finishes.

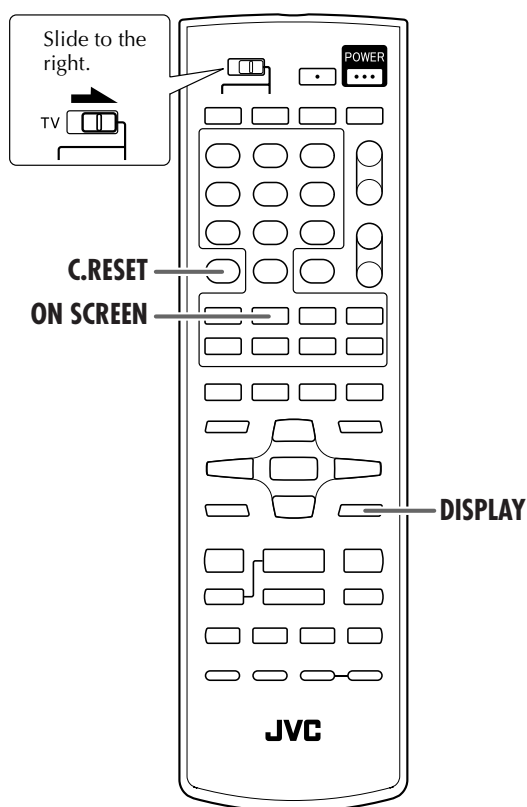

Elapsed Recording Time Indication

1 Set the counter display.

Press **DISPLAY** until a counter reading appears on the front display panel.

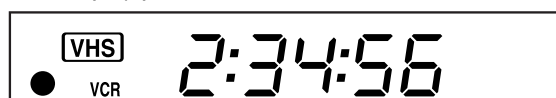

2 Reset the counter.

Press **C.RESET** before starting recording or playback.

- The counter is reset to "0:00:00" and shows the exact elapsed time as the tape runs. You can check the exact time of a recording or playback.

Tape Remaining Time

Press **DISPLAY** until the time remaining on the tape appears.

- The front display panel shows the tape remaining time with ":" blinking.



- By pressing the **DISPLAY** button, you can change display to show the channel position*, clock time, counter reading or tape remaining time.

* Channel position is not displayed during playback.

NOTES:

- When you press **ON SCREEN**, the on-screen display appears on the TV screen for 5 seconds, then the displays other than the counter disappear. To clear the counter display, press **ON SCREEN**.
- Depending on the type of tape being used, the tape remaining time reading may not appear right away, or is not correct. "--:--" may sometimes appear with ":" blinking, or the display may blink on occasion.

Second Audio Recording

This unit's built-in MTS decoder enables reception of Multichannel TV Sound broadcast. To record a SAP program received, set "2ND AUDIO RECORD" to "ON." (pg. 60)

NOTE:

When the channel is changed on the unit;

- The "STEREO" indicator appears on the screen for about 5 seconds if the program is a stereo broadcast.
- The "SAP" indicator appears on the screen for about 5 seconds if the program is a SAP broadcast.
- Both indicators appear when a stereo program is accompanied by SAP sound.

Express Timer Programming

Before performing Express Timer Programming:

- Make sure that the unit's built-in clock is set properly.
- Insert a cassette with the safety tab in place. The unit will come on automatically.
- Turn on the TV and select the VCR channel (or AV mode).
- Slide the TV/VCR/DVD switch on the Remote to the right.

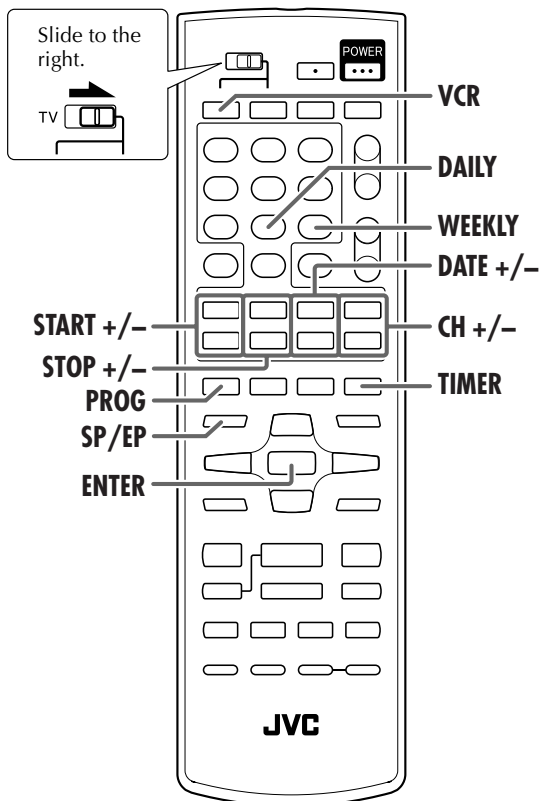

Example: To timer-record the program from 8:00 PM to 10:00 PM on 24th December, on channel 12.

1 Select the VCR deck.

On the unit

Press **VCR/DVD** repeatedly so that the VHS indicator lights up on the front display panel.

On the Remote

Press **VCR** so that the VHS indicator lights up on the front display panel.

2 Access the Program screen.

Press **PROG.** (If you're just starting out, "PROGRAM 1" appears.)

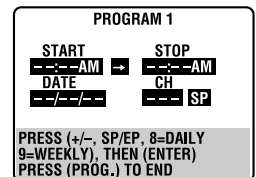

3 Enter the program start time.

Press **START +/-** to enter the time you want recording to start.

- Press and hold **START +/-** to move in 30-minute increments, or press and release repeatedly to move 1 minute at a time.

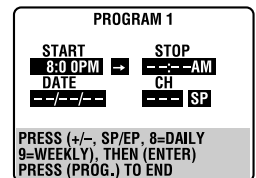

4 Enter the program stop time.

Press **STOP +/-** to enter the time you want recording to stop.

- Press and hold **STOP +/-** to move in 30-minute increments, or press and release repeatedly to move 1 minute at a time.

5 Enter the program date.

Press **DATE +/-**.

- The current date appears on the TV screen. The date you enter appears in its place.

6 Enter the channel position.

Press **CH +/-**.

7 Set the tape speed.

Press **SP/EP**.

8 Return to the normal screen.

Press **PROG** or **ENTER**. "PROGRAM COMPLETED" appears on the TV screen for about 5 seconds, then the normal screen appears. If "PROGRAM NOT COMPLETED PROGRAM OVERLAP" appears on the TV screen, see page 38.

- Repeat steps **2** – **8** for each additional program.

9 Engage the unit's timer mode.

Press **TIMER**. The unit turns off automatically and "⊖" appears on the front display panel.

- To disengage the timer mode, press **TIMER** again.

To Timer-Record Weekly Or Daily Serials:

— anytime during steps **3** through **7**, press **WEEKLY** (number key "9") for weekly serials or **DAILY** (number key "8") for daily serials (Monday – Friday). Either "WEEKLY" or "DAILY" appears on the TV screen. Pressing the button again makes the corresponding indication disappear.

NOTES:

- You can program this unit to timer-record as many as 8 programs. If you try to program the unit to record a ninth, "PROGRAM FULL" appears on the TV screen. To record the extra program, you must first cancel any unnecessary programs. (☞ pg. 37)
- Programs that start after midnight must have the next day's date.

Cable Box or DBS Receiver Users

To timer-record a satellite broadcast using Express Timer Programming:

- 1 Perform steps **1** – **9**. Enter "F-1" for the channel position in step **6**.
- 2 Set the DBS receiver to the appropriate channel before the selected program begins.
- 3 Leave the DBS receiver's power on.

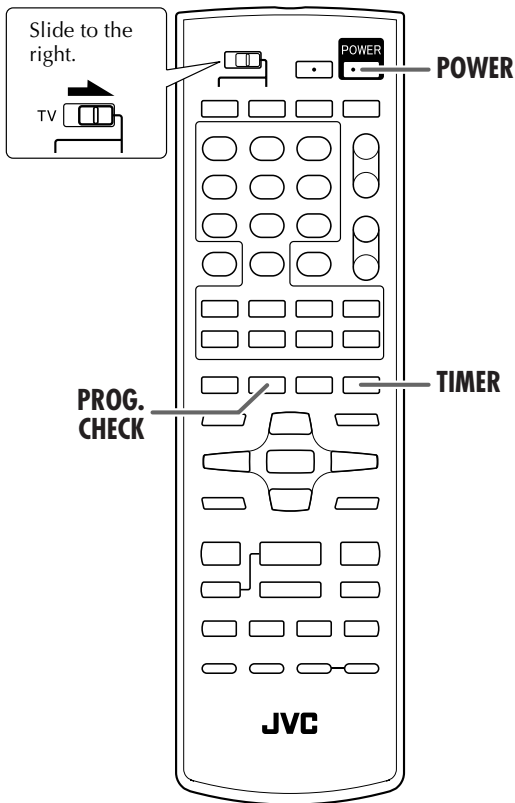

Check, cancel and change programs

1 Disengage the timer mode.

Press **TIMER**, then press **POWER**.

2 Access the Program Check screen.

Press **PROG. CHECK**.

PR	START	STOP	CH	DATE
1	8:00P	10:00	12	12/24
2	10:00A	10:45	40	12/25
3	11:30P	1:00	125	12/25
4				
5				
6				
7				
8				

PRESS (CHECK) TO NEXT

3 Access the Program screen.

Press **PROG. CHECK** again to check more information. Each time you press **PROG. CHECK**, the next program's information appears.

PROGRAM 1			
START	8:00AM	→	STOP
DATE	12/24/03		CH
	WED		TV

PRESS (CANCEL) TO CANCEL
PRESS (CHECK) TO NEXT

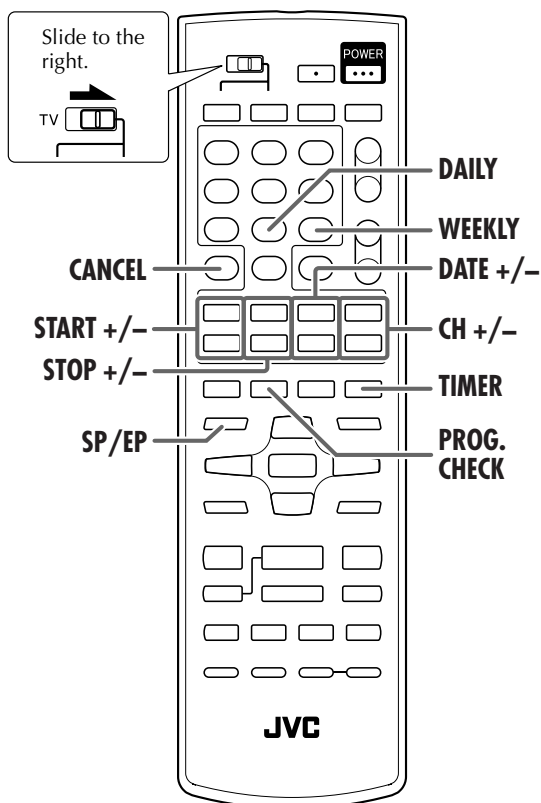

To cancel or change a program

4 Cancel or change a program.

Press **CANCEL** to cancel a program. To change program settings, press the appropriate button: **START +/-**, **STOP +/-**, **DATE +/-**, **CH +/-**, **DAILY** (number key "8"), **WEEKLY** (number key "9") and/or **SP/EP**.

5 Return to the normal screen.

Press **PROG. CHECK** as many times as necessary. If there are still some programs remaining, go on to step **6**.

6 Return to the timer mode.

Press **TIMER**.

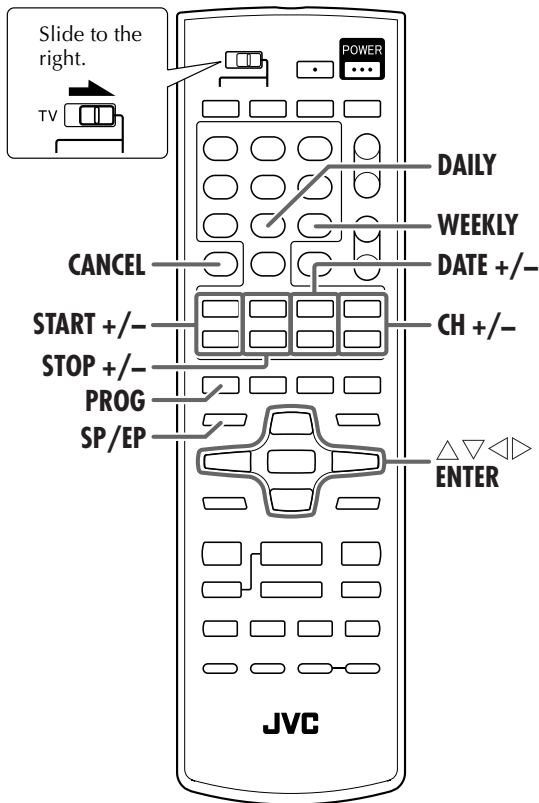

When programs overlap each other

If "PROGRAM NOT COMPLETED PROGRAM OVERLAP" appears, you have another program overlapping the program you have just made. The Program Check screen appears and conflicting programs will start blinking.

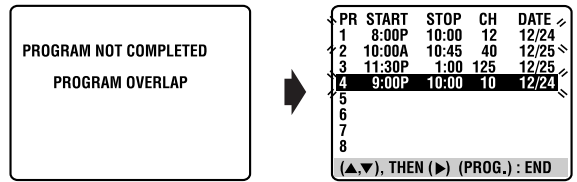

Example: Program 1 (you have just made) and Program 4 overlap each other.

1 Confirm the overlapping programs.

Overlapping programs blink on the TV screen.

2 Select the program to modify.

Press $\Delta \nabla$, then press **ENTER** or \triangleright .

- You can only select one of the overlapping programs.

NOTE:

If you do not mind this overlap, press **PROG** to finish the timer program setting. The program with the lower program number will be recorded and the other will not be recorded correctly. If no changes are made for approximately 1 minute, the unit will return to the normal screen.

3 Cancel or change program setting.

To cancel a program, press **CANCEL** when the Program screen you do not want is shown. "PROGRAM COMPLETED" appears on the TV screen for about 5 seconds, then the normal screen appears.

To change a program, press the appropriate button: **START +/-**, **STOP +/-**, **DATE +/-**, **CH +/-**, **DAILY** (number key "8"), **WEEKLY** (number key "9") and/or **SP/EP** when the Program screen on which you want to make changes is shown, then press **ENTER**. "PROGRAM COMPLETED" appears on the TV screen for about 5 seconds, then the normal screen appears.

NOTE:

If the overlap is not yet solved, or another overlap occurs with the timer program setting after making the last correction on a program, the conflicting programs will be shown on the Program Check screen again. Repeat the above steps again until the overlap is solved.

ATTENTION

If there is a conflict in the timer schedule and one program overlaps with another, only the parts shown below in gray will be recorded.

Pattern 1: The program with the lower program number will be recorded.

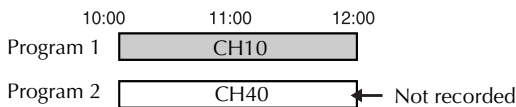

Pattern 2: The program starting earlier will be recorded.

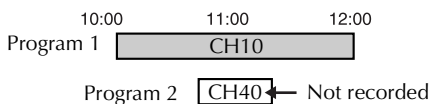

Pattern 3: The program starting earlier will be recorded, followed by the remaining portion of the other program.

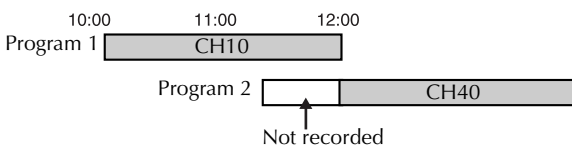

Satellite Auto Recording

This function allows you to automatically record a satellite program which is timer-programmed on your external DBS receiver. Connect a DBS receiver to the unit's AUDIO/VIDEO input (F-1) connector and program the timer on the DBS receiver. The unit starts or stops recording by the signals input from the DBS receiver. After recording, the unit's power shuts off automatically.

- You can also connect the cable box if it has a timer.

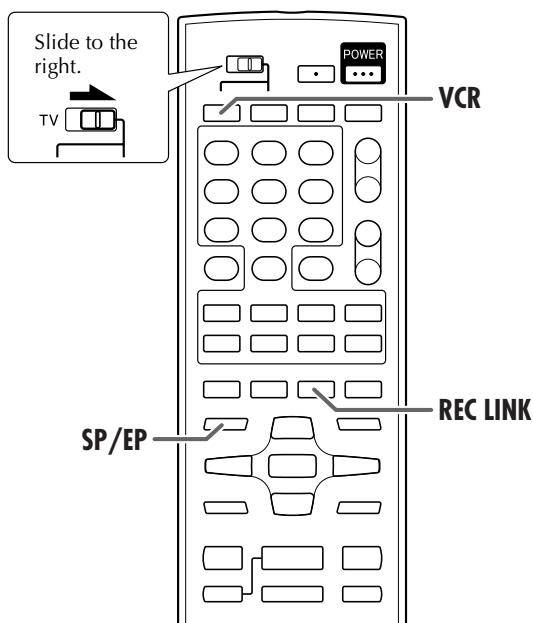

ATTENTION

- Be sure not to turn on the DBS receiver before the program is executed; otherwise, the unit will start recording when the DBS receiver's power is turned on.
- If you have connected another appliance other than a DBS receiver to the AUDIO/VIDEO input (F-1) connector, be sure not to engage the Satellite Auto Recording mode; otherwise, the unit will start recording when the connected appliance's power is turned on.
- Satellite Auto Recording and timer-recording cannot be done at the same time.

Before performing the following steps:

- Make sure the DBS receiver is connected to the unit's AUDIO/VIDEO input (F-1) connector.
- Program the timer on the DBS receiver.
- Insert a cassette with the safety tab in place.
- Slide the TV/VCR/DVD switch to the right.

1 Select the VCR deck.

On the unit

Press **VCR/DVD** repeatedly so that the VHS indicator lights up on the front display panel.

On the Remote

Press **VCR** so that the VHS indicator lights up on the front display panel.

2 Set the tape speed.

Press **SP/EP**.

3 Engage the Satellite Auto Recording mode.

Press and hold **REC LINK** for about 2 seconds. The "⏏" and "⏏" indicators light up and the unit turns off automatically.

VHS



NOTES:

- Operation on the DVD deck are not possible when the Automatic Satellite Program Recording mode is engaged, or timer recording is in progress.
- To disengage the Satellite Auto Recording mode, press **REC LINK**. The "⏏" indicator goes off.
- If the unit's power is off, it is not possible to engage the Satellite Auto Recording mode.
- In step 3, if the "⏏" indicator does not light but instead blinks quickly even though your DBS receiver's power is off, Satellite Auto Recording will not work properly with that DBS receiver*. If this is the case, perform "Express Timer Programming" (pg. 34) to timer-record a satellite program.
* Some DBS receivers output signals even if the power is off. Satellite Auto Recording is not possible with those DBS receivers.
- The "⏏" indicator blinks while Satellite Auto Recording is in progress.
- For timer programming of the DBS receiver, refer to the instruction manual of the DBS receiver.
- Satellite Auto Recording is not possible if your DBS receiver does not have a timer.
- Pressing the unit's **POWER** button while Satellite Auto Recording is in progress turns off the unit's power and disengages the Satellite Auto Recording mode.
- If there are more than one satellite programs you wish to record with Satellite Auto Recording, it is not possible to set different tape speeds for each program.
- Depending on the type of DBS receiver, the unit may not record a slight portion of the beginning of the program or may record slightly longer than the actual length of the program.
- If you engage the Satellite Auto Recording mode when the DBS receiver's power is on, the unit will not start Satellite Auto Recording even though the "⏏" and "⏏" indicators blink. When the DBS receiver shuts off once and is turned back on again, the unit starts recording.
- You can also record a program from your cable system in the same way if the system has a timer.

Basic Playback



- Turn on the TV and select the VCR channel (or AV mode).
- Slide the **TV/VCR/DVD** switch on the Remote to the right.

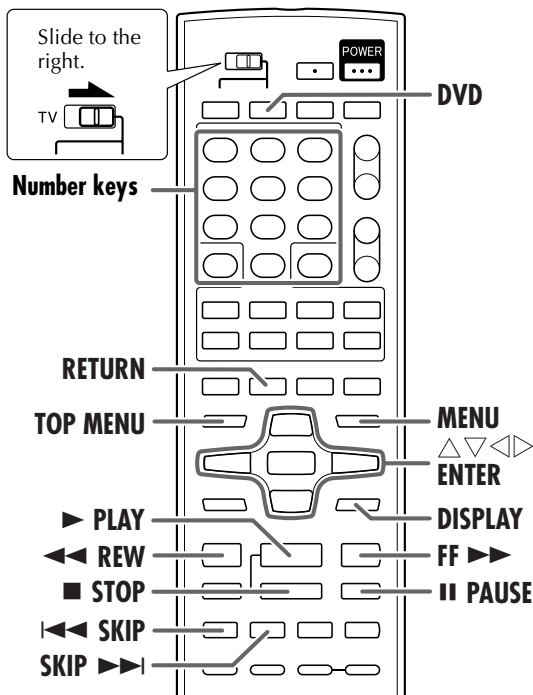
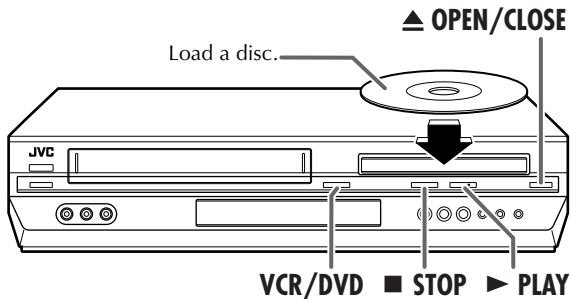

ATTENTION

- You can not use the DVD deck when the VCR deck is in the Automatic Satellite Recording standby and recording mode.
- You can use the DVD deck when the VCR deck is in the timer standby mode.
- If the unit does not accept an operation, appears on the TV screen. (Operations are occasionally unacceptable even if is not displayed.)

1 Load the disc.

- For details, refer to "Placing a Disc" (pg. 8).

2 Select the DVD deck.

On the unit

Press **VCR/DVD** repeatedly so that the DVD indicator lights up on the front display panel.

On the Remote

Press **DVD** so that the DVD indicator lights up on the front display panel.

3 Start playback.

Press **► PLAY**.

Example: DVD VIDEO

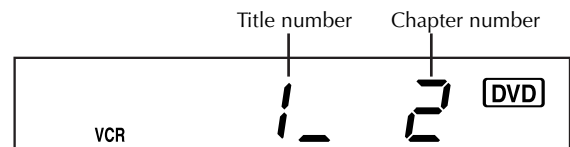

- You can switch the display on the front display panel between the title/chapter/track number and the playback time by pressing **DISPLAY**.
- It may take a few seconds to start playback.
- When inserting a DVD or Video CD disc, a menu display may appear on the TV screen. To play back from the menu, refer to "Locating a Desired Scene Using the Menu of the Video CD with Playback Control (PBC) Function" (pg. 41) or "Locating a desired scene using the DVD menu" (pg. 41).

4 Pause playback.

Press **⏸ PAUSE**.

- To resume normal playback, press **► PLAY**.

5 Stop playback.

Press **■ STOP**.

- When "RESUME" (pg. 64) is "ON," the unit memorizes the position on the disc where you have interrupted playback.
 - To resume playback, press **► PLAY**.
 - To stop playback completely, press **■ STOP** again.
- Press **▲ OPEN/CLOSE** on the DVD deck to open the disc tray, then remove the disc.

To play back a MP3/JPEG disc, see pages 49 – 51.

Playback Features

- Turn on the TV and select the VCR channel (or AV mode).
- Slide the TV/VCR/DVD switch on the Remote to the right.

Locating a desired scene using the DVD menu



DVD VIDEO discs generally have their own menus which show the disc contents. These menus contain various items such as titles of movies, names of songs, or artist information, and display them on the TV screen. You can locate a desired scene using the DVD menu.

1 Access the DVD menu.

Press **TOP MENU** or **MENU**.

2 Start playback.

Press $\triangle \nabla \triangleleft \triangleright$ to select a desired item, then press **ENTER**.

- It may be possible to select the desired item using the **number keys** depending on the disc.

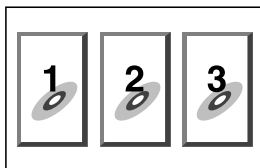

Example:

Locating a Desired Scene Using the Menu of the Video CD with Playback Control (PBC) Function



Some Video CD discs supports the PBC function. PBC is an abbreviation of "PlayBack Control." A Video CD disc recorded with PBC has its own menus, such as a list of the songs of the disc. You can locate a specific scene by using the menu.

1 Access the PBC menu.

In stop mode

Press **▶ PLAY**.

- Depending on a disc, PBC menu may automatically appear on the TV screen by simply loading a disc on the unit. "Pbc" appears on the front display panel.

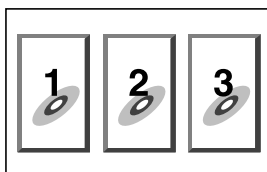

Example:

During playback

Press **RETURN**.

2 Start playback.

Press the appropriate **number keys**.

- The unit starts playback of the selected item.
- When "NEXT" or "PREVIOUS" appears on the TV screen: Pressing **SKIP ▶▶▶** advances to the next page. Pressing **◀◀◀ SKIP** returns to the previous page.
- The method of the operation is different depending on the disc.

To cancel PBC

Start playback by using the **number keys** instead of **▶ PLAY**.

To reactivate PBC

- Press **TOP MENU** or **MENU**.
- Press **■ STOP** to stop playback, then press **▶ PLAY**.

Locating the Start Point of the Item or Skip the Item



Press **◀◀◀ SKIP** or **SKIP ▶▶▶** during playback.

Example:

To locate the beginning of item B from the current position, press **◀◀◀ SKIP** twice.

To locate the beginning of item D from the current position, press **SKIP ▶▶▶** once.

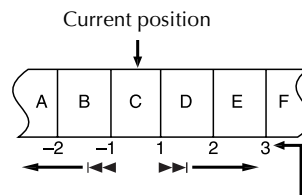

The number you press the button

- When the specified item is located, playback begins automatically.

NOTE:

When you press **◀◀◀ SKIP** or **SKIP ▶▶▶**, the counter display may appear instead of title number/chapter number depending on the discs.

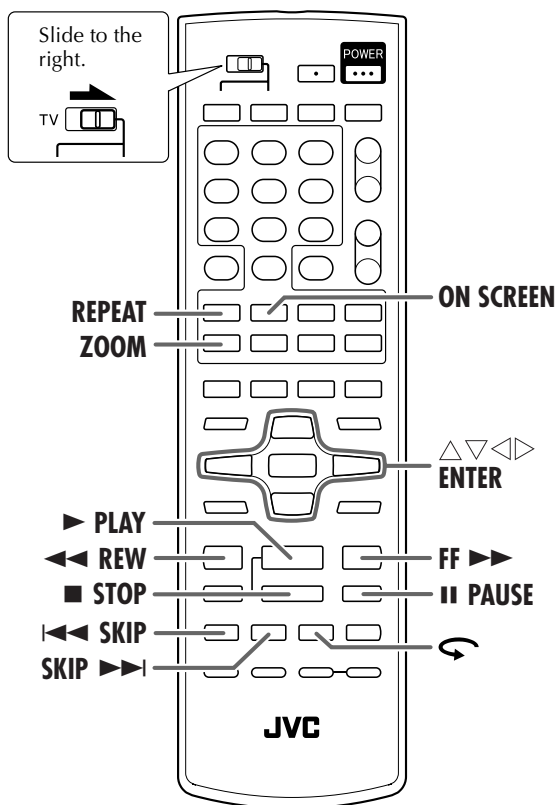

Still Picture/Frame-By-Frame Playback



1 Pause during playback.

Press **II PAUSE**.

2 Activate frame-by-frame playback.

Press **II PAUSE** to advance a still picture.

- To resume normal playback, press **▶ PLAY**.

Slow Motion



During playback, press **II PAUSE**, then press **FF ▶▶** for forward slow motion playback, or **◀◀ REW** for reverse slow motion playback.

- Each press of **FF ▶▶** changes the playback speed as follows:
1/32 → 1/16 → 1/8 → 1/4 → 1/2
- Each press of **◀◀ REW** changes the playback speed as follows (only for DVD VIDEO discs):
-1/32 → -1/16 → -1/8 → -1/4 → -1/2
- To resume normal playback, press **▶ PLAY**.

NOTES:

- Reverse slow motion playback is possible only with the DVD VIDEO discs.
- This function may not work for some Video CD or SVCD.

Variable Speed Search



During playback, press **FF ▶▶** for forward variable speed search, or **◀◀ REW** for reverse variable speed search.

- Each press of **FF ▶▶** changes the playback speed as follows:
+2x → +5x → +20x → +60x
- Each press of **◀◀ REW** changes the playback speed as follows:
-2x → -5x → -20x → -60x
- To resume normal playback, press **▶ PLAY**.

OR

During playback, press and hold **SKIP ▶▶I** for forward search, or press and hold **I◀◀ SKIP** for reverse search.

- While you press and hold the button, the image is played back at 5x speed.
- To resume normal playback, release **I◀◀ SKIP** or **SKIP ▶▶I**.

NOTES:

- Actual speed may be different from that displayed on the TV screen depending on the discs.
- Playback sound is not heard in any variable speed search mode.

One Touch Replay



Press **↶** while playing back a DVD VIDEO disc.

The playback position moves back about 10 seconds before the current position (only within the same title).

Zooming



Press **ZOOM** during playback or while paused.

- Each press of **ZOOM** changes the magnification in the following steps:
ZOOM OFF → ZOOM 1 → ZOOM 2 → ZOOM 3 → ZOOM 4 → ZOOM 5 → ZOOM 6 → (Back to the beginning)
- While zoomed, the picture may look coarse or distorted.

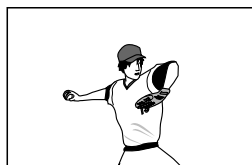

Current magnification



Zoomed-in area

Press **△▽◀▶** to move the zoomed-in scene.

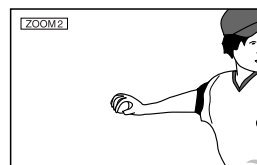

Repeat Playback



You can repeat playback as you like according to the type of disc.

DVD VIDEO: during playback
 Audio CD: during playback or in stop mode
 Video CD/SVCD: in stop mode or during playback with PBC deactivated

1 Access the repeat mode.

Press **REPEAT**.

- Repeat mode is displayed on the TV.

2 Select the repeat mode.

Press **REPEAT** repeatedly to select the desired repeat mode.

DVD VIDEO

CHAPTER→TITLE→OFF→(Back to the beginning)

CHAPTER:	The current chapter is played back repeatedly.
TITLE:	The current title is played back repeatedly.
OFF:	Each title and chapter is played back once.

Video CD/SVCD/CD

TRACK→ALL→OFF→(Back to the beginning)

TRACK:	The current track is played back repeatedly.
ALL:	All tracks are played back repeatedly.
OFF:	Each track is played back once.

- The pop-up window disappears if no operation is done for about 5 seconds.

To cancel Repeat Playback

Press **REPEAT** repeatedly until "OFF" appears on the TV screen.

NOTES:

- Repeat Playback is not possible with a Video CD and SVCD with PBC function.
- Repeat Playback may not work properly depending on the type of disc being used.
- You cannot select A-B Repeat Playback by pressing **REPEAT**.

A-B Repeat Playback



You can repeat the desired part.

1 Access the on-screen bar.

Press **ON SCREEN** twice. The on-screen bar appears on the TV screen.

2 Select menu item.

Press ◀▶ to highlight , then press **ENTER**.

- The following pop-up window appears under the selected item.



3 Select the repeat mode.

Press ▲▼ repeatedly to select "A-B."

4 Select the start point.

Press **ENTER** at the beginning of the part you want to repeat (point A).

- The following display appears in the on-screen bar.



5 Select the end point

Press **ENTER** at the end of the part you want to repeat (point B).

- A-B Repeat Playback starts. The selected part of the disc (between point A and B) is played repeatedly.

To cancel A-B Repeat Playback

Repeat from step **1**, select "OFF" in step **3**, then press **ENTER**.

To clear the on-screen bar

Press **ON SCREEN**.

NOTE:

The points A and B must be set in the same title or track.

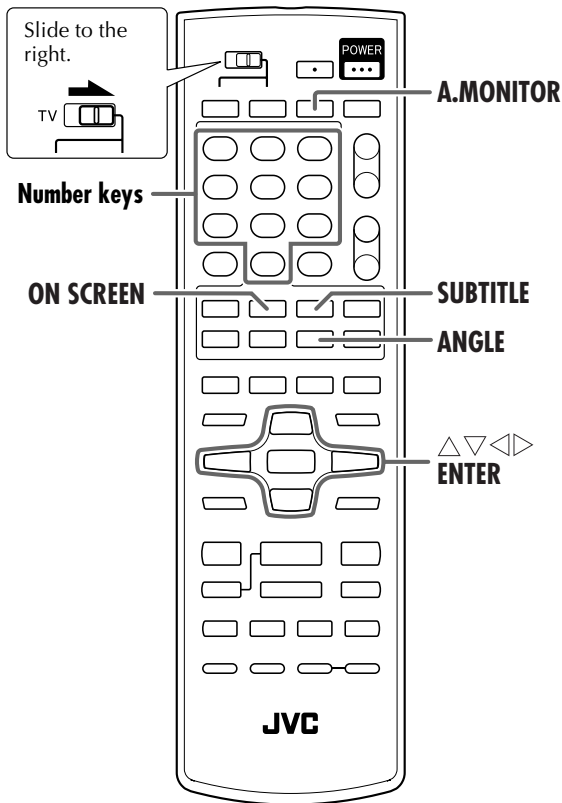

Example:

To play back from a point 2 (hours): 34 (minutes): 08 (seconds) elapsed

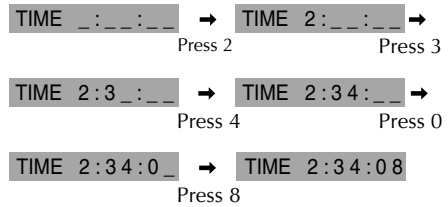

If you have specified a wrong selection,

Press **<** repeatedly until the wrong number is erased, then press **number keys** to enter the correct numbers.

- The unit starts playback from the specified time.

To clear the on-screen bar

Press **ON SCREEN**.

NOTE:

Some DVD VIDEO discs do not contain time information, and it is not possible to use the Time Search function.

Subtitle Selection



You can select subtitle language.

- During playback

1 Access the menu.

Press **SUBTITLE**.

- The following pop-up window appears on the TV screen.

Example (DVD): "ENGLISH" is selected out of 3 subtitle languages recorded.

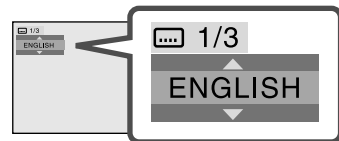

2 Select the subtitle language.

Press **Δ∇** repeatedly to select the desired subtitle language. To turn off the subtitle, press **SUBTITLE** repeatedly until "OFF" is selected.

- Each time you press the button, the subtitle language changes.
- The pop-up window disappears if no operation is done for about 5 seconds.

NOTES:

- **For DVD VIDEO**

Some subtitle languages are abbreviated in the pop-up window. See "Language Code List" (pg. 21).

- **For SVCD**

An SVCD can contain up to four subtitles. Pressing **SUBTITLE** changes the subtitles regardless of whether the subtitles are recorded or not.

Time Search



You can play back a disc from the desired point by specifying the elapsed time from the beginning of the current title (for DVD VIDEO) or the disc (for Audio CD/Video CD) using the Time Search.

1 Access the on-screen bar.

Press **ON SCREEN** twice. The on-screen bar appears on the TV screen.

2 Select menu item.

Press **<▷** to highlight **⊕▷**, then press **ENTER**.

- The following pop-up window appears under the selected item.



3 Select the time.

Press the **number keys** (0-9) to enter the time, then press **ENTER**.

Angle Selection



You can enjoy a variety of scene angles if the DVD VIDEO disc contains "multi-angle" parts, where multiple cameras were used to shoot the same scene from different angles.

- During playback

1 Access the menu.

Press **ANGLE**.

- The following pop-up window appears on the TV screen.

Example: The first view angle is selected out of 3 view angles recorded.

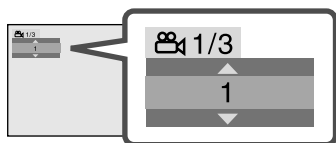

2 Select the view angle.

Press Δ / ∇ or **ANGLE** repeatedly to select the desired view angle.

- Each time you press the button, the angle of the scene changes.
- The pop-up window disappears if no operation is done for about 5 seconds.

Example:

1/3 → 2/3 → 3/3 → (Back to the beginning)

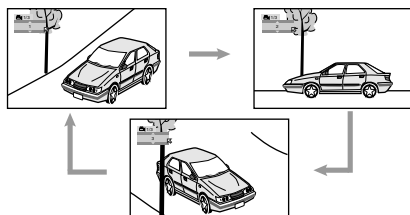

Audio Language and Sound Selection



The audio selection setting allows you to change the audio language of a movie, or to listen to karaoke with or without the vocal.

- During playback

1 Access the menu.

Press **A.MONITOR**.

- The following pop-up window appears on the TV screen.

Example: "ENGLISH" is selected out of 3 audio languages recorded during DVD VIDEO playback.

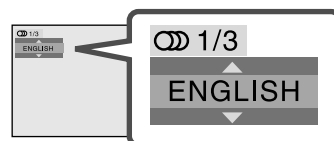

2 Select the audio setting.

Press Δ / ∇ or **A.MONITOR** repeatedly to select the desired audio language.

- Each time you press the button, the audio selection changes.
- The pop-up window disappears if no operation is done for about 5 seconds.

DVD VIDEO (example)

1/3 ENGLISH → 2/3 FRENCH → 3/3 SPANISH → (Back to the beginning)

Video CD

ST → L → R → (Back to the beginning)

ST:	To listen to normal stereo playback.
L:	To listen to L (left) audio channel only.
R:	To listen to R (right) audio channel only.

SVCD

ST 1 → ST 2 → L 1 → R 1 → L 2 → R 2 → (Back to the beginning)

ST 1/ST 2:	To listen to normal stereo playback of ST 1 or ST 2 channel.
L 1/L 2:	To listen to the L (left) 1 or 2 audio channel.
R 1/R 2:	To listen to the R (right) 1 or 2 audio channel.

NOTE:

For DVD VIDEO discs, some audio languages are abbreviated in the pop-up window. See "Language Code List" (pg. 21).

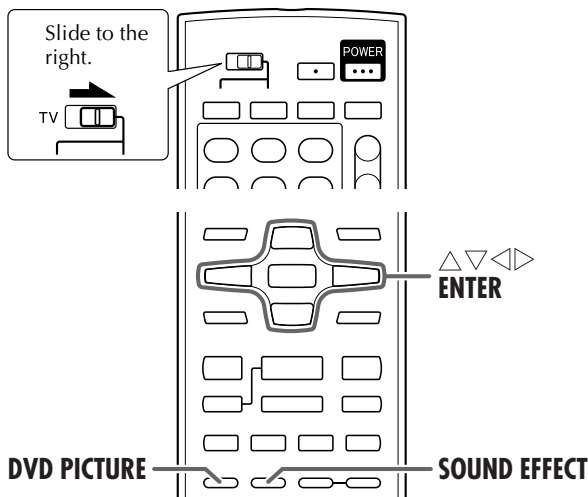

Sound Effect



Using the Sound Effect function, you can change the sound field.

- This function makes a human voice clearer.
- This function works only for analog audio output.

1 Access the selection menu.

Press **SOUND EFFECT** during playback.

- The current setting appears on the TV screen.

2 Turn on the Sound Effect function.

Press **SOUND EFFECT** to turn on the function.

- Each time you press **SOUND EFFECT**, the Sound Effect function turns on and off:
SOUND EFFECT:ON ⇌ **SOUND EFFECT:OFF**
- The selection menu disappears if no operation is done for about several seconds.

NOTES:

- The Sound Effect function works correctly only for a DVD VIDEO disc recorded in the 5.1-channel audio format.
- You may not feel the effect of this function well depending on the source recorded on the disc.

VFP function — Adjusting the picture quality



The VFP (Video Fine Processor) function enables you to adjust the picture character according to the type of programing, picture tone or personal preference.

1 Access the VFP setting menu.

Press **DVD PICTURE** during playback.

- The current setting appears on the TV screen.

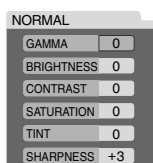

2 Select the VFP mode.

Press ◀▶ repeatedly.

- Each time you press ◀▶, the VFP mode changes as follows:
NORMAL → **CINEMA** → **USER 1** → **USER 2** → (Back to the beginning)

NORMAL:	Select this normally.
CINEMA:	Suitable for movie.
USER 1/ USER 2:	You can adjust parameters that affect picture appearance and store settings. Go to step 3.

To adjust picture appearance manually

- Only "USER 1" or "USER 2" settings can be customized.

3 Access USER menu.

Press ◀▶ repeatedly to select "USER 1" or "USER 2."

4 Select the parameter.

Press △▽ repeatedly to select a parameter you want to adjust, then press **ENTER**.

- Adjust gradually and confirm picture appearance results are as preferred.

GAMMA (-3 to +3):	Adjust this if the neutral color is bright or dark. The brightness of dark and bright portions is maintained.
BRIGHTNESS (-8 to +8):	Adjust this if the picture is bright or dark on the whole.
CONTRAST (-7 to +7):	Adjust this if the objects in far and near positions look unnatural.
SATURATION (-7 to +7):	Adjust this if the picture is whitish or blackish.
TINT (-7 to +7):	Adjust this if the appearance of flesh tone is unnatural.
SHARPNESS (-8 to +8):	Adjust this if the picture is indistinct.

- VFP menu disappears and the following pop-up window appears on the TV screen.

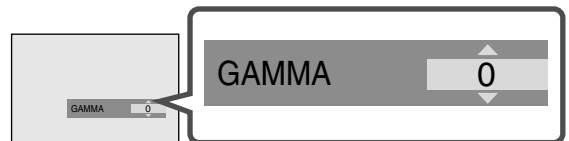

5 Adjust the parameter.

Press △▽ repeatedly to change the setting, then press **ENTER**.

- The current VFP settings appear again.
- Repeat steps 4 and 5 to adjust other parameters.

To return to the normal screen

Press **DVD PICTURE**.

NOTE:

The VFP setting screen disappears if no operation is done for more than about 10 seconds.

Using the on-screen bar



You can check disc information while the disc is loaded and you can use some functions using the on-screen bar. The on-screen bar allows you the various playback operations.

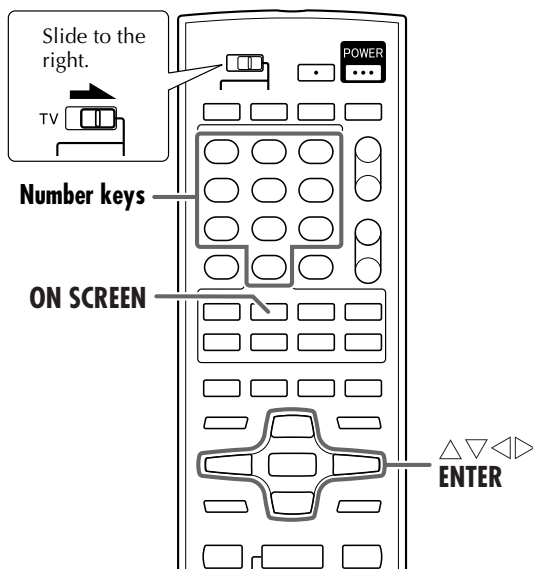

Basic operation on the on-screen bar

During playback

1 Access the on-screen bar.

Press **ON SCREEN** twice. The on-screen bar appears on the TV screen.

- The currently selected item is highlighted.



2 Select menu item.

Press \triangle ∇ to highlight the item you want to work with, then press **ENTER**. The pop-up window appears under the selected item.

After pressing ENTER

- When a pull-down menu appears, press \triangle ∇ to select the setting you want, then press **ENTER**.
- When a number-entry box appears, use the **number key** to enter the number you want, then press **ENTER**.
- When changing the indication of playback time, press **ENTER** repeatedly to select the setting you want.

For details about each function, see page 48.

How to Access the On-Screen Bar

1 Access the status bar.

Press **ON SCREEN** when a disc is loaded. The status bar appears on the TV screen.

Example: During DVD VIDEO playback

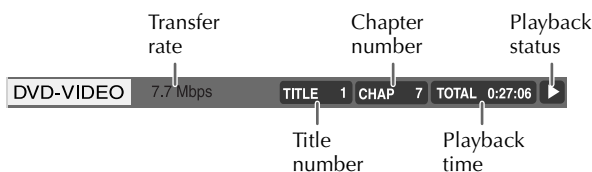

2 Access the menu bar.

Press **ON SCREEN** again. The menu bar appears under the status bar.



To clear the on-screen bar

Press **ON SCREEN**.

Menu Bar Functions for DVD VIDEO

■ Time mode selection

During playback, selects the time mode shown in the status bar and on the front display.

- **TOTAL:** Current title elapsed time
- **T.REM:** Current title remaining time
- **TIME:** Current chapter elapsed time
- **REM:** Current chapter remaining time

■ Repeat mode (See also page 43)

Selects the repeat mode during playback.

- **CHAPTER:** Current chapter repeat
- **TITLE:** Current title repeat
- **A-B:** A-B repeat
- **OFF:** Repeat mode deactivated

■ Time search (See also page 44)

Specifies a time from the beginning of the current title as the point from which to begin playback.

■ Chapter search

During playback, specifies a desired chapter to be played back from.

■ Audio selection (See also page 45)

During playback, selects the audio language or sound track.

■ Subtitle selection* (See also page 44)

During playback, selects the subtitle language.

** It is impossible to select "OFF" when using the on-screen bar. To select "OFF," press ON SCREEN to clear the on-screen bar, then press SUBTITLE repeatedly until "OFF" is selected.*

■ Angle selection (See also page 45)

During playback, selects a desired scene angle in a multi-angle part.

Menu Bar Functions for SVCD/Video CD/Audio CD

■ Time mode selection

Selects the time mode shown in the status bar and on the front display.

- **TIME:** Current track elapsed time
- **REM:** Current track remaining time (while in stop mode, current track total time)
- **TOTAL:** Disc elapsed time
- **T.REM:** Disc remaining time (while in stop mode, disc total time)

■ Repeat mode (See also page 43)

Selects the repeat mode.

- **TRACK:** Current track repeat
- **ALL:** All track repeat
- **A-B:** A-B repeat
- **OFF:** Repeat mode deactivated

■ Time search (See also page 44)

Specifies a time from the beginning of the disc as the point from which to begin playback.

■ Audio selection (See also page 45)

During Video CD/SVCD playback, selects the audio channel(s).

■ Subtitle selection (See also page 44)

During SVCD playback, selects the subtitle.

MP3/JPEG Files Playback

Outline

This unit can play back MP3 and JPEG files on a personally recorded on CD-R/RW and commercially available CD disc.

- This unit may be unable to play back the disc due to the characteristics or recording conditions.

Precautions

About files and folders (groups) on the disc

- This unit can recognize up to 99 groups and up to 150 files per group.
If a disc includes more than the files above limit, the unit stops detecting files when the number of detected files reaches the limit and ignores the subsequent files. The unit also ignores any non-MP3/JPEG file in the disc.
- Add the appropriate extension, such as "mp3" or "jpeg" to the file name.

For making your own disc:

- Use "ISO 9660" as the disc format for CD-R/RW.
- The unit does not support "packet writing" (UDF format) for CD-R/RW.
- The unit supports discs recorded with up to five multiple sessions.
- Finalize the disc.

For MP3 files:

MP3i and MP3 Pro are not available.

For JPEG files:

- This unit supports the JPEG files whose resolution is 32 to 8192 pixel in width and 32 to 7680 pixel in height.
- We recommend to record a file at 640 x 480 resolution. (If a file has been recorded at a resolution of more than 640 x 480, it will take a longer time to be displayed.)

NOTES:

- Because of the disc characteristics or recording condition, some discs may not be played back or it takes time to start playback.
- The unit does not support "packet writing" discs.
- If there are any files which are stored on a disc directly and do not belong to any group, the unit recognized them as belonging to an independent group.
- The unit plays back groups/files on a disc in the alphabetical order. Therefore, playback order may be different from the order recorded on a disc.
- Be sure to set "FILE TYPE" correctly when playing back a disc which contains both MP3 and JPEG files. (☞ pg. 62)

Control display

The control display appears on the TV screen and playback starts when an MP3 or a JPEG disc is loaded.

Example: When an MP3 disc is loaded

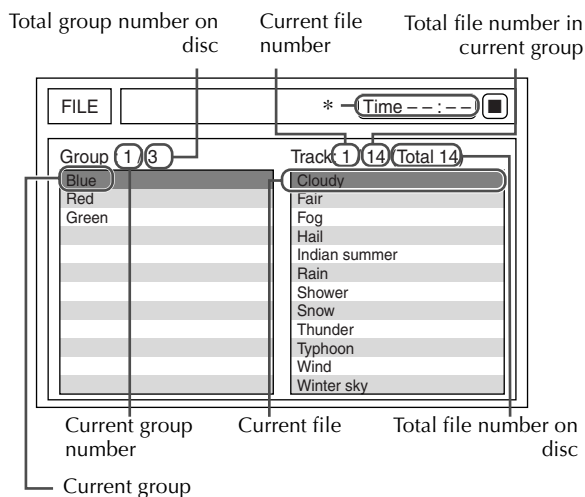

* For MP3 only

Elapsed playing time of current track

Elapsed playing time is only shown during playback.

Basic Playback

When you insert a disc with groups and files, the control display that shows the contents of the disc automatically appears on the TV screen. (☞ pg. 49)

You can specify and play back the desired group/file from the control display using the following procedure.

- Turn on the TV and select the VCR channel (or AV mode).
- Slide the **TV/VCR/DVD** switch on the Remote to the right.

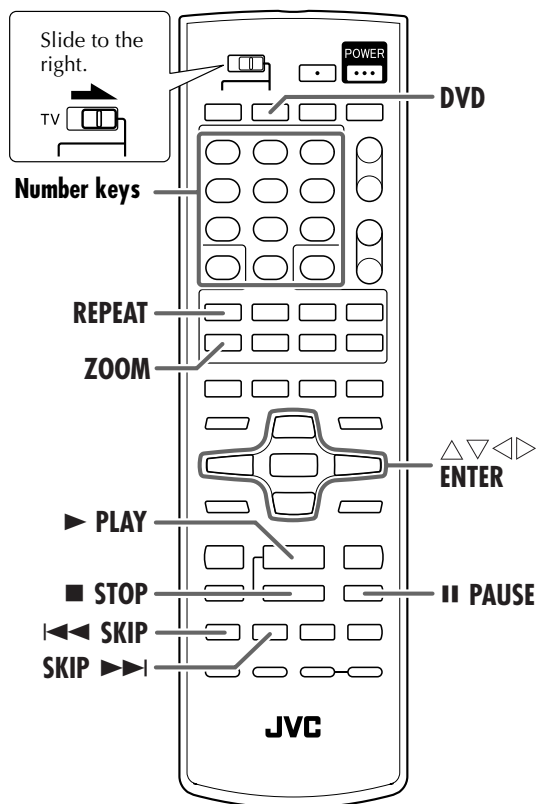
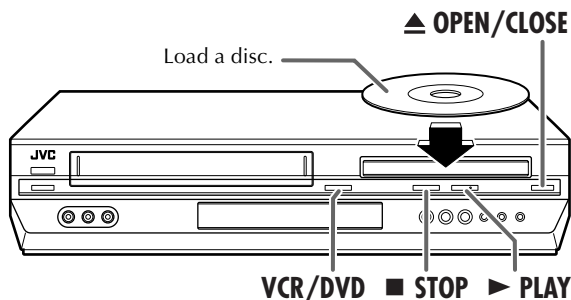

NOTES:

- ► **PLAY**, ■ **STOP**, II **PAUSE**, ◀◀ **SKIP** and **SKIP** ▶▶▶ buttons function the same as with Audio CD discs, however, FF ▶▶▶ and ◀◀ **REW** buttons do not function for MP3/JPEG files playback.
- Resume playback also does not function for MP3/JPEG files playback.

1 Load the disc.

- For details, refer to "Placing a Disc" (☞ pg. 8).

The control display appears on the TV screen. (☞ pg. 49)

2 Select the DVD deck.

On the unit

Press **VCR/DVD** repeatedly so that the DVD indicator lights up on the front display panel.

On the Remote

Press **DVD** so that the DVD indicator lights up on the front display panel.

3 Select the group.

Press ▲▼ to select the desired group, then press ▷.

4 Start playback.

Press ▲▼ to select the desired file, then press **ENTER** or ► **PLAY**.

- You can skip a file across a group. Press **SKIP** ▶▶▶ to skip to the first file of the next group when the last file of the current group is selected.

When playing back a JPEG disc, the slide-show playback starts from the selected file.

- After selecting a file, press ► **PLAY** to start slide-show playback from the selected file, or press **ENTER** to show the selected file.
- The playback interval time of slide-show depends on the file size.

5 Pause playback.

Press II **PAUSE**.

- To resume normal playback, press ► **PLAY**.

6 Stop playback.

Press ■ **STOP**.

- Press ▲ **OPEN/CLOSE** on the DVD deck to open the disc tray, then remove the disc.

Group/File Selection

To start playback by specifying the group/file number

- 1 Press the **number keys** (0-10, +10) to enter the group number.
- 2 Press the **number keys** (0-10, +10) to enter the file number.

Example:

To select 3: Press 3.

To select 14: Press +10, then 4.

To select 20: Press +10, then 10.

Or press +10 twice, then 0.

To select 24: Press +10, +10, then 4.

To select 110: Press +10 ten times, then 10.

To select 150: Press +10 fourteen times, then press 10 once.

For MP3 files playback

Playback starts from the file you have specified.

For JPEG files playback

- The slide-show playback starts from the file you have specified.
- To display only the selected file, then press **ENTER**. To start slide-show playback from that file, press **ENTER** again.

NOTE:

You cannot select 150 even if you press +10 fifteen times, then press 0 once.

Repeat Playback

You can repeat playback of the current group, file (only for MP3 files), or all groups.

- While the control display is on the TV screen:

1 Select the mode.

Press **REPEAT** to select the desired repeat mode.

- Each time you press **REPEAT**, the mode changes as follows:

For MP3 files playback

TRACK→GROUP→ALL→OFF (No indication)→(Back to the beginning)

TRACK:	The current file (track) is played back repeatedly.
GROUP:	All files of the current group are played back repeatedly.
ALL:	All files are played back repeatedly.
OFF (no indication):	Each file is played back once.

For JPEG files playback

GROUP→ALL→OFF (No indication)→(Back to the beginning)

GROUP:	All files of the current group are played back repeatedly.
ALL:	All files are played back repeatedly.
OFF (No indication):	Each file is played back once.

2 Start playback.

Press ► **PLAY**.

To cancel Repeat Playback

Press **REPEAT** repeatedly until the repeat mode display disappears from the TV screen.

To return to the control display

Press ■ **STOP**.

Zooming a still picture

Press **ZOOM** while playing back a JPEG file.

- When you want to zoom the picture during slide-show playback, first press ■ **PAUSE**, then press **ZOOM**.
- Each press of **ZOOM** changes the magnification in the following steps:
ZOOM OFF → ZOOM 1 → ZOOM 2 → (Back to the beginning)
- To resume normal playback, press **ENTER**.

Edit From A Camcorder

Slide the TV/VCR/DVD switch on the Remote to the right.

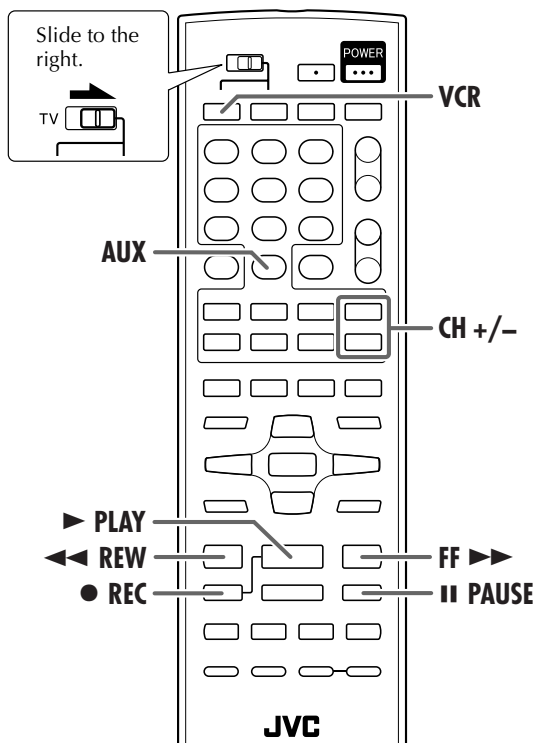
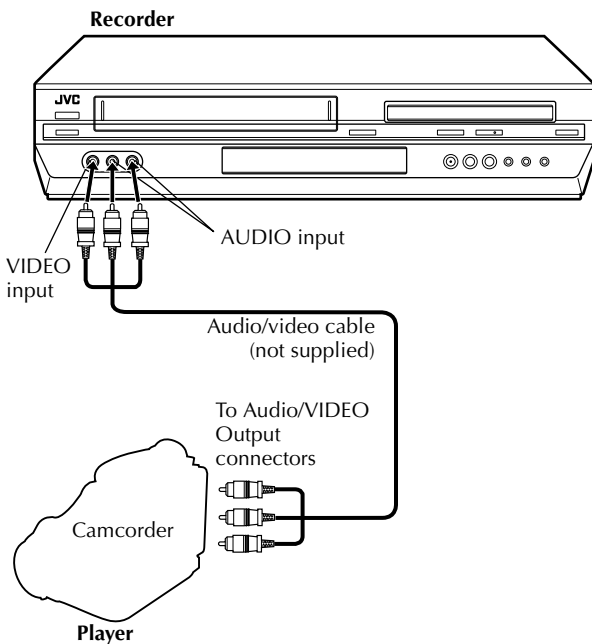

You can use a camcorder as the source player and your unit as the recording deck.

1 Make connections.

Connect the camcorder's AUDIO OUT and VIDEO OUT connectors to the unit's front panel AUDIO and VIDEO input connectors.

- When using a monaural camcorder, connect its AUDIO OUT connector to the AUDIO L input connector on your unit.

2 Select the VCR deck.

On the unit

Press **VCR/DVD** repeatedly so that the VHS indicator lights up on the front display panel.

On the Remote

Press **VCR** so that the VHS indicator lights up on the front display panel.

3 Set the unit's input mode.

Press **AUX** (number key "0") and/or **CH +/-** to select "F-1."

4 Set the edit mode.

See "PICTURE CONTROL" on page 59.

5 Engage the Record Pause mode.

Use **▶ PLAY**, **FF ▶▶**, or **◀◀ REW** to locate the point where you start recording, then press and hold **⏸ PAUSE** and press **● REC** to engage the Record Pause mode.

6 Start the camcorder.

Engage the Play mode of the camcorder.

7 Start the unit.

Press **▶ PLAY** to engage the Record mode of the unit.

NOTES:

- All necessary cables can be obtained from your dealer.
- When you select "EDIT" to dub tapes in step 4, be sure to select "NORM" after you finish dubbing the tapes.

Edit To Or From Another Video Recorder

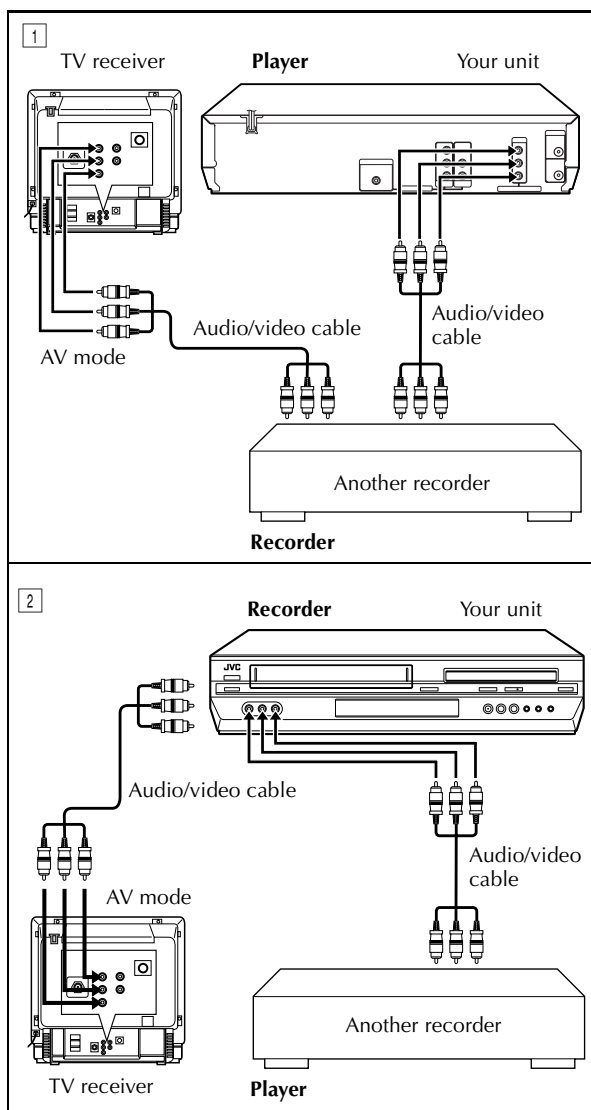

You can use your unit as the source player or as the recording deck.

Slide the **TV/VCR/DVD** switch on the Remote to the right.

1 Make connections.

- 1 When using your unit as the source player ... connect its **AUDIO/VIDEO OUTPUT** connectors to the audio/video input connectors on another recorder.
- 2 When using your unit as the recording deck ... connect its **AUDIO/VIDEO** input connectors to the audio/video output connectors on another recorder.

2 Select the VCR deck.

On the unit

Press **VCR/DVD** repeatedly so that the VHS indicator lights up on the front display panel.

On the Remote

Press **VCR** so that the VHS indicator lights up on the front display panel.

3 Set the input mode of recording deck.

With this video unit, press **AUX** (number key "0") and/or **CH +/-** to select "F-1."

- When using another recorder as the recording deck, refer to its instruction manual.

4 Set the edit mode.

See "PICTURE CONTROL" on page 59.

5 Engage the Record Pause mode of the recording deck.

Locate the point where you start recording, then engage the Record Pause mode.

6 Start the source player.

Engage the Play mode of the source player.

7 Start the recording deck.

Engage the Record mode of the recording deck.

NOTES:

- All necessary cables can be obtained from your dealer.
- When you select "EDIT" to dub tapes in step 4, be sure to select "NORM" after you finish dubbing the tapes.
- When you use this unit as the source player for editing, be sure to set "SUPERIMPOSE" to "OFF" before starting. (pg. 59)

Dubbing

(from DVD to VCR)

- Turn on the TV and select the VCR channel (or AV mode).
- Slide the TV/VCR/DVD switch on the Remote to the right.

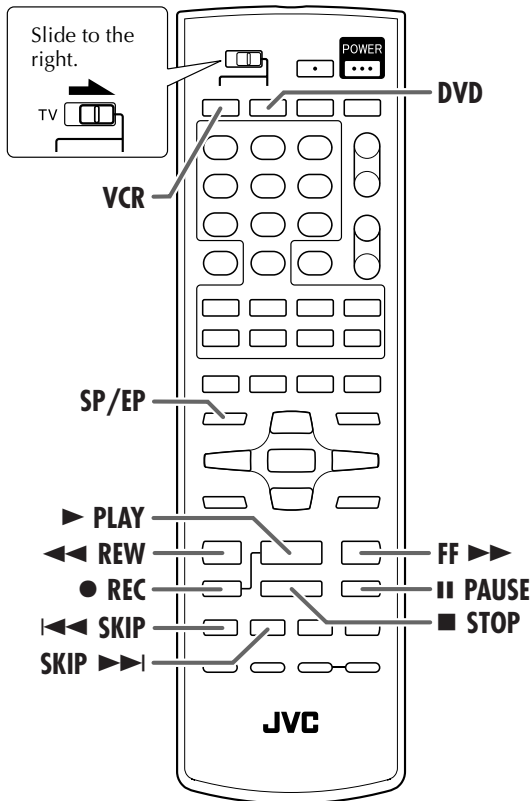

You can dub selected scenes from the DVD disc to a cassette, starting and stopping wherever you wish. However, it is not possible to dub the copy-protected disc. In such case, "Err" appears on the front display panel.

1 Load a cassette and place a disc.

For the VCR deck

Insert a cassette with the record safety tab intact.

For the DVD deck

For details, refer to "Placing a Disc" (pg. 8).

2 Prepare the VCR deck for dubbing.

- 1 Press **VCR**.
- 2 Press **SP/EP** to select recording speed.
- 3 Search for the point where you want to start dubbing by pressing **▶ PLAY**, **FF ▶▶** or **◀◀ REW** then press **■ STOP**.

3 Prepare the DVD deck for dubbing.

- 1 Press **DVD**.
 - 2 Search for the point where you want to start dubbing by pressing **▶ PLAY**, **FF ▶▶**, **◀◀ REW**, **SKIP ▶▶** or **◀◀ SKIP**.
 - 3 Press **|| PAUSE** to pause playback a little before the start point.
- Turn off the on-screen bar if it appears on the TV screen.

4 Start dubbing.

Press and hold **● REC**, then press **▶ PLAY** on the Remote (on DVD deck mode).

- "dub" lights on the front display panel.



5 End dubbing.

Press **■ STOP**.

- Be sure to press **■ STOP** while the VCR indicator lights up on the unit.

NOTES:

- You can dub from DVD to VCR regardless of the scan mode setting. (pg. 15) However, the progressive signals will be converted to the interlace signals when dubbing.
- Set "ON SCREEN GUIDE" to "OFF" (pg. 64) if you do not want to record the on-screen display for DVD discs during dubbing.
- There may be a discrepancy of several seconds between where you intend editing to start, and where it actually starts.
- The superimposed indication during the operation or dubbing is not recorded.
- Set "PICTURE CONTROL" to "EDIT." (pg. 59)

Digital Audio Dubbing

- Turn on the TV and select the VCR channel (or AV mode).
- Slide the TV/VCR/DVD switch on the Remote to the right.

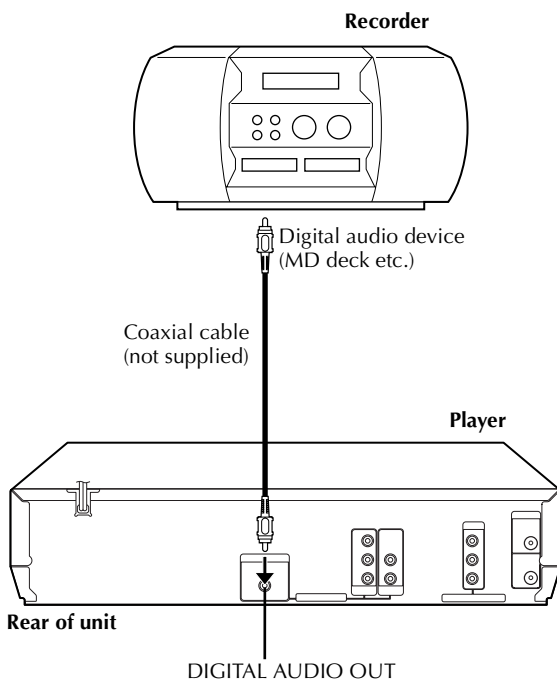

You can dub selected audio from the DVD or Audio CD disc to a MD etc.

However, it is not possible to dub the copy-protected disc.

Example: Dubbing to a MD

1 Make connections.

Connect the coaxial cable between the unit and the digital audio device.

2 Place a disc and load a MD.

For the DVD deck

For details, refer to "Placing a Disc" (☞ pg. 8).

For the digital audio device

Insert a MD.

3 Prepare the DVD deck for dubbing.

- 1 Press **DVD** and select the audio to be dubbed.
- 2 Search for the point where you want to start dubbing by pressing **▶ PLAY**, **FF ▶▶** or **◀◀ REW** then press **■ STOP**.
- 3 Press **◀◀ REW** a little, then press **▶ PLAY** to start playback.
- 4 Press **⏸ PAUSE** to pause playback a little before the start point.

4 Prepare the audio device for dubbing.

Select the input mode.

5 Start dubbing.

- 1 Press **▶ PLAY** to start playback on the DVD deck.
- 2 Start recording on the audio device.

6 End dubbing.

Stop recording on the audio device. Then press **■ STOP** to stop playback on the DVD deck.

NOTES:

- There may be a discrepancy of several seconds between where you intend editing to start, and where it actually starts.
- You can also dub a Video CD or SVCD. Set "DIGITAL AUDIO OUTPUT" to "PCM ONLY." (☞ pg. 62)

Remote Control Functions

Remote A/B/C/D Code Switching

The Remote is capable of controlling four JVC video units independently. Each of units can respond to one of four codes (A, B, C or D). The remote control is preset to send A code signals because your unit is initially set to respond to A code signals. You can easily modify your unit to respond to B, C or D code signals.

Before performing the following steps:

Slide the TV/VCR/DVD switch on the Remote to the right.

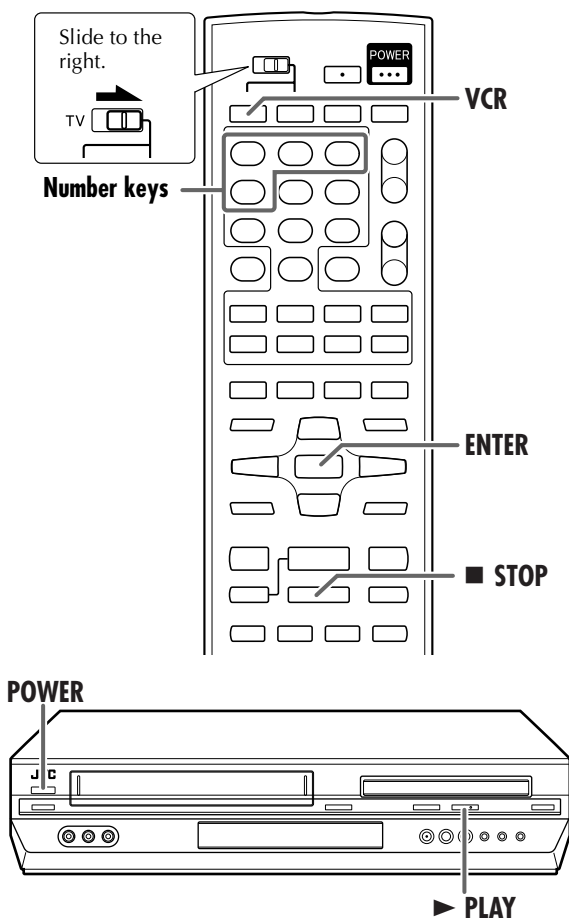

On the Remote

Keep pressing **VCR** down during steps **1** – **2**.

1 Change the remote control code.

Press the **number key "1"** for A, **"2"** for B, **"3"** for C or **"4"** for D.

2 Set the remote control code.

Press **ENTER** to set the code.

NOTE:

Once the batteries are removed, the remote control code is back to A.

On the unit

1 Turn off the unit.

Press **POWER** on the unit.

2 Display the code.

Press **▶ PLAY** on the unit for over 5 seconds while the unit is turned off. The code currently set appears on the front display panel.

- If the code displayed on the front display panel is different from the code set on the Remote, go to step **3**.

3 Change the unit's code.

Press **■ STOP** on the Remote. The code currently set on the Remote will be applied to the unit.

NOTE:

Even if you unplug the end of the mains power cord from the mains, the code currently set remains.

Connecting To A Dolby Digital Decoder or An Amplifier With A Built-in DTS (DVD deck only)

These instructions enable you to connect your unit to dolby digital decoder or amplifier with a built-in DTS.

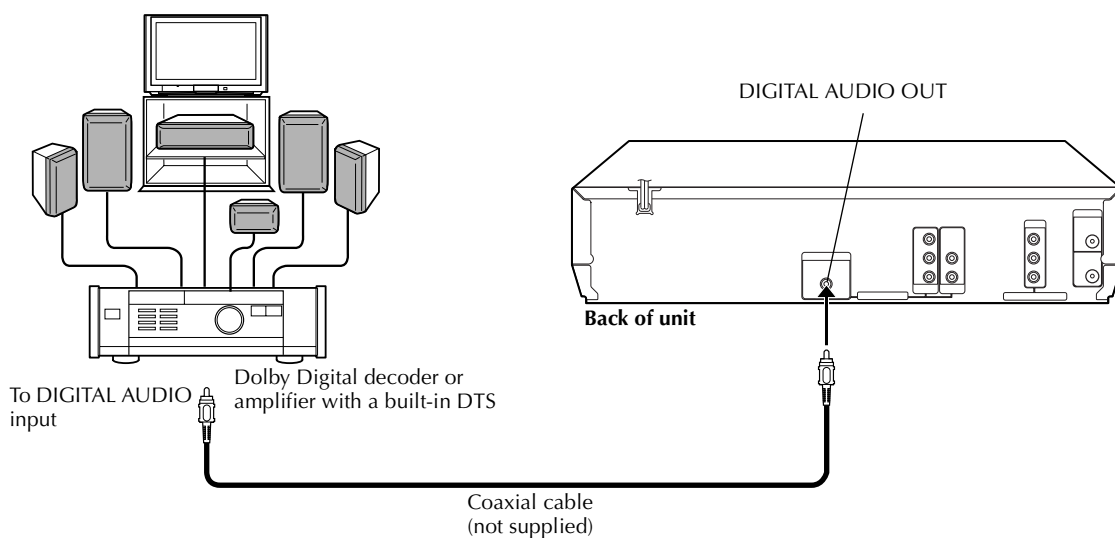

Make connections.

Connect the coaxial cable between the unit and the Dolby Digital decoder or amplifier with a built-in DTS.

NOTES:

- For Dolby digital sound, set "DIGITAL AUDIO OUTPUT" to "DOLBY DIGITAL/PCM." (☞ pg. 62)
- For DTS sound, set "DIGITAL AUDIO OUTPUT" to "STREAM/PCM." (☞ pg. 62)

CAUTIONS:

- This unit has a dynamic range of more than 80 dB with regards to its Hi-Fi audio capability. It is recommended that you check the maximum level if you are going to listen to the Hi-Fi audio signals through a stereo amplifier. A sudden surge in the input level to the speakers may damage them.
- Some speakers and televisions are specially shielded to prevent television interference. If both are of the non-shielded type, do not place the speakers adjacent to the TV set as this can adversely affect the video playback picture.

Mode Set

(VCR deck)

- Turn on the TV and select the VCR channel (or AV mode).
- Slide the TV/VCR/DVD switch on the Remote to the right.

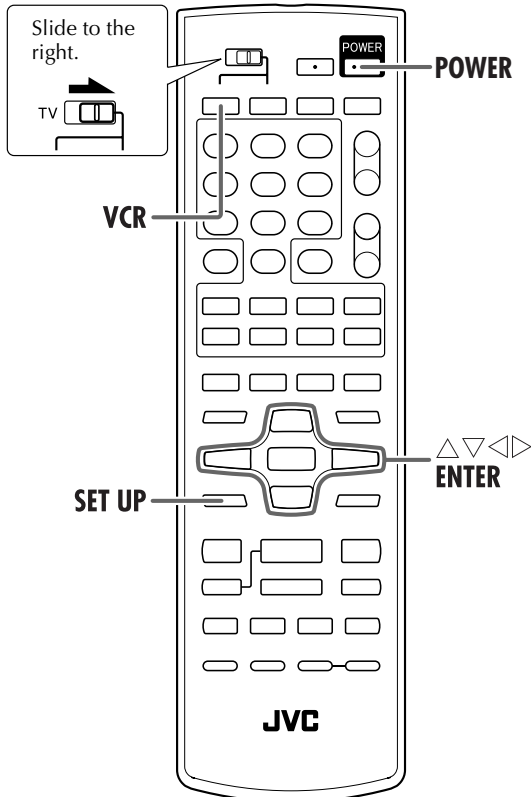

You can change various mode settings on the Function Set screen by following the procedure described below.

- For each mode setting, see pages 59 to 60.

1 Turn on the unit.

Press **POWER**.

2 Select the VCR deck.

On the unit

Press **VCR/DVD** repeatedly so that the VHS indicator lights up on the front display panel.

On the Remote

Press **VCR** so that the VHS indicator lights up on the front display panel.

3 Access the Main Menu screen.

Press **SET UP**.

4 Access the Function Set screen.

Press Δ / ∇ to move the highlight bar (arrow) to "FUNCTION SET," then press **ENTER** or \triangleright .

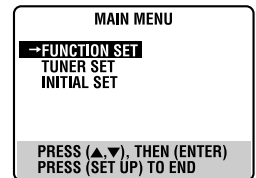

5 Select the mode.

Press Δ / ∇ to move the highlight bar (arrow) to the item you want to change.

FUNCTION	NORM
PICTURE CONTROL	NORM
SUPERIMPOSE	ON
AUTO SP-EP TIMER	OFF
VIDEO STABILIZER	OFF
BLUE BACK	ON
2ND AUDIO RECORD	OFF
NEXT PAGE	

SELECT WITH (Δ , ∇) → (ENTER)

PRESS (SET UP) TO END

PREVIOUS PAGE	HI-FI
→AUDIO MONITOR	HI-FI
AUTO POWER OFF	OFF

SELECT WITH (Δ , ∇) → (ENTER)

PRESS (SET UP) TO END

6 Select the mode setting.

Press **ENTER** or \triangleright .

7 Return to the normal screen.

Press **SET UP**.

* The default setting is **bold** in the table below.

<p>■ PICTURE CONTROL NORM EDIT SOFT SHARP</p>	<p>This feature helps you to adjust the playback picture quality according to your preference. Normally select "NORM."</p> <p>NORM: Picture quality is adjusted automatically.</p> <p>EDIT: Minimizes picture degradation during editing (recording and playback).</p> <p>SOFT: Reduces image coarseness when viewing overplayed tapes containing a lot of noise.</p> <p>SHARP: Clearer, sharper-edged picture when viewing images with lots of flat, same-colored surfaces such as cartoons.</p> <p>NOTES:</p> <ul style="list-style-type: none"> • When you select "EDIT," "SOFT" or "SHARP," the selected mode will not change until you select another mode. • When you select "EDIT" to dub tapes, be sure to select "NORM" after you finish dubbing the tapes. 				
<p>■ SUPERIMPOSE ON OFF</p>	<p>When this function is set to "ON," various operational indicators appear on the TV screen. Messages appear in the selected language. (📄 pg. 18)</p> <p>NOTES:</p> <ul style="list-style-type: none"> • When you use this unit as the source player for editing, be sure to set "SUPERIMPOSE" to "OFF" before starting. • During playback, the operation mode indicators may be disturbed depending on the type of tape being used. 				
<p>■ AUTO SP→EP TIMER ON OFF</p>	<p>When this function is set to "ON," the unit automatically switches to EP mode to allow complete recording if there is not enough tape to record the entire program while timer-recording in SP mode.</p> <p>For Example: Recording a program of 140 minutes in length onto a 120-minute tape</p> <table border="1" data-bbox="426 996 1016 1058"> <tr> <td style="text-align: center;">Approximately 110 minutes</td> <td style="text-align: center;">Approximately 30 minutes</td> </tr> <tr> <td style="text-align: center;">SP mode</td> <td style="text-align: center;">EP mode</td> </tr> </table> <p style="text-align: center;">Total 140 minutes</p> <p>Make sure you set this function to "ON," before the timer-recording starts.</p> <p>NOTES:</p> <ul style="list-style-type: none"> • If you have programed the unit to timer-record 2 or more programs, the second program and those thereafter may not fit on the tape if you set "AUTO SP→EP TIMER" to "ON." In this case, make sure the mode is not engaged, then set the tape speed manually during timer programing. • In order to ensure that the recording fits on the tape, this feature may leave a slight non-recorded section at the end of the tape. • There may be some noise and sound disturbance at the point on the tape where the unit switches from SP to EP mode. • The Auto SP→EP Timer feature is not available during ITR (Instant Timer Recording), and the feature will not work properly on the following tapes: T(ST)-30, T(ST)-60, T(ST)-90, and T(ST)-120. 	Approximately 110 minutes	Approximately 30 minutes	SP mode	EP mode
Approximately 110 minutes	Approximately 30 minutes				
SP mode	EP mode				

* The default setting is **bold** in the table below.

<p>■ VIDEO STABILIZER ON OFF</p>	<p>When this function is set to "ON," you can automatically correct vertical vibration in the picture when playing back unstable recordings made on another recorder.</p> <p>NOTES:</p> <ul style="list-style-type: none"> • When you finish viewing a tape, be sure to set this function to "OFF." • Regardless of the setting, this function has no effect during recording and during special effects playback. • The on-screen display may jitter vertically when this function is set to "ON." • To watch recordings with close-caption, set this function to "OFF."
<p>■ BLUE BACK ON OFF</p>	<p>When this function is set to "ON," the TV screen becomes all blue when receiving a channel not in use.</p> <p>NOTE: When you want to receive an unstable channel with poor signals, set this function to "OFF."</p>
<p>■ 2ND AUDIO RECORD ON OFF</p>	<ul style="list-style-type: none"> • When this function is set to "ON"; If a SAP program is received, the SAP audio is recorded on both the normal and Hi-Fi tracks. The main audio is not recorded. If a non-SAP program is received, the main audio is recorded on both the Hi-Fi and normal tracks. • When this function is set to "OFF," the SAP audio cannot be recorded. <p>NOTES: When the channel is changed on the unit;</p> <ul style="list-style-type: none"> • The "STEREO" indicator appears on the screen for about 5 seconds if the program is a stereo broadcast. • The "SAP" indicator appears on the screen for about 5 seconds if the program is a SAP broadcast. • Both indicators appear when a stereo program is accompanied by SAP sound.
<p>■ AUDIO MONITOR HI-FI HI-FI L HI-FI R NORM MIX</p>	<p>This unit can record two sound tracks simultaneously (normal and Hi-Fi) on a Hi-Fi stereo tape. You can select the sound track(s) to listen to while playing back a Hi-Fi stereo tape. In addition, when playing back a prerecorded tape containing two separate audio programs on the Hi-Fi tracks, you can choose either one by selecting either "HI-FI L" or "HI-FI R."</p> <p>HI-FI: Normally select this. Hi-Fi sound is played back. HI-FI L: Sound on the left Hi-Fi channel is played back. HI-FI R: Sound on the right Hi-Fi channel is played back. NORM: Sound on the normal track is played back. MIX: Both sounds on the Hi-Fi track and normal track are mixed and played back.</p> <p>NOTES:</p> <ul style="list-style-type: none"> • While playing back a monaural tape, sounds on the normal track will be heard regardless of this setting. • You can also use the A.MONITOR button on the Remote to select the desired monitor sound. (☞ pg. 30)
<p>■ AUTO POWER OFF 3H OFF</p>	<p>When this function is set to "3H," the unit is turned off automatically if no operation is done within 3 hours. "AUTO POWER OFF IN 3 MIN" appears on the screen 3 minutes before the unit is turned off.</p>

Mode Set

(DVD deck)

- Turn on the TV and select the VCR channel (or AV mode).
- Slide the TV/VCR/DVD switch on the Remote to the right.

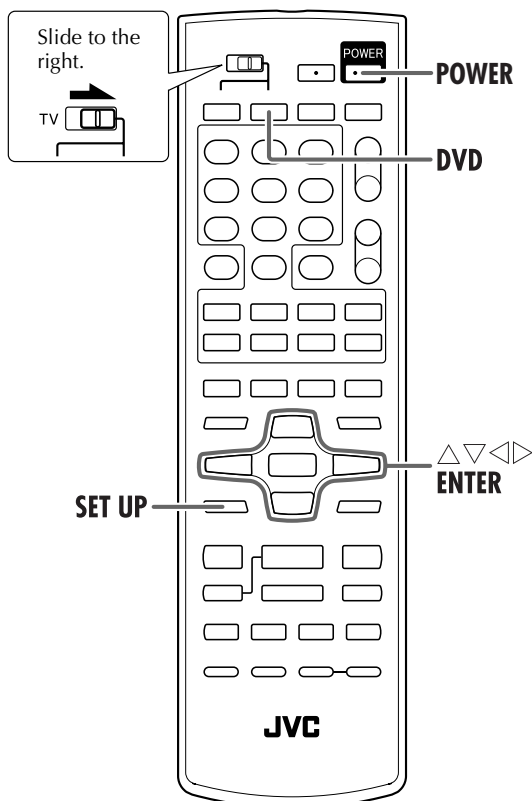

You can change various mode settings on the Mode Set screen by following the procedure described below.

- For each mode setting, see corresponding pages.

LANGUAGE	MENU LANGUAGE (pg. 20) AUDIO LANGUAGE (pg. 20) SUBTITLE (pg. 20) ON SCREEN LANGUAGE (pg. 19)
PICTURE	MONITOR TYPE (pg. 17, 62) PICTURE SOURCE (pg. 62) SCREEN SAVER (pg. 62) FILE TYPE (pg. 62)
AUDIO	DIGITAL AUDIO OUTPUT (pg. 62) DOWN MIX (pg. 63) D. RANGE COMPRESSION (pg. 63)
OTHERS	RESUME (pg. 64) ON SCREEN GUIDE (pg. 64)

- The procedure shows how to set “RESUME” to “ON” on the DVD Set Up menu screen as an example.

1 Turn on the unit.

Press **POWER**.

2 Select the DVD deck.

On the unit

Press **VCR/DVD** repeatedly so that the DVD indicator lights up on the front display panel.

On the Remote

Press **DVD** so that the DVD indicator lights up on the front display panel.

3 Access the DVD Set Up menu screen.

- 1 Press **SET UP**.
- 2 Press **◀ ▶** to select “OTHERS.”

- Each time you press the button, the setup menus change as follows;

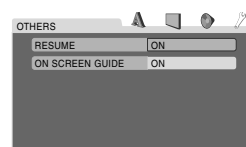

LANGUAGE → PICTURE → AUDIO → OTHERS → (Back to the beginning)

4 Select the mode.

Press **△▽** to move the highlight to “RESUME,” then press **ENTER**.

5 Select the mode setting.

Press **△▽** to select “ON,” then press **ENTER**.

6 Return to the normal screen.

Press **SET UP**.

Picture Settings

* The default setting is **bold** in the table below.

<p>■ MONITOR TYPE 16:9 4:3 LB 4:3 PS</p>	<p>You can select the monitor type depending the TV used when you play back DVD VIDEO discs recorded for wide-screen TVs. For more details, refer to "Monitor Set (DVD deck)" (☞ pg. 17)</p>
<p>■ PICTURE SOURCE AUTO FILM VIDEO</p>	<p>You can obtain optimal picture quality by selecting whether the content on the disc is processed by field (video source) or by frame (film source). Normally set to "AUTO."</p> <p>AUTO: Used to play back a disc containing both video and film source materials. This unit recognizes the picture type (film or video source) of the current disc according to the disc information.</p> <p>FILM: Suitable for playing back a film or progressive source disc.</p> <p>VIDEO: Suitable for playing back a video source disc with relatively a few moments.</p> <p>● If the playback picture is unclear or noisy, or the oblique lines of the picture are rough, try to change to other modes.</p>
<p>■ SCREEN SAVER ON OFF</p>	<p>The TV screen may be burned out if a static picture is displayed for a long time. When this function is set to "ON," the unit automatically activates the screen saver function if a static picture, such as an on-screen display or menu is displayed for over 5 minutes.</p>
<p>■ FILE TYPE AUDIO STILL PICTURE</p>	<p>You can select files to play back, when both MP3 files and JPEG files are recorded on a disc.</p> <p>AUDIO: Select this to play back MP3 files.</p> <p>STILL PICTURE: Select this to play back JPEG files.</p> <p>NOTE: Be sure to open and close the disc tray after changing the setting. The unit reads the disc again and the selected file type can be recognized.</p>

Audio Settings

* The default setting is **bold** in the table below.

<p>■ DIGITAL AUDIO OUTPUT PCM ONLY DOLBY DIGITAL/PCM STREAM/PCM</p>	<p>Set to the appropriate mode according to the type of the device connected to DIGITAL AUDIO OUT connector on the rear of unit. Set this item correctly according to the logo on the device. It is not necessary to set this mode when you connect no device to DIGITAL AUDIO OUT connector.</p> <p>PCM ONLY: Select this when connecting to a device bearing neither Dolby Digital nor DTS logo, or a digital recorder.</p> <p>DOLBY DIGITAL/PCM: Select this when connecting an amplifier or a decoder bearing Dolby Digital (without DTS) logo.</p> <p>STREAM/PCM: Select this when connecting an amplifier or a decoder bearing both Dolby Digital and DTS logos.</p>
---	---

<p>■ DOWN MIX DOLBY SURROUND STEREO</p>	<p>Set to the appropriate mode according to your audio system when you play back a DVD VIDEO disc recorded with surround multichannel audio. This setting affects only the analog audio output signal from the AUDIO OUTPUT connectors (DVD) when playing back a DVD VIDEO disc recorded with surround multichannel audio.</p> <p>DOLBY SURROUND: Select this when you enjoy multichannel surround audio by connecting the unit's analog AUDIO OUTPUT connector (DVD) to a surround decoder.</p> <p>STEREO: Select this when you enjoy conventional 2-channel stereo audio by connecting the unit's analog AUDIO OUTPUT connectors (DVD) to a stereo amplifier/receiver or TV, or when you dub audio of a DVD VIDEO disc recorded with surround audio to your MD, cassette, etc.</p>
<p>■ D. RANGE COMPRESSION AUTO ON</p>	<p>You can compress the dynamic range (the difference between the loudest and quietest audio signals) of the sound when listening to the sound at a low volume or at night. This function is available with DVD VIDEO discs recorded with the Dolby Digital format. Set to the appropriate mode according to the number of channels recorded.</p> <p>AUTO: Audio is played back with channels other than Dolby Digital channel 1 or 2 compressed.</p> <p>ON: Audio is played back with all channel compressed.</p>

Playback discs	Output		
	STREAM/PCM	DOLBY DIGITAL/PCM	PCM ONLY
DVD VIDEO with 48 kHz, 16/20/24 bit linear PCM	48 kHz, 16 bit linear PCM		
DVD VIDEO with DTS	DTS bitstream	44.1 kHz, 16 bit stereo linear PCM	
DVD VIDEO with Dolby Digital	Dolby Digital bitstream		48 kHz, 16 bit stereo linear PCM
Audio CD/Video CD	44.1 kHz, 16 bit stereo linear PCM		
Audio CD with DTS	DTS bitstream	44.1 kHz, 16 bit stereo linear PCM	
MP3 disc	Linear PCM		

NOTES:

- The unit is not equipped with the DTS 5.1 channel decoding function.
- When you play back a DVD VIDEO or Audio CD disc with DTS, use a DTS decoder to get correct signals from your speakers. Never use the unit's analog output connectors, which output incorrect signals that may damage your speakers.
- If you connect the analog outputs and digital outputs simultaneously, be sure to select the source of the amplifier correctly, or set the level control of the amplifier connected to the analog outputs to minimum.

Others Settings

* The default setting is **bold** in the table below.

<p>■ RESUME ON OFF</p>	<p>When this function is set to "ON," you can use the resume function. (☞ pg. 40)</p> <p>ON: The unit resumes playback from the position where playback has been stopped.</p> <p>OFF: This function is deactivated.</p> <p>NOTE: This function is not available for Audio CDs and MP3 discs.</p>
<p>■ ON SCREEN GUIDE ON OFF</p>	<p>When this function is set to "ON," the unit can display "on-screen guide" icons or characters which shows the conditions of the unit or disc.</p>

Child Lock

- Turn on the TV and select the VCR channel (or AV mode).
- Slide the **TV/VCR/DVD** switch on the Remote to the right.

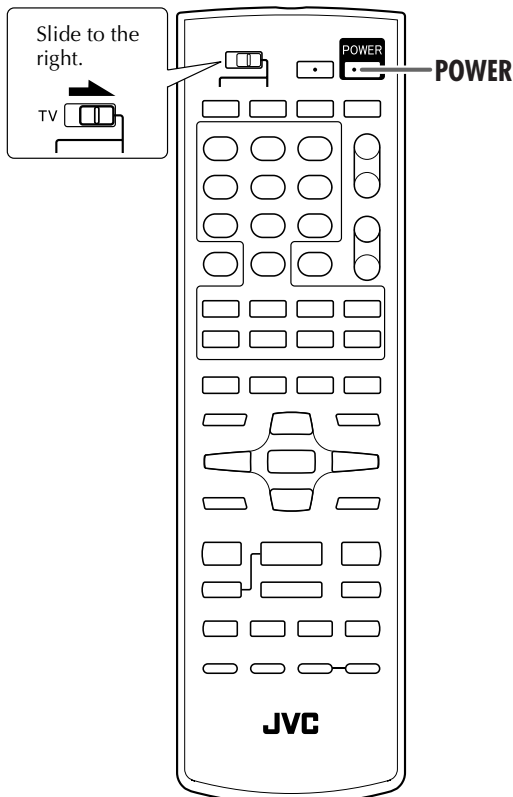

You can disable the unit's operation.

1 Set the Child Lock.

Press and hold **POWER** on the Remote for more than 10 seconds while the unit is turned on. The unit turns off, and "CL" appears on the front display panel.



- To release the child lock, press and hold **POWER** on the Remote until the unit turns on.

NOTES:

- When the child lock function is in use, keep the Remote out of the children's reach.
- Timer recording programs will be performed even if the child lock function is activated.

Before requesting service for a problem, use this chart and see if you can repair the trouble yourself. Small problems are often easily corrected, and this can save you the trouble of sending your unit off for repair.

Power

SYMPTOM	POSSIBLE CAUSE	CORRECTIVE ACTION
1. No power is supplied to the unit.	• The AC power cord is disconnected.	Connect the AC power cord.
2. The Remote won't function.	• The batteries are discharged.	Replace the dead batteries with new ones.

Tape Transport (VCR deck)

SYMPTOM	POSSIBLE CAUSE	CORRECTIVE ACTION
1. During recording, the tape does not run. The counter display blinks on the front display panel.	• The unit is in the Record Pause mode.	Press ► PLAY to resume recording.
2. The tape will not rewind or fast-forward.	• The tape is already fully rewound or fast-forwarded.	Check the cassette.

Playback (VCR deck)

SYMPTOM	POSSIBLE CAUSE	CORRECTIVE ACTION
1. The VCR deck can not be operated.	• The VCR deck is not selected.	On the unit Press VCR/DVD repeatedly so that the VHS indicator lights up on the front display panel. On the Remote Press VCR so that the VHS indicator lights up on the front display panel.
2. The playback picture does not appear while the tape is running.	• If you are using the RF connection, — the TV receiver's channel selector is not set to the VCR channel. — the unit's VCR channel has not been correctly set. • If you are using the AV or Component Video* connection, the TV receiver is not set to the AV mode. * (DVD deck only)	If you are using the RF connection, — set the TV receiver to the VCR channel. — perform "Set the VCR channel." (☞ pg. 13). If you are using the AV or Component Video* connection, set the TV to its AV mode. * (DVD deck only)
3. Noise appears during visual search.	• This is normal.	
4. Noise appears during normal playback.	• The automatic tracking mode is engaged.	Try manual tracking. (☞ pg. 30)
5. The playback picture is blurred or interrupted while TV broadcasts are clear or "USE CLEANING CASSETTE" message appears on the screen.	• The video heads may be dirty.	Use a dry cleaning cassette ECL-3F, or consult your JVC dealer.
6. Breaks are noticeable in Hi-Fi soundtrack.	• The automatic tracking mode is engaged.	Try manual tracking. (☞ pg. 30)

Playback (DVD deck)

SYMPTOM	POSSIBLE CAUSE	CORRECTIVE ACTION
1. The button do not work.	<ul style="list-style-type: none"> The operation is prohibited on the placed disc. 	—
2. The DVD deck can not be operated.	<ul style="list-style-type: none"> The DVD deck is not selected. 	<p>On the unit Press VCR/DVD repeatedly so that the DVD indicator lights up on the front display panel.</p> <p>On the Remote Press DVD so that the DVD indicator lights up on the front display panel.</p>
3. "Ⓞ" appears on the TV screen.	<ul style="list-style-type: none"> The operation is prohibited on the placed disc. 	—
4. "REGION CODE ERROR!" appears on the TV screen.	<ul style="list-style-type: none"> The disc's region number does not match that of the unit. 	Use the discs whose region number includes "ALL" or "1." (ⓘ pg. 7)
5. The disc cannot be played back.	<ul style="list-style-type: none"> The disc's region number does not match that of the unit. This type of the disc cannot be played back. The disc is not placed properly. 	<p>Use the discs whose region number includes "ALL" or "1." (ⓘ pg. 7)</p> <p>See "Unplayable Discs" (ⓘ pg. 7).</p> <p>Remove the disc, then place the disc properly in the disc tray. (ⓘ pg. 8, "Placing a Disc")</p>
6. The language is not played back as you set.	<ul style="list-style-type: none"> The disc does not contain the language you set. 	—
7. Changing audio/subtitle language is not possible.	<ul style="list-style-type: none"> The disc does not contain the audio/subtitle in the multiple languages. 	With some discs, the language should be set on the top menu. (ⓘ pg. 41)
8. The subtitles do not appears on the TV screen.	<ul style="list-style-type: none"> The disc does not contain the subtitles. The subtitle display is set to off. A-B Repeat Playback is in progress. (ⓘ pg. 43) 	<p>—</p> <p>Set the subtitles display to on. (ⓘ pg. 44)</p> <p>The subtitles recorded around A-B point may not appear.</p>
9. Angle cannot be changed.	<ul style="list-style-type: none"> The scene is not recorded from the multiple angles. 	—

MP3/JPEG Files Playback (DVD deck)

SYMPTOM	POSSIBLE CAUSE	CORRECTIVE ACTION
1. A disc cannot be played.	<ul style="list-style-type: none"> • No MP3/JPEG files are recorded to the disc. • Files do not have the correct file extension in their file names. • Files are not recorded in a format compliant with ISO 9660. • The different types of files are recorded to the disc. 	<p>Replace the disc.</p> <p>Add correct file extension (.mp3, .MP3, .jpg, .jpeg, .JPG, .JPEG, or any uppercase and lowercase combination) to their file names.</p> <p>Replace the disc. (Record files using a compliant application.)</p> <p>The disc which contains the different types of files may not be played because of its disc characteristics or recording conditions.</p>
2. When playing back a disc which contains both MP3 files and JPEG files, either MP3 files or JPEG files are played.	<ul style="list-style-type: none"> • When playing back a disc which contains both MP3 files and JPEG files, the selected files in the "FILE TYPE" setting are played back . 	<p>Set "FILE TYPE" to either "AUDIO" (for MP3 files) or "STILL PICTURE" (for JPEG files) which you want to play back beforehand. (ⓘ pg. 62)</p>
3. The control display appears on the TV screen, but no operation can be performed.	<ul style="list-style-type: none"> • No MP3 files or JPEG files are recorded to the disc, or the disc is an unplayable disc (such as CD-ROM). 	<p>Replace the disc. (ⓘ pg. 8)</p>

RECORDING (VCR deck)

SYMPTOM	POSSIBLE CAUSE	CORRECTIVE ACTION
1. Recording cannot be started.	<ul style="list-style-type: none"> • There is no cassette loaded, or the cassette loaded has had its record safety tab removed. 	<p>Insert a cassette, or using adhesive tape, cover the hole where the tab was removed.</p>
2. TV broadcasts cannot be recorded.	<ul style="list-style-type: none"> • "F-1" has been selected as the input mode. 	<p>Set to the desired channel.</p>
3. Tape-to-tape editing is not possible.	<ul style="list-style-type: none"> • The source (another video recorder, camcorder) has not been properly connected. • All necessary power switches have not been turned on. • The input mode is not correct. 	<p>Confirm that the source is properly connected.</p> <p>Confirm that all units' power switches are turned on.</p> <p>Set the input mode to "F-1."</p>
4. Camcorder recording is not possible.	<ul style="list-style-type: none"> • The camcorder has not been properly connected. • The input mode is not correct. 	<p>Confirm that the camcorder is properly connected.</p> <p>Set the input mode to "F-1."</p>
5. "○" and "▷" on the front display panel won't stop blinking.	<ul style="list-style-type: none"> • The end of the tape was reached during recording. 	<p>The program may not have been recorded in its entirety. Next time make sure you have enough time on the tape to record the entire program.</p>

TIMER RECORDING (VCR deck)

SYMPTOM	POSSIBLE CAUSE	CORRECTIVE ACTION
1. Timer recording won't work.	<ul style="list-style-type: none"> • The clock and/or the timer have been set incorrectly. • The timer is not engaged. 	<p>Re-perform the clock and/or timer settings.</p> <p>Press TIMER and confirm that "Ⓞ" is displayed on the front display panel.</p>
2. Timer programming is not possible.	<ul style="list-style-type: none"> • Timer recording is in progress. 	<p>Timer programming can't be performed while a timer recording is in progress. Wait until it finishes.</p>

SYMPTOM	POSSIBLE CAUSE	CORRECTIVE ACTION
3. "⊗" on the front display panel won't stop blinking.	<ul style="list-style-type: none"> ● The timer is engaged but there's no cassette loaded. ● The loaded cassette has had its record safety tab removed. 	<p>Load a cassette with the record safety tab intact.</p> <p>Remove the cassette and cover the hole with adhesive tape, or insert a cassette with the record safety tab intact.</p>
4. "⊗", "○" and "▷" on the front display panel won't stop blinking.	<ul style="list-style-type: none"> ● The end of the tape was reached during timer recording. 	<p>The program may not have been recorded in its entirety. Next time make sure you have enough time on the tape to record the entire program.</p>
5. "⊗" blinks for 10 seconds and the Timer mode is disengaged.	<ul style="list-style-type: none"> ● TIMER has been pressed when there are no programs in memory, or the timer record information has been programmed incorrectly. 	<p>Check the programmed data and re-program as necessary, then press TIMER again.</p>
6. "○" and "▷" on the front display panel won't stop blinking.	<ul style="list-style-type: none"> ● The end of the tape was reached during Instant Timer Recording. 	<p>The program may not have been recorded in its entirety. Next time make sure you have enough time on the tape to record the entire program.</p>
7. "⊗", "○" and "▷" on the front display panel won't stop blinking.	<ul style="list-style-type: none"> ● The Satellite Auto Recording mode is engaged but there is no cassette loaded. ● The loaded cassette has had its record safety tab removed. ● The end of the tape was reached during Satellite Auto Recording. 	<p>Load a cassette with the record safety tab intact.</p> <p>Remove the cassette and cover the hole with adhesive tape, or insert a cassette with the record safety tab intact.</p> <p>The program may not have been recorded in its entirety. Next time make sure you have enough time on the tape to record the entire program.</p>

OTHER PROBLEMS

SYMPTOM	POSSIBLE CAUSE	CORRECTIVE ACTION
1. The image of TV broadcast appears distorted on the TV screen.	<ul style="list-style-type: none"> • The unit leaves turned on and the DVD deck is selected. 	Turn off the unit, or press VCR to select the VCR deck, then press TV/VCR so that the VHS indicator disappears from the front display panel.
2. Whistling or howling is heard from the TV during camcorder recording.	<ul style="list-style-type: none"> • The camcorder's microphone is too close to the TV. • The TV's volume is too high. 	Position the camcorder so its microphone is away from the TV. Turn the TV's volume down.
3. When scanning channels, some of them are skipped over.	<ul style="list-style-type: none"> • Those channels have been designated to be skipped. 	If you need the skipped channels, restore them. (☞ pg. 25)
4. The channel cannot be changed.	<ul style="list-style-type: none"> • Recording is in progress. 	Press II PAUSE to pause the recording, change channels, then press ▶ PLAY to resume recording.
5. Channel settings that were made manually seem to have changed or disappeared.	<ul style="list-style-type: none"> • After the manual settings were made, Auto Channel Set was performed. 	Perform manual setting again.
6. Even though Auto or Semiauto Clock Set has been performed, the clock is incorrect.	<ul style="list-style-type: none"> • The clock setting data received from the host channel is incorrect. 	Select a different host channel during "Semiauto Clock Set" (☞ pg. 23), or perform "Manual Clock Set" (☞ pg. 23).

ATTENTION

This unit contains microcomputers. External electronic noise or interference could cause malfunctioning. In such cases, switch the unit off and unplug the AC power cord. Then plug it in again and turn the unit on. Take out the cassette. After checking the cassette, operate the unit as usual.

Tray Lock

You can lock the disc tray to prohibit the unwanted disc ejection by children.

To lock the disc tray.

While the unit is turned off, press and hold **■ STOP**, then press **▲ OPEN/CLOSE** on the unit. "LOCK" appears on the front display panel and the disc tray is locked.

To unlock tray

While the unit is turned off, press and hold **■ STOP**, then press **▲ OPEN/CLOSE** on the unit. "UNLOCK" appears on the display panel.

PLAYBACK

Q. What happens if the end of the tape is reached during playback or search?

A. The tape is automatically rewound to the beginning.

Q. During search, slow, still and frame-by-frame playback, I can't hear any audio. What's the problem?

A. This is normal.

Q. Can the unit indefinitely remain in the still mode?

A. No. It stops automatically after 5 minutes to protect the heads.

Q. When returning from search to normal playback, the picture is disturbed. Should I be concerned about this?

A. No, it is normal.

Q. Noise bar appear during search. What's the problem?

A. This is normal.

Q. Sometimes, during Index Search, the unit can't find the program I want to see. Why not?

A. There may be index codes too close together.

RECORDING

Q. When I pause and then resume a recording, the end of the recording before the pause is overlapped by the beginning of the continuation of recording. Why does this happen?

A. This is normal. It reduces distortion at the pause and resume points.

Q. Can the unit indefinitely remain in the Record-Pause mode?

A. No. The unit goes to its Stop mode automatically after 5 minutes to protect the heads.

Q. What happens if the tape runs out during recording?

A. The unit stops recording, and "○" and "▷" on the front display panel won't stop blinking.

TIMER RECORDING

Q. "○" and "⊖" remain lit on the front display panel. Is there a problem?

A. No. This is a normal condition for a timer recording in progress.

Q. Can I program the timer while I'm watching a tape or a TV broadcast?

A. You won't see the picture as it is replaced by the on-screen menu, but the audio from the program or tape you're viewing can be heard.

GENERAL

Power requirement : AC 120 V ~ , 60 Hz
 Power consumption
 Power on : 25 W
 Power off : 2.0 W
 Temperature
 Operating : 5°C to 40°C (41°F to 104°F)
 Storage : -20°C to 60°C (-4°F to 140°F)
 Operating position : Horizontal only
 Dimensions (WxHxD)
 : 435 mm x 93 mm x 272 mm
 Weight : 4.1 kg
 Format : VHS NTSC standard
 Maximum recording time
 (SP) : 210 min. with T-210 video cassette
 (EP) : 630 min. with T-210 video cassette

VIDEO/AUDIO (VCR deck)

Signal system : NTSC color signal and EIA monochrome signal, 525 lines/60 fields
 Recording system : DA4 (Double Azimuth) head helical scan system
 Signal-to-noise ratio: 45 dB
 Horizontal resolution : 230 lines
 Frequency range : 70 Hz to 10,000 Hz (Normal audio)
 20 Hz to 20,000 Hz (Hi-Fi audio)
 Input/Output : RCA connectors:
 IN x 1, OUT x 1

VIDEO/AUDIO (DVD deck)

Signal system : NTSC
 Applicable disc : DVD (12 cm, 8 cm)
 CD (12 cm, 8 cm)
 Audio characteristics
 DVD : 4 Hz – 22 KHz
 Frequency response
 CD : 4 Hz – 20 KHz
 S/N Ratio : 90 dB
 Harmonic distortion : 0.1 %
 Wow and flutter : Below Measurable Level
 Dynamic range : 90 dB
 Output
 Component-Y : (RCA) 1.0 Vp-p/75 ohm
 Component-PB/PR : (RCA) 0.7 Vp-p/75 ohm
 Audio : (RCA) 2 Vrms, 1 Kohm
 Digital Audio : (COAXIAL) 0.5 Vp-p/75 ohm

TUNER

Tuning system : Frequency synthesized tuner
 Channel coverage
 VHF : Channels 2 – 13
 UHF : Channels 14 – 69
 CATV : 113 Channels
 RF output : Channel 3 or 4 (switchable; preset to Channel 3 when shipped)
 75 ohms, unbalanced

TIMER

Clock reference : Quartz
 Program capacity : 1-year programmable timer/
 8 programs

ACCESSORIES

Provided accessories
 : RF cable,
 Infrared remote control unit,
 "AA" battery x 2

Specifications shown are for SP mode unless otherwise specified.
 E. & O.E. Design and specifications subject to change without notice.

A		M	
A-B Repeat Playback	43	Manual Clock Set	23
About Discs		Manual Tracking	30
Placing a Disc	8	Mode Set (DVD deck)	
Playable Discs	7	AUDIO LANGUAGE	20
Region Number	7	D. RANGE COMPRESSION	63
Unplayable Discs	7	DIGITAL AUDIO OUTPUT	62
Angle Selection	45	DOWN MIX	63
Audio Language and Sound Selection	45	FILE TYPE	62
Auto Channel Set	24	MENU LANGUAGE	20
C		MONITOR TYPE	17, 62
Check, cancel and change programs	36	ON SCREEN GUIDE	64
Child Lock	64	ON SCREEN LANGUAGE	19
Clock Set	22	PICTURE SOURCE	62
Component Video Connection	14	RESUME	64
Connecting To A Dolby Digital Decoder or An Amplifier		SCREEN SAVER	62
With A Built-in DTS	57	SUBTITLE	20
Control display	49	Mode Set (VCR deck)	
E		2ND AUDIO RECORD	60
EDITING (DVD DECK)		AUDIO MONITOR	60
Digital Audio Dubbing	55	AUTO POWER OFF	60
EDITING (VCR DECK)		AUTO SP→EP TIMER	59
Dubbing (from DVD to VCR)	54	BLUE BACK	60
Edit From A Camcorder	52	PICTURE CONTROL	59
EDITING (VCR)		SUPERIMPOSE	59
Edit To Or From Another Video Recorder	53	VIDEO STABILIZER	60
Elapsed Recording Time Indication	33	Monitor Set (DVD deck)	
Express Timer Programming	34	MONITOR TYPE	17, 62
G		N	
Group/File Selection	51	Next Function Memory	29
I		O	
INDEX	9	One Touch Replay	29, 42
Index Search	28	OPERATIONS ON DVD DECK	40 – 51
Instant ReView	28	OPERATIONS ON VCR DECK	26 – 39
Instant Timer Recording (ITR)	32	P	
L		Pan&Scan	17
Language	18	Playback (DVD deck)	40 – 51
Language Code List	21	Playback (MP3/JPEG files)	49 – 51
Menu/Audio/Subtitle Language Set		Playback (VCR deck)	26 – 30
(DVD deck only)	20	Playback Control (PBC) Function	41
On-screen Language Set (DVD deck)	19	Plug&Play Set	16
On-screen Language Set (VCR deck)	18	R	
Letter Box	17	Record One Program While Watching Another	32
Locating the Start Point of the Item or Skip the Item ...	41	Recording	31 – 33
		Region Number	7
		Remote Control Functions	56
		Repeat Playback	29, 43, 51

S

Satellite Auto Recording	39
Scan Mode Set (DVD deck only)	15
Second Audio Recording	33
Semiauto Clock Set	23
Skip Search	28
Slow Motion	27, 42
Sound Effect	46
Soundtrack Selection	30
Still Picture/Frame-By-Frame Playback	27, 42
Subtitle Selection	44

T

Tape Position Indicator	11
Tape Remaining Time	33
Time Search	44
Timer Recording	34 – 39
Tuner Set	24

V

Variable Speed Search	27, 42
VFP function	46

W

When programs overlap each other	38
--	----

Z

Zooming	42, 51
---------------	--------

JVC

Free Manuals Download Website

<http://myh66.com>

<http://usermanuals.us>

<http://www.somanuals.com>

<http://www.4manuals.cc>

<http://www.manual-lib.com>

<http://www.404manual.com>

<http://www.luxmanual.com>

<http://aubethermostatmanual.com>

Golf course search by state

<http://golfingnear.com>

Email search by domain

<http://emailbydomain.com>

Auto manuals search

<http://auto.somanuals.com>

TV manuals search

<http://tv.somanuals.com>