

JVC



Introduction

DVD PLAYER & VIDEO CASSETTE RECORDER

Preparation

HR-XVC32SUJ

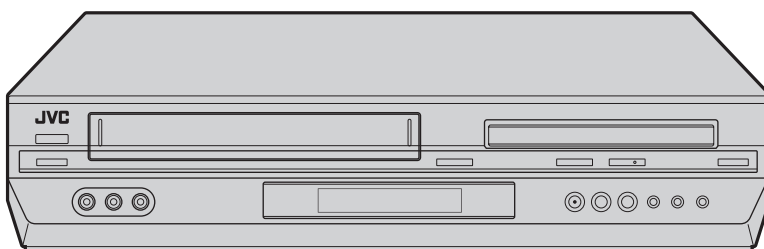

Operations on
VCR Deck

Operations on
DVD Deck

Hi-Fi

VHS

SQPB

DVD
VIDEO

dt
2.0+DIGITAL OUT

DOLBY
DIGITAL

COMPACT
disc
DIGITAL VIDEO

COMPACT
disc
DIGITAL AUDIO

COMPACT
disc
SUPER VIDEO

Advanced Operations

INSTRUCTIONS

Additional Information

LPT1042-001A

*Enjoy Playback of DVD & Video Cassette
All in This Combo Unit*



Region code of DVD VIDEO

This unit can play back DVD VIDEO discs whose region code numbers include "1."

Examples of playable DVD VIDEO discs:



The unit's region code is printed on the rear of the unit.

Supplied accessories

If anything is missing, consult your dealer immediately.

- RF cable
- Remote
- "AA" battery x 2
- Conversion plug



Introduction

SAFETY FIRST 4
Buttons, Connectors, and Indicators 7

Preparation

Connections 9
 Basic Connections 9
 Component Video Connection 10
Initial Settings 11
 Plug&Play Set 11
 Monitor Set (DVD deck) 12
 Language Set 12
 Clock Set 14
 Tuner Set 15

Operations on VCR Deck

Playback on VCR Deck 16
 Basic Playback 16
 Playback Features 18
Recording 20
 Basic Recording 20
 Recording Features 20
Timer Recording 21
 Express Timer Programming 21
 Satellite Auto Recording 23

Operations on DVD Deck

Playback on DVD Deck 24
 Basic Playback 24
 Playback Features 24
 Menu Bar Functions 26
 MP3/JPEG Files Playback 27

Advanced Operations

Editing 28
 Editing with another video recorder
 or a camcorder 28
 Dubbing from DVD to VCR 29
System Connections 30
Other Functions 31
Subsidiary Settings 32
 Mode Set (VCR deck) 32
 Mode Set (DVD deck) 34

Additional Information

Troubleshooting 36
Questions & Answers 37
Language Code List 38
Specifications 38
List of Terms 39

Dear Customer,

Thank you for purchasing the JVC DVD player & VHS video cassette recorder. Before use, please read the safety information and precautions to ensure safe use of your new unit.

IMPORTANT

- Please read the various precautions on page 4 and 5 before installing or operating the unit.
- It may be unlawful to record or play back copyrighted material without the consent of the copyright owner.

SAFETY FIRST

CAUTIONS

WARNING: DANGEROUS VOLTAGE INSIDE
WARNING: TO PREVENT FIRE OR SHOCK HAZARD, DO NOT EXPOSE THIS UNIT TO RAIN OR MOISTURE.

The POWER ϕ /I button does not completely shut off mains power from the unit, but switches operating current on and off. " ϕ " shows electrical power standby and "I" shows ON.

CAUTION:
A DVD/VCR IS A CLASS 1 LASER PRODUCT. HOWEVER THIS DVD/VCR USES A VISIBLE LASER BEAM WHICH COULD CAUSE HAZARDOUS RADIATION EXPOSURE IF DIRECTED. BE SURE TO OPERATE THE UNIT CORRECTLY AS INSTRUCTED. WHEN THIS DVD/VCR IS PLUGGED INTO THE WALL OUTLET, DO NOT PLACE YOUR EYES CLOSE TO THE OPENING OF THE DISC TRAY AND OTHER OPENINGS TO LOOK INTO THE INSIDE OF THIS DVD/VCR. USE OF CONTROLS OR ADJUSTMENTS OR PERFORMANCE OF PROCEDURES OTHER THAN THOSE SPECIFIED HEREIN MAY RESULT IN HAZARDOUS RADIATION EXPOSURE. DO NOT OPEN COVERS AND DO NOT REPAIR YOURSELF. REFER SERVICING TO QUALIFIED PERSONNEL.

CAUTION

- When you are not using the unit for a long period of time, it is recommended that you disconnect the power cord from the AC outlet.
- Dangerous voltage inside. Refer internal servicing to qualified service personnel. To prevent electric shock or fire hazard, remove the power cord from the AC outlet prior to connecting or disconnecting any signal lead or aerial.
- Changes or modifications not approved by JVC could void user's authority to operate the equipment.

The rating plate and safety caution are on the rear of the unit.

This unit is produced to comply with Standard IEC 60065.

POWER SYSTEM:

This set operates on voltage of AC 110 – 220V ~, 50/60 Hz with automatic switching.

Use the conversion plug (provided) depending on the type of your AC WALL outlet.

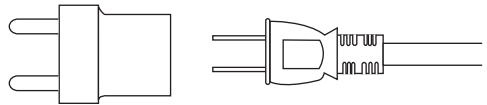

CLASS 1 LASER PRODUCT
REPRODUCTION OF LABELS
WARNING LABEL INSIDE OF THE UNIT

CAUTION: Visible and invisible laser radiation when open and interlock failed or defeated. AVOID DIRECT EXPOSURE TO BEAM.	ADVARSEL: Synlig og usynlig laserstråling når maskinen er åben eller interlocken fejler. Undgå direkte eksponering til strålingen.	WARNING : Synlig och osynlig laserstråling när den öppnas och spårren är urkopplad. Betrakta ej strålen.	VARO: Avattaessa ja suojauslaitus ohitettuna tai viallisena olet alttiina näkyvälle ja näkymättömälle lasersäteilylle. Vältä säteeen kohdistumista suoraan itseesi.
(e)	(d)	(s)	(f)

LP41077-001A

When the equipment is installed in a cabinet or a shelf, make sure that it has sufficient space on all sides to allow for ventilation (10 cm or more on both sides, on top and at the rear.)

When discarding batteries, environmental problems must be considered and the local rules or laws governing the disposal of these batteries must be followed strictly.



- Manufactured under license from Dolby Laboratories. “Dolby” and the double-D symbol are trademarks of Dolby Laboratories.
- “DTS” and “DTS 2.0 + Digital Out” are trademarks of Digital Theater Systems, Inc.
- Cassettes marked “VHS” (or “S-VHS”) can be used with this unit. However, S-VHS recording is not possible with this model.
- This model is equipped with SQPB (S-VHS QUASI PLAYBACK) that makes it possible to play back S-VHS recordings with regular VHS resolution.
- HQ VHS is compatible with existing VHS equipment.
- This product incorporates copyright protection technology that is protected by U.S. patents and other intellectual property rights. Use of this copyright protection technology must be authorized by Macrovision, and is intended for home and other limited viewing uses only unless otherwise authorized by Macrovision. Reverse engineering or disassembly is prohibited.

Failure to heed the following precautions may result in damage to the unit, Remote or video cassette.

1. **DO NOT place the unit —**
 - in an environment prone to extreme temperatures or humidity.
 - in direct sunlight.
 - in a dusty environment.
 - in an environment where strong magnetic fields are generated.
 - on a surface that is unstable or subject to vibration.
2. **DO NOT block the unit’s ventilation openings or holes.**
(If the ventilation openings or holes are blocked by a newspaper or cloth, etc., the heat may not be able to get out.)
3. **DO NOT place heavy objects on the unit or Remote.**
4. **DO NOT place anything which might spill on top of the unit or Remote.**
(If water or liquid is allowed to enter this equipment, fire or electric shock may be caused.)
5. **DO NOT expose the apparatus to dripping or splashing.**
6. **DO NOT use this equipment in a bathroom or places with water. Also DO NOT place any containers filled with water or liquids (such as cosmetics or medicines, flower vases, potted plants, cups, etc.) on top of this unit.**
7. **DO NOT place any naked flame sources, such as lighted candles, on the apparatus.**
8. **AVOID violent shocks to the unit during transport.**

MOISTURE CONDENSATION

Moisture in the air will condense on the unit when you move it from a cold place to a warm place, or under extremely humid conditions—just as water droplets form in the surface of a glass filled with cold liquid. Moisture condensation on the head drum will cause damage to the tape. In conditions where condensation may occur, keep the unit turned on for a few hours to let the moisture dry.

ATTENTION

To mobile phone users:

Using a mobile phone in the vicinity of the unit may cause picture vibration on the TV screen or change the screen to a blue back display.

On placing the unit:

Some TVs or other appliances generates strong magnetic fields. Do not place such appliance on top of the unit as it may cause picture disturbance.

Video heads cleaning

The heads get dirty in the following cases:

- in an environment prone to extreme temperature or humidity
- in a dusty environment
- flaw, dirt or mold on video tapes
- continuous usage for a long time

Use a dry cleaning cassette — ECL-3F — when:

- Rough, poor picture appears while a tape is played back.
- The picture is unclear or no picture appears.
- “USE CLEANING CASSETTE” appears on the screen (only with “SUPERIMPOSE” set to “ON” (pg. 32)).

BEFORE YOU INSTALL YOUR NEW UNIT . . .

- . . . **please read** the sections/literature listed below.
- “CAUTIONS” on page 4.

HOW TO USE THIS INSTRUCTION MANUAL

- All major sections and subsections are listed in the Table Of Contents on page 3. Use this when searching for information on a specific procedure or feature.
- Buttons, connectors, and indicators on the front and rear panel, the front display panel, and the Remote are illustrated on pages 7 and 8.
- The  mark signals a reference to another page for instructions or related information.
- Operation buttons necessary for the various procedures are indicated through the use of illustrations at the bottom of pages.

Usable cassette

Full-Size VHS

T-30 (ST-30**)
T-60 (ST-60**)
T90
T-120 (ST-120**)
T-160 (ST-160**)
ST-210**

Compact VHS*

TC-20 (ST-C20**)
TC-30 (ST-C30**)
TC-40 (ST-C40**)

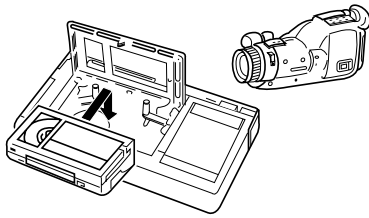

- * Compact VHS camcorder recordings can be played on this unit. Simply place the recorded cassette into a VHS Cassette Adapter and it can be used just like any full-sized VHS cassette.
- ** This unit can record on regular VHS and Super VHS cassettes. However, it will record regular VHS signals only.
 - S-VHS recording is not possible with this unit.
 - This unit is equipped with SQPB (S-VHS QUASI PLAYBACK) that lets you watch tapes recorded in the S-VHS format with regular VHS resolution.
 - SQPB does not deliver Super VHS resolution.

Playable discs

- DVD VIDEO, Audio CD, Video CD, SVCD (8 cm/12 cm disc)



- DVD-R/-RW written in the DVD VIDEO mode
- CD-R/RW written in the SVCD, Video CD or Audio CD format
- CD-R/RW written in MP3/JPEG in accordance with the "ISO 9660" format

Supported Digital audio formats:

Linear PCM, Dolby Digital, DTS (Digital Theater Systems)*

NOTES

- If a disc gets dirty, scratched or warped, or due to the disc characteristics or recording conditions, the player may not be able to play back such discs.
- The player can play back audio signals recorded in MIX-MODE CD, CD-G, CD-EXTRA and CD TEXT.
- With some discs, operations may not be possible.

* To play back DTS-encoded DVD VIDEO or DTS-encoded Audio CD discs correctly, connect the player to an amplifier with a built-in DTS decoder.

Unplayable discs

If you try to play back discs listed below, noise may be generated and causes damage to speakers.

- DVD-RW written in the VR mode
- DVD-ROM, DVD-RAM, DVD AUDIO, CD-ROM, PHOTO CD, SACD
- Unfinalized discs
- Discs of irregular shape or discs with tape, seals or paste on either the label side or playback side. Playing back these discs may damage the player.

The Non-DVD side of a "DualDisc" does not comply with the "Compact Disc Digital Audio" standard. Therefore, the use of Non-DVD side of a DualDisc on this product may not be recommended.

Buttons, Connectors, and Indicators

Front View

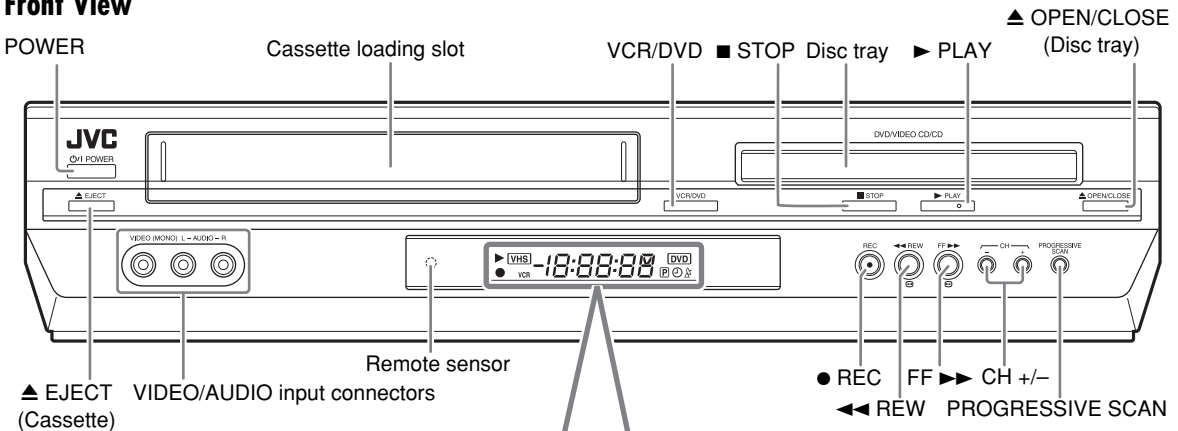

Front Display Panel

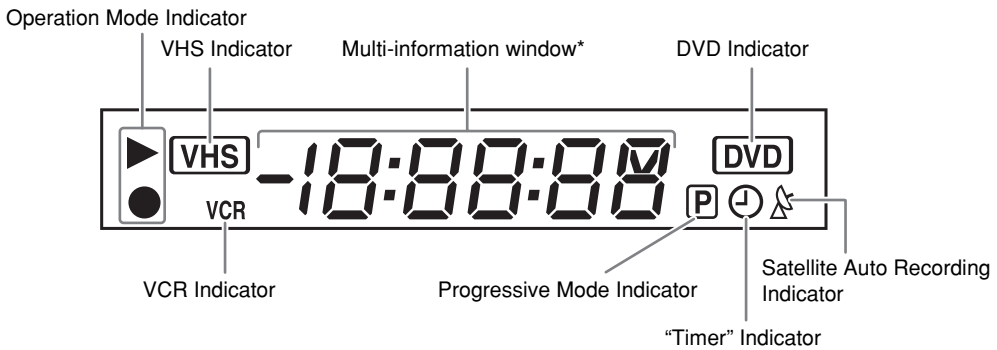

* You can change the information by pressing **DISPLAY** on the Remote as follows:

For VCR deck: Channel/auxiliary input/clock/tape counter information will be displayed.

For DVD deck: The current group/title/track/chapter number(s), time, and status information will be displayed.

Rear View

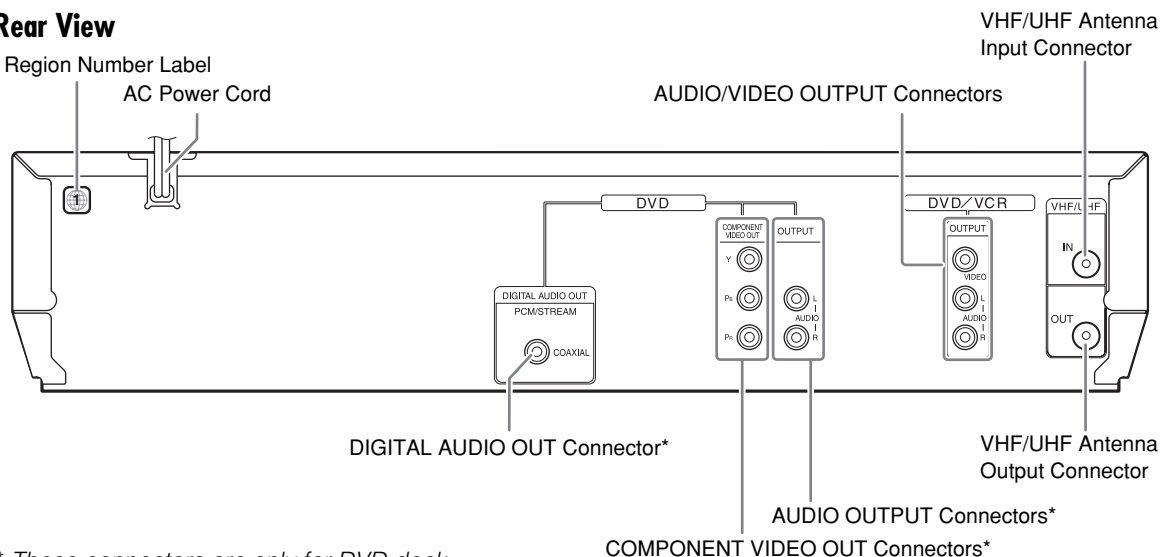

* These connectors are only for DVD deck.

Remote

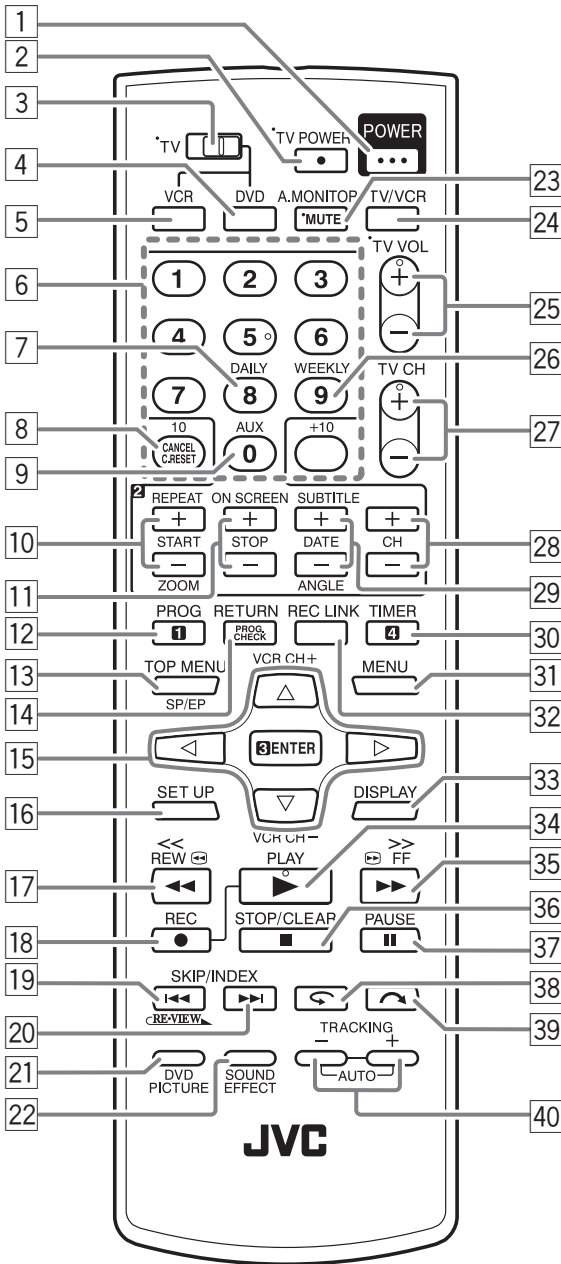

- 1 Power Button (POWER)
- 2 TV Power Button (TV POWER)
- 3 TV/VCR/DVD switch
- 4 DVD Button
- 5 VCR Button
- 6 Number Buttons
- 7 Daily Button (DAILY)
- 8 Cancel Button (CANCEL), Reset Button (C.RESET)
- 9 Auxiliary Button (AUX)
- 10 Start Time Button (START +/-), Repeat Button (REPEAT), Zooming Button (ZOOM)
- 11 Stop Time Button (STOP +/-), On-Screen Button (ON SCREEN)
- 12 Programming Button (PROG)
- 13 Top Menu Button (TOP MENU), SP/EP Button
- 14 Program Check Button (PROG. CHECK), Return Button (RETURN)
- 15 </>/</>/</> Button, ENTER Button, VCR Channel Button (VCR CH +/-)
- 16 Set Up Button (SET UP)
- 17 Rewind Button (<< REW)
- 18 Record Button (● REC)
- 19 Reverse Skip/Index Button (◀◀ SKIP/INDEX), Review Button (◀◀ REVIEW)
- 20 Forward Skip/Index Button (▶▶ SKIP/INDEX)
- 21 DVD Picture Button (DVD PICTURE)
- 22 Sound Effect Button (SOUND EFFECT)
- 23 TV Muting Button (MUTE)/Audio Monitor Button (A.MONITOR)
- 24 TV/VCR Button
- 25 TV Volume Button (TV VOL +/-)
- 26 Weekly Button (WEEKLY)
- 27 TV Channel Button (TV CH +/-)
- 28 Channel Button (CH +/-)
- 29 Date Button (DATE +/-), Subtitle Button (SUBTITLE), Angle Button (ANGLE)
- 30 Timer Button (TIMER)
- 31 Menu Button (MENU)
- 32 Satellite Auto Recording Button (REC LINK)
- 33 Display Button (DISPLAY)
- 34 Play Button (▶ PLAY)
- 35 Fast Forward Button (FF ▶▶)
- 36 Stop Button (■ STOP)/Clear Button* (CLEAR)
* Does not function with this unit.
- 37 Pause Button (|| PAUSE)
- 38 One Touch Replay Button (↶)
- 39 Skip Search Button (↷)
- 40 Tracking Button (TRACKING +/-)

How to use the Remote

Before use, insert two AA size batteries into the Remote with the polarity (⊕ and ⊖) matched correctly as indicated on the Remote.

- Point the Remote toward the remote sensor.
- The maximum operating distance of the Remote is about 8 m.

The Remote can operate most of your unit's functions, as well as basic functions of TV sets of JVC.

Buttons with a small dot on the left side of the name (**TV POWER** (Ⓛ), **TV/VCR**, **TV VOL +/-**, **TV CH +/-**, **MUTE**) can also be used to operate a JVC's TV after setting the **TV/VCR/DVD** switch to the left.

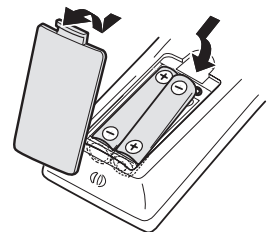

Connections

Basic Connections

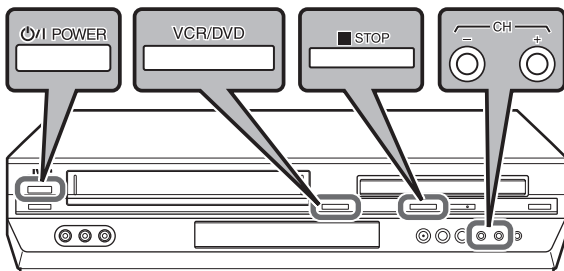
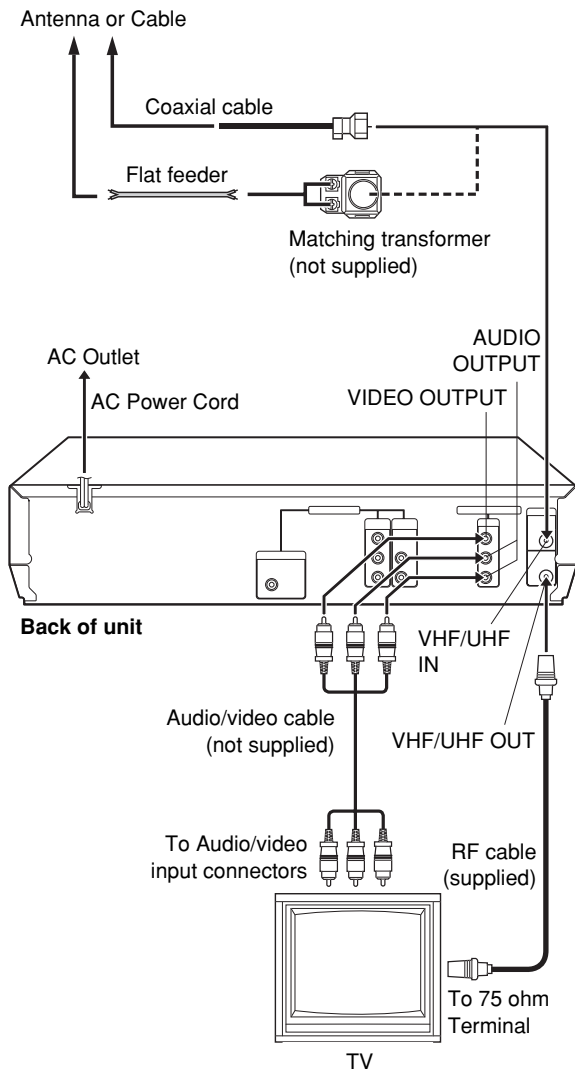

① Place the unit on a stable, horizontal surface.

② Connect the unit to TV.

RF Connection

- 1 Disconnect the TV antenna from the TV.
- 2 Connect the TV antenna cable to the VHF/UHF IN connector on the rear panel of the unit.
- 3 Connect the supplied RF cable between the VHF/UHF OUT connector on the rear panel of the unit and the TV's antenna terminal.

AV Connection

- 1 Connect the antenna, unit and TV as per "RF Connection."
- 2 Connect an optional audio/video cable between the AUDIO/VIDEO OUTPUT connectors on the rear panel of the unit and the TV's audio/video input connectors.

• Set your TV to AV mode.

③ Plug the end of the AC power cord into an AC outlet.

This unit performs Plug&Play Set automatically. (See pg. 11)

The clock and tuner channels will automatically be set when the antenna is connected and when the AC power cord is connected to an AC outlet for the first time. (If "Auto" and the channel indicator are displayed on the front display panel before the unit is powered on, the clock and tuner channels are being set automatically. Wait for the time to be displayed on the front display panel before turning on the unit.)

④ Set the VCR channel.

The VCR channel is the channel on which you can watch the picture from the unit on the TV only when using RF connection. With RF connection, set the VCR channel to "3 CH" or "4 CH."

- The VCR channel is preset to "3 CH." Set to "4 CH" if the Channel 3 is used for broadcasting in your area.
- With AV connection, set the VCR channel to "- CH" (off).

To set the VCR channel, perform the following steps:

Before performing the following steps:

- Make sure there is no cassette inserted in the unit.
- Make sure the unit is turned on, then press **VCR/DVD** on the unit so that the VHS indicator lights up on the front display panel.

- 1 Press **POWER** on the unit to turn off the unit, then press **STOP** on the unit for more than 5 seconds. "3 CH" appears on the front display panel.
- 2 Press **CH +/-** on the unit to select "3 CH," "4 CH," or "- CH" (off), then press **POWER** on the unit.

Component Video Connection (For high-quality DVD pictures)

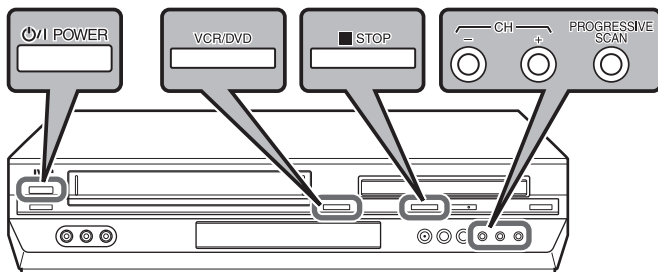
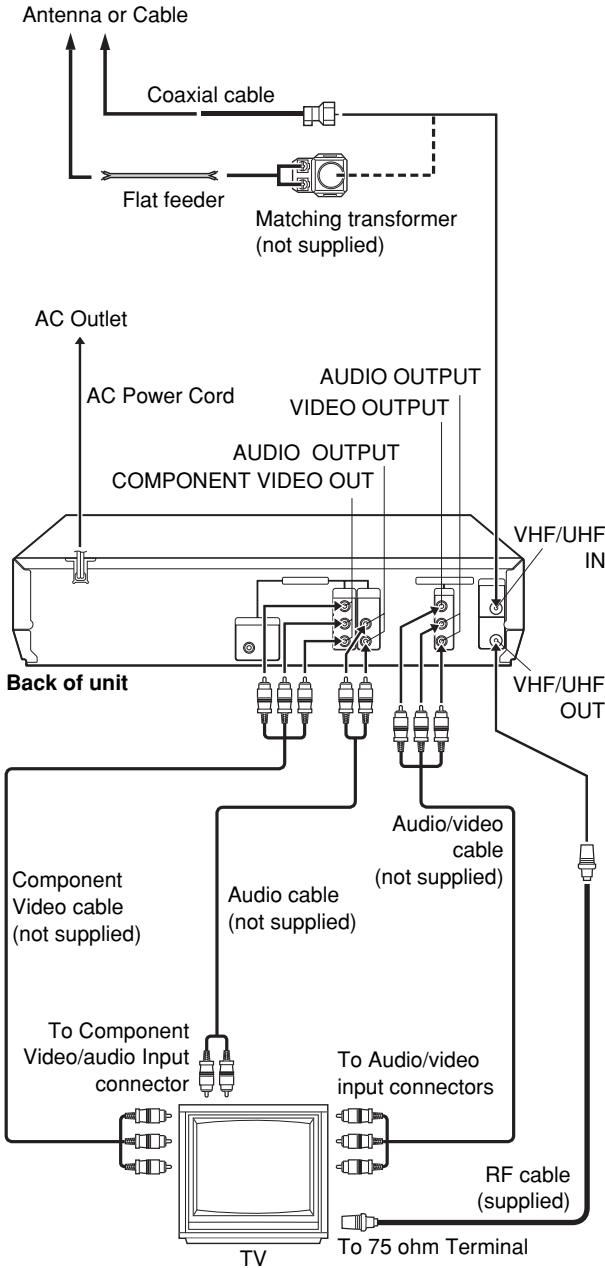

ATTENTION

Be sure to connect the unit's VIDEO OUTPUT (DVD/VCR) connector to the TV's VIDEO input connector.

1 Place the unit on a stable, horizontal surface.

2 Connect the unit to TV.

- 1 Connect the antenna, unit and TV as per "AV Connection." (pg. 9)
- 2 Connect the unit's COMPONENT VIDEO OUTPUT connector to the TV's component video input connector.

3 Plug the end of the AC power cord into an AC outlet.

This unit performs Plug&Play Set automatically. (pg. 11)

The clock and tuner channels will automatically be set when the antenna is connected and when the AC power cord is connected to an AC outlet for the first time. (If "Auto" and the channel indicator are displayed on the front display panel before the unit is powered on, the clock and tuner channels are being set automatically. Wait for the time to be displayed on the front display panel before turning on the unit.)

4 Set the VCR channel to off.

Before performing the following steps:

- Make sure there is no cassette inserted in the unit.
- Make sure the unit is turned on, then press **VCR/DVD** on the unit so that the VHS indicator lights up on the front display panel.

- 1 Press **POWER** on the unit to turn off the unit, then press **STOP** on the unit for more than 5 seconds. "3 CH" appears on the front display panel.
- 2 Press **CH +/-** on the unit to select "3 CH," "4 CH," or "- CH" (off), then press **POWER** on the unit.

NOTES:

- By using the component video connection, you can view the images in the progressive mode. For switching to the progressive mode, refer to "Scan Mode Set (DVD deck only)." (pg. 11)
- To enjoy playback of DVD with the component video connection, set the TV's input to the component video input.

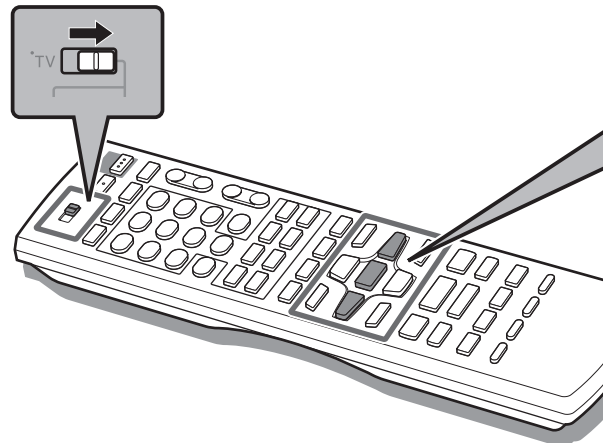

Scan Mode Set (DVD deck only)

This unit supports the progressive scan system as well as the conventional interlaced scan system. If your TV equipped with component video connectors supports the progressive video input, you can enjoy a high quality picture by setting the progressive scan mode to active.

- Refer also to the instruction manuals supplied with your TV.
- If your TV equipped with component video connectors does not support the progressive video input, do not change the scan mode to the "PROGRESSIVE."

- Turn on the TV and select the VCR channel (or AV mode).
- Slide the **TV/VCR/DVD** switch on the Remote to right.

1 Select the DVD deck.

Press **VCR/DVD** on the unit so that the DVD indicator lights up on the front display panel.

2 Switch the mode.

- 1 Press and hold **PROGRESSIVE SCAN** on the unit for more than 3 seconds.
The current scan mode blinks on the front display panel.
- 2 While the current scan mode blinks, press $\triangleleft \triangleright$ to select "*ProGr*" (ProGr) (for the progressive scan mode) or "*IntEr*" (IntEr) (for the interlaced scan mode), then press **ENTER**.
 - If the current scan mode stops blinking before you make the setting, start from step 1 again.

NOTE:

When the progressive scan mode is selected, the Progressive mode indicator (**P**) lights up on the front display panel.

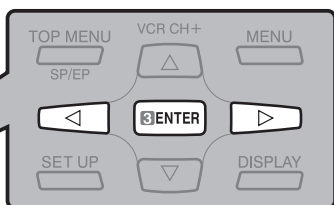

Initial Settings

Plug&Play Set

This unit sets the clock and tuner channels automatically when the AC power cord is connected to an AC outlet for the first time.

The time and date can be set automatically by the clock setting data transmitted from one of the regular TV broadcast channels. (We call this TV channel the "host channel" and it is a PBS channel in your area.)

- The antenna cable must be connected for Plug&Play set. (☞ pg. 9 and 10)

NOTES

- If you use a cable box, Plug&Play will not function; set the clock and tuner channels separately. (☞ pg. 14 and 15)
- Depending on areas or reception conditions, the unit may not receive the Auto clock setting data from the PBS channel. If this function is taking a considerable amount of time, it may be necessary to perform the Semiauto or Manual Clock Set procedure. (☞ pg. 14)

1 Perform Plug&Play set.

Connect the AC power cord to an AC outlet. Do not turn on the unit. The clock and tuner channels will be set automatically.

Auto

During Initial Auto Clock Set
"Auto" blinks.

40CH

During Auto Channel Set
The channel numbers are displayed as they are scanned and set.

8:00 PM

Plug&Play Completed
The current time is displayed.

What to do if Plug&Play set failed

- If an incorrect time is displayed on the front display panel, you may be receiving the clock setting data of a PBS channel from an adjacent time zone, or an incorrect PBS channel from a cable TV system. In this case, perform "Semiauto Clock Set" or "Manual Clock Set" (☞ pg. 14).
- If "--:--" appears on the front display panel, your antenna cable may not be connected to the unit or there may not be a Host PBS signal available in your area. Ensure that the antenna cable is connected correctly. Then turn on and off the unit; Plug&Play set will be automatically reactivated. If Plug&Play set is not performed though the antenna cable is connected correctly, perform "Manual Clock Set" (☞ pg. 14), then "Auto Channel Set" (☞ pg. 15) or "Manual Channel Set" (☞ pg. 15).

Initial Settings (continued)

Monitor Set (DVD deck)

You can select the monitor type depending the TV used when you playback DVD VIDEO disc recorded for wide-screen TVs.

- Turn on the TV and select the VCR channel (or AV mode).
- Slide the **TV/VCR/DVD** switch on the Remote to the right.

1 Select the DVD deck.

Press **DVD** on the Remote so that the DVD indicator lights up on the front display panel.

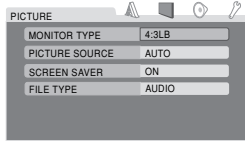

2 Access the DVD Set Up Menu screen.

- 1 Press **SET UP**.
- 2 Press $\triangleleft \triangleright$ to select "PICTURE."

3 Select the mode.

Press $\triangle \nabla$ to move the highlight to "MONITOR TYPE," then press **ENTER**.

4 Select the mode setting.

Press $\triangle \nabla$ to select the desired setting, then press **ENTER**.

[16:9] (Wide television screen)

For a wide-screen (16:9) TV.



[4:3 LB] (Letter Box conversion)

For a normal (16:9) TV. Displays a wide-screen picture to fit the width of the TV screen keeping the aspect ratio.



[4:3 PS] (Pan Scan conversion)

For a normal (16:9) TV. The picture is zoomed up to filling the screen vertically and the left and right sides of the picture are cut off.



5 Return to the normal screen.

Press **SET UP**.

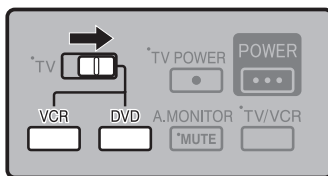

Language Set

You can change the language settings manually as required.

- Turn on the TV and select the VCR channel (or AV mode).
- Slide the **TV/VCR/DVD** switch on the Remote to the right.

On-screen Language Set (VCR deck)

1 Select the VCR deck.

Press **VCR** on the Remote so that the VHS indicator lights up on the front display panel.

2 Access the Main Menu screen, then select the Initial Set.

- 1 Press **SET UP** to access the Main Menu screen.
- 2 Press $\triangle \nabla$ to move the highlight bar (arrow) to "INITIAL SET," then press **ENTER**.

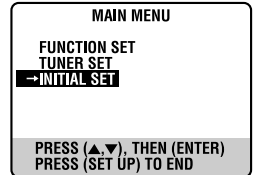

3 Select the language.

Press $\triangle \nabla$ to move the highlight bar (arrow) to "LANGUAGE," then press **ENTER** repeatedly until the desired language is selected.

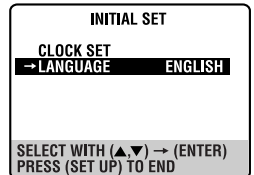

4 Return to the normal screen.

Press **SET UP**.

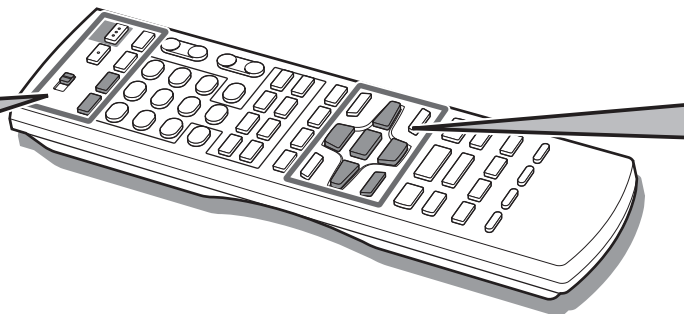

On-screen Language Set (DVD deck)

This DVD deck offers you the choice to view on-screen messages in 3 different languages.

1 Select the DVD deck.

Press **DVD** on the Remote so that the DVD indicator lights up on the front display panel.

2 Access the DVD Set Up Menu screen.

- 1 Press **SET UP**.
- 2 Press $\triangleleft \triangleright$ to select "LANGUAGE."

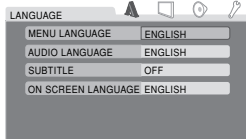

3 Select the mode.

Press $\triangle \nabla$ to move the highlight to "ON SCREEN LANGUAGE," then press **ENTER**.

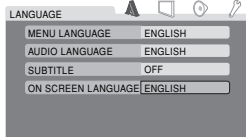

4 Select the mode setting.

Press $\triangle \nabla$ to select the desired setting, then press **ENTER**.

5 Return to the normal screen.

Press **SET UP**.

Menu/Audio/Subtitle Language Set

(DVD deck only)

Some DVD discs contain the DVD menu display, audio, subtitle in the multiple language. With these discs, you can set the default language.

1 Select the DVD deck.

Press **DVD** on the Remote so that the DVD indicator lights up on the front display panel.

2 Access the DVD Set Up Menu screen.

- 1 Press **SET UP**.
- 2 Press $\triangleleft \triangleright$ to select "LANGUAGE."

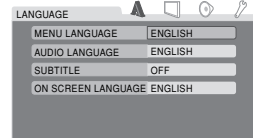

3 Select the mode.

Press $\triangle \nabla$ to move the highlight to the mode you want to change, then press **ENTER**.

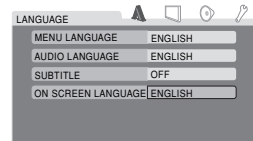

4 Select the mode setting.

Press $\triangle \nabla$ to select the desired setting, then press **ENTER**.

- See "Language Code List." (pg. 38)

5 Return to the normal screen.

Press **SET UP**.

NOTE:

When the selected language is not available on the disc, the disc's default menu language is played back.

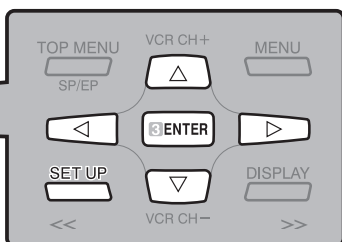

Initial Settings (continued)

Clock Set

Perform clock setting only if the clock has not been set correctly by the Plug&Play setting.

- Turn on the TV and select the VCR channel (or AV mode).
- Slide the **TV/VCR/DVD** switch on the Remote to the right.

Preparations

1 Select the VCR deck.

Press **VCR** on the Remote so that the VHS indicator lights up on the front display panel.

2 Access the Main Menu screen.

Press **SET UP**.

3 Access the Initial Set screen.

Press $\Delta\nabla$ to move the highlight bar (arrow) to "INITIAL SET," then press **ENTER**.

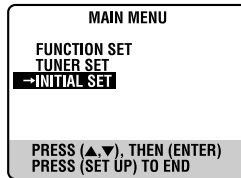

4 Access the Clock Set screen.

Press $\Delta\nabla$ to move the highlight bar (arrow) to "CLOCK SET," then press **ENTER**.

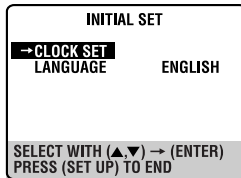

Manual Clock Set

1 Set the time, date, and year.

Press $\Delta\nabla$ to set the hour, then press **ENTER**.

Set the date and year in the same way.

- Press and hold $\Delta\nabla$ to change the time by 30 minutes or the date by 15 days.

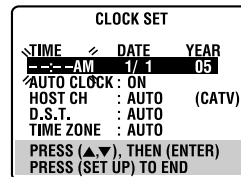

2 Select D.S.T. mode.

Press **ENTER** to move the highlight bar to "D.S.T.," then press $\Delta\nabla$ to select the desired setting.

ON: Adjustment will be made by the built-in clock itself.

OFF: Select when Daylight Saving Time does not apply to you.

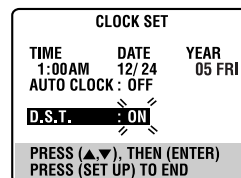

3 Start clock.

Press **SET UP** and normal screen appears.

To make corrections any time during the process

Press **ENTER** repeatedly until the item you want to change blinks, then press $\Delta\nabla$.

Semiauto Clock Set

You can change the host channel/D.S.T. (Daylight Saving Time)/time zone setting manually.

NOTE:

The time set previously will be erased when "AUTO CLOCK," "HOST CH," "D.S.T.," or "TIME ZONE" setting is changed.

1 Set "AUTO CLOCK" to "ON."

Press **ENTER** repeatedly to move the highlight bar to "AUTO CLOCK," then press $\Delta\nabla$ so that "ON" is selected.

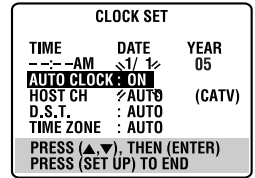

2 Select the host channel.

You can either select "AUTO" or enter a PBS channel number.

Press **ENTER** to move the highlight bar to "HOST CH," then press $\Delta\nabla$ repeatedly until "AUTO" or the desired PBS channel number is selected.

NOTE:

Some PBS channels do not transmit clock setting data.

3 Select the D.S.T. mode.

Press **ENTER** to move the highlight bar to "D.S.T.," then press $\Delta\nabla$ repeatedly until the desired setting is selected.

AUTO: Select if you want to adjust your VCR's clock automatically by the incoming signal from the host channel. Be sure to select the correct time zone manually in step 4.

ON: Adjustment will be made by the built-in clock itself.

OFF: Select when Daylight Saving Time does not apply to you.

4 Select the time zone.

Press **ENTER** to move the highlight bar to "TIME ZONE," then press $\Delta\nabla$ repeatedly until "AUTO" or the desired time zone is selected. Each time you press the button, the time zone changes as follows:

Δ AUTO Δ ATLANTIC Δ EASTERN Δ CENTRAL
 Δ MOUNTAIN Δ PACIFIC Δ ALASKA Δ HAWAII Δ
(back to the beginning)

5 Complete the Semiauto Clock Set.

Press **SET UP** to return to normal screen.

IMPORTANT

Turn off the unit after performing Semiauto Clock. "Auto" will appear on the front display panel while the clock is being set. The current clock time will appear automatically when the clock setting is complete.

Tuner Set

- Turn on the TV and select the VCR channel (or AV mode).
- Slide the **TV/VCR/DVD** switch on the Remote to the right.

Auto Channel Set

Perform Auto Channel Set only if channels have not been set correctly by the Plug&Play setting.

1 Select the VCR deck.

Press **VCR** on the Remote so that the VHS indicator lights up on the front display panel.

2 Access the Main Menu screen, then select the Tuner Set.

- 1 Press **SET UP**.
- 2 Press Δ/∇ to move the highlight bar (arrow) to "TUNER SET," then press **ENTER**.

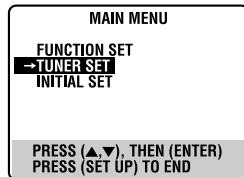

3 Perform Auto Channel Set.

Press Δ/∇ to move the highlight bar (arrow) to "AUTO CHANNEL SET," then press **ENTER**. You can automatically set the receivable channels in your area in the order of their frequencies.

- When Auto Channel Set is complete, "SCAN COMPLETED" appears on the TV screen.
- If the scan was unsuccessful, "SCAN COMPLETED-NO SIGNAL-" appears on screen. Check the connections and start again.

4 Return to the normal screen.

Press **SET UP**.

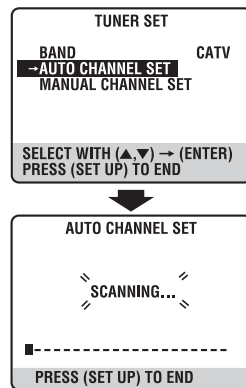

Manual Channel Set

You can add the channels you want or delete the channels you do not want manually.

1 Select the VCR deck.

Press **VCR** on the Remote so that the VHS indicator lights up on the front display panel.

2 Access the Main Menu screen, then select the Tuner Set.

- 1 Press **SET UP**.
- 2 Press Δ/∇ to move the highlight bar (arrow) to "TUNER SET," then press **ENTER**.

3 Access the Manual Channel Set screen.

Press Δ/∇ to move the highlight bar (arrow) to "MANUAL CHANNEL SET," then press **ENTER**.

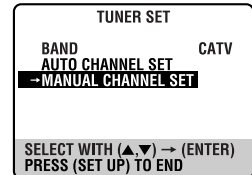

4 Add or skip the desired channels.

To add channels

- 1 Press the **number keys** to input a channel number you want to add.
- 2 Press **ENTER** to set to "ADD."
- 3 Repeat 1 to 2 to add other channels.

To skip channels

- 1 Press Δ/∇ or the **number buttons** to select a channel number you want to skip.
- 2 Press **ENTER** to set to "SKIP."
- 3 Repeat 1 to 2 to skip other channels.

5 Return to the normal screen.

Press **SET UP**.

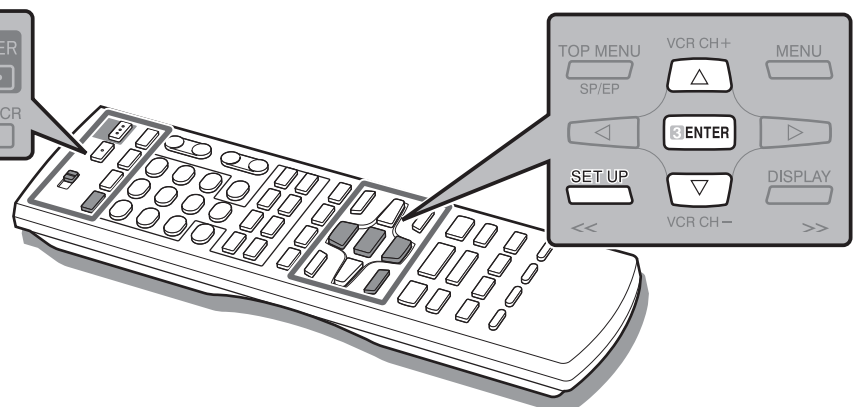
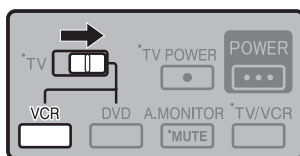
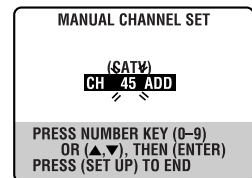

Playback on VCR Deck

Basic Playback

- Turn on the TV and select the VCR channel (or AV mode).
- Slide the **TV/VCR/DVD** switch on the Remote to the right.

1 Load a cassette.

Make sure the window side is up, the rear label side is facing you and the arrow on the front of the cassette is pointing towards the recorder.

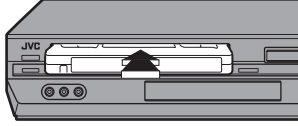

- Do not apply too much pressure when inserting.
- The unit turns on, and the counter is reset automatically.
- If the cassette's record safety tab has been removed, playback begins automatically.

2 Select the VCR deck.

Press **VCR** on the Remote so that the VHS indicator lights up on the front display panel.

3 Start playback.

Press **▶ PLAY**.

During playback

Stop playback

Press **■ STOP** on the Remote.

Pause playback and view still picture

Press **⏸ PAUSE**.

- Press **▶ PLAY** to resume normal playback.
- If there is vertical jitter, press **CH +** or **-** to correct the picture.

Pause and Frame-by-Frame playback

Press **⏸ PAUSE** to pause, then press **⏸ PAUSE** repeatedly.

- Press **▶ PLAY** to resume normal playback.

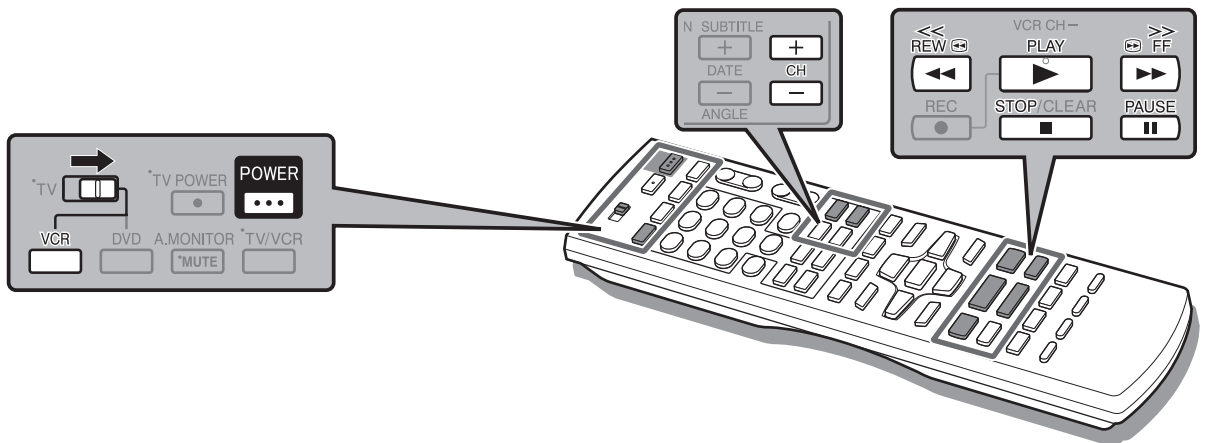

Variable Speed Search (including slow-motion)

Press **◀ REW** or **▶ FF** repeatedly.

- Press **▶ PLAY** to resume normal playback.
- Each time you press **◀ REW** or **▶ FF**, the playback speed changes. To decrease the speed during picture search, press the opposite direction button repeatedly.

Reverse		Forward	
←	→	←	→
Reverse search 3 steps	Slow motion	Normal play	Forward search 2 steps

- During still picture, holding **⏸ PAUSE** for more than 2 seconds starts forward slow motion playback. If you press **⏸ PAUSE** again, still picture resumes.
- During slow motion playback, some noise may appear on the TV screen. Press **CH +** or **-** to eliminate the noise.

When the tape is not running

Rewind/fast-forward at high speed

Press **◀ REW** or **▶ FF**.

Eject the cassette

Press **▲ EJECT** on the unit.

- You can also eject the cassette when the recorder is turned off.

Turn off the unit

Press **POWER**.

NOTE:

In the search, still, slow-motion or frame-by frame playback mode,

- the picture will be distorted
- the noise bars will appear
- there will be a loss of color with an LP-recorded tape

On-Screen Display (VCR deck)

If you press **ON SCREEN** on the Remote when "SUPERIMPOSE" is set to "ON" (pg. 32), various operational indicators appear on the TV screen.

Press **ON SCREEN** again to clear the display.

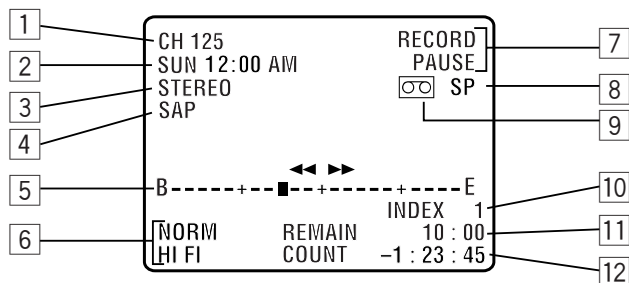

- | | |
|--|----------------------------------|
| 1 Channel Position Number/Auxiliary Input Indicator (F-1) | 6 Audio Mode Display |
| 2 Day/Clock Display | 7 Opening Mode Indicators |
| 3 Stereo Program Indicator | 8 Tape Speed (SP/EP) |
| 4 SAP Indicator | 9 "Cassette Loaded" Mark |
| 5 Tape Position Indicator
The position of "■" in relation to "B" (beginning) or "E" (end) shows the current position on the tape. | 10 Index number |
| | 11 Tape Remaining Time Indicator |
| | 12 Counter Display |

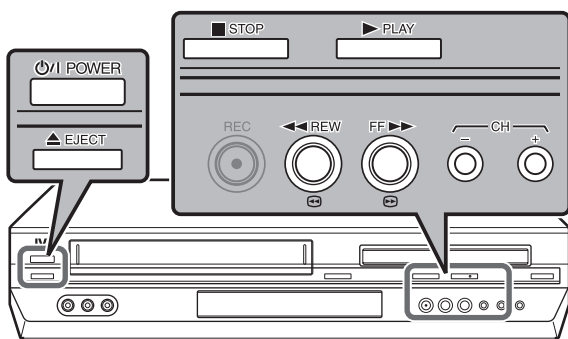

Playback on VCR Deck (continued)

Playback Features

Skip Search

During playback, press (Skip Search) 1 to 6 times to skip over unwanted sections.

Each press initiates a 30-second period of fast-motion playback. Normal playback resumes automatically.

- To resume normal playback during a Skip Search, press **▶ PLAY**.

Index Search

Index codes are placed on the tape at the beginning of each recording when recording on this unit.

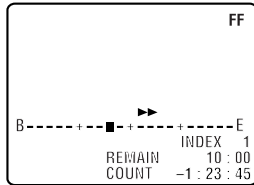

- 1 While the tape is not running, press **◀◀ INDEX** or **INDEX ▶▶** to start search.
- 2 To access a recording of 2 to 9 index codes away, press **◀◀ INDEX** or **INDEX ▶▶** repeatedly until the correct number is displayed.

Example:

To locate the beginning of B from the current position, press **◀◀ INDEX** twice.

To locate the beginning of D from the current position, press **INDEX ▶▶** once.

- Playback begins automatically when the desired recording is located.

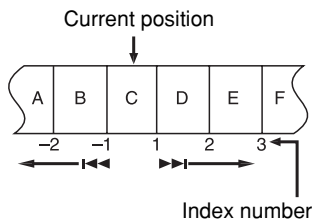

Instant ReView

Simply by pressing a single button, the unit power comes on, rewinds, and begins playback of the last timer-recorded program. If you have several programs recorded, you can easily access any of them.

NOTE:

Before starting, make sure that the unit is off and that the Timer mode is disengaged.

Activate Instant ReView

Press **◀◀ REVIEW** (). The unit power comes on and the unit searches for the index code indicating the start of the last timer-recorded program. Once it's found, playback begins automatically.

- To watch the first of the 3 programs, press **◀◀ REVIEW** three times. The unit searches and begins playback automatically. You can access a program as far as 9 index codes away from the current tape position.

Next Function Memory

The Next Function Memory "tells" the unit what to do after rewinding. Ensure that the unit is in stop mode.

• Automatic Playback Start

Press **◀◀ REW**, then press **▶ PLAY** within 2 seconds.

• Automatic Power Off

Press **◀◀ REW**, then press **POWER** within 2 seconds.

• Automatic Timer Standby

Press **◀◀ REW**, then press **TIMER** within 2 seconds.

• Automatic Cassette Ejection After Tape Rewind

Press **◀◀ REW**, then press **▲ EJECT** within 2 seconds.

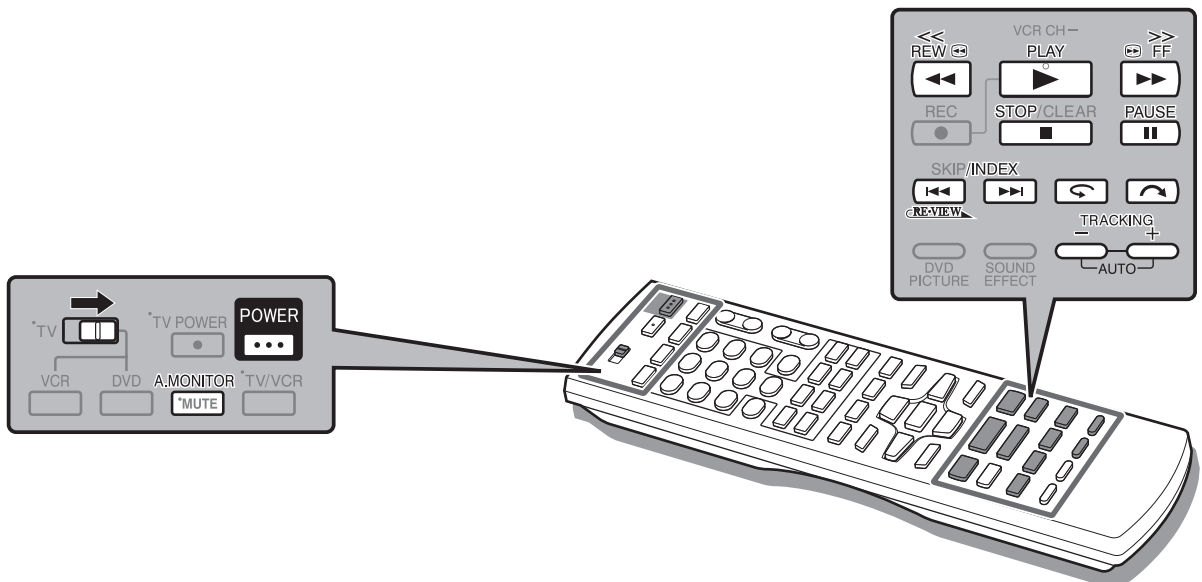

Repeat Playback

During playback, press and hold ► **PLAY** for more than 5 seconds. "►" on the front display panel starts blinking slowly. To stop playback, press ■ **STOP**.

NOTE:

Pressing ► **PLAY**, ◀◀ **REW**, **FF** ▶▶ or || **PAUSE** also stops Repeat Playback.

One Touch Replay

Press ↶ (One Touch Replay) during playback. Pressing ↶ once moves the playback position back to about 7 seconds before the current position. You can press ↶ up to 4 times each One Touch Replay.

Adjusting Tracking Condition

Automatic tracking adjustment

When a new cassette is loaded, the recorder enters the automatic tracking mode.

Manual tracking adjustment

If automatic tracking cannot eliminate noises well during playback, adjust the tracking manually.

- 1 Press **TRACKING +/-** at the same time during playback to activate manual tracking.
- 2 Press **TRACKING** to eliminate the noises. Press it briefly for a fine adjustment, or press and hold for a coarse adjustment.
- 3 Press **TRACKING +/-** again to reactivate automatic tracking.

Selecting Soundtrack

Your recorder is capable of recording three soundtracks (HIFI L, HIFI R and NORM) and plays back the one you select.

Pressing **A.MONITOR** changes the soundtrack as follows:

H I-F I:	Hi-Fi sound is played back
H I-F I L:	Sound on the left Hi-Fi channel is played back
H I-F I R:	Sound on the right Hi-Fi channel is played back
NORM:	Sound on the normal track is played back
NORM H I-F I:	Both sounds on the Hi-Fi track and normal track are mixed and played back

NOTE:

Set "SUPERIMPOSE" to "ON" to display the indications on the screen. (pg. 32)

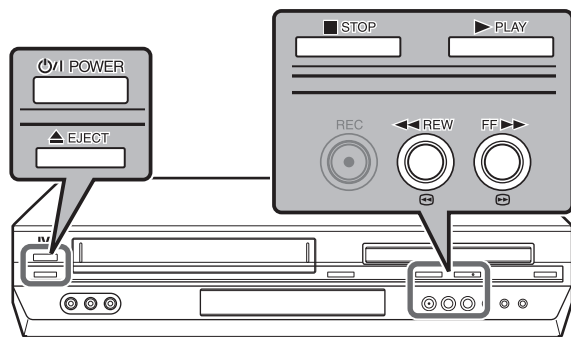

Recording

Basic Recording

- Turn on the TV and select the VCR channel (or AV mode).
- Slide the **TV/VCR/DVD** switch on the Remote to the right.

1 Load a cassette.

Make sure the record safety tab is intact. If not, cover the hole with adhesive tape before inserting the cassette.

- The recorder turns on, and the counter is reset, automatically.

2 Select the VCR deck.

Press **VCR** on the Remote so that the VHS indicator lights up on the front display panel.

3 Select recording channel.

Press **CH +/-** or the **number buttons**.

- You can select channel in the stop mode or recording pause mode.

4 Set tape speed.

Press **SP/EP**. The current setting for the tape speed appears on the display panel and the screen for about 5 seconds. Press **SP/EP** again to change the setting while tape speed is displayed.

5 Start recording.

On the recorder, press **REC**. Or on the Remote, while holding **REC**, press **PLAY**.

- If the tape reaches its end during recording, the recording stops and “●” and “▶” on the display panel blink.

During recording

Pause recording

Press **II PAUSE**.

- Press **▶ PLAY** to resume recording.
- You can select channel in the recording pause mode.

Stop recording

Press **■ STOP** on the Remote.

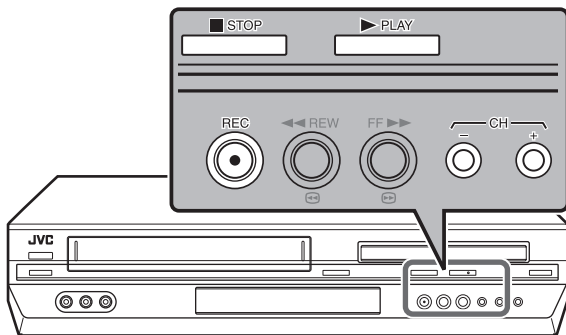

Recording Features

Watching one programme while recording another

If your recorder is connected to the TV via the AV connection, press **TV/VCR**. The recorder's VCR indicator and the TV broadcast being recorded disappear. Once recording is in progress, all you need to do is to set the channel controls on the TV for the station you wish to view.

- The programme selected with the TV's channel controls appears on the screen, while the one selected with the **CH +/-** is recorded on the tape.

Instant Timer Recording (ITR)

During recording, press **● REC** on the unit repeatedly until the desired recording length appears on the display panel. “●” on the display panel starts blinking.

- Each time you press the button, recording length increases in 30-minute intervals (up to 6 hours).
- The unit turns off after recording is finished.

Tape Remaining Time/Time Counter

Press **DISPLAY** repeatedly to display the tape remaining time and time counter on the front display panel. To reset the time counter, press **C.RESET**.

NOTE:

Depending on the type of tape being used, the tape remaining time reading may not appear right away, or is not correct. “- -: -” may sometimes appear with “:” blinking, or the display may blink on occasion.

Second Audio Recording

This unit's built-in MTS decoder enables reception of Multichannel TV Sound broadcast. To record a SAP program received, set “2ND AUDIO RECORD” to “ON.” (pg. 33)

Accidental erasure prevention

To prevent accidental recording on a recorded cassette, remove its record safety tab. To record on it later, cover the hole with adhesive tape.

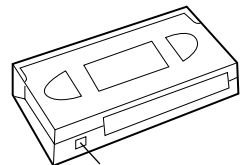

Record safety tab

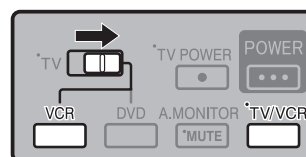

Timer Recording

Express Timer Programming

1 Select the VCR deck.

Press **VCR** on the Remote so that the VHS indicator lights up on the front display panel.

2 Access the Program screen.

Press **PROG.** (If you're just starting out, "PROGRAM 1" appears.)

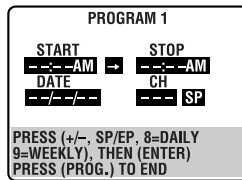

3 Enter the program start time.

Press **START +/-** to enter the time you want recording to start.

- Press and hold **START +/-** to move in 30-minute increments, or press and release repeatedly to move 1 minute at a time.

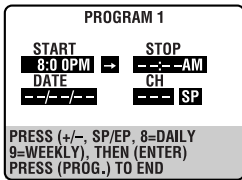

4 Enter the program stop time.

Press **STOP +/-** to enter the time you want recording to stop.

- Press and hold **STOP +/-** to move in 30-minute increments, or press and release repeatedly to move 1 minute at a time.

5 Enter the program date.

Press **DATE +/-**.

- The current date appears on the TV screen. The date you enter appears in its place.

6 Enter the channel position.

Press **CH +/-**.

7 Set the tape speed.

Press **SP/EP**.

8 Return to the normal screen.

Press **PROG** or **ENTER**. "PROGRAM COMPLETED" appears on the TV screen for about 5 seconds, then the normal screen appears. If "PROGRAM NOT COMPLETED PROGRAM OVERLAP" appears on the TV screen, see page 22.

- Repeat step 2 to 8 for each additional program.

9 Engage the unit's timer mode.

Press **TIMER**. The unit turns off automatically and "⏸" appears on the front display panel.

- To disengage the timer mode, press **TIMER** again.

To Timer-Record Weekly Or Daily Serials:

— anytime during steps 3 through 7, press **WEEKLY** (number button "9") for weekly serials or **DAILY** (number button "8") for daily serials (Monday – Friday). Either "WEEKLY" or "DAILY" appears on the TV screen. Pressing the button again makes the corresponding indication disappear.

NOTES:

- You can program this unit to timer-record as many as 8 programs. If you try to program the unit to record a ninth, "PROGRAM FULL" appears on the TV screen. To record the extra program, you must first cancel any unnecessary programs. (pg. 22)
- Programs that start after midnight must have the next day's date.

Cable Box or DBS Receiver Users

To timer-record a satellite broadcast using Express Timer Programming:

- 1 Perform steps 1 – 9. Enter "F-1" for the channel position in step 6.
- 2 Set the DBS receiver to the appropriate channel before the selected program begins.
- 3 Leave the DBS receiver's power on.

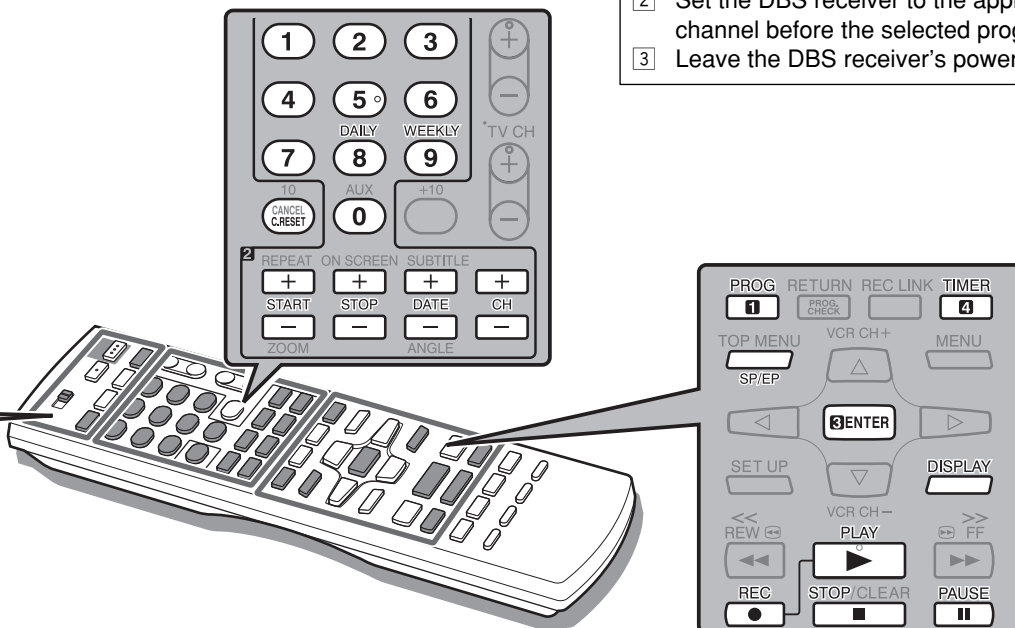

Timer Recording (continued)

Check, cancel and change programs

1 Disengage the timer mode.

Press **TIMER**, then press **POWER**.

2 Access the Program Check screen.

Press **PROG. CHECK**.

PR	START	STOP	CH	DATE
1	8:00P	10:00	12	12/24
2	10:00A	10:45	40	12/25
3	11:30P	1:00	125	12/25
4				
5				
6				
7				
8				

PRESS (CHECK) TO NEXT

3 Access the Program screen.

Press **PROG. CHECK** again to check more information.

Each time you press **PROG. CHECK**, the next program's information appears.

PROGRAM 1			
START	STOP	CH	DATE
8:00AM	10:00AM		
DATE	CH	SP	WED
12/24/03	12	TV	

PRESS (CANCEL) TO CANCEL
PRESS (CHECK) TO NEXT

To cancel or change a program

4 Cancel or change a program.

Press **CANCEL** to cancel a program. To change program settings, press the appropriate button: **START +/-**, **STOP +/-**, **DATE +/-**, **CH +/-**, **DAILY** (number button "8"), **WEEKLY** (number button "9") and/or **SP/EP**.

5 Return to the normal screen.

Press **PROG. CHECK** as many times as necessary. If there are still some programs remaining, go on to step 6.

6 Return to the timer mode.

Press **TIMER**.

When programs overlap each other

If "PROGRAM NOT COMPLETED PROGRAM OVERLAP" appears, you have another program overlapping the program you have just made. The Program Check screen appears and conflicting programs will start blinking.

PROGRAM NOT COMPLETED				
PROGRAM OVERLAP				

→

PR	START	STOP	CH	DATE
1	8:00P	10:00	12	12/24
2	10:00A	10:45	40	12/25
3	11:30P	1:00	125	12/25
4	9:00P	10:00	10	12/24
5				
6				
7				
8				

(▲▼), THEN (▶) (PROG.): END

Example: Program 1 (you have just made) and Program 4 overlap each other.

1 Confirm the overlapping programs.

Overlapping programs blink on the TV screen.

2 Select the program to modify.

Press $\Delta\nabla$, then press **ENTER**.

- You can only select one of the overlapping programs.

NOTE:

If you do not mind this overlap, press **PROG** to finish the timer program setting. The program with the lower program number will be recorded and the other one will not be recorded correctly. If no changes are made for approximately 1 minute, the unit will return to the normal screen.

3 Cancel or change program setting.

To cancel a program, press **CANCEL** when the Program screen you do not want is shown. "PROGRAM COMPLETED" appears on the TV screen for about 5 seconds, then the normal screen appears.

To change a program, press the appropriate button: **START +/-**, **STOP +/-**, **DATE +/-**, **CH +/-**, **DAILY** (number button "8"), **WEEKLY** (number button "9") and/or **SP/EP** when the Program screen on which you want to make changes is shown, then press **ENTER**. "PROGRAM COMPLETED" appears on the TV screen for about 5 seconds, then the normal screen appears.

NOTE:

If the overlap is not yet solved, or another overlap occurs with the timer program setting after making the last correction on a program, the conflicting programs will be shown on the Program Check screen again. Repeat the above steps again until the overlap is solved.

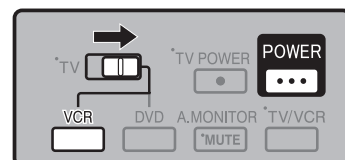

Satellite Auto Recording

This function allows you to automatically record a satellite program which is timer-programed on your external DBS receiver or the cable box if it has a timer.

ATTENTION

Be sure not to turn on the DBS receiver before the program is executed; otherwise, the unit will start recording when the DBS receiver's power is turned on.

Before performing the following steps:

- Make sure the DBS receiver is connected to the unit's VIDEO/AUDIO input (F-1) connector.
- Program the timer on the DBS receiver.
- Insert a cassette with the safety tab in place.
- Turn on the TV and select the VCR channel (or AV mode).
- Slide the **TV/VCR/DVD** switch on the Remote to the right.

1 Select the VCR deck.

Press **VCR** on the Remote so that the VHS indicator lights up on the front display panel.

2 Set the tape speed.

Press **SP/EP**.

3 Engage the Satellite Auto Recording mode.

Press and hold **REC LINK** for about 2 seconds. The "⏏" and "⌚" indicators light up and the unit turns off automatically.

NOTES:

- Operation on the DVD deck are not possible when the Automatic Satellite Program Recording mode is engaged, or timer recording is in progress.
- To disengage the Satellite Auto Recording mode, press **REC LINK**. The "⏏" indicator goes off.
- Depending on the type of DBS receiver, the unit may not record a slight portion of the beginning of the program or may record slightly longer than the actual length of the program.

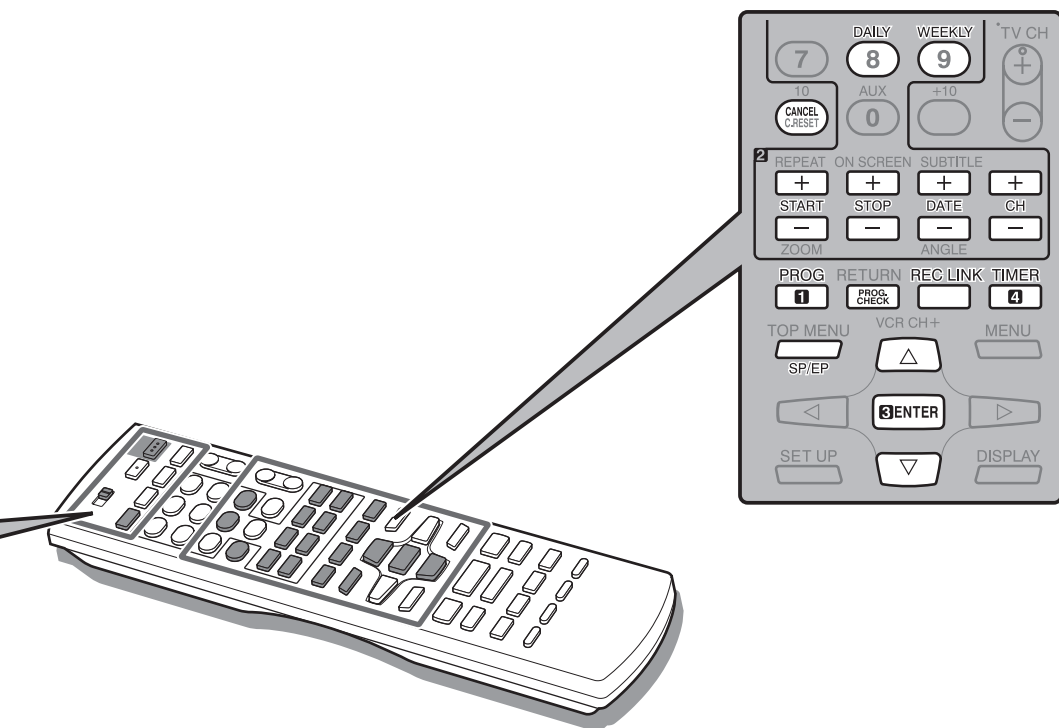

Playback on DVD Deck

Basic Playback

- Turn on the TV and select the VCR channel (or AV mode).
- Slide the **TV/VCR/DVD** switch on the Remote to the right.

1 Load a disc.

- 1 Press **▲ OPEN/CLOSE** on the unit to open the disc tray.
- 2 Place the disc in the disc tray with the label side up.
 - To insert an 8-cm disc, place it in the inner recess.
- 3 Press **▲ OPEN/CLOSE** to close the disc tray.
 - Some DVDs start playback automatically.

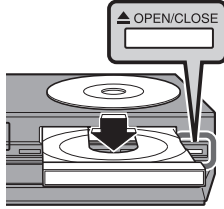

2 Select the DVD deck.

Press **DVD** on the Remote so that the DVD indicator lights up on the front display panel.

3 Start playback.

Press **▶ PLAY**.

During playback

Stop playback

Press **■ STOP** on the Remote.

- When "RESUME" is set to "ON" (pg. 35), the unit memorizes the position on the disc where you have interrupted playback.
 - To resume playback, press **▶ PLAY**.
 - To stop playback completely, press **■ STOP** again.

Pause and Frame-by-Frame playback

Press **⏸ PAUSE**. Each time you press the button, the still picture advances to the next frame.

- Press **▶ PLAY** to resume normal playback.

Skip chapter or track

Press **SKIP ►►►** or **◄◄◄ SKIP**.

Variable Speed Search

Press **FF ►►►** or **◄◄◄ REW**. Each time you press the button, the playback speed changes.

- If you press and hold **SKIP ►►►** or **◄◄◄ SKIP**, the playback is advanced/reversed at 5 times normal speed.

Slow Motion playback

Press **FF ►►►** or **◄◄◄ REW** while playback is paused. Each time you press the button, the playback speed changes.

- Press **▶ PLAY** to resume normal playback.
- Reverse slow motion is available only for DVD VIDEO discs.

Playback Features

Using the disc menu

You can operate a disc—SVCD/VCD with Playback Control* (PBC)—using the disc menu shown on the TV screen.

* A method of controlling disc play for SVCD/VCD by using the disc menu.

■ For DVD

- 1 Press **TOP MENU** or **MENU** to show the disc menu.
- 2 Press **△▽◀▶** to select a desired item, then press **ENTER** or **▶ PLAY**.

- With some discs, you can also select items by entering the number using the number buttons.

■ For SVCD/VCD

- 1 While stopped, press **TOP MENU** or **▶ PLAY** to show the menu.
- 2 Press the numeric buttons to select a desired item.
 - To move to the next or previous page of the current menu, press **SKIP ►►►** or **◄◄◄ SKIP**.
 - To return to the previous menu, press **RETURN**.

To play back without PBC

While stopped, press the numeric buttons instead of **▶ PLAY** to start playback.

To reactivate PBC

- Press **TOP MENU** or **MENU**.
- Press **■ STOP** to stop playback, then **▶ PLAY**.

Zooming the picture

- 1 Press **ZOOM**.
- 2 Each time you press **ZOOM**, the magnification changes.
 - You can use **△▽◀▶** button to move the zoomed position.
- 3 To return to the normal playback, select the normal size by pressing **ZOOM** repeatedly.

One Touch Replay

Press **↶** while playing back a DVD VIDEO disc.

The playback position moves back about 10 seconds before the current position (only within the same title).

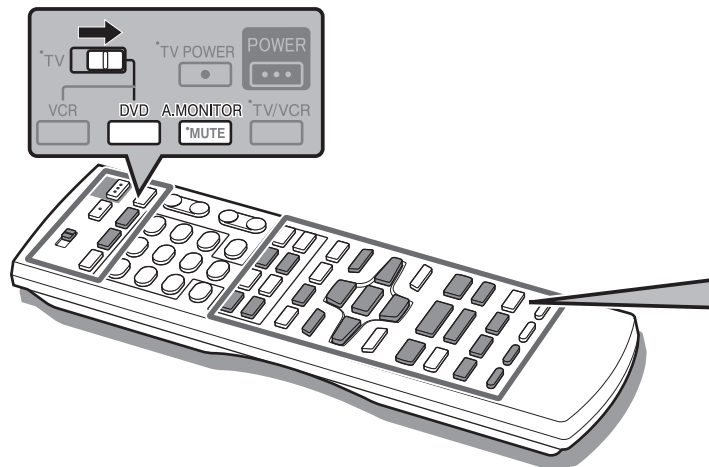

Changing the language, sound, and scene angle

- 1 Press the corresponding button.

SUBTITLE:

select audio language for DVD VIDEO.

A.MONITOR:

select audio language for DVD VIDEO.

select audio channel for SVCD/VCD.

ANGLE:

select the view-angle.

- 2 Press $\Delta \nabla$ to select the desired setting, then press **ENTER**.

Repeat Playback

Press **REPEAT** repeatedly to select the desired repeat mode.

DVD VIDEO (during playback)

CHAP: The current chapter is played back repeatedly.

TITLE: The current title is played back repeatedly.

OFF: Each title and chapter is played back once.

Video CD/SVCD/Audio CD

(in stop mode or during playback with PBC deactivated)

TRACK: The current track is played back repeatedly.

ALL: All tracks are played back repeatedly.

OFF: Each track is played back once.

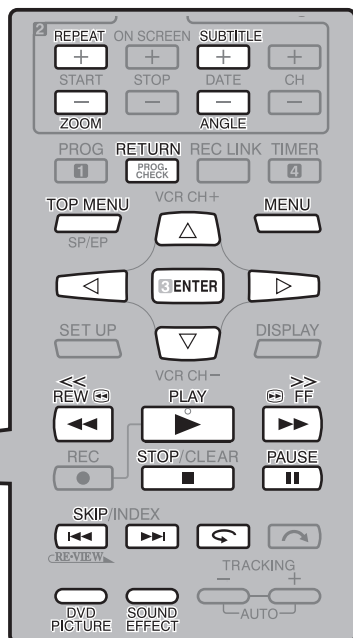

Changing the Sound Field

This function makes a human voice clearer.

- 1 Press **SOUND EFFECT**.
- 2 Each time you press **SOUND EFFECT**, the Sound Effect mode changes.
 - As the value becomes bigger, the Sound Effect works stronger.

NOTE:

The Sound Effect function works correctly only for a DVD VIDEO disc recorded in the 5.1-channel audio format.

Changing the picture tone (VFP)

The VFP (Video Fine Processor) function allows you to adjust the picture character according to the type of programming, picture tone or personal preferences.

- 1 Press **DVD PICTURE**.
- 2 Press $\triangleleft \triangleright$ to select the desired preset.

NORMAL	For watching TV in a general room.
CINEMA	For watching a movie software in a room with suppressed light.
USER1 USER2	You can adjust parameters that affect the picture character and store the settings as a user preset. See below.

To adjust the picture tone

- 1 Select "**USER1**" or "**USER2**."
- 2 Press $\Delta \nabla$ to select a parameter, then press **ENTER**.

GAMMA	Adjust this if the neutral color is bright or dark. The brightness of dark and bright portion is maintained (-3 to +3).
BRIGHTNESS	Adjust this if the picture is bright or dark on the whole (-8 (darkest) to +8 (brightest)).
CONTRAST	Adjust this if the far and near position is unnatural (-7 to +7).
SATURATION	Adjust this if the picture is whitish or blackish (-7 (blackest) to +7 (whitest)).
TINT	Adjust this if the appearance of flesh tone is unnatural (-7 to +7).
SHARPNESS	Adjust this if the picture is indistinct (-8 to +8).

- 3 Press $\Delta \nabla$ to adjust the parameter, then press **ENTER**.
- 4 Repeat step 2 and 3 to adjust other parameters.
- 5 Press **DVD PICTURE** to finish the setting.

Playback on DVD Deck (continued)

Menu Bar Functions

You can use various functions from the menu bar.

To Bring Up the Menu Bar

When a disc is inserted, press **ON SCREEN** twice.

A menu bar for the type of disc inserted will appear under the status bar.

Ex.: Menu bar for DVD VIDEO

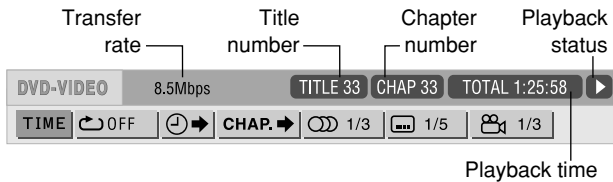

To dismiss the menu bar and the status bar, press **ON SCREEN**.

Basic Operation Procedure

1 Press **<>** to select the icon you want to work with.

2 Press **ENTER**.

After pressing **ENTER**:

- When a pull-down menu appears, press **Δ∇** to select the setting you want, then press **ENTER**.
- When a number-entry box appears, use the **number buttons** to enter the number you want, then press **ENTER**.
- When changing **TIME** setting, press **ENTER** repeatedly to select the setting you want.

NOTES:

- The selected item on the menu bar is shown in green.
- The available functions differ depending on the player status. Refer to the explanation below to check when you can use a certain function.

Menu Bar Functions

TIME selects the time mode shown in the display window and the status bar.

- TOTAL**: Elapsed time of current title (DVD) or a disc (CD/VCD/SVCD)
- T.REM**: Remaining time of current title (DVD) or a disc (CD/VCD/SVCD) (Except for DVD: while stopped, disc total time)
- TIME**: Elapsed time of current chapter (DVD) or track (CD/VCD/SVCD)
- REM**: Remaining time of current chapter (DVD) or track (CD/VCD/SVCD) (while stopped, current track total time)

REPEAT selects repeat mode.

- DVD**: During playback
- CD**: In any condition
- VCD/SVCD**: In any condition except PBC playback
- CHAPTER**: Current chapter repeat (DVD)
- TITLE**: Current title repeat (DVD)
- TRACK**: Current track repeat (CD/VCD/SVCD)
- ALL**: All track repeat (CD/VCD/SVCD)
- A-B**: A-B repeat (During playback). After selecting A-B, press **ENTER** at the beginning point of repeat, then press **ENTER** again at the end point.
- OFF**: Repeat mode deactivated. Select this to quit repeat mode.

TIME specifies beginning point of a title (DVD) or a disc (CD/VCD/SVCD) by the time.

- DVD**: In any condition
- CD**: In any condition except program or random playback
- VCD/SVCD**: In any condition except PBC or program or random playback

CHAP. specifies a chapter to play back from (DVD only).

AUDIO selects the audio language (DVD), sound track (DVD), or audio channel (VCD/SVCD) during playback.

SUBTITLE selects the subtitle language (DVD) or subtitle (SVCD) during playback.

ANGLE selects a scene angle in a multiangle part (DVD only).

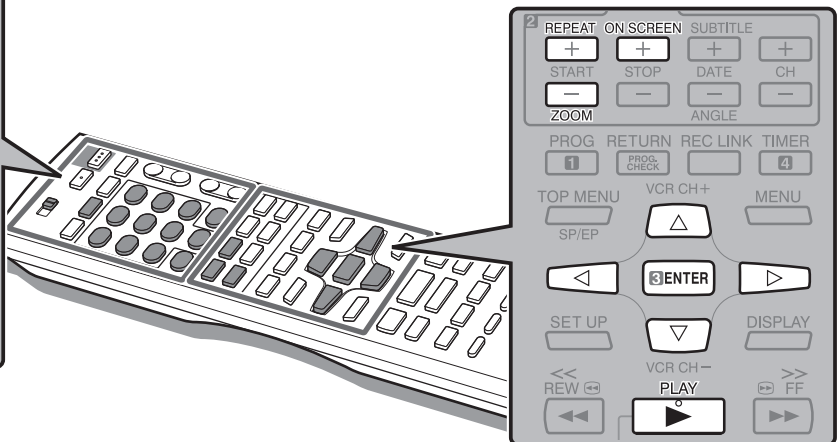

MP3/JPEG Files Playback

You can play back MP3/JPEG files on a CD/CD-R/RW.

Precautions

- Use "ISO 9660" as the disc format.
- The unit does not support "packet writing (UDF format)" discs.
- The unit supports discs recorded with up to five multiple sessions.
- The unit may be unable to play back a disc due to the characteristics or recording conditions.
- The unit recognizes up to 99 groups, 150 files per group. If a disc includes more than the files above limit, the unit stops detecting files when the number of detected files reaches the limit and ignores the subsequent files. The unit also ignores any non-MP3/JPEG file in the disc.
- Add the appropriate extension (".mp3" and ".jpg") to the file name.
- MP3i and MP3 Pro are not available.
- This unit supports the JPEG files whose resolution is 32 to 8192 pixel in width and 32 to 7680 pixel in height.
- We recommend to record a file at 640 x 480 resolution. (If a file has been recorded at a resolution of more than 640 x 480, it will take a longer time to be displayed.)

Control Display

The control display appears on the TV screen when an MP3 or a JPEG disc is loaded.

Example: When an MP3 disc is loaded

Total group number on disc Current file number Total file number in current group

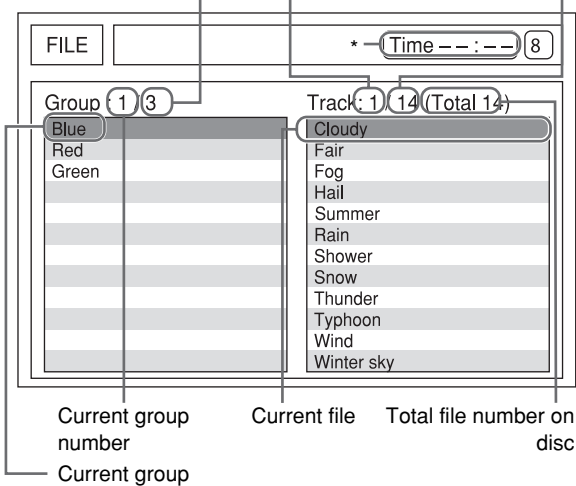

* For MP3 only

Elapsed playing time of current track is only shown during playback.

Press Δ ∇ \leftarrow \rightarrow to move the cursor bar to a desired file, then press \blacktriangleright **PLAY**.

- For JPEG files: when you press **ENTER**, only the selected file is played back.

Group/File Selection

To start playback by specifying the group/file number

- 1 Press the **number buttons** to enter the group number.
- 2 Press the **number buttons** to enter the file number.

Example:

To select 3: Press 3.

To select 14: Press +10, then 4.

To select 20: Press +10, then 10.

Or press +10 twice, then 0.

To select 24: Press +10, +10, then 4.

To select 110: Press +10 ten times, then 10.

For MP3 files playback

Playback starts from the file you have specified.

For JPEG files playback

- The slide-show playback starts from the file you have specified.
- To display only the selected file, then press **ENTER**. To start slide-show playback from that file, press **ENTER** again.

Repeat Playback

You can repeat playback of the current group, file (only for MP3 files), or all groups.

- While the control display is on the TV screen:

1 Select the mode.

Press **REPEAT** to select the desired repeat mode.

- Each time you press **REPEAT**, the mode changes as follows:

For MP3 files playback

TRACK: The current file (track) is played back repeatedly.

GROUP: All files of the current group are played back repeatedly.

ALL: All files are played back repeatedly.

OFF (No indication): Each file is played back once.

For JPEG files playback

GROUP: All files of the current group are played back repeatedly.

ALL: All files are played back repeatedly.

OFF (No indication): Each file is played back once.

2 Start playback.

Press \blacktriangleright **PLAY**.

Zooming a still picture

Press **ZOOM** while playing back a JPEG file.

- Each press of **ZOOM** changes the magnification.
- To resume normal playback, press **ENTER**.

Editing with another video recorder or a camcorder

You can use your recorder as the source player or the recording deck. You can use a camcorder as the source player and your recorder as the recording deck. Refer also to the other components' instruction manuals for connection and its operations.

When using the unit as the source player

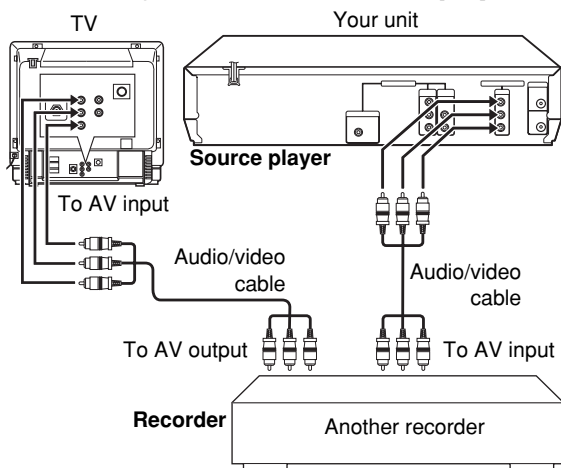

When using the unit as the recorder

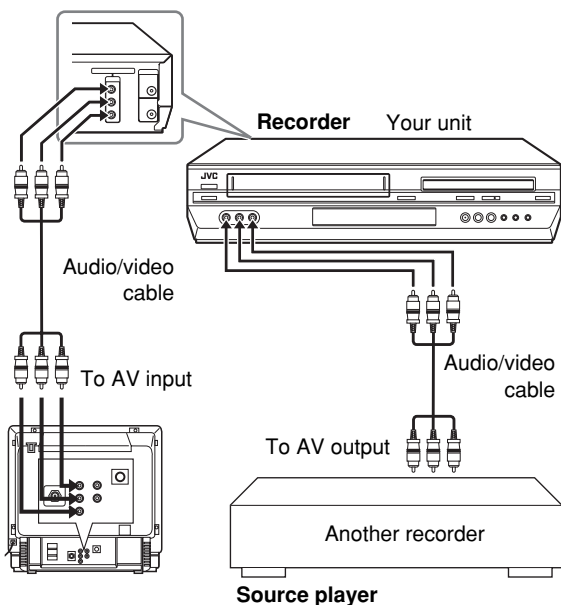

1 Make connections.

Connection with another video recorder

- 1 When using your unit as the source player ... connect its AUDIO/VIDEO OUTPUT connectors on the rear panel to the recording deck.
- 2 When using your unit as the recording deck ... connect its VIDEO/AUDIO connectors on the front panel to the source player.

Connection with a camcorder

Connect the camcorder's AUDIO/VIDEO OUT connectors to the unit's VIDEO/AUDIO connectors on the front panel via a cable adapter.

2 Select the VCR deck.

Press **VCR** on the Remote so that the VHS indicator lights up on the front display panel.

3 Load cassettes.

Insert the playback cassette into the source player and the cassette to be recorded on into the recording deck.

4 Select input mode on recording deck.

Select the correct external input on the recording deck. On this recorder, press **AUX** (number button "0") and/or **CH +/-** to select "F-1."

5 Select edit mode.

See "PICTURE CONTROL" on page 32.

6 Set the recorder to the record pause mode.

Locate the point where you start recording on the source player, then operate the recorder so that recording is paused.

7 Start playback on the source player.

8 Start recording on the recorder.



Dubbing from DVD to VCR

- Turn on the TV and select the VCR channel (or AV mode).
- Slide the **TV/VCR/DVD** switch on the Remote to the right.

1 Load a cassette and place a disc.

2 Prepare the VCR deck for dubbing.

- 1 Press **VCR**.
- 2 Press **SP/EP** to select recording speed.
- 3 Search for the point where you want to start dubbing.

3 Prepare the DVD deck for dubbing.

- 1 Press **DVD**.
- 2 Search for the point where you want to start dubbing.
- 3 Press **II PAUSE** to pause playback.

4 Start dubbing.

Press and hold **● REC**, then press **▶ PLAY** on the Remote.

- “*dub* (dub)” lights on the front display panel.

5 End dubbing.

Press **■ STOP**.

- Be sure to press **■ STOP** while the VCR indicator lights up on the unit.

NOTES:

- It is not possible to dub the copy-protected disc.
- Set “ON SCREEN GUIDE” to “OFF” (pg. 35) if you do not want to record the on-screen display for DVD discs during dubbing.

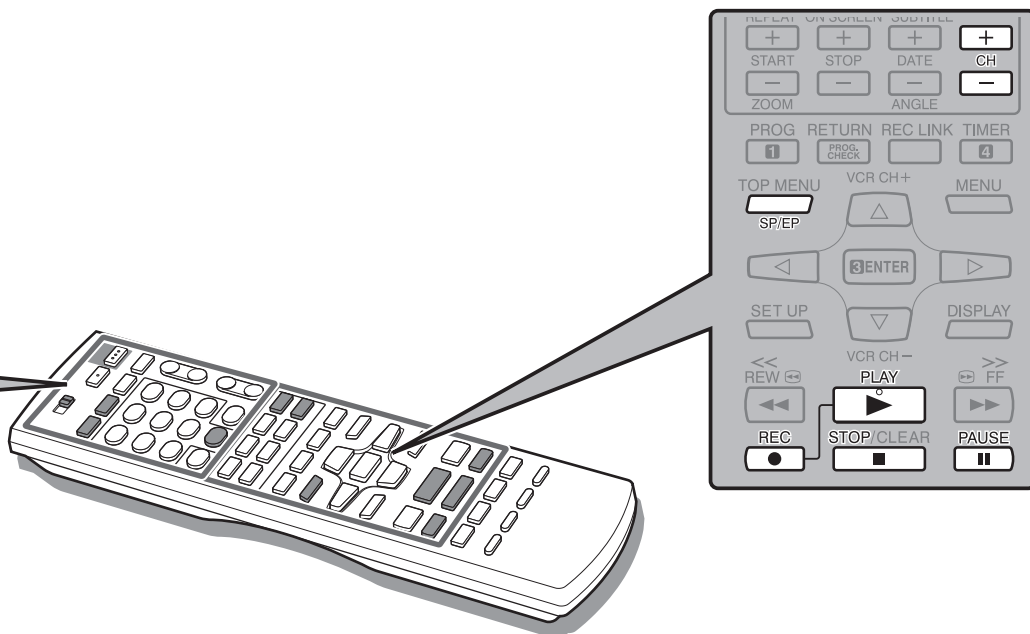

System Connections

Connecting To A Dolby Digital Decoder or An Amplifier With A Built-in DTS (DVD deck only)

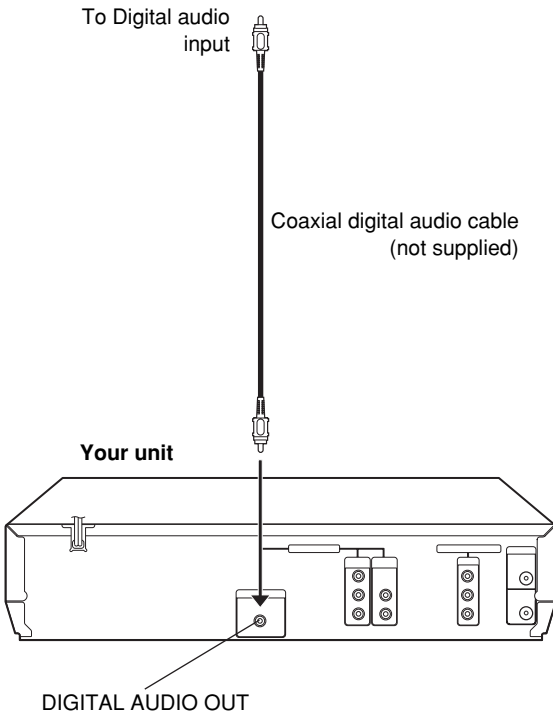
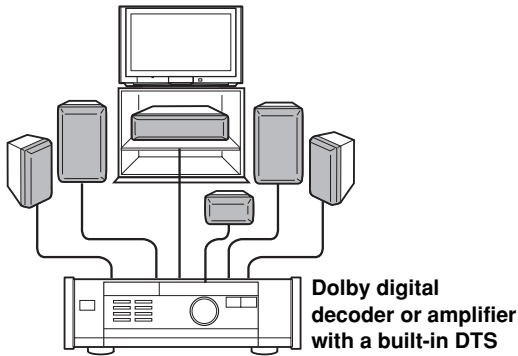

These instructions enable you to connect your unit to dolby digital decoder or amplifier with a built-in DTS. Connect the coaxial cable between the unit and the Dolby Digital decoder or amplifier with a built-in DTS.

NOTES:

- For Dolby digital sound, set "DIGITAL AUDIO OUTPUT" to "DOLBY DIGITAL/PCM." (pg. 35)
- For DTS sound, set "DIGITAL AUDIO OUTPUT" to "STREAM/PCM." (pg. 35)

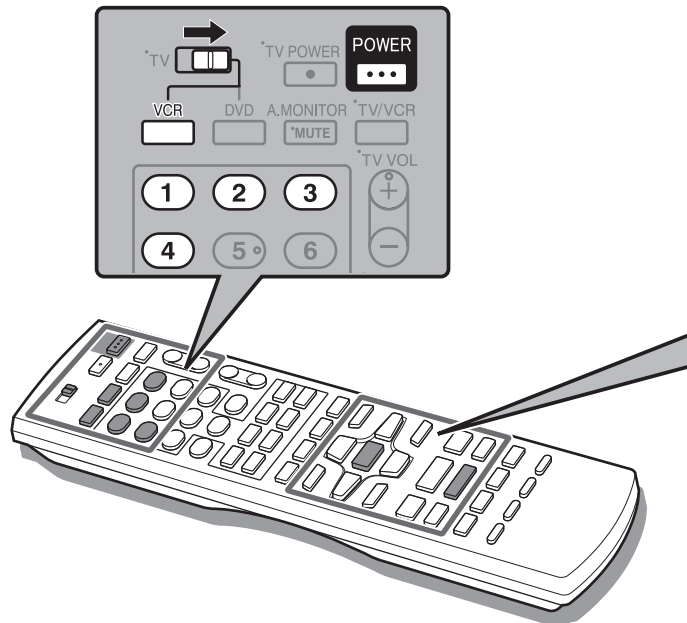

Other Functions

Slide the TV/VCR/DVD switch on the Remote to the right.

Remote A/B/C/D Code Switching

The Remote is capable of controlling four JVC video units independently. Each of units can respond to one of four codes (A, B, C or D). The preset code is A.

On the Remote

Keep pressing **VCR** down during steps ① - ②.

① Change the Remote code.

Press the **number button** "1" for A, "2" for B, "3" for C or "4" for D.

② Set the Remote code.

Press **ENTER** to set the code.

NOTE:

Once the batteries are removed, the Remote code is back to A.

On the unit

① Turn off the unit.

Press **POWER** on the unit.

② Display the code.

Press **▶ PLAY** on the unit for over 5 seconds while the unit is turned off. The code currently set appears on the front display panel.

③ Change the unit's code.

Press **■ STOP** on the unit. The code currently set on the Remote will be applied to the unit.

NOTE:

Even if you unplug the end of the mains power cord from the mains, the code currently set remains.

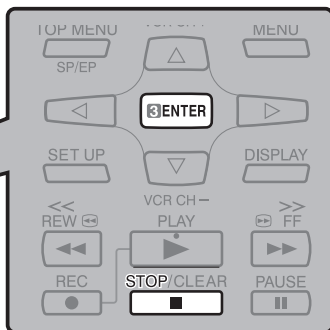

Child Lock

You can disable the unit's operation.

① Set the Child Lock.

Press and hold **POWER** on the Remote for more than 10 seconds while the unit is turned on. The unit turns off, and "CL (CL)" appears on the front display panel.

- To release the child lock, press and hold **POWER** on the Remote until the unit turns on.

NOTE:

Timer recording programs will be performed even if the child lock function is activated.

Tray Lock

You can lock the disc tray to prohibit the unwanted disc ejection by children.

To lock the disc tray

While the unit is turned off, press and hold **■ STOP**, then press **▲ OPEN/CLOSE** on the unit.

"L oc (Lock)" appears on the front display panel and the disc tray is locked.

To unlock tray

While the unit is turned off, press and hold **■ STOP**, then press **▲ OPEN/CLOSE** on the unit.

"U nL oc (Unlock)" appears on the front display panel.

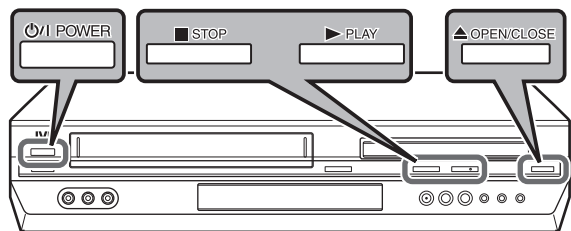

Subsidiary Settings

Mode Set (VCR deck)

- Turn on the TV and select the VCR channel (or AV mode).
- Slide the **TV/VCR/DVD** switch on the Remote to the right.

You can change various mode settings on the Function Set screen.

1 Select the VCR deck.

Press **VCR** on the Remote so that the VHS indicator lights up on the front display panel.

2 Access the Main Menu screen, then select the Function Set.

- 1 Press **SET UP** to access the Main Menu screen.
- 2 Press $\Delta \nabla$ to move the highlight bar (arrow) to "FUNCTION SET," then press **ENTER**.

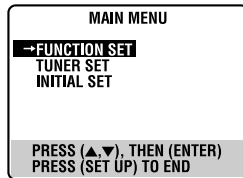

3 Select the mode.

Press $\Delta \nabla$ to move the highlight bar (arrow) to the item you want to change.

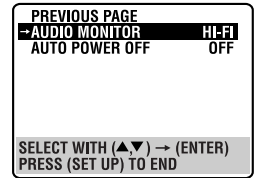
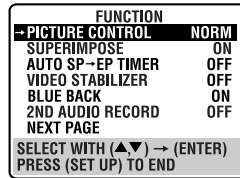

4 Select the mode setting.

Press **ENTER**.

5 Press SET UP to return to the normal screen.

* The default setting is **bold** in the table below.

PICTURE CONTROL NORM EDIT SOFT SHARP	<p>This feature helps you to adjust the playback picture quality according to your preference. Normally select "NORM."</p> <p>NORM: Picture quality is adjusted automatically. EDIT: Minimizes picture degradation during editing (recording and playback). SOFT: Reduces image coarseness when viewing overplayed tapes containing a lot of noise. SHARP: Clearer, sharper-edged picture when viewing images with lots of flat, same-colored surfaces such as cartoons.</p> <p>NOTES:</p> <ul style="list-style-type: none"> • When you select "EDIT," "SOFT" or "SHARP," the selected mode will not change until you select another mode. • When you select "EDIT" to dub tapes, be sure to select "NORM" after you finish dubbing the tapes. 						
SUPERIMPOSE ON OFF	<p>When this function is set to "ON," various operational indicators appear on the TV screen. Messages appear in the selected language. (pg. 15)</p> <p>NOTES:</p> <ul style="list-style-type: none"> • When you use this unit as the source player for editing, be sure to set "SUPERIMPOSE" to "OFF" before starting. • During playback, the operation mode indicators may be disturbed depending on the type of tape being used. 						
AUTO SP →EP TIMER ON OFF	<p>When this function is set to "ON," the unit automatically switches to EP mode to allow complete recording if there is not enough tape to record the entire program while timer-recording in SP mode.</p> <p>For Example:</p> <table border="1" style="margin-left: auto; margin-right: auto;"> <tr> <td style="text-align: center;">Approximately 110 minutes</td> <td style="text-align: center;">Approximately 30 minutes</td> </tr> <tr> <td style="text-align: center;">SP mode</td> <td style="text-align: center;">EP mode</td> </tr> <tr> <td colspan="2" style="text-align: center;">Total 140 minutes</td> </tr> </table> <p>Make sure you set this function to "ON," before the timer-recording starts.</p> <p>NOTES:</p> <ul style="list-style-type: none"> • If you have programmed the unit to timer-record 2 or more programs, the second program and those thereafter may not fit on the tape if you set "AUTO SP →EP TIMER" to "ON." In this case, make sure the mode is not engaged, then set the tape speed manually during timer programming. • In order to ensure that the recording fits on the tape, this feature may leave a slight nonrecorded section at the end of the tape. • There may be some noise and sound disturbance at the point on the tape where the unit switches from SP to EP mode. • The Auto SP →EP Timer feature is not available during ITR (Instant Timer Recording), and the feature will not work properly on the following tapes: T(ST)-30, T(ST)-60, T(ST)-90, and T(ST)-120. 	Approximately 110 minutes	Approximately 30 minutes	SP mode	EP mode	Total 140 minutes	
Approximately 110 minutes	Approximately 30 minutes						
SP mode	EP mode						
Total 140 minutes							

VIDEO STABILIZER ON OFF	When this function is set to "ON," you can automatically correct vertical vibration in the picture when playing back unstable recordings made on another recorder. NOTES: <ul style="list-style-type: none"> • When you finish viewing a tape, be sure to set this function to "OFF." • Regardless of the setting, this function has no effect during recording and during special effects playback. • The on-screen display may jitter vertically when this function is set to "ON." • To watch recordings with close-caption, set this function to "OFF."
BLUE BACK ON OFF	When this function is set to "ON," the TV screen becomes all blue when receiving a channel not in use. NOTE: When you want to receive an unstable channel with poor signals, set this function to "OFF."
2ND AUDIO RECORD ON OFF	<ul style="list-style-type: none"> • When this function is set to "ON"; If a SAP program is received, the SAP audio is recorded on both the normal and Hi-Fi tracks. The main audio is not recorded. If a non-SAP program is received, the main audio is recorded on both the Hi-Fi and normal tracks. • When this function is set to "OFF"; the SAP audio cannot be recorded. NOTES: When the channel is changed on the unit; <ul style="list-style-type: none"> • The "STEREO" indicator appears on the screen for about 5 seconds if the program is a stereo broadcast. • The "SAP" indicator appears on the screen for about 5 seconds if the program is a SAP broadcast. • Both indicators appear when a stereo program is accompanied by SAP sound.
AUDIO MONITOR HI-FI HI-FI L HI-FI R NORM MIX	This unit can record two sound tracks simultaneously (normal and Hi-Fi) on a Hi-Fi stereo tape. You can select the sound track(s) to listen to while playing back a Hi-Fi stereo tape. In addition, when playing back a prerecorded tape containing two separate audio programs on the Hi-Fi tracks, you can choose either one by selecting either "HI-FI L" or "HI-FI R." HI-FI: Normally select this. Hi-Fi sound is played back. HI-FI L: Sound on the left Hi-Fi channel is played back. HI-FI R: Sound on the right Hi-Fi channel is played back. NORM: Sound on the normal track is played back. MIX: Both sounds on the Hi-Fi track and normal track are mixed and played back. NOTES: <ul style="list-style-type: none"> • While playing back a monaural tape, sounds on the normal track will be heard regardless of this setting. • You can also use the A.MONITOR button on the Remote to select the desired monitor sound. (pg. 19)
AUTO POWER OFF 3H OFF	When this function is set to "3H," the unit is turned off automatically if no operation is done within 3 hours. "AUTO POWER OFF IN 3 MIN" appears on the screen 3 minutes before the unit is turned off.

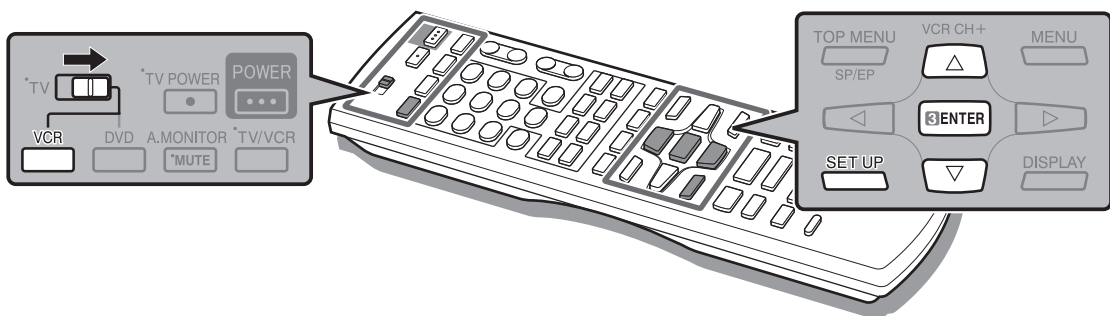

Subsidiary Settings (continued)

Mode Set (DVD deck)

- Turn on the TV and select the VCR channel (or AV mode).
- Slide the **TV/VCR/DVD** switch on the Remote to the right.

1 Select the DVD deck.

Press **DVD** on the Remote so that the DVD indicator lights up on the front display panel.

2 Access the DVD Set Up Menu screen.

- 1 Press **SET UP**.
- 2 Press **<>** to select the menu.

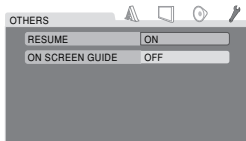

- Each time you press the button, the setup menus change as follows,

A LANGUAGE → **P**ICTURE → **A**AUDIO →
OTHERS → (Back to the beginning)

3 Select the mode.

Press **Δ∇** to move the highlight to the mode you want to change, then press **ENTER**.

4 Select the mode setting.

Press **Δ∇** to select the desired setting, then press **ENTER**.

5 Return to the normal screen.

Press **SET UP**.

NOTE:

About "LANGUAGE" menu, see "Language Set" on page 13.

The default setting is **bold** in the table below.

Picture Settings

MONITOR TYPE 16:9 4:3 LB 4:3 PS	You can select the monitor type depending the TV used when you play back DVD VIDEO discs recorded for wide-screen TVs. For more details, refer to "Monitor Set (DVD deck)." (pg. 12)
PICTURE SOURCE AUTO FILM VIDEO	You can obtain optimal picture quality by selecting whether the content on the disc is processed by field (video source) or by frame (film source). Normally set to "AUTO." AUTO: Used to play back a disc containing both video and film source materials. This unit recognizes the picture type (film or video source) of the current disc according to the disc information. FILM: Suitable for playing back a film or progressive source disc. VIDEO: Suitable for playing back a video source disc with relatively a few moments. • If the playback picture is unclear or noisy, or the oblique lines of the picture are rough, try to change to other modes.
SCREEN SAVER ON OFF	The TV screen may be burned out if a static picture is displayed for a long time. When this function is set to "ON," the unit automatically activates the screen saver function if a static picture, such as an on-screen display or menu is displayed for over 5 minutes.
FILE TYPE AUDIO STILL PICTURE	You can select files to play back, when both MP3 files and JPEG files are recorded on a disc. AUDIO: Select this to play back MP3 files. STILL PICTURE: Select this to play back JPEG files. NOTE: Be sure to open and close the disc tray after changing the setting. The unit reads the disc again and the selected file type can be recognized.

Audio Settings

<p>DIGITAL AUDIO OUTPUT</p> <p>PCM ONLY DOLBY DIGITAL/PCM STREAM/PCM</p>	<p>Set to the appropriate mode according to the type of the device connected to DIGITAL AUDIO OUT connector on the rear of unit. Set this item correctly according to the logo on the device. It is not necessary to set this mode when you connect no device to DIGITAL AUDIO OUT connector.</p> <p>PCM ONLY: Select this when connecting to a device bearing neither Dolby Digital nor DTS logo, or a digital recorder.</p> <p>DOLBY DIGITAL/PCM: Suitable for playing back a film or progressive source disc.</p> <p>STREAM/PCM: Select this when connecting an amplifier or a decoder bearing both Dolby Digital and DTS logos.</p>
<p>DOWN MIX</p> <p>DOLBY SURROUND STEREO</p>	<p>Set to the appropriate mode according to your audio system when you play back a DVD VIDEO disc recorded with surround multichannel audio. This setting affects only the analog audio output signal from the AUDIO OUTPUT connectors (DVD) when playing back a DVD VIDEO disc recorded with surround multichannel audio.</p> <p>DOLBY SURROUND: Select this when you enjoy multichannel surround audio by connecting the unit's analog AUDIO OUTPUT connector (DVD) to a surround decoder.</p> <p>STEREO: Select this when you enjoy conventional 2-channel stereo audio by connecting the unit's analog AUDIO OUTPUT connectors (DVD) to a stereo amplifier/receiver or TV, or when you dub audio of a DVD VIDEO disc recorded with surround audio to your MD, cassette, etc.</p>
<p>D. RANGE COMPRESSION</p> <p>AUTO ON</p>	<p>You can compress the dynamic range (the difference between the loudest and quietest audio signals) of the sound when listening to the sound at a low volume or at night. This function is available with DVD VIDEO discs recorded with the Dolby Digital format. Set to the appropriate mode according to the number of channels recorded.</p> <p>AUTO: Audio is played back with channels other than Dolby Digital channel 1 or 2 compressed. ON: Audio is played back with all channel compressed.</p>

Other Settings

<p>RESUME</p> <p>ON OFF</p>	<p>When this function is set to "ON," you can use the resume function. (Ⓜ pg. 24)</p> <p>ON: The unit resumes playback from the position where playback has been stopped. OFF: This function is deactivated.</p> <p>NOTE: This function is not available for Audio CDs and MP3 discs.</p>
<p>ON SCREEN GUIDE</p> <p>ON OFF</p>	<p>When this function is set to "ON," the unit can display "on-screen guide" icons or characters which shows the conditions of the unit or disc.</p>

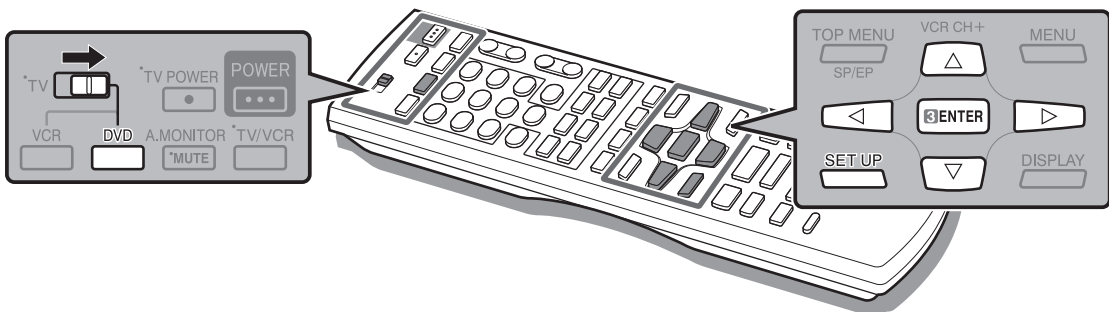

Troubleshooting

Power

SYMPTOM	POSSIBLE CAUSE	CORRECTIVE ACTION
No power is supplied to the unit.	• The AC power cord is disconnected.	Connect the AC power cord.
The Remote does not function.	• The batteries are discharged.	Replace the dead batteries with new ones.

Playback

SYMPTOM	POSSIBLE CAUSE	CORRECTIVE ACTION
The VCR deck cannot be operated.	• The VCR deck is not selected.	Press VCR/DVD on the unit or VCR on the Remote so that the VHS indicator lights up on the front display panel.
The playback picture does not appear on the TV screen.	<ul style="list-style-type: none"> • If you are using the RF connection, <ul style="list-style-type: none"> – the TV receiver's channel selector is not set to the VCR channel. – the unit's VCR channel has not been correctly set. • If you are using the AV or Component Video* connection, the TV receiver is not set to the AV mode. * (DVD deck only)	If you are using the RF connection, <ul style="list-style-type: none"> – set the TV receiver to the VCR channel. – perform "Set the VCR channel." (pg. 9) If you are using the AV or Component Video* connection, set the TV to its AV mode. * (DVD deck only)
The button do not work.	• The operation is prohibited on the placed disc.	_____
The DVD deck cannot be operated.	• The DVD deck is not selected.	Press VCR/DVD on the unit or DVD on the Remote so that the DVD indicator lights up on the front display panel.
"Ⓞ" appears on the TV screen.	• The operation is prohibited on the placed disc.	_____
"REGION CODE ERROR!" appears on the TV screen.	• The disc's region number does not match that of the unit.	Use the discs whose region number includes "ALL" or "1."

Recording

SYMPTOM	POSSIBLE CAUSE	CORRECTIVE ACTION
Recording cannot be started.	• There is no cassette loaded, or the cassette loaded has had its record safety tab removed.	Insert a cassette, or using adhesive tape, cover the hole where the tab was removed.
TV broadcasts cannot be recorded.	• "F-1" has been selected as the input mode.	Set to the desired channel.
Timer recording does not work.	<ul style="list-style-type: none"> • The clock and/or the timer have been set incorrectly. • The timer is not engaged. 	Re-perform the clock and/or timer settings. Press TIMER and confirm that "Ⓞ" is displayed on the front display panel.
Timer programing is not possible.	• Timer recording is in progress.	Timer programing cannot be performed while a timer recording is in progress. Wait until it finishes.

ATTENTION

This unit contains microcomputers. External electronic noise or interference could cause malfunctioning. In such cases, switch the unit off and unplug the AC power cord. Then plug it in again and turn the unit on. Take out the cassette. After checking the cassette, operate the unit as usual.

Questions & Answers

PLAYBACK

Q. What happens if the end of the tape is reached during playback or search?

→A. The tape is automatically rewound to the beginning.

Q. During search, slow, still and frame-by-frame playback, I can't hear any audio. What's the problem?

→A. This is normal.

Q. Can the unit indefinitely remain in the still mode?

→A. No. It stops automatically after 5 minutes to protect the heads.

Q. When returning from search to normal playback, the picture is disturbed. Should I be concerned about this?

→A. No, it is normal.

Q. Noise bar appear during search. What's the problem?

→A. This is normal.

Q. Sometimes, during Index Search, the unit can't find the program I want to see. Why not?

→A. There may be index codes too close together.

RECORDING

Q. When I pause and then resume a recording, the end of the recording before the pause is overlapped by the beginning of the continuation of recording. Why does this happen?

→A. This is normal. It reduces distortion at the pause and resume points.

Q. Can the unit indefinitely remain in the Record-Pause mode?

→A. No. The unit goes to its Stop mode automatically after 5 minutes to protect the heads.

Q. What happens if the tape runs out during recording?

→A. The unit stops recording, and "●" and "▶" on the front display panel will not stop blinking.

TIMER RECORDING

Q. "●" and "⌚" remain lit on the front display panel. Is there a problem?

→A. No. This is a normal condition for a timer recording in progress.

Q. Can I program the timer while I'm watching a tape or a TV broadcast?

→A. You will not see the picture as it is replaced by the on-screen menu, but the audio from the program or tape you are viewing can be heard.

Language Code List

AA	Afar	EU	Basque	KL	Greenlandic	OC	Occitan	ST	Sesotho
AB	Abkhazian	FA	Persian	KM	Cambodian	OM	(Afan) Oromo	SU	Sundanese
AF	Afrikaans	FI	Finnish	KN	Kannada	OR	Oriya	SV	Swedish
AM	Ameharic	FJ	Fiji	KO	Korean (KOR)	PA	Panjabi	SW	Swahili
AR	Arabic	FO	Faroese	KS	Kashmiri	PL	Polish	TA	Tamil
AS	Assamese	FY	Frisian	KU	Kurdish	PS	Pashto, Pushto	TE	Telugu
AY	Aymara	GA	Irish	KY	Kirghiz	PT	Portuguese	TG	Tajik
AZ	Azerbaijani	GD	Scots Gaelic	LA	Latin	QU	Quechua	TH	Thai
BA	Bashkir	GL	Galician	LN	Lingala	RM	Rhaeto-Romance	TI	Tigrinya
BE	Byelorussian	GN	Guarani	LO	Laothian	RN	Kirundi	TK	Turkmen
BG	Bulgarian	GU	Gujarati	LT	Lithuanian	RO	Rumanian	TL	Tagalog
BH	Bihari	HA	Hausa	LV	Latvian, Lettish	RU	Russian	TN	Setswana
BI	Bislama	HI	Hindi	MG	Malagasy	RW	Kinyarwanda	TO	Tonga
BN	Bengali, Bangla	HR	Croatian	MI	Maori	SA	Sanskrit	TR	Turkish
BO	Tibetan	HU	Hungarian	MK	Macedonian	SD	Sindhi	TS	Tsonga
BR	Breton	HY	Armenian	ML	Malayalam	SG	Sangho	TT	Tatar
CA	Catalan	IA	Interlingua	MN	Mongolian	SH	Serbo-Croatian	TW	Twi
CO	Corsican	IE	Interlingue	MO	Moldavian	SI	Singhalese	UK	Ukrainian
CS	Czech	IK	Inupiak	MR	Marathi	SK	Slovak	UR	Urdu
CY	Welsh	IN	Indonesian	MS	Malay (MAY)	SL	Slovenian	UZ	Uzbek
DA	Danish	IS	Icelandic	MT	Maltese	SM	Samoan	VI	Vietnamese
DZ	Bhutani	IW	Hebrew	MY	Burmese	SN	Shona	VO	Volapuk
EL	Greek	JI	Yiddish	NA	Nauru	SO	Somali	WO	Wolof
EO	Esperanto	JW	Javanese	NE	Nepali	SQ	Albanian	XH	Xhosa
ET	Estonian	KA	Georgian	NL	Dutch	SR	Serbian	YO	Yoruba
		KK	Kazakh	NO	Norwegian	SS	Siswati	ZU	Zulu

Specifications

GENERAL

Power requirement	: AC 110 V – 220 V \sim , 50 Hz/60 Hz
Power consumption	
Power on	: 25 W
Power off	: 4.0 W
Temperature	
Operating	: 5°C to 40°C (41°F to 104°F)
Storage	: –20°C to 60°C (–4°F to 140°F)
Operating position	: Horizontal only
Dimensions (WxHxD)	: 435 mm x 93 mm x 272 mm
Weight	: 4.1 kg
Format	: VHS NTSC standard
Maximum recording time	
(SP)	: 210 min. with T-210 video cassette
(EP)	: 630 min. with T-210 video cassette

VIDEO/AUDIO (VCR deck)

Signal system	: NTSC color signal and EIA monochrome signal, 525 lines/60 fields
Recording system	: DA4 (Double Azimuth) head helical scan system
Signal-to-noise ratio	: 45 dB
Horizontal resolution	: 230 lines
Frequency range	: 70 Hz to 10,000 Hz (Normal audio) 20 Hz to 20,000 Hz (Hi-Fi audio)
Input/Output	: RCA connectors: IN x 1, OUT x 1

VIDEO/AUDIO (DVD deck)

Signal system	: NTSC
Applicable disc	: DVD (12 cm, 8 cm) CD (12 cm, 8 cm)
Audio characteristics	
DVD	: 4 Hz – 22 KHz
Frequency response	
CD	: 4 Hz – 20 KHz

S/N Ratio	: 90 dB
Harmonic distortion	: 0.1%
Wow and flutter	: Below Measurable Level
Dynamic range	: 90 dB
Output	
Component-Y	: (RCA) 1.0 Vp-p/75 ohm
Component-PB/PR	: (RCA) 0.7 Vp-p/75 ohm
Audio	: (RCA) 2 Vrms, 1 Kohm
Digital Audio	: (COAXIAL) 0.5 Vp-p/75 ohm

TUNER

Tuning system	: Frequency synthesized tuner
Channel coverage	
VHF	: Channels 2 – 13
UHF	: Channels 14 – 69
CATV	: 113 Channels
RF output	: Channel 3 or 4 (switchable; preset to Channel 3 when shipped) 75 ohms, unbalanced

TIMER

Clock reference	: Quartz
Program capacity	: 1-year programmable timer/ 8 programs

Specifications shown are for SP mode unless otherwise specified.

E. & O.E. Design and specifications subject to change without notice.

List of Terms

B

Buttons, Connectors, and Indicators	
Front View	7
Front Display Panel	7
Rear View	7
Remote	8

C

Check, cancel and change programs	22
Child Lock	31
Clock Set	14
Connections	
Basic Connections	9
Component Video Connection	10
Connecting To A Dolby Digital Decoder or An Amplifier With A Built-in DTS (DVD deck only)	30

D

Dubbing from DVD to VCR	29
-------------------------------	----

E

Editing with another video recorder or a camcorder	28
Express Timer Programming	21

I

Instant Timer Recording (ITR)	20
-------------------------------------	----

M

Mode Set (VCR deck)	
2ND AUDIO RECORD	33
AUDIO MONITOR	33
AUTO POWER OFF	33
AUTO SP → EP TIMER	32
BLUE BACK	33
PICTURE CONTROL	32
SUPERIMPOSE	32
VIDEO STABILIZER	33
Mode Set (DVD deck)	
AUDIO LANGUAGE	13
D. RANGE COMPRESSION	35
DIGITAL AUDIO OUTPUT	35
DOWN MIX	35
FILE TYPE	34
MENU LANGUAGE	13
MONITOR TYPE	34
ON SCREEN GUIDE	35
ON SCREEN LANGUAGE	13
PICTURE SOURCE	34
RESUME	35
SCREEN SAVER	34
SUBTITLE	13
Monitor Set (DVD deck)	12

L

Language Code List	38
Language Set	
Menu/Audio/Subtitle Language Set (DVD deck only)	13
On-screen Language Set (DVD deck)	13
On-screen Language Set (VCR deck)	12

O

On-Screen Display (VCR Deck)	17
------------------------------------	----

P

Playable discs	6
Playback on DVD Deck	
Changing the language, sound, and scene angle	25
Changing the picture tone (VFP)	25
Changing the Sound Field	25
Menu Bar Functions	26
MP3/JPEG Files Playback	27
One Touch Replay	24
Repeat Playback	25
Using the disc menu	24
Zooming the picture	24
Playback on VCR Deck	
Adjusting Tracking Condition	19
Index Search	18
Instant ReView	18
Next Function Memory	18
One Touch Replay	19
Repeat Playback	19
Selecting Soundtrack	19
Skip Search	18
Plug&Play Set	11

Q

Questions & Answers	37
---------------------------	----

R

Region code	2
Remote A/B/C/D Code Switching	31

S

Satellite Auto Recording	23
Scan Mode Set	11
Second Audio Recording	20
Specifications	38

T

Tape Remaining Time/Time Counter	20
To cancel or change a program	22
Tray Lock	31
Troubleshooting	36
Tuner Set	
Auto Channel Set	15
Manual Channel Set	15

U

Unplayable discs	6
Usable cassette	6

W

Watching one programme while recording another	20
When programs overlap each other	22

JVC

Free Manuals Download Website

<http://myh66.com>

<http://usermanuals.us>

<http://www.somanuals.com>

<http://www.4manuals.cc>

<http://www.manual-lib.com>

<http://www.404manual.com>

<http://www.luxmanual.com>

<http://aubethermostatmanual.com>

Golf course search by state

<http://golfingnear.com>

Email search by domain

<http://emailbydomain.com>

Auto manuals search

<http://auto.somanuals.com>

TV manuals search

<http://tv.somanuals.com>