

JVC

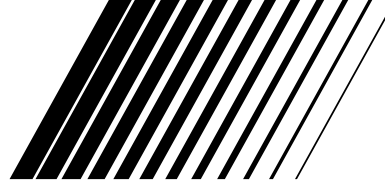

DVD PLAYER & VIDEO CASSETTE RECORDER

HR-XVC38BU HR-XVC39SU

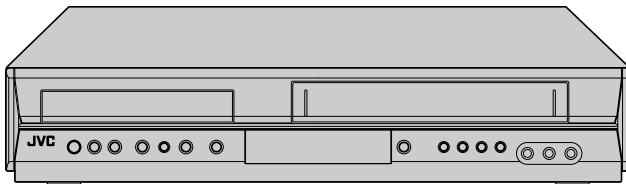
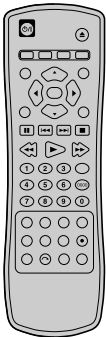

HDMI™
HIGH DEFINITION MULTIMEDIA INTERFACE

Hi-Fi

VHS

SQP/B

DVD
VIDEO

dts
DIGITAL OUT

DD DOLBY
DIGITAL

COMPACT
disc
DIGITAL VIDEO

COMPACT
disc
SUPER VIDEO

COMPACT
disc
DIGITAL AUDIO

INSTRUCTIONS

For Customer Use:

Enter below the Model No. and
Serial No. which are located on the
rear of cabinet. Retain this
information for future reference.

Model No. _____

Serial No. _____

LPT1128-001A



CAUTION
RISK OF ELECTRIC SHOCK
DO NOT OPEN



CAUTION: TO REDUCE THE RISK OF ELECTRIC SHOCK DO NOT REMOVE COVER (OR BACK) NO USER-SERVICEABLE PARTS INSIDE REFER SERVICING TO QUALIFIED SERVICE PERSONNEL.



This lightning flash with arrowhead symbol within an equilateral triangle is intended to alert the user to the presence of uninsulated dangerous voltage within the product's enclosure that may be of sufficient magnitude to constitute a risk of electric shock to persons.



The exclamation point within an equilateral triangle is intended to alert the user to the presence of important operating and maintenance (servicing) instructions in the literature accompanying the product.

WARNING: TO PREVENT FIRE OR ELECTRIC SHOCK HAZARD, DO NOT EXPOSE THIS PRODUCT TO RAIN OR MOISTURE.

CAUTION: Do not block any ventilation openings. Install in accordance with the manufacturer's instructions.

Slots and openings in the cabinet are provided for ventilation and to ensure reliable operation of the product and to protect it from over heating.

The openings should be never be blocked by placing the product on a bed, sofa, rug or other similar surface. This product should not be placed in a built-in installation such as a bookcase or rack unless proper ventilation is provided or the manufacturer's instruction have been adhered to.

CLASS 1 LASER PRODUCT
KLASSE 1 LASER PRODUKT
LUOKAN 1 LASER LAITE
KLASS 1 LASER APPARAT
CLASSE 1 PRODUIT LASER

CAUTION:

This product employs a Laser System.

To ensure proper use of this product, please read this owner's manual carefully and retain it for future reference. Should the unit require maintenance, contact an authorized service center.

Performing controls, adjustments, or carrying out procedures other than those specified herein may result in hazardous radiation exposure.

To prevent direct exposure to laser beam, do not try to open the enclosure. Visible laser radiation when open. **DO NOT STARE INTO BEAM.**

CAUTION: The apparatus should not be exposed to water (dripping or splashing) and no objects filled with liquids, such as vases, should be placed on the apparatus.

CAUTION:

VISIBLE AND INVISIBLE LASER RADIATION WHEN OPEN AND INTERLOCKS DEFEATED

CAUTION:

Changes or modifications not approved by JVC could void user's authority to operate the equipment.

REGULATORY INFORMATION: FCC Part 15

This equipment has been tested and found to comply with the limits for a Class B digital device, pursuant to Part 15 of the FCC Rules. These limits are designed to provide reasonable protection against harmful interference when the product is operated in a residential installation. This product generates, uses, and can radiate radio frequency energy and, if not installed and used in accordance with the instruction manual, may cause harmful interference to radio communications. However, there is no guarantee that interference will not occur in a particular installation. If this product does cause harmful interference to radio or television reception, which can be determined by turning the product off and on, the user is encouraged to try to correct the interference by one or more of the following measures:

- Reorient or relocate the receiving antenna.
- Increase the separation between the product and receiver.
- Connect the product into an outlet on a circuit different from that to which the receiver is connected.
- Consult the dealer or an experienced radio/TV technician for help.

CAUTION concerning the Power Cord

Most appliances recommend they be placed upon a dedicated circuit;

That is, a single outlet circuit which powers only that appliance and has no additional outlets or branch circuits. Check the specification page of this owner's manual to be certain.

Do not overload wall outlets. Overloaded wall outlets, loose or damaged wall outlets, extension cords, frayed power cords, or damaged or cracked wire insulation are dangerous. Any of these conditions could result in electric shock or fire. Periodically examine the cord of your appliance, and if its appearance indicates damage or deterioration, unplug it, discontinue use of the appliance, and have the cord replaced with an exact replacement part by an authorized service personnel.

Protect the power cord from physical or mechanical abuse, such as being twisted, kinked, pinched, closed in a door, or walked upon. Pay particular attention to plugs, wall outlets, and the point where the cord exits the appliance.

To disconnect power from the mains, pull out the mains cord plug. When installing the product, ensure that the plug is easily accessible.

IMPORTANT SAFETY INSTRUCTIONS

CAUTION: PLEASE READ AND OBSERVE ALL WARNINGS AND INSTRUCTIONS IN THIS OWNER'S MANUAL. AND THOSE MARKED ON THE PRODUCT. RETAIN THIS BOOKLET FOR FUTURE REFERENCE.

This product has been designed and manufactured to assure personal safety. Improper use can result in electric shock or fire hazard. The safeguards incorporated in this product will protect you if you observe the following procedures for installation, use, and servicing.

This product does not contain any parts that can be repaired by the user.

DO NOT REMOVE THE CABINET COVER, OR YOU MAY BE EXPOSED TO DANGEROUS VOLTAGE. REFER SERVICING TO QUALIFIED SERVICE PERSONNEL ONLY.

- 1. Read these instructions.** - All these safety and operating instructions should be read before the product is operated.
- 2. Keep these instructions.** - The safety, operating and use instructions should be retained for future reference.
- 3. Heed all warnings.** - All warnings on the product and in the operating instructions should be adhered to.
- 4. Follow all instructions.** - All operating and use instructions should be followed.
- 5. Do not use this product near water.** - For example: near a bath tub, wash bowl, kitchen sink, laundry tub, in a wet basement; or near a swimming pool; and other areas located near water.
- 6. Clean only with dry cloth.** - Unplug this product from the wall outlet before cleaning. Do not use liquid cleaners.
- 7. Do not block any ventilation openings. Install in accordance with the manufacturer's instructions.** - Slots and openings in the cabinet are provided for ventilation and to ensure reliable operation of the product and to protect it from over-heating. The openings should never be blocked by placing the product on a bed, sofa, rug or other similar surface. This product should not be placed in a built-in installation such as a bookcase or rack unless proper ventilation is provided or the manufacturer's instructions have been adhered to.
- 8. Do not install near any heat sources such as radiators, heat registers, stoves, or other apparatus (including amplifiers) that produce heat.**
- 9. Do not defeat the safety purpose of the polarized or grounding-type plug.** A polarized plug has two blades with one wider than the other. A grounding type plug has two blades and a third grounding prong. The wide blade or the third prong are provided for your safety. If the provided plug does not fit into your outlet, consult an electrician for replacement of the obsolete outlet.
- 10. Protect the power cord from being walked on or pinched particularly at plugs, convenience receptacles, and the point where they exit from the product.**
- 11. Only use attachments/accessories specified by the manufacturer.**



- 12. Use only with the cart, stand, tripod, bracket, or table specified by the manufacturer, or sold with apparatus. When a cart is used, use caution when moving the cart/product combination to avoid injury from tip-over.**
- 13. Unplug this product during lightning storms or when unused for long periods of time.**
- 14. Refer all servicing to qualified service personnel. Servicing is required when the product has been damaged in any way, such as power-supply cord or plug is damaged, liquid has been spilled or objects have fallen into the product, the product has been exposed to rain or moisture, does not operate normally, or has been dropped.**

Contents

Introduction	5-9	Operations - VCR	19-25
Moisture Condensation	5	VCR Tape Playback	19-20
Symbol Used in this Manual	5	Basic Instructions	19
About the  Symbol Display	5	Auto Tracking	19
Notes on Discs	5	Manual Tracking	19
About the Remote Control	5	Search	19
Types of Playable Discs	6	Still Picture and Frame-by-Frame Playback ..	19
Regional Code	6	Slow Motion	20
Selecting the Viewing Source	6	CM SKIP (Commercial Skip)	20
Front Panel	7	VHS Hi-Fi Stereo/MTS Broadcast	20
Remote Control	8	Hi-Fi Stereo Audio Sound	20
Rear Panel	9	MTS (Multi-Channel TV Sound)	20
Preparation	9-18	VCR Tape Recording	21-24
Connecting an Antenna or Cable TV	10	Basic Instructions	21
Basic TV Connections	10-11	Timer Recording	21-22
Optional TV Connections	11	Instant Timer Recording	23
Resolution Setting	11	Recording from External Components	23
HDMI Connection (DVD deck only)	12	Copying from DVD to VCR	24
Connection to an Amplifier	13	On-Screen Display - VCR	24
Initial Settings - VCR	14-15	Additional VCR Information	25
General Operation	14	VCR Auto Play System	25
CLOCK	14	S-VHS Quasi Playback (SQPB)	25
• Auto Clock Set	14	Easy Information	25
• Manual Clock Set	14	Operations - DVD	26-30
PROGRAM	14	Playback Setup	26
TUNING	15	General Features	26-27
• Auto Channel Programming	15	Additional Features	27-28
• To Add or Erase Channels	15	Playing an Audio CD	28
SETUP	15	Programmed Playback	28
• FUNCTION OSD	15	Viewing a JPEG File	29
• AUDIO MODE	15	Playing a DVD VR Format Disc	30
• BROADCAST TYPE	15	Maintenance and Service	30
(STEREO/SAP/MONO)	15	Reference	31-35
• AUDIO OUTPUT	15	Language Codes List	31
(STEREO/LEFT/RIGHT)	15	Area Codes List	31
Displaying Disc Information on-screen	16	Troubleshooting	32-33
Initial Settings - DVD	16-18	Specifications	34
General Operation	16	Warranty (Only in U.S.A.)	35
LANGUAGE	17		
DISPLAY	17		
AUDIO	17		
OTHERS	18		
Remote Control Function	18		

Introduction

To ensure proper use of this product, please read this owner's manual carefully and retain for future reference.

This manual provides information on the operation and maintenance of your DVD+VCR. Should the unit require service, contact an authorized service location.

Moisture Condensation

Never operate the DVD+VCR immediately after moving it from a cold location to a warm location. Leave it for two or three hours without operating it. If you use the DVD+VCR in such a situation, it may damage disc/tapes and internal parts.

Symbol Used in this Manual

Note: Indicates special notes and operating features.

Tip: Indicates tips and hints for making the task easier.

A section whose title has one of the following symbols is applicable only to the disc represented by the symbol.

- ALL** All discs listed below
- DVD** DVD and finalized DVD±R/RW
- VCD** Video CDs
- ACD** Audio CDs

About the Symbol Display

"" may appear on your TV display during operation and indicates that the function is not permitted by this unit or the disc.

Notes on Discs

Handling Discs

Do not touch the playback side of the disc. Hold the disc by the edges so that fingerprints do not get on the surface. Never stick paper or tape on the disc.



Storing Discs

After playing, store the disc in its case. Do not expose the disc to direct sunlight or sources of heat and never leave it in a parked car exposed to direct sunlight.

Cleaning Discs

Fingerprints and dust on the disc can cause poor picture quality and sound distortion. Before playing, clean the disc with a clean cloth. Wipe the disc from the center out.

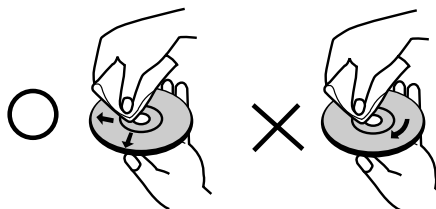

Do not use strong solvents such as alcohol, benzene, thinner, commercially available cleaners, or anti-static spray intended for older vinyl records.

About the Remote Control

Operation Range

Point the remote control at the remote sensor and press the buttons.

Distance: About 23 ft (7 m) from the front of the remote sensor.

Angle: About 30° in each direction of the front of the remote sensor.

Battery installation

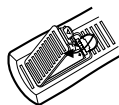



Detach the battery cover on the rear of the remote control, and insert two (R03/AAA) size batteries with ⊕ and ⊖ aligned correctly.



Do not mix old and new batteries and never mix different types of batteries such as standard, alkaline, etc.

Types of Playable Discs

	DVD (8 cm / 12 cm disc)
	Audio CD and Video CD (8 cm / 12 cm disc)

In addition, this unit plays DVD-R, DVD+R, DVD-RW, DVD+RW, SVCD, and CD-R / CD-RW that contains audio titles, and/or JPEG files.

RW COMPATIBLE This indicates a product feature that is capable of playing DVD-RW discs recorded with Video Recording format.

Notes:

- Depending on the conditions of the recording equipment or the CD-R/RW (or DVD±R/RW) disc itself, some CD-R/RW (or DVD±R/RW) discs cannot be played on the unit.
- Only plays if DVD-RW is recorded in Video mode and has been finalized.
- Do not use irregularly shaped CDs (e.g., heart-shaped or octagonal) since they may result in malfunctions.
- This DVD+VCR requires discs and recordings to meet certain technical standards in order to achieve optimal playback quality. Pre-recorded DVDs are automatically set to these standards. There are many different types of recordable disc formats and these require certain pre-existing conditions (see above) to ensure compatible playback.

Regional Code

This unit has a regional code printed on the rear of the unit. This unit can play only DVD discs labeled same as the rear of the unit or "ALL".

Notes on Regional Codes

- Most DVD discs have a globe with one or more numbers in it clearly visible on the cover. This number must match your DVD+VCR's regional code or the disc cannot play.
- If you try to play a DVD with a different region code from your player, the message "Check Regional Code" appears on the TV screen.

Notes on Copyrights:

It is forbidden by law to copy, broadcast, show, broadcast via cable, play in public, or rent copyrighted material without permission.

This product features the copy protection function developed by Macrovision. Copy protection signals are recorded on some discs. When recording and playing the pictures of these discs picture noise will appear. This product incorporates copyright protection technology that is protected by method claims of certain U.S. patents and other intellectual property rights owned by Macrovision Corporation and other rights owners. Use of this copyright protection technology must be authorized by Macrovision Corporation, and is intended for home and other limited viewing uses only unless otherwise authorized by Macrovision Corporation. Reverse engineering or disassembly is prohibited.

Notice for Progressive Scan Use

CONSUMERS SHOULD NOTE THAT NOT ALL HIGH DEFINITION TELEVISION SETS ARE FULLY COMPATIBLE WITH THIS PRODUCT AND MAY CAUSE ARTIFACTS TO BE DISPLAYED IN THE PICTURE. IN CASE OF 525 PROGRESSIVE SCAN PICTURE PROBLEMS, IT IS RECOMMENDED THAT THE USER SWITCH THE CONNECTION TO THE 'STANDARD DEFINITION' OUTPUT. IF THERE ARE QUESTIONS REGARDING OUR TV SET COMPATIBILITY WITH THIS MODEL 525p DVD+VCR, PLEASE CONTACT OUR CUSTOMER SERVICE CENTER.

Selecting the Viewing Source

You must select one of your output sources (DVD or VCR) to view on the TV screen.

- If you want to view DVD deck output source:
 - Press DVD until DVD indicator in the display window lights and output source of DVD deck is viewed on the TV screen.
- If you want to view VCR deck output source:
 - Press VCR until VCR indicator in the display window lights and output source of VCR deck is viewed on the TV screen.

Notes:

- If you insert a disc while the DVD+VCR is in the VCR mode, the DVD+VCR will switch to DVD mode automatically.
- If you insert a cassette tape without prevention tab while the DVD+VCR is in the DVD mode, the DVD+VCR will switch to VCR mode automatically.

Front Panel

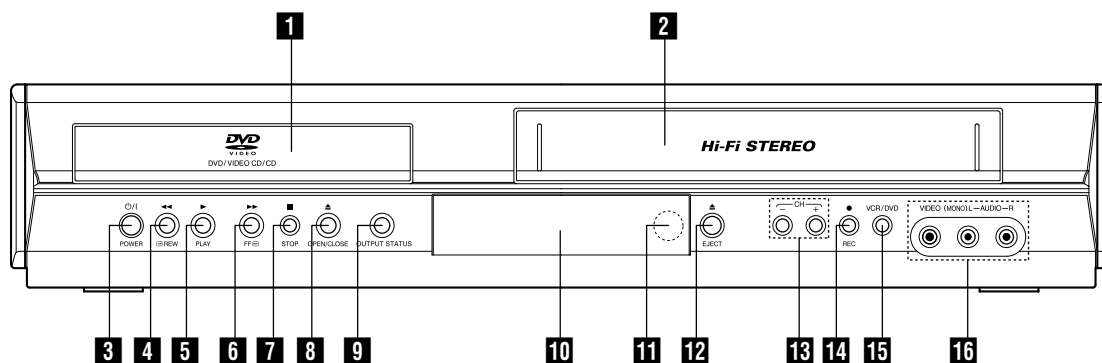

1 Disc Tray (DVD deck)

Insert a disc here.

2 Cassette Compartment (VCR deck)

Insert a video cassette here.

3 POWER

Switches the DVD+VCR ON and OFF.

4 REW

- **DVD:** Skip to beginning of current chapter or track, press twice in quick successions to go to previous chapter or track. Press and hold button for about two seconds to search backward.

- **VCR:** Rewinds the tape during the stop mode or for fast reverse picture search.

5 PLAY

Starts playback of a disc or tape.

6 FF

DVD: Skip to next chapter or track. Press and hold for two seconds for a fast forward search.

VCR: Advances the tape during the STOP mode or for fast forward picture search.

7 STOP

Stops playback of the disc or tape.

8 OPEN/CLOSE

Opens or closes the disc tray.

9 OUTPUT STATUS

You can change the resolution depending on your TV.

- **HDMI mode:** You can switch among the 480p, 720p or 1080i resolution.

- **Component mode:** You can switch among 480i, 480p, 720p or 1080i resolution.

10 Display Windows

DVD The DVD deck is selected.



A disc is in the DVD deck.
(Lights when a disc is in the DVD deck and Flashes when no disc.)



Indicates when the Progressive scan is active.



Indicates repeat mode.



DVD+VCR is in timer recording or a timer recording is programmed. (VCR part only)



A cassette is in the VCR deck.

VCR

The VCR deck is selected.

REC

DVD+VCR is Recording. (VCR part only)

PM

Indicates PM time. (AM is not displayed.)

TV

Lights when TV mode is active.

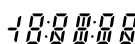

Indicates total playing time, elapsed time, remaining time or current deck status (Playback, Pause, etc).

11 Remote Sensor

Point the DVD+VCR remote control here.

12 EJECT

Ejects the tape in the VCR deck.

13 CH (-/+)

To scan up or down through memorized channels.

14 REC

To record normally or to activate One-touch Timer Recording by repeated presses.

15 DVD/VCR (output select)

Select one of your output sources to view on the TV screen between DVD and VCR.

16 LINE2 (VIDEO/AUDIO (L/R))

Connect to the audio/video output of an external source (Audio system, TV/Monitor, Another VCR).

Remote Control

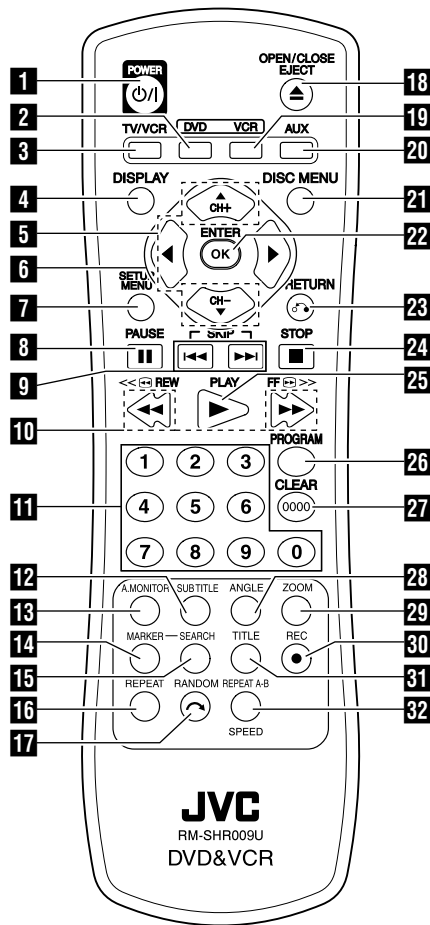

- 1 POWER (⏻/⏿)**
Switches DVD+VCR ON and OFF.
- 2 DVD**
Select the DVD+VCR function mode to DVD.
- 3 TV/VCR**
To view channels selected by the VCR tuner or by the TV tuner.
- 4 DISPLAY**
Accesses On-Screen Display.
Switches between the clock, tape counter and tape remaining modes on the display.
- 5 CH (-/+)**
Selects VCR channels.
Adjusts manually the tape's picture onscreen.
- 6 ◀ ▶ ▲ ▼**
Selects menu options.
- 7 SETUP MENU**
Accesses or removes DVD Setup menu and VCR menu.
- 8 PAUSE (⏸)**
Pause playback or recording temporarily. Press repeatedly for frame-by-frame playback.
- 9 SKIP (⏮ / ⏭)**
Go to next chapter or track. Returns to beginning of current chapter or track or go to previous chapter or track.

- 10 REW (⏮)/FF (⏭)**
- DVD: Search backward or forward.
- VCR: Rewinds/Advances the tape during the STOP mode, for fast backward/forward picture search.
- 11 0-9**
Selects numbered options in a menu.
- 12 SUBTITLE**
Selects a subtitle language.
- 13 A.MONITOR**
Selects an audio language (DVD) or an audio channel (VCD).
- 14 MARKER**
Marks any point during playback.
- 15 SEARCH**
Displays Marker Search menu.
- 16 REPEAT**
Repeat chapter, track, title or all.
- 17 RANDOM**
Plays tracks in random order.
↻
Fast forwards picture search through 30 seconds of recording.
- 18 OPEN/CLOSE (⏏)**
Opens and closes the disc tray.
EJECT (⏏)
Ejects the tape in the VCR deck.
- 19 VCR**
Select the DVD+VCR function mode to VCR.
- 20 AUX**
Selects the VCR deck's source (Tuner, LINE 1, or LINE 2).
- 21 DISC MENU**
Accesses menu on a DVD disc.
- 22 ENTER/OK**
Confirms menu selections.
Displays functions on the TV screen.
- 23 RETURN (⏪)**
Removes the setup menu.
Displays the menu of a video CD with PBC.
- 24 STOP (■)**
Stops playback or recording.
- 25 PLAY (▶)**
Starts playback.
- 26 PROGRAM**
Places a track on the program list.
- 27 CLEAR (0000)**
Removes a mark on the Marker Search menu.
- 28 ANGLE**
Selects a DVD camera angle, if available.
- 29 ZOOM**
Enlarges DVD video image.
- 30 REC (●)**
Starts recording. Press repeatedly to set the recording time.
- 31 TITLE**
Displays the disc's Title menu, if available.
- 32 REPEAT A-B**
Repeats sequence between two points (A and B).
SPEED
Selects recording speed.

Rear Panel



Caution

Do not touch the inner pins of the jacks on the rear panel. Electrostatic discharge may cause permanent damage to the unit.

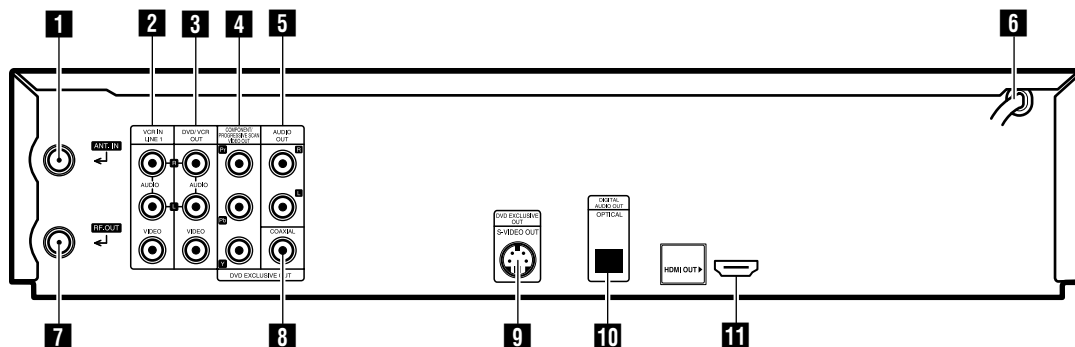

- | | |
|--------------------------------------------------------------------------------------------------------------------------------------------------------------------------------------------------------------------------------------------------------------------------------------------------------------------------------------------------------------------------------------------------------------------------------------------------------------------------------------------------------------------------------------------------------------------------------------------------------------------------------------------------------------------------------------------------------------------|----------------------------------------------------------------------------------------------------------------------------------------------------------------------------------------------------------------------------------------------------------------------------------------------------------------------------------------------------------------------------------------------------------------------------|
| <p>1 ANT.IN
Connect the VHF/UHF/CATV antenna to this terminal.</p> <p>2 VCR IN LINE 1 (VIDEO/AUDIO (Left/Right))
Connect the audio/video output of an external source (Audio system, TV/Monitor, VCR, Camcorder).</p> <p>3 DVD/VCR OUT (VIDEO/AUDIO (Left/Right))
Connect to a TV with video and audio inputs.</p> <p>4 COMPONENT/PROGRESSIVE SCAN VIDEO OUT (Y Pb Pr) (DVD OUT)
Connect to a TV with Y Pb Pr inputs.</p> <p>5 AUDIO OUT (Left/Right) (DVD OUT)
Connect to a TV or other equipment with audio inputs.</p> <p>6 AC Power Cord
Plug into the power source.</p> <p>7 RF. OUT
Connect to a TV with RF coaxial inputs.</p> | <p>8 COAXIAL (DIGITAL AUDIO OUT jack) (DVD OUT)
Connect to digital (coaxial) audio equipment.</p> <p>9 S-VIDEO OUT (DVD OUT)
Connect to a S-Video Input on TV.</p> <p>10 OPTICAL (DIGITAL AUDIO OUT jack) (DVD OUT)
Connect to digital (optical) audio equipment.</p> <p>11 HDMI OUT (DVD OUT)
HDMI output providing a high quality interface for digital audio and video.</p> |
|--------------------------------------------------------------------------------------------------------------------------------------------------------------------------------------------------------------------------------------------------------------------------------------------------------------------------------------------------------------------------------------------------------------------------------------------------------------------------------------------------------------------------------------------------------------------------------------------------------------------------------------------------------------------------------------------------------------------|----------------------------------------------------------------------------------------------------------------------------------------------------------------------------------------------------------------------------------------------------------------------------------------------------------------------------------------------------------------------------------------------------------------------------|

Preparation

Depending on your TV and other equipment there are various ways you can connect the player. Please refer to the manuals of your TV, VCR, stereo system or other devices as necessary for additional connection information.

Notes:

- The picture and sound of a nearby TV, VCR, or radio may be distorted during playback. Position the units away from each other or turn off the unit after removing the disc.
- Make sure the DVD+VCR is connected directly to the TV and tune the TV to the correct video input channel.
- Do not connect the DVD+VCR's AUDIO OUT jack to the phono in jack (record deck) of your audio system. Do not connect the DVD+VCR via another VCR. The DVD image could be distorted by the copy protection system.

Connecting an Antenna or Cable TV

1 Antenna:

Disconnect the antenna from the rear of the TV and identify the antenna cable. If it is a round 75 ohm coaxial cable connect it directly to the jack marked ANT.IN on your DVD+VCR. If your antenna cable is flat connect it to a 300-ohm to 75-ohm antenna adaptor (not supplied) and slip the adaptor over the ANT.IN jack. Don't attempt to screw it into the DVD+VCR.

2 Cable TV:

If your cable connection has no converter or descrambler, unscrew the cable from your TV and attach it to the ANT.IN jack on the DVD+VCR. If a converter is required connect a coaxial cable from the wall jack to the IN connector on the converter, and a coaxial cable from the OUT connector on the converter to the ANT.IN on your DVD+VCR. This cable hookup permits both TV and DVD+VCR operation.

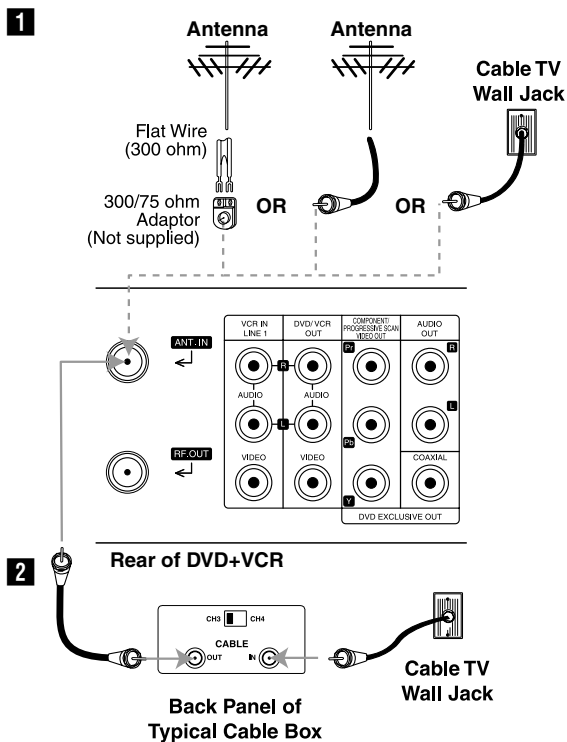

To view or record a CATV channel

1. Tune the TV to the DVD+VCR output channel (CH 3 or 4).
2. Set the DVD+VCR channel selector to the cable output channel. (Example: CH3)
3. Select a channel using the cable converter.

Notes:

- With this connection, you cannot record one program while viewing another.
- If you are using a cable box to tune channels, it is not necessary to do Auto Channel Set.

Basic TV Connections

Make one of the following connections, depending on the capabilities of your TV.

RF coaxial connection

Connect the RF.OUT jack on the DVD+VCR to the antenna in jack on the TV using the supplied 75-ohm Coaxial Cable (R).

How to set the DVD+VCR's RF output channel

1. When the DVD+VCR is turned off (standby mode), press and hold CH (-/+) on the front panel simultaneously for more than five seconds. "RF03" or "RF04" appears in the display window.
2. Press CH (-/+) to change the RF output channel (RF03 or RF04). Tune the TV to this channel.
3. Turn off the DVD+VCR.

Audio/Video connection

1. Connect the DVD/VCR VIDEO OUT jack on the DVD+VCR to the video in jack on the TV using an optional video cable (V).
2. Connect the Left and Right DVD/VCR AUDIO OUT jacks on the DVD+VCR to the audio left/right in jacks on the TV (A1) using an optional audio cable.

Notes:

- If you use this connection, set the TV's source selector to VIDEO.
- For DVD/VCR VIDEO OUT jack connection, resolution must be set to 480i or 480p, however DVD/VCR VIDEO OUT is always at 480i standard resolution.

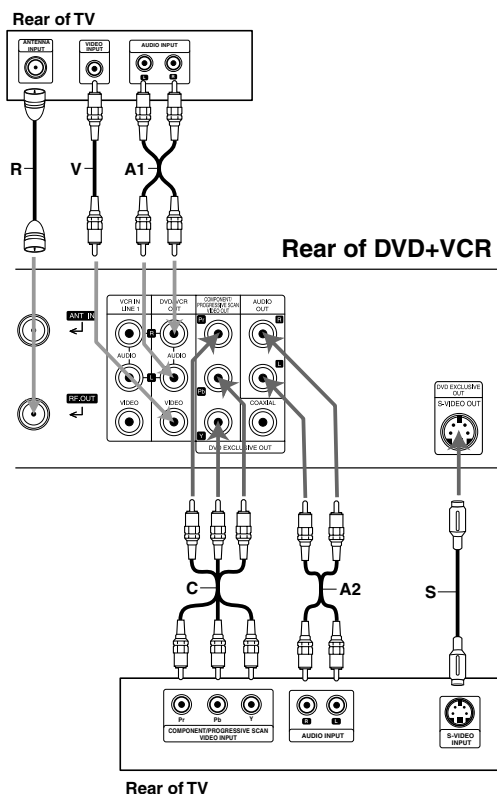

Optional TV Connections

These connections support only DVD playback. The tuner and VCR still output through the RF.OUT (R) or DVD/VCR OUT (A, V) jacks.

Audio connection

Connect the Left and Right AUDIO OUT jacks of the DVD+VCR to the audio left/right in jacks on the TV using an optional audio cable (A2).

S-Video connection

Connect the S-VIDEO OUT jack on the DVD+VCR to the S-Video in jack on the TV using the optional S-Video cable (S).

Note:

For S-Video connection, resolution must be set to 480i or 480p, however S-VIDEO OUT is always at 480i standard resolution.

Component Video / Progressive Scan connection

If your television is a high-definition or "digital ready" television, you may take advantage of the DVD+VCR's progressive scan output for the highest video resolution possible.

Connect the COMPONENT/PROGRESSIVE SCAN VIDEO OUT jacks on the DVD+VCR to the corresponding in jacks on the TV using an optional Y Pb Pr cable (C).

Notes:

- The 480p and 720p resolutions are Progressive scan applied resolutions.
- Progressive scan does not work with the analog video connections (yellow VIDEO OUT jack and S-VIDEO OUT jack).

Resolution Setting

The resolution setting support only DVD playback.

1. Before you set the resolution, this unit must be in stop mode. Press STOP (■) to stop playback.
2. Press OUTPUT STATUS on the front panel once. The current resolution setting will be appears in the display window.
3. Press OUTPUT STATUS repeatedly to change the resolution you want.

The available resolution according to the connections are as shown below.

OUTPUT CONNECTIONS	Available Resolutions
HDMI VIDEO OUT	1920 x 1080i 1280 x 720p 720 x 480p
COMPONENT VIDEO OUT	1920 x 1080i 1280 x 720p 720 x 480p 720 x 480i
VIDEO OUT	720 x 480i
S-VIDEO	720 x 480i

Notes:

- For 720p and 1080i resolution on the component video out, only non-copy protected discs can be played back. If the disc is copy protected, it will be displayed in the 480p resolution without HDMI cable connection. With HDMI cable connection, the picture may not be displayed properly.
- If your TV does not support the resolution you have set, the picture may not be displayed properly. Please read TV's owner's manual then set the resolution that your TV can accept.

HDMI Connection (DVD deck only)

If you have a HDMI TV or monitor, you can connect it to this DVD+VCR using a HDMI cable.

1. Set the TV's source to HDMI (refer to TV's Owner's manual).
2. Connect the HDMI OUT jack on the unit to the HDMI jack on a HDMI compatible TV or monitor using an optional HDMI cable (**H**).
3. Press OUTPUT STATUS on the front panel repeatedly to select the desired resolution.

Notes:

- Both PCM and Bitstream Audio out is available, when the sample frequency is set to 48kHz in HDMI connection.
- If Audio setup is set to bitstream and your TV does not support Bitstream Audio out in HDMI connection, audio sound may not output or distorted.
- When the no sound or noisy sound are output with HDMI connection, set the Audio option [Dolby Digital, DTS or MPEG] in the SETUP menu to PCM or Off.
- The arrow on the cable connector body should be face up for correct alignment with the connector on the DVD+VCR.

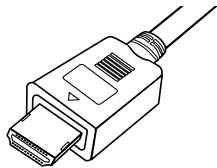

- If there is noise or lines on the screen, please check the HDMI cable.
- Not all HDCP-compatible DVI devices will work with this unit.
- If your HDMI TV does not support HDCP, the blue screen appears on the screen.

Tip:

When you use HDMI connection, you can change the resolution (480p, 720p, 1080i) for the HDMI output.

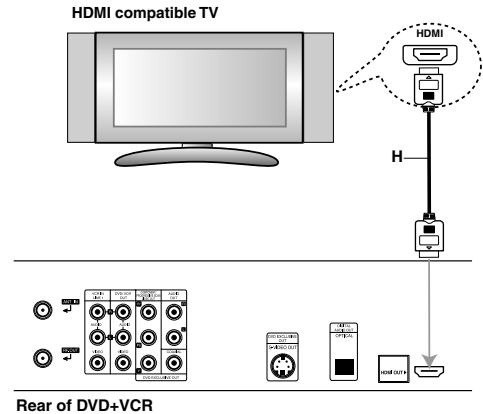

About HDMI

HDMI (High Definition Multimedia Interface) supports both video and audio on a single digital connection for use with DVD players, Set-Top boxes, and other AV devices.

HDMI was developed to provide the technologies of HDCP (High-bandwidth Digital Content Protection). HDCP is used to protect digital content transmitted and received.

HDMI has the capability to support standard, enhanced, or high-definition video plus standard to multi-channel surround-sound audio, HDMI features include uncompressed digital video, a bandwidth of up to 5 gigabytes per second, one connector (instead of several cables and connectors), and communication between the AV source and AV devices such as DTVs.

HDMI, the HDMI logo and High-Definition Multimedia Interface are trademarks or registered trademarks of HDMI licensing LLC.

Connection to an Amplifier

You can only listen to DVD playback using OPTICAL (O), COAXIAL (X) and AUDIO OUT (A2) connections. The tuner and VCR will still be heard through the RF. OUT (R) or DVD/VCR AUDIO OUT (A1) jack. (See page 11.)

Connecting to an amplifier equipped with two channel analog stereo or Dolby Pro Logic II/Pro Logic

Connect the Left and Right AUDIO OUT (or DVD/VCR AUDIO OUT) jacks on the DVD+VCR to the audio left and right in jacks on your amplifier, receiver, or stereo system using optional audio cables (A1, A2).

Connecting to an amplifier equipped with two channel digital stereo (PCM) or to an Audio/Video receiver equipped with a multi-channel decoder (Dolby Digital™, MPEG 2, or DTS)

1. Connect one of the DVD+VCR's DIGITAL AUDIO OUT jacks (OPTICAL O, COAXIAL X) to the corresponding in jack on your amplifier. Use an optional digital (OPTICAL O, COAXIAL X) audio cable.
2. You will need to activate the DVD+VCR's digital output. (See "AUDIO" on page 17.)

Digital Multi-channel sound

A digital multi-channel connection provides the best sound quality. For this you need a multi-channel Audio/Video receiver that supports one or more of the audio formats supported by your DVD+VCR (MPEG 2, Dolby Digital and DTS). Check the receiver manual and the logos on the front of the receiver.

Caution:

Due to the DTS Licensing agreement, the digital output will be in DTS digital out when DTS audio stream is selected.

Notes:

- If the audio format of the digital output does not match the capabilities of your receiver, the receiver will produce a strong, distorted sound or no sound at all.
- Six Channel Digital Surround Sound via digital connection can only be obtained if your receiver is equipped with a Digital Multi-channel decoder.
- To see the audio format of the current DVD in the on-screen display, press A.MONITOR.

Rear of DVD+VCR

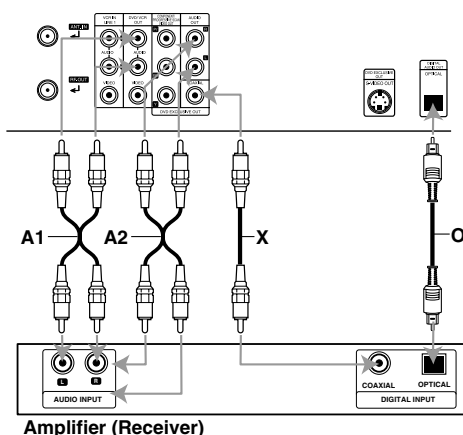

Manufactured under license from Dolby Laboratories. "Dolby", "Pro Logic", and the double-D symbol are trademarks of Dolby Laboratories.

DTS and DTS Digital Out are trademarks of Digital Theater Systems, Inc.

Accessory Audio/Video (A/V) Connections to DVD+VCR

Connect the VCR IN LINE 1 or LINE 2 jacks on the DVD+VCR to the audio/video out jacks on your accessory component, using the optional audio/video cables. (Refer to page 23 for "Recording from External Components".)

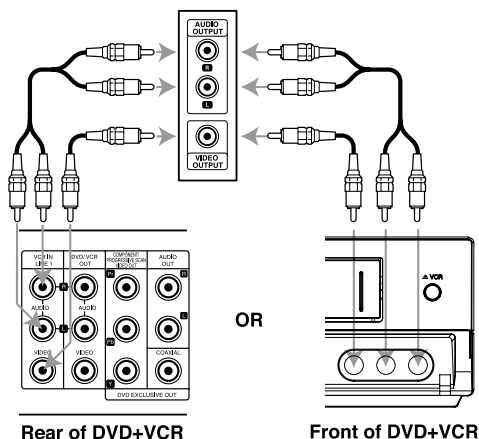

Initial Settings - VCR

By using the VCR Setup menu, you can make various adjustments to items such as clock setting, and timer recordings.

Your DVD+VCR allows remote control adjustment of several features.

General Operation

1. Press VCR on the remote control.
2. Press SETUP MENU and the MAIN menu will appear.

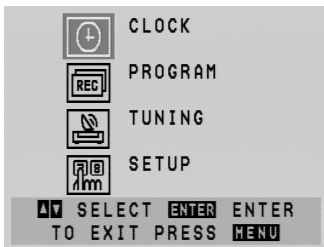

3. Use ▲/▼ to select the desired menu, then press ENTER/OK.
4. Use ▲/▼ to choose a desired option on the selected Menu. Then use ◀/▶ to choose a desired setting.
5. Press SETUP MENU when finished.

Note:

Menus remain on-screen for 3 minutes.

CLOCK

The DVD+VCR gives you two ways to set the time and date: the Auto Clock Feature or Manually.

Auto Clock Set



AUTO CLOCK SET

The Auto Clock Set feature is set to ON at the factory. In the ON setting, the DVD+VCR looks for a channel carrying XDS (Extended Data Services) information. XDS updates the clock using the Coordinated Universal Time.

- Use ◀/▶ to choose ON or OFF.

DAYLIGHT SAVINGS

You can turn Daylight Savings On or Off manually. If you choose "AUTO", the DVD+VCR sets the clock using the DST information broadcast in the signal (channel).

- Use ◀/▶ to choose AUTO, ON or OFF.

TIME ZONE

You can set your local Time Zone manually. If you choose "AUTO", the DVD+VCR sets the clock using the first Coordinated Universal Time information it finds in a broadcast signal.

- Use ◀/▶ to choose the correct time zone (AUTO, EASTERN, CENTRAL, MOUNTAIN, PACIFIC, ALASKA or HAWAII).

Notes:

- The Auto Clock feature enables the DVD+VCR to set up the clock while the DVD+VCR is turned off.
- There are cases where the TV station does not send or sends wrong date and/or time information and the DVD+VCR sets the incorrect time. **If this happens we recommend that you set the clock manually.**

Manual Clock Set

Use ▲/▼/◀/▶ to enter the necessary information.

- MONTH : Choose the month.
- DAY : Choose the date.
The day of the week will display automatically.
- YEAR : Choose the year.
- TIME : Choose the time.
Press and hold ◀/▶ to advance clock continuously.

Notes:

- If setting the clock manually, "AUTO CLOCK SET" must set to "OFF". If it is set to "ON", an incorrect date and/or time will be entered again when the DVD+VCR is turned off.
- The clock uses the 12-hour system. Be sure to set AM and PM correctly.

PROGRAM

The Timer Recording function allows you to record up to 8 programs within a period of one year. (See pages 21 - 22.)

TUNING

This DVD+VCR is equipped with a frequency synthesized tuner capable of receiving up to 181 channels. These include VHF channels 2-13, UHF channels 14-69 and CATV channels 1-125.

Auto Channel Programming

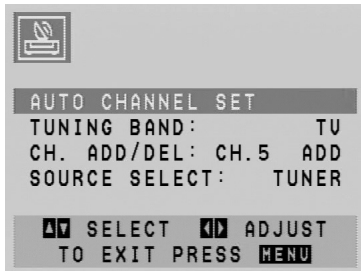

1. Choose the SOURCE SELECT option, then use ◀/▶ to select TUNER. Use ◀/▶ to switch among TUNER, LINE1, and LINE2.
2. Choose the AUTO CHANNEL SET option, then use ◀/▶ to find channels.
 - The tuner will automatically cycle through all available channels (TV/CATV) in the area and place them in the tuner's memory.
 - After the AUTO CHANNEL SET is complete, the TUNING menu will hide and return to the TV screen automatically.
3. Make sure the TUNING BAND is set appropriately (TV or CATV).
 - TV : If you are using a standard antenna to receive channels.
 - CATV : If you are using basic cable to receive channels.

To Add or Erase Channels

This feature allows you to add or erase channels from memory manually.

1. Choose the CH. ADD/DEL option, then use ◀/▶ to select a channel to add or erase.
2. Use ENTER/OK to add or erase the channel. Repeat steps 1 and 2 to add or erase other channels.
3. Press SETUP MENU to return to the TV screen.

SETUP



FUNCTION OSD

The on-screen display can be turned on or off.

AUDIO MODE

The DVD+VCR has two separate audio playback systems, the high quality VHS Hi-Fi system and standard NORMAL mono system. The same audio is generally recorded on both systems. The VHS Hi-Fi system plays on separate (left and right) channels, and the NORMAL system plays monaural sound. The normal track is always played so the cassette can be played on a DVD+VCR that does not have VHS Hi-Fi.

BROADCAST TYPE (STEREO/SAP/MONO)

Multichannel Television Sound (MTS) carries stereo and/or Second Audio Program (SAP) bilingual signals. Set this display to the desired position when both MTS stereo and SAP signals are received. When only one of the MTS signal is received, the DVD+VCR automatically selects the corresponding receiving mode (Stereo or SAP) regardless of the selected position. For normal operation, the display should be in the STEREO position. The DVD+VCR will then record a STEREO program when available, and record a mono program IF the program is NOT IN STEREO. For weak STEREO and/or SAP broadcasts, changing the display to mono may give clearer sound.

AUDIO OUTPUT (STEREO/LEFT/RIGHT)

Used during playback [when AUDIO MODE (HI-FI/NORMAL) is in HI-FI position] for selecting the audio output signals from the AUDIO OUT terminals (L ch and R ch), and RF.OUT. This display setting should normally be left in the stereo position, so that when a stereo tape is played, the stereo sound will be heard through the left and right channels. If a mono tape is played and the audio output is set to stereo, the same mono sound will be heard from both left and right channels.

Displaying Disc Information on-screen - DVD

You can display various information about the disc loaded on-screen.

1. Press DISPLAY to show various playback information.

The items displayed differ depending on the disc type or playing status.



2. You can select an item by pressing ▲/▼ and change or select the setting by pressing ◀/▶.
 - Title (Track) – Current title (or track) number/ total number of titles (or tracks)
 - Chapter – Current chapter number/total number of chapters
 - Time – Elapsed playing time
 - Audio – Selected audio language or channel
 - Subtitle – Selected subtitle
 - Angle – Selected angle/total number of angles
 - Sound – Selected sound mode

Note:

If no button is pressed for a few seconds, the on-screen display disappears.

Initial Settings - DVD

By using the DVD Setup menu, you can make various adjustments to items such as picture and sound. You can also set a language for the subtitles and the Setup menu, among other things. For details on each Setup menu item, see pages 17 - 18.

To display and exit the Menu:

Press SETUP MENU to display the menu. A second press of SETUP MENU will take you back to initial screen.

To go to the next level:

Press ▶ on the remote control.

To go back to the previous level:

Press ◀ on the remote control.

General Operation

1. Press DVD on the remote control.
2. Press SETUP MENU. The Setup menu appears.
3. Use ▲/▼ to select the desired option then press ▶ to move to the second level. The screen shows the current setting for the selected item, as well as alternate setting(s).
4. Use ▲/▼ to select the second desired option then press ▶ to move to the third level.
5. Use ▲/▼ to select the desired setting then press ENTER/OK to confirm your selection. Some items require additional steps.
6. Press SETUP MENU or PLAY (▶) to exit the Setup menu.

LANGUAGE

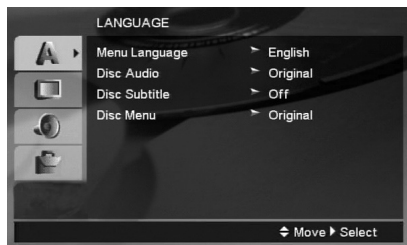

Menu Language

Select a language for the VCR and DVD's setup menu and information display.

Disc Audio / Subtitle / Menu

Select the language you prefer for the audio track (disc audio), subtitles, and the disc menu.

Original: Refers to the original language in which the disc was recorded.

Other: To select another language, press number buttons then ENTER/OK to enter the corresponding 4-digit number according to the language code list in the reference chapter (see page 32). If you enter the wrong language code, press CLEAR (0000).

Off (for Disc Subtitle) : Turn off Subtitle.

DISPLAY



TV Aspect

4:3 : Select when a standard 4:3 TV is connected.

16:9 : Select when a 16:9 wide TV is connected.

Display Mode

Display Mode setting works only when the TV Aspect mode is set to "4:3".

Letterbox: Displays a wide picture with bands on the upper and lower portions of the screen.

Panscan: Automatically displays the wide picture on the entire screen and cuts off the portions that do not fit.

AUDIO

Each DVD disc has a variety of audio output options. Set this unit's AUDIO options according to the type of audio system you use.

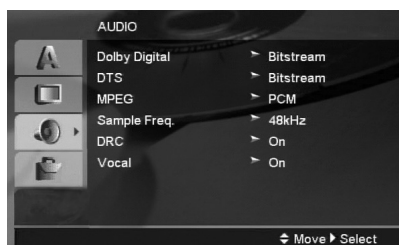

Dolby Digital / DTS / MPEG

Bitstream: Select "Bitstream" if you connect the DVD+VCR's DIGITAL AUDIO OUT jack to an amplifier or other equipment with a Dolby Digital, DTS or MPEG decoder.

PCM (for Dolby Digital / MPEG): Select when connected to a two-channel digital stereo amplifier. DVDs encoded in Dolby Digital or MPEG will be automatically downmixed to two-channel PCM audio.

Off (for DTS): If you select "Off", the DTS signal is not output through the DIGITAL AUDIO OUT jack.

Sample Freq. (Frequency)

If your receiver or amplifier is NOT capable of handling 96 kHz signals, select 48 kHz. When this choice is made, this unit automatically converts any 96 kHz signals to 48 kHz so your system can decode them.

If your receiver or amplifier is capable of handling 96 kHz signals, select 96 kHz. When this choice is made, this unit passes each type of signal through without any further processing.

Check the documentation for your amplifier to verify its capabilities.

DRC (Dynamic Range Control)

With the DVD format, you can hear a program's soundtrack in the most accurate and realistic presentation possible, thanks to digital audio technology. However, you may wish to compress the dynamic range of the audio output (the difference between the loudest sounds and the quietest ones). This allows you to listen to a movie at a lower volume without losing clarity of sound. Set DRC to On for this effect.

Vocal

Set to On only when a multi-channel karaoke DVD is playing. The karaoke channels on the disc mix into normal stereo sound.

OTHERS



PBC

Set Playback Control (PBC) to On or Off.

On: Video CDs with PBC are played according to the PBC.

Off: Video CDs with PBC are played the same way as Audio CDs.

Auto Play

You can set up the DVD+VCR so a DVD disc automatically starts playing whenever the DVD is inserted.

If Auto Play mode is set to On, this DVD player will search for title that has the longest playback time and then play back the title automatically.

On: Auto Play function is active.

Off: Auto Play function is not active.

Note:

The Auto Play function may not work for some DVDs.

B.L.E. (Black Level Expansion)

To select the black level of playback pictures. Set your preference and monitor's ability.

On: Expanded grey scale. (0 IRE cut off)

Off: Standard grey scale. (7.5 IRE cut off)

Remote Control Function

Remote Control A/B/C Code Switching

The remote control is capable of controlling three JVC video units independently. Each of the units can respond to one of three codes (A, B or C). The remote control is preset to send C code signals because your unit is initially set to respond to C code signals. You can easily modify your unit to respond to A or B code signals.

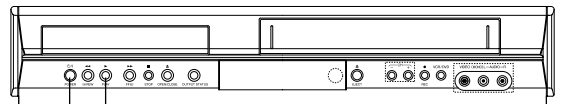

Power/Play button

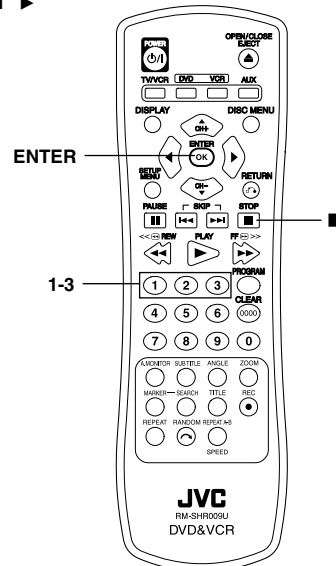

- Keep pressing ENTER down during step 1.
- 1. Press the number key "1" for A, "2" for B or "3" for C to change the remote control code.
- 2. Press on the unit to turn off the unit with no video tape inserted.
- 3. Press on the unit for over 5 seconds while the unit is turned off. The current code appears on the display window.
- 4. Press on the remote control to change the unit's code. The new code currently set on the remote control blinks on the display window for approximately 5 seconds, and is applied to the unit.







Operations - VCR

This chapter describes how to operate the VCR and DVD.

VCR Tape Playback

Press the VCR button to select the device to be operated.

Basic Instructions

1. Turn on the TV.
2. Tune the TV to the DVD+VCR output channel (CH 3 or 4) or if a direct VIDEO/AUDIO connection is made between the DVD+VCR and the TV, set the TV's source selector to VIDEO.
3. Insert a pre-recorded video cassette. The  indicator lights and the DVD+VCR powers on automatically.
4. If the  (TIMER) indicator in the display window is lit, press POWER () once.
5. If a tape without a safety tab is inserted the unit starts playback automatically. If not, press PLAY () .
6. Press STOP () to stop playback. If the tape reaches the end before you press STOP () the DVD+VCR automatically stops, rewinds and ejects the tape.

Note:

It is not necessary to select the tape speed for playback because it is automatically selected by the DVD+VCR. Also, during playback the TV/VCR selector switches to VCR mode automatically.

Auto Tracking

Automatic tracking adjusts the picture to remove snow or streaks and beings when:

- A tape is played for the first time.
- The tape speed (SP, LP, SLP) changes.
- Streaks or snow appear due to scratches on the tape.

Manual Tracking

To manually adjust the tracking use the CH (-/+) buttons during playback.



Notes:

- Vertical jitter requires a very fine adjustment.
- Tracking is automatically reset to normal when the tape is ejected or the power cord is unplugged for more than 3 seconds.

Search

This function lets you visually search for a tape section in either direction: forward and reverse. During the high-speed picture search modes, the audio is muted and horizontal lines (noise bars) appear. Also, a short time is needed to stabilize the tape speed when re-entering the PLAY mode so slight interference may be observed during this time.



To search:

1. Press REW () or FF () during playback.
2. To return to playback, press PLAY () .

Note:

After 3 minutes in SEARCH mode the DVD+VCR returns to PLAY mode to protect the tape and video heads.

Still Picture and Frame-by-Frame Playback

1. Press PAUSE () during playback. A still picture appears on the TV screen and the audio is muted.
2. If the still picture vibrates vertically, stabilize it by using CH (-/+) on the remote control.
3. Press PAUSE () repeatedly to advance the video picture one frame at a time.
4. To return to playback, press PLAY () .

Note:

After 5 minutes in STILL mode the DVD+VCR stops to protect the tape and video heads.

Slow Motion

1. While in still mode, press FF (▶▶). The tape is played at a speed 1/19 times slower than the normal speed.
2. Use CH (-/+) on the Remote Control if necessary to adjust the tracking.
3. To return to the normal speed, press PLAY (▶).

Notes:

- During slow motion, audio is muted and horizontal lines (noise bars) may appear on the TV screen. This is normal.
- After 3 minutes in SLOW MOTION mode the DVD+VCR goes back to PLAY mode to protect the tape and video heads.

CM SKIP (Commercial Skip)

This feature is useful for skipping commercials or short program segments.

1. Press ⏮ in playback mode.
The DVD+VCR performs a fast forward picture search through 30 seconds of recording.
2. Press ⏮ again to extend the search time by an addition 30 seconds. The maximum search time is 3 minutes.
3. When the search is complete, the DVD+VCR goes into playback mode automatically.

VHS Hi-Fi Stereo/ MTS Broadcast

This DVD+VCR is equipped with the VHS Hi-Fi audio sound system for recording and playback. The information below gives a brief description of Hi-Fi audio and how to record and play a tape in the Hi-Fi audio mode.

Hi-Fi Stereo Audio Sound

A stereo TV with AUDIO/VIDEO input jacks or a stereo audio system is required for true stereo playback. To experience the full and rich stereo sound available with Hi-Fi recorded tapes, we recommend the connection of this unit to a home stereo audio system.

1. Set the AUDIO MODE option to HI-FI on the VCR SETUP menu.

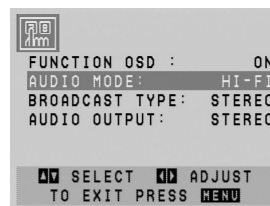

2. Set the AUDIO OUTPUT option to STEREO so that the left channel sound (L) is heard from the left speaker and the right channel sound (R) is heard from the right speaker.

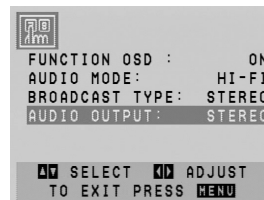

The other options are (LEFT) POSITION, which results in the left channel sound (L) being heard from both speakers or (RIGHT) POSITION, which results in the right channel sound (R) being heard from both speakers.

3. Insert a cassette and press PLAY (▶).

MTS (Multi-Channel TV Sound)

This DVD+VCR can decode MTS stereo and bilingual (SAP) off-the-air broadcast sound signals. It also decodes stereo TV sound from local cable companies as long as they operate on assigned cable frequencies and use the EIA-recommended MTS stereo/bilingual TV sound system.

Multichannel TV Sound Indicator (MTS)

When you press ENTER/OK one or both of the indicators appears on the TV Screen.

STEREO

The DVD+VCR can record in stereo onto the VHS Hi-Fi audio tracks when the BROADCAST TYPE option is in the STEREO position. The DVD+VCR can also record mono audio onto the mono audio track.

SAP

Some stations transmit a Second Audio Program, which is used for a second language or additional information.

STEREO/SAP

Use the BROADCAST TYPE option to select the desired recording mode (STEREO or SAP).

VCR Tape Recording

Basic Instructions

1. Turn on the DVD+VCR and TV.
2. Tune the TV to the DVD+VCR output channel (CH 3 or 4) or if a direct VIDEO/AUDIO connection is made between the DVD+VCR and the TV, set the TV's source selector to VIDEO.
3. Insert a video cassette with the safety tab intact.
4. Select the desired channel using CH (-/+).
5. If you are recording from another source via audio/video input jacks (at the rear or front panel), select LINE1 or LINE2 using AUX.
6. Set the desired recording speed (SP or SLP) by pressing SPEED. This DVD+VCR is not designed to record in LP mode.
7. Set the MTS mode (STEREO or SAP). Set the BROADCAST TYPE option to SAP if applicable.
8. Press REC (●) and recording starts. The REC indicator appears in the display window. If a cassette with no safety tab is loaded, the cassette is ejected.
9. Press STOP (■) to stop recording. If the tape reaches the end before STOP (■) is pressed, the DVD+VCR stops, rewinds and ejects the tape.

Tip:

Use PAUSE (||) for best results when making changes while recording. For example, if you want to change channels while recording, first press PAUSE (||) to put the unit in pause mode, select the desired channel on the DVD+VCR, and then press PAUSE (||) again to resume recording.

Note:

During the VCR recording mode, you cannot change to the DVD mode.

To pause the recording

1. Press PAUSE (||) to pause the tape during recording. The REC indicator flashes in the display window.
2. When you want to continue recording, press PAUSE (||) or press REC (●). After 5 minutes in PAUSE mode, the DVD+VCR stops automatically to protect the tape and the video heads.

To record one TV program while watching another

1. Press TV/VCR to select the TV mode during recording. The TV indicator appears.
2. Using the TV, select the channel to be viewed.

Timer Recording

For unattended recording, you must input the channels to be recorded and the starting and ending times.

Things to know before starting

If you try to set the program timer before setting the clock, "PLEASE SET THE CLOCK" appears for a moment and then CLOCK menu appears on the TV screen. Set the time and date before proceeding.

1. Turn on the DVD+VCR and the TV.
2. Be sure the TV is set to the DVD+VCR output channel (3 or 4).
3. Make sure the TUNING BAND in the TUNING menu is set appropriately (TV or CATV).
4. Press SETUP MENU and the MAIN menu appears.
5. Use ▲ / ▼ to choose the PROGRAM menu and press ENTER/OK.

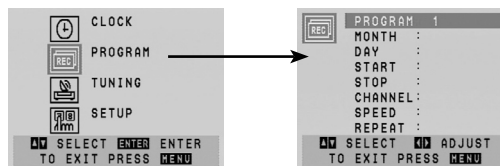

- If eight programs are already entered, the FULLY PROGRAMMED message appears for a moment and then PROGRAM 1 appears on the TV screen.
6. Use the ▲ / ▼ buttons to switch between the program options, and the ◀ / ▶ buttons to input the program information:
Input the month, day, start and stop times of the program you want to record.

CHANNEL: Select a TV channel, LINE1 or LINE2. If you have CABLE TV and use a cable box (converter) you must set the channel to match the cable box output channel (usually CH 3 or 4). Change channels on the cable box instead of with the DVD+VCR. If you use a cable converter, you can program multiple recordings only on the converter box output channel. This is because the converter determines what channel you view through your DVD+VCR.

SPEED: AUTO mode determines how much tape is left and switches the speed from SP to SLP if it is necessary to complete recording the program. If this occurs there could be some picture and sound distortion at the point where the speed changes.

REPEAT: To record up to 8 programs on a certain day of every week select WEEKLY. To record up to 8 programs at the same time Monday through Friday select DAILY. Otherwise select ONCE.

7. Press SETUP MENU and the program is memorized by the DVD+VCR.
8. Additional programs may be entered by repeating steps 1-7.
9. Ensure you insert a tape with the record safety tab intact before the first programmed time.
10. Press STOP (■) to end timer recording.

Notes:

- If you make a mistake or want to change a setting, use ▲ to select the option and correct it using ◀ / ▶.
- If the program preset time is past, the "PAST TIME PROGRAMMED" message appears on the TV screen. Return to the incorrect program and program it with the correct time.
- If you enter a past date, the timer recording will be performed on that date of the next year.
- If the power fails or the DVD+VCR is unplugged the clock and timer settings are kept in memory for only 3 seconds. Otherwise you must reset the clock and timer.
- If the tape indicator is blinking, no tape is loaded.
- When you are playing DVD at programmed Recording time, the DVD+VCR automatically change to VCR mode and start recording.
- The DVD+VCR will automatically power off when Timer Recording ends.

Checking or Erasing the Timer Program

Programming can be checked whenever the DVD+VCR is turned on.

1. Press SETUP MENU and the MAIN menu appears.
2. Use ▲ / ▼ to choose the PROGRAM menu and press ENTER/OK.

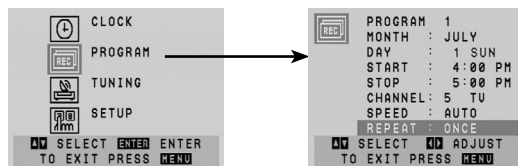

3. Use ◀ / ▶ to select a program you want to check or erase. To erase the program, press CLEAR (0000).
4. Press SETUP MENU to return to the TV screen.

Program Priority

If the recording start and end times of preset programs overlap on the same day (see the example), the second program is not recorded until the first is finished.

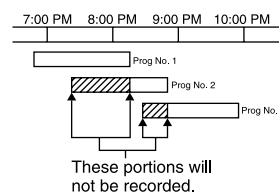

In this example, the first part of program numbers 2 and 3 are not recorded.

Instant Timer Recording

With this feature you can record for a preset length without using the program timer.

1. Turn on DVD+VCR and the TV.
2. Be sure the TV is tuned to the DVD+VCR output channel (CH 3 or 4). If a direct VIDEO/AUDIO connection is made between the DVD+VCR and the TV, set the TV's source selector to VIDEO.
3. Insert a video cassette with the safety tab intact.
4. Select the desired channel using CH (-/+) or the number buttons (0-9). The channel number appears on the TV screen. If you are recording from another source via audio/video input jacks (at the rear or front panel), select LINE1 (rear jacks) or LINE2 (front jacks) by using AUX.
5. Set the desired recording speed (SP or SLP) using SPEED. The tape speed appears on the TV screen.
6. Press REC (●) twice. The menu appears on the TV screen, recording starts, and the ⌚ (TIMER) indicator lights.

INSTANT TIMER RECORD	
CHANNEL	2
SPEED	SP
START LENGTH	NOW 0H30M

7. Press REC (●) repeatedly to select the recording time length. Each time you press this button the recording time increases 30 minutes (up to 9 hours). At the end of the recording, the DVD+VCR will stop recording and shut off.

If you set the time to 0H00M, the DVD+VCR goes into the normal recording mode. Press STOP (■) to stop the recording.

Note:

During Instant Timer Recording, you cannot change the channel on the DVD+VCR.

Checking the Recording Time

Press REC (●) once to check the recording time. The recalled setting automatically returns to the TV screen after 6 seconds.

Extending the Recording Time

The recording time can be extended anytime by pressing REC (●). Subsequent presses result in advancing the recording time by 30-minute increments.

Note:

If you press PAUSE (||) during instant timer recording, the instant timer recording is cancelled.

Recording from External Components

You can record from an external component, such as a camcorder or VCR, connected to any of the DVD+VCR's external inputs.

1. Make sure that the component you want to record from is connected properly to the DVD+VCR. See page 13.
2. Press AUX repeatedly to select the external input to record from.
 - LINE1 (L1): Audio/Video Input mounted on back panel.
 - LINE2 (L2): Audio/Video Input mounted on front panel.
3. Load a recordable tape.
4. Set a recording mode (SP or SLP) as necessary by pressing SPEED repeatedly.
5. Play the tape or disc in the external component. If you have a TV attached to your DVD+VCR, you can see the video playing.
6. Press REC (●) once to start recording. The REC indicator lights in the display window.
7. Press STOP (■) to stop recording.

Notes:

- Before recording, confirm the recording start position.
- If your source is copy-protected using CopyGuard, you will not be able to record it using this unit. See Copyright on page 6 for more details.
- To record for a fixed length of time, see Instant Timer Recording.

Copying from DVD to VCR

You can copy the contents of a DVD to a VHS tape.

1. Insert the disc you wish to copy into the DVD deck and close the disc tray.
2. Insert a blank VHS video tape into the VCR deck.
3. Find the place on the DVD from which you want to start dubbing using the PLAY, FF, REW and PAUSE functions.
For best results, pause playback at the point from which you want to record.
4. Press REC (●). The DVD goes into PLAY mode and the VCR goes into RECORD mode. If the DVD disc menu appears, you may need to press PLAY (▶) manually to begin copying.
5. When the DVD is finished playing, press STOP (■) to end copying.

Notes:

- If you use the DISPLAY or ZOOM function during copying, the information displayed on-screen will be recorded.
- If the DVD you are attempting to copy is copy protected, you will not be able to copy the disc. It is not permitted to copy Macrovision encoded DVDs (or Discs). "Lock" is displayed in the display window.
- You must stop the copy process manually when the DVD movie ends, or the unit may replay and record over and over again.
- When you stop the DVD playback during copying, the recording on VCR is stopped automatically.

On-Screen Display - VCR

Some of these functions will be displayed every time the DVD+VCR is operated.

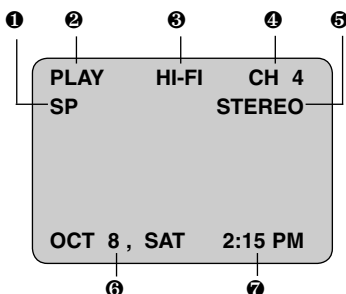

- | | |
|-----------------------------|--------------------------------------------------------|
| 1 TAPE SPEED DISPLAY | 5 STEREO/SAP DISPLAY
(MONO is not displayed) |
| 2 FUNCTION DISPLAY | 6 DATE DISPLAY |
| 3 HI-FI DISPLAY | 7 CLOCK/ COUNT/
REMAIN DISPLAY |
| 4 CHANNEL DISPLAY | |

Each press of the ENTER/OK changes the TV screen in the following sequence.

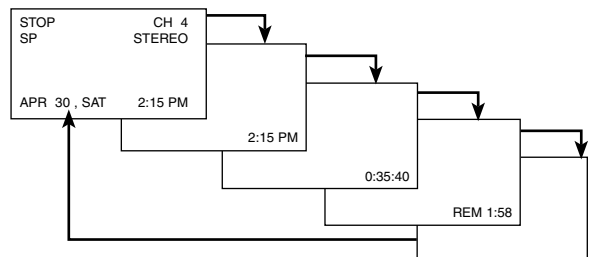

Real-Time Counter

If a tape with contents recorded on it is inserted into the VCR, the real-time counter shows length of the tape running in hours, minutes, and seconds. Press DISPLAY to select the real-time counter display. Every press of DISPLAY changes the TV screen as illustrated below.

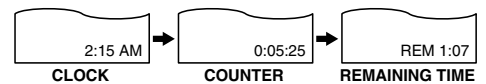

Counter Memory

This feature is useful if there is a section of tape you want to view immediately after recording or if you want to return to the same point several times.

1. Begin recording or playing a tape.
2. Press DISPLAY until the real-time counter is displayed on the TV screen.
3. At the point that you want to locate later, reset the real-time counter to "0:00:00" by pressing CLEAR (0000).
4. Continue to play or record.
5. Press STOP (■) when recording or playback finishes.
6. Press REW (◀◀). The tape automatically stops when the tape counter returns to about "0:00:00".

Tape Remaining

This function displays the amount of time remaining on the tape during recording or playback. Press DISPLAY repeatedly until the REM indicator displays on the TV screen during recording or playback.

The remaining tape length may not be displayed correctly depending on the condition of the tape and the kind of the tape (T-140, T-160, or T-210 etc.).

Notes:

- The function displays can be seen displayed on the TV screen for 5 seconds.
- The clock (or tape counter, tape remaining) mode will be displayed until you press ENTER/OK.
- The tape counter and the remaining tape length indicator appear only when a cassette is inserted. Also, the remaining tape length indicator appears after any tape operation.

Additional VCR Information

- During manual recording, timer recording, Instant Timer Recording, playback, or fast forward modes, the DVD+VCR automatically starts rewinding the tape at the end of the tape. The cassette stops at the beginning of the tape and is ejected.
- After you have finished using the DVD+VCR, rewind, eject, and remove the cassette. Place the cassette in its protective sleeve to protect it from dust. It is not necessary to rewind the cassette before removing it, but if you do, it is ready to play or record the next time you use it.
- Be sure the DVD+VCR channel selector is on the correct channel you wish to record. The channel that is being recorded can always be checked by setting the television on the DVD+VCR channel (CH 3 or 4) and pressing the TV/VCR to turn the DVD+VCR's TV indicator off.
- Do not attempt to hook up more than one television set to the DVD+VCR for either recording or playback.

VCR Auto Play System

This DVD+VCR features automatic playback.

When you load a tape with the safety tab removed the following occurs:

- The Output Source is changed to VCR mode automatically.
- The power turns on automatically and playback begins.
- At the end of the tape, the DVD+VCR stops, then rewinds.
- The tape is ejected after rewinding and the turns itself off automatically.

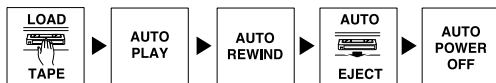

Note:

Auto power off does not function during regular DVD play mode. (DVD+VCR power stays on.)

S-VHS Quasi Playback (SQPB)

- This DVD+VCR can play back S-VHS recorded tapes, however, it cannot make recordings using S-VHS format tapes.
- SQPB is an abbreviation for S-VHS Quasi Playback.

Easy Information

If the Extended Data Service (XDS) signals are provided along with normal TV signal in your area or during playback of a tape recorded with Extended Data Service (XDS) signals, the station ID, program title, and program details are shown on the TV screen. When viewing a channel with Extended Data Service (XDS) signals, press ENTER/OK and the station ID will appear on the TV screen. Press ENTER/OK again and the program details will appear on the TV screen.

When viewing a tape recorded with Extended Data Service (XDS) signals, press ENTER/OK twice and the program title and program details will appear on the TV screen.

Program Details

LENGTH: Indicates the run length of a program.

TIME REMAINING: Indicates the remaining time of a program.

RATING: Indicates the rating of the current program (N/A, G, PG, PG-13, R, NC-17, X and Not Rated). The rating N/A means that the motion picture ratings are not applicable to this program.

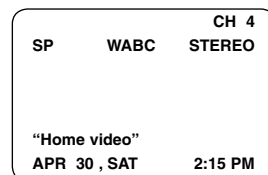

Easy Information Screen
(Station ID)

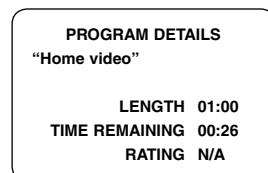

Easy Information Screen
(Program details)



Operations - DVD

Playback Setup

- Turn the TV on and select the video input source connected to this unit.
 - Audio System: Turn the Audio System on and select the input source connected to this unit.
1. Press OPEN/CLOSE (▲) to open the disc tray.
 2. Load your chosen disc in the tray with the playback side down.
 3. Press OPEN/CLOSE (▲) to close the tray.
READING appears on the display window, and playback starts automatically.
If playback does not start, press PLAY (▶).
In some cases, the disc menu might appear instead.

General features

Buttons	Operations	Discs
OPEN/CLOSE (▲)	Opens or closes the disc tray.	ALL
STOP (■)	During playback, press STOP (■) to stop playback. The unit records the stop point depending on the disc. "■■■" appears on the screen briefly. If you press STOP (■) again, "■" appears on the screen and the unit will clear the stop point.	ALL
PAUSE ()	During playback, press to pause playback.	ALL
	Press repeatedly to play Frame-by-Frame.	DVD VCD
SKIP (◀◀ / ▶▶)	During playback, press SKIP (◀◀ or ▶▶) to go to the next chapter/track or to return to the beginning of the current chapter/track. Press SKIP (◀◀) twice briefly to step back to the previous chapter/track.	ALL
REW/FF (◀◀ / ▶▶)	During playback, press REW (◀◀) or FF (▶▶) repeatedly to select the required scan speed. DVD: 4 steps Video CD, Audio CD: 3 steps	DVD VCD ACD
	While the playback is paused, press FF (▶▶) repeatedly to play in slow motion (4 steps, forward only).	DVD VCD
REPEAT	During playback, press REPEAT repeatedly to select a desired repeat mode. DVD Video discs: Chapter/Title/Off Video CD, Audio CD: Track/All/Off Notes: <ul style="list-style-type: none"> • If you press SKIP (▶▶) once during Repeat Chapter playback, the repeat playback cancels. • For Video CD with PBC, you must set PBC to Off on the Setup menu to use this function. (See "PBC" on page 18.) 	ALL
REPEAT A-B	During playback, each press of REPEAT A-B button to select point A and point B and repeats a sequence from point A (Starting point) to point B (End point). Note: The A-B repeat function is available only in the current track.	DVD VCD ACD

Buttons	Operations	Discs
ZOOM	<p>During playback or pause mode, press ZOOM to enlarge the video image (3 steps). You can move through the zoomed picture using ◀ ▶ ▲ ▼ buttons. Press CLEAR (0000) to exit.</p> <p>Notes:</p> <ul style="list-style-type: none"> • Zoom may not work on some DVDs. • For JPEG files, the zoom function is not available when the resolution is set to 720p or 1080i. 	DVD VCD JPEG
RANDOM	During playback or in stop mode, press RANDOM for random playback.	ACD
TITLE	If the current DVD title has a menu, the title menu appears on the screen. Otherwise, the disc menu may appear.	DVD
DISC MENU	The disc menu appears on the screen.	DVD
 (ANGLE)	<p>During playback of DVD disc contains scenes recorded different camera angles, press ANGLE repeatedly to select a desired angle.</p> <p>Tip:</p> <p>The Camera Angle icon is displayed on the TV screen when alternate angles are available.</p>	DVD
 (SUBTITLE)	During playback, press SUBTITLE repeatedly to select a desired subtitle language.	DVD
 (AUDIO)	During playback, press A.MONITOR repeatedly to hear a different audio language or audio track.	DVD VCD

Additional features

3D Surround

To produce a 3D surround effect that simulates multichannel audio from two stereo speakers (instead of the five+ speakers normally required for multi-channel audio from a home theater system).

DVD VCD

1. Press DISPLAY during playback.
2. Use ▲ or ▼ to select the sound option.
The sound option will be highlighted.
3. Use ◀ or ▶ to select "3D SUR".
To turn off the 3D Surround effect, select "Normal".

ACD

1. Press A.MONITOR during playback.
"3D SUR" appears on the menu screen.
2. To return to normal playback, press A.MONITOR repeatedly until "3D SUR" disappears from the menu screen.

Time Search **DVD VCD**

To start playing at any chosen time on the disc:

1. Press DISPLAY during playback.
2. Press ▲ / ▼ to select the time clock icon and "--:--:" appears.
3. Input the required start time in hours, minutes, and seconds from left to right. If you enter the wrong numbers, press CLEAR (0000) to remove the numbers you entered. Then input the correct numbers.
4. Press ENTER/OK to confirm. Playback starts from the selected time.

Marker Search **DVD VCD**

To enter a Marker

You can start playback from up to nine memorized points. To enter a marker, press MARKER at the desired point on the disc. The Marker icon appears on the TV screen briefly. Repeat to enter up to nine markers.

To Recall or Clear a Marked Scene

1. During disc playback, press SEARCH. The marker search menu appears on the screen.
2. Within 10 seconds, press ◀ / ▶ to select a marker number that you want to recall or clear.
3. Press ENTER/OK and playback starts from the marked scene. Or, press CLEAR (0000) and the marker number is erased from the list.
4. You can play any marker by inputting its number on the marker search menu.

Last Scene Memory **DVD** **ACD** **VCD1.1**

This player memorizes last scene from the last disc that is viewed. The last scene remains in memory even if you remove the disc from the player or switch off the player. If you load a disc that has the scene memorized, the scene is automatically recalled.

Note:

This player does not memorize the scene of a disc if you switch off the player before commencing to play the disc.

Screen Saver

The screen saver appears when you leave the DVD+VCR in Stop mode for about five minutes.

Playing an Audio CD

This unit can play Audio CDs.

Audio CD

Once you insert an Audio CD, a menu appears on the TV screen. Press ▲/▼ to select a track then press PLAY (▶) or ENTER/OK and playback starts. You can use variable playback functions. Refer to pages 26 - 28.

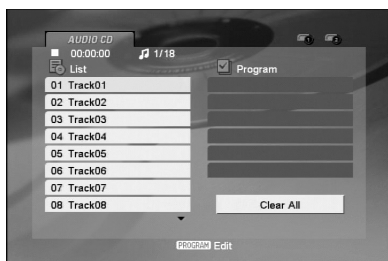

Note:

When playing an Audio CD with HDMI OUT as the output, the beginning of some songs may not be played.

Programmed Playback

The program function enables you to store your favorite tracks from any disc in the player memory.

A program can contain 30 tracks.

1. Insert an Audio CD.
AUDIO CD menu appears.
2. During STOP mode, press PROGRAM and the Ⓜ mark will appear.

Note:

Press PROGRAM again to exit the program edit mode, then the Ⓜ mark will disappear.

3. Select a track on the “List”, then press ENTER/OK to place the selected track on the “Program” list. Repeat to place additional tracks on the list.
4. Select the track you want to start playing on the “Program” list.
5. Press PLAY (▶) or ENTER/OK to start. Playback begins in the order in which you programmed the tracks. Playback stops after all of the tracks on the “Program” list have played once.
6. To resume normal playback from programmed playback, select a track on the list and then press PLAY (▶).

Repeat Programmed Tracks

Press REPEAT to select a desired repeat mode.

- Track: repeats the current track
- All: repeats all the tracks on programmed list.
- Off (No display): does not play repeatedly.

Note:

If you press SKIP (▶▶) once during Repeat Track playback, the repeat playback cancels.

Erasing a Track from “Program” List

1. During STOP mode, press PROGRAM and the Ⓜ mark will appear
2. Use ▲▼◀▶ to select the track that you wish to erase from the Program list.
3. Press CLEAR (0000). Repeat step 1~3 to erase additional tracks on the list.

Erasing the Complete Program List

1. During STOP mode, press PROGRAM and the Ⓜ mark will appear
2. Use ▲▼◀▶ to select “Clear All”, then press ENTER/OK.

Note:

The programs are also cleared when the power is off or the disc is removed.

Viewing a JPEG File

Using this DVD+VCR you can view discs with JPEG files.

1. Insert a disc and close the tray. The PHOTO menu appears on the TV screen.

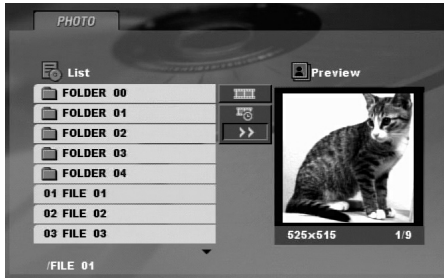

2. Press ▲/▼ to select a folder, and press ENTER/OK. A list of files in the folder appears. If you are in a file list and want to return to the previous Folder list, use the ▲/▼ buttons on the remote to highlight [Back] and press ENTER/OK.
3. If you want to view a particular file, press ▲/▼ to highlight a file and press ENTER/OK or PLAY (▶). The selected file will appear for viewing. While viewing a file, you can press STOP (■) to move to the previous menu (PHOTO menu).

Tips:

- Information and user guidance regarding the current image is displayed in the lower part of the screen. You can toggle this bar on and off using RETURN (↵).
- There are three Slide Speed options [Speed] : >>> (Fast), >> (Normal) and > (Slow) Use ▲▼◀▶ to highlight the Speed. Then, use ◀/▶ to select the option you want to use then press ENTER/OK.

Note:

When viewing a JPEG file, the user guidance will not be displayed on the TV screen if the resolution is set to 720p or 1080i.

Slide Show

Use ▲▼◀▶ to highlight the [Slide Show] then press ENTER/OK.

Still Picture

1. Press PAUSE (II) during slide show. The player will now go into PAUSE mode.
2. To return to the slide show, press PLAY (▶) or press PAUSE (II) again.

Moving to another File

Press SKIP (▶▶ or ◀◀) or cursor (◀ or ▶) once while viewing a picture to advance to the next or previous file.

Zoom

Use zoom to enlarge the photo image. (See page 27.)

Note:

When the resolution is set to 720p or 1080i, this function is not available.

To rotate picture

Press ▲/▼ during showing a picture to rotate the picture clockwise or counter clockwise.

JPEG disc compatibility with this player is limited as follows:

- Depending upon the size and number of JPEG files, it could take a long time for the DVD+VCR to read the disc's contents. If you don't see an on-screen display after several minutes, some of the files may be too large — reduce the resolution of the JPEG files to less than 5760 (Horizontal) x 3840 (Vertical) pixels and burn another disc.
- The total number of files in a folder should be less than 1190 files.
- Some discs may be incompatible due to a different recording format or the condition of disc.
- Ensure that all the selected files have the ".jpg" extensions when copying into the CD layout.
- If the files have ".jpe" or ".jpeg" extensions, please rename them as ".jpg" file.
- File names without ".jpg" extension will not be able to be read by this DVD+VCR. Even though the files are shown as JPEG image files in Windows Explorer.

Playing a DVD VR Format Disc

This unit will play DVD-R/RW discs recorded using the DVD-Video format that have been finalized using a DVD-recorder.

- This unit will play DVD-RW discs recorded using the Video Recording (VR) format.
1. Insert a disc and close the tray, It start playing automatically.
 2. The DVD-VR menu appears on the TV screen when you press DISC MENU buttons while playing.



3. Press ▲/▼ to select a track then press PLAY (▶) or ENTER and playback starts.
4. Press DISC MENU to move to the list menu.

Notes:

- Unfinalized DVD-R/RW discs cannot be played in this player.
- Some DVD-VR disc are made with CPRM data by DVD RECORDER. Player does not support these kinds of discs.

What is 'CPRM'?

CPRM is a copy protection system (with scramble system) only allowing the recording of 'copy once' broadcast programs. CPRM stands for Content Protection for Recordable Media.

This player is CPRM compatible, which means that you can record copy-once broadcast programs, but you cannot then make a copy of those recordings. CPRM recordings can only be made on DVD-RW discs formatted in VR mode, and CPRM recordings can only be played on players that are specifically compatible with CPRM.

Maintenance and Service

Refer to the information in this chapter before contacting a service technician.

Handling the Unit

When shipping the unit

Please save the original shipping carton and packing materials. If you need to ship the unit, for maximum protection, re-pack the unit as it was originally packed at the factory.

Keeping the exterior surfaces clean

- Do not use volatile liquids such as insecticide spray near the unit.
- Do not leave rubber or plastic products in contact with the unit for a long period of time since they leave marks on the surface.

Cleaning the unit

To clean the player, use a soft, dry cloth. If the surfaces are extremely dirty, use a soft cloth lightly moistened with a mild detergent solution.

Do not use strong solvents such as alcohol, benzene, or thinner, as these might damage the surface of the unit.

Maintaining the Unit

The DVD+VCR is a high-tech, precision device. If the optical pick-up lens and disc drive parts are dirty or worn, the picture quality could be diminished.

Depending on the operating environment, regular inspection and maintenance are recommended after every 1,000 hours of use.

For details, please contact your nearest authorized service center.

Reference

Language Codes List

Use this list to input your desired language for the following initial settings:

Disc Audio, Disc Subtitle, Disc Menu.

Language	Code	Language	Code	Language	Code	Language	Code
Abkhazian	6566	Fiji	7074	Lingala	7678	Singhalese	8373
Afar	6565	Finnish	7073	Lithuanian	7684	Slovak	8375
Afrikaans	6570	French	7082	Macedonian	7775	Slovenian	8376
Albanian	8381	Frisian	7089	Malagasy	7771	Somali	8379
Ameharic	6577	Galician	7176	Malay	7783	Spanish	6983
Arabic	6582	Georgian	7565	Malayalam	7776	Sudanese	8385
Armenian	7289	German	6869	Maltese	7784	Swahili	8387
Assamese	6583	Greek	6976	Maori	7773	Swedish	8386
Aymara	6588	Greenlandic	7576	Marathi	7782	Tagalog	8476
Azerbaijani	6590	Guarani	7178	Moldavian	7779	Tajik	8471
Bashkir	6665	Gujarati	7185	Mongolian	7778	Tamil	8465
Basque	6985	Hausa	7265	Nauru	7865	Tatar	8484
Bengali; Bangla	6678	Hebrew	7387	Nepali	7869	Telugu	8469
Bhutani	6890	Hindi	7273	Norwegian	7879	Thai	8472
Bihari	6672	Hungarian	7285	Oriya	7982	Tibetan	6679
Breton	6682	Icelandic	7383	Panjabi	8065	Tigrinya	8473
Bulgarian	6671	Indonesian	7378	Pashto, Pushto	8083	Tonga	8479
Burmese	7789	Interlingua	7365	Persian	7065	Turkish	8482
Byelorussian	6669	Irish	7165	Polish	8076	Turkmen	8475
Cambodian	7577	Italian	7384	Portuguese	8084	Twi	8487
Catalan	6765	Japanese	7465	Quechua	8185	Ukrainian	8575
Chinese	9072	Javanese	7487	Rhaeto-Romance	8277	Urdu	8582
Corsican	6779	Kannada	7578	Rumanian	8279	Uzbek	8590
Croatian	7282	Kashmiri	7583	Russian	8285	Vietnamese	8673
Czech	6783	Kazakh	7575	Samoan	8377	Volapük	8679
Danish	6865	Kirghiz	7589	Sanskrit	8365	Welsh	6789
Dutch	7876	Korean	7579	Scots Gaelic	7168	Wolof	8779
English	6978	Kurdish	7585	Serbian	8382	Xhosa	8872
Esperanto	6979	Laothian	7679	Serbo-Croatian	8372	Yiddish	7473
Estonian	6984	Latin	7665	Shona	8378	Yoruba	8979
Faroese	7079	Latvian, Lettish	7686	Sindhi	8368	Zulu	9085

Area Codes List

Choose an area code from this list.

Area	Code	Area	Code	Area	Code	Area	Code
Afghanistan	AF	Ethiopia	ET	Malaysia	MY	Saudi Arabia	SA
Argentina	AR	Fiji	FJ	Maldives	MV	Senegal	SN
Australia	AU	Finland	FI	Mexico	MX	Singapore	SG
Austria	AT	France	FR	Monaco	MC	Slovak Republic	SK
Belgium	BE	Germany	DE	Mongolia	MN	Slovenia	SI
Bhutan	BT	Great Britain	GB	Morocco	MA	South Africa	ZA
Bolivia	BO	Greece	GR	Nepal	NP	South Korea	KR
Brazil	BR	Greenland	GL	Netherlands	NL	Spain	ES
Cambodia	KH	Islands	HM	Netherlands Antilles	AN	Sri Lanka	LK
Canada	CA	Hong Kong	HK	New Zealand	NZ	Sweden	SE
Chile	CL	Hungary	HU	Nigeria	NG	Switzerland	CH
China	CN	India	IN	Norway	NO	Taiwan	TW
Colombia	CO	Indonesia	ID	Oman	OM	Thailand	TH
Congo	CG	Israel	IL	Pakistan	PK	Turkey	TR
Costa Rica	CR	Italy	IT	Panama	PA	Uganda	UG
Croatia	HR	Jamaica	JM	Paraguay	PY	Ukraine	UA
Czech Republic	CZ	Japan	JP	Philippines	PH	United States	US
Denmark	DK	Kenya	KE	Poland	PL	Uruguay	UY
Ecuador	EC	Kuwait	KW	Portugal	PT	Uzbekistan	UZ
Egypt	EG	Libya	LY	Romania	RO	Vietnam	VN
El Salvador	SV	Luxembourg	LU	Russian Federation	RU	Zimbabwe	ZW

Troubleshooting

Check the following guide for the possible cause of a problem before contacting service.

Symptom	Cause	Correction
No power.	<ul style="list-style-type: none"> The power cord is disconnected. 	<ul style="list-style-type: none"> Plug the power cord into the wall outlet securely.
Abnormal or no picture	<ul style="list-style-type: none"> The TV is not set to receive DVD+VCR signal output. 	<ul style="list-style-type: none"> Insert a disc or tape. (Check that the disc or tape indicator in the display window is lit.)
	<ul style="list-style-type: none"> The video cable is not connected securely. 	<ul style="list-style-type: none"> Select the appropriate video input mode on the TV so the picture from the DVD+VCR player appears on the TV screen.
	<ul style="list-style-type: none"> The HDMI mode is on. 	<ul style="list-style-type: none"> Set HDMI on the front panel to OFF.
	<ul style="list-style-type: none"> Unit output setting and TV resolution capabilities mismatch. 	<ul style="list-style-type: none"> Check TV capability. Check mode of connections (e.g. S-Video, Components etc.). Check unit Resolution setting according to TV capability and mode of connection.
	<ul style="list-style-type: none"> Wrong cable connection. 	<ul style="list-style-type: none"> Check the connection.
Distorted or no sound.	<ul style="list-style-type: none"> The equipment connected with the audio cable is not set to receive DVD+VCR signal output. 	<ul style="list-style-type: none"> Select the correct input mode of the audio receiver so you can listen to the sound from the DVD+VCR.
	<ul style="list-style-type: none"> The audio cables are not connected securely. 	<ul style="list-style-type: none"> Connect the audio cable into the jacks securely.
	<ul style="list-style-type: none"> The power of the equipment connected with the audio cable is turned off. 	<ul style="list-style-type: none"> Turn on the equipment connected with the audio cable.
	<ul style="list-style-type: none"> The AUDIO options are set to the wrong position. 	<ul style="list-style-type: none"> Set the AUDIO options to the correct position.
	<ul style="list-style-type: none"> In HDMI mode, audio selection is not set to PCM. 	<ul style="list-style-type: none"> Change AUDIO setup to PCM mode.
The playback picture is poor.	<ul style="list-style-type: none"> The disc is dirty. 	<ul style="list-style-type: none"> Clean the disc.
	<ul style="list-style-type: none"> The TV channels are not tuned in properly. 	<ul style="list-style-type: none"> Check tuning, carry out tuning again.
	<ul style="list-style-type: none"> Tape heads are dirty. 	<ul style="list-style-type: none"> Clean video heads.
	<ul style="list-style-type: none"> Tape is a rental or was recorded on another VCR. 	<ul style="list-style-type: none"> Use CH (-/+) for manual tracking adjustment while tape is playing.

Symptom	Cause	Correction
The DVD+VCR does not start playback.	<ul style="list-style-type: none"> No disc is inserted. No tape is inserted. 	<ul style="list-style-type: none"> Insert a disc or tape. (Check that the disc or tape indicator in the display window is lit.)
	<ul style="list-style-type: none"> An unplayable disc is inserted. 	<ul style="list-style-type: none"> Insert a playable disc. (Check the disc type and Regional code.)
	<ul style="list-style-type: none"> The disc is placed upside down. 	<ul style="list-style-type: none"> Place the disc with the playback side down.
	<ul style="list-style-type: none"> The disc is not placed within the guide. 	<ul style="list-style-type: none"> Place the disc on the disc tray correctly inside the guide.
	<ul style="list-style-type: none"> The disc is dirty. 	<ul style="list-style-type: none"> Clean the disc.
Video tape cannot be inserted.	<ul style="list-style-type: none"> Is the cassette compartment empty? 	<ul style="list-style-type: none"> Eject the tape in.
No Hi-Fi sound	<ul style="list-style-type: none"> Audio mode is not set properly. 	<ul style="list-style-type: none"> Select STEREO by repeatedly pressing A.MONITOR on the remote control.
The remote control does not work properly.	<ul style="list-style-type: none"> There is an obstacle in the path of the remote control and this unit. 	<ul style="list-style-type: none"> Remove the obstacle.
	<ul style="list-style-type: none"> The batteries in the remote control are exhausted. 	<ul style="list-style-type: none"> Replace the batteries with new ones.
	<ul style="list-style-type: none"> The remote control is not pointed at the remote sensor of the DVD+VCR. 	<ul style="list-style-type: none"> Point the remote control at the remote sensor of the DVD+VCR.
	<ul style="list-style-type: none"> The remote control is too far from the DVD+VCR. 	<ul style="list-style-type: none"> Operate the remote control within 23 ft (7m).
	<ul style="list-style-type: none"> This remote control use the same buttons for VCR and DVD functions (ex. PLAY). 	<ul style="list-style-type: none"> When using a VCR, first press the VCR button. When using a DVD, first press the DVD button.
Camcorder image is not shown.	<ul style="list-style-type: none"> Camcorder is off. 	<ul style="list-style-type: none"> Turn camcorder on and operate properly.
Camcorder image via AV input to DVD+VCR is not shown on TV screen.	<ul style="list-style-type: none"> DVD+VCR SOURCE SELECT is not set to LINE1 or LINE2. 	<ul style="list-style-type: none"> Press AUX to select LINE input channel (LINE1 or LINE2).
Timer recording is not possible.	<ul style="list-style-type: none"> Clock in DVD+VCR is not set to correct time. 	<ul style="list-style-type: none"> Set clock to correct time.
	<ul style="list-style-type: none"> Timer has been programmed incorrectly. 	<ul style="list-style-type: none"> Reprogram Timer.
	<ul style="list-style-type: none"> Ⓞ indicator light does not appear after programming timer. 	<ul style="list-style-type: none"> Reprogram Timer and turn DVD+VCR off to enable timer.

Specifications

General

Power requirements	120 V, 60 Hz
Power consumption	18 W
Dimensions (approx.)	16.9" X 3.1" X 10.4" (430 X 78.5 X 265 mm) (w x h x d)
Weight (approx.)	9.26 lbs (4.2 kg)
Operating temperature	5°C to 40°C (41°F to 104°F)
Operating humidity	5 % to 90 %
Signal system	NTSC

Inputs

ANTENNA IN	75 ohms (VHF/UHF/CATV)
VHS VIDEO IN (LINE1, 2)	1 V (p-p) 75 ohms, sync negative, RCA jack x 2
VHS AUDIO IN (LINE1, 2)	-6.0 dBm more than 47 ohms, RCA jack (L, R) x 2

Outputs

VIDEO OUT	1 V (p-p) 75 ohms, sync negative
S-VIDEO OUT	(Y) 1.0 V (p-p), 75 ohms, negative sync, Mini DIN 4-pin x 1 (C) 0.286 V (p-p) 75 ohms
COMPONENT VIDEO OUT (PROGRESSIVE SCAN)	(Y) 1.0 V (p-p), 75 ohms, negative sync, RCA jack x 1 (Pb)/(Pr) 0.7 V (p-p), 75 ohms, RCA jack x 2
HDMI OUT	19-pin x 1, Corresponding to HDCP Video: 480p/720p/1080i Audio: 2 ch PCM/Bitstream
Audio output (digital audio)	0.5 V (p-p), 75 ohms, RCA jack x 1, OPTICAL x 1
Audio output (analog audio)	2.0 Vrms (1 KHz, 0 dB), 600 ohms, RCA jack (L, R) x 1
RF OUT	Channel 3 or 4 (Adjustable)

VCR Specifications

Head system	Four head helical scan azimuth system
Timer	12-hour display type with AM, PM
Tape speed	SP: 33.35 mm/sec, LP: 16.67 mm/sec, SLP: 11.12 mm/sec
Tape width	12.7 mm
Maximum recording time	SP: 2 HOURS (T-120), SLP: 6 HOURS (T-120)/8 HOURS (T-160)
Rewind time	About 3 minutes (T-120)
Channel coverage	VHF: 2-13, UHF: 14-69, CATV: 1-125 (4A, A-W, W+1 - W+84, A-5 - A-1)
Frequency range	20 Hz to 20 kHz
Signal-to-noise ratio	More than 43 dB
Dynamic range	More than 88 dB
Channel separation	More than 60 dB

DVD Specifications

Laser system	Semiconductor laser, wavelength 650 nm
Frequency response	DVD (PCM 96 kHz): 8 Hz to 44 kHz, DVD (PCM 48 kHz): 8 Hz to 22 kHz CD: 8 Hz to 20 kHz
Signal-to-noise ratio	More than 100 dB (ANALOG OUT jacks only)
Harmonic distortion	Less than 0.008%
Dynamic range	More than 95 dB (DVD/CD)

Accessories:

RF 75-ohm Coaxial Cable x 1, Remote control x 1, Batteries (R03/AAA) x 2

- Design and specifications are subject to change without prior notice.

Warranty (Only in U.S.A.)



LIMITED WARRANTY

VCR EXCHANGE-90

JVC COMPANY OF AMERICA warrants this Video Cassette Recorder and all parts thereof, except as set forth below ONLY TO THE ORIGINAL PURCHASER AT RETAIL to be FREE FROM DEFECTIVE MATERIALS AND WORKMANSHIP from the date of the original retail purchase for the period shown below. ("The Warranty Period")

LABOR 90 DAYS	PARTS 90DAYS
----------------------	---------------------

THIS LIMITED WARRANTY IS VALID ONLY IN THE FIFTY (50) UNITED STATES, THE DISTRICT OF COLUMBIA AND IN THE COMMONWEALTH OF PUERTO RICO.

WHAT WE WILL DO:

If this product is found to be defective within the warranty period, JVC will, at its option, either repair or replace the defective part(s) or replace the product with a new or refurbished functionally equivalent product. Within 90 days from date of retail sale, repair or replacement will be at no charge to the customer.

WHAT YOU MUST DO FOR WARRANTY SERVICE:

Please do not return your product to the retailer. Instead, please box the product carefully, preferably in the original carton, and ship, insured to the JVC repair/replacement facility nearest you.

To obtain the address of the location nearest you, please call (800) 252-5722 or visit our website at <http://www.jvc.com>

A COPY OF YOUR BILL OF SALE, A COMPLETED WARRANTY REPAIR/REPLACEMENT FORM AND ALL OF THE ORIGINAL ACCESSORIES WHICH CAME WITH YOUR UNIT MUST ACCOMPANY THE PRODUCT TO BE ELIGIBLE FOR REPAIR/REPLACEMENT UNDER WARRANTY.

If you have any questions concerning your JVC Product, please contact our Customer Care Center at (800) 252-5722.

WHAT IS EXCLUDED:

The warranty does not cover:

1. Products which have been subject to abuse, accident, alteration, modification, tampering, negligence, misuse, faulty installation, lack of reasonable care, or if repaired or serviced by anyone other than a service facility authorized by JVC to render such service, or if affixed to any attachment not provided with the products, or if the model or serial number has been altered, tampered with, defaced or removed.
2. Initial installation, installation and removal, from "built in" entertainment centers, and other mounting systems.
3. Operational adjustments covered in the Owner's Manual, normal maintenance, including head cleaning.
4. Damage that occurs in shipment, due to act of God, and cosmetic damage.
5. Signal reception problems and failures due to line power surge.
6. Products used for commercial purposes (including but not limited to rental).
7. Accessories.
8. Batteries (except that Rechargeable Batteries are covered for 90 days from the date of purchase).

There are no express warranties except as listed above.

AFTER THE WARRANTY:

Please contact JVC's Customer Care Center at (800) 252-5722 to obtain the cost of out of warranty repair or replacement.

THE DURATION OF ANY IMPLIED WARRANTIES, INCLUDING THE IMPLIED WARRANTY OF MERCHANTABILITY, IS LIMITED TO THE DURATION OF THE EXPRESS WARRANTY HEREIN.

JVC SHALL NOT BE LIABLE FOR ANY LOSS OF USE OF THE PRODUCT, INCONVENIENCE, OR ANY OTHER DAMAGES, WHETHER DIRECT, INCIDENTAL OR CONSEQUENTIAL (INCLUDING, WITHOUT LIMITATION, DAMAGE TO TAPES, RECORDS OR DISCS) RESULTING FROM THE USE OF THIS PRODUCT, OR ARISING OUT OF ANY BREACH OF THIS WARRANTY. ALL EXPRESS AND IMPLIED WARRANTIES, INCLUDING THE WARRANTIES OF MERCHANTABILITY AND FITNESS FOR PARTICULAR PURPOSE, ARE LIMITED TO THE WARRANTY PERIOD SET FORTH ABOVE.

Some states do not allow the exclusion of incidental or consequential damages or limitations on how long an implied warranty lasts, so these limitations or exclusions may not apply to you. This warranty gives you specific legal rights and you may also have other rights which vary from state to state.

JVC COMPANY OF AMERICA
DIVISION OF JVC AMERICAS CORP.

1700 Valley Road
Wayne, New Jersey 07470

<http://www.jvc.com>

REFURBISHED PRODUCTS CARRY A SEPARATE WARRANTY, THIS WARRANTY DOES NOT APPLY. FOR DETAIL OF REFURBISHED PRODUCT WARRANTY, PLEASE REFER TO THE REFURBISHED PRODUCT WARRANTY INFORMATION PACKAGED WITH EACH REFURBISHED PRODUCT.

For customer use:

Enter below the Model No. and Serial No. which is located either on the rear, bottom or side of the cabinet. Retain this information for future reference.

Model No.: _____ Serial No.: _____

Purchase Date : _____ Name Of Dealer : _____



WARRANTY REPAIR / REPLACEMENT FORM

PLEASE COMPLETE THE FOLLOWING;

PLEASE NOTE : P.O. BOXES ARE NOT ACCEPTABLE

NAME: _____

STREET ADDRESS: _____

CITY: _____ STATE _____ ZIPCODE _____

DAY TIME PHONE NUMBER: _____

REASON FOR RETURN _____

Please do not return your product to the retailer. Instead, please box the product carefully, preferably in the original carton, and ship, insured to the JVC repair/replacement facility nearest you.

A COPY OF YOUR BILL OF SALE, A COMPLETED WARRANTY REPAIR/REPLACEMENT FORM AND ALL OF THE ORIGINAL ACCESSORIES WHICH CAME WITH YOUR UNIT MUST ACCOMPANY THE PRODUCT TO BE ELIGIBLE FOR REPAIR/REPLACEMENT UNDER WARRANTY.

To obtain the address of the location nearest you, please call (800) 252-5722 or visit our website <http://www.jvc.com>.

If you have any questions concerning your JVC Product, please contact our Customer Care Center at (800) 252-5722.

BT-51031-2
(0704)

US Printed in Indonesia
0306MNH-SW-LG

Free Manuals Download Website

<http://myh66.com>

<http://usermanuals.us>

<http://www.somanuals.com>

<http://www.4manuals.cc>

<http://www.manual-lib.com>

<http://www.404manual.com>

<http://www.luxmanual.com>

<http://aubethermostatmanual.com>

Golf course search by state

<http://golfingnear.com>

Email search by domain

<http://emailbydomain.com>

Auto manuals search

<http://auto.somanuals.com>

TV manuals search

<http://tv.somanuals.com>