

JVC

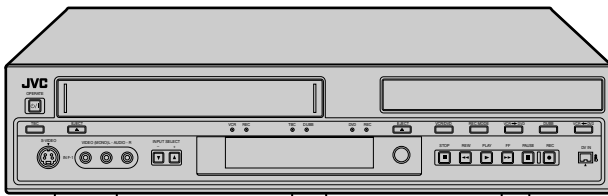

DVD VIDEO RECORDER & VIDEO CASSETTE RECORDER

SR-MV55U/ SR-MV45U



Super VHS ET



INSTRUCTIONS

For Customer Use:

Enter below the Model No. and Serial No. which are located on the rear of cabinet. Retain this information for future reference.

Model No. _____

Serial No. _____

LPT1145-001A

EN

Dear Customer,

Thank you for purchasing the JVC DVD video recorder/video cassette recorder. Before use, please read the safety information and precautions to ensure safe use of your new unit.

CAUTIONS**CAUTION**

**RISK OF ELECTRIC SHOCK
DO NOT OPEN**

AVIS

**RISQUE DE CHOC ELECTRIQUE
- NE PAS OUVRIR.**

**This Class B digital apparatus complies with
Canadian ICES-003.**

**Cet appareil numérique de la
classe B est conforme à la
norme NMB-003 du Canada.**



The lightning flash with arrowhead symbol, within an equilateral triangle, is intended to alert the user to the presence of uninsulated "dangerous voltage" within the product's enclosure that may be of sufficient magnitude to constitute a risk of electric shock to persons.



The exclamation point within an equilateral triangle is intended to alert the user to the presence of important operating and maintenance (servicing) instructions in the literature accompanying the appliance.

CAUTION:

A UNIT IS A CLASS 1 LASER PRODUCT. HOWEVER THIS UNIT USES A VISIBLE LASER BEAM WHICH COULD CAUSE HAZARDOUS RADIATION EXPOSURE IF DIRECTED. BE SURE TO OPERATE THE UNIT CORRECTLY AS INSTRUCTED.

WHEN THIS UNIT IS PLUGGED INTO THE WALL OUTLET, DO NOT PLACE YOUR EYES CLOSE TO THE OPENING OF THE DISC TRAY AND OTHER OPENINGS TO LOOK INTO THE INSIDE OF THIS UNIT.

USE OF CONTROLS OR ADJUSTMENTS OR PERFORMANCE OF PROCEDURES OTHER THAN THOSE SPECIFIED HEREIN MAY RESULT IN HAZARDOUS RADIATION EXPOSURE.

DO NOT OPEN COVERS AND DO NOT REPAIR YOURSELF. REFER SERVICING TO QUALIFIED PERSONNEL.

CLASS 1 LASER PRODUCT**REPRODUCTION OF LABELS****WARNING LABEL INSIDE OF THE UNIT**

CAUTION VISIBLE AND/OR INVISIBLE CLASS 1M LASER RADIATION WHEN OPEN DO NOT STARE INTO BEAM OR VIEW DIRECTLY WITH OPTICAL INSTRUMENTS.	ATTENTION RAYONNEMENT LASER VISIBLE ET/OU INVISIBLE DE CLASSE 1M UNE FOIS OUVERT. NE PAS FIXER LE FASCEAU NI REGARDER DIRECTEMENT AVEC DES INSTRUMENTS OPTIQUES.	ADVARSEL SYNLIG OG/ELLER USYNLIG KLASSE 1M-LASERSTRÅLING VED ÅBNING. SE IKKE IND I STRÅLEN-HELLER IKKE MED OPTISKE INSTRUMENTER.	ADVARSEL SYNLIG OG/ELLER USYNLIG LASERSTRÅLING I KLASSE 1 M NÅR DEKSEL ÅBNES. IKKE STIRP INN I STRÅLEN ELLER SE DIREKTE MED OPTISKE INSTRUMENTER.	VARO! AVATTASSA OLET ALTIINA NÄKYVÄLLE JÄI TAI NÄKYMÄTÖMÄLLE LUOKAN 1M LASERSÄTELYLLE. ÄLÄ KATSO SUORAAN SÄTEESEEN TAI TARKASTELE SIFÄ OPTISEN LAITTEEN LÄPI.	VARNING SYNLIG OCH/ELLER OSYNLIG LASERSTRÅLING KLASS 1M NÄR DENNA DEL ÄR ÖPPNAD. STIRRA EJ IN I STRÅLEN OCH BETRÄKTA EJ STRÅLEN MED OPTISKA INSTRUMENT. LPM1235-001A
---	---	---	--	--	---

OR

CAUTION CLASS 1M LASER RADIATION WHEN OPEN DO NOT VIEW DIRECTLY WITH OPTICAL INSTRUMENTS.	ATTENTION EMET UN RAYONNEMENT LASER DE CLASSE 1M LORSQUE OUVERT. NE PAS REGARDER DIRECTEMENT A TRAVERS DES INSTRUMENTS D'OPTIQUES.	ADVARSEL EMET UN KLASSE 1M-LASERSTRÅLING NÅR ÅBNET. IKKE SE DIREKTE INN I OPTISKE INSTRUMENTER.	ADVARSEL KLASSE 1M LASERSTRÅLING NÅR APPARATET ÅBNES. KIG IKKE DIREKTE PÅ STRÅLEN MED OPTISKE INSTRUMENTER.	VARO! LUOKAN 1M LASERSÄTELY LÄITTEEN SISÄLLÄ. ÄLÄ KATSO SÄTEESEEN SUORAAN OPTISILLA LÄITTEILLÄ.	VARNING KLASS 1M LASERSTRÅLING NÅR DEN ÄR ÖPPEN. TITTA INTE DIREKT PÅ DEN MED OPTISKA INSTRUMENT. (SW) LPM1235-001A
---	--	--	---	---	--

This unit apply to the standard "IEC60825-1:2001" for laser products.

WARNING:

TO PREVENT FIRE OR SHOCK HAZARD, DO NOT EXPOSE THIS UNIT TO RAIN OR MOISTURE.

CAUTION:

This unit should be used with AC 120V~, 60Hz only.

To prevent electric shocks and fire hazards, DO NOT use any other power source.

CAUTION:

TO PREVENT ELECTRIC SHOCK, MATCH WIDE BLADE OF PLUG TO WIDE SLOT, FULLY INSERT.

ATTENTION:

POUR ÉVITER LES CHOC ÉLECTRIQUES, INTRODUIRE LA LAME LA PLUS LARGE DE LA FICHE DANS LA BORNE CORRESPONDANTE DE LA PRISE ET POUSSER JUSQU'AU FOND.

Note to CATV system installer:

This reminder is provided to call the CATV system installer's attention to Article 820-40 of the NEC that provides guidelines for proper grounding and, in particular, specifies that the cable ground shall be connected to the grounding system of the building, as close to the point of cable entry as practical.

CAUTION:

Changes or modifications not approved by JVC could void user's authority to operate the equipment.

IMPORTANT PRODUCT SAFETY INSTRUCTIONS

Electrical energy can perform many useful functions. But improper use can result in potential electrical shock or fire hazards. This product has been engineered and manufactured to assure your personal safety. In order not to defeat the built-in safeguards, observe the following basic rules for its installation, use and servicing.

ATTENTION:

Follow and obey all warnings and instructions marked on your product and its operating instructions. For your safety, please read all the safety and operating instructions before you operate this product and keep this booklet for future reference.

INSTALLATION

1. Grounding or Polarization

(A) Your product may be equipped with a polarized alternating-current line plug (a plug having one blade wider than the other). This plug will fit into the power outlet only one way. This is a safety feature.

If you are unable to insert the plug fully into the outlet, try reversing the plug. If the plug should still fail to fit, contact your electrician to replace your obsolete outlet. Do not defeat the safety purpose of the polarized plug.

(B) Your product may be equipped with a 3-wire grounding-type plug, a plug having a third (grounding) pin. This plug will only fit into a grounding-type power outlet. This is a safety feature. If you are unable to insert the plug into the outlet, contact your electrician to replace your obsolete outlet. Do not defeat the safety purpose of the grounding-type plug.

2. Power Sources

Operate your product only from the type of power source indicated on the marking label. If you are not sure of the type of power supply to your home, consult your product dealer or local power company. If your product is intended to operate from battery power, or other sources, refer to the operating instructions.

3. Overloading

Do not overload wall outlets, extension cords, or integral convenience receptacles as this can result in a risk of fire or electric shock.

4. Power Cord Protection

Power supply cords should be routed so that they are not likely to be walked on or pinched by items placed upon or against them, paying particular attention to cords at plugs, convenience receptacles, and the point where they exit from the product.

5. Ventilation

Slots and openings in the cabinet are provided for ventilation. To ensure reliable operation of the product and to protect it from overheating, these openings must not be blocked or covered.

- Do not block the openings by placing the product on a bed, sofa, rug or other similar surface.
- Do not place the product in a built-in installation such as a bookcase or rack unless proper ventilation is provided or the manufacturer's instructions have been adhered to.

6. Wall or Ceiling Mounting

The product should be mounted to a wall or ceiling only as recommended by the manufacturer.

USE

1. Accessories

To avoid personal injury:

- Do not place this product on an unstable cart, stand, tripod, bracket, or table. It may fall, causing serious injury to a child or adult, and serious damage to the product.
- Use only with a cart, stand, tripod, bracket, or table recommended by the manufacturer or sold with the product.
- Use a mounting accessory recommended by the manufacturer and follow the manufacturer's instructions for any mounting of the product.
- Do not try to roll a cart with small casters across thresholds or deep-pile carpets.

2. Product and Cart Combination

A product and cart combination should be moved with care. Quick stops, excessive force, and uneven surfaces may cause the product and cart combination to overturn.

PORTABLE CART WARNING
(Symbol provided by RETAC)



3. Water and Moisture

Do not use this product near water—for example, near a bath tub, wash bowl, kitchen sink or laundry tub, in a wet basement, or near a swimming pool and the like.

4. Object and Liquid Entry

Never push objects of any kind into this product through openings as they may touch dangerous voltage points or short-out parts that could result in a fire or electric shock. Never spill liquid of any kind on the product.

5. Attachments

Do not use attachments not recommended by the manufacturer of this product as they may cause hazards.

6. Cleaning

Unplug this product from the wall outlet before cleaning. Do not use liquid cleaners or aerosol cleaners. Use a damp cloth for cleaning.

7. Heat

The product should be situated away from heat sources such as radiators, heat registers, stoves, or other products (including amplifiers) that produce heat.

SERVICING

1. Servicing

If your product is not operating correctly or exhibits a marked change in performance and you are unable to restore normal operation by following the detailed procedure in its operating instructions, do not attempt to service it yourself as opening or removing covers may expose you to dangerous voltage or other hazards. Refer all servicing to qualified service personnel.

2. Damage Requiring Service

Unplug this product from the wall outlet and refer servicing to qualified service personnel under the following conditions:

- a. When the power supply cord or plug is damaged.
- b. If liquid has been spilled, or objects have fallen into the product.
- c. If the product has been exposed to rain or water.
- d. If the product does not operate normally by following the operating instructions. Adjust only those controls that are covered by the operating instructions as an improper adjustment of other controls may result in damage and will often require extensive work by a qualified technician to restore the product to its normal operation.
- e. If the product has been dropped or damaged in any way.
- f. When the product exhibits a distinct change in performance—this indicates a need for service.

3. Replacement Parts

When replacement parts are required, be sure the service technician has used replacement parts specified by the manufacturer or which have the same characteristics as the original part. Unauthorized substitutions may result in fire, electric shock or other hazards.

4. Safety Check

Upon completion of any service or repairs to this product, ask the service technician to perform safety checks to determine that the product is in safe operating condition.

HOW TO USE THIS INSTRUCTION MANUAL

- All major sections and subsections are listed in the Table Of Contents on page 6. Use this when searching for information on a specific procedure or feature.
- The Index on pages 11 – 15 illustrates the controls and connections on the front and rear panel, the front display panel and the remote control.
- The list of terms on page 87 lists frequently-used terms, and the number of the page on which they are used or explained in the manual.
- The  mark signals a reference to another page for instructions or related information.
- Operation buttons necessary for the various procedures are clearly indicated through the use of illustrations at the beginning of each major section.

BEFORE YOU INSTALL YOUR NEW UNIT . . .

. . . **please read the sections/literature listed below.**

- “CAUTIONS” on page 2
- “IMPORTANT PRODUCT SAFETY INSTRUCTIONS” on pages 3 – 5

Declaration of Conformity

Model Number: SR-MV55U/SR-MV45U
 Trade Name: JVC
 Responsible Party: JVC Americas Corp.
 Address: 1700 Valley Road Wayne, N.J. 07470
 Telephone Number: 973-317-5000

This device complies with Part 15 of FCC Rules.
 Operation is subject to the following two conditions:

(1) This device may not cause harmful interference, and (2) this device must accept any interference received, including interference that may cause undesired operation.

This equipment has been tested and found to comply with the limits for a Class B digital device, pursuant to Part 15 of the FCC Rules. These limits are designed to provide reasonable protection against harmful interference in a residential installation. This equipment generates, uses, and can radiate radio frequency energy and, if not installed and used in accordance with the instructions, may cause harmful interference to radio communications. However, there is no guarantee that interference will not occur in a particular installation. If this equipment does cause harmful interference to radio or television reception, which can be determined by turning the equipment off and on, the user is encouraged to try to correct the interference by one or more of the following measures:

- Reorient or relocate the receiving antenna.
- Increase the separation between the equipment and receiver.
- Connect the equipment into an outlet on a circuit different from that to which the receiver is connected.
- Consult the dealer or an experienced radio/TV technician for help.



- Manufactured under licence from Dolby Laboratories. "Dolby" and the double-D symbol are trademarks of Dolby Laboratories.
- "DTS" and "DTS Digital Out" are trademarks of Digital Theater Systems, Inc.
- Cassettes marked "S-VHS" and "VHS" can be used with this unit. However, S-VHS recordings are possible only with cassettes marked "S-VHS".

By using the S-VHS ET function, it is possible to record and play back with S-VHS picture quality on VHS cassettes with this unit.

- This product incorporates copyright protection technology that is protected by method claims of certain U.S. patents and other intellectual property rights owned by Macrovision Corporation and other rights owners. Use of this copyright protection technology must be authorized by Macrovision Corporation, and is intended for home and other limited viewing users only unless otherwise authorized by Macrovision Corporation. Reverse engineering or disassembly is prohibited.

When the equipment is installed in a cabinet or a shelf, make sure that it has sufficient space on all sides to allow for ventilation (10 cm or more on both sides, on top and at the rear).

When discarding batteries, environmental problems must be considered and the local rules or laws governing the disposal of these batteries must be followed strictly.

Failure to heed the following precautions may result in damage to the unit, remote control or disc/cassette.

1. **DO NOT place the unit** —
 - in an environment prone to extreme temperatures or humidity.
 - in direct sunlight.
 - in a dusty environment.
 - in an environment where strong magnetic fields are generated.
 - on a surface that is unstable or subject to vibration.
2. **DO NOT block the unit's ventilation openings or holes.**
 (If the ventilation openings or holes are blocked by a newspaper or cloth, etc., the heat may not be able to get out.)
3. **DO NOT place heavy objects on the unit or remote control.**
4. **DO NOT place anything which might spill on top of the unit or remote control.**
 (If water or liquid is allowed to enter this equipment, fire or electric shock may be caused.)
5. **DO NOT expose the apparatus to dripping or splashing.**
6. **DO NOT use this equipment in a bathroom or places with water. Also DO NOT place any containers filled with water or liquids (such as cosmetics or medicines, flower vases, potted plants, cups, etc.) on top of this unit.**
7. **DO NOT place any naked flame sources, such as lighted candles, on the apparatus.**
8. **AVOID violent shocks to the unit during transport.**

MOISTURE CONDENSATION

Moisture in the air will condense on the unit when you move it from a cold place to a warm place, or under extremely humid conditions—just as water droplets form on the surface of a glass filled with cold liquid. In conditions where condensation may occur, disconnect the unit's power plug from the wall and keep it disconnected for a few hours to let the moisture dry, then turn on the unit.

ATTENTION:



- Using a mobile phone in the vicinity of the unit may cause picture vibration on the TV screen or change the screen to black back display.
- Some TVs or other appliances generate strong magnetic fields. Do not place such appliances on top of the unit as it may cause picture disturbance.
- If there is a power outage when using the unit, the recorded data may be erased.
- Recorded programs and data cannot be restored once the disc or tape is damaged.

DISC INFORMATION	7	EDITING	46
About Discs	7	Tape Dubbing (From VCR To DVD)	46
INDEX	11	Manual Dubbing (From VCR To DVD)	47
INSTALLING YOUR NEW UNIT	16	Disc Dubbing (From DVD To VCR)	48
Basic Connection	16	Manual Dubbing (From DVD To VCR)	49
INITIAL SETTINGS	17	Program Dubbing (From DVD to VCR)	50
Clock Set	17	DV Dubbing (DVD Deck Only).....	51
Language	18	Edit From A Camcorder.....	52
Monitor Set (DVD Deck Only)	19	Edit To Or From Another Recorder	53
OPERATIONS ON DVD DECK	20	Digital Audio Dubbing	54
Basic Playback.....	20	REMOTE CONTROL	55
Playback Features	21	Remote Control Functions.....	55
Live Memory Playback.....	24	SYSTEM CONNECTIONS	57
Using The On-screen Bar	28	Connecting To A Dolby Digital Decoder Or An Amplifier	
Parental Lock	32	With Built-in DTS	57
OPERATIONS ON VCR DECK	33	SUBSIDIARY SETTINGS	58
Basic Playback.....	33	Mode Set (DVD Deck)	58
Playback Features	34	Mode Set (VCR Deck)	60
RECORDING	36	Format A Disc (DVD Deck Only)	62
Simultaneous Recording.....	36	Finalize A Disc (DVD Deck Only)	63
Recording Features (DVD Deck)	37	Scan Mode Set.....	65
Recording Features (VCR Deck)	38	Tray Lock (DVD Deck Only)	65
NAVIGATION (DVD DECK ONLY)	39	Mode Lock	65
Library Database DVD Navi	39	Last Function Memory	65
Edit Original Information.....	40	TROUBLESHOOTING	66
Edit Play List Information	42	GLOSSARY	69
Edit Library Information.....	44	APPENDIX	70
Playback With MP3/JPEG Navigation.....	45	RS-232C INTERFACE (SR-MV55U ONLY)	73
		RS-232C Interface – Command Table –	73
		RS-232C Interface – Specifications –	73
		RS-232C Interface – Command –	74
		SPECIFICATIONS	86
		LIST OF TERMS	87

About Discs

Recordable/playable Discs

You can use discs with the following logos for recording and playback.

 <p>DVD-RAM 12 cm: 4.7 GB/9.4 GB 8 cm: 1.4 GB/2.8 GB Ver. 2.0 Ver. 2.1, Ver. 2.1/3x Ver. 2.2/5x</p>	 <p>DVD-RW 12 cm: 4.7 GB/9.4 GB 8 cm: 1.4 GB/2.8 GB Ver. 1.0 (VR mode) Ver. 1.1, Ver. 1.1/2x (Video mode/VR mode) Ver. 1.2/4x (Video mode/VR mode)</p>
 <p>DVD-R 12 cm: 4.7 GB/9.4 GB 8 cm: 1.4 GB/2.8 GB General Ver. 2.0 (Video mode) General Ver. 2.0/4x/8x/16x (Video mode)</p>	

- The above table is based on the information as of December 2006.
- Recording and playback may not be performed depending on the characteristics and condition of the disc used, leading to unsatisfactory results. Using discs manufactured by JVC is recommended since they have been tested to be compatible with this unit.

DVD-RAM Discs

It is only possible to use discs which conform with DVD-RAM standard Version 2.0 or 2.1.

- It is impossible to record on DVD-RAM discs which do not conform to this standard. If you use a disc formatted under a different standard version, format it on this unit before use.
- It may not be possible to record, play back, edit or dub a DVD-RAM disc even if it conforms to the standard if it was recorded or edited on the devices from other manufacturers or on a PC, or if it has far too many titles, or if there is very little available capacity remaining on the disc.
- Some DVD-RAM discs are contained in a cartridge. This unit cannot handle this type of disc. Remove the disc from the cartridge (only discs with a removable cartridge); or the use of DVD-RAM discs not contained in a cartridge is recommended.
- DVD-RAM discs recorded on this unit cannot be played back on an incompatible DVD player.
- It is possible to record copy-once programs of digital broadcasts only onto 4.7/9.4 GB DVD-RAM discs (2.8 GB DVD-RAM discs are not compatible).

DVD-R/RW Discs

It is only possible to use DVD-R discs which conform with DVD-R standard Version 2.0.

When a DVD-R/RW disc (Video mode) is finalized (☞ pg. 63), it can be played back on a standard DVD player as a DVD VIDEO disc.

When a DVD-RW disc (VR mode) is finalized (☞ pg. 63), it can be played back on a standard DVD player compatible with the VR mode of DVD-RW discs.

Before finalizing —

— it is possible to record on unrecorded areas of the disc, edit the disc title and program titles, and delete programs.

- It is impossible to record or edit DVD-R/RW discs recorded on other devices even if they have not been finalized.
- It is impossible to overwrite recorded areas of DVD-R discs.
- Available recording capacity does not increase even if a recorded program is deleted from a DVD-R disc.

After finalizing —

After a DVD-R/RW disc (Video mode) has been finalized, it is possible to play back the recorded programs (video and/or audio) on a standard DVD video player as a DVD VIDEO disc.

- Edited titles are displayed as the “DVD menu” in video mode.
- It is impossible to record, edit or delete the data either in video mode or in VR mode.
- Either in video mode or in VR mode, although the disc can be played back on DVD players from other manufacturers, sometimes it may not be possible to play back depending on the disc and recording conditions.
- It is impossible to record on CD-R/RW or DVD-R discs used for authoring.
- It is impossible to record onto DVD-R/RW (Video mode) discs broadcasts that allow you to copy once. The copy once programs can only be recorded onto DVD-RW discs formatted in VR mode.

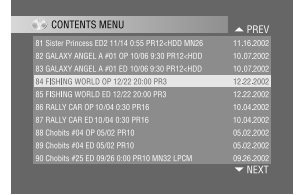







NOTE:

The following may result if you play back a DVD-R disc recorded on another unit.

- The disc does not play.
- A mosaic pattern (block noise) appears on the screen.
- Video or audio may be dropped out.
- The unit stops during playback.

Discs For Playback Only

You can use discs with the following logos for playback only.

 <p>DVD VIDEO (example of region code indications)</p> 	<p>Video CD/Super Video CD</p> 
 <p>Audio CD CD-DA files</p>	 <p>CD-R CD-DA/JPEG/MP3 files</p>
 <p>CD-RW CD-DA/JPEG/MP3 files</p>	 <p>CD-ROM JPEG/MP3 files</p>

- Playback may not be performed depending on the characteristics and condition of the disc used.
- DTS Audio CDs can also be played back (An optional DTS decoder is required).
- MP3 and JPEG discs can be played back on this unit only when they have been recorded in the ISO9660 or Joliet format and finalized.
- JPEG files that can be played back on this unit must conform to JFIF/Baseline process, and the maximum resolution of a JPEG file is 2,812 pixels in width and 2,112 pixels in height.
- CD-R/RW discs recorded in music CD format need to be finalized to play back on this unit.
- Operation and audio quality of this unit are not guaranteed for discs that do not conform to the Compact Disc specification (CD-DA). Before you play back a CD, check for the CD logo and read the notes on the package to confirm that it conforms to the Compact Disc specification.
- Depending on the intentions of the author of the software, recording conditions of DVD discs and Video CD discs may be restricted. Since this unit plays back discs according to the intentions of the author of the software as indicated on the disc, some functions may not operate as commanded.
- When switching from the first layer to the second layer of double-layered DVD VIDEO discs, the image and sound may be momentarily distorted. This is not a malfunction.

- DVD-AUDIO discs compatible with DVD video players can be played.
- Super Audio CDs (SACD) compatible with conventional CD players can be played.
- Super Video CDs (SVCD) can be played. However, depending on the discs, some may not be playable.

Unplayable Discs

The following types of discs cannot be played using this unit. Do not attempt to play back any kind of disc that is damaged (cracked, warped, or repaired with adhesive tape) or discs in unusual shapes (heart-shaped, octagonal, or other forms). If such discs are accidentally played back, it may cause noise that can lead to speaker damage.

- CD-ROM discs (including PHOTO-CD and CD-G)
- Discs recorded in Packet Write (UDF) format.
- 1.3-GB double density CDs (DDCD)
- High density CDs (HDCD)

The following discs also cannot be played back.

- Discs of a region number other than "1"
- DVD-RAM (2.6 GB/5.2 GB)
- DVD-RAM (TYPE1)

Caution for DualDisc playback

The Non-DVD side of a "DualDisc" does not comply with the "Compact Disc Digital Audio" standard. Therefore, the use of Non-DVD side of a DualDisc on this product may not be recommended.

Region Number

The world is divided into 6 regions for DVD VIDEO discs. DVD VIDEO discs are assigned a region number to indicate which region they may be played back in. A disc cannot be played back on this unit unless the region number of the disc matches that of the unit. The region number for this unit is "1". Only discs whose region number includes "1" or "ALL" can be played back such as shown below.

Examples of DVD VIDEO labels which can be played back using this unit.



Marks of discs in this instruction manual

	Allows operation with a DVD-RAM disc.		Allows operation with a Video CD disc.
	Allows operation with a DVD-R disc.		Allows operation with an Audio CD disc.
	Allows operation with a DVD-RW disc.		Allows operation with a disc including MP3 files.
	Allows operation with a DVD VIDEO disc.		Allows operation with a disc including JPEG files.

Recording Medium And Format

DVD-RAM

- Recording and erasing can be performed as many times as possible on a disc.
- Editing can be performed after recording, such as deleting unwanted parts.
- While recording, it is possible not only to start playback of a program currently being recorded, but also to watch another program previously recorded.

DVD-RW (VR mode)

- Recording and erasing can be performed as many times as possible on a disc.
- Editing can be performed after recording, such as deleting unwanted parts.

DVD-RW (Video mode)

- Can be played back on other DVD players.
- New recording can be performed by erasing all the data on a disc once played back.

DVD-R

- Can be played back on other DVD players.
- Suitable when keeping a recorded disc for a long time.

File Structure Of Discs

DVD VIDEO

Typically, DVD VIDEO discs are made up of larger units called "titles". Each title has a number (title number) that can be used to select desired titles. Titles are further divided into units called "chapters". Each chapter has a number (chapter number) that can also be used to select desired chapters. Note that some discs are not divided into titles and chapters.

When you record a program on a DVD-RAM/RW (VR mode) disc

A single recording session results in a single title (a single chapter). However, chapter marks are automatically inserted when recording is paused, or audio changes from monaural to stereo due to commercial breaks, etc. It is also possible to insert chapter marks at desired locations during playback. (pg. 22)

When you record a program on a DVD-R/RW (Video mode) disc

A single recording session results in a single title (a single chapter). However, chapter marks are automatically inserted when recording is paused, or audio changes due to commercial breaks, etc. It is also possible to insert chapter marks at desired locations during either recording or playback. Once the disc has been finalized, these chapter marks are deleted and new chapter marks are assigned automatically approximately every 5 minutes.

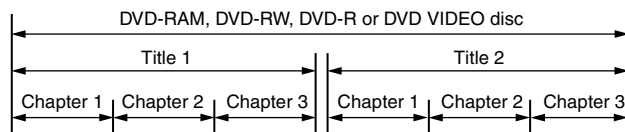

- In Video mode, even before finalizing, it is impossible to perform editing operations other than changing the disc name and/or title names and deleting programs and/or titles.
- After finalizing, it is impossible to perform editing operations.

Audio CD/Video CD

Typically, Audio CD discs are divided into separate tracks each containing one song. Each track is assigned a number. For example, the third track is Track 3. The same is true for Video CD discs.

However, some discs are not divided into tracks.

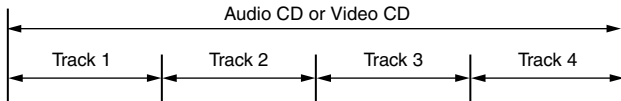

JPEG/MP3 Disc (CD-R/RW/ROM)

MP3/JPEG files put in directories nested in several levels on a disc will be organized as if they were put in single level directories (groups) by the MP3/JPEG Navigation of this unit. (pg. 45)

File structure of a disc before starting the MP3/JPEG Navigation

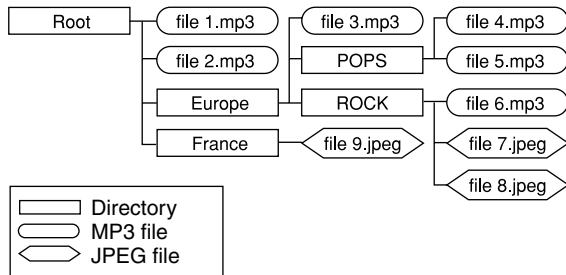

File structure of the disc after starting the MP3/JPEG Navigation

Files are automatically grouped as follows and displayed on the MP3/JPEG Navigation screen. Data is displayed in the alphabetical order of file name. Files are grouped based on roots.

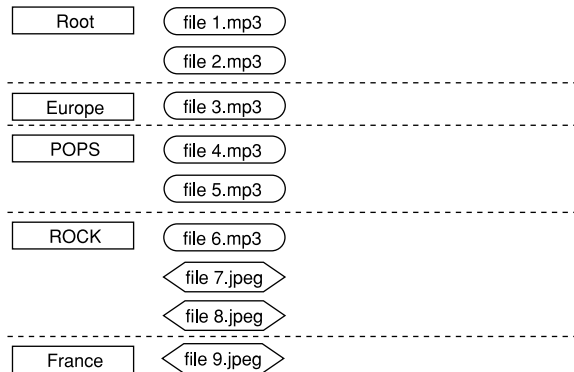

- This unit can recognize up to 9 hierarchies including directories and files. Also, it can recognize up to 250 files in each group, and up to 99 groups on a disc.

NOTES:

• Video CD discs that support Playback Control (PBC)

The contents of a disc are recorded into several hierarchies, and played back according to the instructions on the screen while navigating through the hierarchies. It is also possible to playback recorded tracks consecutively without activating the PBC function even when playing a PBC-compatible disc. (pg. 24)

• Regarding the contents recorded on discs

Some files may not be played back depending on the file types and other factors.

DVD VIDEO Marks

Sometimes marks are printed on a DVD disc and/or on its packaging to indicate information regarding the contents and functions of the disc. Check the marks indicating the contents and functions of the disc. Note, however, that in some cases a disc may not include a mark even for a function it supports.

Marks related to video

	Number of subtitles		Number of angles
	Recorded under the standard 4:3 aspect ratio		Screen includes black bands at the top and the bottom of image which has a standard 4:3 aspect ratio (letter box)
	Video playback is in Wide video mode (16:9) on wide televisions, but in letter box on televisions with standard 4:3 aspect ratio.		Video playback is in Wide video mode (16:9) on wide televisions, but pan and scan is used on televisions with standard 4:3 aspect ratio (either the left or right side of the image is cut-out).

Marks related to audio

	Number of audio tracks
	Dolby Digital Recording mark Developed by Dolby Laboratories. It enables high-quality stereo audio recording.
	DTS (Digital Theater Systems) You can enjoy DTS audio if you connect an amplifier with a built-in DTS decoder to the DIGITAL AUDIO OUT connector of the unit.

Placing A Disc

Opening the disc tray

Press ▲ (EJECT) to open the disc tray.

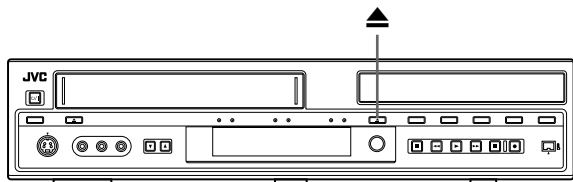

- Pressing the button again closes the disc tray.
- Use the button to open and close the disc tray.
- Do not block the disc tray with your hand while it is opening or closing as this may result in hardware failure.
- Do not place unplayable discs or any object other than a disc on the disc tray.
- Do not press down strongly on the disc tray or place any heavy objects on it.

Discs without cartridges

Place the disc on the disc tray with the label side facing up. Since disc size changes depending on the disc to be played back, be sure to correctly align the disc with the grooves for its size. If the disc is not in its groove, it may be scratched or otherwise damaged. To insert an 8 cm disc, place it according to the inner groove.

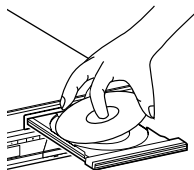

DVD-RAM discs contained in cartridges

Double-sided discs:

Remove the disc from the cartridge. Align the disc with the grooves on the disc tray as shown in the illustration and insert with the side you wish to play back or record facing down. If you insert the disc with "Side A" facing down, programs are recorded on the side A.

Single-sided discs:

Remove the disc from the cartridge. Align the disc with the grooves on the disc tray as shown in the illustration and insert with the label side facing up.

Care And Handling Of Discs

How to handle discs

When handling a disc, do not touch the surface of the disc. Since discs are made of plastic, they are easily damaged. If a disc gets dirty, dusty, scratched or warped, the images and sound will not be picked up correctly, and such a disc may cause the unit to malfunction.

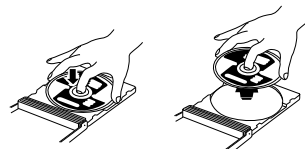

Label side

Do not damage the label side, stick paper to or use any adhesives on its surface.

Recording side

Make sure that discs are not scratched and dirty on the recording side before use. Scratches and dirt on the recording side of a disc may hinder proper playback and recording. Also be careful that a DVD-RAM disc may get scratched or dirt when removed from cartridge then put back in after use.

Storage

Make sure that discs are kept in their cases. If discs are piled on top of one another without their protective cases, they can be damaged. Do not put discs in a location where they may be exposed to direct sunlight, or in a place where the humidity or temperature is high. Avoid leaving discs in your car!

Maintenance of discs

If there are fingerprints or other dirt adhering to a disc, wipe with a soft dry cloth, moving from the centre outwards.

If a disc is difficult to clean, wipe with a cloth moistened with water. Never use record cleaners, petrol, alcohol or any anti-static agents.



CAUTION:

Sometimes during playback, noise may appear or images may be garbled. This is sometimes due to the disc. (It may not be up to industry standards.)

These symptoms are caused by the discs, not by the malfunction of the unit.

Front View

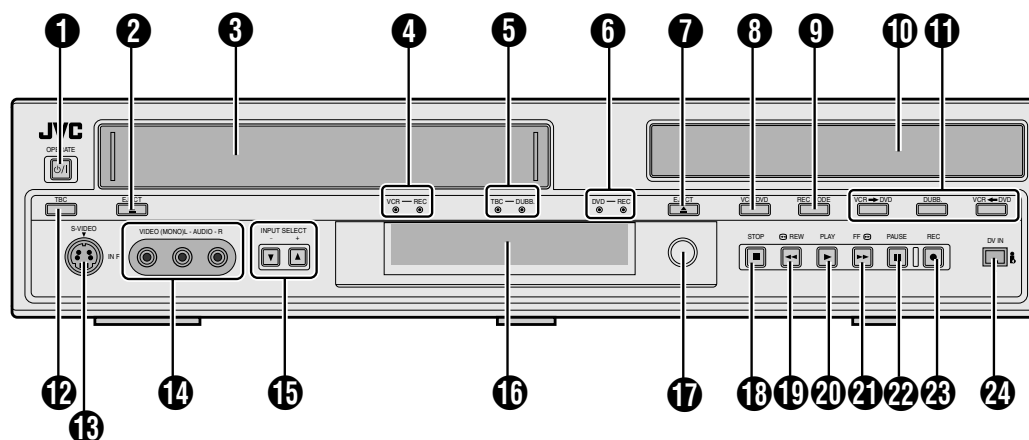

- 1 Operate Button (OPERATE ψ /I)
- 2 Eject Button (EJECT \blacktriangle)(VCR) \rightarrow pg. 33
- 3 Cassette Loading Slot
- 4 VCR Lamp \rightarrow pg. 33
- 5 VCR Recording Lamp (REC) \rightarrow pg. 36
- 6 TBC Lamp \rightarrow pg. 35
- 7 Dubbing Lamp (DUBB.) \rightarrow pg. 46
- 8 DVD Lamp (DVD) \rightarrow pg. 17, 20
- 9 DVD Recording Lamp (REC) \rightarrow pg. 36
- 10 Open/Close Button (EJECT \blacktriangle)(DVD) \rightarrow pg. 10
- 11 VCR/DVD Button
- 12 Recording Mode Button (REC MODE) \rightarrow pg. 36
- 13 Disc Tray
- 14 Dubbing Button (DUBB.) \rightarrow pg. 46
- 15 Dubbing Direction Button (VCR \rightarrow DVD/VCR \leftarrow DVD) \rightarrow pg. 46, 48
- 16 TBC Button \rightarrow pg. 35
- 17 S-video Input Connectors (S-VIDEO IN F-1) \rightarrow pg. 52
- 18 Video/Audio Input Connectors (VIDEO/AUDIO (L/R) IN F-1) \rightarrow pg. 52
- 19 Input Select Button (INPUT SELECT +/-) \rightarrow pg. 35, 36
- 20 Front Display Panel \rightarrow pg. 13
- 21 Infrared Beam Receiving Window
- 22 Stop Button (\blacksquare) \rightarrow pg. 20, 33
- 23 Reverse Search Button ($\blacktriangleleft\blacktriangleleft$) \rightarrow pg. 21, 27, 34
- 24 Rewind Button ($\blacktriangleleft\blacktriangleleft$) (VCR deck) \rightarrow pg. 33
- 25 Reverse Slow Button (SLOW -) \rightarrow pg. 22
- 26 Play Button (\blacktriangleright) \rightarrow pg. 20, 33
- 27 Forward Search Button ($\blacktriangleright\blacktriangleright$) \rightarrow pg. 21, 27, 34
- 28 Fast Forward Button ($\blacktriangleright\blacktriangleright$) (VCR deck) \rightarrow pg. 33
- 29 Forward Slow Button (SLOW +) \rightarrow pg. 22
- 30 Pause Button (\parallel) \rightarrow pg. 20, 34
- 31 Record Button (\bullet) \rightarrow pg. 36
- 32 DV Input connector [DV IN (i.Link*)] (DVD deck only) \rightarrow pg. 51

* i.Link refers to the IEEE1394-1995 industry specification and extensions thereof. The i.Link logo is used for products compliant with the i.Link standard.

When using a monaural audio cable, use [AUDIO L (MONO)] input connector. In this case, the sound on the left channel is also recorded on the right channel.

Rear View

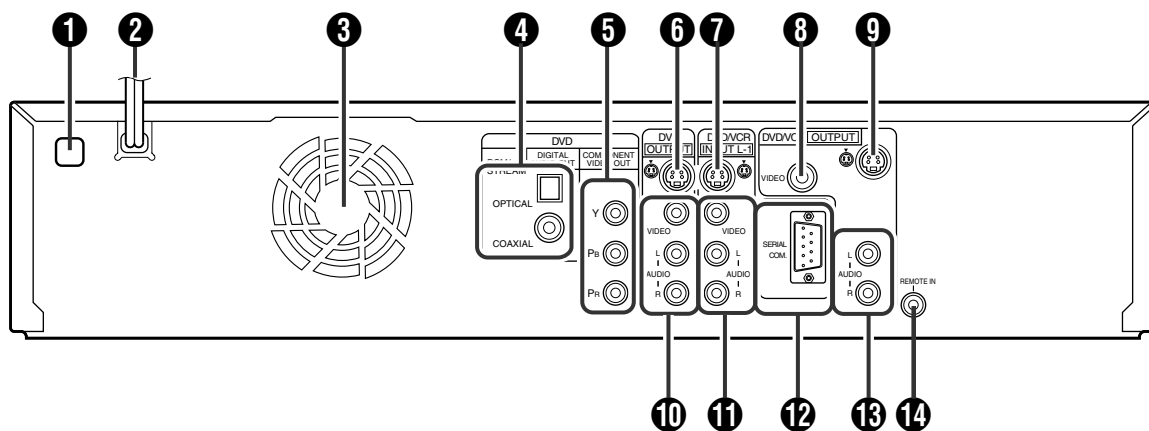

1 Region Number Label ➔ pg. 8

2 AC Power Cord ➔ pg. 16

3 Cooling Fan

- This prevents the temperature from rising inside the unit. Do not remove it.
- Install the unit so as not to block the area around the fan.
- The cooling fan may be activated even if the unit is turned off when "POWER SAVE" is set to "OFF" (➔ pg. 59).

4 Digital Audio Output Connectors [DIGITAL AUDIO OUT (COAXIAL/OPTICAL)] (DVD deck only) ➔ pg. 54, 57

5 Component Video Output Connectors [COMPONENT VIDEO OUT (Y/PB/PR)] ➔ pg. 16

- This component video output enables you to watch the images on the VCR deck in Progressive scan mode, refer to "VHS Progressive Scan" (➔ pg. 35).

6 S-video Output Connector (DVD deck only) ➔ pg. 16

7 S-video Input Connector ➔ pg. 53

8 BNC Video Output Connector [VIDEO OUTPUT] ➔ pg. 16

9 S-video Output Connector ➔ pg. 16

10 Video/Audio Output Connectors [VIDEO/AUDIO OUTPUT] (DVD deck only) ➔ pg. 16

11 Video/Audio Input Connectors (VIDEO/AUDIO INPUT [L-1]) ➔ pg. 53

12 Serial Command Connector (D-SUB 9-PIN) [SERIAL COM.] ➔ pg. 73 (SR-MV55U)

- Use this connector when controlling this unit via a computer. The cable to be used should be a RS-232C interface cable (straight type). For details on the RS-232C interface command, refer to page 73.

13 Audio Output Connectors [AUDIO OUTPUT] ➔ pg. 16

14 Remote In Connector* (REMOTE IN)

- * There is currently no compatible remote control unit available.

Front Display Panel

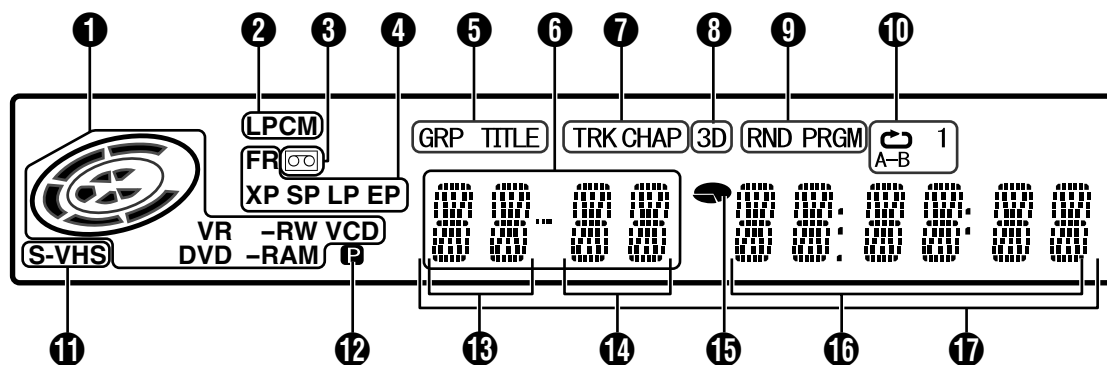

- 1** Disc Type Indicator
When a disc is loaded, the type of the disc is indicated.
- Disc Status Indicator**
When a disc is running, the disc marks rotate.
- VR Mode Indicator** ⇨ pg. 62
Lights when a DVD-RW disc is formatted in VR mode.
- 2** Linear PCM Indicator (LPCM)
Lights when "XP MODE REC AUDIO" is set to "LINEAR PCM" (⇨ pg. 59) for recording with DVD-RAM, DVD-R and DVD-RW discs, and when Linear PCM audio is played.
- 3** Cassette Loaded Mark ()
Indicates the present of a cassette in the VCR deck. Lights when a cassette is loaded into the VCR deck.
- 4** Recording Mode Indicator (XP/SP/LP/EP/FR) ⇨ pg. 37
Blinks when recording mode is being set.
While "FR" is blinking, the left 3 digits of the Multi Display (13 14) indicate setting values ranging from "60" to "480". After the value has been set, only "FR" lights.
- 5** Group/Title Indicator (GRP/TITLE)
"GRP" or "TITLE" lights depending on a disc loaded while the left 2 digits of the Multi Display (13) indicate the numbers explained below.
"GRP": Total number of groups or group number being played back are displayed on the Multi Display.
"TITLE": Total number of titles or title number being played back are displayed on the Multi Display.
- 6** Input Indicator
Indicates the input selected.
- 7** Track/Chapter Indicator (TRK/CHAP)
"TRK" or "CHAP" lights depending on a disc loaded while the 3rd and 4th digits from the left of the Multi Display (14) indicate the numbers explained below.
"TRK": Total number of tracks or track number being played back are displayed on the Multi Display.
"CHAP": Chapter number being played back are displayed on the Multi Display.
- 8** Simulated Surround Effect Indicator (3D) ⇨ pg. 30
Lights when a simulated surround effect is set to "3D-ON" on the on-screen bar.
- 9** Random/Program Playback Mode Indicator (RND/PRGM) ⇨ pg. 31
"RND": Lights when Random Playback mode is set.
"PRGM": Lights when Program Playback mode is set.
- 10** Repeat Mode Indicator (1/A-B) ⇨ pg. 29, 35
Select Repeat Playback mode on the on-screen bar.
"1": Whole disc is played back repeatedly. It also lights up during the Repeat Playback on the VCR deck.
"1": A single title/chapter/track is played back repeatedly.
"A-B": The selected part (A-B) is played back repeatedly.
No display: Repeat Playback mode is off.
- 11** S-VHS Indicator
Lights up when a cassette marked "S-VHS" is inserted with "S-VHS MODE" set to "ON" (⇨ pg. 61), the cassette recorded in S-VHS or S-VHS ET mode is played back, or when "S-VHS ET" is set to "ON". (⇨ pg. 60)
- 12** Video Output Indicator (P) ⇨ pg. 65
No display: Indicates that interlace mode is engaged.
P: Indicates that progressive mode is engaged.
(Example) P lights when video output mode is in progressive mode.
- 13** Group/Title Number Display
- 14** Track/Chapter Number Display
- 15** Remaining Time/Elapsed Time Indicator ⇨ pg. 23, 37
Lights when remaining time of DVD-RAM, DVD-R and DVD-RW discs is displayed, and lights out when elapsed time is displayed. The right 6 digits of the Multi Display (16) indicate elapsed or remaining time of each track.
No display: Indicates elapsed time of the disc.
Displayed: Indicates remaining time of the disc.
- 16** Remaining Time/Elapsed Time Display ⇨ pg. 23, 37
- 17** Multi Display
Displays clock, elapsed time and remaining time. Also displays status of the unit (NO DISC/OPEN/CLOSE/READING).

On-Screen Display (DVD deck)

When "SUPERIMPOSE" is set to "AUTO" and **ON SCREEN** on the remote control is pressed, various operational indicators appear on the TV screen. To clear the operational indicators, press **ON SCREEN** twice.

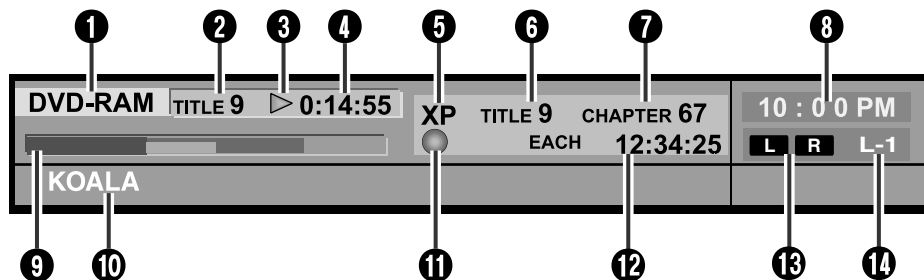

1 Disc Display

Displays the type of the disc loaded on the disc tray.

2 Title Number*

Displays number of the title currently being played back.

3 Playback Operation Status Indicator*

Indicates playback operation status by pictographs.

4 Playback Time*

Displays playback time of the title currently being played back.

5 Recording Mode

Displays recording mode as XP, SP, LP, EP, FR60–FR360, FR420 and FR480. Current recording mode is displayed during recording, and recording mode in which the program was recorded is displayed during playback. The recording mode is not displayed during play list playback.

6 Title Number

Displays playback title number during playback, and recording title number during recording.

7 Chapter Number

Displays playback chapter number during playback, and recording chapter number during recording.

8 Clock Display

9 Bar Meter Display [☞](#) pg. 26

Displays playback point and other information in bar meter.

10 Title Name Display

Displays title name newly registered to the title recorded on DVD-RAM/RW/R discs, or file name of JPEG and MP3 files.

11 Operation Status Indicator

Indicates operation status by pictographs. (Also indicates its speed for forward high-speed search, reverse high-speed search and slow motion.)

12 Time Display

Displays single title playback elapsed time, single track playback elapsed time, single track remaining time, total elapsed time, total remaining time, and other information in turn.

13 Audio Mode Display

Displays audio that is being input.

14 Auxiliary Input Indicator (L-1 or F-1)

Displays currently selected input.

* During Live Memory playback, playback operation status is displayed. During normal playback, the multichannel encoding method is displayed.

On-Screen Display (VCR deck)

When "SUPERIMPOSE" is set to "ON" or "AUTO" and **ON SCREEN** on the remote control is pressed, various operational indicators appear on the TV screen. To clear the operational indicators, press **ON SCREEN** again.

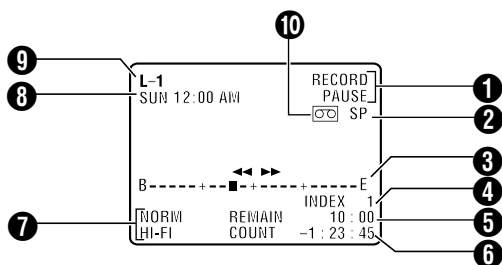

1 Operation Mode Indicators

2 Recording Mode (SP/EP)

3 Tape Position Indicator

The tape position indicator appears on the TV screen when you press ◀ or ▶ from the Stop mode or perform an Index Search. ([☞](#) pg. 34) The position of "■" in relation to "B" (Beginning) or "E" (End) shows you where you are on the tape.

NOTE:

Depending on the type of tape being used, the tape position indicator may not appear correctly.

4 Index number [☞](#) pg. 34

5 Tape Remaining Time Indicator [☞](#) pg. 38

6 Counter Display

7 Audio Mode Display [☞](#) pg. 35

8 Day/Clock Display

9 Auxiliary Input Indicator (L-1 or F-1)

10 "Cassette Loaded" Mark

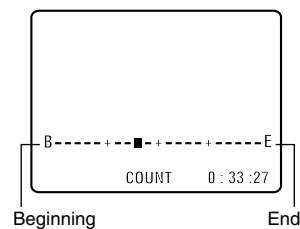

Remote Control

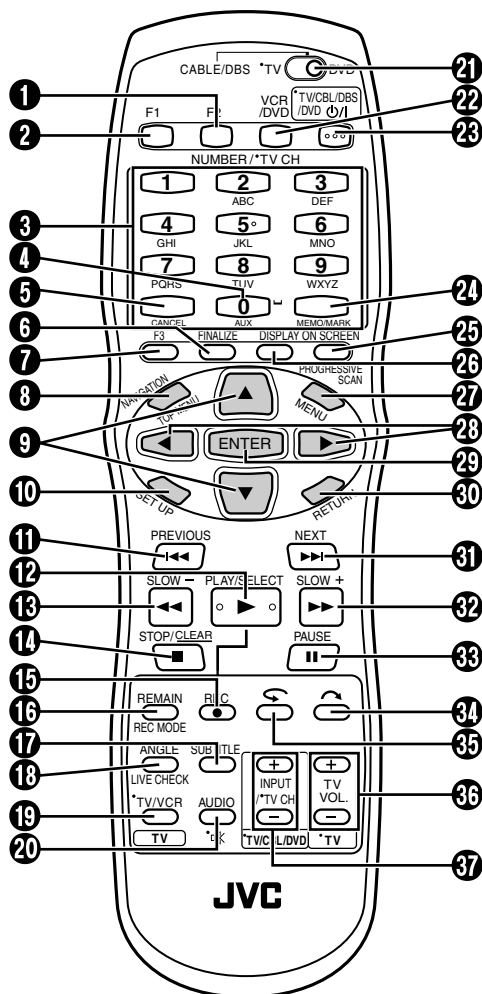

- 18 Reverse Search Button (◀◀) pg. 21, 27, 34
- Rewind Button (◀◀) (VCR deck) pg. 33
- Reverse Slow Button (SLOW -) pg. 22
- 14 Stop Button (■) pg. 20, 33
- Clear Button (CLEAR) (DVD deck only) pg. 30
- 15 Record Button (●) pg. 36
- 16 Remain Button (REMAIN) pg. 23, 37
- Recording Mode Button (REC MODE) pg. 36
- 17 Subtitle Button (SUBTITLE) (DVD deck only) pg. 23
- 18 Angle Button (ANGLE) (DVD deck only) pg. 23
- Live Check Button (LIVE CHECK) pg. 25, 27
- 19 TV/VCR Button pg. 55
- 20 Audio Button (AUDIO) pg. 23, 35
- TV Muting Button (🔇) pg. 55
- 21 TV/CABLE/DBS/DVD switch pg. 17, 55, 56
- 22 VCR/DVD Button pg. 17
- 23 TV/CBL/DBS/DVD Standby/On Button (⏻) (⏻)
- 24 Memo Button (MEMO) (DVD deck only) pg. 40, 43, 45
- Mark Button (MARK) (DVD deck only) pg. 22
- 25 On-Screen Button (ON SCREEN) pg. 14, 28
- Progressive Scan Button (PROGRESSIVE SCAN) pg. 65
- 26 Display Button (DISPLAY) pg. 23, 37
- 27 Menu Button (MENU) (DVD deck only) pg. 21
- 28 ◀ ▶ Button pg. 17
- 29 Enter Button (ENTER) pg. 17
- 30 Return Button (RETURN) pg. 24
- 31 Forward Skip Button (▶▶) (DVD deck) pg. 21, 27
- Index Button (▶▶) (VCR deck) pg. 34
- Next Button (NEXT) (DVD deck only) pg. 24
- 32 Next Search Button (▶▶) pg. 21, 27, 34
- Fast Forward Button (▶▶) (VCR deck) pg. 33
- Forward Slow Button (SLOW +) pg. 22
- 33 Pause Button (⏸) pg. 20, 34
- 34 Skip Search Button (↶) pg. 22, 27
- 35 Instant Replay Button (↶) pg. 27, 34
- 36 TV Volume Button (TV VOL.) pg. 55
- 37 TV/CBL DVD Channel Button (INPUT/TV CH +/-) pg. 36, 55

The glow-in-the-dark buttons shown in grey on the illustration above are helpful when using the remote control in darkened rooms.

Buttons with a small dot on the left side of the name can also be used to operate your TV. (pg. 55)

- 1 F2 Button: Not use on this unit.
- 2 F1 Button pg. 65
- 3 Number Keys pg. 24
- Character Keys (DVD deck only) pg. 41
- 4 Auxiliary Button (AUX) pg. 53
- 5 Cancel Button (CANCEL) pg. 30
- 6 Finalize Button (FINALIZE) pg. 63, 64
- 7 F3 Button: Not use on this unit.
- 8 Top Menu Button (TOP MENU) (DVD deck only) pg. 21
- Navigation Button (NAVIGATION) (DVD deck only) pg. 39
- 9 ◀ ▶ Button pg. 17
- 10 Set Up Button (SET UP) pg. 17
- 11 Reverse Skip Button (◀◀) (DVD deck) pg. 21, 27
- Index Button (◀◀) (VCR deck) pg. 34
- Previous Button (PREVIOUS) (DVD deck only) pg. 24
- 12 Play Button (▶) pg. 20, 33
- Select Button (SELECT) (DVD deck only) pg. 20, 40

How To Use

Before use, insert two AA size batteries into the remote control with the polarity (+) and (-) matched correctly as indicated on the battery compartment or on the lid.

The remote control can operate most of your unit's functions, as well as basic functions of TV sets of JVC and other brands. (pg. 55)

- Point the remote control toward the receiving window.
- The maximum operating distance of the remote control is about 8 m.

NOTE:

If the remote control doesn't work properly, remove its batteries, wait a short time, replace the batteries and then try again.

Basic Connection

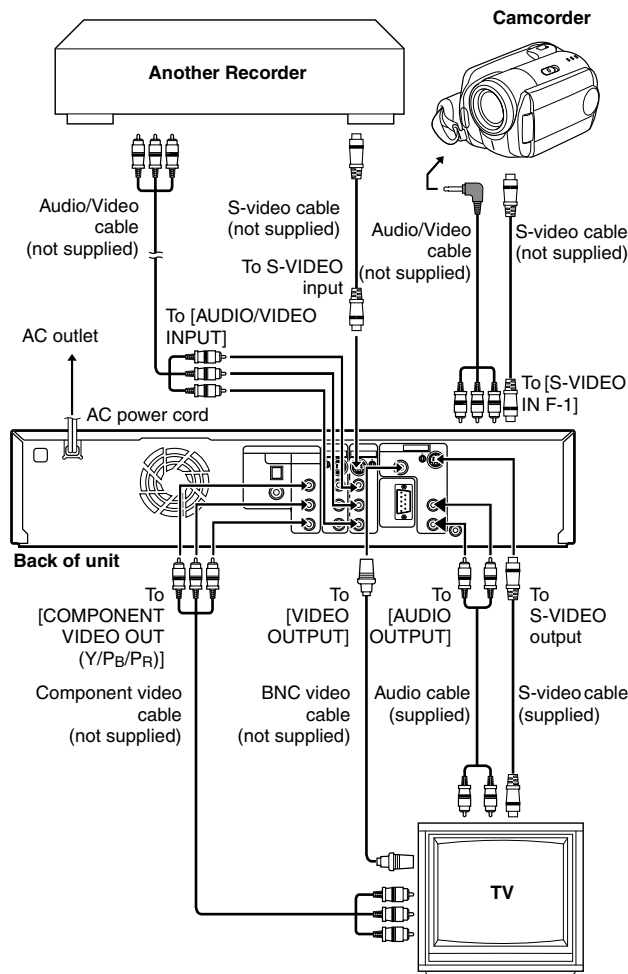

It's essential that your unit be properly connected.

ATTENTION:

Connect the AC plug only after all connections to the TV has been completed.

- Make sure the package contains all of the accessories listed in "SPECIFICATIONS" on page 86.
- Place the unit on a stable, horizontal surface.

THESE STEPS MUST BE COMPLETED BEFORE ANY VIDEO OPERATION CAN BE PERFORMED.

Connecting to a TV Monitor

Connect the unit to a TV depending on the TV and cables you use.

■ AV Connection

To connect to a TV with BNC connector —

- 1 Connect an optional audio cable between the [AUDIO OUTPUT] connectors on the rear panel of the unit and the TV's audio input connectors.
- 2 Connect an optional BNC video cable between the unit's BNC [VIDEO OUTPUT] connector and the TV's BNC VIDEO input connector.

■ S-Video Connection

To connect to TV's S-VIDEO input and AUDIO input connectors —

- 1 Connect the unit's S-VIDEO output connector to the TV's S-VIDEO input connector.
- 2 Connect the unit's [AUDIO OUTPUT] connectors to the TV's AUDIO input connectors.

- You can obtain high-quality S-VHS pictures.
- If your TV is not stereo-capable, use the unit's [AUDIO OUTPUT] connectors to connect to an audio amplifier for Hi-Fi stereo sound reproduction.

■ Component Video Connection (DVD deck only)

To connect to TV's component video input connectors —

- 1 Connect the unit's [COMPONENT VIDEO OUT (Y/Pb/Pr)] connectors to the TV's component video input connectors.
 - 2 Connect the unit's [AUDIO OUTPUT] connectors to the TV's AUDIO input connectors.
- You can obtain high-quality component video pictures.
 - If your TV is not stereo-capable, use the unit's [AUDIO OUTPUT] connectors to connect to an audio amplifier for Hi-Fi stereo sound reproduction.
 - By using the component video connection, you can view the images in the progressive mode. For switching to the progressive mode, refer to "Scan Mode Set" (☞ pg. 65).
 - You can also watch the images on the VCR deck in Progressive scan mode via the component video output, refer to "VHS Progressive Scan" (☞ pg. 35).

Connecting to a Camcorder

■ AV Connection

- 1 Connect the unit's [VIDEO/AUDIO (L/R) IN F-1] connectors on the front panel to the camcorder's AV connector.
- Set "FRONT AUX F-1" to "VIDEO". (☞ pg. 59)

■ S-Video Connection

- 1 Connect the unit's [S-VIDEO IN F-1] connector on the front panel to the camcorder's s-video output connector.
- 2 Connect the unit's [AUDIO IN F-1] connectors on the front panel to the camcorder's AV connector.
- Set "FRONT AUX F-1" to "S-VIDEO". (☞ pg. 59)

To connect to a DV camcorder, refer to "DV Dubbing (DVD Deck Only)" (☞ pg. 51).

Connecting to Another Recorder

- 1 Connect the unit's [S-VIDEO INPUT] or [VIDEO INPUT] connector to another recorder's s-video or video output connector.
- 2 Connect the unit's [AUDIO INPUT] connectors to another recorder's audio output connectors.

Plug the end of the AC power cord into an AC outlet.

- "LOADING" blinks on the front display panel when the AC plug of the AC power cord is connected into an AC outlet. It takes approximately 50 seconds for the unit to be turned on. This is not a malfunction.

Clock Set

- Turn on the unit.
- Turn on the TV and select the AV mode.
- Slide the TV/CABLE/DBS/DVD switch to DVD.

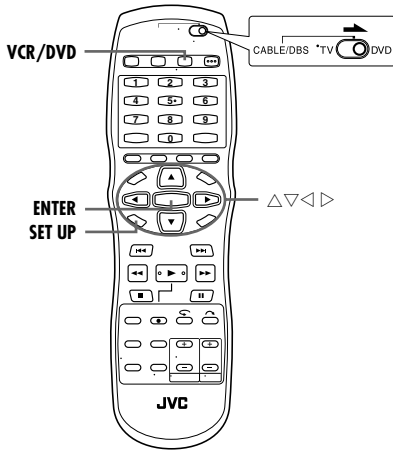

1 Press **VCR/DVD** repeatedly so that the DVD lamp lights up on the unit.

2 Press **SET UP** to access the Main Menu screen.

3 Press $\triangleleft \triangleright$ to select "INITIAL SET UP", then press **ENTER**.

4 Press $\triangle \nabla$ to select "TIME", then press **ENTER**. Press $\triangle \nabla$ until the desired time appears, then press **ENTER** to start clock.

- Set the date and year in the same way.

- Holding $\triangle \nabla$ changes the time in 30-minute intervals, or changes the date in 15-day intervals.

5 Press $\triangle \nabla$ to select "D.S.T.", then press **ENTER**. Press $\triangle \nabla$ to select the desired setting, then press **ENTER**.

ON: Adjustment will be made by the built-in clock itself.

OFF: Select when Daylight Saving Time does not apply to you.

6 Press **SET UP** to complete the setting.

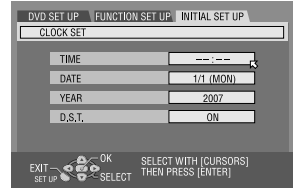

Daylight Saving Time

This function enables automatic adjustment of the unit's clock at the start and end of Daylight Saving Time.

With D.S.T activated, —

— on the second Sunday of March at 2:00 AM, the clock is adjusted to 3:00 AM.

— on the first Sunday of November at 2:00 AM, the clock is adjusted to 1:00 AM.

Language

- Turn on the unit.
- Turn on the TV and select the AV mode.
- Slide the **TV/CABLE/DBS/DVD** switch to **DVD**.

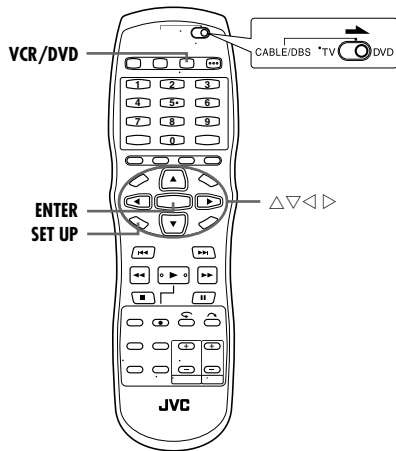

On-screen Language Set

This unit offers you the choice to view on-screen messages in 3 different languages.

- 1 Press **VCR/DVD** repeatedly so that the DVD lamp lights up on the unit.
- 2 Press **SET UP** to access the Main Menu screen.
- 3 Press $\triangleleft \triangleright$ to select "FUNCTION SET UP", then press **ENTER**.
- 4 Press $\triangleleft \triangleright$ to select "DISPLAY SET", then press **ENTER**.
- 5 Press $\triangle \nabla$ to select "ON SCREEN LANGUAGE", then press **ENTER**.
- 6 Press $\triangle \nabla$ to select your desired language, then press **ENTER**.
- 7 Press **SET UP** to complete the setting.

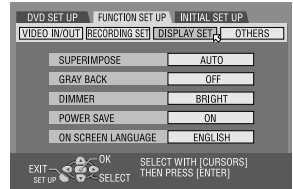

Menu/Audio/Subtitle Language Set (DVD deck only)

Some DVD discs contain the DVD menu display, audio and subtitles in multiple languages. With these discs, you can set the default language as you like.

- The procedure shows how to set "MENU LANGUAGE" as an example.

- 1 Press **VCR/DVD** repeatedly so that the DVD lamp lights up on the unit.
- 2 Press **SET UP** to access the Main Menu screen.
- 3 Press $\triangleleft \triangleright$ to select "DVD SET UP", then press **ENTER**.
- 4 Press $\triangleleft \triangleright$ to select "LANGUAGE SET", then press **ENTER**.
- 5 Press $\triangle \nabla$ to select "MENU LANGUAGE", then press **ENTER**.
- 6 Press $\triangle \nabla$ to select your desired language, then press **ENTER**.
 - See "Language Code List" (pg. 70).
- 7 Press **SET UP** to complete the setting.

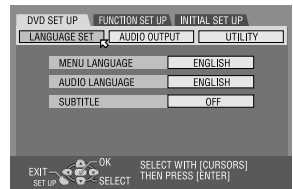

NOTE:

When the selected language is not available on the disc, the disc's default menu language is played back.

Monitor Set (DVD Deck Only)

You can select the monitor type depending on the TV used when you play back DVD VIDEO discs recorded for wide-screen TVs.

- Turn on the unit.
- Turn on the TV and select the AV mode.
- Slide the **TV/CABLE/DBS/DVD** switch to **DVD**.

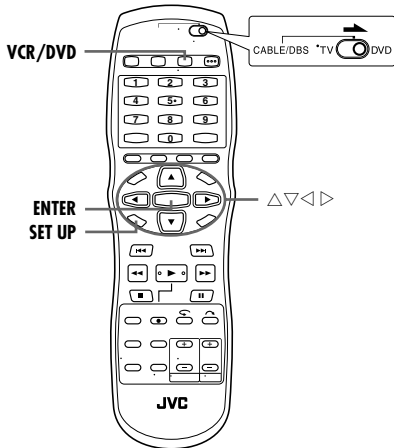

- 1 Press **VCR/DVD** repeatedly so that the DVD lamp lights up on the unit.
- 2 Press **SET UP** to access the Main Menu screen.
- 3 Press **◀▶** to select "FUNCTION SET UP", then press **ENTER**.
- 4 Press **◀▶** to select "VIDEO IN/OUT", then press **ENTER**.
- 5 Press **△▽** to select "MONITOR TYPE", then press **ENTER**.
- 6 Press **△▽** to select the desired option, then press **ENTER**.
- 7 Press **SET UP** to complete the setting.

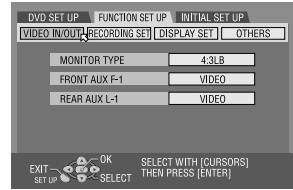

* The **boldface** settings below indicate the settings at your purchase.

■ MONITOR TYPE — **4:3LB** / 4:3PS / 16:9AUTO / 16:9FIX

4:3LB (Letter Box conversion):

Select this when the aspect ratio of your TV is 4:3 (conventional TV). While viewing a wide screen picture, the black bars appear on the top and the bottom of the screen.

4:3PS (Pan&Scan):

Select this when the aspect ratio of your TV is 4:3 (conventional TV). While viewing a wide screen picture, the black bars do not appear; however, the left and right edges of the pictures will not be shown on the screen.

16:9AUTO (Wide television conversion):

Select this when the aspect ratio of your TV is 16:9 (wide TV).

16:9FIX (Wide television conversion):

Select this when the aspect ratio of your TV is fixed to 16:9 (wide TV). The unit automatically adjusts the screen width of the output signal correctly when playing back a picture whose aspect ratio is 4:3.

Pan&Scan/Letter Box

In general, DVD VIDEO disc are produced for a wide-screen TV with 16:9 aspect ratio.

Material with this ratio will not fit to a TV with 4:3 aspect ratio.

There are two styles to display the image, "Pan&Scan" (PS) and "Letter Box" (LB).

Pan&Scan

The right and left side of the image are cut off. The image fills the screen.

- The picture will be shown in the "4:3LB" mode depending on the disc even if the "4:3PS" mode is selected.



Letter Box

Black bands appear at the top and bottom of the image. The image itself appears in 16:9 aspect ratio.



Basic Playback



- Turn on the unit.
- Turn on the TV and select the AV mode.
- Slide the TV/CABLE/DBS/DVD switch to DVD.

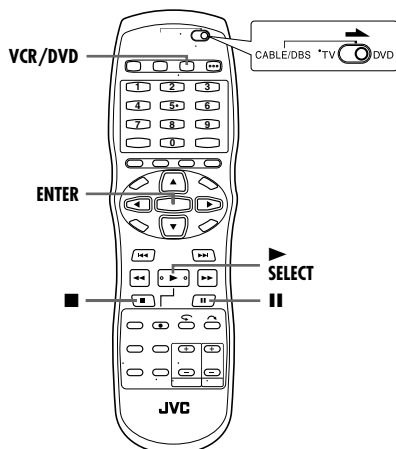
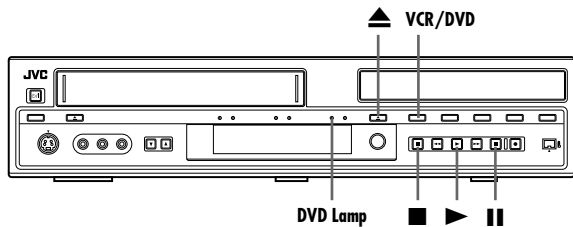

ATTENTION:

- It takes approximately 30 seconds to read a disc depending on the type and condition of the disc since this unit is multi-disc compatible (DVD-RAM, DVD-RW, DVD-R). It may even take several minutes when a disc is dirty, scratched or warped.
- It may take a few seconds to start playback. This is not a malfunction.
- Forward/reverse high-speed search and other operations cannot be performed while playback is stopped.

To play back an MP3/JPEG disc, see "Playback With MP3/JPEG Navigation" (pg. 45).

1 Load a disc.

- For details, refer to "Placing A Disc" (pg. 10).
- Playback begins automatically if an auto-playback DVD disc is loaded.
- Pressing ► also closes the disc tray, and playback begins automatically.

2 Press VCR/DVD repeatedly so that the DVD lamp lights up on the unit.

3 Press ► to start playback.

- If you load a DVD disc whose region code does not match the unit, "REGION CODE ERROR CHECK DISC" appears on the TV screen. For details, refer to "Region Number" (pg. 8).
- If "CAN NOT PLAY BACK DISC UNDER CURRENT SETTING" appears on the TV screen, refer to "Parental Lock" (pg. 32).
- With Video CD discs with PBC control or some DVD discs, the menu display may appear on the TV screen after starting playback. In this case, select an item which you want to play back from the menu. Otherwise, the playback cannot go forward. Refer to "Playback Control (PBC) Function" (pg. 24) or "Locating A Desired Scene Using The DVD Menu" (pg. 21).
- The Library Database DVD Navi also enables you to search and select the desired programs. (pg. 70)

4 Press II to pause playback.

- To resume normal playback, press ►.

5 Press ■ to stop playback.

- When a recordable disc is played, playback stops and AV input (from external AV source) resumes on the TV screen.
- When a playback-only disc is played, playback stops and the still image at the time you press ■ remains on the TV screen. Pressing ■ again resumes the AV input (from external AV source).
- If ▲ (EJECT) is pressed during playback, playback stops, then the disc tray opens.

NOTE:

When the Library Database DVD Navi screen appears, choose a thumbnail image of the desired program on the TV screen, then press SELECT(►). (pg. 40)

Playback Features

- Turn on the unit.
- Turn on the TV and select the AV mode.
- Slide the **TV/CABLE/DBS/DVD** switch to **DVD**.
- Press **VCR/DVD** repeatedly so that the DVD lamp lights up on the unit.

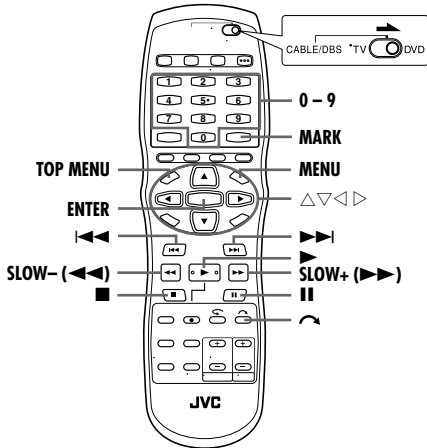

Locating The Start Point Of The Item Or Skip The Item



Press **◀◀** or **▶▶** during playback.

- Pressing **▶▶** locates the start point of the item or skips the item for forward direction, then resumes playback.
- Pressing **◀◀** locates the start point of the item or skips the item for reverse direction, then resumes playback.

When a DVD-RAM/RW/R disc is played

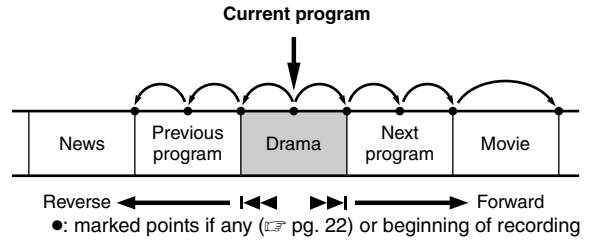

Example:

- To locate the beginning of the next item, press **▶▶** once.
- To locate the beginning of the current item, press **◀◀** once.
- To locate the beginning of the previous item, press **◀◀◀** three times.

When a DVD VIDEO, Audio CD or Video CD disc is played

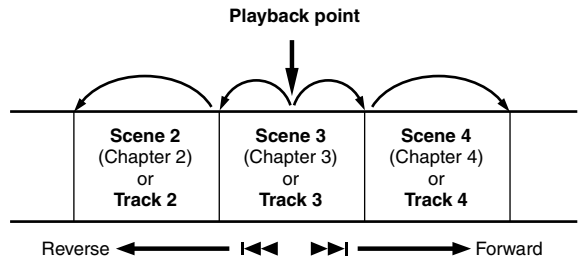

Example:

- To locate the beginning of the next item, press **▶▶** once.
- To locate the beginning of the current item, press **◀◀** once.

Locating A Desired Scene Using The DVD Menu



DVD VIDEO discs may have top menu and disc menu.

Top menu

DVD discs generally have their own menus which show the disc contents. These menus contain various items such as titles of a movie, names of songs, or artist information. You can locate a desired scene by using the top menu displayed on the TV screen. Press **TOP MENU** to access the top menu.

Disc menu

Disc menus include playback data (angle menu, subtitle menu, etc.) specific to each title. Press **MENU** to access the disc menu.

1 Press **TOP MENU** or **MENU** to access the DVD menu.

Example:

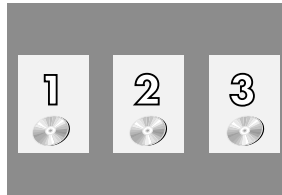

2 Press **△▽◀▶** to select a desired title, then press **ENTER**. Playback starts.

- It may be possible to select the desired item using the **number keys** depending on the menu display.

NOTE:

When "O" appears on the TV screen in step 1, the disc does not have a top menu or disc menu.

Variable Speed Search



During playback, press **▶▶▶** for forward variable speed search, or **◀◀◀** for reverse variable speed search.

- Each press of the button increases the search speed for each direction.
- To resume normal playback, press **▶**.

OR

During playback, press and hold **▶▶▶** for 2 or more seconds for forward search at 5x speed, or press and hold **◀◀◀** for 2 or more seconds for reverse search at -5x speed.

- Releasing the button resumes normal playback.

For Audio CD

You can perform 4 levels of speed search with **▶▶▶** and **◀◀◀**. (Audio is active also during variable speed search.) You cannot perform slow motion for each direction.

Reverse ◀◀												▶▶ Forward											
Reverse Search 4 steps				Reverse Play		Reverse Slow Motion 3 steps				Slow Motion 3 steps			Normal Play		Forward Search 4 steps								
-60	-15	-5	-3	-1	-1/2	-1/4	-1/16	1/16	1/4	1/2	1	3	5	15	60								

NOTE:

For slow motion speed search, refer to "Slow Motion" (pg. 22).

Still Picture/Frame-By-Frame Playback



- 1 Press **II** to pause during playback.
- 2 Press **II** or **<|>** to activate frame-by-frame playback.
 - Each press of **II** advances the still picture frame by frame.
 - Each press of **<|>** advances/reverses the still picture frame by frame.
 - Frame-by-frame playback for reverse direction cannot be performed with Video CD discs.
 - To resume normal playback, press **▶**.

Slow Motion



- 1 Press **II** to pause during playback.
- 2 Press **SLOW -** (**<<|**) or **SLOW +** (**|>>**).
 - Each press of **SLOW -** (**<<|**) or **SLOW +** (**|>>**) increases the slow motion speed for each direction (from 1/16 to 1/2 times the normal speed).
 - Slow motion for reverse direction cannot be performed with Video CD discs.

Skip Search



- During playback, press **↶**.
- Each press initiates an approximately 30-second period of fast-motion playback. Normal playback resumes automatically.
 - Skip search cannot be performed when a Video CD disc is being played back with the PBC function.

Resume Function



It is possible to memorize the position where you stop playback and resume playback from that position.

- Be sure to set "RESUME" to "ON" or "DISC RESUME". (☞ pg. 59)
- 1 Press **■** during playback to memorize a resume point.
 - The unit enters Resume Stop mode and memorize the position where you have stopped playback as a resume point. (The inside of the disc status indicator on the front display panel blinks while memorizing.)
 - The unit retains a memory of the resume points of the last 30 discs played back, even though they have been ejected if "RESUME" is set to "DISC RESUME". (☞ pg. 59)
 - Performing the following steps would erase the resume points: (The inside of the disc status indicator stops blinking and lights.)

When "RESUME" is set to "ON":

- Press **⏻** to turn off the unit.
- Press **▲ (OPEN/CLOSE)** to take out the disc.
- Press **■** in stop mode.
- Press **TOP MENU** to display the top menu, then start playback by selecting an item, etc.
- Press **MENU** to display the disc menu, then start playback by selecting an item, etc.

When "RESUME" is set to "DISC RESUME":

- Set "RESUME" to "OFF". (☞ pg. 59)
- Press **■** in stop mode.
- Press **TOP MENU** to display the top menu, then start playback by selecting an item, etc.
- Press **MENU** to display the disc menu, then start playback by selecting an item, etc.

- 2 Press **▶** in stop mode to resume playback. The unit starts playback from the resume point.

NOTES:

- "DISC RESUME" setting works on DVD VIDEO, VCD and already finalized DVD-R/DVD-RW (video mode) discs. For other types of discs, the function under "ON" setting will be applied even if "RESUME" is set to "DISC RESUME". (☞ pg. 59)
- If you stop the playback of a disc for which an resume point has already been memorized, the memory will be updated with the new resume point.
- After the unit has memorized the resume point for 30 discs, remembering a new resume point will cause the unit to delete the oldest memorized point. Stopping playback of a disc for which a resume point is already stored may change the order in which the points are stored. This may potentially change the order in which points are deleted.
- When the unit memorizes a resume point for a disc, it also remembers audio language, subtitle and angle settings.
- This function may not work for some Video CD.
- When "RESUME" is changed to "ON" or "OFF" (☞ pg. 59), resume points of the discs memorized with "RESUME" set to "DISC RESUME" will be cleared.
- Resume points are memorized for each side of a double-sided disc.

Marking Positions To Play Back Again Later



It is possible to mark positions (up to 999 points) where you want to play back once again later, and start playback from a marked position.

To mark positions:

During playback or recording, press **MARK** at positions you want to mark.

- "MARK" appears on the TV screen. You can easily locate the marked positions using **◀◀|** or **|▶▶** when you play back the disc.

To delete the marked positions:

While paused, press **◀◀|** or **|▶▶** to locate a marked position you want to delete, then press **MARK**.

- Crossed "MARK" appears on the TV screen, and the marked position is deleted.

NOTE:

When a DVD-R/RW (Video mode) disc is finalized, marked points marked before finalizing will be deleted, and programs will be divided automatically into "chapters" approximately every 5 minutes. (☞ pg. 63)

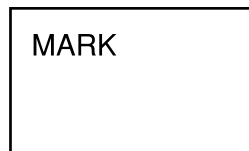

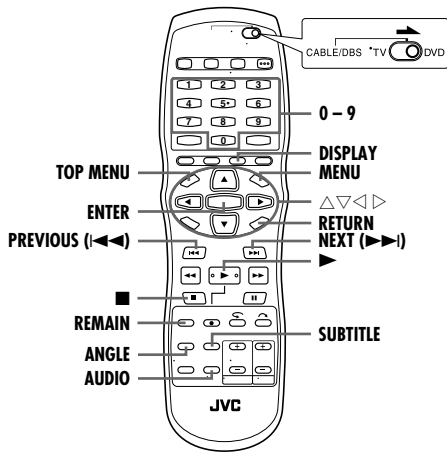

Checking The Time Information



You can check time information of a disc on the front display panel and the TV screen.

Press **DISPLAY** once to display the lastly displayed information. To change the display, press **DISPLAY** repeatedly.

■ DVD-RAM/DVD-R/DVD-RW

During playback or recording

Clock time (front display panel only) → Current title elapsed time → Disc remaining time* → (back to the beginning)

- * only discs before finalizing
- Clock time is displayed only when a recordable disc is recorded.

In stop mode

- It is possible to check disc remaining time according to recording modes also by pressing **REMAIN**.
- In FR mode, it is possible to set recording time in detail. While the recording mode and the disc remaining time are displayed by pressing **REMAIN**, press $\Delta \nabla$ to select "FR", then press $\triangleleft \triangleright$ to select the desired recording time. (☞ pg. 37)
- It is not possible to switch the recording mode during playback or while recording.

■ Video CD/Audio CD

During playback or in stop mode

Total remaining time → Current track elapsed time → Current track remaining time → Total elapsed time → (back to the beginning)

NOTE:

When a PBC-compatible Video CD disc is loaded, deactivate the PBC function. (☞ pg. 24)

Angle Selection



You can enjoy a variety of scene angles if a DVD VIDEO disc contains "multi-angle" parts, where the same scene was shot from different angles.

If the disc contains "multi-angle" parts, "ⓐ" appears on the TV screen at the beginning of the "multi-angle" part.

1 Press **ANGLE** during playback. The angle selection display appears on the TV screen.

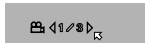

When 3 scene angles are contained.

2 Press **ANGLE** or $\triangleleft \triangleright$ to select your desired angle.

- Each time you press **ANGLE** or $\triangleleft \triangleright$, the angle changes.
- When "ⓐ" appears on the TV screen, the current scene is not recorded from multiple angles. In addition, some discs prohibit angle selection.

- To clear the angle selection display, press **ENTER**. In addition, the angle selection display disappears automatically if no operation is done for 10 seconds.

Subtitle Selection



Some DVD VIDEO discs contain more than one subtitle language, from among which you can choose the desired subtitle language. "Ⓜ" appears on the TV screen at the beginning of the part where more than one subtitle language are recorded.

1 Press **SUBTITLE** during playback. The subtitle selection display appears on the TV screen.



When 3 subtitle languages are contained.

- Each time you press **SUBTITLE**, the subtitle display is switched on and off.

2 Press $\triangleleft \triangleright$ to select your desired language.

- To clear the subtitle selection display, press **ENTER**.

NOTES:

- When "Ⓜ" appears on the TV screen, no subtitle language is recorded.
- When the subtitle language won't be changed with the procedure above, change the subtitle on a disc menu displayed by pressing **MENU**.

Audio Language/Sound Selection



Some DVD VIDEO discs contain the multiple audio language or sound. You can select the desired audio language or sound. For some Video CD discs, you can switch the audio channel to choose Karaoke either with or without the vocal.

1 Press **AUDIO** during playback. The Audio Language/Sound selection display appears.



When 3 audio languages are contained.

2 Press **AUDIO** or $\triangleleft \triangleright$ to select your desired audio language/sound.

- Each time you press **AUDIO** or $\triangleleft \triangleright$, the audio language/sound changes.
- To clear the Audio Language/Sound selection display, press **ENTER**.

NOTES:

- When "Ⓜ" appears on the TV screen, no other audio language is recorded.
- When the audio language won't be changed with the procedure above, change the audio on a disc menu displayed by pressing **MENU**.
- Pressing **AUDIO** to select the audio language/sound is only possible during playback. It is not possible to select by pressing **AUDIO** in stop mode. However, you can select the desired audio language/sound from the setup menu while in stop mode.

Audio Channel Selection



When playing discs on which you recorded stereo programs, you can choose the desired audio channel.

- When "SUPERIMPOSE" is set to "AUTO", you can confirm on the TV screen the audio channel you have chosen. (pg. 59)
- Each time you press **AUDIO**, the audio channel changes.



TRACK	USE
On-Screen Display	
	For stereo discs
	For audio of left channel
	For audio of right channel

Playback Control (PBC) Function



Some Video CD discs support the PBC function. PBC is an abbreviation of "Play Back Control". A Video CD disc recorded with PBC has its own menus, such as a list of the songs on the disc. You can locate a specific scene by using the menu.

- 1 Press **▶** in stop mode. The PBC menu appears.
- 2 Press the **number keys** to enter the number of the desired scene. The unit starts playback of the selected item.
 - "PBC" appears on the front display panel.
 - When "NEXT" or "PREVIOUS" appears on the TV screen:
 - Pressing **NEXT** (**▶▶**) advances to the next page.
 - Pressing **PREVIOUS** (**◀◀**) returns to the previous page.
 - You can return to the menu by pressing **RETURN**.
 - The method of the operation is different depending on the disc.

NOTES:

- If you want to playback a PBC-compatible Video CD disc without activating the PBC function, start playback in stop mode by using the **number keys**, instead of the **▶** button, to choose the track, then press **ENTER**.
- To activate the PBC function when a PBC-compatible Video CD disc is being played back without the PBC function, press **TOP MENU**, or press **■** then press **▶**.

Live Memory Playback



This unit records pictures onto DVD-RAM discs, instead of video tapes, then plays back the pictures recorded on the discs. This makes it possible to achieve high-speed writing and read-out that has not been possible with conventional VCRs, enabling recording and playback simultaneously.

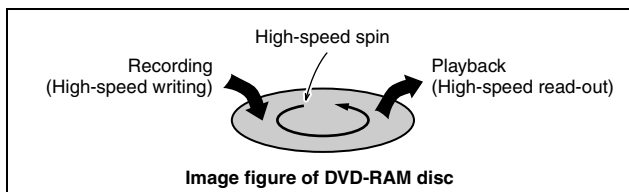

It is called "Live Memory Playback" to start playback of the program being recorded, with a time-lag between a recording point and a playback point, as shown in the figure below.

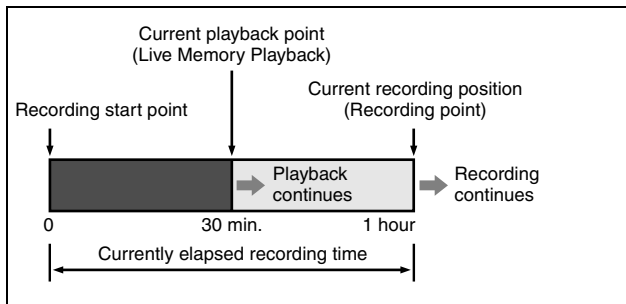

Not only can this unit play back a program previously recorded while recording another program, but the unit also allows you to play back from the beginning of a program while continuing to record the same program.

Recording/playback Status Display

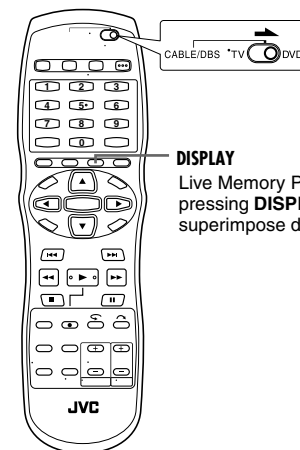

DISPLAY

Live Memory Playback status can be checked by pressing **DISPLAY** to display the bar meter on the superimpose display.

Press **DISPLAY**. The current status is superimposed on the TV screen.

Bar meter display

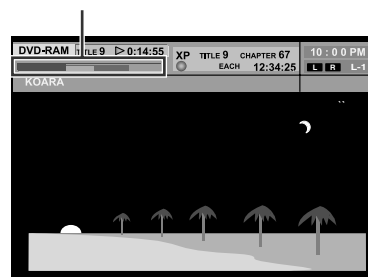

Superimpose display

Overview Of Live Memory Playback

You can play back a program you are recording from the beginning while continuing to record onto a DVD-RAM disc. This is called "Live Memory Playback".

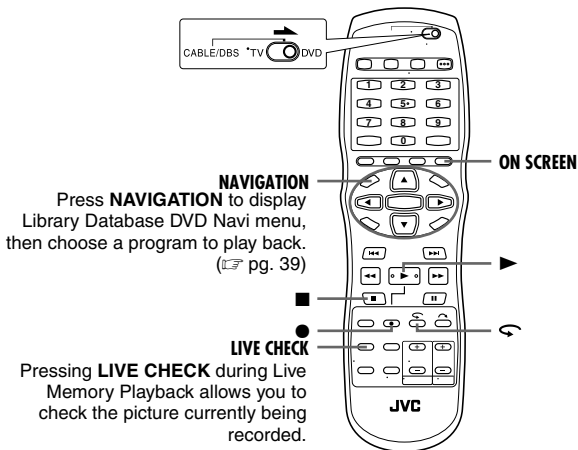
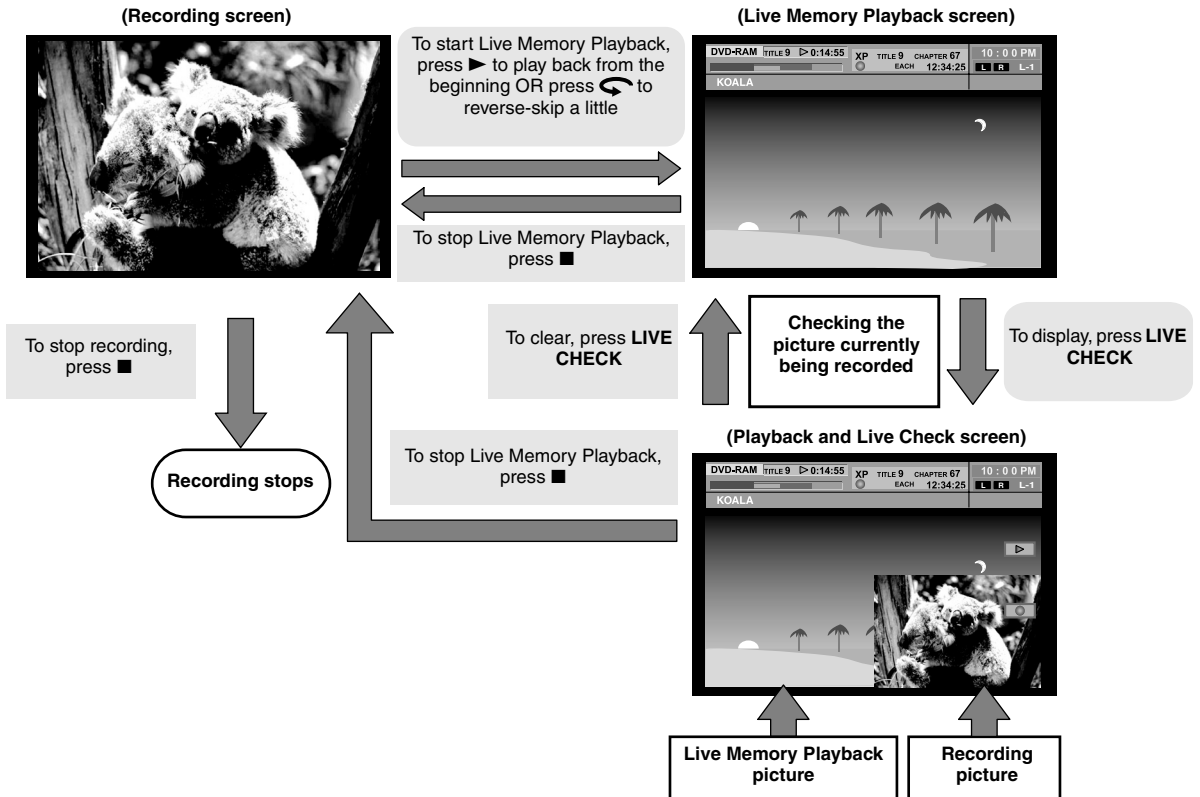

NOTES:

- Live Memory Playback could be performed approximately 30 seconds after recording has started.
- Although high-speed search up to approximately 30 seconds before the current recording point is possible during Live Memory Playback, once the current recording point is reached, the unit resumes normal playback and maintains a delay of approximately 30 seconds so that recording and playback can continue.
- Playback may be paused for a moment during Live Memory Playback, which does not interfere with recording.
- Live Memory Playback cannot be performed while recording the source from DV input.
- When **LIVE CHECK** is pressed to display the picture currently being recorded, the picture size may not be correct.

Display During Live Memory Playback

During recording, you can watch at your will what was previously recorded or is currently being recorded. It is possible to perform freely normal playback operations (forward/reverse high-speed search and variable-speed search) within the range of the red or blue bar on the TV screen.

When Live Memory Playback reaches the point of 30 seconds before the current recording point by forward high-speed search or other operations, the unit returns to normal playback.

The superimpose display appears by pressing **ON SCREEN**. (pg. 14)

The Live Check picture is displayed on the bottom right corner by pressing **LIVE CHECK**.

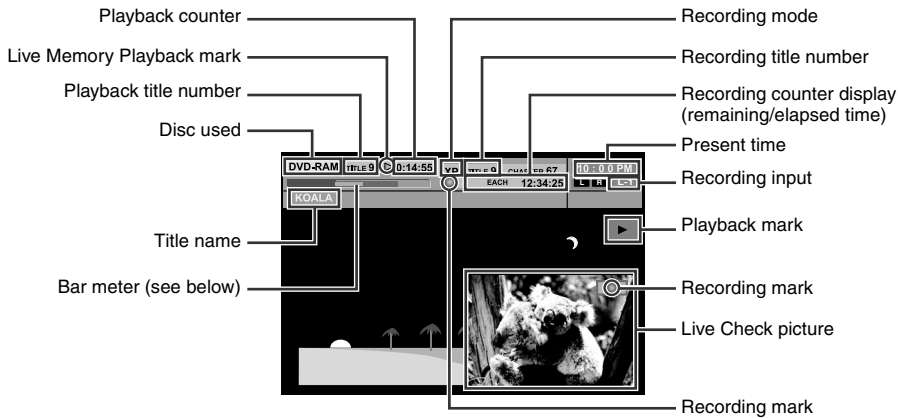

This unit displays the current recording/playback status by the bar meter.
(Example of bar meter display)

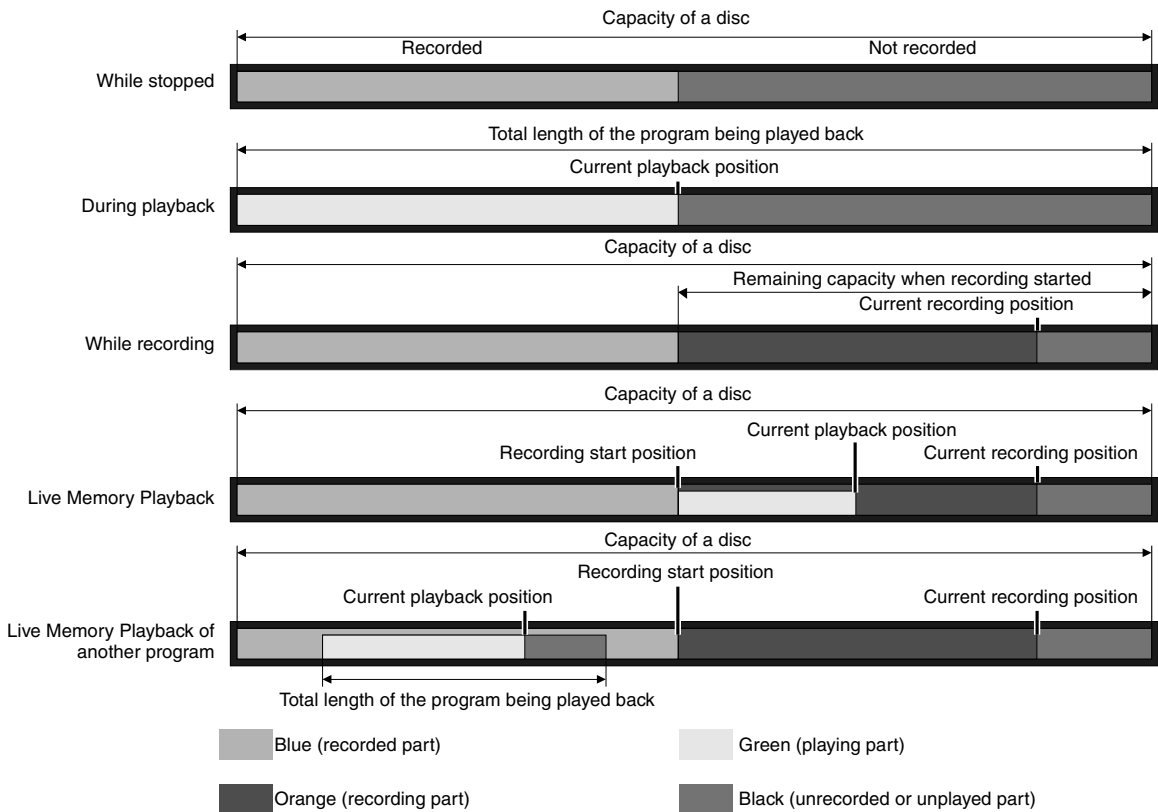

Buttons To Be Used During Live Memory Playback

- Turn on the unit.
- Turn on the TV and select the AV mode.
- Slide the TV/CABLE/DBS/DVD switch to DVD.

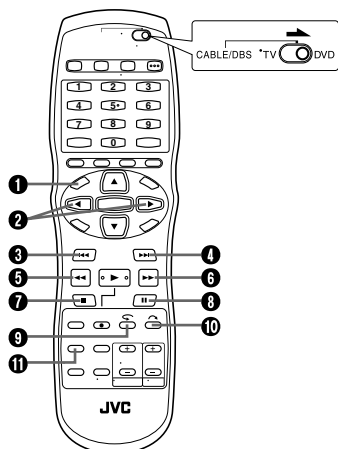

1 NAVIGATION

Displays Library Database DVD Navi menu. You can choose a program to play back.



Available only when paused

Advances/reverses the still picture frame by frame.



- Pressing once skips back to the beginning of the chapter being played back.
- Pressing down for 2 or more seconds during playback reverses playback at 5 times the normal speed while pressed. Releasing the button resumes normal playback.

Available only when paused

- Pressing down for 2 or more seconds reverses playback at 1/16 times the normal speed.



- Pressing once skips forward to the beginning of the next chapter being played back.
- Pressing down for 2 or more seconds during playback advances playback at 5 times the normal speed while pressed. Releasing the button resumes normal playback.

Available only when paused

- Pressing down for 2 or more seconds advances playback at 1/16 times the normal speed.



- Each press of the button during playback advances the playback speed in 5 steps for reverse direction.

Available only when paused

- Pressing once reverses playback by 1/16 times the normal speed.
- Each press of the button during reverse 1/16 times slow-motion reverses slow-motion by 1/16 times, 1/4 times and 1/2 times the normal speed.



- Each press of the button during playback advances the playback speed in 4 steps for forward direction.

Available only when paused

- Pressing once advances playback by 1/16 times the normal speed.
- Each press of the button during forward 1/16 times slow-motion advances slow-motion by 1/16 times, 1/4 times and 1/2 times the normal speed.



Stops Live Memory Playback to return to the screen being recorded.

Then a resume point is stored.

Pressing ■ again stops recording.

8 II

Pressing once pauses playback (still picture playback). Pressing repeatedly advances the still picture frame by frame.



It is useful when watching sports programs, etc.

- Pressing once skips back for approximately 7 seconds and resumes playback.
- Pressing repeatedly skips back continuously as many times as pressed.



It is useful when skipping over unwanted sections.

- Pressing once skips forward for approximately 30 seconds and resumes playback.
- Pressing repeatedly skips forward continuously as many times as pressed.

11 LIVE CHECK

You can check, for example, if the program you are recording has already finished.

- Pressing once displays the picture currently being recorded and the one being played back simultaneously.
- Pressing successively clears the Live Check window and displays only the picture currently being played back.

To Play Back From The Beginning Of The Program While Recording

You can play back a program you are recording from the beginning while continuing to record onto a DVD-RAM disc.

Press ►. Live Memory Playback starts from the beginning of the program being recorded.

- Pressing ◀◀ or ▶▶ allows you to locate the desired scenes.

Instant Replay

You can move back the playback position while continuing to record onto a DVD-RAM disc.

Press ↶.

- Each press skips back for approximately 7 seconds and resumes playback.
- Pressing while paused skips back for approximately 7 seconds and resumes pause.

To Watch A Program Previously Recorded While Recording

You can play back a program you recorded previously while recording.

1 Press ► during recording. Live Memory Playback starts.

2 Press ◀◀ or ▶▶ to locate the beginning of the desired program.

NOTE:

To stop playback, press ■. The program being recorded is displayed.

Using The On-screen Bar



The on-screen bar allows you to control various playback functions. Some of the functions operated on Navigation Menu can be controlled on the On-screen bar.

Be sure to clear Library Database DVD Navi screen by pressing **NAVIGATION**.

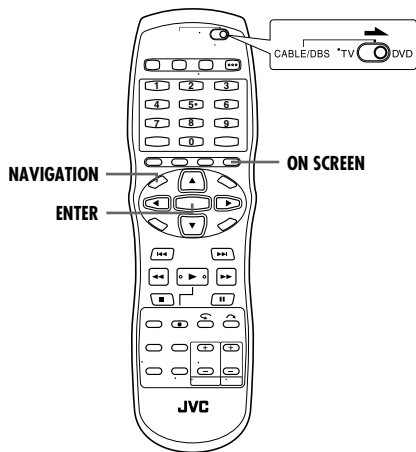

- 1 Disc type.
- 2 Select this for Repeat Playback. (↗ pg. 29)
- 3 Select this for A-B Repeat Playback. (↗ pg. 29)
- 4 Select this for search function. (↗ pg. 29)
- 5 Select this for time search function. (↗ pg. 30)
- 6 Select this to switch Simulated Surround Effect function. (↗ pg. 30)
- 7 Select this for Picture Control function. (↗ pg. 30)
- 8 Select this to switch picture source type. (↗ pg. 31)
- 9 Current status area for the selected item.
- 10 Select this for Program Playback. (↗ pg. 31)
- 11 Select this for Random Playback. (↗ pg. 31)
- 12 Select this to control the switching interval of the slide show. (↗ pg. 31)

NOTE:

Although examples of the on-screen bar are provided here only for 3 types of discs, the on-screen bar will be displayed for whichever disc indicated in the left column.

Basic Operation On The On-screen Bar

Example: When selecting Picture Control function of DVD

During playback or while stopped

1 Press **ON SCREEN** twice to access the on-screen bar. The item currently selected is highlighted and pointed by ↗.



2 Press ◀▶ to select "Picture Control", then press **ENTER**. The pop-up window appears under the selected item.



3 Press ◀▶ to select the desired option, then press **ENTER**.

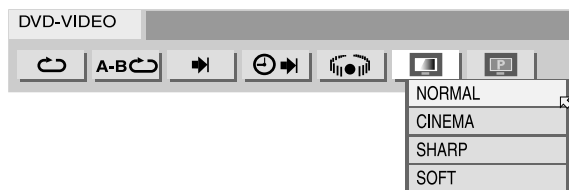

To clear the on-screen bar

Press **ON SCREEN**.

NOTE:

See the corresponding pages for details on each menu item.

How To Access The On-screen Bar

1 Press **ON SCREEN** whenever a disc is loaded.

Contents of the on-screen bar during playback

DVD VIDEO

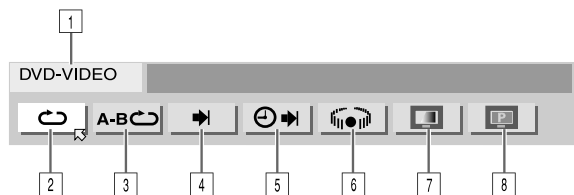

Video CD

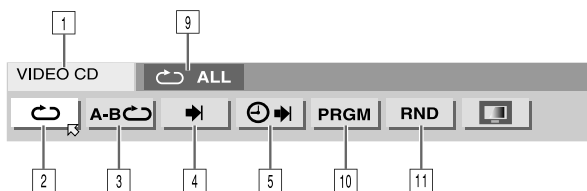

JPEG disc



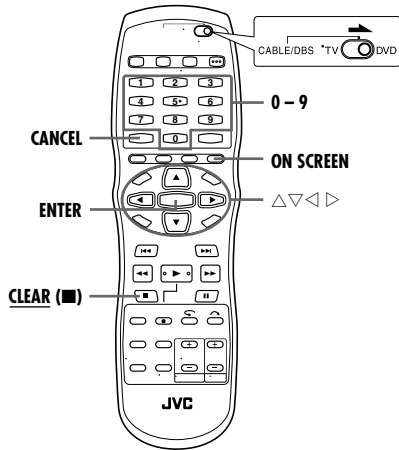

Repeat Playback



You can repeat playback as you like according to the type of disc.

- 1 Press **ON SCREEN** twice to access the on-screen bar.
- 2 Press $\triangleleft \triangleright$ to select "**A-B**", then press **ENTER**. The pop-up window appears under the selected item.



- 3 Press $\triangle \nabla$ repeatedly to select the desired Repeat mode, then press **ENTER**.

DVD-RAM/RW/R

OFF: Repeat playback is not performed.

ALL REPEAT: The whole disc is played back repeatedly.

TITLE REPEAT: The current title is played back repeatedly.

DVD VIDEO

OFF: Repeat playback is not performed.

TITLE REPEAT: The current title is played back repeatedly.

CHAPTER REPEAT: The current chapter is played back repeatedly.

Audio CD/Video CD/JPEG/MP3

OFF: Repeat playback is not performed.

ALL REPEAT: The whole disc is played back repeatedly.

TRACK REPEAT*: The current track is played back repeatedly.

* "TRACK REPEAT" cannot be selected for JPEG discs.

To clear the on-screen bar

Press **ON SCREEN**.

To cancel Repeat Playback

Repeat the above procedure from step 1, select "OFF" in step 3, then press **ENTER**.

NOTES:

- Repeat Playback is not possible for a Video CD with PBC function.
- Repeat Playback may not work properly depending on the type of the disc being used.

A-B Repeat Playback



You can repeat the desired part.

During playback

- 1 Press **ON SCREEN** twice to access the on-screen bar.
- 2 Press $\triangleleft \triangleright$ to select "**A-B**".
- 3 Press **ENTER** at the beginning of the desired part you want to repeat (point A). The elapsed playing time of the point A appears



- 4 Press **ENTER** at the end of the desired part you want to repeat (point B). The elapsed playing time of the point B appears.

- The selected part of the disc (between point A and B) is played repeatedly.



To clear the on-screen bar

Press **ON SCREEN**.

To cancel A-B Repeat Playback

Press $\triangleleft \triangleright$ to select "**A-B**", then press **ENTER**.

NOTES:

- A-B Repeat Playback may not work properly depending on the type of disc being used.
- The subtitles recorded around the A-B point may not appear.
- When the end of the item is reached before the end point is set, the on-screen bar disappears from the TV screen. In such a case, repeat the procedure from step 1.
- The point B must be set at least 3 seconds after the point A.
- When playing back a DVD, A-B Repeat Playback is possible only within the same title.
- "**A-B**" cannot be selected during Program and Random Playback.
- "**A-B**" cannot be selected while stopped.

Locating The Beginning Of A Desired Selection



You can locate the beginning of a title, chapter, group or track.

During playback or while stopped

- 1 Press **ON SCREEN** twice to access the on-screen bar.
 - 2 Press $\triangleleft \triangleright$ to select "**SEARCH**", then press **ENTER**.
 - 3 Press $\triangle \nabla$ to select the desired item, then press **ENTER**.
- Skip this step for Video CD and Audio CD.

For DVD-RAM/RW/R, DVD VIDEO

"TITLE SEARCH" or "CHAPTER SEARCH" is selectable. ("TITLE SEARCH" only is selectable while stopped.)

For JPEG, MP3

"GROUP SEARCH" or "TRACK SEARCH" is selectable.

For Video CD, Audio CD

"TRACK" is selectable.



NOTE:

Settings that are selectable during playback and stop mode differ depending on the type of disc or search used.

4 Press the **number keys** to enter the desired item number, then press **ENTER**.

- Playback starts from the selected section.

Examples:

- 1 To select track 5, press the **number key** "5".
- 2 To select track 15, press the **number key** "1" and "5".
- 3 To select track 25, press the **number key** "2" and "5".

If you have specified a wrong selection

Press **CANCEL** or **CLEAR** (■) to clear the wrong number, then enter the correct one before you press **ENTER** in this step.

To clear the on-screen bar

Press **ON SCREEN**.

NOTES:

- When "⊙" is displayed on the TV screen in step 4, the chapter you have selected is not contained in the disc, or chapter search does not work on the disc.
- Before you press **ENTER**, playback may start automatically when you enter the section's number depending on the disc.
- This function is not possible for a Video CD with PBC function.

Time Search



You can play back a disc from the desired point by specifying the elapsed playing time from the beginning of a title (DVD-RAM, DVD-R, DVD-RW and DVD VIDEO) or a disc (Video CD and Audio CD).

1 Press **ON SCREEN** twice to access the on-screen bar.

2 Press $\triangleleft \triangleright$ to select "⌚▶", then press **ENTER**. The pop-up window appears under the selected item.



3 Press the **number keys** to enter the time, then press **ENTER**. Playback starts from the specified time.

Example:

To play back from a point 12 (minutes): 50 (seconds) elapsed.

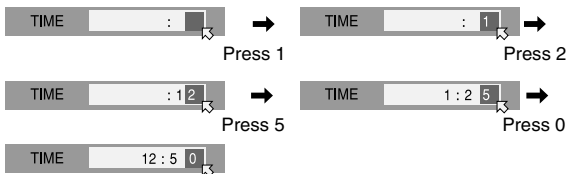

If you have specified a wrong selection,

Press **CANCEL** (for the last entered number) or **CLEAR** (■) (for whole numbers) to clear the wrong number, then enter the correct one(s) before you press **ENTER** in this step.

To clear the on-screen bar

Press **ON SCREEN**.

NOTES:

- When "⊙" is displayed on the TV screen in step 3, you have selected a point that exceeds the recording time of the disc.
- Some DVD VIDEO discs do not contain time information, and it is not possible to use the Time Search function. In such cases, "⊙" is displayed on the TV screen as well.
- This function is not possible for a Video CD with PBC function.

Simulated Surround Effect



It is possible to get a simulated surround effect from your stereo system. You can enjoy the virtual surround sound with your 2-channel stereo system.

1 Press **ON SCREEN** twice to access the on-screen bar.

2 Press $\triangleleft \triangleright$ to select "⌚▶", then press **ENTER**.

- "3D-ON" appears above the selected item and Simulated Surround Effect is activated.
- Each time you press **ENTER**, "3D-ON" appears and disappears alternately.



To clear the on-screen bar

Press **ON SCREEN**.

To cancel the simulated surround effect

Press **ENTER** to clear "3D-ON" from the screen.

NOTES:

- The simulated surround effect works correctly only when playing back a title recorded in multichannels.
- Simulated Surround Effect does not affect the DVD VIDEO bitstream signal from the [DIGITAL AUDIO OUTPUT] connector.
- When Simulated Surround Effect is activated, the settings of "ANALOG AUDIO OUT" and "D. RANGE CONTROL" are disabled. (☞ pg. 58)

Adjusting The Picture Quality



You can obtain optimal picture quality by selecting an appropriate picture mode.

1 Press **ON SCREEN** twice to access the on-screen bar.

2 Press $\triangleleft \triangleright$ to select "🖥️", then press **ENTER**. The pop-up window appears under the selected item.



3 Press $\triangle \nabla$ to select the desired option, then press **ENTER**.

NORMAL: Normally select this option.

CINEMA: Suitable for a movie disc, etc.

SHARP: Clearer, sharper-edged picture when viewing images with lots of flat, same-colored surfaces such as cartoons.

SOFT: Select this option when too much noise appears.

To clear the on-screen bar

Press **ON SCREEN**.

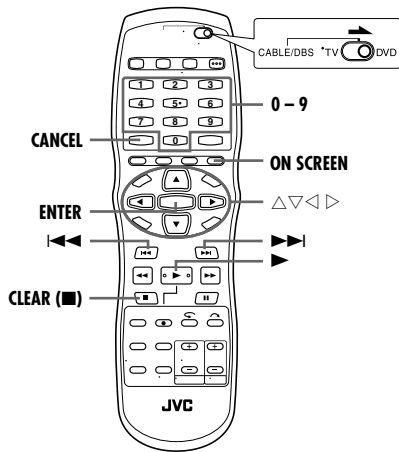

3 Press the **number keys** to enter the track numbers in the desired order.

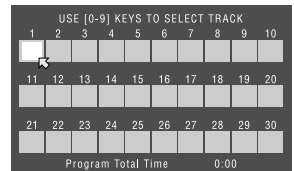

Examples:

- 1 To select track 5, press the **number key "5"** and **ENTER**.
- 2 To select track 15, press the **number key "1"** and **"5"**.
- 3 To select track 25, press the **number key "2"** and **"5"**.

If you have specified a wrong selection

Press **CANCEL**. The last selection is erased. Or press **CLEAR** (■). The whole selection is erased.

- 4** Press ►. Playback starts in the programmed order.
- When all of the programmed tracks have been played back, Program Playback stops, but the programmed information remains.
 - To add tracks to the end of the program, perform steps 1 through 3.
 - During Program Playback, pressing ►| skips to the next selection of the program. Pressing |◀ returns to the beginning of the current selection.

Setting The Progressive Mode



You can obtain optimal picture quality by selecting whether the content on the disc is processed by field (video source) or by frame (film source).

1 Set the unit to the progressive scan mode. Refer to "Scan Mode Set" (pg. 65).

2 Press **ON SCREEN** twice to access the on-screen bar.

3 Press ◀▶ to select "P", then press **ENTER**. The pop-up window appears under the selected item.



4 Press △▽ to select the desired option, then press **ENTER**.

AUTO 1: Used to play a disc containing both video and film source materials. This system recognizes the source type (video or film) of the current disc according to the disc information. Normally select this option.

AUTO 2: Almost the same as the "AUTO 1", but the processing of the scenes with movement is different. Select "AUTO 1" or "AUTO 2" to your preference.

FILM: Suitable for playing back a progressive scanned film source disc.

VIDEO: Suitable for playing back a video source disc. The outlines on the played back pictures will be soft.

To clear the on-screen bar
Press **ON SCREEN**.

Program Playback



You can program up to 30 tracks to play back in the desired order.

While stopped

1 Press **ON SCREEN** twice to access the on-screen bar.

2 Press ◀▶ to select "PRGM", then press **ENTER**. The program table appears under on-screen bar.



To clear the on-screen bar and the contents of the program
Press **ON SCREEN**.

To cancel Program Playback

Press ◀▶ to select "PRGM", then press **ENTER**.

NOTE:

Program Playback is not possible depending on the type of disc.

Random Playback



You can play back all the tracks on the disc in random order.

While stopped

1 Press **ON SCREEN** twice to access the on-screen bar.

2 Press ◀▶ to select "RND", then press **ENTER**. Playback starts in random order.



To clear the on-screen bar
Press **ON SCREEN**.

To cancel Random Playback

Perform steps 1 and 2.

NOTE:

The same track will not be played back more than once during Random Playback.

Select The Switching Interval Of The Slide Show



You can control the switching interval of the slide show.

1 Press **ON SCREEN** twice to access the on-screen bar.

2 Press ◀▶ to select "10 SEC.", then press **ENTER**. The pop-up window appears under the selected item.

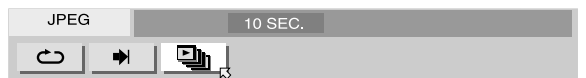

3 Press △▽ to select the desired option, then press **ENTER**.

- Each time you press △▽, the interval changes as follows:
5 SEC. ↔ 10 SEC. ↔ 15 SEC. ↔ 20 SEC. ↔ 25 SEC. ↔ 30 SEC. ↔ (Back to the beginning)

To clear the on-screen bar
Press **ON SCREEN**.

Parental Lock



This function restricts playback of DVD VIDEO discs which contain violent (and other) scenes according to the level set by the user. For example, if a movie which includes violent scenes supports the parental lock feature, such scenes which you do not want to let children view can be cut or replaced by other scenes.

- Turn on the unit.
- Turn on the TV and select the AV mode.
- Slide the TV/CABLE/DBS/DVD switch to DVD.

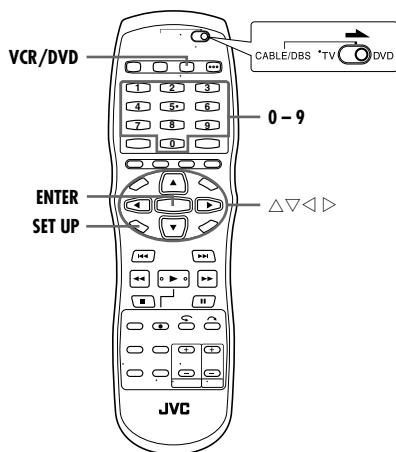

To Set Parental Lock For The First Time

While stopped

1 Press **VCR/DVD** repeatedly so that the DVD lamp lights up on the unit.

2 Press **SET UP** to access the Main Menu screen.

3 Press $\triangleleft \triangleright$ to select "DVD SET UP", then press **ENTER**.

4 Press $\triangleleft \triangleright$ to select "UTILITY", then press **ENTER**.

5 Press $\triangle \nabla$ to select "PARENTAL LOCK", then press **ENTER**.

6 Press $\triangle \nabla$ to select "PARENTAL LEVEL", then press **ENTER**.

7 Press $\triangle \nabla$ to select the desired level, then press **ENTER**.

- The smaller the value of level is, the more restrictive the Parental Lock level becomes.

- Select "NONE" to cancel the restriction.

8 Press the **number keys** to enter your desired four-digit number, then press **ENTER**.

- If you made a mistake, enter a correct number again.

9 Press $\triangle \nabla$ to select "COUNTRY CODE", then press **ENTER**.

10 Press $\triangle \nabla$ to select your country code, then press **ENTER**.

- If you do not need to change your country code, jump to **12**.
- See "Country/Area Code List for Parental Lock" (pg. 71)

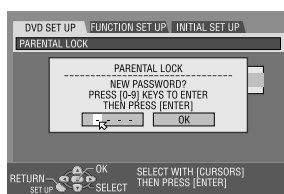
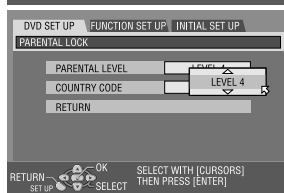
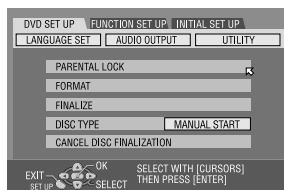

11 Press the **number keys** to enter the same password as in step **8** above, then press **ENTER**.

12 Press **SET UP** twice to complete the setting.

NOTE:

Remember your password, or make a note of it.

To Change The Settings

You can change the Parental lock settings later.

1 Perform steps **1** to **5** of "To Set Parental Lock For The First Time" to access the "PARENTAL LOCK" screen before continuing.

To change the level

2 Press $\triangle \nabla$ to select "PARENTAL LEVEL", then press **ENTER**.

3 Press $\triangle \nabla$ to select the desired level, then press **ENTER**.

To change the country code

4 Press $\triangle \nabla$ to select "COUNTRY CODE", then press **ENTER**.

5 Press $\triangle \nabla$ to select your country code, then press **ENTER**.

- See "Country/Area Code List for Parental Lock" (pg. 71).

6 Press the **number keys** to enter the same password as in step **8** of "To Set Parental Lock For The First Time", then press **ENTER**.

7 Press **SET UP** twice to complete the setting.

NOTE:

If you forget your password, enter "8888" in step **6**.

To Temporarily Release Parental Lock

When you set the parental lock level strictly, some discs may not be played back at all. When you insert such a disc and try to play it back, the confirmation screen appears on the TV screen, asking you whether you want Parental Lock to be temporarily released or not.

1 Load a disc.

- If the disc is rated higher than the selected level, the confirmation screen appears.

2 Press $\triangleleft \triangleright$ to select "YES", then press **ENTER**.

- If you select "NO", you cannot play back that disc.

3 Press the **number keys** to enter the same password as in step **8** of "To Set Parental Lock For The First Time", then press **ENTER**.

- When you enter the correct password, the Parental Lock is released and the unit starts playback.

- If you enter a wrong password, "ENTRY ERROR RETRY" appears on the TV screen. Enter the correct password.

- If you have successively entered wrong password three times, "ENTRY ERROR CAN NOT CHANGE PASSWORD" appears on the TV screen. In such a case, press **ENTER**. The disc will stop. Then play back the disc again, and try the procedure again from step **1**.

NOTE:

If you forget your password, enter "8888" in step **3**.

Basic Playback

- Turn on the unit.
- Turn on the TV and select the AV mode.
- Slide the **TV/CABLE/DBS/DVD** switch to **DVD**.

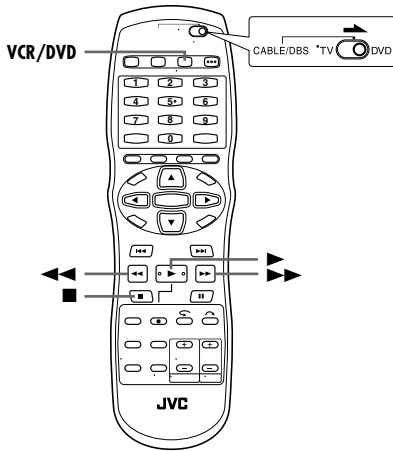
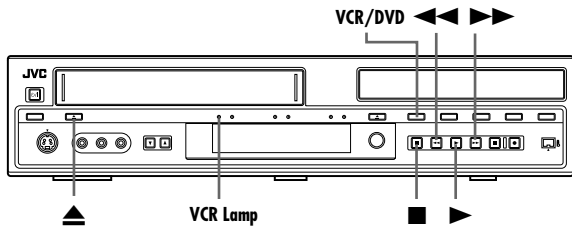

1 Load a cassette. Make sure the window side is up, the rear label side is facing you and the arrow on the front of the cassette is pointed toward the unit.

- Do not apply too much pressure when inserting.
- If the record safety tab has been removed, playback begins automatically. However, if "REC SAFETY" is set to "OFF" (☞ pg. 61), playback will not begin automatically.
- The unit's power comes on automatically and the counter is reset to 0:00:00.

2 Press **VCR/DVD** repeatedly so that the VCR lamp lights up on the unit.

3 Find the program start point. If the tape is advanced past the start point, press ◀◀. To go forward, press ▶▶.

4 Press ▶ to start playback.

5 Press ■ to stop playback.

- To eject the cassette, press ▲ (VCR).

Clean the video heads using a dry cleaning cassette — TCL-3F — when:

- Rough, poor picture appears while a tape is played back.
- The picture is unclear or no picture appears.
- "USE CLEANING CASSETTE" appears on the screen (only with "SUPERIMPOSE" set to "ON" or "AUTO"). (☞ pg. 61)

NOTE:

The heads get dirty in the following cases:

- in an environment prone to extreme temperature or humidity
- in a dusty environment
- flaw, dirt or mold on video tapes
- continuous usage for a long time

Usable cassettes

Full-Size VHS

T-30 (ST-30**)
T-60 (ST-60**)
T90
T-120 (ST-120**)
T-160 (ST-160**)
ST-210**

Compact VHS*

TC-20 (ST-C20**)
TC-30 (ST-C30**)
TC-40 (ST-C40**)

* Compact VHS camcorder recordings can be played on this unit. Simply place the recorded cassette into a VHS Cassette Adapter and it can be used just like any full-sized VHS cassette.

** This unit can record on regular VHS and Super VHS cassettes. While only VHS signals can be recorded on regular VHS cassettes¹⁾, both VHS and Super VHS signals can be recorded and played back using Super VHS cassettes.

1) By using the S-VHS ET function, it is possible to record and play back with S-VHS picture quality on VHS cassettes with this unit.

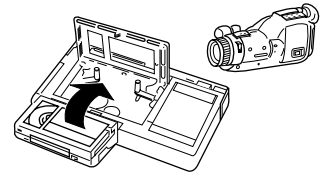

Playback Features

- Turn on the unit.
- Turn on the TV and select the AV mode.
- Slide the TV/CABLE/DBS/DVD switch to DVD.
- Press VCR/DVD repeatedly so that the VCR lamp lights up on the unit.

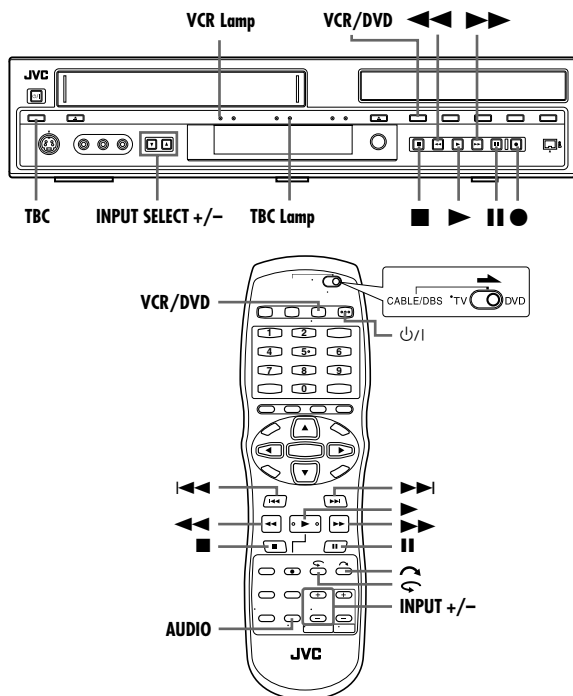

ATTENTION:

In the search, still, slow-motion or frame-by-frame playback mode,

- the picture will be distorted.
- the noise bars will appear.
- there may be a loss of color.
- you cannot hear the sound.

Still Picture/Frame-By-Frame Playback

- 1 Press **II** to pause during playback.
 - 2 Press **II** to activate frame-by-frame playback.
- To resume normal playback, press **▶**.

Slow Motion

- 1 Press **II** to pause during playback.
 - 2 Press and hold **II** for 2 seconds, then release. Press **II** and release again to return to still picture.
- The speed changes for each direction by pressing **◀◀** and **▶▶** repeatedly.
 - To resume normal playback, press **▶**.

Variable Speed Search

During playback, press **▶▶** for forward variable speed search, or **◀◀** for reverse variable speed search.

- Each press of the button increases the search speed for each direction.

When pressing **▶▶**:

(SP): +5x ↔ +11x

(EP): +11x ↔ +31x

When pressing **◀◀**:

Once **◀◀** is pressed, reverse search starts in -1x normal playback speed. After this process, each press of **◀◀** changes the search speed between -5x and -11x in SP mode, -11x and -31x in EP mode.

(SP): -1x ↔ -5x ↔ -11x

(EP): -1x ↔ -11x ↔ -31x

- To resume normal playback, press **▶**.

Instant Replay

During playback, press **↶**. The unit rewinds the picture a little (about 7 seconds) and resumes playback.

- If the button is pressed repeatedly, the unit rewinds the pictures continuously and resumes playback.

Skip Search

During playback, press **↷** 1 to 6 times to skip over unwanted sections.

- Each press initiates an approximately 30-second period of fast-motion playback. Normal playback resumes automatically.
- To resume normal playback, press **▶**.

Index Search

Your unit automatically marks index codes at the beginning of each recording. This function gives you quick access to any one of 9 index codes in either direction.

NOTE:

Before starting, make sure the unit is in the Stop mode.

Press **◀◀** or **▶▶** to activate Index Search. "INDEX -1" or "INDEX 1" is displayed on the TV screen and search begins in the corresponding direction.

- To access index codes 2 through 9, press **◀◀** or **▶▶** repeatedly until the correct index number is displayed.

Example:

To locate the beginning of B from the current position, press **◀◀** twice.

To locate the beginning of D from the current position, press **▶▶** once.

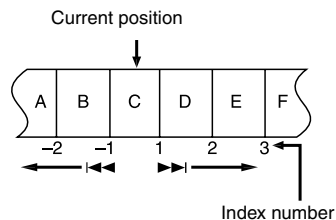

- When the specified index code is located, playback begins automatically.

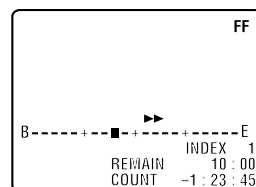

Next Function Memory

The Next Function Memory "tells" the unit what to do after rewinding. Before continuing, make sure the unit is in the Stop mode.

For Automatic Start Of Playback

Press ◀◀, then press ▶ within 2 seconds.

For Automatic Cassette Ejection After Tape Rewind

Press ◀◀, then press ▲ (VCR) on the unit within 2 seconds.

Repeat Playback

Your unit can automatically play back the whole tape repeatedly.

- 1 Press ▶ to start playback.
- 2 Press and hold ▶ for over 5 seconds, then release.
 - ⏮ lights up on the front display panel.
- 3 Press ■ at any time to stop Repeat Playback.
 - Pressing ▶, ◀◀, ▶▶ or || also stops Repeat Playback.

NOTES:

- To select the returning point (recording end or tape end), see "RETURN POINT" on page 61.
- It is possible to use the Mode Lock function. (☞ pg. 65)

Manual Tracking

Your unit is equipped with automatic tracking control. During playback, you can override this and adjust the tracking manually by pressing the **INPUT SELECT** buttons.

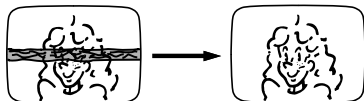

- 1 During playback, press **INPUT SELECT +/-** on the unit simultaneously to activate manual tracking.
- 2 Press **INPUT SELECT +/-** on the unit or **INPUT +/-** on the remote control to adjust the tracking manually.
 - To return to automatic tracking, press **INPUT SELECT +/-** on the unit simultaneously or eject and insert the tape again.

NOTE:

When a new tape is inserted, the unit enters the automatic tracking mode automatically.

Adjusting picture condition — Digital TBC/NR

Your unit is equipped with the Digital TBC (Time Base Corrector) that removes jitter from fluctuating video signals to deliver a stable picture even with old tapes and rental cassettes.

The Digital 3-DNR (Noise Reduction) which cuts noise and enables clear picture reproduction is also linked to this function. We recommend that you use the DIGITAL TBC/NR function when...

- playing back a tape recorded on a camcorder.
- playing back a tape repeatedly used.
- using this unit as the source player for editing.

Press **TBC** on the unit so that the TBC lamp lights up on the unit.

- Each time you press the button, it toggles this function on and off.

NOTES:

- If you play back a tape recorded under poor TV reception condition, the picture may become more stable with Digital TBC/NR deactivated.
- If you play back a tape where certain types of signals are recorded (using a PC or some character generators) with Digital TBC/NR activated, the playback picture may be distorted. In this case, deactivate Digital TBC/NR.
- Digital TBC/NR and Video Stabilizer (☞ pg. 61) cannot be used at the same time; if you activated Digital TBC/NR when "VIDEO STABILIZER" is set to "ON", Video Stabilizer will be automatically turned "OFF". Make sure Digital TBC/NR is deactivated when you want to use Video Stabilizer.

Soundtrack Selection

Your unit is capable of recording three soundtracks (HI-FI L, HI-FI R and NORM) and will play back the one you select.

During Playback

Pressing **AUDIO** changes the soundtrack as follows:

TRACK	USE
On-Screen Display	
HI-FI	Hi-Fi sound is played back
HI-FI L	Sound on the left Hi-Fi channel is played back
HI-FI R	Sound on the right Hi-Fi channel is played back
NORM	Sound on the normal track is played back
NORM HI-FI	Both sounds on the Hi-Fi track and normal track are mixed and played back

NOTES:

- "HI-FI" should normally be selected. In this mode, Hi-Fi stereo tapes are played back in stereo, and the normal audio track is played back automatically for tapes with only normal audio.
- "SUPERIMPOSE" must be set to "ON" or "AUTO" or the on-screen displays will not appear. (☞ pg. 61)

VHS Progressive Scan

You can watch the image on VCR deck in the Progressive scan mode via component video.

ATTENTION:

Your TV needs to be compatible with Progressive and to have Component video input connectors.

- 1 Set the Progressive-compatible TV to the component input mode.
- 2 Press **VCR/DVD** repeatedly so that the DVD lamp lights up on the unit, then press **PROGRESSIVE SCAN** for 3 or more seconds so that the Video output indicator (P) lights on the front display panel.
- 3 Press **VCR/DVD** repeatedly so that the VCR lamp lights up on the unit.
- 4 Press **VCR→DVD**.

NOTE:

Be sure to engage the DVD deck in stop mode.

Simultaneous Recording

This function allows you to record programs on both DVD deck and VCR deck simultaneously from the same input source (F1 or L1). It is useful when you require both DVD and tape version of a program you are recording once recording is complete.

- Turn on the unit.
- Turn on the TV and select the AV mode.
- Slide the **TV/CABLE/DBS/DVD** switch to **DVD**.

ATTENTION:

It is not possible to record programs on a DVD-R disc which has already been finalized.

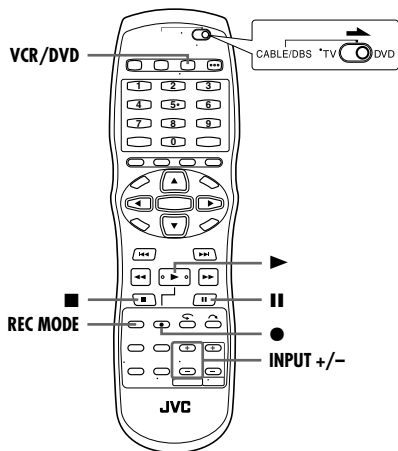
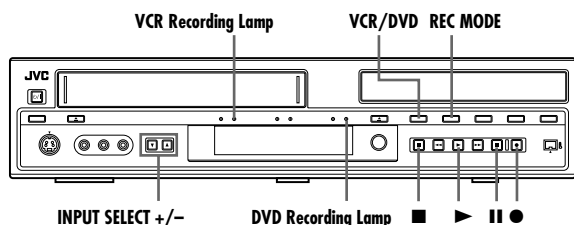

1 Prepare the DVD deck for recording.

- 1 Load a recordable disc.
 - 2 Press **VCR/DVD** repeatedly so that the DVD lamp lights up on the unit.
 - 3 Press **INPUT SELECT +/-** on the unit or **INPUT +/-** on the remote control to select the recording source (**F1** or **L1**).
 - 4 Set the DVD deck to the stop mode.
 - 5 Press **REC MODE** repeatedly to set the recording mode.
- When you press **REC MODE** once, the current recording mode is displayed. Thereafter, each time you press **REC MODE**, the recording mode changes as follows:
XP → SP → LP → EP → FR → (Back to the beginning)
 - * The value is selectable from 1 to 6 hours in 5-minute intervals, from 7 to 8 hours in 1-hour intervals by pressing **<D>** repeatedly after selecting "FR60-FR360", "FR420" and "FR480". To change the value in 30-minute intervals, press and hold **<D>**.
 - For details on the recording mode, see page 37.

2 Prepare the VCR deck for recording.

- 1 Load a cassette with the record safety tab intact. If not, set "REC SAFETY" to "OFF" (pg. 61).
- The counter is reset to 0:00:00.
- 2 Press **VCR/DVD** repeatedly so that the VCR lamp lights up on the unit.
- 3 Press **INPUT SELECT +/-** on the unit or **INPUT +/-** on the remote control to select the recording source (**F1** or **L1**).
- The recording source selected MUST be the same as that selected for the DVD deck.

4 Rewind the tape fully to the beginning and set the VCR deck to the stop mode.

5 Press **REC MODE** repeatedly to set the recording mode.

- When you press **REC MODE** once, the current recording mode is displayed. Thereafter, each time you press **REC MODE**, the recording mode alternates between **SP** and **EP**.

NOTE:

The order for the DVD and VCR deck preparation is not fixed. You may choose to start preparation for the VCR deck first. In whichever case, the recording source selection in step 3 must be the same.

3 Press **●** and **||** simultaneously to set to record pause mode.

- Both the DVD and VCR deck will enter the Record Pause mode at the same time.
- If the recording source selected in step 3 differs on the DVD and VCR deck, only the current selected deck will enter the Record Pause mode.
- If you do not start recording within 5 minutes, the VCR deck will enter stop mode automatically while the DVD deck remains in the Record Pause mode.

4 After about 10 seconds, press **▶** to start recording.

- Both the DVD and VCR deck start recording at the same time. Both the DVD and VCR recording lamps light on the unit.
- If the recording source selected in step 3 differs on the DVD and VCR deck, only the current selected deck will start recording.
- If you start recording immediately after setting the decks to Record Pause mode in step 3, the current selected deck will start recording while the other deck remains in the Record Pause mode. Be sure to wait for about 10 seconds.

5 To pause recording, press **||**.

- Both the DVD and VCR deck will enter the Record Pause mode at the same time.
- To resume recording, press **▶**.

6 To stop recording, press **■**.

- Both the DVD and VCR deck will stop recording at the same time.

NOTES:

- If Mode Lock is engaged when both the DVD and VCR deck are in stop mode, Simultaneous Recording will not work.
- If Mode Lock is engaged during Simultaneous Recording, it is not possible to pause or stop the recording.
- It is recommended to format a DVD-RAM disc before use if you use the disc on this unit for the first time.
- When using a brand-new DVD-RW disc, format the disc either in VR mode or in Video mode. (pg. 62)
- Recordings made on DVD-R/RW disc must be finalized to play back on other DVD players. Perform "Finalize A Disc (DVD Deck Only)" (pg. 63)
- You can record up to 99 programs and 99 play lists on each disc.
- When recording is started, an index of the first part of recording is automatically recorded. (pg. 39) To delete the index, refer to page 41.
- Recording on the DVD deck sometimes may stop or cannot be performed even if there is enough available capacity remaining on the disc.

Accidental erasure prevention

To prevent accidental recording on a recorded cassette, remove its safety tab and set "REC SAFETY" to "ON" (pg. 61). To record on it later, cover the hole with adhesive tape or set "REC SAFETY" to "OFF".

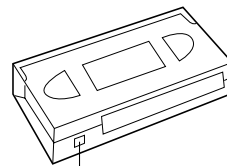

Record safety tab

Recording Mode

MPEG2 format is used as recording format. As a guide for picture quality, the "bps" unit is used to represent how much data can be recorded per second. The larger this value is, the better the picture quality becomes but more capacity is required for the recording. Select XP or SP for programs where quick movement occurs, such as sports programs, and LP or EP for talk shows, etc. with relatively less movement.

The recording modes for a 4.7 GB disc are set as follows:

Recording mode	Recording amount (approx.)	Maximum recording time (approx.)
XP	10 Mbps	1 hour
SP	5 Mbps	2 hours
LP	2 Mbps	4 hours
EP	1.6 Mbps	6 hours
FR60–FR360	The amount varies depending on the selected time.	1 – 6 hours
FR420		7 hours
FR480		8 hours

Recording Features (DVD Deck)



- Turn on the unit.
- Turn on the TV and select the AV mode.
- Slide the TV/CABLE/DBS/DVD switch to DVD.
- Press VCR/DVD repeatedly so that the DVD lamp lights up on the unit.

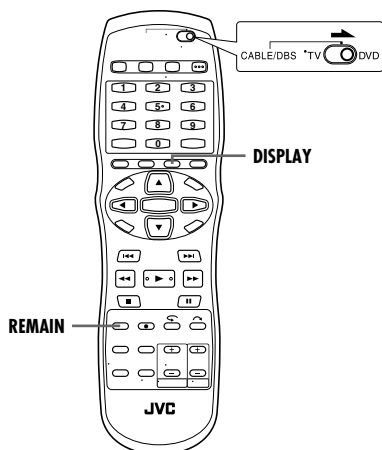

Elapsed Recording Time And Disc Remaining Time Indication

During recording, press **DISPLAY** repeatedly until the desired indication appears on the front display panel.

- Each time you press **DISPLAY**, the time indication changes as follows:
Elapsed recording time → Disc remaining time → Clock → (Back to the beginning)
- You can also check the disc remaining time by pressing **REMAIN** while the unit is stopped or recording is in progress. The list of disc remaining times for all recording modes appears on the TV screen.

Free Rate Function

To record the entire program, the unit automatically set the appropriate recording mode depending on the combination of the total time of the program to be recorded and either the remaining disc space or the specified recording time (from 60 minutes to 480 minutes).

■ To record the entire program by specifying the desired recording time

Select "FR60–FR360", "FR420" or "FR480" in a recording mode selection procedure. (pg. 36)

■ To record a 25-min. long daily program five times just on a same disc for example

Be sure to set the recording mode to "FR125" to fit the total recording time to the whole disc space.

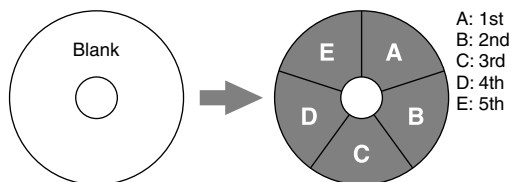

When the same program is recorded in SP mode instead of in "FR125", the 5th program cannot be recorded.

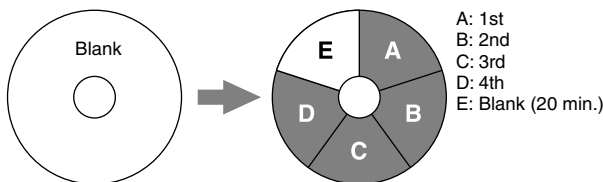

NOTES:

- In order to ensure that the recording fits on the disc, this feature may leave a slight non-recorded section at the end of the disc.
- There may be some noise and sound disturbance at the point on the disc where the unit switches the mode.

Recording Features (VCR Deck)

- Turn on the unit.
- Turn on the TV and select the AV mode.
- Slide the **TV/CABLE/DBS/DVD** switch to **DVD**.
- Press **VCR/DVD** repeatedly so that the VCR lamp lights up on the unit.

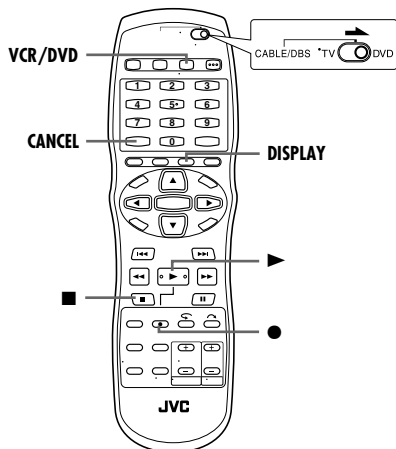
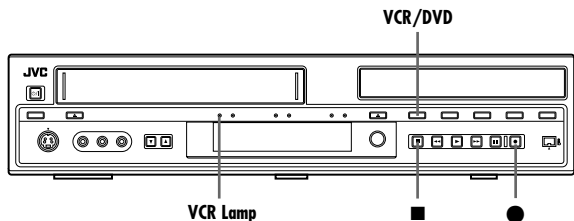

Repeat Recording

You can record programs on one tape repeatedly. The tape is automatically rewound to the beginning to continue recording when the end of tape is reached during recording. The previously recorded programs will be overwritten.

During recording, press and hold **▶** and **●** on the remote control or **●** on the unit for more than 5 seconds.

- The recording lamp on the unit starts to blink slowly.

To stop recording, press **■**.

NOTE:

It is possible to use the Mode Lock function (➤ pg. 65).

Elapsed Recording Time Indication

1 Press **DISPLAY** until a counter reading appears on the front display panel.

2 Press **CANCEL** to reset the counter before starting recording or playback.

- The counter is reset to "0:00:00" and shows the exact elapsed time as the tape runs. You can check the exact time of a recording or playback.

Tape Remaining Time

1 Press **DISPLAY** until the time remaining on the tape appears.

- By pressing the **DISPLAY** button, you can change display to show the clock time, counter reading or tape remaining time.

NOTES:

- When you press **ON SCREEN**, the on-screen display appears on the TV screen for 5 seconds, then the displays other than the counter disappears. To clear the counter display, press **ON SCREEN**.

- Depending on the type of tape being used, the tape remaining time reading may not appear right away, or is not correct. "—:—:—" may sometimes appear, or the display may blink on occasion.

Active Video Calibration

The Video Calibration checks the condition of the tape in use during playback and recording, and compensates to provide the highest-possible playback and recording pictures. You can set "VIDEO CALIBRATION" to "ON" or "OFF" to your preference. (➤ pg. 60)

Playback

The unit assesses the quality of the tape once you initiate playback.

- The unit adjusts the playback picture quality based on the quality of the tape in use.
- Video Calibration is active during automatic tracking. The Video Calibration screen appears blinking on the TV screen.

NOTES:

- When watching a tape recorded with "VIDEO CALIBRATION" set to "ON", it is recommended that you leave "VIDEO CALIBRATION" on during playback as well.
- When watching a rental tape or one recorded on another VCR, or when using this unit as the player for editing, set "VIDEO CALIBRATION" to your preference. (➤ pg. 60)
- The Video Calibration only appears at the beginning of automatic tracking. Even though it doesn't appear after that, the VIDEO CALIBRATION function is operative.

Recording

The unit assesses the quality of the tape once you initiate recording.

- The unit spends approximately 7 seconds assessing the condition of the tape, then begins recording.

NOTES:

- The Video Calibration works for both SP and EP modes only after a tape has been inserted and the Record mode is first initiated. It does not work during recording.
- Once the cassette is ejected, the Video Calibration data is cancelled. The next time the cassette is used for recording, Video Calibration is re-performed.

ATTENTION:

Since the Video Calibration works before recording actually starts, there is a delay of approximately 7 seconds after **●** and **▶** on the Remote are pressed, or **●** on the unit is pressed. To make sure you record the desired scene or program in its entirety, first perform the following steps:

- 1** While holding **II**, press **●** to engage the Record Pause mode.
 - The unit then automatically checks the condition of the tape and, after approximately 7 seconds, re-enters Record Pause mode.
- 2** Press **▶** to start recording.

If you want to bypass the Video Calibration and begin recording immediately, set "VIDEO CALIBRATION" to "OFF". (➤ pg. 60)

Library Database DVD Navi



The Library Database DVD Navi enables you to search and select the desired programs recorded on a DVD-RAM/R/RW disc very easily.

You can record up to 99 programs on a disc.

Each time a program is recorded on the disc, the information of the program is registered for the Library Database DVD Navi automatically.

So, you can confirm the information of the programs recorded on the disc with the Library Database DVD Navi screen. And, you can also select one of the programs recorded on the disc using the Library Database DVD Navi.

The following screen appears as the Library Database DVD Navi screen when you press **NAVIGATION**. You can move the arrow to select the desired position on the screen by pressing Δ ∇ \triangleleft \triangleright on the remote control.

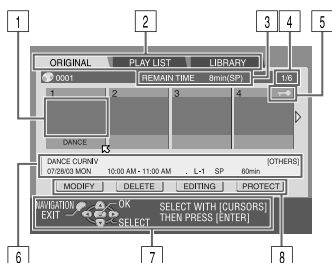

- 1 Index
(Small still picture of each program)
- 2 Names of functions
ORIGINAL (pg. 40)
PLAY LIST (pg. 42)
LIBRARY (pg. 44)
- 3 Remaining time
(Based on the recording mode currently selected)
- 4 Current/Total number of program(s)
(For example, there are 6 recorded programs and the program indicated by the arrow is the 1st one.)
- 5 Icons
(Indicate the recording situation for each program.)
🔒 : This program is write-protected.
- 6 Recording information for the program indicated by the arrow
- 7 Guidance for operations
- 8 Operational commands

Using Library Database DVD Navi system, you can easily modify registered information, edit the program or play list, as well as search for the beginning of each program.

About registration of information

The following information is automatically registered for each program when ordinary recording is performed, then stored in an area specified on the unit.

- index* (reduced still pictures to show program titles)
- program title*
- category*
- date and time
- input select
- recording mode
- length of recording time

The items marked with an asterisk (*) can be easily modified and registered again after recording by using Library Database DVD Navi system.

About editing of programs

Library Database DVD Navi system has the following functions for editing of programs.

- "Edit Play List Information" (pg. 42)
- "Delete Program" (pg. 41)

The limitations of registration

You can register information up to 99 programs.

When the amount of information is at the limits of registration, you cannot record new program any more. In this case, you need to delete old programs to register new one. (pg. 41)

NOTE:

Once a DVD-R/RW (Video mode) disc has been finalized, the displays for original and play list do not appear. Only display for library appears.

The display for original recording



The display for play list



Scan For Beginning(s) Of Program(s)

- Turn on the TV and select the AV mode.
- Slide the **TV/CABLE/DBS/DVD** switch to **DVD**.

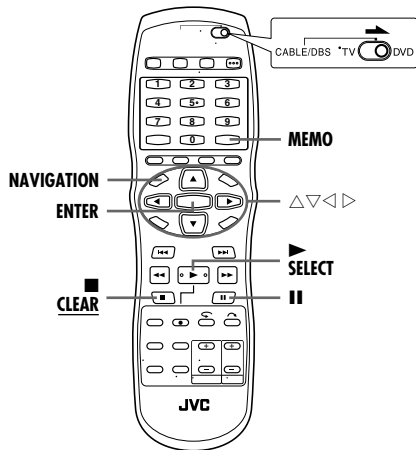

You can scan the beginning of the program easily with the Library Database DVD Navi.

- 1 Load a recorded disc.
- 2 Press **NAVIGATION**. The Library Database DVD Navi screen appears.
- 3 Press $\Delta \nabla \triangleleft \triangleright$ to select "ORIGINAL", then press **ENTER**.
- 4 Press $\triangleleft \triangleright$ to select the index (small still pictures) of the desired program.
 - When you want the plural programs to be played back continuously, press **MEMO** after selecting the desired program. The numbers of the playback order appear on the index. You can select up to 30 programs.
 - When you want to correct the order, move the arrow to the desired index and press **MEMO**. The number disappears and the unit re-numbers the other programs automatically.
 - When you want to cancel the order, press **CLEAR** (■).
- 5 Press **SELECT** (▶) to start playback.
- 6 Press **II** to pause playback.
 - To resume normal playback, press ▶.
- 7 Press ■ to stop playback.

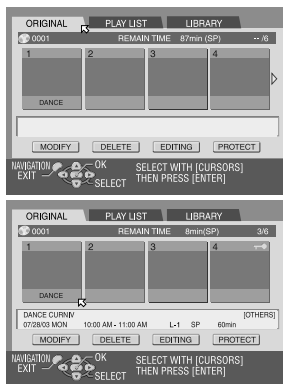

Edit Original Information



- Turn on the TV and select the AV mode.
- Slide the **TV/CABLE/DBS/DVD** switch to **DVD**.

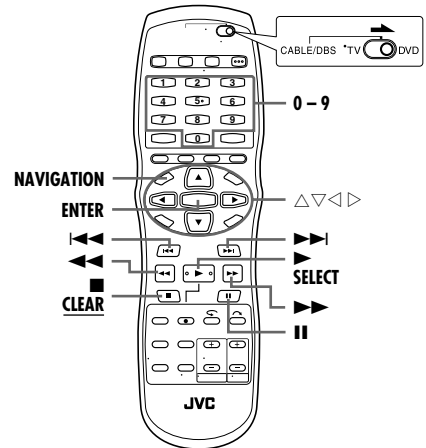

Modify Index

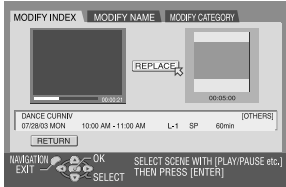
- 1 Press **NAVIGATION**. The Library Database DVD Navi screen appears.
- 2 Press $\Delta \nabla \triangleleft \triangleright$ to select "ORIGINAL", then press **ENTER**.
- 3 Press $\Delta \nabla \triangleleft \triangleright$ to select one program you want to modify, then press ∇ .
- 4 Press $\Delta \nabla \triangleleft \triangleright$ to select "MODIFY", then press **ENTER**.
- 5 Press $\triangleleft \triangleright$ to select "MODIFY INDEX".
- 6 Search for the picture from the program by pressing the appropriate buttons (\triangleleft , \triangleright , \blacktriangleleft , \blacktriangleright , or **II**). The pictures of the program appear on the left window.
 
- 7 Confirm the arrow is on "REPLACE", then press **ENTER** to register new index. New index appears on the right window.
 - When you press **ENTER** with the arrow on "RETURN" you can return to the previous screen.
- 8 Press **NAVIGATION** to return to the normal screen.
 - Press ■ to cancel pause mode after pressing **NAVIGATION**.

Modify Program Name

1 Perform steps **1** to **3** of "Modify Index" (pg. 40) before continuing.

2 Press $\Delta \nabla \triangleleft \triangleright$ to select "MODIFY", then press **ENTER**.

3 Press $\triangleleft \triangleright$ to select "MODIFY NAME".

4 Press $\Delta \nabla \triangleleft \triangleright$ to select the desired letter or command, then press **ENTER**. Repeat this process to complete the name.

- To correct a letter, press $\Delta \nabla \triangleleft \triangleright$

- to select "DELETE" or "DELETE ALL", then press **ENTER**.

- You can enter the letters up to 64.

- You can also enter the new name with the **number keys**. For example, when you press **2** repeatedly, "A", "B", "C", "a", "b", "c", "2", and then "A" appear by turns. You can use the following buttons.

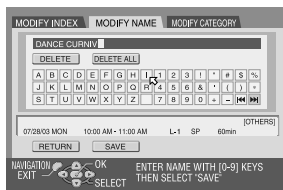

Number keys: for entering letters, numbers and blank space

$\triangleleft \triangleright$ **buttons:** for moving the entering or inserting point

CLEAR (■) **button:** for correcting a letter

$\leftarrow \rightarrow$ **buttons:** for changing character tables

5 Press $\Delta \nabla \triangleleft \triangleright$ to select "SAVE", then press **ENTER**.

6 Press $\Delta \nabla \triangleleft \triangleright$ to select "RETURN", then press **ENTER**. The Library Database DVD Navi screen appears again.

7 Press **NAVIGATION** to return to the normal screen.

Modify Category

1 Perform steps **1** to **3** of "Modify Index" (pg. 40) before continuing.

2 Press $\Delta \nabla \triangleleft \triangleright$ to select "MODIFY", then press **ENTER**.

3 Press $\triangleleft \triangleright$ to select "MODIFY CATEGORY".

4 Press $\Delta \nabla \triangleleft \triangleright$ to select the desired category, then press **ENTER**.

5 Press **ENTER**. The Library Database DVD Navi screen appears again.

6 Press **NAVIGATION** to return to the normal screen.

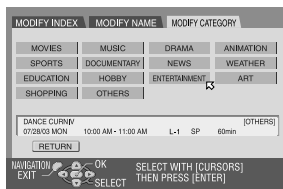

Protect Title (DVD-RAM & DVD-RW (VR mode) only)

You can protect the program to prevent accidental erasure of the important program.

1 Perform steps **1** to **2** of "Modify Index" (pg. 40) before continuing.

2 Press $\Delta \nabla \triangleleft \triangleright$ to select a program you want to protect, then press ∇ .

3 Press $\triangleleft \triangleright$ to select "PROTECT", then press **ENTER**. "🔑" appears.

- To cancel the protection, repeat **2** – **3** again.

4 Press **NAVIGATION** to return to the normal screen.

NOTE:

All the programs on a disc will be deleted once the disc is formatted even if they are protected titles. (pg. 62)

Delete Program

You cannot record any more with Library Database DVD Navi once the registered programs on the disc reach 99 programs. Deleting unnecessary programs after dubbing or other operations can increase remaining time and available recording capacity. (For DVD-R discs, although it is possible to delete recorded programs, available recording capacity does not increase.) The deleted program is never resumed. Play lists and program information in the unit's library are also deleted.

1 Perform steps **1** to **2** of "Modify Index" (pg. 40) before continuing.

2 Press $\Delta \nabla \triangleleft \triangleright$ to select one program you want to delete, then press ∇ .

3 Press $\Delta \nabla \triangleleft \triangleright$ to select "DELETE", then press **ENTER**. The message appears for your confirmation.

4 Press $\triangleleft \triangleright$ to select "YES", then press **ENTER**.

- When you cancel the deletion, select "NO", then press **ENTER**.

5 Press **NAVIGATION** to return to the normal screen.

Delete Unwanted Part Of The Program (DVD-RAM & DVD-RW (VR mode) only)

You can delete unwanted part of the program.

1 Perform steps **1** to **2** of "Modify Index" (pg. 40) before continuing.

2 Press $\triangleleft \triangleright$ to select one program whose unwanted part you want to delete, then press ∇ .

3 Press $\triangleleft \triangleright$ to select "EDITING", then press **ENTER**.

4 Press \blacktriangleright to start playback. The playback pictures appear in the window on the screen. The elapsed playing time starts counting with the arrow on "IN".

5 Find the point where you want the deletion to begin, then press **ENTER** with the arrow on "IN". The edit-in time is fixed and the elapsed playing time starts counting again.

6 Find the point where you want the deletion to end, then press **ENTER** with the arrow on "OUT". The edit-out time is fixed.

- Press \leftarrow , \rightarrow , \blacktriangleright , \blacktriangleleft , \blacktriangleleft , \blacktriangleright or \parallel to find the edit-in and edit-out points.

7 Press $\Delta \nabla \triangleleft \triangleright$ to select "PREVIEW", then press **ENTER** to preview the edited program.

8 Press $\Delta \nabla \triangleleft \triangleright$ to select "EXECUTE", then press **ENTER**.

- If you do not want to delete the scene, select "CLEAR" and press **ENTER**.

9 Press $\triangleleft \triangleright$ to select "YES", then press **ENTER**. The selected scene is deleted.

- To cancel the deletion, press $\triangleleft \triangleright$ to select "NO", then press **ENTER**.

To modify the points

1 Press $\triangleleft \triangleright$ to select "CLEAR", then press **ENTER**.

2 Press Δ to select "IN", then repeat steps **4** – **9**.

10 Press **NAVIGATION** to return to the normal screen.

NOTES:

- There may be a discrepancy of several seconds between the scene you intend to edit, and the scene which is actually edited.

- Available recording capacity may not match the deleted part after deletion.

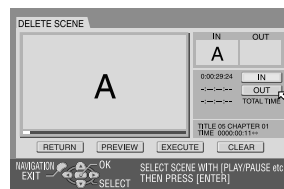

Edit Play List Information



- Turn on the TV and select the AV mode.
- Slide the TV/CABLE/DBS/DVD switch to DVD.

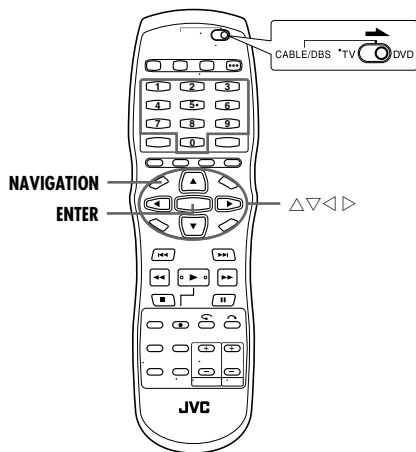

Play List

It is a collection of the scenes. A play list can be freely edited and played back without ever changing any original recording data. Using the random access of a DVD disc (which allows video data to be instantly read no matter where it is on the disc), a play list includes information such as the timer counter for the playback start point and end point, indexes for checking the contents of recorded data, category information, and more. Playback according to a play list you have created allows you to enjoy various combinations of video images from a single program.

Create Play List

- 1 Load a DVD-RAM or DVD-RW (VR mode) disc that was recorded with this unit.
- 2 Press **NAVIGATION**. The Library Database DVD Navi screen appears.
- 3 Press $\Delta \nabla \triangleleft \triangleright$ to select "PLAY LIST", then press **ENTER**.
- 4 Press $\Delta \nabla \triangleleft \triangleright$ to select "CREATE", then press **ENTER**.
- 5 Press \blacktriangleright to start playback. The playback pictures appear in the window on the screen. The elapsed playing time starts counting with the arrow on "IN".
 - To locate the beginning of other titles, press $\blacktriangleleft \blacktriangleright \blacktriangleright \blacktriangleright \blacktriangleleft \blacktriangleright \blacktriangleright \blacktriangleright$ or \parallel .
- 6 Find the point where you want the created play list to begin, then press **ENTER** with the arrow on "IN". The edit-in time is fixed and the elapsed playing time starts counting again.
- 7 Find the point where you want the created play list to end, then press **ENTER** with the arrow on "OUT". The edit-out time is fixed.
 - Press $\blacktriangleleft \blacktriangleright \blacktriangleright \blacktriangleright \blacktriangleleft \blacktriangleright \blacktriangleright \blacktriangleright$ or \parallel to find the edit-in and edit-out points.
 - The edit-out point must come after the edit-in point.

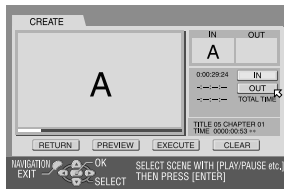

8 Press $\triangleleft \triangleright$ to select "PREVIEW", then press **ENTER** to preview the play list.

9 Press $\triangleleft \triangleright$ to select "EXECUTE", then press **ENTER**. The play list is created.

To modify the points

- 1 Press $\triangleleft \triangleright$ to select "CLEAR", then press **ENTER**.
- 2 Repeat steps 5 – 9 as necessary.

10 Press **NAVIGATION** to return to the normal screen.

NOTES:

- There may be a discrepancy of several seconds between the scene you intend to edit, and the scene which is actually edited.
- The title, index and category of the play list can be modified in the same way as "ORIGINAL". (See pg. 40)
- You can modify the play list that has just been created here by adding, moving, or deleting unwanted parts to create a digest edition, etc.

Add Scenes To A Play List

1 Perform steps 1 to 3 of "Create Play List" (See pg. 42) before continuing.

2 Press $\triangleleft \triangleright$ to select the play list to which you wish to add a scene, then press ∇ .

3 Press $\triangleleft \triangleright$ to select "EDITING", then press **ENTER**.

4 Press $\triangleleft \triangleright$ to select "ADD SCENE".

5 Press \blacktriangleright to start playback. The playback pictures appear in the window on the screen. The elapsed playing time starts counting with the arrow on "IN".

- To locate the beginning of other titles, press $\blacktriangleleft \blacktriangleright \blacktriangleright \blacktriangleright \blacktriangleleft \blacktriangleright \blacktriangleright \blacktriangleright$.

6 Find the point where you want the added scene to begin, then press **ENTER** with the arrow on "IN". The edit-in time is fixed and the elapsed playing time starts counting again.

7 Find the point where you want the added scene to end, then press **ENTER** with the arrow on "OUT". The edit-out time is fixed.

8 Press $\triangleleft \triangleright$ to select "PREVIEW", then press **ENTER** to preview approximately 5 seconds before and after the edited scene.

9 Press $\triangleleft \triangleright$ to select "EXECUTE", then press **ENTER**. The selected scene is added.

To modify the points

- 1 Press $\triangleleft \triangleright$ to select "CLEAR", then press **ENTER**.
- 2 Repeat steps 5 – 8 as necessary.

10 Press **NAVIGATION** to return to the normal screen.

NOTE:

There may be a discrepancy of several seconds between the scene you intend to edit, and the scene which is actually edited.

Move Scenes

1 Perform steps 1 to 3 of "Create Play List" (See pg. 42) before continuing.

2 Press $\triangleleft \triangleright$ to select a play list into which you wish to move a scene, then press ∇ .

3 Press $\triangleleft \triangleright$ to select "EDITING", then press **ENTER**.

4 Press $\triangleleft \triangleright$ to select "MOVE SCENE".

5 Press \blacktriangleright to start playback. The playback pictures appear in the window on the screen. The elapsed playing time starts counting with the arrow on "IN".

- To locate the beginning of other titles, press $\blacktriangleleft \blacktriangleright \blacktriangleright \blacktriangleright \blacktriangleleft \blacktriangleright \blacktriangleright \blacktriangleright$.

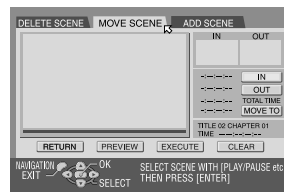
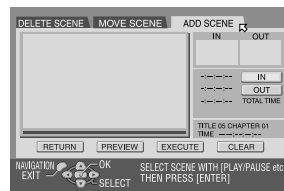

6 Find the point where you want the moved scene to begin, then press **ENTER** with the arrow on "IN". The edit-in time is fixed and the elapsed playing time starts counting again.

7 Find the point where you want the moved scene to end, then press **ENTER** with the arrow on "OUT". The edit-out time is fixed.

8 Press **▶** to start playback.

9 Find the point where you want the moved scene to be moved, then press **ENTER** with the arrow on "MOVE TO".

- Press **◀◀**, **▶▶**, **◀▶**, **▶◀** or **||** to find the edit-in, edit-out and move-to points.

10 Press **◀▶** to select "PREVIEW", then press **ENTER** to preview the part approximately 5 seconds before and after the point to which the scene has been moved.

11 Press **◀▶** to select "EXECUTE", then press **ENTER**. The selected scene is moved.

To modify the points

1 Press **◀▶** to select "CLEAR", then press **ENTER**.

2 Repeat steps **5 – 11** as necessary.

12 Press **NAVIGATION** to return to the normal screen.

NOTE:

There may be a discrepancy of several seconds between the scene you intend to edit, and the scene which is actually edited.

Delete Unwanted Part From Play List

1 Perform steps **1 to 3** of "Create Play List" (☞ pg. 42) before continuing.

2 Press **◀▶** to select a play list from which you wish to delete unwanted parts, then press **▽**.

3 Press **◀▶** to select "EDITING", then press **ENTER**.

4 Press **◀▶** to select "DELETE SCENE", then press **ENTER**.

5 Press **▶** to start playback. The playback pictures appear in the window on the screen. The elapsed playing time starts counting with the arrow on "IN".

- To locate the beginning of other titles, press **◀◀/▶▶**.

6 Find the point where you want the deletion to begin, then press **ENTER** with the arrow on "IN". The edit-in time is fixed and the elapsed playing time starts counting again.

7 Find the point where you want the deletion to end, then press **ENTER** with the arrow on "OUT". The edit-out time is fixed.

- Press **◀◀**, **▶▶**, **◀▶**, **▶◀** or **||** to find the edit-in and edit-out points.

8 Press **◀▶** to select "PREVIEW", then press **ENTER** to preview the scene approximately 5 seconds before and after the deleted part.

9 Press **◀▶** to select "EXECUTE", then press **ENTER**. The selected scene is deleted.

To modify the points

1 Press **◀▶** to select "CLEAR", then press **ENTER**.

2 Repeat steps **5 – 9**.

10 Press **◀▶** to select "YES", then press **ENTER**. The selected scene is deleted.

- To cancel the deletion, press **◀▶** to select "NO", then press **ENTER**.

To modify the points

1 Press **◀▶** to select "CLEAR", then press **ENTER**.

2 Press **△** to select "IN", then repeat steps **4 – 10**.

11 Press **NAVIGATION** to return to the normal screen.

NOTE:

There may be a discrepancy of several seconds between the scene you intend to edit, and the scene which is actually edited.

Play Back Play List

1 Perform steps **1 to 3** of "Create Play List" (☞ pg. 42) before continuing.

2 Press **◀▶** to select the index (small still pictures) of the desired play list.

- When you want the plural play lists to be played back continuously, press **MEMO** after selecting the desired play lists. The numbers of the playback order appear on the index. You can select up to 30 play lists.

- When you want to correct the order, move the arrow on the desired index and press **MEMO**. The number disappears and the unit renumbers the other play lists automatically.

- When you want to cancel the order, press **CLEAR** (■).

3 Press **ENTER** or **SELECT** (▶) to start playback. The playback starts.

4 Press **||** to pause playback.

- To resume normal playback, press **▶**.

5 Press **■** to stop playback.



Delete Play List

1 Perform steps **1 to 3** of "Create Play List" (☞ pg. 42) before continuing.

2 Press **◀▶** to select one play list you want to delete, then press **▽**.

3 Press **◀▶** to select "DELETE", then press **ENTER**.

4 Press **◀▶** to select "YES", then press **ENTER**.

- When you cancel the deletion, select "NO", then press **ENTER**.

5 Press **NAVIGATION** to return to the normal screen.

NOTE:

Even if a play list is deleted, the programs recorded on a DVD disc and the library information are not affected at all.

Modify Index

1 Perform steps **1 to 3** of "Create Play List" (☞ pg. 42) before continuing.

2 Perform steps **3 to 8** of "Modify Index" (☞ pg. 40).

Modify Program Title

1 Perform steps **1 to 3** of "Create Play List" (☞ pg. 42) before continuing.

2 Press **△▽◀▶** to select one program you want to modify, then press **▽**.

3 Perform steps **2 to 7** of "Modify Program Name" (☞ pg. 41).

Modify Category

1 Perform steps **1 to 3** of "Create Play List" (☞ pg. 42) before continuing.

2 Press **△▽◀▶** to select one program you want to modify, then press **▽**.

3 Perform steps **2 to 6** of "Modify Category" (☞ pg. 41).

Edit Library Information



Program information can be registered in the unit's memory for up to 1,300 programs. It is helpful when finding out on which disc the desired program is recorded.

- Turn on the TV and select the AV mode.
- Slide the TV/CABLE/DBS/DVD switch to DVD.

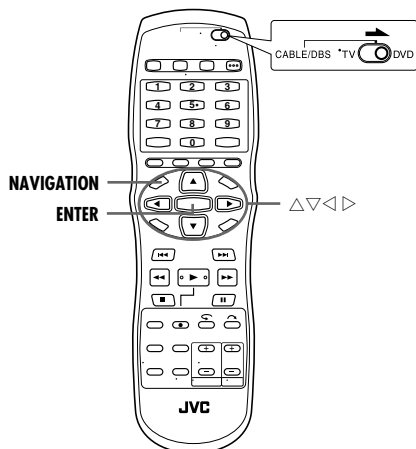

Scan For Program From Library

1 Press **NAVIGATION**. The Library Database DVD Navi screen appears.

2 Press $\Delta \nabla \triangleleft \triangleright$ to select "LIBRARY", then press **ENTER**.

3 Press $\triangleleft \triangleright$ to select the appropriate sort button to sort the information, then press **ENTER**.

"DISC No." : Sort by disc number

"CATEGORY" : Sort by category

"DATE" : Sort by date

"NAME" : Sort by name

- The sorting order can be switched between ascending order and descending order by pressing the sort buttons.

4 Press $\triangleleft \triangleright$ to select the desired program, then press **ENTER**.

- Playback begins automatically after the selected program is located.

When the disc that contains the selected program is not loaded

A screen prompting you to load the designated disc appears. Place the disc whose number is displayed on the screen after pressing **ENTER** to close the prompt screen. Then perform steps 1 to 4.

NOTE:

If a disc registered in the library is recorded or modified on DVD units from other manufacturers, it may become impossible to operate properly.

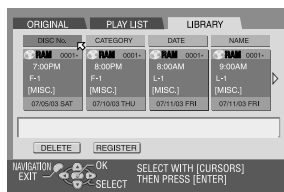

Register Disc

1 Load a disc you want to register.

2 Press **NAVIGATION**. The Library Database DVD Navi screen appears.

3 Press $\Delta \nabla \triangleleft \triangleright$ to select "LIBRARY", then press **ENTER**.

4 Press $\triangleleft \triangleright$ to select "REGISTER", then press **ENTER**.

5 Press $\triangleleft \triangleright$ to select "REGISTER", then press **ENTER** to confirm the registration.

6 Press **NAVIGATION** to return to the normal screen.

NOTES:

- It is not possible to register discs formatted on devices other than JVC's DVD recorders.
- It is not possible to register discs recorded on devices other than JVC's DVD recorders.
- It is not possible to register discs when "SAVE AS LIBRARY" is set to "OFF". (pg. 59)

Delete Information

1 Press **NAVIGATION**. The Library Database DVD Navi screen appears.

2 Press $\Delta \nabla \triangleleft \triangleright$ to select "LIBRARY", then press **ENTER**.

3 Press $\Delta \nabla \triangleleft \triangleright$ to select the appropriate sort button to sort the information, then press **ENTER**.

4 Press $\triangleleft \triangleright$ to select a program you want to delete, then press ∇ .

5 Press $\Delta \nabla \triangleleft \triangleright$ to select "DELETE", then press **ENTER**.

6 Press $\triangleleft \triangleright$ to select "DELETE", then press **ENTER** to confirm the deletion.

7 Press **NAVIGATION** to return to the normal screen.

Playback With MP3/JPEG Navigation



This unit can play back discs that MP3 sound files and JPEG image files taken with digital still cameras or other devices are recorded.

The MP3/JPEG Navigation enables you to search and select the desired files recorded on CD-R/RW or CD-ROM discs very easily.

The following screen appears as the MP3/JPEG Navigation screen when you press **NAVIGATION**. You can move the arrow to select the desired position on the screen by pressing $\Delta \nabla \triangleleft \triangleright$ on the remote control.

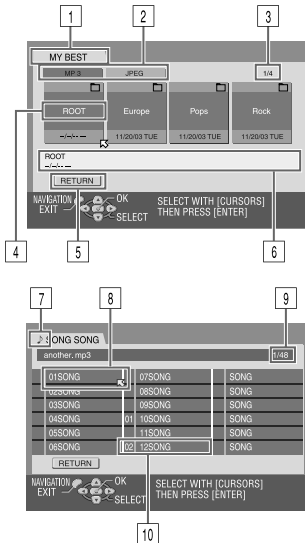

- 1 Name of the inserted disc.
- 2 Sort buttons ("MP3"/"JPEG")
- 3 Selected group number/total number of groups on the disc
- 4 Group name
- 5 Return button ("RETURN")
- 6 Group name/Created date
- 7 File type indicator
 ♪: MP3
 📷: JPEG
- 8 Selected file
- 9 Selected file number/total number of files in the group that contains the selected file
- 10 Program number/file name

Locating The Desired Group And Tracks

- 1 Load a disc.
- 2 Press **NAVIGATION**. The MP3/JPEG Navigation screen appears.
- 3 **For MP3 Playback**
 Press $\triangleleft \triangleright$ to select "MP3". Only groups which contain MP3 files appear.
- 4 **For JPEG Playback**
 Press $\triangleleft \triangleright$ to select "JPEG". Only groups which contain JPEG files appear.

4 Press $\triangleleft \triangleright$ to select the desired group, then press **ENTER**.

For MP3 Playback

- The tracks in the selected group appear.

For JPEG Playback

- The images in the selected group appear.

5 Press $\Delta \nabla \triangleleft \triangleright$ to select the desired item, then press **ENTER**.

The unit starts playback from the selected item.

- The unit stops when all items in the selected group are played back.

NOTES:

- If you press **SELECT** (\blacktriangleright) instead of **ENTER** in step 4, the unit starts playback from the first file of the group.
- JPEG files are played back as a slide show at the set intervals. (pg. 31)
- If a file name includes any 2-byte character, the unit may not show the file name correctly.
- Press $\Delta \nabla$ to select "RETURN", then press **ENTER** to return to the screen that shows the group(s).
- The order of the groups and items shown in steps 4 and 5 may differ from the order shown on your PC.

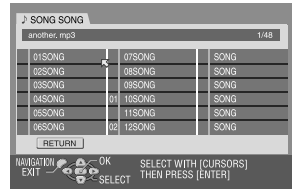
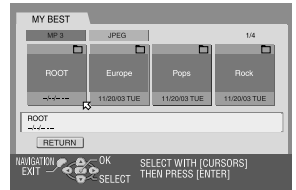

Program Playback

1 Perform steps 1 to 4 of "Locating The Desired Group And Tracks" in the left column before continuing.

2 Press $\Delta \nabla \triangleleft \triangleright$ to select the desired item, then press **MEMO** in the desired order.

- The order number appears on the left of the track name.
- Repeat this step as necessary.
- To cancel the track, press $\Delta \nabla \triangleleft \triangleright$ to select the track, then press **CANCEL**.
- Pressing **CLEAR** (\blacksquare) clears all the order numbers.

3 Press \blacktriangleright to start playback.

- To quit the Program Playback, press \blacksquare .
- Repeat playback can be performed if it is set as such on the on-screen bar. (pg. 29)

NOTES:

- It is not possible to select tracks and images simultaneously.
- It is not possible to select tracks or images in other groups.

On completion of the playback of all the items

1 Perform steps 1 to 4 of "Locating The Desired Group And Tracks" in the left column.

2 Press **CLEAR** (\blacksquare).

- The order numbers are reset and cleared.

3 Press **NAVIGATION** to complete the procedure.

Tape Dubbing (From VCR To DVD)

Because this unit includes both DVD deck and VCR deck, you can easily use this unit for dubbing without connecting any other equipment.

- Turn on the unit.
- Turn on the TV and select the AV mode.
- Slide the **TV/CABLE/DBS/DVD** switch to **DVD**.

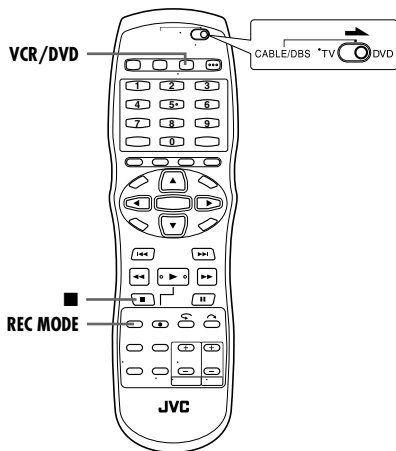
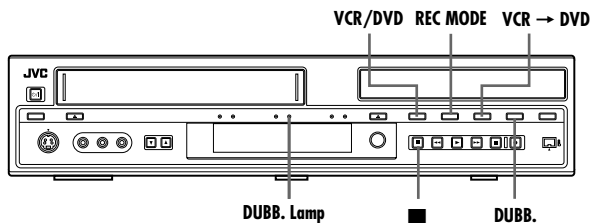

NOTES:

- The superimposed indication during the operation or dubbing is not recorded.
- It is not possible to dub a tape with a copy protection signal.
- If the recording capacity of disc become full, the tape stops automatically.
- It is not possible to perform other operations like Live Memory Playback. Check the recorded program on the disc after dubbing.
- If the index code is found on a tape, a single title is created. While creating a title, the dubbing stops and then starts again.
- When dubbing can not be performed properly, set "BLUE BACK" to "OFF". (pg. 61)

Dubbing An Entire Cassette

- 1 Press **VCR/DVD** repeatedly so that the VCR lamp lights up on the unit.
- 2 Press **SET UP** to access the Main Menu screen.
- 3 Press $\Delta \nabla$ to select "COPY SET", then press **ENTER**.

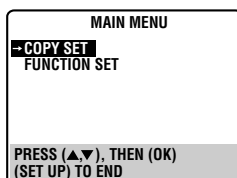

- 4 Press $\Delta \nabla$ to select "FULL DISC", then press **ENTER** to select "OFF".
 - Pressing **ENTER** toggles the setting between on and off.
- 5 Press **SET UP** to complete the setting.

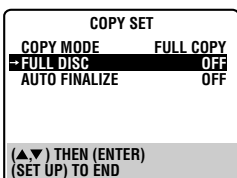

6 Load a cassette you want to dub on the VCR deck, and a recordable disc on the DVD deck.

7 Press **VCR/DVD** repeatedly so that the DVD lamp lights up on the unit.

8 Press **REC MODE** repeatedly to set the recording mode. (pg. 36)

9 Press **VCR -> DVD** to select the dubbing direction. The dubbing (DUBB.) lamp lights up on the unit.

10 Press and hold **DUBB.** for more than 2 seconds to start dubbing. The dubbing (DUBB.) lamp blinks on the unit.

- When dubbing a tape-end recorded VHS tape, set the input of this unit to a no signal input before dubbing.
- If the tape has not been rewound, the VCR deck rewinds the tape automatically. When the VCR deck has finished rewinding, dubbing begins automatically.
- After dubbing is completed, the VCR deck rewinds the tape automatically. Press **VCR -> DVD** to turn off the dubbing (DUBB.) lamp.
- To stop dubbing, press **■**.

Dubbing An Entire Cassette with Just Dubbing

When using the Just Dubbing function, the unit automatically fast-forwards the tape to the end, then rewinds back to the beginning to calculate the total recording time. The unit then automatically sets the appropriate recording mode depending on the total recording time and the available disc space.

1 Press **VCR/DVD** repeatedly so that the VCR lamp lights up on the unit.

2 Perform steps 2 – 3 of "Dubbing An Entire Cassette" in the left column before continuing.

3 Press $\Delta \nabla$ to select "FULL DISC", then press **ENTER** to select "ON".

4 Press **SET UP** to complete the setting.

5 Load a cassette you want to dub on the VCR deck, and a recordable disc on the DVD deck.

6 Press **VCR/DVD** repeatedly so that the DVD lamp lights up on the unit.

7 Press **VCR -> DVD** to select the dubbing direction. The dubbing (DUBB.) lamp lights up on the unit.

8 Press and hold **DUBB.** for more than 2 seconds to start dubbing. The dubbing (DUBB.) lamp blinks on the unit.

- When dubbing a tape-end recorded VHS tape, set the input of this unit to a no signal input before dubbing.
- After dubbing is completed, the VCR deck rewinds the tape automatically. Press **VCR -> DVD** to turn off the dubbing (DUBB.) lamp.
- To stop dubbing, press **■**.

Auto Finalizing

When dubbing to a DVD-R/RW (Video mode) disc, you can select whether to finalize the disc automatically after dubbing has been completed.

To automatically finalize the disc after dubbing:

- 1 Perform steps 1 – 3 of "Dubbing An Entire Cassette" in the left column before continuing.
- 2 Press $\Delta \nabla$ to select "AUTO FINALIZE", then press **ENTER** to select "ON".
- 3 Press **SET UP** to complete the setting.

NOTE:

It is possible to set the operation method of a DVD-R/RW (Video mode) disc when finalizing the disc. Each time the finalized disc is played back, it will be played back in accordance to the setting you have selected during finalization. For details, refer to "Finalize A DVD-R/RW Disc" (pg. 63).

Manual Dubbing (From VCR To DVD)

Dubbing A Part Of A Cassette

You can dub the selected scenes on a tape to the DVD disc, starting and stopping wherever you wish.

- Turn on the unit.
- Turn on the TV and select the AV mode.
- Slide the **TV/CABLE/DBS/DVD** switch to **DVD**.

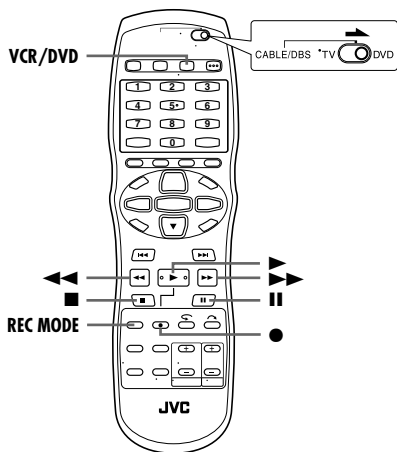
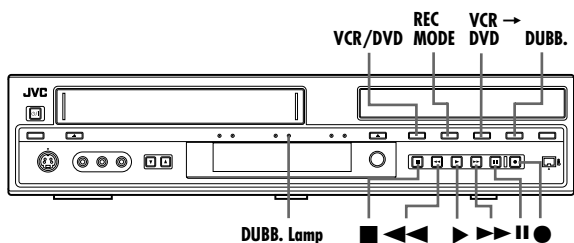

NOTES:

- There may be a discrepancy of several seconds between where you intend dubbing to start, and where it actually starts.
- The superimposed indication during the operation or dubbing is not recorded.
- It is not possible to dub a tape with a copy protection signal.
- If the recording capacity of disc become full, the tape stops automatically.
- It is not possible to perform other operations like Live Memory Playback. Check the recorded program on the disc after dubbing.
- When dubbing can not be performed properly, set "BLUE BACK" to "OFF". (pg. 61)

- 1 Press **VCR/DVD** repeatedly so that the VCR lamp lights up on the unit.
- 2 Press **SET UP** to access the Main Menu screen.
- 3 Press $\Delta \nabla$ to select "COPY SET", then press **ENTER**.

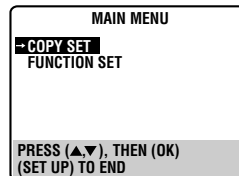

- 4 Press $\Delta \nabla$ to select "COPY MODE", then press **ENTER** to select "FULL COPY" or "1 PROG.".

- Pressing **ENTER** toggles the setting between "FULL COPY" and "1 PROG.".

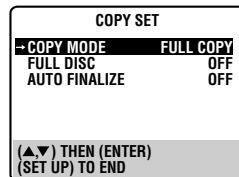

- 5 Press **SET UP** to complete the setting.

- When "1 PROG." is selected, recording will stop when an index code or unrecorded portion is detected.

- 6 Load a cassette you want to dub on the VCR deck, and a recordable disc on the DVD deck.

- 7 Press **VCR -> DVD** to select the dubbing direction. The dubbing (DUBB.) lamp lights up on the unit.

- 8 Locate the point from where you want to start dubbing, then pause playback by pressing the following buttons: **▶**, **▶▶**, **◀◀**, **■**, **||**

- 9 Prepare the DVD deck for dubbing.

- 1 Press **VCR/DVD** repeatedly so that the DVD lamp lights up on the unit.

- 2 Press **REC MODE** repeatedly to set the recording mode. (pg. 36)

- 3 Press **●** and **||** simultaneously so that the DVD deck enters the Record Pause mode.

- 10 Press and hold **DUBB.** for more than 2 seconds to start dubbing. The dubbing (DUBB.) lamp blinks on the unit.

- When dubbing a tape-end recorded VHS tape, set the input of this unit to a no signal input before dubbing.
- To stop dubbing, press **■**.
- Upon completing dubbing, dubbing ends automatically even without pressing **■**. Press **VCR -> DVD** to turn off the dubbing (DUBB.) lamp.

Disc Dubbing (From DVD To VCR)

Dubbing An Entire Disc

Because this unit includes both DVD deck and VCR deck, you can easily use this unit for dubbing without connecting any other equipment.

- Turn on the unit.
- Turn on the TV and select the AV mode.
- Slide the **TV/CABLE/DBS/DVD** switch to **DVD**.

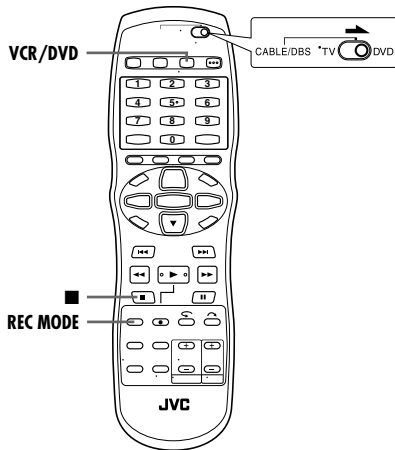
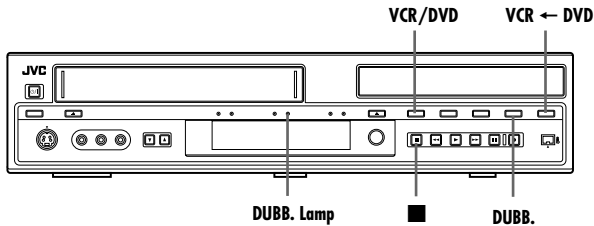

- 1 Load a disc you want to dub on the DVD deck, and a cassette with the record safety tab intact on the VCR deck.
- 2 Press **VCR/DVD** repeatedly so that the VCR lamp lights up on the unit.
- 3 Press **REC MODE** repeatedly to set the recording mode. (☞ pg. 36)
- 4 Press **VCR ← DVD** to select the dubbing direction. The dubbing (DUBB.) lamp lights up on the unit.
- 5 Press and hold **DUBB.** for more than 2 seconds to start the dubbing. The dubbing (DUBB.) lamp blinks on the unit.
 - If the tape has not been rewound, the VCR deck rewinds the tape automatically. When the VCR deck has finished rewinding, dubbing begins automatically.
 - After dubbing is completed, the VCR deck rewinds the tape automatically. Press **VCR ← DVD** to turn off the dubbing (DUBB.) lamp.
 - To stop dubbing, press ■.

NOTES:

- It is not possible to start dubbing if the unit retains a memory of the resume points. Press ■ twice to clear the resume points.
- There may be a discrepancy of several seconds between where you intend dubbing to start, and where it actually starts.
- If you do not want the superimposed indication to be recorded, set "SUPERIMPOSE" to "OFF" before dubbing. (☞ pg. 59)
- When the end of the tape is reached during dubbing, the tape is ejected and both deck stops.
- It may be impossible to dub a DVD-R or DVD-RW (Video mode) disc recorded on the devices from other manufacturers or on a PC. In such case, perform "Manual Dubbing (From DVD To VCR)" (☞ pg. 49).
- It is not possible to perform other operations like Live Memory Playback. Check the recorded program on the disc after dubbing.

Manual Dubbing (From DVD To VCR)

Dubbing A Part Of A Disc

You can dub the selected scenes on a DVD disc to the tape, starting and stopping wherever you wish.

- Turn on the unit.
- Turn on the TV and select the AV mode.
- Slide the **TV/CABLE/DBS/DVD** switch to **DVD**.

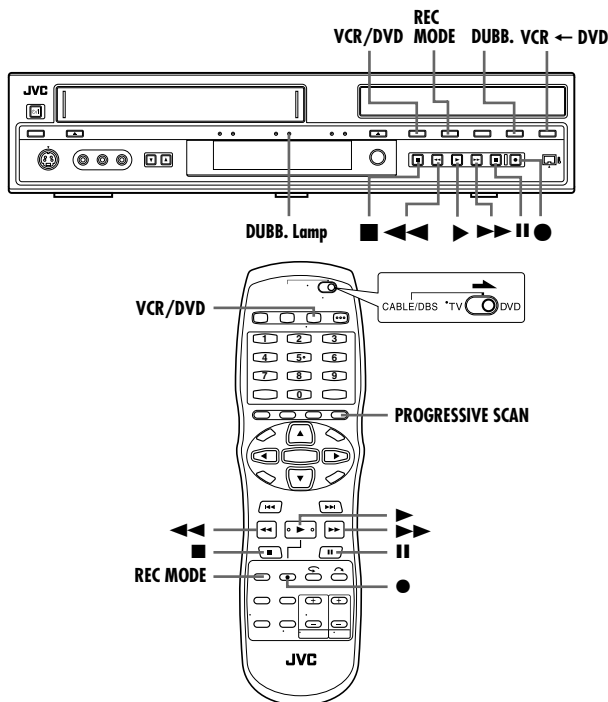

1 Load a disc you want to dub on the DVD deck, and a cassette with the record safety tab intact on the VCR deck.

2 Press **VCR←DVD** to select the dubbing direction. The dubbing (DUBB.) lamp lights up on the unit.

3 Prepare the DVD deck for dubbing.

1 Press **VCR/DVD** repeatedly so that the DVD lamp lights up on the unit.

2 Locate the point from where you want to start dubbing, then pause playback by pressing the following buttons: **▶**, **▶▶**, **◀◀**, **■**, **||**

4 Prepare the VCR deck for dubbing.

1 Press **VCR/DVD** repeatedly so that the VCR lamp lights up on the unit.

2 Press **REC MODE** repeatedly to set the recording mode. (pg. 36)

3 Press **●** and **||** simultaneously so that the VCR deck enters the Record Pause mode.

5 Press and hold **DUBB.** for more than 2 seconds to start the dubbing. The dubbing (DUBB.) lamp blinks on the unit.

6 Press **■** to stop recording on the VCR deck. Then press **VCR/DVD**, and press **■** to stop playback on the DVD deck.

• Press **VCR←DVD** to turn off the dubbing (DUBB.) lamp.

NOTES:

- It is not possible to start dubbing if the unit retains a memory of the resume points. Press **■** twice to clear the resume points.
- There may be a discrepancy of several seconds between where you intend dubbing to start, and where it actually starts.
- If you do not want the superimposed indication to be recorded, set "SUPERIMPOSE" to "OFF" before dubbing. (pg. 59)
- When the end of the tape is reached during dubbing, the tape is ejected and both deck stops.
- When the progressive mode is set, the dubbing (DUBB.) lamp does not light up on the front display panel. Press **PROGRESSIVE SCAN** so that video output indicator (P) lights off on the front display panel.
- It is not possible to perform other operations like Live Memory Playback. Check the recorded program on the disc after dubbing.

Program Dubbing (From DVD to VCR)

Dubbing The Desired Programs On A Disc

You can select and dub your desired programs on a DVD disc to the tape.

- Turn on the unit.
- Turn on the TV and select the AV mode.
- Slide the **TV/CABLE/DBS/DVD** switch to **DVD**.

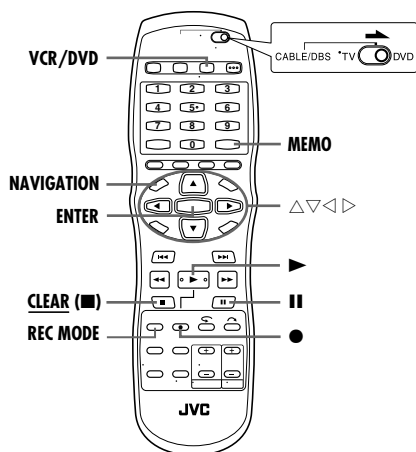
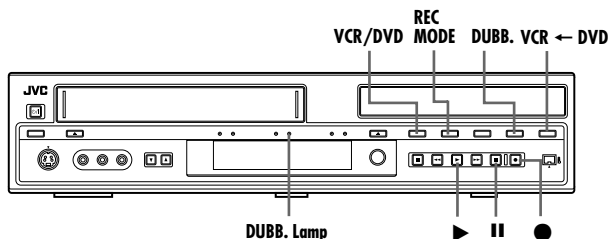

1 Load a disc you want to dub on the DVD deck, and a cassette with the record safety tab intact on the VCR deck.

2 Press **VCR←DVD** to select the dubbing direction. The dubbing (DUBB.) lamp lights up on the unit.

3 Prepare the DVD deck for dubbing.

1 Press **VCR/DVD** repeatedly so that the DVD lamp lights up on the unit.

2 Press **NAVIGATION** to access the Library Database DVD Navi screen.

3 Press **△▽◀▶** to select "ORIGINAL", then press **ENTER**.

4 Press **◀▶** to select the desired program, then press **MEMO**.

• Select the programs in the order that you want them to be dub. The numbers of the playback order appear on the index. You can select up to 30 programs.

• If you have specified a wrong selection, press **MEMO**. The number disappears.

• When you want to clear all the numbers, press **CLEAR (■)**.

4 Press **▶** to locate the point where you want dubbing to start, then press **||** to pause playback.

5 Prepare the VCR deck for dubbing.

1 Press **VCR/DVD** repeatedly so that the VCR lamp lights up on the unit.

2 Press **REC MODE** repeatedly to set the recording mode. (☞ pg. 36)

3 Press **●** and **||** simultaneously so that the VCR deck enters the Record Pause mode.

6 Press and hold **DUBB.** for more than 2 seconds to start the dubbing. The dubbing (DUBB.) lamp blinks on the unit.

• Playback on the DVD deck and recording on the VCR deck starts at the same time.

• When all the selected programs have been dubbed, playback on the DVD deck and recording on the VCR deck stops automatically at the same time. Press **VCR←DVD** to turn off the dubbing (DUBB.) lamp.

NOTES:

• The program memory remains even after dubbing is completed. To clear the memory, access the Library Database DVD Navi screen and press **CLEAR (■)**.

• When locating the point where you want dubbing to start, be sure to press **▶** then press **||**. There should be at least a one-second interval when pressing these two buttons.

• If you do not want the superimposed indication to be recorded, set "SUPERIMPOSE" to "OFF" before dubbing. (☞ pg. 59)

DV Dubbing (DVD Deck Only)

You can dub programs from a DV camcorder or DV equipment connected to the unit with a DV cable. The unit's remote control allows you the limited control of the connected DV camcorder or DV equipment functions during dubbing.

NOTES:

- Use the DV cable VC-VDV 204U for connection.
- When you connect a PC to the [DV IN] connector, we do not assure the normal operation of this unit.

Your unit

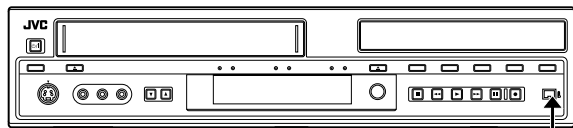

To [DV IN]

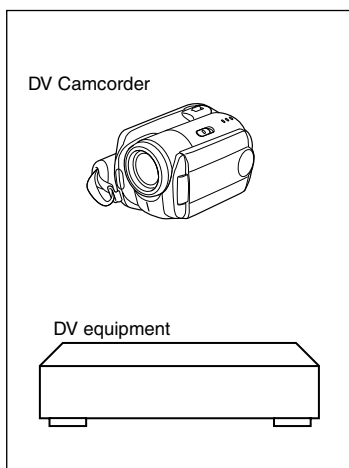

DV cable
(VC-VDV 204U)
(not supplied)

DV connector

- 1 Connect a DV camcorder or DV equipment to the [DV IN] connector on the unit's front panel.
- 2 Load a DVD-RAM/RW/R disc on the unit.
- 3 Press **VCR/DVD** repeatedly so that the DVD lamp lights up on the unit.
- 4 Press **INPUT SELECT +/-** on the unit or **INPUT +/-** on the remote control to set the input to "DV".
 - The "DV DUBBING" controller appears on the TV screen.
 - If "CAM" does not appear on the "DV DUBBING" controller, make sure the DV equipment is connected correctly.
- 5 Press **REC MODE** repeatedly to set the recording mode. (pg. 36)
- 6 Locate the point from where you want to start dubbing, then stop or pause playback by pressing the following buttons on the remote control: **▶▶▶**, **◀◀◀**, **■**, **||**
 - To play back in slow speed (1/10 of the normal speed), press **||** to pause playback, then press **◀◀◀** or **▶▶▶**.
 - To play back frame-by-frame, press **||** to pause playback, then press **||** repeatedly. Each press of **||** advances a frame.
 - To change the playback direction, press **◀◀◀** or **▶▶▶**.
- 7 Press **◀▷** to select **AUDIO 1**, then press **ENTER**.
- 8 Press **△▽** to select the desired sound track, then press **ENTER**.

AUDIO 1: Select this to record the original stereo sound played back on the connected DV equipment.

AUDIO 2: Select this to record the dubbed stereo sound played back on the connected DV equipment.

MIX: Select this to record the sound of both "AUDIO 1" and "AUDIO 2".

- Note that this selection is not available when the source program is recorded in 16BIT (48 kHz) mode.

- 9 Press **◀▷** to select **DV DUBBING**, then press **ENTER**. The dubbing starts.
 - Playback on the external DV equipment and recording on the unit should start simultaneously.
 - When the playback from the beginning is not possible, the "DV DUBBING" controller cannot be used. Perform dubbing without using the "DV DUBBING" controller. (pg. below)
 - To pause dubbing, press **◀▷** to select **DV DUBBING**, then press **ENTER**. Both the unit and the external DV equipment pause dubbing. Pressing **||** on the unit also works the same way.
 - To clear the "DV DUBBING" controller from the TV screen, press **ON SCREEN**.

- 10 Press **■** on the remote control to stop dubbing.
 - Both the unit and the external DV equipment stop dubbing.

NOTES:

- Dubbing copyright guarded programs is not possible.
- Original DV information such as the recording date and time are not recorded.
- The superimposed indication during the operation or dubbing is not recorded.
- It is not possible to perform dubbing when the dubbing (DUBB.) lamp lights up on the unit. Press **VCR→DVD** so that the dubbing (DUBB.) lamp lights off.

Performing dubbing without using the "DV DUBBING" controller

- 1 Press **INPUT SELECT +/-** on the unit or **INPUT +/-** on the remote control to set the input to "DV".
- 2 Press **REC MODE** repeatedly to set the recording mode. (pg. 36)
- 3 Start playback on the external DV equipment slightly before the actual point from where you wish to start dubbing.
- 4 Press **●** on the unit to start recording. Or while holding **●**, press **▶** on the remote control. The dubbing starts.
- 5 When the dubbing ends, press **■** on the unit, then stop playback on the external DV equipment.

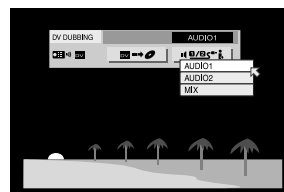

Edit From A Camcorder

You can use a camcorder as the source player and your unit as the recording deck.

1 If the camcorder has no S-VIDEO output connector:

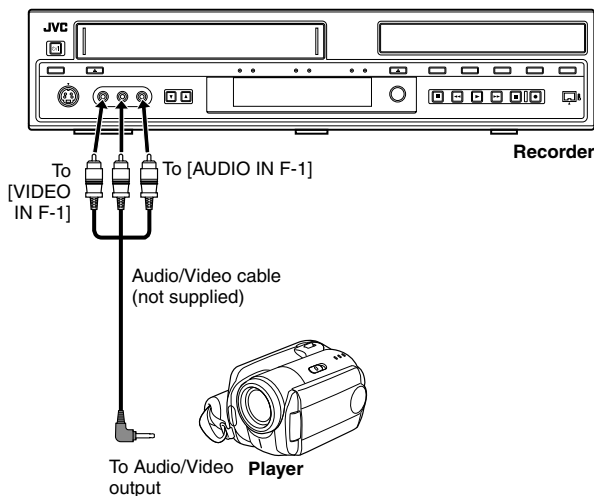

2 If the camcorder has an S-VIDEO output connector:

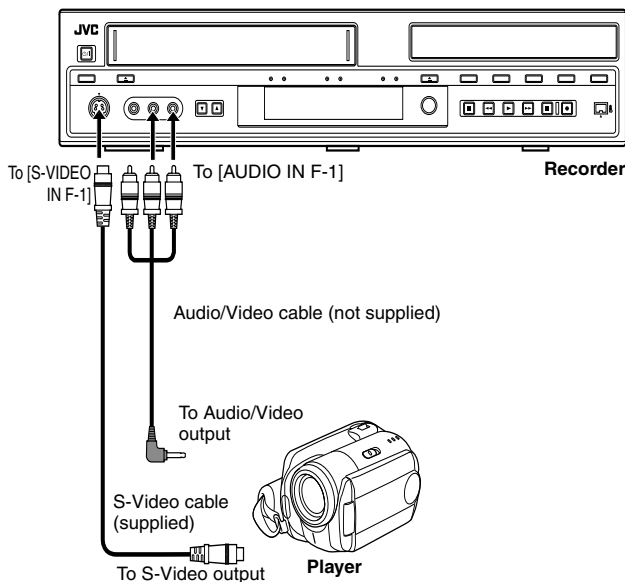

Slide the TV/CABLE/DBS/DVD switch to **DVD**.

1 Make connections.

1 If the camcorder has no S-VIDEO output connector:
— connect the camcorder's Audio/Video output connector to the unit's [AUDIO IN F-1] and [VIDEO IN F-1] input connectors on the front panel.

• When using a monaural camcorder, connect its AUDIO OUT connector to the [AUDIO L] input connector on your unit.
2 If the camcorder has an S-VIDEO output connector:
— connect the camcorder's Audio/Video output and S-Video output connectors to the unit's [AUDIO IN F-1] and [S-VIDEO IN F-1] connectors on the front panel.

2 Press **VCR/DVD** repeatedly to select the recording deck.

3 Press **INPUT SELECT +/-** on the unit or **INPUT +/-** on the remote control to select "F-1".

• Set "FRONT AUX F-1" to "VIDEO" for the [VIDEO IN F-1] connector, or "S-VIDEO" for the [S-VIDEO IN F-1] connector, depending on the connector being used. (ⓘ pg. 59) This setting is also applied to the VCR deck.

4 For VCR deck only

Set "PICTURE CONTROL" to the appropriate mode. (ⓘ pg. 61)

5 Press **REC MODE** repeatedly to set the recording mode. (ⓘ pg. 36)

6 Start playback on the camcorder slightly before the actual point from where you wish to start dubbing.

For VCR deck only

Press ● and II simultaneously to set to record pause mode.

7 Press ● on the unit to start recording. Or while holding ●, press ► on the remote control. The dubbing starts.

For VCR deck only

After about 10 seconds, press ► to start recording.

8 Press ■ on the unit, then stop playback on the camcorder.

NOTES:

- All necessary cables can be obtained from your dealer.
- Refer to the camcorder's instruction manual for operating procedure.
- The quality of dubbed picture becomes poorer than that of the original.
- When you select "EDIT" to dub tapes in step 4, be sure to select "AUTO" (or "NORM" when "VIDEO CALIBRATION" is set to "OFF") after you finish dubbing the tapes.

Edit To Or From Another Recorder

You can use your unit as the source player or as the recording deck.

NOTE:

When using another recorder as the recording deck, refer to its instruction manual.

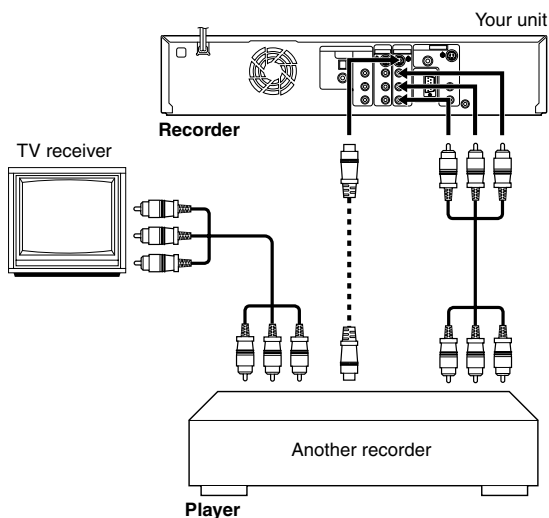

Slide the TV/CABLE/DBS/DVD switch to **DVD**.

1 Make connections.

When using this unit as the recording deck

1 If the another recorder has no S-VIDEO connector, connect the unit's [AUDIO/VIDEO INPUT] connectors to the audio/video output connectors on another recorder.

2 If the another recorder has S-VIDEO connector, connect the [AUDIO INPUT] and [S-VIDEO INPUT] connectors to the audio and S-video output connectors on another recorder.

- If connecting a unit with an S-VIDEO connector, it is recommended to use the supplied S-Video cable to minimize picture degradation while editing.

2 Press **VCR/DVD** repeatedly to select the recording deck.

3 Press **INPUT SELECT +/-** on the unit or **INPUT +/-** or **AUX** on the remote control to select "L-1" when using this unit as the recording deck.

- Set "REAR AUX L-1" to "VIDEO" for the [VIDEO INPUT] connector, or "S-VIDEO" for the [S-VIDEO INPUT] connector, depending on the connector being used. (☞ pg. 59) This setting is also applied to the VCR deck.

4 For VCR deck only

Set "PICTURE CONTROL" to the appropriate mode. (☞ pg. 61)

5 Press **REC MODE** repeatedly to set the recording mode. (☞ pg. 36)

6 Engage the Play mode of the source player.

For VCR deck only

Press ● and II simultaneously to set to record pause mode.

7 Engage the Record mode of the recording deck.

For VCR deck only

After about 10 seconds, press ► to start recording.

8 Stop recording on the recording deck, then stop playback on the source player.

NOTES:

- All necessary cables can be obtained from your dealer.
- When you use this unit as the source player for editing, be sure to set "SUPERIMPOSE" to "OFF" before starting. (☞ pg. 59)
- When you select "EDIT" to dub tapes in step 4, be sure to select "AUTO" (or "NORM" when "VIDEO CALIBRATION" is set to "OFF") after you finish dubbing the tapes.

Digital Audio Dubbing

You can dub selected audio from a DVD or Audio CD disc to a digital audio device.

However, it is not possible to dub copy-protected discs.

- Turn on the TV and select the AV mode.
- Slide the **TV/CABLE/DBS/DVD** switch to **DVD**.

Example: Dubbing to an MD

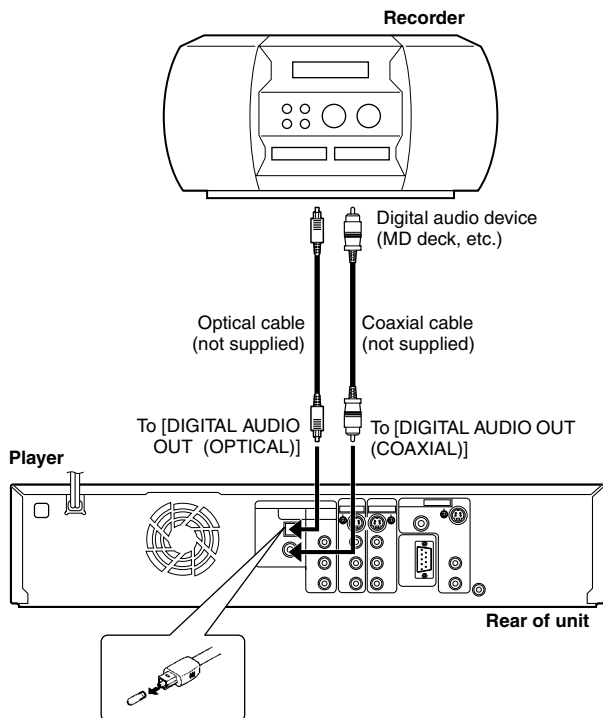

Note for connection:
Remove the protection cap from the cable.

- 1** Connect the unit and a digital audio device using either an optional optical cable or an optional coaxial cable.
- 2** Place a disc on the unit and load an MD on the connected digital audio device.
- 3** Select the audio to be dubbed.
- 4** Start playback slightly before the actual point from where you wish to start dubbing.
- 5** Press **II** to pause playback.
- 6** Select the input mode on the connected digital audio device.
- 7** Press **▶** to start playback on the unit.
- 8** Start recording on the digital audio device.
- 9** Stop recording on the digital audio device. Then press **■** to stop playback on the unit.

NOTE:

There may be a discrepancy of several seconds between where you intend editing to start, and where it actually starts.

Remote Control Functions

Remote control 1/2/3/4 Code Switching

The remote control is capable of controlling four JVC video units independently. Each of the units can respond to one of four codes (1, 2, 3 or 4). The remote control is preset to send 3 code signals because your unit is initially set to respond to 3 code signals. You can easily modify your unit to respond to 1, 2 or 4 code signals.

Slide the **TV/CABLE/DBS/DVD** switch to **DVD**.

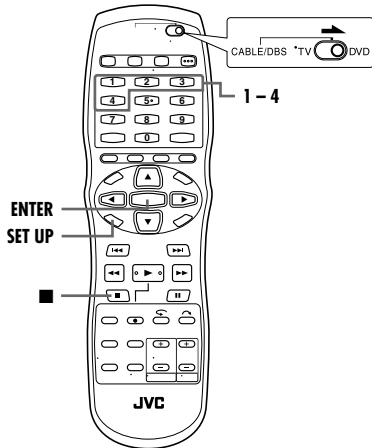
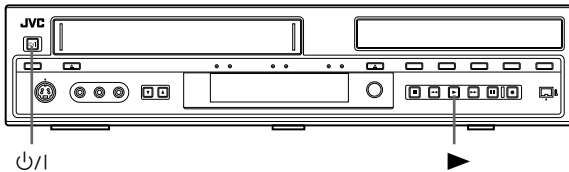

- Keep pressing **SET UP** down during step 1.
- 1** Press the **number key "1"** for 1, **"2"** for 2, **"3"** for 3 or **"4"** for 4 to change the remote control code, then press **ENTER**.
- 2** Press **power** on the unit to turn off the unit.
- 3** Press **right arrow** on the unit for over 5 seconds while the unit is turned off. The current code appears on the front display panel.
- 4** Press **square** on the remote control to change the unit's code. The new code currently set on the remote control blinks on the front display panel for approximately 5 seconds, and is applied to the unit.

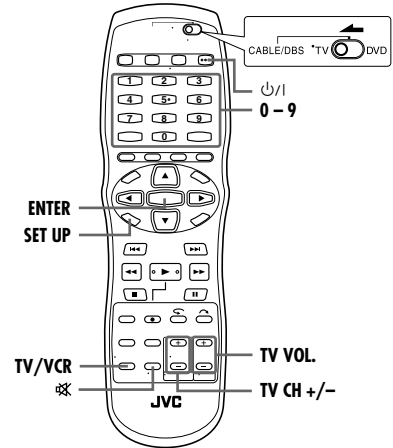

TV Multi-Brand Remote Control

Your remote control can operate the basic functions of your TV set. In addition to JVC TVs, other manufacturer's TVs can also be controlled.

- Turn off the TV using its remote control.
- Slide the **TV/CABLE/DBS/DVD** switch to **TV**.

IMPORTANT:

Although the supplied remote control unit is compatible with JVC televisions, as well as many other models, it may not work with your TV, or in some instances, may have limited function capability.

- Keep pressing **SET UP** down during step 1.
- 1** Enter your TV's brand code using the **number keys**, then press **ENTER**.
- 2** Press **power** on the unit's remote control to turn on the TV and try operations (see step 3).
- Once you have set the remote control to operate the TV, you do not have to repeat this step until you replace your remote control's batteries.
- Some brands of TVs have more than one code. If the TV does not function with one code, try entering another.
- 3** Press the corresponding button to operate the TV: **power**, **TV/VCR**, **TV CH +/-**, **TV VOL.**, **TV Muting**, **number keys**.
- For some brands of TVs, you must press **ENTER** after having pressed the **number keys**.

BRAND NAME	CODE
JVC	01, 03
HITACHI	10
MAGNAVOX	02
MIITSUBISHI	03
PANASONIC	04, 11
RCA	05
SHARP	06
SONY	07
SAMSUNG	12
SANYO	13
SEARS	13
TOSHIBA	08
ZENITH	09

Cable Box Or DBS Receiver Multi-Brand Remote Control

Your remote control can operate the basic functions of your cable box or DBS (Direct Broadcast Satellite) receiver set. In addition to JVC cable boxes or DBS receivers, other manufacturer's cable boxes or DBS receiver can also be controlled.

Slide the **TV/CABLE/DBS/DVD** switch to **CABLE/DBS**.

- Keep pressing **SET UP** down during step 1.

1 Enter your cable box or DBS receiver's brand code using the **number keys**, then press **ENTER**.

2 Press $\psi/1$ on the unit's remote control to turn on the cable box or DBS receiver and try operations (➡ step 3).

- Once you have set the remote control to operate the cable box or DBS receiver, you do not have to repeat this step until you replace your remote control's batteries.
- Some brands of cable box or DBS receiver have more than one code. If the cable box or DBS receiver does not function with one code, try entering another.

3 Press the corresponding button to operate the cable box or DBS receiver: $\psi/1$, **TV CH +/-**, **number keys**.

- For some brands of cable box, you must press **ENTER** after having pressed the **number keys**.
- The **number keys** may not function with some cable boxes.

IMPORTANT:

It may not work with your cable box, or in some instances, may have limited function capability.

NOTES:

- It's not possible to operate a cable box or DBS receiver that is not equipped with a receiving window.
- It's not possible to set the remote control for both your cable box and a DBS receiver at the same time. You can only set the remote control to operate one of these units at a time.

CABLE BOX BRAND	CODE
ARCHER	01, 05, 17
CABLETENNA	01, 17
CABLEVIEW	15, 16, 17, 21, 25
CITIZEN	15, 16, 17, 21, 25
CURTIS	02
DIAMOND	01, 17
GC BRAND	15, 16, 17, 21, 25
GEMINI	15
GENERAL INSTRUMENTS	01, 04, 06, 11, 12, 15, 28
HAMLIN	10, 18, 23
JASCO	15
JERROLD	01, 04, 06, 11, 12, 15, 28
NOVAVISION	02
OAK	07
PANASONIC	13, 14
PULSER	15, 16, 17, 21, 25
RCA	13, 14
REGAL	10, 18, 23
REMBRANDT	01, 16, 17
SAMSUNG	05, 16, 24
SCIENTIFIC ATLANTA	02
SIGMA	07
SL MARX	05, 16, 17, 24, 25
SPRUCER	13, 14
STARGATE	05, 15, 16, 17, 21, 24, 25
TELEVIEW	05, 16, 24
TOCOM	01, 04, 16
UNIKA	01, 17
UNIVERSAL	16, 17, 25
VIDEOWAY	03, 09, 22
ZENITH	03, 09, 22

DBS RECEIVER BRAND	CODE
JVC (DISH Network)	51
ECHOSTAR (DISH Network)	51
SONY (DSS)	41
RCA (DSS)	40

Connecting To A Dolby Digital Decoder Or An Amplifier With Built-in DTS

These instructions enable you to connect your unit to a Dolby Digital decoder or an amplifier with built-in DTS.

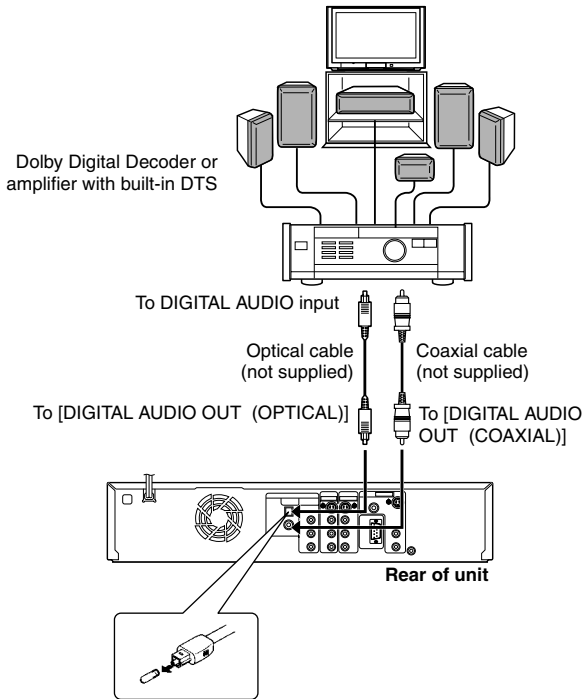

1 Connect the unit and a Dolby Digital decoder or an amplifier with built-in DTS using either an optional optical cable or an optional coaxial cable.

NOTES:

- For Dolby Digital sound, set "DIGITAL AUDIO OUT" to "DOLBY DIGITAL/PCM". (☞ pg. 58)
- For DTS sound, set "DIGITAL AUDIO OUT" to "STREAM/PCM". (☞ pg. 58)

CAUTIONS:

- This unit has a dynamic range of more than 110 dB with regards to its Hi-Fi audio capability. It is recommended that you check the maximum level if you are going to listen to the Hi-Fi audio signals through a stereo amplifier. A sudden surge in the input level to the speakers may damage them.
- Some speakers and televisions are specially shielded to prevent television interference. If both are of the non-shielded type, do not place the speakers adjacent to the TV set as this can adversely affect the playback picture.

Mode Set (DVD Deck)

- Turn on the unit.
- Turn on the TV and select the AV mode.
- Slide the **TV/CABLE/DBS/DVD** switch to **DVD**.

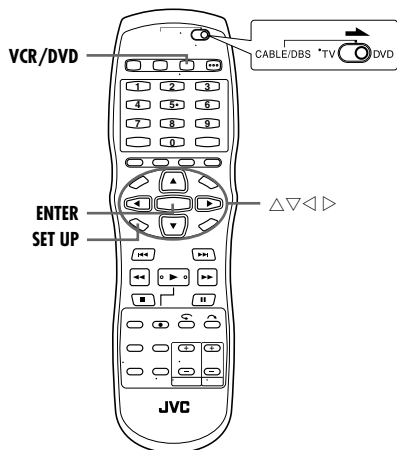

Various modes of this unit are categorized into menus nested in 2 levels shown in the following table. To change the settings of these modes, find the desired mode in the menu (for details on each menu, see pages 58 through 59), then follow the procedure below.

DVD SET UP	LANGUAGE SET (↗ pg. 18) AUDIO OUTPUT (↗ pg. 58) UTILITY (↗ pg. 32, 62, 63, 64)
FUNCTION SET UP	VIDEO IN/OUT (↗ pg. 19, 59) RECORDING SET (↗ pg. 59) DISPLAY SET (↗ pg. 59) OTHERS (↗ pg. 59)
INITIAL SET UP	CLOCK SET (↗ pg. 17)

- The procedure below shows how to set the desired option of the “DV AUTO CHAPTER” mode as an example.

- 1 Press **VCR/DVD** repeatedly so that the DVD lamp lights up on the unit.
- 2 Press **SET UP** to access the Main Menu screen.
- 3 Press $\triangleleft \triangleright$ to select “FUNCTION SET UP”, then press **ENTER**.
- 4 Press $\triangleleft \triangleright$ to select “RECORDING SET”, then press **ENTER**.
- 5 Press $\triangle \nabla$ to select “DV AUTO CHAPTER”, then press **ENTER**.

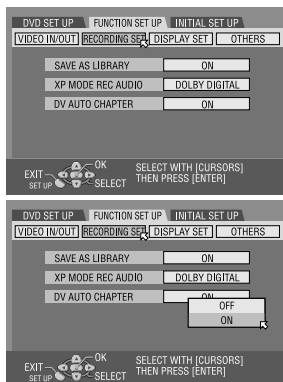

- 6 Press $\triangle \nabla$ to select the desired option, then press **ENTER**.
- 7 Press **SET UP** to complete the setting.

* The **boldface** settings below indicate the settings at your purchase.

AUDIO OUTPUT

■ DIGITAL AUDIO OUT — DOLBY DIGITAL/PCM / **STREAM/PCM** / PCM ONLY

Set to the appropriate mode according to the type of the device connected to [DIGITAL AUDIO OUT] connector.

DOLBY DIGITAL/PCM: Select this when you connect the digital input connector of a Dolby Digital decoder or an amplifier with a built-in Dolby Digital decoder.

STREAM/PCM: Select this when you connect the digital input connector of an amplifier with a built-in DTS, Dolby Digital, or MPEG multichannel decoder.

PCM ONLY: Select this when you connect the linear PCM digital input of other audio equipment (amplifier, MD or DAT deck, etc.).

■ ANALOG AUDIO OUT — **STEREO** / DOLBY SURROUND

Select the appropriate setting to accommodate the unit to the connected A/V equipment. This function takes effect when a DVD VIDEO disc is played back.

STEREO: Select this when listening to conventional two-channel stereo audio with the unit's [AUDIO OUTPUT] connectors connected to a stereo amplifier/receiver or TV set, or in case you want to record the audio from a DVD VIDEO disc to a Mini Disc, etc.

DOLBY SURROUND: Select this when listening to multichannel surround audio with the unit's [AUDIO OUTPUT] connectors connected to an amplifier/receiver with a built-in surround decoder or a surround decoder.

■ D. RANGE CONTROL — **NORMAL** / WIDE RANGE / TV MODE

The dynamic range (the difference between the loudest sound and the quietest one) can be compressed during playback of a program encoded in Dolby Digital format.

This function takes effect when a DVD VIDEO disc recorded in Dolby Digital format is played back at low or middle volume.

NORMAL: Normally select this setting to activate this function.

WIDE RANGE: Select this to deactivate this function when you enjoy wide dynamic range program.

TV MODE: Select this when you hear the sound through the TV's speaker(s).

NOTES:

- This function takes no effect on programs other than that recorded in Dolby Digital format.
- This function does not work when Simulated Surround Effect is activated. (↗ pg. 30)
- The effect of “NORMAL” and “WIDE RANGE” may not be different depending on discs.

■ OUTPUT LEVEL — **STANDARD** / LOW

You can lower the output level of analog audio to accommodate the unit to the connected A/V equipment.

STANDARD: Normally select this setting.

LOW: The output level of analog audio is lowered.

VIDEO IN/OUT

■ MONITOR TYPE — 4:3LB / 4:3PS / 16:9AUTO / 16:9FIX

You can select the monitor type depending on the TV used when you play back DVD VIDEO discs recorded for wide-screen TVs. For details, refer to "Monitor Set (DVD Deck Only)" (ⓘ pg. 19).

■ FRONT AUX F-1 — VIDEO / S-VIDEO

Select the appropriate mode depending on the connector (F-1) being used on the front panel.

VIDEO: To use the [VIDEO IN F-1] connector on the front panel.

S-VIDEO: To use the [S-VIDEO IN F-1] input connector on the front panel.

NOTE:

This setting is also applied to the VCR deck.

■ REAR AUX L-1 — VIDEO / S-VIDEO

Select the appropriate mode depending on the connector (L-1) being used on the rear panel.

VIDEO: To use the [VIDEO INPUT] connector on the rear panel.

S-VIDEO: To use the [S-VIDEO INPUT] connector on the rear panel.

NOTE:

This setting is also applied to the VCR deck.

RECORDING SET

■ SAVE AS LIBRARY — OFF / ON

When this function is set to "ON", the recording information is automatically stored in the library. For details, refer to "Edit Library Information" (ⓘ pg. 44).

■ XP MODE REC AUDIO — DOLBY DIGITAL / LINEAR PCM

You can select the audio format when you record a program in XP mode. When this function is set to "LINEAR PCM", you can obtain a high-quality audio sound.

DOLBY DIGITAL: To record in Dolby Digital format.

LINEAR PCM: To record in Linear PCM format.

■ DV AUTO CHAPTER — OFF / ON

When this function is set to "ON", you can create chapters (marks) when dubbing via the DV input terminal connecting the external DV camcorder.

DISPLAY SET

■ SUPERIMPOSE — OFF / AUTO

When this function is set to "AUTO", various operational indicators appear on the TV screen.

OFF: To turn off superimposed indications.

AUTO: To superimpose operational indications for approximately five seconds just after the corresponding operation.

NOTES:

- Even when "SUPERIMPOSE" is set to "OFF", you can display the various operational indicators by pressing **ON SCREEN**. To clear the operational indicators, press **ON SCREEN** again.
- When you use this unit as the source player for editing, be sure to set "SUPERIMPOSE" to "OFF" before starting. (ⓘ pg. 53)
- When you select "AUTO", during playback, the operation mode indicators may be disturbed depending on the type of disc being used.

■ GRAY BACK — OFF / ON

When this function is set to "ON", the TV screen becomes all gray when there is no signal input from the external input.

NOTE:

When you want to receive an unstable external input with poor signals, set this function to "OFF".

■ DIMMER — BRIGHT / DIM

You can change the brightness of the front display panel.

BRIGHT: Normally select this.

DIM: To dim the front display panel.

■ POWER SAVE — OFF / ON

When this function is set to "ON", you can reduce the power consumption while the unit is turned off.

NOTES:

- During Power Save mode, it is not possible to engage the Tray Lock function. (ⓘ pg. 65)
- It takes some time for the unit to complete initialization after you turn on unit power, with "WAKE UP" blinking on the front display panel.
- When "POWER SAVE" is set to "OFF", the cooling fan on the rear of the unit may be activated even if the unit is turned off.

■ ON SCREEN LANGUAGE

This unit offers you the choice to view on screen messages in 3 different languages.

For details, refer to "On-screen Language Set" (ⓘ pg. 18).

OTHERS

■ RESUME — OFF / ON / DISC RESUME

When this function is set to "ON" or "DISC RESUME", you can use the resume function. (ⓘ pg. 22)

OFF: You cannot use the resume function.

ON: You can start playback from the resume point of the placed disc.

DISC RESUME: The unit retains a memory of the resume points of the last 30 discs played back, even though they have been ejected.

NOTE:

"DISC RESUME" setting works on DVD VIDEO, VCD and already finalized DVD-R/DVD-RW (video mode) discs. For other types of discs, the function under "ON" setting will be applied even if "RESUME" is set to "DISC RESUME".

Mode Set (VCR Deck)

- Turn on the unit.
- Turn on the TV and select the AV mode.
- Slide the **TV/CABLE/DBS/DVD** switch to **DVD**.

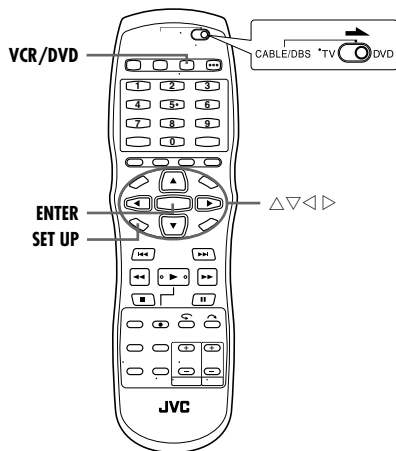

You can change various mode settings on the Function Set screen. To change the settings of these modes, find the desired mode in the menu (for details on each menu, see pages 60 through 61), then follow the procedure below.

1 Press **VCR/DVD** repeatedly so that the VCR lamp lights up on the unit.

2 Press **SET UP** to access the Main Menu screen.

3 Press $\Delta \nabla$ to select "COPY SET" or "FUNCTION SET", then press **ENTER**.

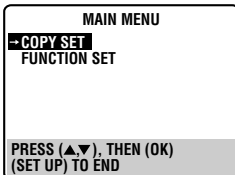

4 Press $\Delta \nabla$ to select the item you want to change, then press **ENTER** or \triangleright to select the desired mode.

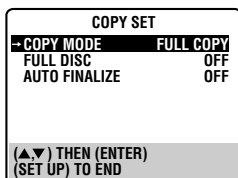

OR

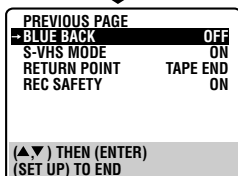
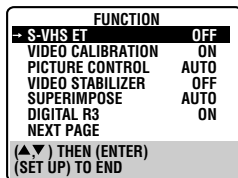

5 Press **SET UP** to complete the setting.

* The **boldface** settings below indicate the settings at your purchase.

COPY SET

■ COPY MODE — FULL COPY / 1 PROG.

This function allows you to select the position to stop dubbing when performing manual dubbing from the VCR deck to DVD deck. (ⓘ pg. 47)

FULL COPY: Dubbing stops at the end of tape.

1 PROG.: Dubbing stops when an index code or unrecorded portion is detected.

■ FULL DISC — ON / OFF

You can activate Just Dubbing function when dubbing an entire cassette from the VCR deck to DVD deck by setting this function to "ON". The unit automatically calculates the total recording time of the cassette and sets the appropriate recording mode depending on the calculated time and the available disc space. (ⓘ pg. 46)

■ AUTO FINALIZE — ON / OFF

When this function is set to "ON", the unit will automatically finalize the disc when dubbing has been completed. (ⓘ pg. 46)

FUNCTION SET

■ S-VHS ET — ON / OFF

You can record in SP mode on VHS cassettes with S-VHS picture quality. You can play back a tape recorded using the S-VHS ET function on most of the S-VHS recorders and VHS recorders equipped with SQPB (S-VHS QUASI PLAYBACK) function. (Notice some recorders are not compatible with the S-VHS ET function.) When this function is set to "ON", the S-VHS indicator lights up on the front display panel.

NOTES:

- You can activate the S-VHS ET function only before you start recording on a VHS cassette.
- Before recording, make sure that "VIDEO CALIBRATION" is set to "ON". (ⓘ below)
- You cannot activate the S-VHS ET function:
 - while recording is in progress.
 - while Video Calibration (ⓘ pg. 38) is in progress.
- The S-VHS ET function does not work with S-VHS cassettes.
- To keep the highest quality recording and playback pictures over a long period of time, S-VHS recording on S-VHS cassettes is recommended.
- Use of high grade tapes is recommended for S-VHS ET recordings. On some tapes, picture quality will not improve even if the S-VHS ET function is used. Check the recording quality before you start important recordings.
- While playing back a tape recorded using the S-VHS ET function on some recorders, noise may appear. (If playback picture becomes blurred or interrupted, use a cleaning cassette.)
- In the variable speed search, still, slow-motion or frame-by-frame playback modes (ⓘ pg. 34, "Playback Features"), noise may appear. If these modes are performed frequently on a tape recorded using the S-VHS ET function, the tape may be damaged and the picture may be deteriorated.

■ VIDEO CALIBRATION — ON / OFF

When this function is set to "ON", this unit checks the condition of the tape in use during playback and recording, and compensates to provide the highest-possible pictures. This takes place whenever you play back a tape or start recording after inserting a tape. (ⓘ pg. 38)

PICTURE CONTROL — AUTO / EDIT / SOFT / SHARP

This feature helps you to adjust the playback picture quality according to your preference. Normally select "AUTO".

AUTO: Picture quality is adjusted automatically.

EDIT: Minimizes picture degradation during editing (recording and playback).

SOFT: Reduces image coarseness when viewing overplayed tapes containing a lot of noise.

SHARP: Clearer, sharper-edged picture when viewing images with lots of flat, same-colored surfaces such as cartoons.

NOTES:

- When you select "EDIT", "SOFT" or "SHARP", the selected mode will not change until you select another mode.
- When you select "EDIT" to dub tapes, be sure to select "NORM" after you finish dubbing the tapes.
- When "VIDEO CALIBRATION" is "OFF", "PICTURE CONTROL" switches automatically from "AUTO" to "NORM".

VIDEO STABILIZER — ON / OFF

When this function is set to "ON", you can automatically correct vertical vibration in the picture when playing back unstable recordings made on another recorder.

NOTES:

- When you finish viewing a tape, be sure to set this function to "OFF".
- Regardless of the setting, this function has no effect during recording and during special effects playback.
- The on-screen display may jitter vertically when this function is set to "ON".
- To watch recordings with close-caption, set this function to "OFF".

SUPERIMPOSE — AUTO / ON / OFF

When this function is set to "AUTO", various operational indicators appear on the TV screen.

AUTO: To superimpose operational indications for approximately five seconds just after the corresponding operation.

ON: Functions in the same way as "AUTO". However, when "ON" is selected, the counter display (ⓘ pg. 14) will always be displayed during playback.

OFF: To turn off superimposed indications.

NOTES:

- When you use this unit as the source player for editing, be sure to set "SUPERIMPOSE" to "OFF" before starting.
- During playback, the operation mode indicators may be disturbed depending on the type of tape being used.

DIGITAL R3 — ON / OFF

When this function is set to "ON", the Digital 3R picture system applies edge correction to the luminance signal to enhance detail.

NOTES:

- Normally it is recommended to keep "DIGITAL 3R" set to "ON".
- Depending on the type of tape being used, picture quality may be better with "DIGITAL 3R" set to "OFF".
- If you use the unit as the source player for editing, be sure to set "DIGITAL 3R" to "OFF" before starting.

BLUE BACK — ON / OFF

When this function is set to "ON", the TV screen becomes all blue when there is no signal input from the external input.

NOTE:

When you want to receive an unstable external input with poor signals, set this function to "OFF".

S-VHS MODE — ON / OFF

Your unit can record in S-VHS (Super VHS), S-VHS ET or VHS.

To record in S-VHS:

Set "S-VHS MODE" to "ON". Then, insert a cassette marked "S-VHS". The S-VHS indicator lights up on the front display panel. The S-VHS recording mode is selected.

To record in S-VHS ET on a VHS cassette:

Set "S-VHS ET" to "ON". (ⓘ pg. 60) Then, insert a cassette marked "VHS". The S-VHS indicator lights up on the front display panel.

To record in VHS:

Insert a cassette marked "VHS".

Set "S-VHS ET" to "OFF". (ⓘ pg. 60)

The VHS recording mode is automatically selected regardless of the "S-VHS MODE" setting.

To record in VHS on an S-VHS cassette:

Insert a cassette marked "S-VHS". The S-VHS indicator lights up on the front display panel. Then, set "S-VHS MODE" to "OFF". The S-VHS indicator goes off.

The VHS recording mode is selected.

NOTE:

When playing back a tape that has been recorded in S-VHS or S-VHS ET, the S-VHS indicator lights up on the front display panel regardless of the "S-VHS MODE" setting.

RETURN POINT — TAPE END / REC END

Returning point for Playback or Repeat Play can be set to tape end or recording end. (This unit considers 1-second unrecorded portion as the recording end.) When the returning point is reached, playback stops and the cassette will be automatically rewind.

TAPE END: Playback stops at the end of tape.

REC END: Playback stops at the end of the recording.

NOTE:

The setting you have made is kept in memory. Even if this unit is unplugged or power failure occurs, it will resume every time you turn on this unit. (ⓘ pg. 65)

REC SAFETY — ON / OFF

Usually, you can only record onto a cassette with its record safety tab intact. When this function is set to "OFF", recording can be done onto a cassette with its record safety tab removed.

NOTES:

- The setting you have made is kept in memory. Even if this unit is unplugged or power failure occurs, it will resume every time you turn on this unit. (ⓘ pg. 65)
- When "REC SAFETY" is set to "OFF", playback does not start automatically when you insert a cassette with its record safety tab removed. (ⓘ pg. 36)

Format A Disc (DVD Deck Only)



Some DVD-RAM/RW discs are unformatted. Format the disc when you use an unformatted disc or you want to delete all recordings and data on the disc.

ATTENTION:

- When a disc is formatted, all recordings and data are erased. It is impossible to restore them.
- Never turn off the unit or disconnect the mains power cord while "NOW FORMATTING..." is displayed on the TV screen.

- Turn on the unit.
- Turn on the TV and select the AV mode.
- Slide the **TV/CABLE/DBS/DVD** switch to **DVD**.
- Load a DVD-RAM/RW disc to format.

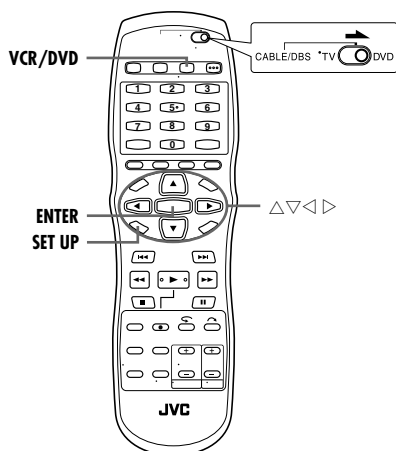

Format A DVD-RAM Disc

- 1 Press **VCR/DVD** repeatedly so that the DVD lamp lights up on the unit.
- 2 Press **SET UP** to access the Main Menu screen.
- 3 Press $\Delta \nabla \triangleleft \triangleright$ to select "DVD SET UP", then press **ENTER**.
- 4 Press $\triangleleft \triangleright$ to select "UTILITY", then press **ENTER**.
- 5 Press $\Delta \nabla$ to select "FORMAT", then press **ENTER**. Press $\triangleleft \triangleright$ to select "YES", then press **ENTER** when "DISC WILL BE FORMATTED" appears on the TV screen.
- 6 Press $\triangleleft \triangleright$ to select "OK", then press **ENTER** when "DISC FORMATTING WAS SELECTED" appears on the TV screen.
- 7 Upon completing formatting, "COMPLETED" appears on the TV screen. Press **ENTER** to end, then press **SET UP** to return to the normal screen.

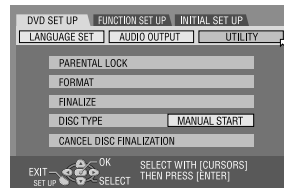

Format A DVD-RW Disc

- 1 Perform steps 2 to 4 of "Format A DVD-RAM Disc" on the above before continuing.
- 2 Press $\Delta \nabla$ to select "FORMAT", then press **ENTER**. Press $\triangleleft \triangleright$ to choose "VR MODE" or "VIDEO MODE", then press **ENTER** when "DISC WILL BE FORMATTED" appears on the TV screen.
 - "VR MODE": To be chosen when you want to record, erase, or edit data on the disc repeatedly.
 - "VIDEO MODE": To be chosen when you want to erase all the data on the disc once played back to record new data, or play back the disc on other DVD players.
- 3 Press $\triangleleft \triangleright$ to select "YES", then press **ENTER** when "DISC WILL BE FORMATTED IN VR MODE/VIDEO MODE" appears on the TV screen.
- 4 Upon completing formatting, "COMPLETED" appears on the TV screen. Press **ENTER** to end, then press **SET UP** to return to the normal screen.

NOTES:

- It is impossible to format Version 1.0 DVD-RW discs in Video mode.
- It is impossible to format DVD-R discs.
- All the programs on a disc will be deleted once the disc is formatted even if they are protected titles. (pg. 41)

Finalize A Disc (DVD Deck Only)



Finalizing DVD-R/RW discs recorded on this unit makes it possible for the discs to be played back on other DVD players. DVD-RW discs are finalized in the mode that the discs were formatted, enabling playback on compatible DVD players. Titles input in the Library Database DVD Navi are registered as titles in the DVD menu. (☞ pg. 41)

- Turn on the unit.
- Turn on the TV and select the AV mode.
- Slide the **TV/CABLE/DBS/DVD** switch to **DVD**.
- Load a DVD-R/RW disc to finalize.

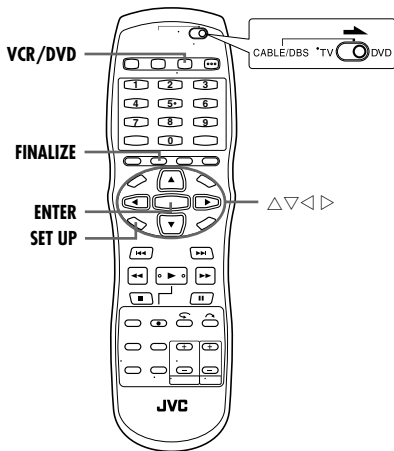

Before finalizing

- It is possible to record on a blank space.
- It is possible to enter a program title. (☞ pg. 41)
- It is possible to delete programs. (☞ pg. 41)
- It is impossible to overwrite recorded areas of DVD-R discs.
- Available recording capacity does not increase even if a recorded program is deleted from a DVD-R disc.
- It is impossible to record or edit DVD-R/RW discs recorded on other devices even if they have not been finalized.

After finalizing (For DVD-R/RW (Video mode) discs)

- Video and audio that have been recorded by then are recorded in conformity to the DVD Video standard, enabling you to play back the discs as DVD VIDEO discs.
- Although DVD-R/RW discs finalized on this unit become playable on DVD players compatible with DVD-R/RW discs, some discs still may not play, for which JVC cannot take responsibility.
- Marked points marked before finalizing will be deleted, and programs will be divided automatically into "chapters" approximately every 5 minutes. (☞ pg. 22)
- Depending on the DVD players and DVD-R/RW discs used, and on the conditions of recording, it may not be possible to play back the discs. In this case, play back the discs on this unit.
- Additional recordings become impossible.

Finalize A DVD-R/RW Disc

- 1 Press **VCR/DVD** repeatedly so that the DVD lamp lights up on the unit.
- 2 Press **SET UP** to access the Main Menu screen.
 - Alternatively, you can press **FINALIZE** to access the "FINALIZE" setting on the "UTILITY" menu directly. For details, refer to "Direct Access To "FINALIZE" Setting" (☞ pg. 64).
- 3 Press $\Delta \nabla \triangleleft \triangleright$ to select "DVD SET UP", then press **ENTER**.
- 4 Press $\triangleleft \triangleright$ to select "UTILITY", then press **ENTER**.
- 5 To change the operation method of a DVD-R/RW (Video mode) disc, press $\Delta \nabla$ to select "DISC TYPE", then press **ENTER**. Press $\Delta \nabla$ to select the desired option, then press **ENTER**.
- 6 Press $\Delta \nabla$ to select "FINALIZE", then press **ENTER**. Press $\triangleleft \triangleright$ to select "YES", then press **ENTER** when "DISC WILL BE FINALIZED" appears on the TV screen.
- 7 Press $\triangleleft \triangleright$ to select "OK", then press **ENTER** when "FINALIZING WILL MAKE DISC READ-ONLY" appears on the TV screen.
- 8 Press **SET UP** to return to the normal screen.
 - Menu screen is cleared.
 - You can select whether to finalize a disc automatically after dubbing. For details, refer to "Auto Finalizing" (☞ pg. 46)
 - Once a DVD-R/RW (Video mode) disc has been finalized, the displays for original and play list do not appear. Only display for library appears.
 - Once a DVD-RW (VR mode) disc has been finalized, it can be played on DVD players compatible with VR mode.

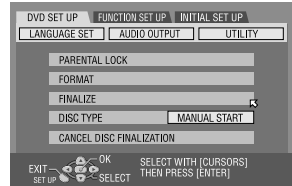

* The **boldface** settings below indicate the settings at your purchase.

■ DISC TYPE — **MANUAL START** / MENU STOP / AUTO REPEAT / NO MENU

You can set the operation method of a DVD-R/RW (Video mode) disc when finalizing the disc on this unit.

MANUAL START:

When the DVD disc is loaded, the disc will stop after it has been read. To play back the disc, press **▶**.

MENU STOP:

When the DVD disc is loaded, the disc will be played back automatically after it has been read. Playback will stop when the disc menu is displayed.

AUTO REPEAT:

When the DVD disc is loaded, the disc will be played back automatically after it has been read. The disc will be played repeatedly.

NO MENU:

When the DVD disc is loaded, the disc will be played back automatically after it has been read. All the titles on the disc will be played back sequentially; playback will stop when the last title is played.

Cancel The Finalization Of A DVD-RW Disc

1 Load a DVD-RW disc to cancel the disc finalization, and perform steps 2 to 4 of “Finalize A DVD-R/RW Disc” (pg. 63) before continuing.

2 Press \triangle/∇ to select “CANCEL DISC FINALIZATION”, then press **ENTER**.

3 Press \triangle/∇ to select “OK”, then press **ENTER** when “CANCEL DISC FINALIZATION” appears on the TV screen.

4 Press **SET UP** to return to the normal screen.

- When the disc finalization is cancelled, the mode in which the disc was formatted is restored, making the disc recordable. (pg. 7, 62)

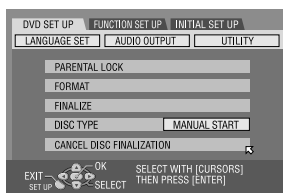

Direct Access To “FINALIZE” Setting

When you wish to finalize or cancel the finalization of a disc, besides accessing the “FINALIZE” setting through the **SET UP** button, you can also use the **FINALIZE** button on the remote control. This **FINALIZE** button enables you to access the “FINALIZE” setting directly after loading the disc.

To finalize a disc

- 1** Load the disc.
- 2** Press **DVD** so that the DVD lamp lights up on the unit.
- 3** Press **FINALIZE** to access the “FINALIZE” setting.
 - The screen in step 6 of “Finalize A DVD-R/RW Disc” (pg. 63) appears.
- 4** Perform steps 6 to 8 of “Finalize A DVD-R/RW Disc” (pg. 63) to finalize the disc.

To cancel finalization

- 1** Perform steps 1 to 3 of “To finalize a disc” above.
 - The screen in step 2 of “Cancel The Finalization Of A DVD-RW Disc” on the left column appears.
- 2** Perform steps 2 to 4 of “Cancel The Finalization Of A DVD-RW Disc” on the left column to cancel finalization of the disc.

NOTES:

- The direct access (**FINALIZE**) function works only when in the DVD deck mode, on the condition that the Main Menu or Library Database DVD Navi screen is not displayed.
- The direct access (**FINALIZE**) function will not work in the following cases, and an operation prohibition mark “ ⓧ ” appears on the TV screen.
 - During DVD recording or playback.
 - Disc is not loaded.
 - A playback-only disc is loaded.
 - A DVD-RAM or DVD VIDEO disc is loaded.
 - Disc reading in progress.
 - Disc information acquisition failure when DVD-RAM is loaded.
- When this unit is in the VCR deck mode or when dubbing is in progress, the direct access (**FINALIZE**) function will also not work. However, “ ⓧ ” will not be displayed.

Scan Mode Set

If you connect the unit and TV with Component Video Connection (☞ pg. 16), you can select the scan mode from two modes: Interlaced scan mode which is used in the conventional TV system, and Progressive scan mode which enables reproduction of higher-quality images. For details, refer to "GLOSSARY" (☞ pg. 69).

ATTENTION:

Your TV needs to be compatible with Progressive.

- Turn on the unit.
- Turn on the TV and select the AV mode.
- Slide the **TV/CABLE/DBS/DVD** switch to **DVD**.

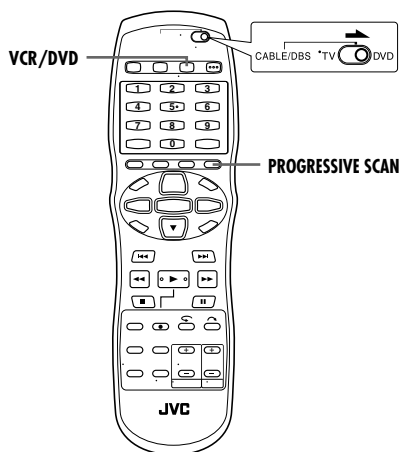

1 Press **VCR/DVD** repeatedly so that the DVD lamp lights up on the unit.

2 Press **PROGRESSIVE SCAN** for 3 or more seconds.
 • Video output indicator (P) lights on the front display panel if Progressive scan mode has been established. (☞ pg. 13)
 • Each press of **PROGRESSIVE SCAN** for 3 or more seconds switches the scan mode.

NOTES:

- When the Progressive scan mode is engaged, no video signal is output from [AUDIO/VIDEO] and S-VIDEO output connectors.
- Interlaced scan mode is the setting at your purchase.
- Interlaced scan mode might be suitable depending on video material.
- Scan mode cannot be set while menu screen is displayed.

Watch the image on VCR deck in the Progressive scan mode via component video

- 1 Set the Progressive-compatible TV to the component input mode.
- 2 Press **VCR/DVD** repeatedly so that the DVD lamp lights up on the unit, then press **PROGRESSIVE SCAN** for 3 or more seconds so that the Video output indicator (P) lights on the front display panel.
- 3 Press **VCR/DVD** repeatedly so that the VCR lamp lights up on the unit.
- 4 Press **VCR→DVD**.

NOTE:

Be sure to engage the DVD deck in stop mode.

Tray Lock (DVD Deck Only)

You can lock the disc tray to prohibit the unwanted disc ejection by children.

- Turn off the unit.

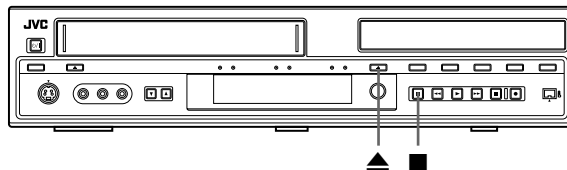

To lock tray

While the unit is turned off, press and hold ■, then press ▲ (**EJECT**) on the unit. "LOCKED" appears on the front display panel and the disc tray is locked.

To unlock tray

While the unit is turned off, press and hold ■, then press ▲ (**EJECT**) on the unit. "UNLOCK" appears on the front display panel.

NOTE:

To engage Tray Lock, "POWER SAVE" must be set to "OFF" (☞ pg. 59). In addition, the Tray Lock function is cancelled when the AC power plug is disconnected from the AC outlet. It is therefore advisable to use the Mode Lock function.

Mode Lock

During playback, recording or in stop mode, press and hold **F1** on the remote control for more than 5 seconds. "LOCKED" appears on the front display panel.

- No buttons will function and playback and recording will not be interrupted.
- When the unit is in the stop mode, all buttons will not function except ● and ►.

To cancel Mode Lock, press and hold **F1** again for more than 5 seconds.

NOTES:

- It is also possible to use Mode Lock during Repeat Playback (☞ pg. 29, 35).
- It is not possible to engage Mode Lock when the Main Menu screen, Library Database DVD Navi screen or the on-screen display is displayed.
- During Mode Lock, certain commands of the RS-232C control cannot be used. Cancel Mode Lock when using the RS-232C control.
- Unlike the Tray Lock function, Mode Lock will not be cancelled even if the AC power plug is disconnected from the AC outlet. When the AC power plug is reconnected, "LOCKED" appears on the front display panel and the unit remains in the power off condition. You can turn on the unit; however, it is not possible to turn off the unit thereafter. Only ● and ► are functional.

Last Function Memory

Before disconnecting the AC power plug from the AC outlet, press ⏻ to turn off the unit, your settings for the following functions are kept in the memory. These settings will resume when the unit is turned on again.

- Input selection (auxiliary input; L-1, F-1 or DV)
- Recorder selection (The last selected deck is memorized.)
- Recording mode (☞ pg. 36)
- Mode settings (☞ pg. 58 – 61)

Before requesting service for a problem, use this chart and see if you can solve the trouble yourself. Small problems are often easily solved, and this can save you the trouble of sending your unit off for repair.

Initializing (DVD Deck Only)

Malfunction occurs on the unit.

→ Press $\odot/|$ to turn off the unit, press and hold \blacksquare , then press $\odot/|$ for two seconds or more.

General

No power is supplied to the unit.

- The AC power plug is disconnected from the AC outlet.
- Connect the AC power plug to the AC outlet securely. (☞ pg. 16)

The remote control does not work properly.

- Remove the batteries, wait for 5 minutes or more, then load the batteries again. The remote control code will revert back to its default setting "3". If you had change the remote control code prior to replacing the batteries, you need to set the code again. (☞ pg. 55)
- The setting of the remote control code is inappropriate.
- Set the same remote control code (1, 2, 3, or 4) on both the unit and the remote control. (☞ pg. 55)
- The batteries are discharged.
- Replace the dead batteries with new ones. The remote control code will revert back to its default setting "3". If you had change the remote control code prior to replacing the batteries, you need to set the code again. (☞ pg. 55)

Dubbing from the external equipment is not possible.

- The source (another video recorder, camcorder) has not been properly connected.
- Confirm that the source is properly connected.
- All necessary power switches have not been turned on.
- Confirm that all units' power switches are turned on.
- The setting of the input position is inappropriate.
- Select the input position ("F-1" or "L-1") that corresponds to the input terminal connected to the external equipment. (☞ pg. 53)
- The record safety tab has been removed when dubbing to the cassette.
- Using adhesive tape, cover the hole where the tab was removed.

The on-screen display superimposed on the program played back/received on this unit is recorded when you dub the program to an external recording equipment.

→ Set "SUPERIMPOSE" to "OFF". (☞ pg. 59, 61)

The unit does not operate.

- There are cases when the operation is prohibited on the disc.
- Lightning or static electricity may cause malfunction of the unit.
- Press $\odot/|$ to turn the power off, then press the button again to turn the power on.

Playback (DVD Deck)

The DVD deck can not be operated.

- The DVD deck is not selected.
- Press **VCR/DVD** repeatedly so that the DVD lamp lights up on the unit.

Images do not appear on the TV screen.

- The TV is not set to the AV mode.
- Set the TV to its AV mode.
- When interlace scanned program is played back, progressive scan mode is selected.
- Press and hold **PROGRESSIVE SCAN** until **P** disappears from the front display panel.

Playback does not start or stop immediately after playback is started by pressing \blacktriangleright . On the front display panel, "NO DISC" appears.

- The disc is loaded upside down.
- Place the disc on the disc tray with the playback surface facing downward. (☞ pg. 10)
- A disc not being compatible with the unit is loaded.
- Load a playable disc on the unit. (☞ pg. 7)
- A dirty disc is loaded.
- Clean the disc. (☞ pg. 10)
- Defective disc is loaded.
- Replace the warped or scratched disc with a normal one.

"READING" remains on the front display panel and the disc cannot be ejected.

- You can try the following operation to eject the disc. Press and hold \blacktriangle (DVD) until the disc is ejected. It may take approximately 30 seconds.
- OR
- Press \blacksquare and **OPERATE** $\odot/|$ on the unit simultaneously to reset the unit, once "LOADING" appears on the front display panel press \blacktriangle (DVD) immediately until the disc is ejected.
- The disc ejection can be sudden. Take care not to injure your fingers when the disc tray opens.

Images are blurred or distorted when you start High-Speed Search.

- Images are blurred or distorted at the point where the playback speed changes and this is not a malfunction of the unit.

Playback does not start.

- Playback does not start for approximately 30 seconds after recording is stopped and this is not a malfunction of the unit.

Playback does not start when you select a title or a chapter.

- The Parental Lock is engaged and the disc is rated higher than the set level.
- Release the Parental Lock temporarily or change the set level. (☞ pg. 32)

Playback (VCR Deck)

The VCR deck can not be operated.

- The VCR deck is not selected.
- Press **VCR/DVD** repeatedly so that the VCR lamp lights up on the unit.

The tape will not rewind or fast-forward.

- The tape is already fully rewound or fast-forwarded.
- Check the cassette.

The playback picture does not appear while the tape is running.

- The TV is not set to the AV mode.
- Set the TV to its AV mode.

Noise appears during visual search.

- This is normal.

Noise appears during normal playback.

- The automatic tracking mode is engaged.
- Try manual tracking. (☞ pg. 35)

The playback picture is blurred or interrupted while external AV inputs are clear or "USE CLEANING CASSETTE" message appears on the screen.

- The video heads may be dirty.
- Use a dry cleaning cassette TCL-3F, or consult your JVC dealer.

Breaks are noticeable in Hi-Fi soundtrack.

- The automatic tracking mode is engaged.
- Try manual tracking. (☞ pg. 35)

Recording (DVD Deck)

Recording cannot be made.

- No disc or a disc not being compatible with the unit is loaded.
- Load a recordable disc on the unit. (☞ pg. 7)
- The disc loaded is not formatted.
- Format the disc. (☞ pg. 62)
- A finalized DVD-R disc is loaded.
- Recording cannot be made on finalized discs. Load a recordable disc on the unit.
- The disc is full or does not have enough space for the program to be recorded.
- Clear unnecessary programs on the disc or load a blank disc. (☞ pg. 41)

Recording (VCR Deck)

During recording, the tape does not run. The VCR recording lamp lights up on the front display panel.

- The unit is in the Record Pause mode.
- Press ▶ to resume recording.

Recording cannot be made.

- There is no cassette loaded, or the cassette loaded has had its record safety tab removed and "REC SAFETY" is set to "ON".
- Insert a cassette, or using adhesive tape, cover the hole where the tab was removed and "REC SAFETY" is set to "OFF" (☞ pg. 61).

Camcorder recording is not possible.

- The camcorder has not been properly connected.
- Confirm that the camcorder is properly connected.
- The input mode is not correct.
- Set the input mode to "F-1".

The tape is automatically rewound, then the unit is shut off.

- The end of the tape was reached during recording.
- The program may not have been recorded in its entirety. Next time make sure you have enough time on the tape to record the entire program.

Other Problems

The image of the program appears distorted on the TV screen.**For basic connection**

- Press **PROGRESSIVE SCAN** for 3 or more seconds so that the Video output indicator (P) lights off on the front display panel.

For component video connection

- Press **PROGRESSIVE SCAN** for 3 or more seconds so that the Video output indicator (P) lights up on the front display panel.

Whistling or howling is heard from the TV during camcorder recording.

- The camcorder's microphone is too close to the TV.
- Position the camcorder so its microphone is away from the TV.
- The TV's volume is too high.
- Turn the TV's volume down.

The AV input cannot be changed.

- Recording is in progress.
- Press **II** to pause the recording, change auxiliary input, then press ▶ to resume recording.

Buttons and controls do not function at all.

- Mode Lock is activated.
- Press and hold **F1** for more than 5 seconds to cancel Mode Lock.

On-screen Message (DVD Deck Only)

MEMORY IS FULL NOTHING MORE CAN BE REGISTERED IN THE LIBRARY IF YOU DELETE UNNECESSARY TITLE INFORMATION, YOU CAN THEN REGISTER ADDITIONAL INFORMATION

- The memory is full for registration for the Navigation system. The recording cannot be started even though the capacity for the recording is enough. (☞ pg. 44)

AVAILABLE MEMORY IS LOW SOON YOU WILL NO LONGER BE ABLE TO REGISTER INFORMATION IN THE LIBRARY IF YOU DELETE UNNECESSARY TITLE INFORMATION, YOU CAN THEN REGISTER ADDITIONAL INFORMATION

- The remaining capacity of the memory is not enough for registration for the Navigation system. The recording cannot be started even though the capacity for the recording is enough. (☞ pg. 44)

DISC NOT REGISTERED IN THE LIBRARY REGISTER DISC?

- A disc that is not registered in the library has been inserted. Register the disc as necessary. (☞ pg. 44)

INSERT DISC #XXXX

- Appears when a title that has been selected in the library is not contained in the loaded disc.

CAN NOT RECORD OR MAKE PLAY LIST DELETE UNWANTED TITLES

- Recording and/or editing cannot be performed with a loaded DVD-RAM disc.
- The number of titles exceeds 99.
- The number of play lists exceeds 99.

DISC NOT RECORDABLE INSERT RECORDABLE DISC

- When a playback-only disc or a finalized disc is loaded, ● has been pressed. (☞ pg. 7)

REGION CODE ERROR CHECK DISC

- A disc loaded cannot be played back on this unit since the region number of the disc does not match that of the unit. (☞ pg. 8)

UNREADABLE DISC CHECK DISC

- When an incompatible disc is loaded, ► has been pressed. (☞ pg. 8)

COULD NOT FORMAT THE DISC CHECK THE DISC

- Formatting is not complete since the disc may be dirty or damaged. Take out the disc, clean it and retry. (☞ pg. 10, 62)

COULD NOT FINALIZE THE DISC CHECK THE DISC

- Finalizing is not complete since the disc may be dirty or damaged. Take out the disc, clean it and retry. (☞ pg. 10, 63)

COULD NOT CANCEL DISC FINALIZATION CHECK THE DISC

- Canceling disc finalization is not complete since the disc may be dirty or damaged. Take out the disc, clean it and retry. (☞ pg. 10, 64)

PRESS [STOP] AGAIN TO STOP RECORDING

- During Live Memory playback, ■ has been pressed. (☞ pg. 27)

COPY PROHIBITED CAN NOT RECORD

- An attempt has been made to record copy-protected contents.
- An attempt has been made to record copy-once contents on a disc that is not CPRM compatible, such as DVD-R.

COPY PROHIBITED CAN NOT PLAY

- The unit has detected invalid contents at the start or in the middle of playback.

THE i.LINK DEVICE THAT YOU HAVE CONNECTED IS NOT RECOGNIZED MAKE SURE THAT THE DEVICE IS CONNECTED PROPERLY AND POWERED ON

- An attempt has been made to start DV dubbing when a digital video camera is not properly connected to the unit.
- Check the connection. (☞ pg. 51)

■ Aspect ratio

The ratio of vertical and horizontal sizes of a displayed image. The horizontal vs. vertical ratio of conventional TVs is 4:3, and that of wide-screens is 16:9.

■ Chapter

Refers to individual chapters included in a title.

■ Composite video signal

Refers to video signal comprised of three kinds of signals combined: an image signal made up of luminance and chrominance signals using the frequency multiplication technique; burst signal providing the basis for color reproduction; and synchronization signal.

■ Component video signal

A video signal system where parts of information necessary for reproducing image signal comprised of the three primary colors of light are transmitted via separate signal lines. Types of signal, such as R/G/B, Y/Pb/Pr, etc., are available.

■ Disc menu

A screen display prepared for allowing selection of images, sounds, subtitles, multiangles, etc. recorded on a DVD disc.

■ Dolby Digital (AC-3)

A six-channel system consisting of left, centre, right, left rear, right rear and LFE (Low-Frequency Effect channel, for use with a sub-woofer) channels. All processing is done in the digital domain. Not all Dolby Digital discs contain six (5.1) channels of information.

■ Down-mix

Internal stereo mix of multichannel surround audio by a DVD player. The down-mix signals are output from stereo output connectors.

■ DTS

A Digital Surround audio encoding format configured with six (5.1) channels, similar to Dolby Digital. It requires a decoder, either in the player or in an external receiver. DTS stands for Digital Theater Systems.

Not all DTS discs contain six (5.1) channels of information.

■ Interlaced scan

In the conventional video system, a picture is shown on the display monitor in two halves. The Interlaced scan system places lines of the second half of the picture in-between lines of the first half of the picture.

■ JPEG

A still-picture data compression system proposed by the Joint Photographic Expert Group, which features small decrease in image quality in spite of its high compression ratio.

■ Letter box

A method of displaying wide images like movies in the centre of a 4:3 TV screen with no part of the image deleted, by placing black bands on the top and bottom of the screen. This name has resulted from the screen form looking literally like a letter box.

■ Linear PCM (PCM: Pulse Code Modulation)

A system for converting analog sound signal to digital signal for later processing, with no data compression used in conversion.

■ MP3

A file format with a sound data compression system. "MP3" is the abbreviation of Motion Picture Experts Group 1 (or MPEG-1) Audio Layer 3. By using MP3 format, one CD-R/RW can contain about 10 times as much data volume as a regular CD can.

■ MPEG

A family of Standards for compressing audio-visual information. "MPEG" standards include MPEG-1, MPEG-2 and MPEG-4. Video CD and MP3 are based on MPEG-1, while DVD is based on MPEG-2. MPEG stands for Moving Picture coding Experts Group.

■ Multiangle

By recording multiple scenes progressing at the same time in a single title, the user can select view angles. This feature is called the multiangle function.

■ Multichannel

DVD is specified to have each sound track constitute one sound field. Multichannel refers to a structure of sound tracks having three or more channels.

■ Multilanguage

When a title is created to cope with multiple languages, it is generally called a multilanguage title.

■ NTSC (National television system committee)

A black and white and color television system format used in the U.S.A., Canada, Mexico and Japan.

■ PAL (Phase Alternation by Line)

A color television system format used extensively in Western Europe.

■ Parental Lock

A feature of this system to automatically determine whether or not to reproduce particular DVD software by comparing its parental lock level (a measure of undesirability of scenes, etc. from educational viewpoint) set for the software beforehand with that set on this system by the user; if the software's level is less restrictive than the user-set level, it will be reproduced.

■ Playback control (PBC)

Refers to the signal recorded on Video CDs for controlling reproduction. By using menu screens recorded on a Video CD that supports PBC, you can enjoy interactive-type software as well as software having a search function.

■ Progressive scan

Progressive scan displays all the horizontal lines of a picture at one time, as a single frame. This system can convert the interlaced video from DVD into progressive format for connection to a progressive display. It dramatically increases the vertical resolution.

■ Region Code

A system for allowing discs to be played back only in the regions designated beforehand. All the countries in the world are grouped into six regions, each region being identified by a specified Region Code (or region number). If the Region Code given to a disc includes a numeral which matches one in the Region Code of a player, the player can play back the disc.

■ Sampling frequency

Frequency of sampling data when analog data is converted to digital data. Sampling frequency numerically represents how many times the original analog signal is sampled per second.

■ Surround

A system for creating three-dimensional sound fields full of realism by arranging multiple speakers around the listener.

■ Transfer rate

The rate of transferring digital data. Usually the measure is in baud per second. The DVD system applies a variable transfer rate system for high efficiency.

Language Code List

AA	Afar	IN	Indonesian	RU	Russian
AB	Abkhazian	IS	Icelandic	RW	Kinyarwanda
AF	Afrikaans	IW	Hebrew	SA	Sanskrit
AM	Ameharic	JI	Yiddish	SD	Sindhi
AR	Arabic	JW	Javanese	SG	Sangho
AS	Assamese	KA	Georgian	SH	Serbo-Croatian
AY	Aymara	KK	Kazakh	SI	Singhalese
AZ	Azerbaijani	KL	Greenlandic	SK	Slovak
BA	Bashkir	KM	Cambodian	SL	Slovenian
BE	Byelorussian	KN	Kannada	SM	Samoan
BG	Bulgarian	KO	Korean (KOR)	SN	Shona
BH	Bihari	KS	Kashmiri	SO	Somali
BI	Bislama	KU	Kurdish	SQ	Albanian
BN	Bengali, Bangla	KY	Kirghiz	SR	Serbian
BO	Tibetan	LA	Latin	SS	Siswati
BR	Breton	LN	Lingala	ST	Sesotho
CA	Catalan	LO	Laothian	SU	Sundanese
CO	Corsican	LT	Lithuanian	SW	Swahili
CS	Czech	LV	Latvian, Lettish	TA	Tamil
CY	Welsh	MG	Malagasy	TE	Telugu
DZ	Bhutani	MI	Maori	TG	Tajik
EL	Greek	MK	Macedonian	TH	Thai
EO	Esperanto	ML	Malayalam	TI	Tigrinya
ET	Estonian	MN	Mongolian	TK	Turkmen
EU	Basque	MO	Moldavian	TL	Tagalog
FA	Persian	MR	Marathi	TN	Setswana
FJ	Fiji	MS	Malay (MAY)	TO	Tonga
FO	Faroese	MT	Maltese	TR	Turkish
FY	Frisian	MY	Burmese	TS	Tsonga
GA	Irish	NA	Nauru	TT	Tatar
GD	Scots Gaelic	NE	Nepali	TW	Twi
GL	Galician	OC	Occitan	UK	Ukrainian
GN	Guarani	OM	(Afan) Oromo	UR	Urdu
GU	Gujarati	OR	Oriya	UZ	Uzbek
HA	Hausa	PA	Panjabi	VI	Vietnamese
HI	Hindi	PL	Polish	VO	Volapuk
HR	Croatian	PS	Pashto, Pushto	WO	Wolof
HU	Hungarian	PT	Portuguese	XH	Xhosa
HY	Armenian	QU	Quechua	YO	Yoruba
IA	Interlingua	RM	Rhaeto-Romance	ZH	Chinese
IE	Interlingue	RN	Kirundi	ZU	Zulu
IK	Inupiak	RO	Rumanian		

Country/Area Code List for Parental Lock

AD	Andorra	CK	Cook Islands	GN	Guinea
AE	United Arab Emirates	CL	Chile	GP	Guadeloupe
AF	Afghanistan	CM	Cameroon	GQ	Equatorial Guinea
AG	Antigua and Barbuda	CN	China	GR	Greece
AI	Anguilla	CO	Colombia	GS	South Georgia and the South Sandwich Islands
AL	Albania	CR	Costa Rica	GT	Guatemala
AM	Armenia	CU	Cuba	GU	Guam
AN	Netherlands Antilles	CV	Cape Verde	GW	Guinea-Bissau
AO	Angola	CX	Christmas Island	GY	Guyana
AQ	Antarctica	CY	Cyprus	HK	Hong Kong
AR	Argentina	CZ	Czech Republic	HM	Heard Island and McDonald Islands
AS	American Samoa	DE	Germany	HN	Honduras
AT	Austria	DJ	Djibouti	HR	Croatia
AU	Australia	DK	Denmark	HT	Haiti
AW	Aruba	DM	Dominica	HU	Hungary
AZ	Azerbaijan	DO	Dominican Republic	ID	Indonesia
BA	Bosnia and Herzegovina	DZ	Algeria	IE	Ireland
BB	Barbados	EC	Ecuador	IL	Israel
BD	Bangladesh	EE	Estonia	IN	India
BE	Belgium	EG	Egypt	IO	British Indian Ocean Territory
BF	Burkina Faso	EH	Western Sahara	IQ	Iraq
BG	Bulgaria	ER	Eritrea	IR	Iran (Islamic Republic of)
BH	Bahrain	ES	Spain	IS	Iceland
BI	Burundi	ET	Ethiopia	IT	Italy
BJ	Benin	FI	Finland	JM	Jamaica
BM	Bermuda	FJ	Fiji	JO	Jordan
BN	Brunei Darussalam	FK	Falkland Islands (Malvinas)	JP	Japan
BO	Bolivia	FM	Micronesia (Federated States of)	KE	Kenya
BR	Brazil	FO	Faroe Islands	KG	Kyrgyzstan
BS	Bahamas	FR	France	KH	Cambodia
BT	Bhutan	FX	France, Metropolitan	KI	Kiribati
BV	Bouvet Island	GA	Gabon	KM	Comoros
BW	Botswana	GB	United Kingdom	KN	Saint Kitts and Nevis
BY	Belarus	GD	Grenada	KP	Korea, Democratic People's Republic of
BZ	Belize	GE	Georgia	KR	Korea, Republic of
CA	Canada	GF	French Guiana	KW	Kuwait
CC	Cocos (Keeling) Islands	GH	Ghana	KY	Cayman Islands
CF	Central African Republic	GI	Gibraltar	KZ	Kazakhstan
CG	Congo	GL	Greenland	LA	Lao People's Democratic Republic
CH	Switzerland	GM	Gambia	LB	Lebanon
CI	Côte d'Ivoire				

LC	Saint Lucia	NU	Niue	SZ	Swaziland
LI	Liechtenstein	NZ	New Zealand	TC	Turks and Caicos Islands
LK	Sri Lanka	OM	Oman	TD	Chad
LR	Liberia	PA	Panama	TF	French Southern Territories
LS	Lesotho	PE	Peru	TG	Togo
LT	Lithuania	PF	French Polynesia	TH	Thailand
LU	Luxembourg	PG	Papua New Guinea	TJ	Tajikistan
LV	Latvia	PH	Philippines	TK	Tokelau
LY	Libyan Arab Jamahiriya	PK	Pakistan	TM	Turkmenistan
MA	Morocco	PL	Poland	TN	Tunisia
MC	Monaco	PM	Saint Pierre and Miquelon	TO	Tonga
MD	Moldova, Republic of	PN	Pitcairn	TP	East Timor
MG	Madagascar	PR	Puerto Rico	TR	Turkey
MH	Marshall Islands	PT	Portugal	TT	Trinidad and Tobago
ML	Mali	PW	Palau	TV	Tuvalu
MM	Myanmar	PY	Paraguay	TW	Taiwan
MN	Mongolia	QA	Qatar	TZ	Tanzania, United Republic of
MO	Macau	RE	Réunion	UA	Ukraine
MP	Northern Mariana Islands	RO	Romania	UG	Uganda
MQ	Martinique	RU	Russian Federation	UM	United States Minor Outlying Islands
MR	Mauritania	RW	Rwanda	US	United States
MS	Montserrat	SA	Saudi Arabia	UY	Uruguay
MT	Malta	SB	Solomon Islands	UZ	Uzbekistan
MU	Mauritius	SC	Seychelles	VA	Vatican City State (Holy See)
MV	Maldives	SD	Sudan	VC	Saint Vincent and the Grenadines
MW	Malawi	SE	Sweden	VE	Venezuela
MX	Mexico	SG	Singapore	VG	Virgin Islands (British)
MY	Malaysia	SH	Saint Helena	VI	Virgin Islands (U.S.)
MZ	Mozambique	SI	Slovenia	VN	Viet Nam
NA	Namibia	SJ	Svalbard and Jan Mayen	VU	Vanuatu
NC	New Caledonia	SK	Slovakia	WF	Wallis and Futuna Islands
NE	Niger	SL	Sierra Leone	WS	Samoa
NF	Norfolk Island	SM	San Marino	YE	Yemen
NG	Nigeria	SN	Senegal	YT	Mayotte
NI	Nicaragua	SO	Somalia	YU	Yugoslavia
NL	Netherlands	SR	Suriname	ZA	South Africa
NO	Norway	ST	Sao Tome and Principe	ZM	Zambia
NP	Nepal	SV	El Salvador	ZR	Zaire
NR	Nauru	SY	Syrian Arab Republic	ZW	Zimbabwe

RS-232C Interface – Command Table –

Lower Order→ Higher Order↓	0	1	2	3	4	5	6	7	8	9	A	B	C	D	E	F
0		Complete	Error	Cassette Out		Not Target					ACK	NAK				
1																
2																
3	VCR Selection								DVD Selection		Play					Stop
4																Still
5							Clear									
6	Chapter Sense	Title Sense														
7																
8	Chapter Search	Title Search													Date Preset	Clock Preset
9	Finalize	Cancel- Disc Finaliza- tion	DiscErase	TOP MENU	MENU	NEXT CHAPTER	PREV CHAPTER	Setup	SET	UP	DOWN	RIGHT	LEFT	Next Title	Prev Title	Remote Data
A	Standby On	Standby Off		Eject								FF	REW	Fwd Field Step	Rev Field Step	
B	Viss Fwd	Viss Rev				Fwd Shtl	Rev Shtl		Select Preset	Select Sense					Date Data Sense	ClockData Sense
C											Rec	Rec Pause				
D								Status Sense	Tc Data Sense	CTL Data Sense				JVCStatus Sense		
E																
F	Command Target										Rec/Dub Request					

RS-232C Interface – Specifications –

• 9PIN D-Sub

This unit

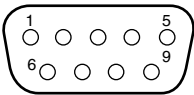

PIN No.	Signal	Operation	Direction of signal
2	TxD	Transmit data	This unit→PC
3	RxD	Receive data	This unit←PC
5	GND	Signal grounding	

Mode : Non-synchronous
 Character length : 8 bits
 Parity : Odd
 Start bit : 1
 Stop bit : 1
 Data rate : 9600bps
 Bit configuration

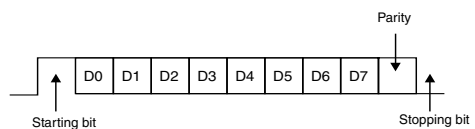

NOTES:

- When using the Serial Command Connector, the cable to be used should be a RS-232C interface cable (straight type).
- It takes about 10 seconds for the communication to be established after turning on the unit.
- During command transmission, a minimum interval of 50 mm/second is required between each command.

RS-232C Interface – Command –

• Operation Commands

Commands for operating functions such as PLAY and REC on the DVD and VCR deck.

Command	Description
3A	Plays the selected deck.
3F	Stops the selected deck. Resume will be cleared when this is pressed while in the Stop mode. (DVD Deck) Rec Request will be cleared.
4F	Switches the selected deck to the Still mode.
80	Searches the specified chapter and starts playback from the beginning. (DVD Deck) See page 76 for data format.
81	Searches the specified title and starts playback from the beginning. (DVD Deck) See page 76 for data format.
8E	For setting the date. See page 76 for data format.
8F	For setting the time. See page 76 for data format.
90	Finalizes the disc. (DVD Deck)
91	Cancels disc finalization. (DVD Deck)
92	For erasing rewritable discs. (DVD Deck)
93	Displays/Closes the top menu of a disc. (DVD Deck)
94	Displays/Closes the disc menu. (DVD Deck)
95	Advances to the next chapter. Functions like the ►► button on the remote control. (DVD Deck)
96	Returns to the previous chapter. Functions like the ◀◀ button on the remote control. (DVD Deck)
97	Displays/Closes the Main Menu and Library Database DVD Navi screen. 97 → 30: Closes the screen. 97 → 31: Displays the Main Menu screen. 97 → 32: Displays the Library Database DVD Navi screen. (DVD Deck)
98	Functions as a confirmation key.
99	Functions as an up key.
9A	Functions as a down key.
9B	Functions as a right key.
9C	Functions as a left key.
9D	Advances to the next title. Functions like the ►►I button on the remote control. (DVD Deck)
9E	Returns to the previous title. Functions like the ◀◀ button on the remote control. (DVD Deck)
9F	Issues the same codes as the wired remote control via RS-232C. Prolonged keypress for VCR deck operations are not allowed. See page 77 for the remote control codes.
A0	Power On
A1	Power Off
A3	Eject: DVD Deck: Opens/Closes tray. VCR Deck: Removes cassette.
AB	FF: DVD Deck: Functions only during playback. Activates forward search. For details on the search speed, refer to "Variable Speed Search" (☞ pg. 21). VCR Deck: Fast forward. Search Fwd during playback. For details on the search speed, refer to "Variable Speed Search" (☞ pg. 34).
AC	REW: DVD Deck: Functions only during playback. Activates reverse search. For details on the search speed, refer to "Variable Speed Search" (☞ pg. 21). VCR Deck: Rewind. Search Rev during playback. For details on the search speed, refer to "Variable Speed Search" (☞ pg. 34).

Command	Description
AD	Functions as a key for advancing (FWD) a frame. When this command is received during still mode, the unit advances the still picture by one frame (or field) in the FWD direction.
AE	Functions as a key for reversing (REV) a frame. When this command is received during still mode, the unit reverses the still picture by one frame (or field) in the REV direction.
B0	Viss Fwd: Fast forwards to the start position. (VCR Deck)
B1	Viss Rev: Rewinds to the start position. (VCR Deck)
B5	Fwd Shtl: Functions only during playback. Activates forward search. DVD Deck: B5 → 30: STILL B5 → 31: FWD SLOW at a slower speed. B5 → 32: FWD SLOW at a slow speed. B5 → 33: FWD SLOW at a fast speed. B5 → 35: 1x B5 → 36: FWD SEARCH at a fast speed. B5 → 37: FWD SEARCH at a faster speed. B5 → 38: FWD SEARCH at the fastest speed. B5 → 39: FWD SEARCH at the most fastest speed. VCR Deck: B5 → 30: STILL B5 → 31: FWD SLOW at a slow speed. B5 → 33: FWD SLOW at a fast speed. B5 → 35: 1x B5 → 36: FWD SEARCH at a fast speed. B5 → 37: FWD SEARCH at a faster speed. B5 → 38: FWD SEARCH at the fastest speed.
B6	Rev Shtl: Functions only during playback. Activates reverse search. DVD Deck: B6 → 30: STILL B6 → 31: REV SLOW at a slower speed. B6 → 32: REV SLOW at a slow speed. B6 → 33: REV SLOW at a fast speed. B6 → 35: -1x B6 → 36: REV SEARCH at a fast speed. B6 → 37: REV SEARCH at a faster speed. B6 → 38: REV SEARCH at the fastest speed. B6 → 39: REV SEARCH at the most fastest speed. VCR Deck: B6 → 30: STILL B6 → 31: REV SLOW at a slow speed. B6 → 33: REV SLOW at a fast speed. B6 → 35: -1x B6 → 36: REV SEARCH at a fast speed. B6 → 37: REV SEARCH at a faster speed. B6 → 38: REV SEARCH at the fastest speed.
B8	For setting the input, recording mode, audio language selection and subtitle selection. See pages 78 - 80 for data format.
CA	Rec: Starts recording at the selected deck when a Rec Request is received.
CB	Rec Pause: Switches the selected deck to the Rec Pause mode when a Rec Request is received.
F0	Command Target: F0 → 30: For selecting VCR deck. F0 → 38: For selecting DVD deck.
FA	Rec Request: For issuing approval for recording. This can be cleared using STOP.

80: Chapter Search

	1st Byte	2nd Byte	3rd Byte
Chapter Search	Hundreds	Tens	Ones
ASCII codes (30 - 39)	3*	3*	3*
E.g. (012)	30	31	32

E.g.: When searching the 12th chapter.

81: Title Search under "ORIGINAL"

	1st Byte	2nd Byte	3rd Byte	4th Byte
Title Search (ORIGINAL)	30	Hundreds	Tens	Ones
ASCII codes (30 - 39)	30	3*	3*	3*
E.g. (045)	30	30	34	35

E.g.: When searching the 45th title.

81: Title Search in "PLAY LIST"

	1st Byte	2nd Byte	3rd Byte	4th Byte
Title Search (PLAY LIST)	38	Hundreds	Tens	Ones
ASCII codes (30 - 39)	38	3*	3*	3*
E.g. (028)	38	30	32	38

E.g.: When searching the 28th play list.

8E: Date Preset

	1st Byte	2nd Byte	3rd Byte	4th Byte	5th Byte	6th Byte
Date Preset	Mth (Tens)	Mth (Ones)	Day (Tens)	Day (Ones)	Yr (Tens)	Yr (Ones)
ASCII code (30 - 39)	3*	3*	3*	3*	3*	3*
E.g. (01.17.2006)	30	31	31	37	30	36

E.g.: When setting the date to January 17 2006.

8F: Clock Preset

	1st Byte	2nd Byte	3rd Byte	4th Byte	5th Byte	6th Byte
Clock Preset	Hr (Tens)	Hr (Ones)	Min (Tens)	Min (Ones)	Sec (Tens)	Sec (Ones)
ASCII code (30 - 39)	3*	3*	3*	3*	3*	3*
E.g. (12:34:56)	31	32	33	34	35	36

E.g.: When setting the time to 12 hrs 34 min and 56 sec.

9F: Remote Data

The remote control codes for controlling the VTR (similar to wired remote control) via RS-232C are as shown in the following table. The codes apply to both DVD and VCR deck unless otherwise stated.

Code	Items	Remarks	Code	Items	Remarks
03	STOP/CLEAR		88	TBC ON/OFF	VCR Deck only
04	EJECT	VCR Deck only	8E	ON SCREEN	
06	S.FWD/SLOW+		90	MEMORY/MARK	DVD Deck only
07	S.REV/SLOW-		96	CM SKIP	
08	FWD SLOW 1/6	VCR Deck only	97	DV INPUT	DVD Deck only
0B	POWER ON/OFF		AF	REV FRAME	
0C	PLAY/SELECT		B0	-SLOW D	DVD Deck only
0D	PAUSE		B1	SHUTTLE -C	
14	NEXT/▶▶/INDEX +1		B2	SHUTTLE -B	
15	PREVIOUS/◀◀/INDEX -1		B3	SHUTTLE -A	
17	AUDIO		B4	SHUTTLE -2	
18	INPUT -		B5	SHUTTLE -1	
19	INPUT +		B6	-SLOW B	
1E	ON SCREEN	VCR Deck only	B7	-SLOW C	
20	TEN KEY 0/AUX/SPACE	DVD Deck only	B8	+SLOW C	
21	TEN KEY 1		B9	+SLOW B	
22	TEN KEY 2/ABC		BA	SHUTTLE +1	
23	TEN KEY 3/DEF		BB	SHUTTLE +2	
24	TEN KEY 4/GHI		BC	SHUTTLE +A	
25	TEN KEY 5/JKL		BD	SHUTTLE +B	
26	TEN KEY 6/MNO		BE	SHUTTLE +C	
27	TEN KEY 7/PQRS		BF	+SLOW D	DVD Deck only
28	TEN KEY 8/TUV		C0	ANGLE/LIVE CHECK	
29	TEN KEY 9/WXYZ		C4	SUBTITLE	DVD Deck only
31	REMAIN/REC MODE		CC	REC	
36	CANCEL		CD	REC PAUSE	
37	SET UP		CE	INDEX +1	VCR Deck only
38	DISPLAY		CF	INDEX -1	
39	COUNTER RESET	VCR Deck only	D0	REV SLOW 1/6	
3C	ENTER		D4	RETURN	
3D	FINALIZE	DVD Deck only	D6	VCR/DVD	
40	AUTO TRACKING ON/ OFF	VCR Deck only	D8	JOG -1	DVD Deck only
41	TRACKING +		D9	JOG -1/2	
42	TRACKING -		DA	JOG +1/2	
43	VCR DECK	DVD Deck only	DB	JOG +1	
44	DVD DECK		DC	INSTANT REPLAY	
7C	SP	VCR Deck only	E0	TOP MENU/NAVIGATION	DVD Deck only
7D	LP		E1	L1 Y/C INPUT SELECT	
80	CURSOR ▶		E2	L1 COMPOSITE INPUT SELECT	
81	MENU	DVD Deck only	EA	AUX(L-1) SELECT	VCR Deck only
82	CURSOR △		EC	F-1 Y/C INPUT SELECT	
84	CURSOR ◀		ED	FWD FRAME	
86	CURSOR ▽		EE	F-1 COMPOSITE INPUT SELECT	
87	OPEN/CLOSE	DVD Deck only			

B8: Input Selection

		1st Byte	2nd Byte
External input selection	L-1 VIDEO	30	31
	L-1 S-VIDEO	30	39
	F-1 VIDEO	30	35
	F-1 S-VIDEO	30	3D
	DV	30	34

B8: Recording Mode Selection

	1st Byte	2nd Byte		1st Byte	2nd Byte		1st Byte	2nd Byte
XP	34	30	FR150	34	93	FR265	34	AA
SP	34	31	FR155	34	94	FR270	34	AB
LP	34	32	FR160	34	95	FR275	34	AC
EP	34	33	FR165	34	96	FR280	34	AD
DV	34	38	FR170	34	97	FR285	34	AE
FR60	34	81	FR175	34	98	FR290	34	AF
FR65	34	82	FR180	34	99	FR295	34	B0
FR70	34	83	FR185	34	9A	FR300	34	B1
FR75	34	84	FR190	34	9B	FR305	34	B2
FR80	34	85	FR195	34	9C	FR310	34	B3
FR85	34	86	FR200	34	9D	FR315	34	B4
FR90	34	87	FR205	34	9E	FR320	34	B5
FR95	34	88	FR210	34	9F	FR325	34	B6
FR100	34	89	FR215	34	A0	FR330	34	B7
FR105	34	8A	FR220	34	A1	FR335	34	B8
FR110	34	8B	FR225	34	A2	FR340	34	B9
FR115	34	8C	FR230	34	A3	FR345	34	BA
FR120	34	8D	FR235	34	A4	FR350	34	BB
FR125	34	8E	FR240	34	A5	FR355	34	BC
FR130	34	8F	FR245	34	A6	FR360	34	BD
FR135	34	90	FR250	34	A7	FR420	34	C9
FR140	34	91	FR255	34	A8	FR480	34	D5
FR145	34	92	FR260	34	A9			

B8: Audio Language Selection

	1st Byte	2nd Byte		1st Byte	2nd Byte		1st Byte	2nd Byte
ENGLISH	39	11	HI	39	3F	RM	39	6D
GERMAN	39	12	HR	39	40	RN	39	6E
FRENCH	39	13	HU	39	41	RO	39	6F
ITALIAN	39	14	HY	39	42	RU	39	70
SPANISH	39	15	IA	39	43	RW	39	71
DUTCH	39	16	IE	39	44	SA	39	72
SWEDISH	39	17	IK	39	45	SD	39	73
NORWEGIAN	39	18	IN	39	46	SG	39	74
FINNISH	39	19	IS	39	47	SH	39	75
DANISH	39	1A	IW	39	48	SI	39	76
JAPANESE	39	1B	JI	39	49	SK	39	77
AA	39	1C	JW	39	4A	SL	39	78
AB	39	1D	KA	39	4B	SM	39	79
AF	39	1E	KK	39	4C	SN	39	7A
AM	39	1F	KL	39	4D	SO	39	7B
AR	39	20	KM	39	4E	SQ	39	7C
AS	39	21	KN	39	4F	SR	39	7D
AY	39	22	KO	39	50	SS	39	7E
AZ	39	23	KS	39	51	ST	39	7F
BA	39	24	KU	39	52	SU	39	80
BE	39	25	KY	39	53	SW	39	81
BG	39	26	LA	39	54	TA	39	82
BH	39	27	LN	39	55	TE	39	83
BI	39	28	LO	39	56	TG	39	84
BN	39	29	LT	39	57	TH	39	85
BO	39	2A	LV	39	58	TI	39	86
BR	39	2B	MG	39	59	TK	39	87
CA	39	2C	MI	39	5A	TL	39	88
CO	39	2D	MK	39	5B	TN	39	89
CS	39	2E	ML	39	5C	TO	39	8A
CY	39	2F	MN	39	5D	TR	39	8B
DZ	39	30	MO	39	5E	TS	39	8C
EL	39	31	MR	39	5F	TT	39	8D
EO	39	32	MS	39	60	TW	39	8E
ET	39	33	MT	39	61	UK	39	8F
EU	39	34	MY	39	62	UR	39	90
FA	39	35	NA	39	63	UZ	39	91
FJ	39	36	NE	39	64	VI	39	92
FO	39	37	OC	39	65	VO	39	93
FY	39	38	OM	39	66	WO	39	94
GA	39	39	OR	39	67	XH	39	95
GD	39	3A	PA	39	68	YO	39	96
GL	39	3B	PL	39	69	ZH	39	97
GN	39	3C	PS	39	6A	ZU	39	98
GU	39	3D	PT	39	6B			
HA	39	3E	QU	39	6C			

See "Language Code List" (pg. 70).

B8: Subtitle Selection

	1st Byte	2nd Byte		1st Byte	2nd Byte		1st Byte	2nd Byte
OFF	3C	10	HA	3C	3E	QU	3C	6C
ENGLISH	3C	11	HI	3C	3F	RM	3C	6D
GERMAN	3C	12	HR	3C	40	RN	3C	6E
FRENCH	3C	13	HU	3C	41	RO	3C	6F
ITALIAN	3C	14	HY	3C	42	RU	3C	70
SPANISH	3C	15	IA	3C	43	RW	3C	71
DUTCH	3C	16	IE	3C	44	SA	3C	72
SWEDISH	3C	17	IK	3C	45	SD	3C	73
NORWEGIAN	3C	18	IN	3C	46	SG	3C	74
FINNISH	3C	19	IS	3C	47	SH	3C	75
DANISH	3C	1A	IW	3C	48	SI	3C	76
JAPANESE	3C	1B	JI	3C	49	SK	3C	77
AA	3C	1C	JW	3C	4A	SL	3C	78
AB	3C	1D	KA	3C	4B	SM	3C	79
AF	3C	1E	KK	3C	4C	SN	3C	7A
AM	3C	1F	KL	3C	4D	SO	3C	7B
AR	3C	20	KM	3C	4E	SQ	3C	7C
AS	3C	21	KN	3C	4F	SR	3C	7D
AY	3C	22	KO	3C	50	SS	3C	7E
AZ	3C	23	KS	3C	51	ST	3C	7F
BA	3C	24	KU	3C	52	SU	3C	80
BE	3C	25	KY	3C	53	SW	3C	81
BG	3C	26	LA	3C	54	TA	3C	82
BH	3C	27	LN	3C	55	TE	3C	83
BI	3C	28	LO	3C	56	TG	3C	84
BN	3C	29	LT	3C	57	TH	3C	85
BO	3C	2A	LV	3C	58	TI	3C	86
BR	3C	2B	MG	3C	59	TK	3C	87
CA	3C	2C	MI	3C	5A	TL	3C	88
CO	3C	2D	MK	3C	5B	TN	3C	89
CS	3C	2E	ML	3C	5C	TO	3C	8A
CY	3C	2F	MN	3C	5D	TR	3C	8B
DZ	3C	30	MO	3C	5E	TS	3C	8C
EL	3C	31	MR	3C	5F	TT	3C	8D
EO	3C	32	MS	3C	60	TW	3C	8E
ET	3C	33	MT	3C	61	UK	3C	8F
EU	3C	34	MY	3C	62	UR	3C	90
FA	3C	35	NA	3C	63	UZ	3C	91
FJ	3C	36	NE	3C	64	VI	3C	92
FO	3C	37	OC	3C	65	VO	3C	93
FY	3C	38	OM	3C	66	WO	3C	94
GA	3C	39	OR	3C	67	XH	3C	95
GD	3C	3A	PA	3C	68	YO	3C	96
GL	3C	3B	PL	3C	69	ZH	3C	97
GN	3C	3C	PS	3C	6A	ZU	3C	98
GU	3C	3D	PT	3C	6B			

● System Commands

Commands relating to RS-232C control system.

Command	Description
01	Complete: Issued by the VTR upon completing all specified operations by commands such as Title Search.
02	Error: Issued by the VTR when receiving invalid commands in the context. In such cases, commands that are sent will not be accepted. However, a return command will be issued but only to the Status Sense. To clear the Error status, perform command 56 (Clear).
05	Not Target: Issued by the VTR when specified operations by commands such as Title Search cannot be completed properly.
0A	ACK: A return command issued when a defined command is received.
0B	NAK: A return command issued when an undefined or possibly nonexistent command is received.
56	Clear: Clears the Error status.

● Response Commands

Commands for acquiring information such as deck status.

Command	Description
03	Cassette Out: Issued by the VCR deck when the cassette is ejected after ejecting is performed.
60	Chapter Sense: For acquiring the current chapter number.* (DVD Deck)
61	Title/Track Sense: For acquiring the current title number under "ORIGINAL" or in the "PLAY LIST".* (DVD Deck)
B9	Select Sense: For acquiring the status of the inputs, recording mode, audio language selection and subtitle selection.*
BE	Date Data Sense: For acquiring the currently configured year, month and day.*
BF	Clock Data Sense: For acquiring the currently configured hour, minute and second.*
D7	Status Sense: For acquiring the deck information.*
D8	TC Data Sense: For acquiring the total remaining time in the current recording mode when there is a media in the selected deck.*
D9	CTL Data Sense: For acquiring the lapse counter when there is a media in the selected deck.*
DD	JVC Status Sense: Returns data from the unit.*

* See pages 81 - 84 for data format.

Chapter Sense

	1st Byte	2nd Byte	3rd Byte
Chapter Sense	Hundreds	Tens	Ones
60	3*	3*	3*
E.g. (012)	30	31	32

E.g.: When the current chapter is the 12th chapter.

Title/Track Sense under "ORIGINAL"

	1st Byte	2nd Byte	3rd Byte	4th Byte
Title/Track Sense (ORIGINAL)	30	Hundreds	Tens	Ones
61	30	3*	3*	3*
E.g. (045)	30	30	34	35

E.g.: When the current title under "ORIGINAL" is the 45th title.

Title/Track Sense in "PLAY LIST"

	1st Byte	2nd Byte	3rd Byte	4th Byte
Title/Track Sense (PLAY LIST)	38	Hundreds	Tens	Ones
61	38	3*	3*	3*
E.g. (028)	38	30	32	38

E.g.: When the current title under "PLAY LIST" is the 28th title.

Select Sense

	1st Byte	2nd Byte	3rd Byte	4th Byte	5th Byte
Select Sense	External input selection	—	Recording mode selection	Audio language selection	Subtitle selection
B9	3*	2D	**	**	**
E.g. (392D311112)	39	2D	31	11	12

E.g.: When the selection status of the VTR is as follows:

External input selection → L-1 S-VIDEO

Recording mode selection → SP

Audio language selection → ENGLISH

Subtitle selection → GERMAN

For response data for B9, see data format for B8 (Select Preset) on pages 78 - 80.

Date Data Sense For acquiring the currently configured year, month and day in ASCII codes.

	1st Byte	2nd Byte	3rd Byte	4th Byte	5th Byte	6th Byte
Date Sense	Mth (Tens)	Mth (Ones)	Day (Tens)	Day (Ones)	Yr (Tens)	Yr (Ones)
BE	3*	3*	3*	3*	3*	3*
E.g. (01.17.2006)	30	31	31	37	30	36

When the current date is not set, the value is fixed as "—" (0x2D).

Clock Data Sense For acquiring the currently configured hour, minute and second in ASCII codes.

	1st Byte	2nd Byte	3rd Byte	4th Byte	5th Byte	6th Byte
Clock Sense	Hr (Tens)	Hr (Ones)	Min (Tens)	Min (Ones)	Sec (Tens)	Sec (Ones)
BF	3*	3*	3*	3*	3*	3*
E.g. (12:34:56)	31	32	33	34	35	36

When the current time is not set, the value is fixed as "—" (0x2D).

Status Data Sense

D7 STATUS SENSE	1byte		2byte		3byte	
	VCR	DVD	VCR	DVD	VCR	DVD
bit7	0 (Fixed)	1 (Fixed)	Video EE	Video EE	0 (Fixed)	0 (Fixed)
bit6	1 (Fixed)	1 (Fixed)	Audio EE	Audio EE	0 (Fixed)	0 (Fixed)
bit5	0 (Fixed)	0 (Fixed)	0 (Fixed)	0 (Fixed)	0 (Fixed)	0 (Fixed)
bit4	Record Forbidden	Record Forbidden	0 (Fixed)	0 (Fixed)	0 (Fixed)	0 (Fixed)
bit3	Cassette Not Inserted	Disc Not Inserted	Occurrence of abnormality in VTR	Occurrence of abnormality in VTR	0 (Fixed)	0 (Fixed)
bit2	0 (Fixed)	0 (Fixed)	0 (Fixed)	0 (Fixed)	0 (Fixed)	During Repeat Playback (Including PAUSE)
bit1	0 (Fixed)	0 (Fixed)	Start sensor	0 (Fixed)	0 (Fixed)	0 (Fixed)
bit0	RS-232C command error status. Clear using 56 (Clear).	RS-232C command error status. Clear using 56 (Clear).	End sensor	0 (Fixed)	0 (Fixed)	0 (Fixed)

D7 STATUS SENSE	4byte		5byte	
	VCR	DVD	VCR	DVD
bit7	During PLAY (Including STILL and search)	During PLAY (Including STILL and search)	During PAUSE	During PAUSE
bit6	During FF	0 (Fixed)	0 (Fixed)	0 (Fixed)
bit5	During REW	0 (Fixed)	During Forward Shuttle Search (Excluding STILL)	During Forward Shuttle Search (Excluding STILL)
bit4	During STOP	During STOP	During Reverse Shuttle Search (Excluding STILL)	During Reverse Shuttle Search (Excluding STILL)
bit3	During STANDBY (Unit Power Off)	During STANDBY (Unit Power Off)	SPEED CODE 3	SPEED CODE 3
bit2	During CASSETTE EJECT	0 (Fixed)	SPEED CODE 2	SPEED CODE 2
bit1	During REC (Including REC PAUSE)	During REC (Including REC PAUSE)	SPEED CODE 1	SPEED CODE 1
bit0	0 (Fixed)	0 (Fixed)	SPEED CODE 0	SPEED CODE 0

If the status of the VTR matches to that stated in the above tables, the value returned is "1". Otherwise, the value "0" is returned. For details on SPEED CODE 0 - 3, refer to the SPEED CODE table on page 84.

SPEED CODE

	DVD				VCR			
	SPEED CODE 3 (bit3)	SPEED CODE 2 (bit2)	SPEED CODE 1 (bit1)	SPEED CODE 0 (bit0)	SPEED CODE 3 (bit3)	SPEED CODE 2 (bit2)	SPEED CODE 1 (bit1)	SPEED CODE 0 (bit0)
STILL	0	0	0	0	0	0	0	0
FWD/REV SLOW at a slower speed	0	0	0	1	0	0	0	1
FWD/REV SLOW at a slow speed	0	0	1	0				
FWD/REV SLOW at a fast speed	0	0	1	1				
1x/-1x	0	1	0	1	0	1	0	1
FWD/REV SEARCH at a fast speed	0	1	1	0	0	1	1	1
FWD/REV SEARCH at a faster speed	0	1	1	1				
FWD/REV SEARCH at the fastest speed	1	0	0	0	1	0	0	0
FWD/REV SEARCH at the most fastest speed	1	0	0	1				

TC Data Sense For acquiring the remaining time in the current recording mode in hours, minutes and seconds for DVD, and hours and minutes for VCR.

	1st Byte	2nd Byte	3rd Byte	4th Byte	5th Byte	6th Byte	7th Byte	8th Byte
TC Data Sense	Hr (Tens)	Hr (Ones)	Min (Tens)	Min (Ones)	Sec (Tens)	Sec (Ones)	Frame (Tens)	Frame (Ones)
D8	3*	3*	3*	3*	3*	3*	2D	2D
E.g. (01:23:45)	30	31	32	33	34	35	2D	2D

E.g.: When remaining time is 1 hr 23 min 45 sec.

VCR (hr and min only)

DVD (hr, min and sec only)

Frame is fixed as "—" (0x2D).

CTL Data Sense For acquiring lapse counter of selected deck in hours, minutes and seconds.

	1st Byte	2nd Byte	3rd Byte	4th Byte	5th Byte	6th Byte	7th Byte	8th Byte
CTL Data Sense	Hr (Tens)	Hr (Ones)	Min (Tens)	Min (Ones)	Sec (Tens)	Sec (Ones)	Frame (Tens)	Frame (Ones)
D9	3*	3*	3*	3*	3*	3*	2D	2D
E.g. (01:23:45)	30	31	32	33	34	35	2D	2D

E.g.: When time lapse counter is 1 hr 23 min 45 sec.

Frame is fixed as "—" (0x2D).

JVC Status Sense

DD JVC SENSE	1byte		2byte		3byte		4byte	
	VCR	DVD	VCR	DVD	VCR	DVD	VCR	DVD
bit7	1 (Fixed)	1 (Fixed)	0 (Fixed)	0 (Fixed)	1 (Fixed)	1 (Fixed)	1 (Fixed)	1 (Fixed)
bit6	0 (Fixed)	0 (Fixed)	0 (Fixed)	0 (Fixed)	0 (Fixed)	0 (Fixed)	1 (Fixed)	1 (Fixed)
bit5	0 (Fixed)	0 (Fixed)	1 (Fixed)	1 (Fixed)	0 (Fixed)	0 (Fixed)	0 (Fixed)	0 (Fixed)
bit4	During Playback of EP Recorded Tape	0 (Fixed)	0 (Fixed)	0 (Fixed)	0 (Fixed)	0 (Fixed)	0 (Fixed)	0 (Fixed)
bit3	0 (Fixed)	0 (Fixed)	0 (Fixed)	Refer to the DISC TYPE table below.	0 (Fixed)	0 (Fixed)	During dubbing (Including PAUSE)	During dubbing (Including PAUSE)
bit2	0 (Fixed)	0 (Fixed)	0 (Fixed)		0 (Fixed)	0 (Fixed)	0 (Fixed)	0 (Fixed)
bit1	0 (Fixed)	0 (Fixed)	1 (Fixed)		0 (Fixed)	0 (Fixed)	0 (Fixed)	0 (Fixed)
bit0	1 (Fixed)	1 (Fixed)	0 (Fixed)		During dubbing (Including PAUSE)	During dubbing (Including PAUSE)	0 (Fixed)	0 (Fixed)

DISC TYPE

	bit3	bit2	bit1	bit0
DVD	0	0	0	0
DVD-RAM	0	0	0	1
DVD-R	0	0	1	0
DVD-RW	0	0	1	1
DVD+R	0	0	0	0
DVD+RW	0	0	0	0
VCD	0	1	1	0
CD	0	1	1	1
...
No disc	1	1	1	1

GENERAL**Power requirement**

AC 120 V~, 60 Hz

Power consumption

Power on: 52 W

Power off: 2.7 W

Temperature

Operating: 5°C to 35°C (41°F to 95°F)

Storage: -20°C to 60°C (-4°F to 140°F)

Operating position

Horizontal only

Dimensions (WxHxD)

435 mm x 96 mm x 343 mm (17-3/16" x 3-13/16" x 13-1/2")

Weight

5.5 kg (12.1 lbs)

Input/Output

S-video input:

Y: 0.8 – 1.2 Vp-p, 75 ohms

C: 0.2 – 0.4 Vp-p, 75 ohms

S-video output:

Y: 1.0 Vp-p, 75 ohms

C: 0.3 Vp-p, 75 ohms

Video input: 0.5 – 2.0 Vp-p, 75 ohms (pin jack)

Video output: 1.0 Vp-p, 75 ohms (pin jack x1, BNC x 1)

Audio input:

-8 dB, 50 kohms (pin jack)

Corresponding to mono (left)

Audio output: -8 dB, 1 kohms (pin jack)

i.Link: 4-pin for DV input

Component video output:

Y: 1.0 Vp-p, 75 ohms

Cb/CR, Pb/PR: 0.7 Vp-p, 75 ohms

Corresponding to copy protection

Remote Input: ø3.5 mm

Serial Command: D-SUB 9-PIN

Digital audio output:

Optical: -18 dBm, 660 nm

Coaxial: 0.7 Vp-p, 75 ohms

Corresponding to Dolby Digital and DTS Digital Surround

Bit stream

Selectable in digital audio output setting menu

VIDEO/AUDIO (VCR Deck)**Signal system**

NTSC color signal and EIA monochrome signal, 525 lines/60 fields

Recording system

DA4 (Double Azimuth) head helical scan system

Format

S-VHS/VHS NTSC standard

Maximum recording time

(SP): 210 min. with ST-210 video cassette

(EP): 30 min. with ST-210 video cassette

Signal-to-noise ratio

45 dB

Horizontal resolution

230 lines

Frequency range

(Normal audio): 70 Hz to 10,000 Hz

(Hi-Fi audio): 20 Hz to 20,000 Hz

Specifications shown are for SP mode unless otherwise specified.

ACCESSORIES**Provided accessories**

Audio cable,

S-video cable,

Infrared remote control unit,

"AA" battery x 2

E.& O.E. Design and specifications subject to change without notice.

ATTENTION:

This unit contains microcomputers. External electronic noise or interference could cause malfunctioning. In such cases, switch the unit off and unplug the mains power cord. Then plug it in again and turn the unit on. Take out the disc. After checking the disc, operate the unit as usual.

VIDEO/AUDIO (DVD Deck)**Recording format**

DVD-RAM: DVD Video Recording format

DVD-R: DVD-Video format

DVD-RW: DVD-Video format, DVD Video Recording format

Recording time

Maximum 8 hours (with 4.7 GB disc)

(XP): Approx. 1 hour

(SP): Approx. 2 hours

(LP): Approx. 4 hours

(EP): Approx. 6 hours

(FR): Approx. 1 hour – 8 hours

Audio recording system

Dolby Digital (2 ch)

Linear PCM (XP mode only)

Video recording compression system

MPEG2 (CBR/VBR)

A		O	
A-B Repeat Playback	29	On-screen bar	28
Accidental erasure prevention	36	On-screen Language Set	18
Active Video Calibration	38	P	
Adjusting The Picture Quality	30	Pan&Scan	19
Angle Selection	23	Play List	42
Audio Channel Selection	24	Playback	20 – 35
Audio Language/Sound Selection	23	Playback Control (PBC)	24
Auto Finalizing	46	Program Playback	31
C		R	
Clock Set	17	Random Playback	31
Copy mode	60	Recordable/playable discs	7
D		Recording	36 – 38
Daylight Saving Time	17	Recording Medium And Format	8
Delete Program	41	Recording Mode	37
Digital TBC/NR	35	Region Number	8
Disc menu	21	Register Disc	44
Disc Remaining Time	37	Remote control 1/2/3/4 Code Switching	55
Discs For Playback Only	7	Repeat Playback	29, 35
Dubbing	46 – 54	Repeat Recording	38
DVD menu	21	Resume Function	22
E		RS-232C Interface	73 – 85
Elapsed Recording Time Indication	37, 38	S	
F		Select The Switching Interval Of The Slide Show	31
File Structure Of Discs	8	Setting The Progressive Mode	31
Finalize A Disc	63	Simulated Surround Effect	30
Format A Disc	62	Simultaneous Recording	36
Free Rate Function	37	Skip Search	22, 34
I		Slow Motion	22, 34
Index Search	34	Soundtrack Selection	35
Initial settings	17 – 19	Still Picture/Frame-By-Frame Playback	22, 34
Input select	36	Subtitle Selection	23
Instant Replay	27, 34	T	
J		Tape Position Indicator	14
JPEG	7, 9, 45	Tape Remaining Time	38
L		Time Search	30
Last Function Memory	65	Top menu	21
Letter Box	19	Tray Lock	65
Live Memory	24	Troubleshooting	66 – 68
M		TV Multi-Brand Remote Control	55
Manual Tracking	35	U	
Marking Positions To Play Back Again Later	22	Unplayable Discs	8
Menu/Audio/Subtitle Language Set	18	Usable cassettes	33
Mode Lock	65	V	
Mode Set	58 – 61	Variable Speed Search	21, 34
MP3	7, 9, 45	Video input select (S-VIDEO/VIDEO)	59
N			
Next Function Memory	35		

EN

**SR-MV55U/
SR-MV45U**

JVC
VICTOR COMPANY OF JAPAN, LIMITED

Free Manuals Download Website

<http://myh66.com>

<http://usermanuals.us>

<http://www.somanuals.com>

<http://www.4manuals.cc>

<http://www.manual-lib.com>

<http://www.404manual.com>

<http://www.luxmanual.com>

<http://aubethermostatmanual.com>

Golf course search by state

<http://golfingnear.com>

Email search by domain

<http://emailbydomain.com>

Auto manuals search

<http://auto.somanuals.com>

TV manuals search

<http://tv.somanuals.com>