

JVC



ATTENTION !

Check all accessories listed on page 101.

**HDD & S-VHS
VIDEO RECORDER**

HM-HDS4EK

FIRST

See
AUTO SET UP
on **PAGE 14**

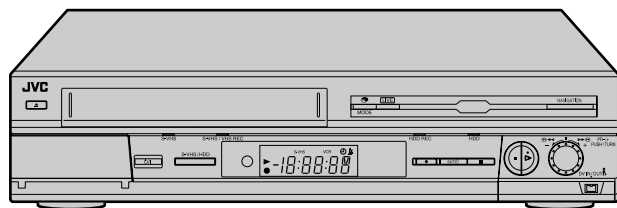

HDD **S-VHS**
625
VIDEO Plus+ **Hi-Fi**
DELUXE
Super VHS ET

INSTRUCTIONS

Safety Precautions

The rating plate and the safety caution are on the rear of the unit.

WARNING: DANGEROUS VOLTAGE INSIDE

WARNING: TO PREVENT FIRE OR SHOCK HAZARD, DO NOT EXPOSE THIS UNIT TO RAIN OR MOISTURE.

CAUTION

- When you are not using the recorder for a long period of time, it is recommended that you disconnect the power cord from the mains outlet.
- Dangerous voltage inside. Refer internal servicing to qualified service personnel. To prevent electric shock or fire hazard, remove the power cord from the mains outlet prior to connecting or disconnecting any signal lead or aerial.

IMPORTANT

Connection to the mains supply in the United Kingdom. DO NOT cut off the mains plug from this equipment.

If the plug fitted is not suitable for the power points in your home or the cable is too short to reach a power point, then obtain a proper safety approved extension lead/adaptor or consult your dealer.

In the unlikely event of the plug fuse failing be sure to replace the fuse only with an identical approved type, as originally fitted, and to replace the fuse cover. If the fuse fails again consult your nearest JVC dealer.

If nonetheless the mains plug is cut off remove the fuse and dispose of the plug immediately, to avoid a possible shock hazard by inadvertent connection to the mains supply.

If this product is not supplied fitted with a mains plug then follow the instructions given below:

DO NOT make any connection to the Larger Terminal coded E or Green.

The wires in the mains lead are coloured in accordance with the following code:



Blue to N (Neutral) or Black
Brown to L (Live) or Red

If these colours do not correspond with the terminal identifications of your plug, connect as follows:
Blue wire to terminal coded N (Neutral) or coloured Black.
Brown wire to terminal coded L (Live) or coloured Red.
If in doubt — consult a competent electrician.

IMPORTANT

- Please read the various precautions on pages 2 – 3 before installing or operating the recorder.
- It should be noted that it may be unlawful to re-record pre-recorded tapes, records, or discs without the consent of the owner of copyright in the sound or video recording, broadcast or cable programme and in any literary, dramatic, musical, or artistic work embodied therein.

The STANDBY/ON $\phi/1$ button does not completely shut off mains power from the unit, but switches operating current on and off. " ϕ " shows electrical power standby and "1" shows ON.

Video tapes recorded with this video recorder in the LP (Long Play) mode cannot be played back on a single-speed video recorder.

When the equipment is installed in a cabinet or a shelf, make sure that it has sufficient space on all sides to allow for ventilation (10 cm or more on both sides, on top and at the rear.)

When discarding batteries, environmental problems must be considered and the local rules or laws governing the disposal of these batteries must be followed strictly.

Failure to heed the following precautions may result in damage to the recorder, remote control or video cassette.

1. **DO NOT** place the recorder ...

- ... in an environment prone to extreme temperatures or humidity.
- ... in direct sunlight.
- ... in a dusty environment.
- ... in an environment where strong magnetic fields are generated.
- ... on a surface that is unstable or subject to vibration.

2. **DO NOT** block the recorder's ventilation openings or holes. (If the ventilation openings or holes are blocked by a newspaper or cloth, etc., the heat may not be able to get out.)

3. **DO NOT** place heavy objects on the recorder or remote control.

4. **DO NOT** place anything which might spill on top of the recorder or remote control.

(If water or liquid is allowed to enter this equipment, fire or electric shock may be caused.)

5. **DO NOT** expose the apparatus to dripping or splashing.

6. **DO NOT** use this equipment in a bathroom or places with water. Also **DO NOT** place any containers filled with water or liquids (such as cosmetics or medicines, flower vases, potted plants, cups, etc.) on top of this unit.

7. **DO NOT** place any naked flame sources, such as lighted candles, on the apparatus.

8. **AVOID** violent shocks to the recorder during transport.

HDD

S-VHS
625

VIDEO Plus+
DELUXE

- Cassettes marked "S-VHS" and "VHS" can be used with this video cassette recorder. However, S-VHS recordings are possible only with cassettes marked "S-VHS".
By using the S-VHS ET function, it is possible to record and play back with S-VHS picture quality on VHS cassettes with this recorder.
- VIDEO Plus+ and PlusCode are registered trademarks of Gemstar Development Corporation. The VIDEO Plus+ system is manufactured under license from Gemstar Development Corporation.
- This product incorporates copyright protection technology that is protected by method claims of certain U.S. patents and other intellectual property rights owned by Macrovision Corporation and other rights owners. Use of this copyright protection technology must be authorized by Macrovision Corporation, and is intended for home and other limited viewing users only unless otherwise authorized by Macrovision Corporation.
Reverse engineering or disassembly is prohibited.

MOISTURE CONDENSATION

Moisture in the air will condense on the recorder when you move it from a cold place to a warm place, or under extremely humid conditions—just as water droplets form in the surface of a glass filled with cold liquid. Moisture condensation on the head drum will cause damage to the tape. In conditions where condensation may occur, keep the recorder turned on for a few hours to let the moisture dry.

ATTENTION:

To mobile phone users:

Using a mobile phone in the vicinity of the recorder may cause picture vibration on the TV screen or change the screen to a blue back display.

On placing the recorder:

Some TVs or other appliances generates strong magnetic fields. Do not place such appliance on top of the recorder as it may cause picture disturbance.

PRECAUTION FOR Hard Disk Drive

1. Before installing the recorder

This recorder has a built-in hard disk drive, which is a device to read minute magnetic changes.

The inside of the device is precision-built, which, when installing the recorder, requires you to note the following:

- DO NOT use the recorder in a location prone to vibration or dust.
- DO NOT place the recorder where difference in temperatures is large (condensation can occur), or where humidity is high.
 - When condensation occurs
Water droplets form on the hard disc or head drums inside, possibly causing hard disc and heads to be damaged.
 - About condensation
When well-cooled beer is poured into a glass, water droplets often form around its outside. This phenomenon is called condensation.
- DO NOT install the recorder where the cooling fans in its back may be blocked, or where the recorder may be closed in.
- DO NOT use the recorder placed vertically.

NOTES:

- *When you connect the recorder's power plug to the mains outlet, the HDD starts its setup and it continues for a while. Press $\psi/1$ on the recorder to use it after the HDD completes its setup.*
- *The hard disk may produce mechanical noise, but it is not a malfunction.*

2. Before using the recorder

When the power of the unit is on, the hard disc is constantly rotating at high speed.

This requires you to note the following:

- DO NOT impart vibration or shock.
If given a heavy shock, not only is the data recorded damaged but also the hard disk itself can be damaged.
- DO NOT allow anything having strong magnetism or emitting strong electromagnetic waves (cell phones, etc.) near the recorder.
- DO NOT disconnect the power plug from the wall outlet when the power of the recorder is on.
If the power supply is cut off while the hard disc is in operation, it can be damaged or the data stored on it may be damaged. Be sure to push the power button before turning off the power.

3. While using the recorder

When viewing a program by selecting HDD (Hard Disk Drive), there occurs a slight time lag relative to the actual program being broadcast. This is because pictures received are once stored on the hard disk, and then played back. The time lag is about three seconds. If you turn the power on with the hard disk already selected, it will take about 30 seconds before the pictures received appear on the screen. Up until then, any operation is disabled. But it is not a malfunction.

Some Do's And Don'ts On The Safe Use Of Equipment

This equipment has been designed and manufactured to meet international safety standards but, like any electrical equipment, care must be taken if you are to obtain the best results and safety is to be assured.

- DO** read the operating instructions before you attempt to use the equipment.
- DO** ensure that all electrical connections (including the mains plug, extension leads and interconnections between pieces of equipment) are properly made and in accordance with the manufacturer's instructions. Switch off and withdraw the mains plug when making or changing connections.
- DO** consult your dealer if you are ever in doubt about the installation, operation or safety of your equipment.
- DO** be careful with glass panels or doors on equipment.

- DON'T** continue to operate the equipment if you are in any doubt about it working normally, or if it is damaged in any way — switch off, withdraw the mains plug and consult your dealer.
- DON'T** remove any fixed cover as this may expose dangerous voltages.
- DON'T** leave equipment switched on when it is unattended unless it is specifically stated that it is designed for unattended operation or has a standby mode. Switch off using the switch on the equipment and make sure that your family knows how to do this. Special arrangements may need to be made for infirm or handicapped people.
- DON'T** use equipment such as personal stereos or radios so that you are distracted from the requirements of road safety. It is illegal to watch television whilst driving.
- DON'T** listen to headphones at high volume, as such use can permanently damage your hearing.
- DON'T** obstruct the ventilation of the equipment, for example with curtains or soft furnishings. Overheating will cause damage and shorten the life of the equipment.
- DON'T** use makeshift stands and NEVER fix legs with wood screws — to ensure complete safety always fit the manufacturer's approved stand or legs with the fixings provided according to the instructions.
- DON'T** allow electrical equipment to be exposed to rain or moisture.

ABOVE ALL...

- **NEVER** let anyone especially children push anything into holes, slots or any other opening in the case — this could result in a fatal electrical shock;
- **NEVER** guess or take chances with electrical equipment of any kind — it is better to be safe than sorry!

SAFETY FIRST	2
Safety Precautions	2
Some Do's And Don'ts On The Safe Use Of Equipment	4
INDEX	6
INSTALLING YOUR NEW RECORDER	12
Basic Connection	12
S-VIDEO Connection	13
INITIAL SETTINGS	14
Auto Set Up	14
Preset Download	16
SAT CONTROL SET	18
Satellite Receiver Control Setting	18
SAT CONTROL SET (cont.)	20
T-V LINK	21
T-V Link Functions	21
RECORDING/PLAYBACK ON HDD DECK	22
Basic Recording	22
Basic Playback	23
Playback with HDD Navigation	24
Live Memory Features	28
Playback Features	30
Recording Features	33
RECORDING/PLAYBACK ON VHS DECK	34
Basic Recording	34
Basic Playback	35
Playback with VCR Navigation	36
Playback Features	39
Recording Features	42
B.E.S.T. Picture System	45
TIMER RECORDING	46
VIDEO PLUS+® Timer Programming	46
Express Timer Programming	48
Automatic Satellite Programme Recording	51
REMOTE CONTROL FUNCTIONS	52

EDITING	55
About Hybrid Navigation	55
Modify Information	56
Play List Features	60
Dubbing	63
Normal Dubbing (from HDD to VHS)	65
Normal Dubbing (from VHS to HDD)	66
Edit From A Camcorder	67
Output/Input Set	68
Edit To Or From Another Video Recorder	70
DV Dubbing	72
Audio Dubbing	74
SYSTEM CONNECTIONS	76
Connecting To A Satellite Receiver	76
Connecting/Using A Stereo System	77
SUBSIDIARY SETTINGS	78
Mode Set	78
VIDEO PLUS+® System Setup	83
Clock Set	84
Tuner Set	86
HELP	93
Help Function	93
TROUBLESHOOTING	94
QUESTIONS AND ANSWERS	99
SPECIFICATIONS	100
Check Contents	101
LIST OF TERMS	102

FRONT VIEW

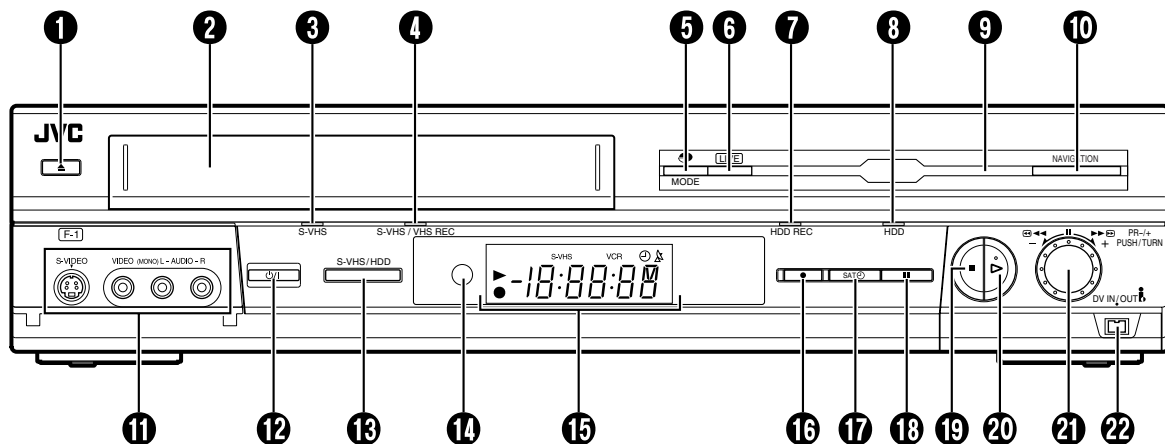

- ❶ Eject ▲ Button ☞ pg. 34
- ❷ Cassette Loading Slot
- ❸ S-VHS mode Indicator ☞ pg. 34
- ❹ S-VHS/VHS Recording Mode Indicator (S-VHS/VHS REC) ☞ pg. 34
- ❺ MODE Button ☞ pg. 9, 22
HDD Capacity Check Ⓞ Button ☞ pg. 9
- ❻ LIVE Button* ☞ pg. 41
* Press this button to return to on air programme screen. When a confirmation message appears by pressing this button during timer programming or title editing, etc., follow the instruction to return to the previous screen.
- ❼ HDD Recording Mode Indicator (HDD REC) ☞ pg. 22
- ❽ HDD Mode Indicator ☞ pg. 22
- ❾ Hard Disk Drive Illumination ☞ pg. 79
- ❿ NAVIGATION Button ☞ pg. 25
- ⓫ S-VIDEO/VIDEO/AUDIO Input Connectors ☞ pg. 67

- ⓬ STANDBY/ON ⏻/⏿ Button ☞ pg. 14
- ⓭ S-VHS/HDD Button ☞ pg. 22
- ⓮ Infrared Beam Receiving Window
- ⓯ Front Display Panel ☞ pg. 7
- ⓰ Record ● Button ☞ pg. 22
- ⓱ SATO Button ☞ pg. 51
- ⓲ Pause || Button ☞ pg. 23
- ⓳ Stop ■ Button ☞ pg. 22
- ⓴ Play ► Button ☞ pg. 23
- ⓵ Advanced JOG Dial ☞ pg. 25
- ⓶ DV IN/OUT Connector (i.Link*) ☞ pg. 72
* i.Link refers to the IEEE1394-1995 industry specification and extensions thereof. The  logo is used for products compliant with the i.Link standard.

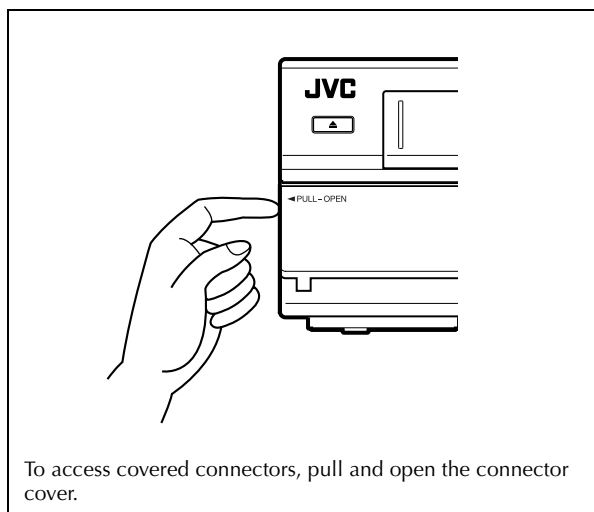

To access covered connectors, pull and open the connector cover.

REAR VIEW

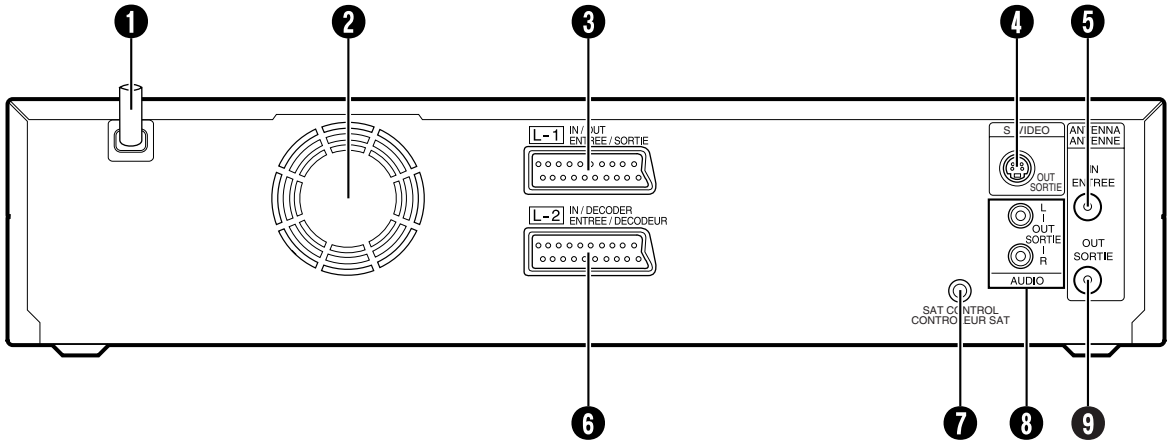

- ❶ Mains Power Cord ☞ pg. 12
- ❷ Cooling Fan
 - This prevents the temperature from rising inside the recorder. Do not remove it.
 - Install the recorder so as not to block the area around the fan.
 - The fan may be activated even if the recorder is turned off.
- ❸ L-1 IN/OUT Connector ☞ pg. 12, 68, 70, 75, 76
- ❹ S VIDEO OUT Connector ☞ pg. 13
- ❺ ANTENNA IN Connector ☞ pg. 12
- ❻ L-2 IN/DECODER Connector ☞ pg. 18, 70, 75, 76
- ❼ SAT CONTROL Connector ☞ pg. 18
- ❽ AUDIO OUT (L/R) Connectors ☞ pg. 13, 77
- ❾ ANTENNA OUT Connector ☞ pg. 12

FRONT DISPLAY PANEL

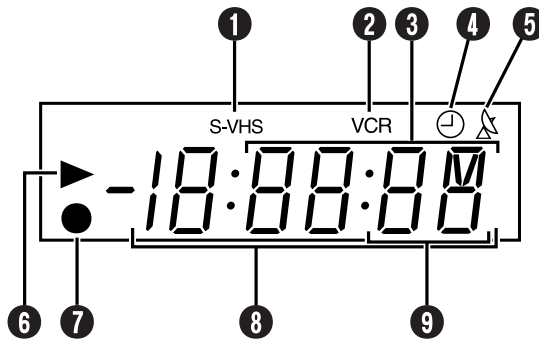

- ❶ S-VHS Indicator (S-VHS deck only) ☞ pg. 80
- ❷ VCR Indicator (S-VHS deck only) ☞ pg. 76
- ❸ Channel/Clock Remain Display (S-VHS deck only) ☞ pg. 43
Mode Display (L-1, L-2 (or SAT*), F-1, d-1, or dub)
* When "L-2 SELECT" is set to "SAT" (☞ pg. 69), "SAT" appears instead of "L-2".
- ❹ "Timer" Indicator ☞ pg. 47
- ❺ Automatic Satellite Programme Recording Indicator (Ⓜ) (S-VHS deck only) ☞ pg. 51
- ❻ Play Indicator
- ❼ Record Indicator ☞ pg. 33
- ❽ Counter Display
- ❾ Tape Speed SP/LP (S-VHS deck only) ☞ pg. 34

ON-SCREEN DISPLAY (for HDD deck)

When "O.S.D." is set to "ON" (☞ pg. 82), various operational information appear on the TV screen. You can show or clear the following operational information by pressing **Ⓢ**. Each time you press **Ⓢ**, the information appears and disappears alternately.

When playing back a recorded programme

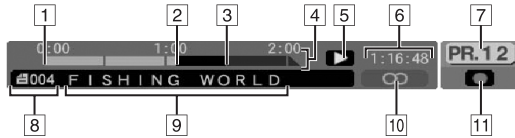

- 1 Programme start
- 2 Current playback point
- 3 Programme end
- 4 Time scale (This programme is an hour and a half long.)
- 5 Play mode
- 6 Elapsed playing time
- 7 Current received (recording) channel position number (On playback background)
- 8 Recorded programme (or play list) number currently being played back
- 9 Title of programme currently being played back
- 10 Audio mode
- 11 Live Memory mode (recording)

When watching a programme on air



- 1 Possible start point from where Live Memory Playback can be performed
- 2 Possible start point from where Live Memory Recording can be performed (Receive channel has changed at this point.)
- 3 Currently viewed point
- 4 Time scale
- 5 Current time
- 6 Current received channel position number

When using Live Memory playback

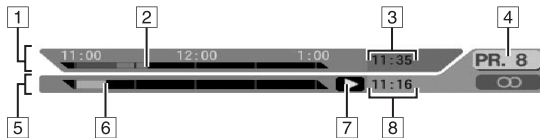

- 1 Time scale for Temporary Recording
- 2 Current Temporary Recording point
- 3 Current time
- 4 Current playback channel position number
- 5 Time scale for Live Memory Playback
- 6 Current playback point
- 7 Live Memory playback mode
- 8 Current playback time

When recording



- 1 Live Memory Recording point
- 2 Live Memory Recording mode

ON-SCREEN DISPLAY (for HDD deck)

When "O.S.D." is set to "ON" (pg. 82), various operational information appear on the TV screen.

When pressing MODE ()
(Appears for eight seconds.)

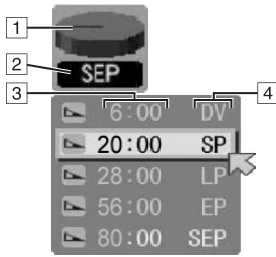

- 1 HDD capacity graph
(Six conditions (full, 60 hours or less open, 40 hours or less open, 20 hours or less open, 10 hours or less open, empty) is displayed in SEP mode.)
- 2 Current recording speed
- 3 Remaining HDD time for each recording speed
- 4 Recording speed

When pressing ● during recording



- 1 Recording time for Instant Timer Recording (ITR) mode*
- * When "d-1" is selected as an input source, this ITR display does not appear on the TV screen.

ON-SCREEN DISPLAY (for DV dubbing)

When "O.S.D." is set to "ON" (pg. 82), various operational information appear on the TV screen.

You can show or clear the following operational information by pressing ①. Each time you press ①, the information appears and disappears alternately.

When capturing images from the external DV equipment

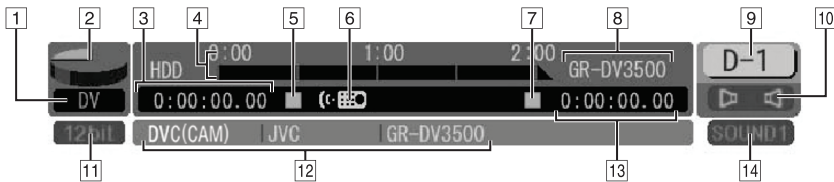

- 1 Recording speed
- 2 HDD capacity graph
- 3 HDD time counter
- 4 Recording time scale
- 5 HDD mode
- 6 Remote control mode
- 7 Connected DV equipment mode

- 8 Connected DV equipment model information
- 9 Input channel
- 10 Sound mode
- 11 Sound input bit-rate*
* Indicates the sound bit-rate of the connected DV equipment
- 12 Connected DV equipment information*
* Maker name and model name, etc. may not appear depending on the connected equipment.
- 13 Time counter for the connected DV equipment
- 14 Sound monitor mode

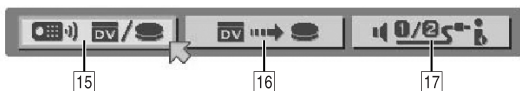

- 15 Remote control switch
- 16 Auto capture button
- 17 Sound monitor switch



- 18 Sound bit-rate*
* Set in DV AUDIO REC setting
- 19 Elapsed recording time

ON-SCREEN DISPLAY (for VHS deck)

When "O.S.D." is set to "ON" (☞ pg. 82), various operational indicators appear on the TV screen.

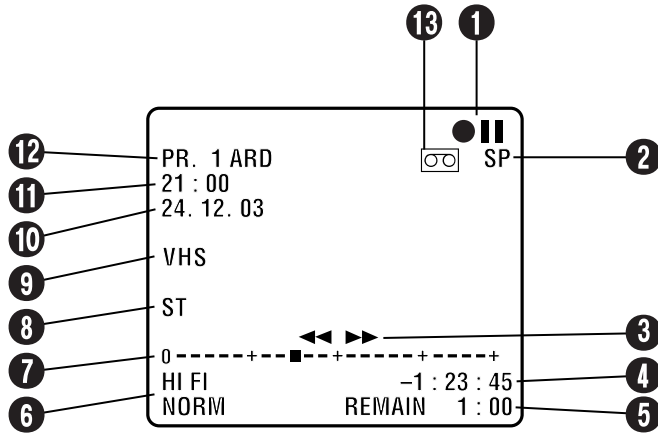

- ❶ Operation Mode Indicators
- ❷ Tape Speed SP/LP
- ❸ Tape Direction
- ❹ Counter Display
- ❺ Tape Remaining Time Indicator ☞ pg. 43
- ❻ Audio Mode Display ☞ pg. 41
- ❼ Tape Position Indicator
- ❽ Type of Broadcast ☞ pg. 44
- ❾ VHS Indicator
- ❿ Current Day/Month/Year
- ⓫ Clock Display
- ⓬ Channel Position Number and Station Name/
Auxiliary Input Indicator (L-1, L-2 (or SAT*), F-1,
D-1, or DUB)
- * When "L-2 SELECT" is set to "SAT" (☞ pg. 69), "SAT" appears
instead of "L-2".
- ⓭ "Cassette Loaded" Mark

The tape position indicator appears on the TV screen when you press ◀◀ or ▶▶ from the Stop mode or perform an Index Search (☞ pg. 40). The position of "■" in relation to "0" (beginning) or "+" (end) shows you where you are on the tape.

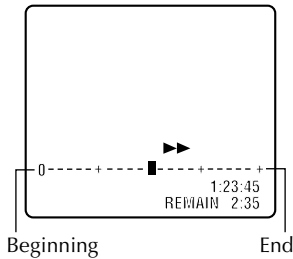

NOTE:

Depending on the type of tape being used, the tape position indicator may not appear correctly.

REMOTE CONTROL

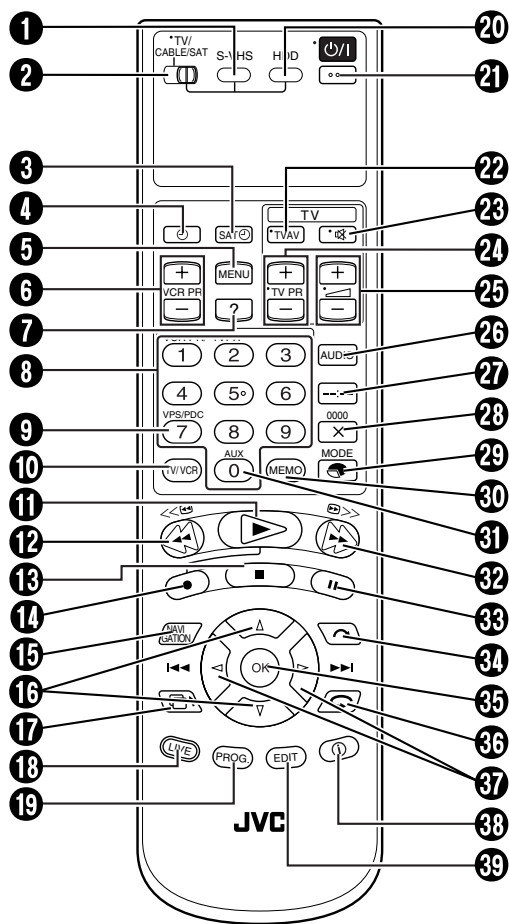

Buttons with a small dot on the left side of the name can also be used to operate your TV. (☞ pg. 53)

- 1 S-VHS Button ☞ pg. 34
 - 2 TV/CABLE/SAT Switch ☞ pg. 53, 54
 - 3 SAT ⊖ Button ☞ pg. 51
 - 4 Timer ⊖ Button ☞ pg. 47
 - 5 MENU Button ☞ pg. 19
 - 6 VCR PR +/- Button ☞ pg. 22
 - 7 Help ? Button ☞ pg. 93
 - 8 Number Keys ☞ pg. 22, 46
 - 9 PDC Button* ☞ pg. 47
- * VPS (Video Programme System) recording is not currently available in the U.K. and not possible with this recorder.
- 10 TV/VCR Button ☞ pg. 53
 - 11 Play ► Button ☞ pg. 23
 - 12 Rewind ◀◀ Button ☞ pg. 30
 - 13 Stop ■ Button ☞ pg. 22
 - 14 Record ● Button ☞ pg. 22
 - 15 NAVIGATION Button ☞ pg. 25
 - 16 △ ▽ Button ☞ pg. 14

- 17 Resume ◀▶ Button* ☞ pg. 93

* Press this button to return to the previous screen on the Navigation screen. When a confirmation message appears by pressing this button during timer programming or title editing, etc., follow the instruction to return to the previous screen.

- 18 LIVE Button*

Auto Tracking Button ☞ pg. 41

* Press this button to return to an air programme screen. When a confirmation message appears by pressing this button during timer programming or title editing, etc., follow the instruction to return to the previous screen.

- 19 PROG. Button ☞ pg. 46, 48
- 20 HDD Button ☞ pg. 22
- 21 STANDBY/ON ⏻/⏻ Button ☞ pg. 14
- 22 TV AV Button ☞ pg. 53
- 23 ⓧ (TV Muting) Button ☞ pg. 53
- 24 TV PR +/- Button ☞ pg. 53
- 25 TV ◀ +/- Button ☞ pg. 53
- 26 AUDIO Button ☞ pg. 32, 41
- 27 Display --:-- Button ☞ pg. 43
- 28 Counter Reset 0000 Button ☞ pg. 43
- 29 Cancel X Button ☞ pg. 53, 63, 89
- 29 ⏪ Button ☞ pg. 9
- MODE Button ☞ pg. 9, 22
- 30 MEMO Button ☞ pg. 26
- 31 AUX Button ☞ pg. 67
- 32 Fast Forward ►► Button ☞ pg. 30
- 33 Pause ⏸ Button ☞ pg. 30
- 34 ~ Button ☞ pg. 31
- 35 OK Button ☞ pg. 14
- 36 ◀ Button ☞ pg. 31
- 37 ◀▶ Button ☞ pg. 14, 31
- 38 Information ⓘ Button* ☞ pg. 8, 9
- 39 EDIT Button ☞ pg. 56

* If you press this button when "O.S.D." is set to "ON" (☞ pg. 82), you can see the current recorder status on the TV screen.

How To Use

The remote control can operate most of your video recorder's functions, as well as basic functions of TV sets and satellite receivers of JVC and other brands. (☞ pg. 53, 54)

- Point the remote control toward the receiving window.
- The maximum operating distance of the remote control is about 8 m.

NOTES:

- When inserting the batteries, be sure to insert in the correct directions as indicated under the battery cover.
- If the remote control doesn't work properly, remove its batteries, wait a short time, replace the batteries and then try again.

Basic Connection

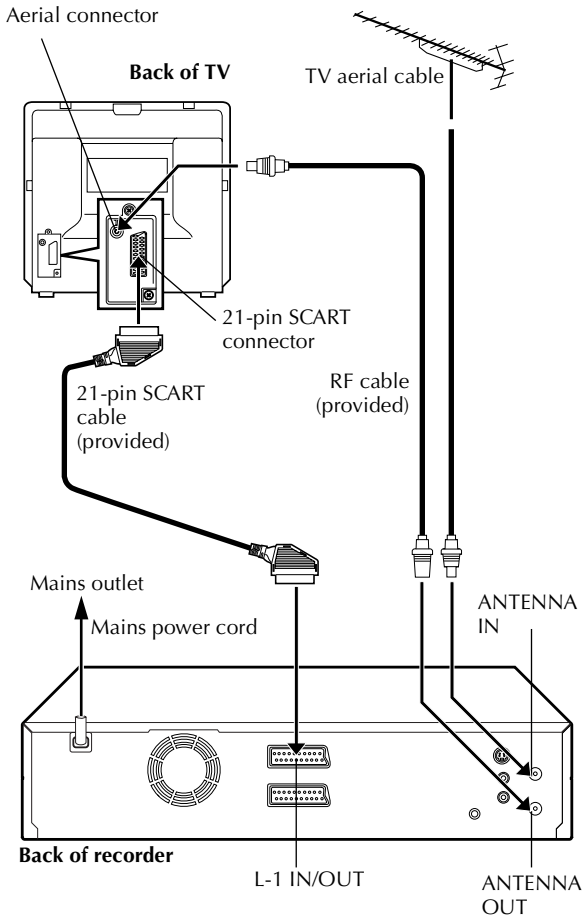

ATTENTION:

Your TV must have a 21-pin AV input connector (SCART) for the connection to the recorder.

It's essential that your video recorder be properly connected.

THESE STEPS MUST BE COMPLETED BEFORE ANY VIDEO OPERATION CAN BE PERFORMED.

1 Check the contents.

Make sure the package contains all of the accessories listed in "Check Contents" on page 101.

2 Situate the recorder.

Place the recorder on a stable, horizontal surface.

3 Connect the recorder to TV.

- 1 Disconnect the TV aerial cable from the TV.
 - 2 Connect the TV aerial cable to the ANTENNA IN connector on the rear panel of the recorder.
 - 3 Connect the provided RF cable between the ANTENNA OUT connector on the rear panel of the recorder and the TV's aerial connector.
 - 4 Connect the provided 21-pin SCART cable between the L-1 IN/OUT connector on the rear panel of the recorder and the TV's 21-pin SCART connector.
- The L-1 IN/OUT connector accepts and delivers either a composite signal (regular video signal) or a Y/C signal (a signal in which the luminance and chrominance signals are separated). If your TV's 21-pin AV input connector (SCART) is compatible with the Y/C signal, set "L-1 OUTPUT" to "S-VIDEO" after the connection and the initial settings are completed (ⓘ pg. 68). You can obtain high-quality S-VHS pictures. (For connection, be sure to use a 21-pin SCART cable that is compatible with the Y/C signal.)
 - Set your TV to the VIDEO (or AV), Y/C, or RGB mode according to the type of your TV's SCART connector.
 - For switching the TV's mode, refer to the instruction manual of your television.
 - To obtain high-quality S-VHS pictures, you can also use the S-VIDEO connection described on page 13.

4 Connect the recorder to mains.

Plug the end of the mains power cord into a mains outlet.

After the connection is completed, perform "Auto Set Up" on page 14.

S-VIDEO Connection

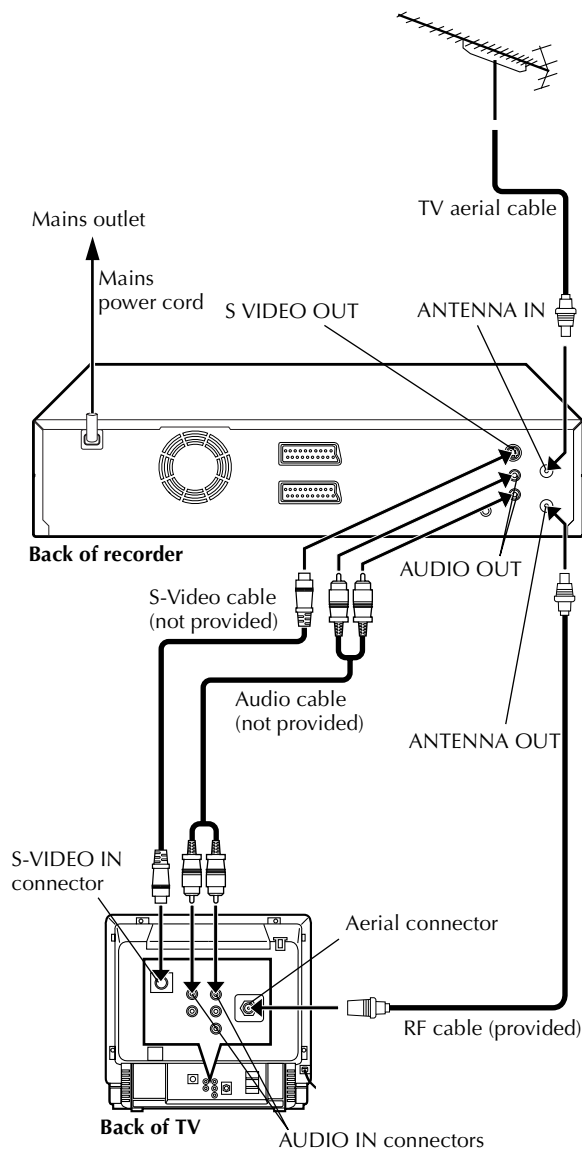

■ To connect to a TV with S-VIDEO/AUDIO IN connectors . . .

1 Connect the recorder to TV.

- 1 Connect the aerial, recorder and TV as per "Basic Connection" (☞ pg. 12).
- 2 Connect the recorder's S VIDEO OUT connector to the TV's S-VIDEO IN connector.
- 3 Connect the recorder's AUDIO OUT connectors to the TV's AUDIO IN connectors.

2 Connect the recorder to mains.

Plug the end of the mains power cord into a mains outlet.

NOTES:

- You can obtain high-quality S-VHS pictures.
- With S-VIDEO connection, you cannot use the Preset Download function (☞ pg. 16).
- If your TV is not stereo-capable, use the recorder's AUDIO OUT connectors to connect to an audio amplifier for Hi-Fi stereo sound reproduction. (☞ pg. 77)
- To operate the recorder with your TV using the S-VIDEO connection, set your TV to its AV mode.
- For switching the TV's mode, refer to the instruction manual of your television.

After the connection is completed, perform "Auto Set Up" on page 14.

Auto Set Up

Auto Channel Set / Auto Clock Set / Auto Guide Program Number Set

Slide TV/CABLE/SAT switch to the right.

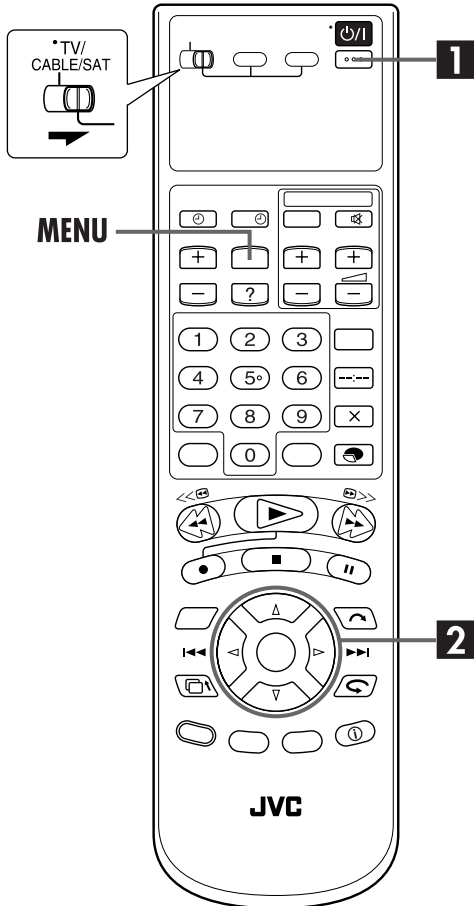

Before starting, make sure of the following:

- The TV aerial cable should be connected to the recorder.
- The recorder's mains power cord should be connected to a mains outlet.
- The TV should be set to its AV mode.

After the P/I button on the recorder or remote control is pressed for the first time to power on the recorder, the Auto Set Up function sets the tuner channels, clock and Guide Program numbers automatically.

1 Turn on the recorder.

Press P/I on the recorder or remote control.

NOTE:

For a few seconds after you pressed P/I , you can not stop Auto Set Up, even if you press **MENU** to cancel this procedure.

2 Perform Auto Set Up.

The AUTO SET/T-V LINK display appears on the front display panel and/or on the TV screen.

On the front display panel

Press Δ to select "Auto" and press **OK** or \triangleright .



On the on-screen display

Press Δ to move the highlight bar (pointer) to "AUTO SET" and press **OK** or \triangleright .

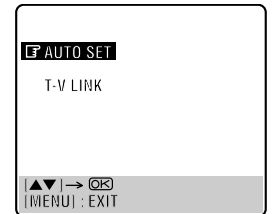

"Auto" blinks on the front display panel; do NOT press any button on the recorder or remote control until the front display panel shows clock time, "(CH) 1" or "--:--" as illustrated on page 17.

- If you are using the on-screen display, the AUTO SET screen will appear. As Auto Set Up progresses, the "█" mark on the TV screen moves from left to right. When the Auto Set Up is completed, "SCAN COMPLETED" appears for about 5 seconds, then the normal screen appears.

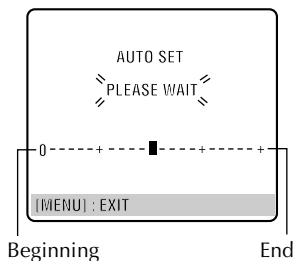

- If you have connected the recorder to a TV offering T-V Link via a 21-pin SCART cable (☞ pg. 12) and the TV is turned on, the recorder automatically performs "Preset Download" (☞ pg. 16) even if you select "Auto" or "AUTO SET" in step 2.

ATTENTION

Once you have performed Auto Set Up, even if the recorder's memory backup has expired, all the stored stations and their Guide Program numbers remain in the recorder's memory and the recorder will not perform Auto Set Up again. You only need to set the clock. (☞ pg. 84)

If you have moved to a different area, perform each setting as required.

- Tuner Set (☞ pg. 86)
- Clock Set (☞ pg. 84)

If a new station starts broadcasting in your area, perform tuner setting (☞ pg. 86).

NOTES:

- In the area where no TV station transmits a PDC (Programme Delivery Control) signal, the recorder can perform neither Auto Clock Set nor Auto Guide Program Number Set.
- If there is a power cut, or if you press $\psi/1$ or **MENU** while Auto Set Up is in progress, Auto Set Up will be interrupted; be sure to turn off the recorder power once and try again from step 1.
- Auto Clock Set may not function properly depending on the reception condition.

Preset Download

Auto Channel Set by Downloading from TV/Auto Clock Set/Auto Guide Program Number Set

ATTENTION

You can use this function only with a TV offering T-V Link, etc.* Be sure to use a fully-wired 21-pin SCART cable.

* Compatible with TVs offering T-V Link, EasyLink, Megalogic, SMARTLINK, Q-Link or DATA LOGIC via fully-wired 21-pin SCART cable. The degree of compatibility and available functions may differ by system.

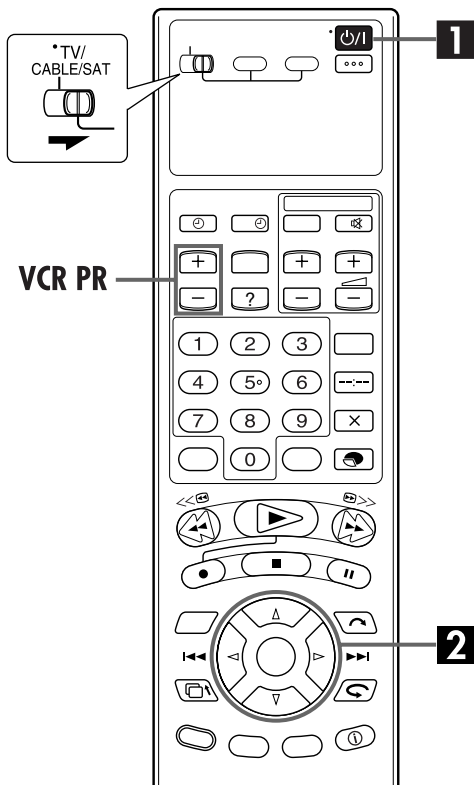

1 Turn on the recorder.

Press O/I on the recorder or remote control.

2 Perform Preset Download.

The AUTO SET/T-V LINK display appears on the TV screen.

Press Δ/∇ to move the highlight bar (pointer) to "T-V LINK" and press **OK** or \triangleright .

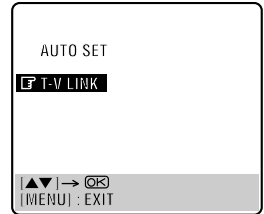

Preset positions on the front display panel increase from "CH1"; do NOT press any button on the recorder or remote control until the front display panel shows clock time, "(CH) 1" or "--:--" as illustrated on page 17.

- If you are using the on-screen display, the T-V LINK screen will appear. Then the GUIDE PROG SET screen will appear during Guide Program Number Set. When Preset Download is completed, "COMPLETED" appears for about 5 seconds, then the normal screen appears.
- If you press any button on the recorder or remote control while downloading is in progress, it will be interrupted.

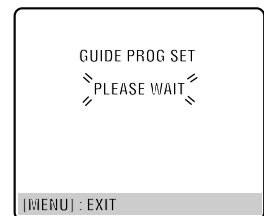
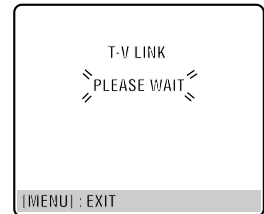

NOTES:

- For details, refer to the instruction manual of your TV.
- In the area where no TV station transmits a PDC (Programme Delivery Control) signal, the recorder can perform neither Auto Clock Set nor Auto Guide Program Number Set.
- If there is a power cut, or if you press O/I or **MENU** while downloading or set up is in progress, it will be interrupted; be sure to turn off the recorder power once and try again from the beginning.
- Auto Clock Set may not function properly depending on the reception condition.
- On this recorder, the characters available for station names (ID) are A-Z, 0-9, -, *, + and _ (space). Some names of downloaded stations may differ from those of your TV (pg. 90).

Results of Auto Set Up/Preset Download appear on the front display panel

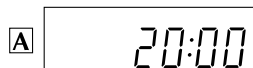

If both Auto Channel Set and Auto Clock Set have been performed successfully, the correct current time is displayed.

Turn on the TV and select its AV mode, then make sure that all necessary stations have been stored in the recorder's memory by using the **VCR PR** button(s).

- If station names (ID –  pg. 91) have also been stored in the recorder's memory, the station name will be displayed at the top left corner of the TV screen for about 5 seconds when the recorder is tuned to a different station.
- If you want to set the tuner manually such as to add or skip channels, to change channel positions, or to set or change station names, see pages 88 – 91.



If Auto Channel Set has succeeded but Auto Clock Set has not, "1" (channel position) is displayed.

 Turn on the TV and select its AV mode, then make sure that all necessary stations have been stored in the recorder's memory by using the **VCR PR** button(s).

- If station names (ID –  pg. 91) have also been stored in the recorder's memory, the station name will be displayed at the top left corner of the TV screen for about 5 seconds when the recorder is tuned to a different station.
- If you want to set the tuner manually such as to add or skip channels, to change channel positions, or to set or change station names, see pages 88 – 91.

 Perform "Clock Set" on page 84.

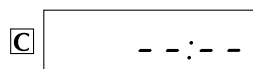



If both Auto Channel Set and Auto Clock Set have failed, "--:--" is displayed.

Make sure the cables are connected properly and turn off the recorder's power once, then turn the recorder's power back on again.

Perform "Auto Set Up" on page 14 or "Preset Download" on page 16 again.

IMPORTANT

- To check if the Guide Program numbers have been set correctly, perform the VIDEO PLUS+ Timer Programming ( pg. 46).
- In certain reception conditions, station names may not be stored correctly, and auto Guide Program Number Set may not work properly. If the Guide Program numbers are not set properly when you timer-record a TV programme using the VIDEO PLUS+ system, the recorder will record a TV programme of a different station. When programming the timer using the VIDEO PLUS+ system, be sure to check the desired channel is selected correctly ( pg. 46, "VIDEO PLUS+ Timer Programming").
- Your video recorder memorizes all detected stations even if reception of some of them is poor. You can delete those stations with an unacceptable picture ( pg. 89, "Delete A Channel").

INFORMATION

Just Clock

Your recorder is equipped with the Just Clock function which provides accurate time keeping through automatic adjustments at regular intervals, by reading data from a PDC signal. If you want to take advantage of this function, simply set it to "ON" ( pg. 84, "Just Clock").

If you have any difficulty with the above procedures call the JVC Customer Service Hot Line on 0870 330 5000

Satellite Receiver Control Setting

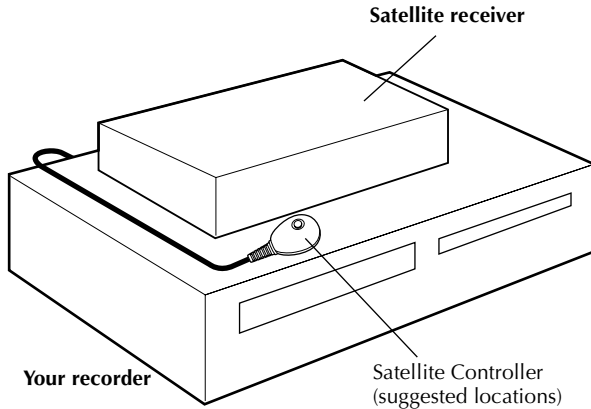

Your recorder

Satellite Controller (suggested locations)

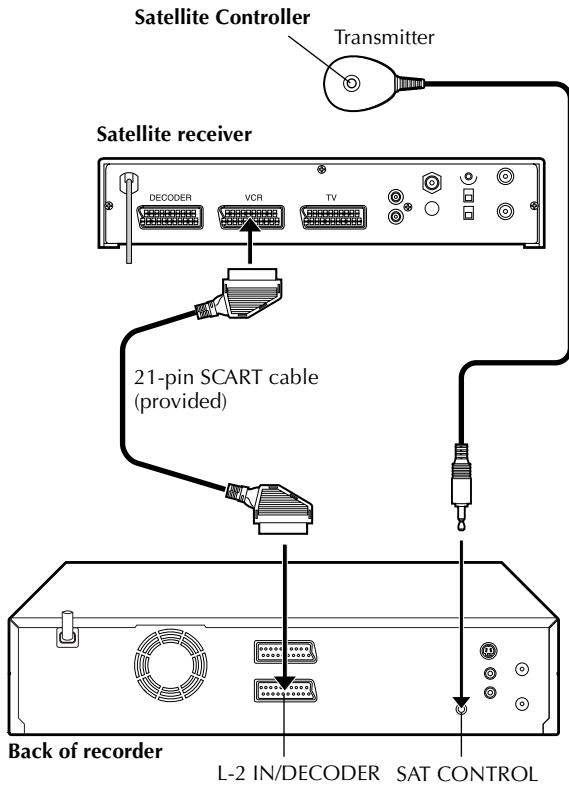

Back of recorder

L-2 IN/DECODER SAT CONTROL

The following procedure is required if you receive satellite channels through a satellite receiver. Approximately 20 seconds before the VIDEO PLUS+ timer programming (pg. 46) or Express timer programming (pg. 48) starts, the recorder sets its input mode to "L-2" and automatically switches the satellite receiver's channels using the provided Satellite Controller.

Installing Satellite Controller

1 Situate the Satellite Controller.

Place the Satellite Controller so that the path between its transmitter and the satellite receiver's remote sensor is unobstructed.

2 Attach the Satellite Controller.

Fix securely using the adhesive strip attached on the back of the Satellite Controller.

3 Make connections.

Be sure to connect the recorder's L-2 IN/DECODER connector to the satellite receiver's 21-pin SCART connector.

NOTE:

When connecting your satellite receiver, refer to its instruction manual.

4 Connect the Satellite Controller to the recorder.

Connect the Satellite Controller to the SAT CONTROL connector on the rear panel.

Setting satellite receiver's brand and channel

After installation, set the satellite receiver's brand and channel correctly; otherwise, the Satellite Controller cannot work correctly.

- Turn on the TV and select the AV mode.
- Slide **TV/CABLE/SAT** switch to the right.

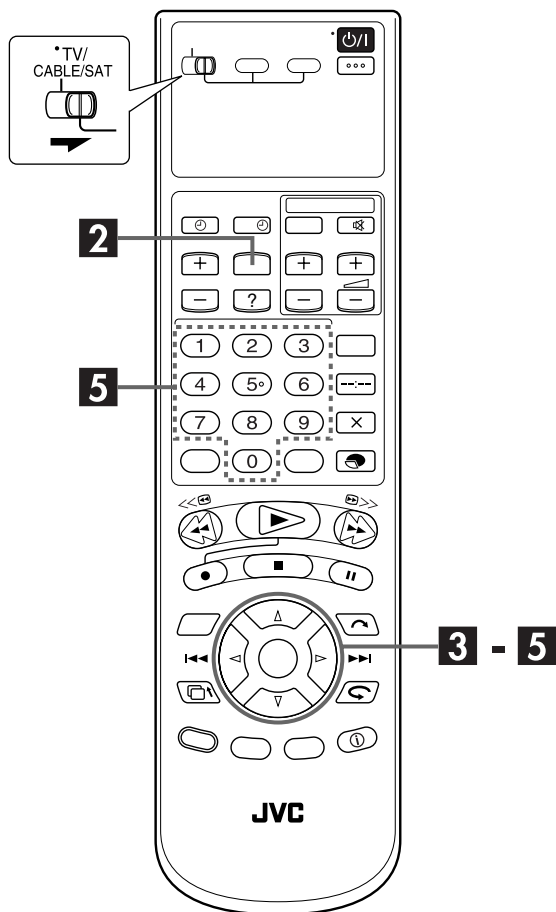

1 Turn on the satellite receiver.

Turn on the satellite receiver's power.

2 Access the Main Menu screen on the recorder.

Press **MENU**.

3 Access the Initial Set screen.

- 1 Press \triangle ∇ to move the arrow to "INITIAL SET UP", then press ∇ .
- 2 Press \triangle ∇ to move the arrow to "INITIAL SET", then press **OK**.

4 Access the Sat Control Set screen.

Press \triangle ∇ to move the highlight bar (pointer) to "SAT CONTROL SET", then press **OK** or \triangleright .



5 Enter the satellite receiver's brand.

Press the appropriate **number keys** to enter the brand code from the list on page 20, then press **OK**.

- If the brand code you entered is invalid, the code field will be reset. Enter the correct brand code again.
- If the recorder is in playback or recording mode, you cannot set the brand code.

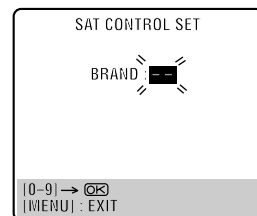

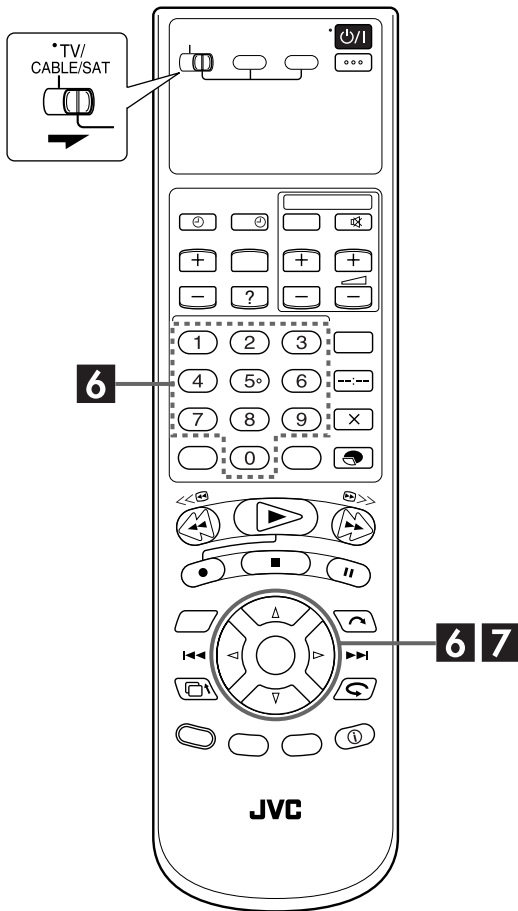

BRAND NAME	CODE
JVC	73
AMSTRAD	60, 61, 62, 63, 92
CANAL SATELLITE	81
CANAL +	81
D-BOX	85
ECHOSTAR (VIA DIGITAL)	82
FINLUX	68
FORCE	89
GALAXIS	88
GRUNDIG	64, 65, 102
HIRSCHMANN	64, 78, 99
HUMAX	88
ITT NOKIA	68
KATHREIN	70, 71, 96
LUXOR	68
MASCOM	93
MASPRO	70
NOKIA	87, 94
PACE	65, 67, 74, 86, 92
PANASONIC	74, 92
PHILIPS	66, 84, 101
RADIX	78
RFT	69
SABA	97
SAGEM	83, 90
SALORA	68
SAMSUNG	83
SIEMENS	64
SKYMASTER	69, 98
TECHNISAT	66, 100
THOMSON	97
TPS	83
TRIAx	91
WISI	64

6 Select the satellite receiver's channel for testing.

Press the appropriate **number keys** to enter one of the channel positions on the satellite receiver, then press **OK**.

- You can select the channel position between 1 to 999.
- After pressing **OK**, the recorder enters the Test mode.

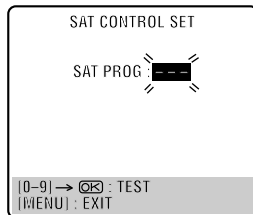

7 Check the result of the test.

If the satellite receiver's channel number has been changed to the same one as you set in step 6 ...

Press Δ / ∇ to move the highlight bar (pointer) to "CHANGED TO ...", then press **OK** or \triangleright to finish the Sat Control Set mode.

If the satellite receiver's channel number has not been changed correctly ...

Press Δ / ∇ to move the highlight bar (pointer) to "NOT CHANGED", then press **OK** or \triangleright . Then perform the procedure again from step 6.



NOTES:

- The Satellite Controller may not work with all types of satellite receiver.
- For some satellite receivers, you need to set its channel input mode to 2-digit.
- If your satellite receiver has more than two channel modes, be sure to set to "All Channel Mode". For details, refer to the instruction manual of the satellite receiver.
- When selecting the satellite receiver's channel (step 6), signals from the remote control may interfere with signals transmitted from the recorder's infrared beam receiving window as possible.

T-V Link Functions

When you connect the recorder to your TV via a fully-wired 21-pin SCART cable (☞ pg. 12), the following functions are available. You can use these functions only with a TV offering T-V Link, etc.*

For details, refer to the instruction manual of your TV.

* Compatible with TVs offering T-V Link, EasyLink, Megalogic, SMARTLINK, Q-Link or DATA LOGIC via fully-wired 21-pin SCART cable. The degree of compatibility and available functions may differ by system.

TV Auto Power On

The TV will turn on and be set to its AV mode automatically whenever you play a tape.

For details, refer to the instruction manual of your TV.

VCR Auto Standby

You can use your TV's remote control to turn off the recorder.

For details, refer to the instruction manual of your TV.

Direct Rec

You can easily start recording the programme that you are watching on your TV. When you use this function, set "DIRECT REC" to "ON" (☞ pg. 82).

Basic Recording

- Turn on the TV and select the AV mode.
- Slide **TV/CABLE/SAT** switch to the right.
- If the recorder is turned on with HDD deck selected, there may be about 30 seconds' delay in starting to show pictures on the screen.

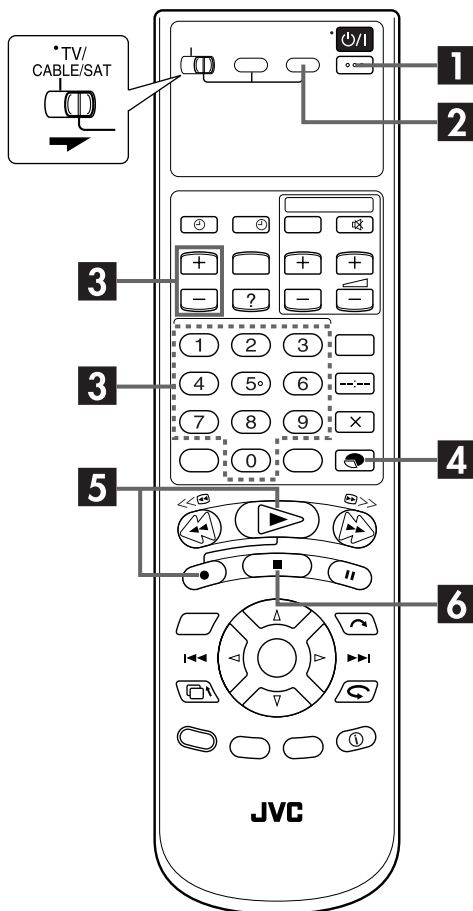
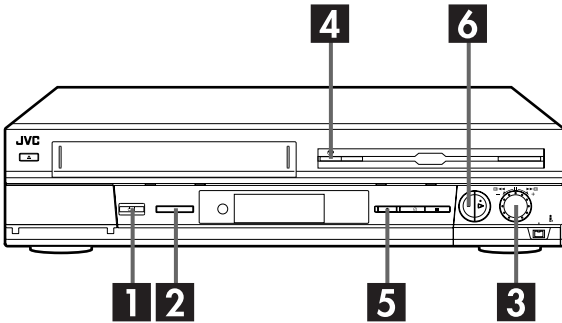

1 Turn on the recorder.

Press **⏻/I**.

- The button corresponding to the previously selected deck lights on the recorder.

2 Select the HDD deck.

On the recorder

Press **S-VHS/HDD** repeatedly until HDD indicator lights.

On the remote control

Press **HDD**.

- The HDD indicator lights on the recorder.

3 Choose a programme.

Press **VCR PR +/-** or the **number keys**. Or turn the **JOG** dial clockwise or counterclockwise to select the channel you wish to record while a TV channel is displayed on the front display panel.

- To change the indication on the front display panel, press the **JOG** dial while the HDD deck is stopped. Each time you press the **JOG** dial, TV channel and clock display alternate.
- When you switch channels on the HDD deck, the picture appears a few seconds behind. It is not a malfunction.

4 Set the recording speed.

Press **MODE**.

- For details on the recording speed, see page 23.

5 Start recording.

Press and hold **●** and press **▶** on the remote control, or press **●** on the recorder.

- The HDD REC mode indicator lights on the recorder.

6 Stop recording.

Press **■**.

- The HDD REC mode indicator turns off.
- There may be a few seconds' delay in resuming normal screen. It is not a malfunction.

NOTES:

- It is not possible to record a TV programme on both the HDD deck and the VHS deck simultaneously. In addition, it is not possible to record simultaneously from the same external input.
- It is not possible to pause recording on the HDD deck while recording from the channels other than "L-1", "L-2", "F-1", "D-1", or "DUB". (☞ pg. 66, 67)
- While recording a programme, you can play back the previously recorded part by "Live Memory Playback" (☞ pg. 28).

Basic Playback

- Turn on the TV and select the AV mode.
- Slide **TV/CABLE/SAT** switch to the right.
- If the recorder is turned on with HDD deck selected, there may be about 30 seconds' delay in starting to show pictures on the screen.

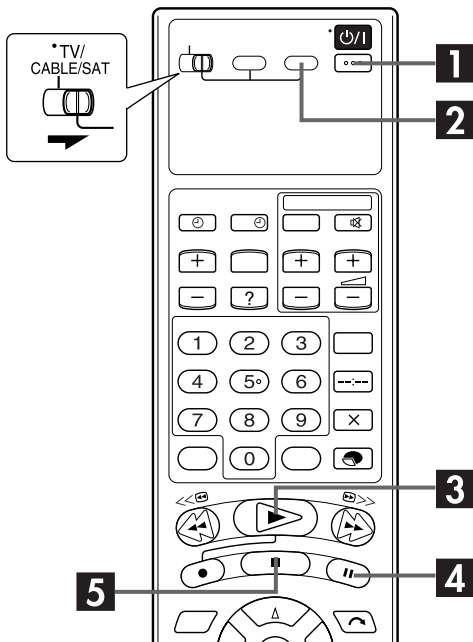
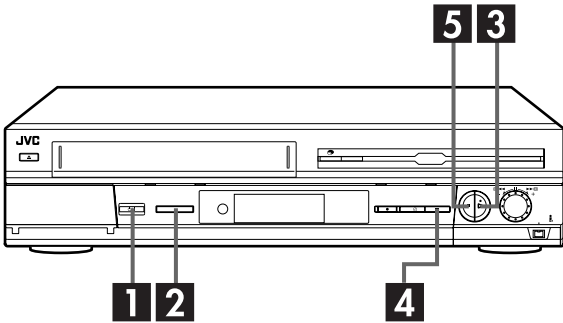

1 Turn on the recorder.

Press **⏻/I**.

- The button corresponding to the previously selected deck lights on the recorder.

2 Select the HDD deck.

On the recorder

Press **S-VHS/HDD** repeatedly until HDD indicator lights.

On the remote control

Press **HDD**.

- The HDD indicator lights on the recorder.

3 Start playback.

Press **▶**.

One of the following screens will appear:

- the programme which has been recorded on the HDD deck at last time and has not been played back yet
- the programme which has been stopped during playback
- the HDD Navigation screen (☞ pg. 24)

- There are some programmes for demonstration on the HDD deck when it is shipped from the factory.

4 Pause playback.

Press **⏸**.

- To resume normal playback, press **▶**.

5 Stop playback.

Press **■**.

- The HDD play indicator turns off.

NOTE:

While recording a programme, you can play back the previously recorded part by "Live Memory Playback" (☞ pg. 28).

Recording Speed on the HDD deck

This recorder has a 80 Gbyte hard disk drive. The pictures and sounds recorded on the HDD deck and other information are written down on the hard disk drive.

As recording format for the HDD deck, MPEG2 format, the same for DVD, is used. As a guide for picture quality, the "bps" unit is used to represent how much data can be recorded per second. The larger this value, the better the picture quality is but the more capacity is required for recording. Select SP for programmes where quick movement occurs, such as sports programmes, and SEP for talk shows, etc. where relativity less movement.

The recording speeds of the recorder are set as follows:

Recording speed	Recording amount (approx.)	Maximum recording time (approx.)
DV	25 Mbps	7 hours*
SP	6.4 Mbps	20 hours
LP	4.5 Mbps	28 hours
EP	3.2 Mbps	56 hours
SEP	2.2 Mbps	80 hours

* When "LIVE MEMORY" is set to "OFF". (☞ pg. 79)

NOTE:







The picture may be blurred or distorted when you start recording or playback in DV recording speed. However, this is not a malfunction of the recorder.

Playback with HDD Navigation



The HDD Navigation enables you to search and select the desired programmes recorded on the HDD deck very easily. There is a 80 Gbyte hard disk drive on this recorder. You can record up to 100 programmes for the HDD deck. Each time a programme is recorded on the HDD deck, the information of the programme are registered for the HDD Navigation automatically. So, you can confirm the information of the programmes recorded on the HDD with the HDD Navigation screen. And, you can also select one of the programmes recorded on the HDD deck using the HDD Navigation.

The following screen appears as the HDD Navigation screen when you select a programme (or play list) (☞ pg. 25). For details of the play list, refer to "Play List Features" (☞ pg. 60).

The Icons and their meanings

	This programme has never been played back.
	This programme was recorded using timer daily recording (daily overwrite) mode.
	This programme was recorded using timer daily recording (weekly overwrite) mode.
	This programme was recorded using timer weekly recording mode.
	This programme has stereo sounds.
	This programme has bilingual sounds.
	This programme was timer recorded.



- 1 Playback screen
(Indicates currently received TV programme.)
- 2 Guidance for operations
- 3 Scroll bar
(Appears when there are over nine registered programmes (or play lists). The scroll bar only indicates that there are more programmes (or play lists) hidden off the current screen display. To show hidden programmes (or play lists), press ◀ ▶ ▶ ◀ repeatedly.)
- 4 Recording information for the programme indicated by the arrow
- 5 Index
(Thumbnail still of each programme)
- 6 Index
 : Indicates no index is registered.
 : Indicates programme in standby for timer recording.
 : Indicates no programme is registered.
- 7 Icons
(Indicate the record condition of each programme.)

Scan for Beginning of Programme (or Play List)

You can scan the beginning of the programme (or play list) easily with the HDD Navigation. For details of the play list, refer to "Play List Features" (☞ pg. 60).

- Turn on the TV and select the AV mode.
- Slide **TV/CABLE/SAT** switch to the right.
- If the recorder is turned on with HDD deck selected, there may be about 30 seconds' delay in starting to show pictures on the screen.

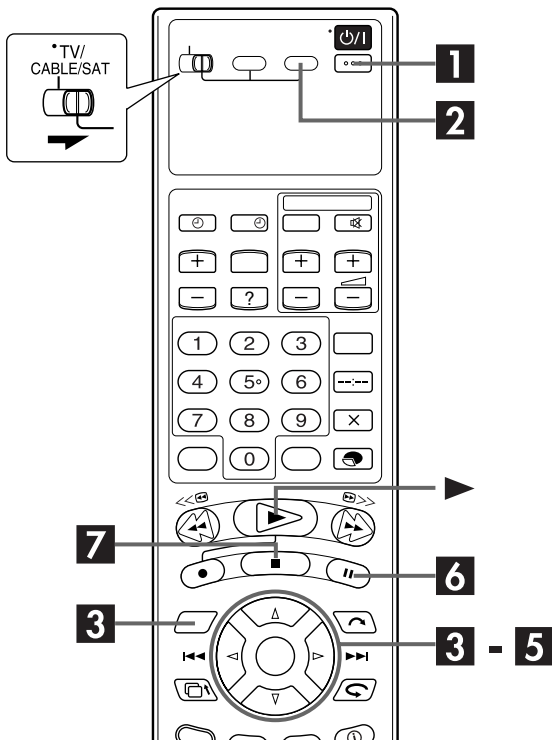

1 Turn on the recorder.

Press **⏻/I**.

2 Select the HDD deck.

Press **HDD**.

3 Access the Index screen.

On the recorder

Press **NAVIGATION**.

On the remote control

- 1 Press **NAVIGATION**. The HDD Navigation screen appears.
 - 2 Press **◀ ▶** to move the arrow to "REC LIST", then press **OK**.
- When you wish to play back a play list, select "PLAY LIST", then press **OK**.

4 Select the programme.

On the recorder

Turn the **JOG** dial to select the programme (or play list), then press the **JOG** dial.



On the remote control

Press **◀ ▶** to move the arrow on the index (small still pictures) of the desired programme, then press **OK**.

- When you wish to play back a programme during recording from the beginning, press **◀ ▶** to move the arrow to the top left corner index of the recording programme.

5 Start playback.

Press **◀ ▶** to move the arrow to "BEGINNING", then press **OK** again.

- To repeat playback of a selected programme (or play list), refer to "Repeat Playback" (☞ pg. 32).

6 Pause playback.

Press **⏸**.

- To resume normal playback, press **▶**.

7 Stop playback.

Press **■**.

- To resume playback from the point where playback was previously stopped, press **◀ ▶** to move the arrow to "RESUME", then press **OK**.

Playing Two or More Programmes (or Play Lists) Continuously in Desired Order

You can select up to eight programmes (or play lists) for continuous programme play.

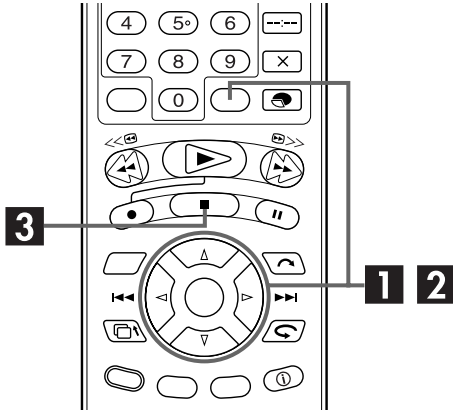

Perform steps **1** to **3** of "Scan for Beginning of Programme (or Play List)" (☞ pg. 25) before continuing.

1 Select the programmes (or play lists).

- 1** Press ◀ ▶ ▷ ▽ to move the arrow to the index of the desired programme (or play list), then press **MEMO**.
 - The number of the programme (or play list) order appears on the index.
- 2** Repeat step **1** to select more programmes (or play lists).
 - To cancel a selection, move the arrow to the programme (or play list) to be cancelled, then press **MEMO**. The selected number of the order disappears from the index and the recorder automatically renumbers the other programmes (or play lists).

2 Start playback.

Press **OK**.

3 Stop playback.

Press **■**.

Sort Recorded Programmes (or Play Lists) by Category and Playback

You can easily search for a desired programme (or play list) in the Index screen by sorting according to the category option registered during recording (or after recording). For details of the play list, refer to "Play List Features" (☞ pg. 60).

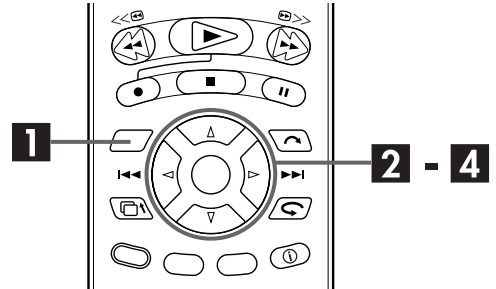

Perform steps **1** to **2** of "Scan for Beginning of Programme (or Play List)" (☞ pg. 25) before continuing.

1 Access the Navigation screen.

Press **NAVIGATION**.

2 Access the Category screen.

Press ◀ ▶ ▷ ▽ to move the arrow to "CATEGORY", then press **OK**.

3 Select the category, then the programme.

- 1** Press ◀ ▶ ▷ ▽ to move the arrow to the desired category, then press **OK**. Programmes (or play lists) having the selected category option appear in the list.
 - To register the category option, refer to "Family Option Preset" (☞ pg. 27) and step **10** of "VIDEO PLUS+™ Timer Programming" (☞ pg. 46).
- 2** Press ◀ ▶ ▷ ▽ to move the arrow to the desired programme (or play list), then press **OK**.

4 Start playback.

Press ◀ ▶ to move the arrow to "BEGINNING", then press **OK**.

- When playback of the entire programme is finished, normal screen resumes.
- When the end of the programme is reached by pressing ▶▶, deck goes to pause mode.

Family Option Preset

You can easily search for a desired programme (or play list) using this option. ("Sort Recorded Programmes (or Play Lists) by Category and Playback" (☞ pg. 26)) Before using this feature, it is recommended to disengage the unnecessary options using the following procedure to eliminate the labor of selection among many options.

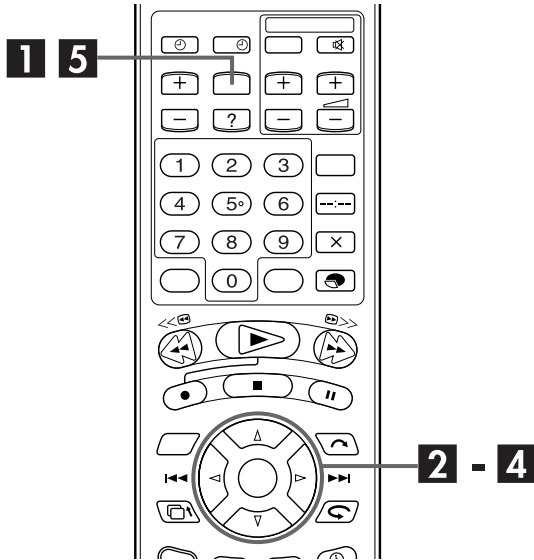

Perform steps **1** to **2** of "Scan for Beginning of Programme (or Play List)" (☞ pg. 25) before continuing.

1 Access the Main Menu screen.

Press **MENU**.

2 Access the Family screen.

- 1 Press $\triangleleft \triangle \triangleright \triangledown$ to move the arrow to "FUNCTION SET UP", then press **▽**.
- 2 Press $\triangleleft \triangle \triangleright \triangledown$ to move the arrow to "FAMILY", then press **OK**.

3 Disengage the option.

- 1 Press $\triangleleft \triangle \triangleright \triangledown$ to move the arrow to the unnecessary option, then press **OK**.
- 2 Press $\triangle \triangledown$ to select "OFF", then press **OK**.
 - To engage the option, select "ON" in step 1.

4 Disengage other options.

Repeat step **3** as necessary.

5 Return to the normal screen.

Press **MENU**.

Sort the Recorded Programmes (or Play Lists) by Title and Playback

You can easily search for a desired programme (or play list) in the Index screen by sorting according to the title registered during recording (or after recording). For details of the play list, refer to "Play List Features" (☞ pg. 60).

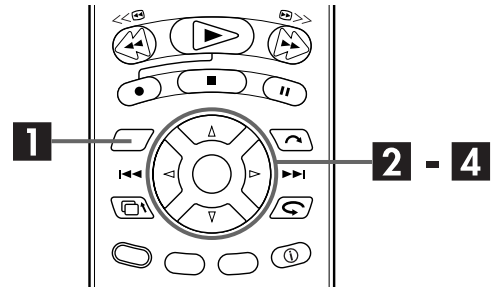

Perform steps **1** to **2** of "Scan for Beginning of Programme (or Play List)" (☞ pg. 25) before continuing.

1 Access the Navigation screen.

Press **NAVIGATION**.

2 Access the Title screen.

Press $\triangleleft \triangle \triangleright \triangledown$ to move the arrow to "TITLE", then press **OK**.

3 Select the initial letter of the title, then the programme.

- 1 Press $\triangleleft \triangle \triangleright \triangledown$ to move the arrow to the desired letter, then press **OK**. Programmes (or play lists) having the selected initial letter in their titles appear in the list among other programmes (or play lists).
 - When there is no title that fits your requirements, the next available selections will appear in alphabetical order.
- 2 Press $\triangleleft \triangle \triangleright \triangledown$ to move the arrow to the desired programme (or play list), then press **OK**.

4 Start playback.

Press $\triangleleft \triangleright$ to move the arrow to "BEGINNING", then press **OK**.

- When playback of the entire programme is finished, normal screen resumes.
- When the end of the programme is reached by pressing **▶▶**, deck goes to pause mode.

Live Memory Features

Equipped with a hard disk drive, this recorder allows information to be written to and read from the hard disk at high speeds. Taking advantage of this feature, you can temporarily record programmes received with the tuner or from an externally connected equipment, and can watch them only a few seconds behind actual air time.

In this recorder, viewing a programme through HDD (not a recorded programme) means you are always watching the programme temporarily recorded on it. This feature enables you to reverse the programme back to view or record any previous part of it. This is called "Live Memory Playback" or "Live Memory Recording", which was impossible until now.

You can select the length of the time for temporary recording from off, 30 minutes, 1 hour, and 3 hours (see pg. 79).

About "Live Memory Playback"

With a certain amount of space (for 30 minutes, 1 hour and 3 hours) reserved on the hard disk, the recorder records broadcasts being received or signals input from an externally connected equipment.

Even while you are reversing the programme to review any previous part, the recorder continues recording the same programme or externally-input signals.

NOTE:

When the reserved amount of time (or space) runs out, the recorder overwrites the previous recordings on the hard disk, starting with the oldest one, repeatedly if necessary. After having recorded a certain number of programmes, if you try to increase the amount of your reserved time on HDD, you may not be allowed to do so because of possible lack of available space, and the recorder will inform you of this by displaying a message on the screen.

Live Memory Playback

- Turn on the TV and select the AV mode.
- Slide TV/CABLE/SAT switch to the right.
- If the recorder is turned on with HDD deck selected, there may be about 30 seconds' delay in starting to show pictures on the screen.

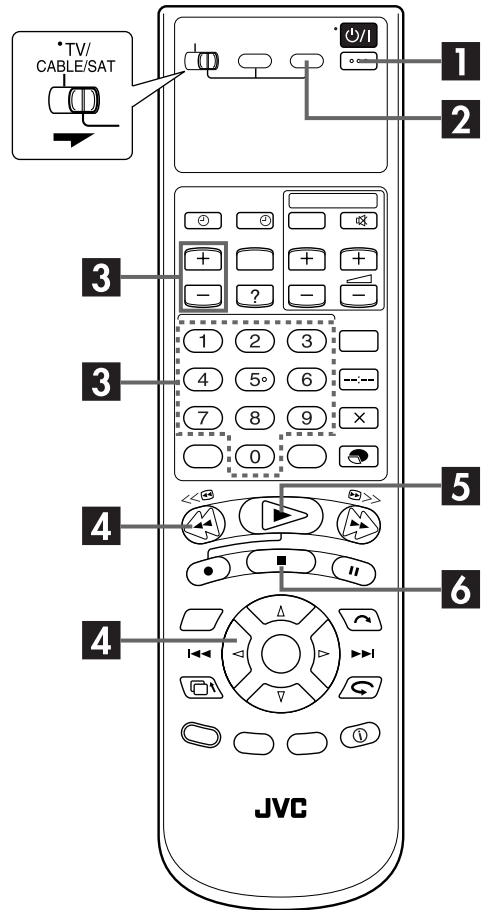

1 Turn on the recorder.

Press \odot /I.

2 Select the HDD deck.

Press HDD.

3 Choose a programme.

Press **VCR PR +/-** or the **number keys** to select the channel you wish to record.

- The temporary recording begins.

4 Locate the point to start playback from.

Press \triangleleft or \blacktriangleleft to search for the previous part of the currently viewing programme (temporary recorded on the background).

5 Start Live Memory Playback.

Press \blacktriangleright .

6 Stop Live Memory Playback.

Press \blacksquare .

- The on-air screen resumes.

NOTES:

- You can use various playback features during Live Memory Playback. (☞ pg. 30)
- If you have started actual recording by pressing \bullet , pressing \blacksquare in step 6 only resumes the on-air screen. To stop actual recording, press \blacksquare again.

About limitation on Live Memory Playback

The temporary recording for Live Memory is cancelled in the following cases, and will start all over again when it is to resume.

- When the power is turned off
- When the system is powered again after a power failure was occurred
- When normal recording (☞ pg. 22), timer programme recording (☞ pg. 46, 48), live memory recording (☞ right column), or automatic satellite programme recording (☞ pg. 51) is performed
- When the thumbnails are changed (☞ pg. 56)
- When the "LIVE MEMORY" setting is changed (☞ pg. 79)
- When tuner channel setting is performed (☞ pg. 14, 86)

Live Memory Recording

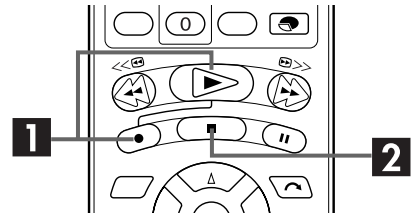

Perform steps 1 to 4 of "Live Memory Playback" (☞ pg. 29) before continuing.

1 Start Live Memory Recording.

On the recorder

Press \bullet .

On the remote control

Press and hold \bullet , then press \blacktriangleright .

- HDD REC indicator and the record indicator on the front display panel blinks, then after a few seconds, the current broadcast screen resumes.

2 Stop Live Memory Recording.

Press \blacksquare .

NOTES:

- You cannot use Live Memory Recording for channels other than the channel you are currently watching.
- Recording speed is automatically set to SP mode when Live Memory Recording is started.
- Temporarily recorded data prior to the beginning of Live Memory Recording is erased when Live Memory Recording started.

Playback Features

- Turn on the TV and select the AV mode.
- Slide **TV/CABLE/SAT** switch to the right.
- If the recorder is turned on with HDD deck selected, there may be about 30 seconds' delay in starting to show pictures on the screen.

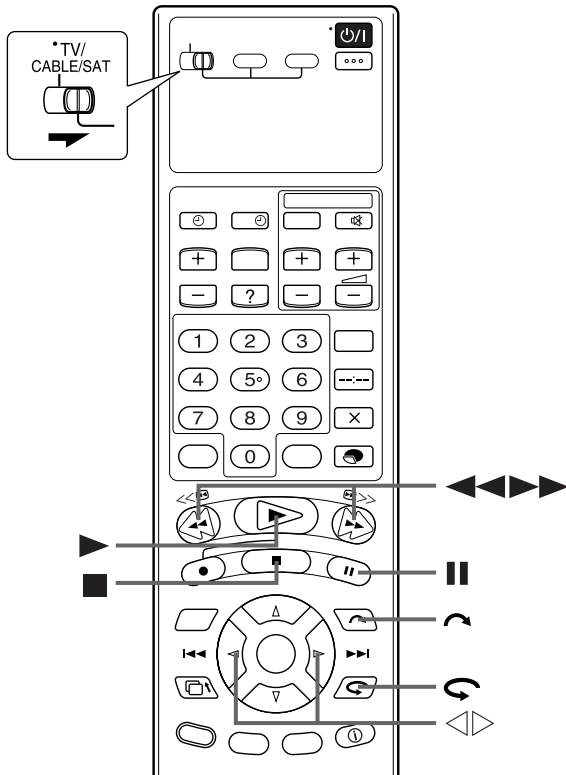

Still Picture/Frame-By-Frame Playback

1 Pause during playback.

Push the **JOG** dial.

OR

Press **II**.

2 Activate frame-by-frame playback.

Turn the **JOG** dial to the right for forward frame-by-frame playback, or to the left for reverse frame-by-frame playback.

OR

Press **▶▶** repeatedly to advance one frame at a time.

Press **◀◀** repeatedly to reverse one frame at a time.

- To resume normal playback, press **▶**.

Slow Motion

1 Pause during playback.

Push the **JOG** dial.

OR

Press **II**.

2 Activate slow motion playback.

Press and hold **▶▶** or **◀◀** for over 2 seconds.

- The playback speed changes for each direction by pressing **▶▶** or **◀◀** repeatedly.
- To resume normal playback, press **▶**.

Variable Speed Search

During playback, turn the **JOG** dial to the right for forward variable-speed search, or to the left for reverse variable-speed search.

OR

During playback (or Live Memory Playback), press **▶▶▶** for forward variable-speed search, or **◀◀◀** for reverse variable-speed search.

- The playback speed changes for each direction by pressing **▶▶▶** or **◀◀◀** repeatedly. Refer to the illustration below.
- To resume normal playback, press **▶**.

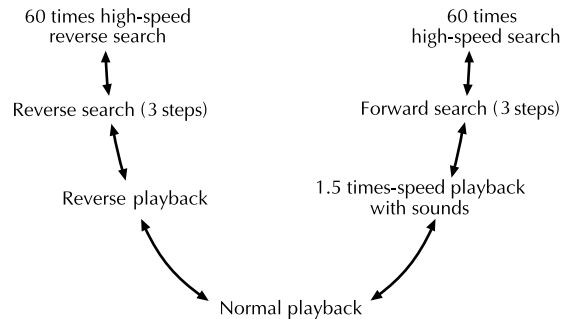

NOTE:

1.5 times-speed playback with sound is not possible when recording speed set to DV.

Jump search

You can locate a scene ahead or behind the current one by jumping scenes according to selected time intervals (see pg. 79) during playback (or Live Memory Playback). This feature is also available during recording (or Live Memory Recording) or when watching a TV received programme.

Press ◀▶.

- To advance forward or back, press ◀▶ repeatedly within 5 seconds of each press to continue jump.
- When you cannot advance any farther (beginning or end of programme reached), the recorder pauses and the message "UNABLE TO GO BACK ANYMORE" appears on the screen. In such a case, press ◀ or ▶.

Example 1:

Playback search when jump interval set to 30 MIN jumps

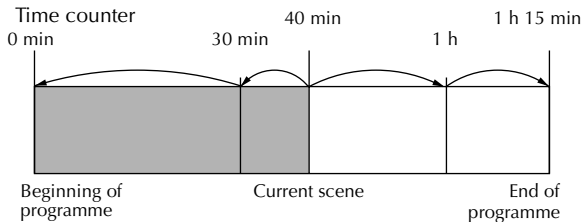

Example 2:

Recording search when jump interval set to 15 MIN jumps

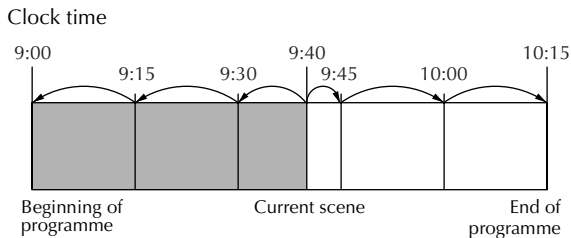

Quick Rewind a little

During playback (or Live Memory Playback), press ⏮. The recorder rewinds the picture a little (about 7 seconds) and resumes playback.

- If the button is pressed repeatedly, the recorder rewinds the pictures continuously and resumes playback.

Quick Skip Forward

During playback (or Live Memory Playback), press ⏭. The recorder skips forward (about 30 seconds at a time) and resumes playback.

- If the button is pressed repeatedly, the recorder skips continuously and resumes playback.

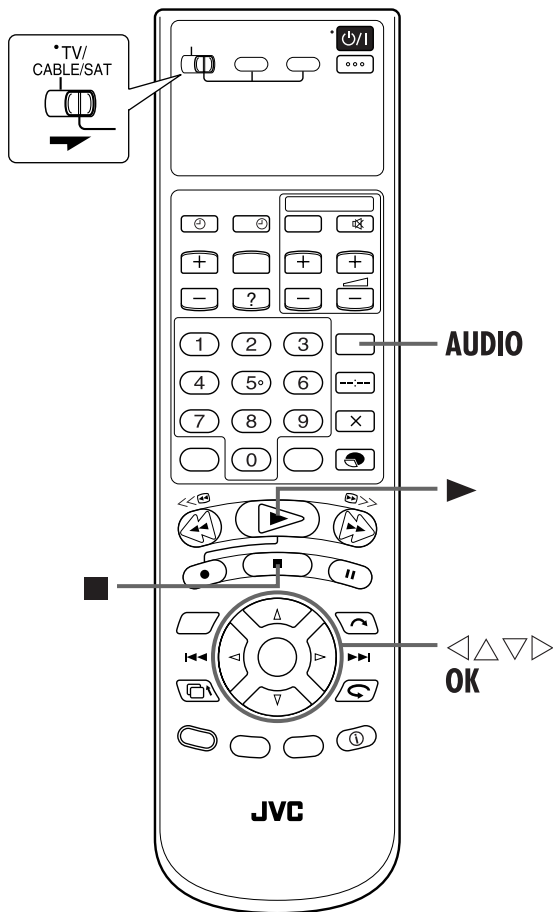

Repeat Playback

Your recorder can automatically play back the desired programme(s) repeatedly.

1 Select the desired programme.

Perform steps 1 to 4 of "Scan for Beginning of Programme (or Play List)" (pg. 25) before continuing.

2 Start Repeat Playback.

Press ◀ ▶ to move the arrow to "REPEAT", then press **OK**.

- The Play indicator (▶) on the front display panel blinks slowly.
- To resume normal playback, press ▶.
- To stop playback, press ■.

NOTE:

Repeat playback is not possible during Live Memory Playback.

Soundtrack Selection

The HDD deck can record 2 soundtracks (L and R).

During Playback

Pressing **AUDIO** changes the soundtrack as follows:

TRACK	USE
On-Screen Display	
	For stereo programme
	For monaural programme
	For main audio of bilingual programme
	For sub audio of bilingual programme
	For NICAM stereo programme
	For NICAM monaural programme
	For NICAM main audio of bilingual programme
	For NICAM sub audio of bilingual programme
	For NICAM FM programme
	For AUX input sounds (L+R)
	For AUX input sound (L)
	For AUX input sound (R)

Recording Features

- Turn on the TV and select the AV mode.
- Slide **TV/CABLE/SAT** switch to the right.
- If the recorder is turned on with HDD deck selected, there may be about 30 seconds' delay in starting to show pictures on the screen.

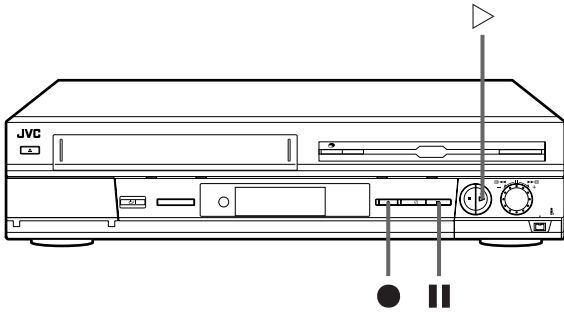

Pausing During Recording

While you are recording a TV programme and watching it, you can pause Live Memory Playback to answer a phone call or so on without missing any scene in the programme. Only the image on the screen pauses and recording still continues background. This feature is also available while watching a TV programme.

1 Pause Live Memory Playback.

Push the **JOG** dial.

OR

Press **II** during Live Memory Playback.

2 Resume Live Memory Playback.

Press **▶** from the pause point.

Record One Programme While Watching Another

Once recording is in progress, all you need to do is to set the channel controls on the TV for the station you wish to view.

- The programme selected with the TV's channel controls appears on the TV screen, while the one selected with the recorder's **VCR PR** buttons is recorded on the tape.

Instant Timer Recording (ITR)

This easy method lets you record for from 30 minutes to 6 hours (selectable in 30-min. increments), and shuts the recorder off after recording is finished.

1 Start recording.

Press ● on the recorder.

2 Engage the ITR mode.

Press ● again. "●" blinks and "0:30" appears on the front display panel.

- ITR timer duration also appears in the TV screen. (☞ pg. 9)

3 Set the recording duration.

If you want to record for more than 30 minutes, press ● to extend the time. Each press extends recording time by 30 minutes.

NOTE:

You can only perform ITR using the ● button on the recorder's front panel.

Receiving Stereo and Bilingual Programmes

Your recorder is equipped with a Digital stereo sound decoder (NICAM) making reception of stereo and bilingual broadcasts possible.

When the channel is changed, the type of broadcast being received will be displayed on the TV screen for a few seconds.

Type of Broadcast Being Received	On-screen Display
Regular Monaural	
NICAM Stereo	
NICAM Bilingual	
NICAM Monaural	
NICAM FM Sound	

NOTE:

"O.S.D." must be set to "ON" or the on-screen displays will not appear (☞ pg. 82).

To Record NICAM Bilingual Programmes

Set "AUDIO REC" to "NICAM" to record the NICAM bilingual programme (☞ pg. 79).

NOTES:

- If the quality of stereo sound being received is poor, the broadcast will be received in monaural with better quality.
- Before playing back a programme recorded in stereo, or a bilingual programme, refer to "Soundtrack Selection" on page 32.

Basic Recording

- Turn on the TV and select the AV mode.
- Slide **TV/CABLE/SAT** switch to the right.
- If the recorder is turned on with HDD deck selected, there may be about 30 seconds' delay in starting to show pictures on the screen.

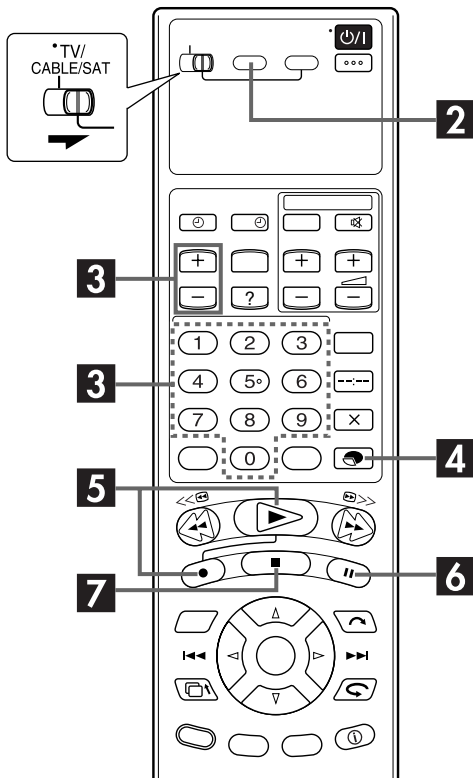
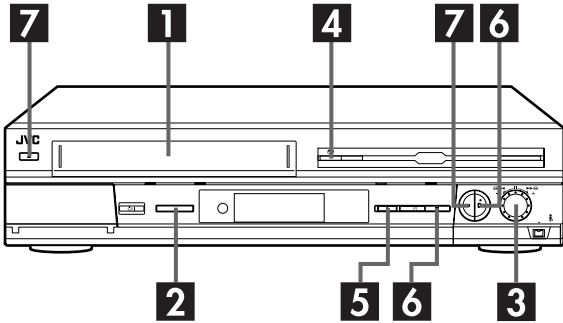

NOTES:

- It is not possible to record a TV programme on both the HDD deck and the VHS deck simultaneously. In addition, it is not possible to record simultaneously from the same external input.
- When the end of the tape is reached during recording, the VHS deck start to rewind the tape automatically.

1 Load a cassette.

Insert a cassette with the record safety tab intact. Make sure the window side is up, the rear label side is facing you and the arrow on the front of the cassette is pointed toward the recorder.

- Do not apply too much pressure when inserting.
- The recorder's power comes on automatically.
- While "----" is blinking on the front display panel, the tape will run for a few seconds to search for the tape number.
- If you want to use VCR Navigation to select the programme after recording with this recorder, set "NAVIGATION" to "ON" (☞ pg. 79).

2 Select the VHS deck.

On the recorder

Press **S-VHS/HDD** repeatedly until S-VHS indicator lights on the recorder.

On the remote control

Press **S-VHS**.

- The S-VHS indicator lights on the recorder.

3 Choose a programme.

Press **VCR PR +/-** or the **number keys**. Or push the **JOG** dial and turn it to the left or right to select the channel you wish to record.

4 Set the tape speed.

Press **MODE**. The current setting appears on the front display panel or TV screen. Press **MODE** again to change the setting while the tape speed is displayed on the TV screen.

5 Start recording.

Press and hold **●** and press **▶** on the remote control, or press **●** on the recorder.

- The S-VHS/VHS REC mode indicator lights on the recorder.

B.E.S.T. takes place at the beginning of both the first SP and the first LP recording after inserting the cassette. (☞ pg. 45)

If "DIRECT REC" is set to "ON", the programme that appears on the TV screen will be recorded. (☞ pg. 82).

6 Pause/Resume recording.

Press **II**. Press **▶** to resume recording.

7 Stop recording.

Press **■**. Then press **▲** to remove the cassette.

Basic Playback

- Turn on the TV and select the AV mode.
- Slide **TV/CABLE/SAT** switch to the right.
- If the recorder is turned on with HDD deck selected, there may be about 30 seconds' delay in starting to show pictures on the screen.

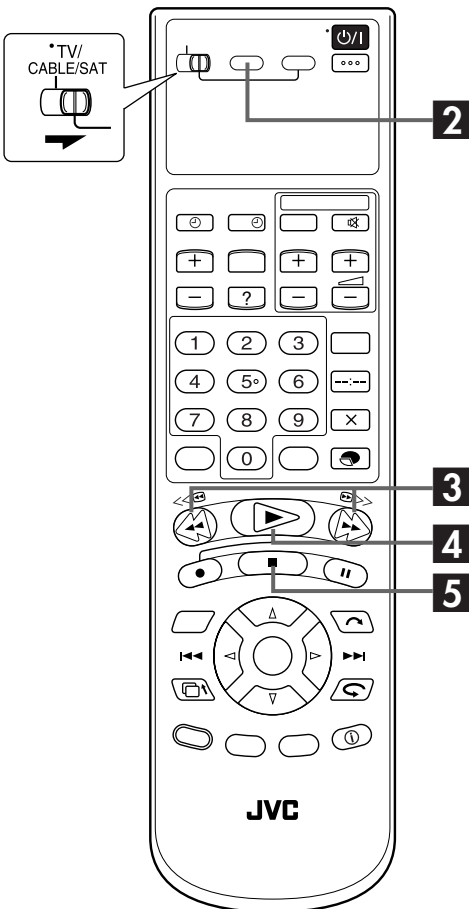
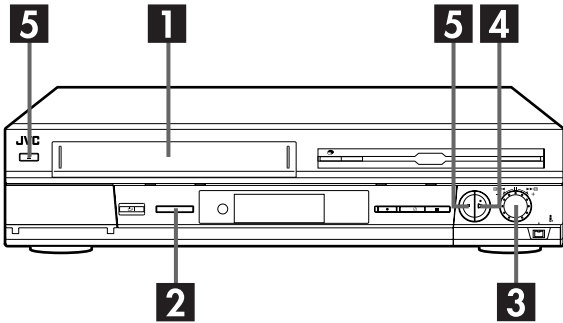

1 Load a cassette.

Make sure the window side is up, the rear label side is facing you and the arrow on the front of the cassette is pointed toward the recorder.

- Do not apply too much pressure when inserting.
- The recorder's power comes on automatically.
- While "----" is blinking on the front display panel, the tape will run for a few seconds to search for the tape number.
- If the record safety tab has been removed, playback begins automatically.

2 Select the VHS deck.

On the recorder

Press **S-VHS/HDD** repeatedly until S-VHS indicator lights on the recorder.

On the remote control

Press **S-VHS**.

- The S-VHS indicator lights on the recorder.

3 Find the programme start point.

If the tape is advanced past the start point, press ◀◀ or turn the **JOG** dial to the left. To go forward, press ▶▶ or turn the **JOG** dial to the right.

4 Start playback.

Press ▶. During automatic tracking, "bEst" appears blinking in the recorder's front display panel. (☞ pg. 45)

5 Stop playback.

Press ■. Then press ▲ to remove the cassette.

Usable cassettes

- Compact VHS camcorder recordings can be played on this video recorder. Simply place the recorded cassette into a VHS Cassette Adapter and it can be used just like any full-sized VHS cassette.
- This video recorder can record on regular VHS and Super VHS cassettes. While only VHS signals can be recorded on regular VHS cassettes*, both VHS and Super VHS signals can be recorded and played back using Super VHS cassettes.

* By using the **S-VHS ET** function, it is possible to record and play back with **S-VHS** picture quality on VHS cassettes with this recorder.

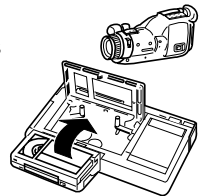

Playback with VCR Navigation

The VCR Navigation enables you to search and select the desired programmes recorded on the VHS deck very easily. When you record a programme with the VHS deck for more than 8 minutes in SP mode for more than 15 minutes in LP mode) with "NAVIGATION" set to "ON" (☞ pg. 79), its information are registered for the VCR Navigation automatically. When the first programme is recorded on a cassette, the VCR Navigation gives the register number to the cassette. The VCR Navigation memorizes the cassette by the number. You can confirm the register number of the cassette when the cassette is loaded or ejected. The VCR Navigation can register up to 2000 programmes or up to 680 cassettes.

The following screen appears as the VCR Navigation screen when you select a programme. (☞ pg. 37)

The Icons and their meanings

	This programme has a little gap at the beginning.
	This programme has never been played back.
	This programme has stereo sounds.
	This programme has bilingual sounds.
	This programme was timer recorded.

Scan for Beginning of Programme

The VCR Navigation can take effect for the programme which has been recorded, and whose information has been registered with this recorder. Once the VHS (S-VHS) cassettes have been used for recording with this recorder, they have the register number given by this recorder.

- Turn on the TV and select the AV mode.
- Slide **TV/CABLE/SAT** switch to the right.
- If the recorder is turned on with HDD deck selected, there may be about 30 seconds' delay in starting to show pictures on the screen.



- 1 Playback screen
(Indicates currently received TV programme.)
- 2 Guidance for operations
- 3 Scroll bar
(Appears when there are over nine registered programmes (or play lists). The scroll bar only indicates that there are more programmes (or play lists) hidden off the current screen display. To show hidden programmes (or play lists), press Δ ∇ repeatedly.)
- 4 Inserted cassette information
(Loaded cassette number, title, total recorded time and remaining recording time based on the currently selected speed.)
- 5 Selected programme information
(Recorded date, time, channel position number, recording speed, title)
- 6 Index
(Thumbnail still of each programme)
- 7 Index
 - : Indicates no index is registered.
 - : Indicates programme in standby for timer recording.
 - : Indicates no programme is registered.

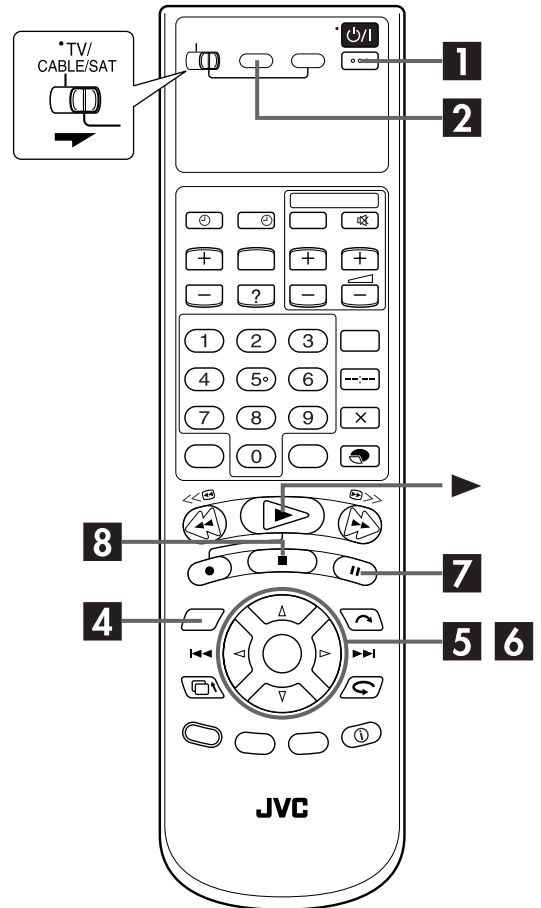

1 Turn on the recorder.

Press $\odot/1$.

2 Select the VHS deck.

Press **S-VHS**.

3 Load the cassette.

Insert a cassette with the record safety tab intact.

4 Access the Index screen.

On the recorder

Press **NAVIGATION**.

On the remote control

1 Press **NAVIGATION**. The VCR Navigation screen appears.

2 Confirm the arrow is on "INDEX", then press **OK**.

• If a registered cassette has been loaded, the contents of the loaded cassette will appear.

5 Select the programme.

On the recorder

Turn the **JOG** dial to select the programme, then press the **JOG** dial.



On the remote control

Press \triangle \triangleright \triangleright \triangleright to move the arrow on the index (small still pictures) of the desired programme, then press **OK**.

6 Start playback.

Press \triangle \triangleright to move the arrow to "PLAY" on the Index screen, then press **OK** again.

7 Pause playback.

Press **II**.

• To resume normal playback, press \blacktriangleright .

8 Stop playback.

Press **■**.

Sort Recorded Programmes by Record Date/Cassette Number and Playback

You can easily search for a desired programme in the Index screen by sorting according to the record date or cassette number registered during recording.

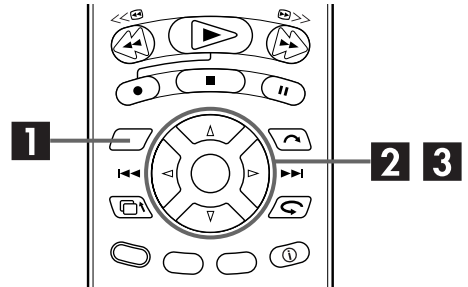

Perform steps **1** and **2** of "Scan for Beginning of Programme" (pg. 37) before continuing.

1 Access the Navigation screen.

Press **NAVIGATION**.

2 Access the date/title screen.

Press \triangle \triangleright \triangleright \triangleright to move the arrow to "DATE" or "CASSETTE #", then press **OK**.

3 Select the programme and confirm the cassette number.

Press \triangle \triangleright \triangleright \triangleright to move the arrow to the desired programme (cassette), then press **OK**.

Cassette number



4 Load the cassette.

After you have found the programme and checked the related cassette number, insert the cassette.

5 Select the programme and start playback.

Perform steps **4** to **5** of "Scan for Beginning of Programme" (pg. 37).

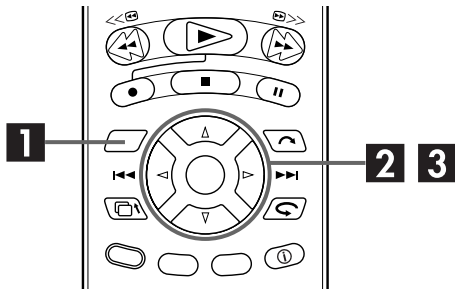

Sort Recorded Programmes by Category and Playback

You can easily search for a desired programme in the Index screen by sorting according to the category option registered during recording (or after recording).

Perform steps **1** and **2** of "Scan for Beginning of Programme" (☞ pg. 37) before continuing.

1 Access the Navigation screen.

Press **NAVIGATION**.

2 Access the date/title screen.

Press $\triangleleft \triangle \triangleright \triangleright$ to move the arrow to "CATEGORY", then press **OK**.

3 Select the category, then the programme, then confirm the cassette number.

- 1 Press $\triangleleft \triangle \triangleright \triangleright$ to move the arrow to the desired category, then press **OK**. Programmes having the selected category option appear in the list.
 - To register the category option, refer to "Family Option Preset" (☞ pg. 27) and step **10** of "VIDEO PLUS+™ Timer Programming" (☞ pg. 46).
- 2 Press $\triangleleft \triangle \triangleright \triangleright$ to move the arrow to the desired programme, then press **OK**.

4 Load the cassette.

After you have found the programme and checked its cassette number, insert the cassette.

5 Select the programme and start playback.

Perform steps **4** to **5** of "Scan for Beginning of Programme" (☞ pg. 37) before continuing.

Sort Recorded Programmes by Title and Playback

You can easily search for a desired programme in the Index screen by sorting according to the title registered at recording (or after recording).

Perform steps **1** and **2** of "Scan for Beginning of Programme" (☞ pg. 37) before continuing.

1 Access the Navigation screen.

Press **NAVIGATION**.

2 Access the Title screen.

Press $\triangleleft \triangle \triangleright \triangleright$ to move the arrow to "TITLE", then press **OK**.

3 Select the initial letter of the title, then the programme, then confirm the cassette number.

- 1 Press $\triangleleft \triangle \triangleright \triangleright$ to move the arrow to the desired letter, then press **OK**. Programmes having the selected initial letter in their titles appear in the list.
- 2 Press $\triangleleft \triangle \triangleright \triangleright$ to move the arrow to the desired programme, then press **OK**.

4 Load the cassette.

After you have found the programme and checked the related cassette number, insert the cassette.

5 Select the programme and start playback.

Perform steps **4** to **5** of "Scan for Beginning of Programme" (☞ pg. 37) before continuing.

Playback Features

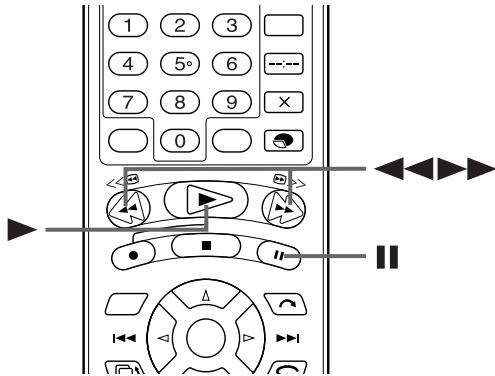

ATTENTION

- Picture may not appear during variable speed search with an LP-recorded tape.
- In the variable speed search, still, slow motion or frame-by-frame playback mode, the picture will be distorted, and there will be a loss of colour.
- When normal playback resumes from search, still, slow motion or frame-by-frame playback, the picture may jitter vertically momentarily depending on the type of TV being used.

Clean the video heads using a dry cleaning cassette — ECL-3F — when:

- Rough, poor picture appears while a tape is played back.
- The picture is unclear or no picture appears.
- "USE CLEANING CASSETTE" appears on the screen (only with "O.S.D." set to "ON" (pg. 82)).

Still Picture/Frame-By-Frame Playback

1 Pause during playback.

Push the JOG dial.

OR

Press **II**.

2 Activate frame-by-frame playback.

Turn the JOG dial to the right for forward frame-by-frame playback, or to the left for reverse frame-by-frame playback.

OR

Press **▶▶** repeatedly to advance one frame at a time.

Press **◀◀** repeatedly to reverse one frame at a time.

Slow Motion

1 Pause during playback.

Push the JOG dial.

OR

Press **II**.

2 Activate slow motion playback.

Press and hold **▶▶** or **◀◀** for over 2 seconds.

- The playback speed changes for each direction by pressing **▶▶** or **◀◀** repeatedly.
- To resume normal playback, press **▶**.

Variable Speed Search

During playback, turn the JOG dial to the right for forward variable-speed search, or to the left for reverse variable-speed search.

OR

During playback, press **▶▶** for forward variable-speed search, or **◀◀** for reverse variable-speed search.

- The playback speed changes for each direction by pressing **▶▶** or **◀◀** repeatedly. Refer to the illustration below.
- To resume normal playback, press **▶**.

Reverse search (2 steps)

Forward search (2 steps)

Reverse playback

Normal playback

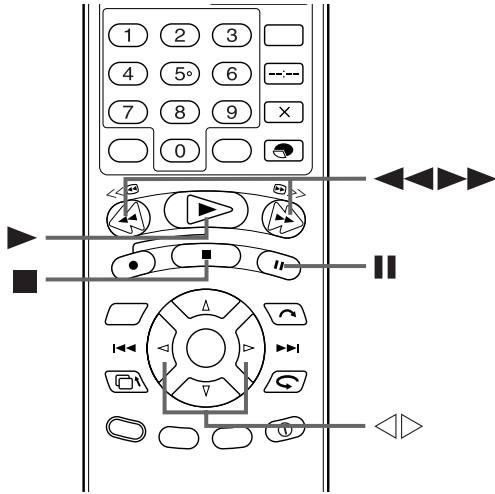

Repeat Playback

Your recorder can automatically play back the whole tape 100 times repeatedly.

1 Start playback.

Press ►.

2 Activate Repeat Playback.

Press ► and hold for over 5 seconds, then release.

- The Play indicator (►) on the front display panel blinks slowly.
- After playing back a tape 100 times, the recorder stops automatically.

3 Stop Repeat Playback.

Press ■ at any time.

- Pressing ►, ◀◀, ▶▶ or || also stops Repeat Playback.

NTSC Playback

Your video recorder is equipped with NTSC circuitry that can play back NTSC tapes.

1 Load a cassette.

Insert a cassette recorded in NTSC.

2 Start playback.

Press ►.

- "NTSC→PAL" appears on the screen for about 5 seconds.

NOTES:

- Some TVs shrink the picture vertically and place black bars at the top and bottom of the screen. This is not a malfunction on the part of either the video recorder or the TV.
- The picture may roll up and down. This can be corrected using the V-HOLD control found on some TVs. (This cannot be corrected if the TV does not have a V-HOLD control.)
- The counter and tape remaining time readings will be incorrect.
- During search, still, or frame-by-frame playback, the picture will be distorted, and there may be a loss of colour.
- Depending on the type of TV, the top and bottom portions of superimposed displays may be cut off during NTSC playback.

Index Search

Your recorder automatically marks index codes at the beginning of each recording. This function gives you quick access to any one of 9 index codes in either direction.

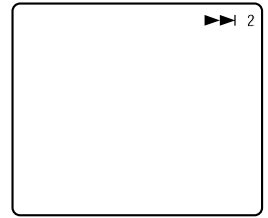

NOTE:

Before starting, make sure the recorder is in the Stop mode.

Activate Index Search.

Press ◀ or ▶ (◀◀◀ or ▶▶▶). "◀◀◀ 1" or "▶▶▶ 1" is displayed on the TV screen and search begins in the corresponding direction.

- To access index codes 2 through 9, press ◀ or ▶ repeatedly until the correct index number is displayed.

Example:

To locate the beginning of B from the current position, press ◀ twice.

To locate the beginning of D from the current position, press ▶ once.

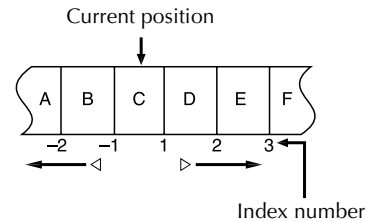

- When the specified index code is located, playback begins automatically.

Next Function Memory

The Next Function Memory "tells" the recorder what to do after rewinding. Before continuing, make sure the recorder is in the Stop mode.

a- For Automatic Start Of Playback

Press ◀◀, then press ► within 2 seconds.

b- For Automatic Cassette Ejection After Tape Rewind

Press ◀◀, then press ▲ within 2 seconds.

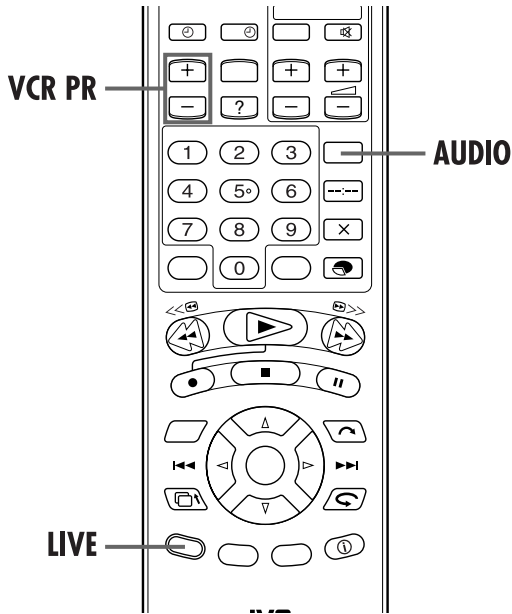

Soundtrack Selection

Your recorder is capable of recording three soundtracks (HI-FI L, HI-FI R and NORM) and will play back the one you select.

During Playback

Pressing **AUDIO** changes the soundtrack as follows:

TRACK	USE
On-Screen Display	
HI FI L R	For Hi-Fi stereo tapes
HI FI L	For main audio of Bilingual tapes
HI FI R	For sub audio of Bilingual tapes
NORM	For audio-dubbed tapes
HI FI NORM	For audio-dubbed tapes

Manual Tracking

Your recorder is equipped with automatic tracking control. During playback, you can override this and adjust the tracking manually by pressing the **VCR PR** buttons.

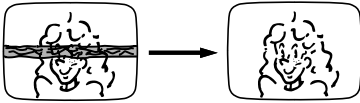

1 Override automatic tracking.

Press **LIVE** on the remote control.

2 Adjust the tracking manually.

Press **VCR PR +** or **-**.

- Press **LIVE** again to return to automatic tracking.

NOTE:

When a new tape is inserted, the recorder enters the automatic tracking mode automatically.

NOTES:

- "HI FI L R" should normally be selected. In this mode, Hi-Fi stereo tapes are played back in stereo, and the normal audio track is played back automatically for tapes with only normal audio.
- For instructions on recording stereo and bilingual programmes, refer to page 44.
- "O.S.D." must be set to "ON" or the on-screen displays will not appear (see pg. 82).

Recording Features

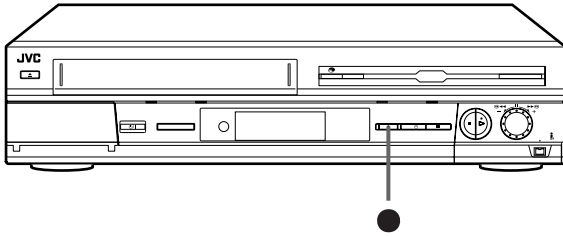

- Turn on the TV and select the AV mode.
- Slide TV/CABLE/SAT switch to the right.
- If the recorder is turned on with HDD deck selected, there may be about 30 seconds' delay in starting to show pictures on the screen.

Recording Resume Function

If there is a power outage during recording, Instant Timer Recording (in the right column) or timer recording (pg. 46, 48), the recording will resume automatically when power is restored to the recorder unless the recorder's memory backup has expired.

Accidental erasure prevention

To prevent accidental recording on a recorded cassette, remove its safety tab. To record on it later, cover the hole with adhesive tape.

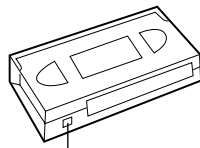

Record safety tab

Record One Programme While Watching Another

Once recording is in progress, all you need to do is to set the channel controls on the TV for the station you wish to view.

- The programme selected with the TV's channel controls appears on the TV screen, while the one selected with the recorder's VCR PR buttons is recorded on the tape.

Instant Timer Recording (ITR)

This easy method lets you record for from 30 minutes to 6 hours (selectable in 30-min. increments), and shuts the recorder off after recording is finished.

1 Start recording.

Press ● on the recorder.

2 Engage the ITR mode.

Press ● again. "●" blinks and "0:30" appears on the front display panel.

3 Set the recording duration.

If you want to record for more than 30 minutes, press ● to extend the time. Each press extends recording time by 30 minutes.

NOTES:

- You can only perform ITR using the ● button on the recorder's front panel.
- When the end of the tape is reached during instant timer recording, the cassette is ejected, then the recorder is powered off automatically.

Elapsed Recording Time Indication

1 Set the counter display.

Press **--:--** so that a counter reading appears on the TV screen and the front display panel.

- The front display panel shows the counter reading with “:” lit.

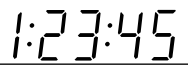

2 Reset the counter.

Press **0000** before starting recording or playback.

- The counter is reset to “0:00:00” and shows the exact elapsed time as the tape runs. You can check the exact time of a recording or playback.

Tape Remaining Time

Press **MODE**.

- The current tape remaining time and the current recording speed alternate in the front display panel. You can also confirm the information on the TV screen. (☞ pg. 10)

NOTE:

Depending on the type of tape being used, the tape remaining time reading may not appear right away, or is not correct. “- -:--” may sometimes appear, or the display may blink on occasion.

Super VHS ET (S-VHS ET)

— Recording on VHS cassettes with S-VHS quality

You can record in SP mode on VHS cassettes with S-VHS picture quality. Set “S-VHS ET” to the desired mode (☞ pg. 80).

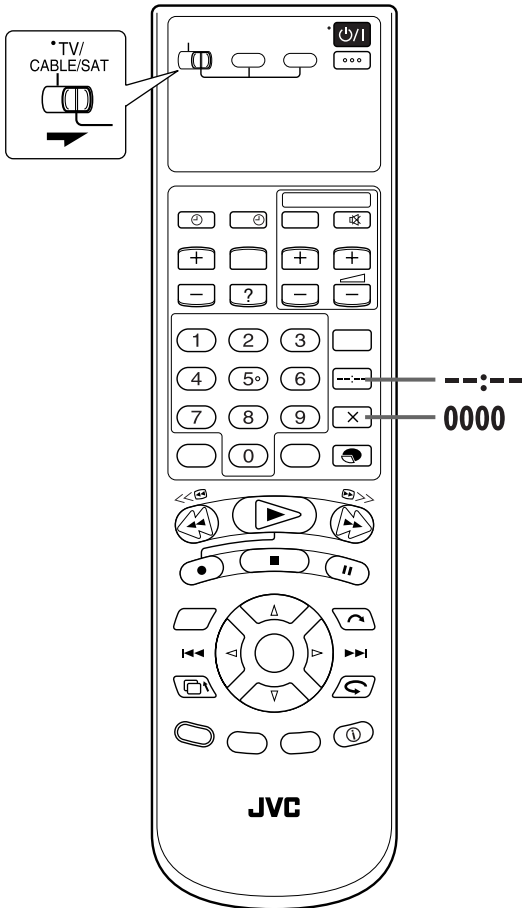

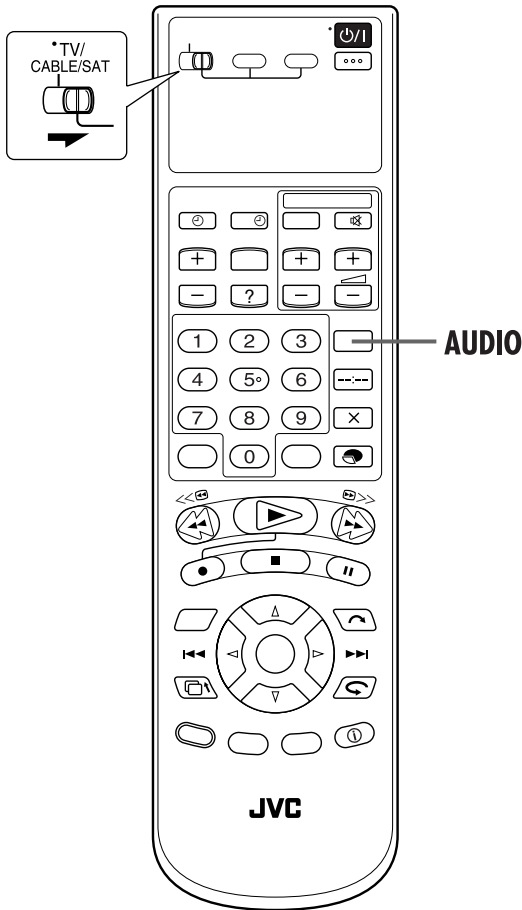

Receiving Stereo and Bilingual Programmes

Your recorder is equipped with a Digital stereo sound decoder (NICAM) making reception of stereo and bilingual broadcasts possible.

When the channel is changed, the type of broadcast being received will be displayed on the TV screen for a few seconds.

Type of Broadcast Being Received	On-screen Display
Regular Monaural NICAM Stereo NICAM Bilingual NICAM Monaural	(none) ST NICAM BIL. NICAM NICAM

- To listen to a stereo programme, press **AUDIO** until "HIFI L R" appears on the TV screen.
- To listen to a bilingual programme, press **AUDIO** until "HIFI L R" or "HIFI R" appears on the TV screen (as required).
- To listen to the standard (Regular Monaural) audio while receiving a NICAM broadcast, press **AUDIO** until "NORM" appears on the TV screen.

NOTE:

"O.S.D." must be set to "ON" or the on-screen displays will not appear (pg. 82).

To Record NICAM Stereo and Bilingual Programmes

The NICAM audio programme will be recorded on the Hi-Fi audio track, and the standard audio programme will be recorded on the normal audio track.

NOTES:

- If the quality of stereo sound being received is poor, the broadcast will be received in monaural with better quality.
- Before playing back a programme recorded in stereo, or a bilingual programme, refer to "Soundtrack Selection" on page 41.

B.E.S.T. Picture System

The B.E.S.T. (Biconditional Equalised Signal Tracking) system checks the condition of the tape in use during playback and recording, and compensates to provide the highest-possible playback and recording pictures. You can set "B.E.S.T." to "ON" or "OFF" to your preference (☞ pg. 81).

Playback

The recorder assesses the quality of the tape once you initiate playback.

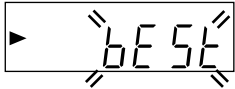

- The recorder adjusts the playback picture quality based on the quality of the tape in use.
- B.E.S.T. is active during automatic tracking. "bEST" appears blinking on the recorder's front display panel.

NOTES:

- When watching a tape recorded with "B.E.S.T." set to "ON", it is recommended that you leave B.E.S.T. on during playback as well.
- When watching a rental tape or one recorded on another video recorder, or when using this recorder as the player for editing, set B.E.S.T. to your preference (☞ pg. 81).
- "bEST" only appears at the beginning of automatic tracking. Even though it doesn't appear after that, the B.E.S.T. function is operative.

Recording

The recorder assesses the quality of the tape once you initiate recording.

DURING B.E.S.T.

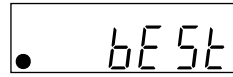

B.E.S.T. COMPLETE

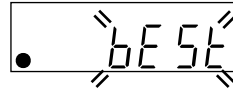

- The recorder spends approximately 7 seconds assessing the condition of the tape, then begins recording.

NOTES:

- The B.E.S.T. system works for both SP and LP modes only after a tape has been inserted and the Record mode is first initiated. It does not work during recording.
- The B.E.S.T. system does not work while Automatic Satellite Programme Recording is in progress (☞ pg. 51).
- In the case of timer recordings, the B.E.S.T. system works before recording is initiated.
- Once the cassette is ejected, the B.E.S.T. data is cancelled. The next time the cassette is used for recording, B.E.S.T. is re-performed.
- Pressing the recorder's ● button while "bEST" is displayed does not start Instant Timer Recording (☞ pg. 42).

ATTENTION

Since the B.E.S.T. system works before recording actually starts, there is a delay of approximately 7 seconds after ● and ▶ on the remote control are pressed, or ● on the recorder is pressed. To make sure you record the desired scene or programme in its entirety, first perform the following steps:

① Press and hold || and press ● to engage the Record Pause mode.

- The recorder then automatically checks the condition of the tape and, after approximately 7 seconds, re-enters Record Pause mode.

② Press ▶ to start recording.

If you want to bypass the B.E.S.T. system and begin recording immediately, set "B.E.S.T." to "OFF" (☞ pg. 81).

VIDEO PLUS+[®] Timer Programming

You can programme this recorder to timer-record as many as 16 programmes.

With the VIDEO PLUS+ system, timer programming is greatly simplified because each TV programme has a corresponding code number which your recorder is able to recognize.

Before performing the VIDEO PLUS+ Timer Programming:

- Make sure that the recorder's built-in clock is set properly.
- Turn on the TV and select the AV mode.
- Slide TV/CABLE/SAT switch to the right.

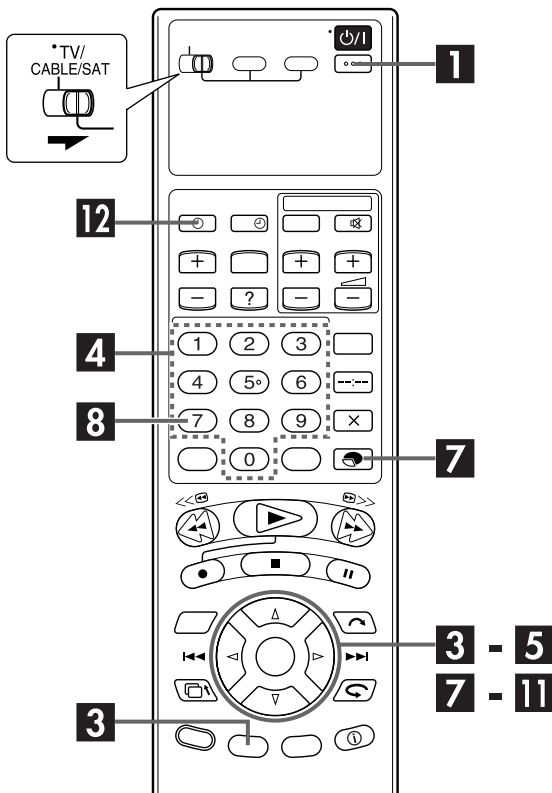

1 Turn on the recorder.

Press power .

2 Load a cassette.

Insert a VHS (or S-VHS) cassette with the record safety tab intact.

3 Access the VIDEO PLUS+ screen.

- 1 Press **PROG.**
 - 2 Press \triangle \triangleright to move the arrow to "VIDEO PLUS+", then press **OK**.
- When "PROGRAMME FULL DELETE UNWANTED TIMER PROGRAMME" appears on the TV screen, you need to cancel some of the currently set programmes. (pg. 50)

4 Enter the PLUSCODE number.

Press the **number keys** to enter the PLUSCODE number of a programme you wish to record.

OR

- 1 Press \triangle \triangleright \triangleright \triangleright to move the arrow to the desired number key, then press **OK**.
 - 2 Repeat step 1 to enter all needed numbers.
- If you make a mistake and needed to delete the last entered number, press \triangle \triangleright \triangleright \triangleright to move the arrow to "DELETE", then press **OK**.
 - To delete all entered numbers at the same time, press \triangle \triangleright \triangleright \triangleright to move the arrow to "DELETE ALL", then press **OK**.

5 Select the recording deck, then confirm the PLUSCODE number.

- 1 Press \triangle \triangleright \triangleright \triangleright to move the arrow to "RECORD TO", then press **OK**.
 - 2 Press \triangle \triangleright to select "HDD" or "VHS", then press **OK**.
 - 3 Press \triangleright to select "CONFIRM", then press **OK**.
- If the number you entered is invalid, "PLUSCODE NO. ERROR CONFIRM PLUSCODE NO. THEN RETRY" appears on the TV screen. Input a valid PLUSCODE number.
 - If "SET GUIDE PROG THEN RETRY" appears on the TV screen, set Guide Program Numbers (pg. 83) manually.

6 Check the programme data.

The PLUSCODE number you entered and the matching timer-recording information are displayed on the TV screen. Check they are correct.

- To cancel this setting, press **PROG.**



IMPORTANT

Make sure the channel position number you wish to record is displayed; if not, see "VIDEO PLUS+ System Setup" on page 83 and set the Guide Program number correctly.

7 Set the recording speed.

- 1 Press \triangle \triangleright to move the arrow to "REC MODE", then press **OK**.
- 2 Press \triangle \triangleright to select the desired mode, then press **OK**.

8 Set the PDC mode.

- 1 Press Δ ∇ to move the arrow to "VPS/PDC".
- 2 Press **PDC** to select "ON" or "OFF".

OR

- 1 Press Δ ∇ to move the arrow to "VPS/PDC", then press **OK**.
- 2 Press Δ ∇ to select the desired setting, then press **OK**.
 - If "VPS/PDC ON" is displayed on the TV screen, PDC is set to ON.
 - If "VPS/PDC OFF" is displayed on the TV screen, PDC is set to OFF.
 - ☞ "PDC Recording" on page 49.
 - VPS (Video Programme System) recording is not currently available in the U.K. and not possible with this recorder.

9 Set the WEEKLY/DAILY programme mode.

- 1 Press Δ ∇ to move the arrow to "WEEKLY/DAILY", then press **OK**.
- 2 Press Δ ∇ to select the desired mode, then press **OK**.
 - For details on each mode, see WEEKLY/DAILY programme timer settings (☞ right column).

10 Set other options.

- 1 Press Δ ∇ to move the arrow to the desired option, then press **OK**.
- 2 Set each option as required.
 - To modify a programme title, perform steps 2 and 3 of "Modify Programme Title" (☞ pg. 57).
 - To modify the category option, press \triangleleft \triangle \triangleright ∇ to select the desired category, press **OK**, press \triangleleft \triangle \triangleright ∇ to move the arrow to "EXIT", then press **OK**.

11 Return to the normal screen.

- Press Δ ∇ to move the arrow to "EXIT", then press **OK**.
- If "PROGRAMME OVERLAPPED" appears on the TV screen, see page 50.
 - To continue timer programming for other programmes, press \triangleleft \triangleright to move the arrow to "CONTINUE", then press **OK**.

12 Engage the recorder's timer mode.

• **For the HDD deck (with the PDC mode is OFF):**
No operation is required to engage the recorder's mode.

• **For the VHS deck and the HDD deck (with the PDC mode is ON):**

Press \ominus (**TIMER**). The recorder turns off automatically and " \ominus " appears on the front display panel.

- To disengage the timer mode, press \ominus (**TIMER**) again.

NOTES:

- During timer recording with " \ominus " appearing on the front display panel, it is not possible to change the recording deck (HDD or VHS).
- It is not possible to timer-record a TV programme with a PLUSCODE number which starts with "0".

WEEKLY/DAILY programme timer settings

• For the HDD deck

When you select a mode other than ONCE, the space on the hard disk drive is saved for new recordings by overwriting previous recordings. To prevent loss of a needed recording, backup programmes you wish to save by dubbing them to tape before overwriting previous recordings.

ONCE (One time recording)

In this mode a programme will not be automatically overwritten.

WEEKLY (OVERWRITE) (Weekly Recording/Weekly Overwrite)

When the set weekly programme is broadcast, the programme recorded last week is automatically deleted and overwritten by the new programme.

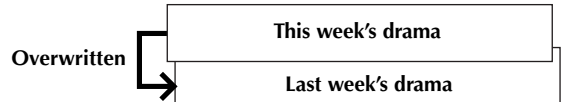

MON-SUN (FOR A WEEK)/ MON-SAT (FOR A WEEK)/ MON-FRI (FOR A WEEK) (Daily Recording/Weekly Overwrite)

When the set weekly programme is broadcast, the programme recorded on the same day last week is automatically deleted and overwritten by the new programme.

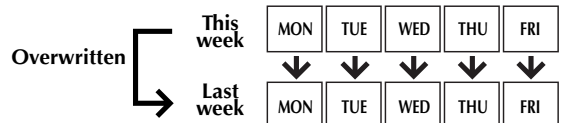

MON-SUN (OVERWRITE)/ MON-SAT (OVERWRITE)/ MON-FRI (OVERWRITE) (Daily Recording/Daily Overwrite)

When the set daily programme is broadcast, yesterday's programme is automatically deleted and overwritten by the new programme.

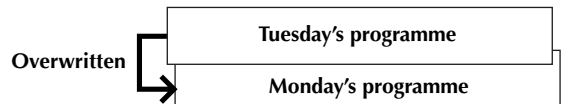

• For the VHS deck

ONCE (Once Recording)

WEEKLY (Weekly Recording)

MON-SUN/MON-SAT/MON-FRI (Daily Recording)

Satellite Receiver Users

To timer-record a satellite broadcast using the VIDEO PLUS+ system:

- 1 Perform "Satellite Receiver Control Setting" on page 18.
- 2 Perform steps 1 – 12. In step 6, the front display panel shows "L2" for the channel position. In step 8, you cannot set "PDC" to "ON".
- 3 Leave the satellite receiver's power on.

Express Timer Programming

You can programme this recorder to timer-record as many as 16 programmes.

If you do not know the PLUSCODE number for the programme you wish to record, use the following procedure to set your recorder to timer-record the programme.

Before performing Express Timer Programming:

- Make sure that the recorder's built-in clock is set properly.
- Turn on the TV and select the AV mode.
- Slide TV/CABLE/SAT switch to the right.

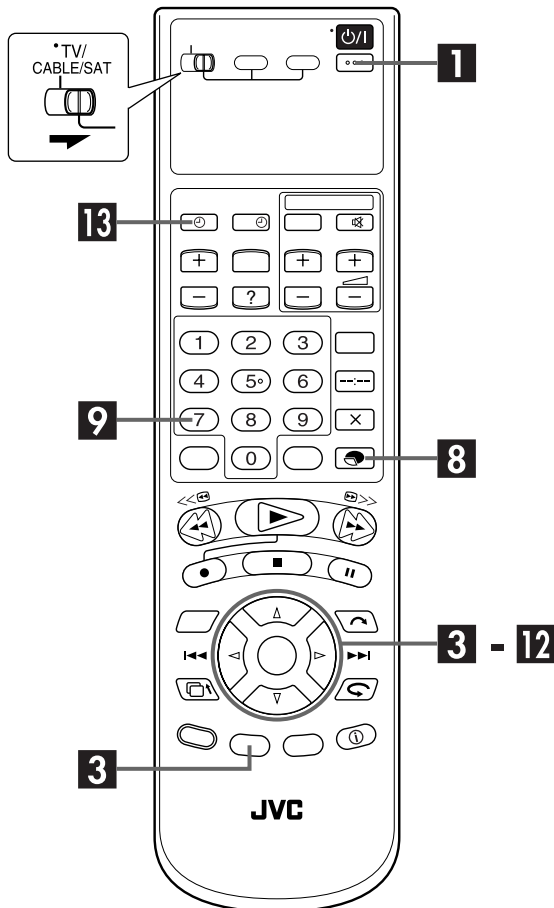

1 Turn on the recorder.

Press P/I .

2 Load a cassette.

Insert a VHS (or S-VHS) cassette with the record safety tab intact.

3 Access the programme screen.

1 Press **PROG**.

2 Press \triangle \triangleright to move the arrow to "PROGRAMME", then press **OK**.

- When "PROGRAMME FULL DELETE UNWANTED TIMER PROGRAMME" appears on the TV screen, you need to cancel some of the currently set programmes. (☞ pg. 50)

4 Select the programme date.

Press \triangle \triangleright \triangleright \triangleright to move the arrow to the desired date, then press **OK**.

5 Select the recording deck.

1 Press \triangle \triangleright to move the arrow to "RECORD TO", then press **OK**.

2 Press \triangle \triangleright to select "HDD" or "VHS", then press **OK**.

6 Set the start time and stop time of the programme.

1 Press \triangleright to move the arrow to "START" or "STOP", then press **OK**.

2 Press \triangle \triangleright to select the desired time, then press **OK**.

7 Select the channel position.

1 Press \triangleright to move the arrow to "TV PROG", then press **OK**.

2 Press \triangle \triangleright to select the desired channel, then press **OK**.

- If you want to set a satellite programme, press the **number key "0"** to change "TV PROG" to "SAT", then press **VCR PR+/-**.

3 Press \triangleright to move the cursor to "CONFIRM", then press **OK**.

8 Set the recording speed.

1 Press \triangle \triangleright to move the arrow to "REC MODE", then press **OK**.

4 Press \triangle \triangleright to select the desired mode, then press **OK**.

9 Set the PDC mode.

- 1 Press \triangle ∇ to move the arrow to "VPS/PDC".
- 2 Press **PDC** to select "ON" or "OFF".

OR

- 1 Press \triangle ∇ to move the arrow to "VPS/PDC", then press **OK**.
- 2 Press \triangle ∇ to select the desired setting, then press **OK**.
 - If "VPS/PDC ON" is displayed on the TV screen, PDC is set to ON.
 - If "VPS/PDC OFF" is displayed on the TV screen, PDC is set to OFF.
 - ☞ "PDC Recording" in the right column.
 - VPS (Video Programme System) recording is not currently available in the U.K. and not possible with this recorder.

10 Set the WEEKLY/DAILY programme mode.

- 1 Press \triangle ∇ to move the arrow to "WEEKLY/DAILY", then press **OK**.
- 2 Press \triangle ∇ to select the desired mode, then press **OK**.
 - For details on each mode, see "WEEKLY/DAILY programme timer settings" (☞ pg. 47).

11 Set other options.

- 1 Press \triangle ∇ to move the arrow to the desired option, then press **OK**.
- 2 Set each option as required.
 - To modify a programme title, perform steps 2 and 3 of "Modify Programme Title" (☞ pg. 57).
 - To modify the category option, press \triangle ∇ to select the desired category, press **OK**, press \triangle ∇ to move the arrow to "EXIT", then press **OK**.

12 Return to the normal screen.

- Press \triangle ∇ to move the arrow to "EXIT", then press **OK**.
- If "PROGRAMME OVERLAPPED" appears on the TV screen, see page 50.
 - To continue timer programming for other programmes, press \triangle ∇ to move the arrow to "CONTINUE", then press **OK**.

13 Engage the recorder's timer mode.

- **For the HDD deck (with the PDC mode is OFF):**
No operation is required to engage the recorder's mode.
- **For the VHS deck and the HDD deck (with the PDC mode is ON):**

Press \ominus (**TIMER**). The recorder turns off automatically and " \ominus " appears on the front display panel.

- To disengage the timer mode, press \ominus (**TIMER**) again.

NOTES:

- During timer recording with " \ominus " appearing on the front display panel, it is not possible to change the recording deck (HDD or VHS).
- When you check, cancel, or change programme, see page 50.

Satellite Receiver Users

To timer-record a satellite broadcast using Express Timer Programming:

- 1 Perform "Satellite Receiver Control Setting" on page 18.
- 2 Perform steps 1 – 3. In step 2, change "TV PROG" to "SAT". The front display panel shows "L-2" for the channel position. Then select the channel position for the satellite broadcast. In step 2, you cannot set "PDC" to "ON".
- 3 Leave the satellite receiver's power on.

PDC Recording

Now available from some TV stations, PDC (Programme Delivery Control) is a service designed to assure safe, accurate timer recording. With this system, special code signals are transmitted together with the audio/video signals. These code signals control your video recorder and have precedence over the advertised times which you may have preset into the timer. This means that your recorder will start and stop recording when the preset TV programmes actually start and end — even if the broadcast time of a preset TV programme is changed from what has been advertised. PDC is currently available nationally on BBC1, BBC2, Ch.4 and Ch.5, except from a few small relay transmitters. Ch.3 operates a PDC service in some areas. All channels intend to offer this service in due course. Check your TV programme listing guide for latest information. If the channel you intend to record does not offer a PDC service your recorder will not start recording if PDC has been selected. Be sure to set PDC to "OFF" if PDC is not available on your selected channel. (See step 8 on page 47 and step 9 in the left column.)

NOTES:

- When you use Express Timer Programming, set the start time (PDC time) exactly as advertised in the TV listing. A different time than advertised will result in no recording.
- PDC recording is also possible when a satellite receiver or a cable system is connected to L-2 IN/DECODER connector on your recorder.
- PDC recording is also possible via the L-1 IN/OUT connector.

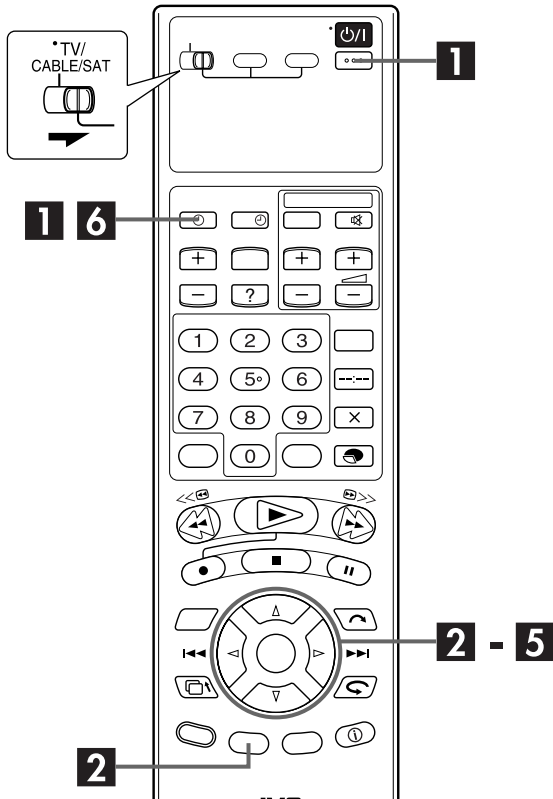

To cancel or change a programme...

4 Cancel or change a programme.

To cancel the programme, press \triangle \square \triangleright \triangleright to move the arrow to "CANCEL", then press **OK**.

To change programme settings, perform steps **4** to **11** of "Express Timer Programming". (pg. 48)

5 Return to the normal screen.

Press \triangle \square \triangleright \triangleright to move the arrow to "EXIT", then press **OK**.

6 Return to the timer mode.

- For the HDD deck (with the PDC mode is OFF): No settings are required to engage recorder's mode.
- For the VHS deck and the HDD deck (with the PDC mode is ON): Press **TIMER**.

NOTE:

When you make a timer programming, see page 48.

Check, cancel and change programmes

1 Disengage the timer mode. (VHS deck only)

Press **TIMER**, then press **TV/**.

2 Access the Programme Check screen, then select the date.

- 1 Press **PROG.**
- 2 Press \triangle \square \triangleright \triangleright to move the arrow to "PROGRAMME LIST", then press **OK**.
- 3 Press \triangle \square \triangleright \triangleright to move the arrow to the desired date, then press **OK**.

3 Access the Programme screen.

Press \triangle \triangleright to select the programme, then press **OK**.



Automatic Satellite Programme Recording

NOTE:

This function is available for the HDD deck only.

This function allows you to automatically record a satellite programme which is timer-programmed on your external satellite receiver. Connect a satellite receiver to the recorder's L-2 IN/DECODER connector and programme the timer on the satellite receiver. When the signals come into the recorder from the satellite receiver, the recorder automatically turns on and starts recording on HDD deck.

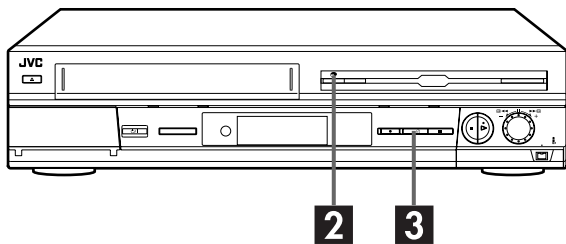

NOTES:

- To disengage the Automatic Satellite Programme Recording mode, press **SAT**.
- If the recorder's power is off, it is not possible to engage the Automatic Satellite Programme Recording mode.
- In step 1, if the **Ⓛ** and **Ⓞ** indicators do not light but instead blink quickly even though your satellite receiver's power is off, Automatic Satellite Programme Recording will not work properly with that satellite receiver*. If this is the case, perform "Express Timer Programming" (pg. 48) to timer-record a satellite programme.
- * Some satellite receivers output signals even if the power is off. Automatic Satellite Programme Recording is not possible with those satellite receivers.
- The **Ⓛ** and **Ⓞ** indicators blink while Automatic Satellite Programme Recording is in progress.
- For timer programming of the satellite receiver, refer to the instruction manual of the satellite receiver.
- Automatic Satellite Programme Recording is not possible if your satellite receiver does not have a timer.
- Pressing the recorder's **⏻/⏮** button while Automatic Satellite Programme Recording is in progress turns off the recorder's power and disengages the Automatic Satellite Programme Recording mode.
- If there are more than one satellite programmes you wish to record with Automatic Satellite Programme Recording, it is not possible to set different recording speeds for each programme.
- Depending on the type of satellite receiver, the recorder may not record a slight portion of the beginning of the programme or may record slightly longer than the actual length of the programme.
- If you engage the Automatic Satellite Programme Recording mode when the satellite receiver's power is on, the recorder will not start Automatic Satellite Programme Recording even though the **Ⓛ** and **Ⓞ** indicators blink. When the satellite receiver shuts off once and is turned back on again, the recorder starts recording.
- You can also record a programme from your cable system in the same way if the system has a timer.
- Just Clock (pg. 84) does not work when the Automatic Satellite Programme Recording mode is engaged.
- When the Automatic Satellite Programme Recording mode is engaged, or the recorder's power is turned off after Automatic Satellite Programme Recording is finished, the recorder will not enter the Timer mode even though "AUTO TIMER" is set to "ON" (pg. 82).

ATTENTION

- Be sure not to turn on the satellite receiver before the programme is executed; otherwise, the recorder will start recording when the satellite receiver's power is turned on.
- If you have connected another appliance other than a satellite receiver to the L-2 IN/DECODER connector, be sure not to engage the Automatic Satellite Programme Recording mode; otherwise, the recorder will start recording when the connected appliance's power is turned on.
- Automatic Satellite Programme Recording and timer-recording cannot be done at the same time.

Before performing the following steps:

- Make sure the satellite receiver is connected to the recorder's L-2 IN/DECODER connector. (pg. 76)
- Programme the timer on the satellite receiver.
- Slide **TV/CABLE/SAT** switch to the right.

1 Select the L-2 SELECT mode.

- Set "L-2 SELECT" to "A/V" or "SAT" (pg. 69).
- When you select "SAT", refer to "IMPORTANT" on page 76.

2 Set the recording speed.

Press **MODE**.

3 Engage the Automatic Satellite Programme Recording mode.

Press and hold **SAT** for about 2 seconds. The **Ⓛ** and **Ⓞ** indicators will light in the front display panel.

Remote A/B/C/D Code Switching

The remote control is capable of controlling four JVC video recorders independently. Each of recorders can respond to one of four codes (A, B, C or D). The remote control is preset to send A code signals because your video recorder is initially set to respond to A code signals. You can easily modify your video recorder to respond to B, C or D code signals.

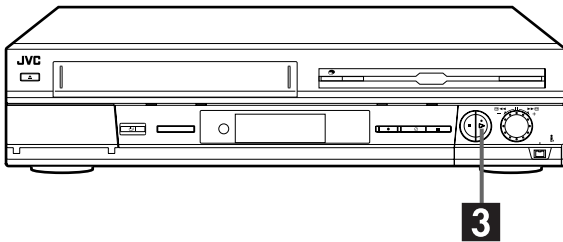
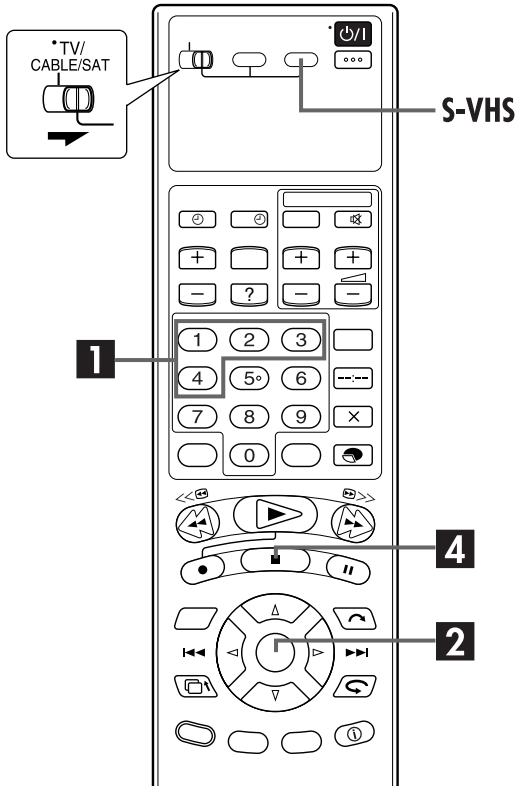

On the remote control

- Slide TV/CABLE/SAT to the right, then press and hold S-VHS during steps **1** through **2**.

1 Change the remote control code.

Press the **number key "1"** for A, "2" for B, "3" for C or "4" for D.

2 Set the remote control code.

Press **OK** to set the code.

On the recorder

3 Display the code.

Press **▶** on the recorder for over 5 seconds while the recorder is turned off. The code currently set appears on the front display panel.

- If the code displayed on the front display panel is different from the code set on the remote control, go to step **4**.

4 Change the recorder's code.

Press **■** on the remote control. The code currently set on the remote control will be applied to the recorder.

TV Multi-Brand Remote Control

Your remote control can operate the basic functions of your TV set. In addition to JVC TVs, other manufacturer's TVs can also be controlled.

Before performing the following steps:

Turn off the TV using its remote control.

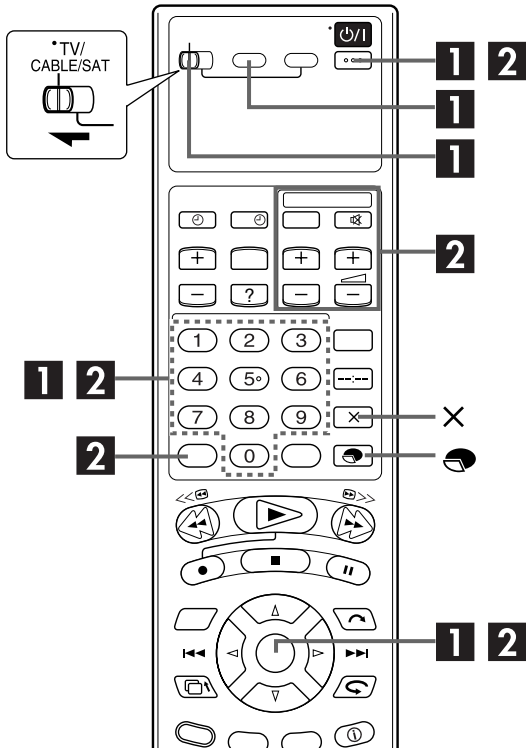

Control Your TV Using Additional Buttons

Use the **number keys**, and the button, X button to select the TV's channel.

- With televisions under Code 01, 02, 07, 10, 11, 14, 20, 23, 24, 25, 27, 33 or 35, the button corresponds to the 1-digit/2-digit entry switching button (often labelled - / -) of your TV's remote control.
- With televisions under Code 01, 28, 29 or 34, the X button corresponds to the 10 + button of your TV's remote control.

NOTE:

The way these buttons are used is determined by your TV. Use these buttons as instructed for your TV's remote control.

1 Set the TV brand code.

Slide **TV/CABLE/SAT** to the left and keep **S-VHS** pressed during this step.

Enter your TV's brand code using the **number keys**, then press **OK**.

Press on the recorder's remote control to turn on the TV and try operations (step 2).

- Once you have set the remote control to operate the TV, you do not have to repeat this step until you replace your remote control's batteries.
- Some brands of TV have more than one code. If the TV does not function with one code, try entering another.

2 Operate the TV.

Press the corresponding button: , **TV/VCR**, **TV PR +/-**, **TV AV**, **TV +/-** (Volume), (TV Muting), **number keys**.

- For some brands of TV, you must press **OK** after having pressed the **number keys**.

IMPORTANT

Although the provided remote control unit is compatible with JVC televisions, as well as many other models, it may not work with your TV, or in some instances, may have limited function capability.

BRAND NAME	CODE
JVC	01, 23, 24, 25
BLAUPUNKT	19
BRANDT	26
FERGUSON	27
FINLUX	30
FUNAI	32
LG/GOLDSTAR	18
GRAETZ	28
GRUNDIG	19
HITACHI	10
ITT	28
LUXOR	28
MITSUBISHI	03
MIVAR	29
NEC	20
NOKIA	31
NORDMENDE	26
PANASONIC	11
PHILIPS	02
SABA	26
SALORA	28
SAMSUNG	02, 12, 33, 34, 35
SELECO	28
SHARP	06
SONY	07
TELEAVIA	26
TELEFUNKEN	26
THOMSON	26
TOSHIBA	14

Satellite Receiver Multi-Brand Remote Control

Your remote control can operate the basic functions of your satellite receiver set. In addition to JVC satellite receivers, other manufacturer's satellite receivers can also be controlled.

Before performing the following steps:

Turn off the satellite receiver using its remote control.

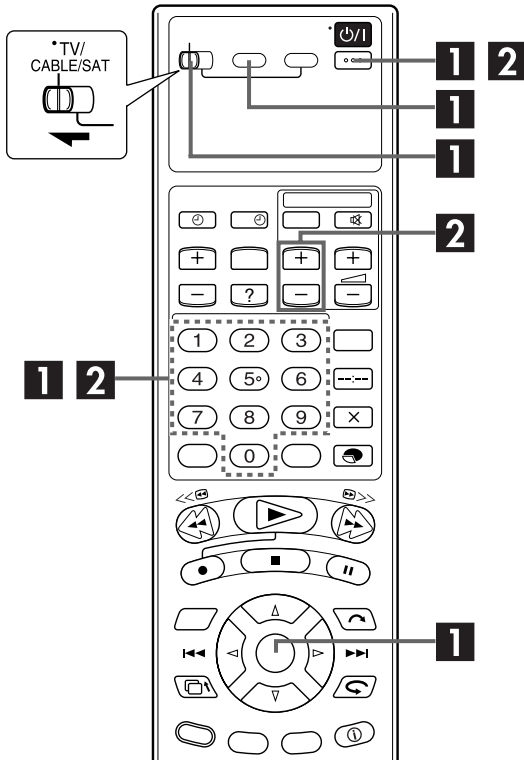

IMPORTANT

Although the provided remote control unit is compatible with JVC satellite receivers, as well as many other models, it may not work with your satellite receiver, or in some instances, may have limited function capability.

1 Set the satellite receiver brand code.

Slide **TV/CABLE/SAT** to the left and keep **S-VHS** pressed during this step.

Enter your satellite receiver's brand code using the **number keys**, then press **OK**.

Press **⏻** on the recorder's remote control to turn on the satellite receiver and try operations (see step **2**).

- Once you have set the remote control to operate the satellite receiver, you do not have to repeat this step until you replace your remote control's batteries.
- Some brands of satellite receiver have more than one code. If the satellite receiver does not function with one code, try entering another.

2 Operate the satellite receiver.

Press the corresponding button: **⏻**, **TV PR +/-**, **number keys**.

- The **number keys** may not function with some satellite receivers.

BRAND NAME	CODE
JVC	73
AMSTRAD	60, 61, 62, 63, 92
CANAL SATELLITE	81
CANAL +	81
D-BOX	85
ECHOSTAR (VIA DIGITAL)	82
FINLUX	68
FORCE	89
GALAXIS	88
GRUNDIG	64, 65, 102
HIRSCHMANN	64, 78, 99
HUMAX	88
ITT NOKIA	68
KATHREIN	70, 71, 96
LUXOR	68
MASCOM	93
MASPRO	70
NOKIA	87, 94
PACE	65, 67, 74, 86, 92
PANASONIC	74, 92
PHILIPS	66, 84, 101
RADIX	78
RFT	69
SABA	97
SAGEM	83, 90
SALORA	68
SAMSUNG	83
SIEMENS	64
SKYMASTER	69, 98
TECHNISAT	66, 100
THOMSON	97
TPS	83
TRIAX	91
WISI	64

About Hybrid Navigation

In the sections “Playback with HDD Navigation” (☞ pg. 24) and “Playback with VCR Navigation” (☞ pg. 36), it is briefly described how to search for the beginning of each recorded programme using the Navigation functions. More detailed explanations are provided in this section using HDD Navigation by way of example.

This recorder has a built-in Hybrid Navigation system, which consists of two Navigation systems (HDD Navigation and VCR Navigation). Using Navigation system, you can easily modify registered information or edit the programme when dubbing from the HDD deck to VHS deck, as well as search for the beginning of each programme.

About registration of information

The following information is automatically registered for each programme when ordinary recording or timer recording is performed, then stored in an area specified on the hard disk. For the VHS deck, set “NAVIGATION” to “ON” (☞ pg. 79).

- index* (reduced still pictures to show programme titles)
- programme title*
- category*
- date and time
- channel
- recording speed
- length of recording time

The items marked with an asterisk (*) can be easily modified and registered again after recording by using Navigation system.

About editing of programmes

Navigation system has six functions for editing of programmes.



- “Modify Information” (☞ pg. 56)
- “Delete Programme Information” (☞ pg. 58)
- “Divide Programme (available only for HDD Navigation)” (☞ pg. 58)
- “Play List Features” (☞ pg. 60)
- “Easy Dubbing from HDD deck to VHS deck” (☞ pg. 63)
- “Audio Dubbing” (☞ pg. 74)

The limitations of registration

You can register information up to 100 programmes in HDD Navigation. In VCR Navigation, you can register information up to 2000 programmes or up to 680 cassettes.

To register the information for VCR Navigation, you need to record a programme for more than 5 minutes in SP mode (for more than 15 minutes in LP mode).

When the amount of information is at the limits of registration, you cannot record new programme any more. In this case, you need to delete old programmes to register new one (☞ pg. 58).

Modify Information

NOTE:

The Navigation systems cannot work during recording on the HDD deck or in SAT mode (see pg. 51).

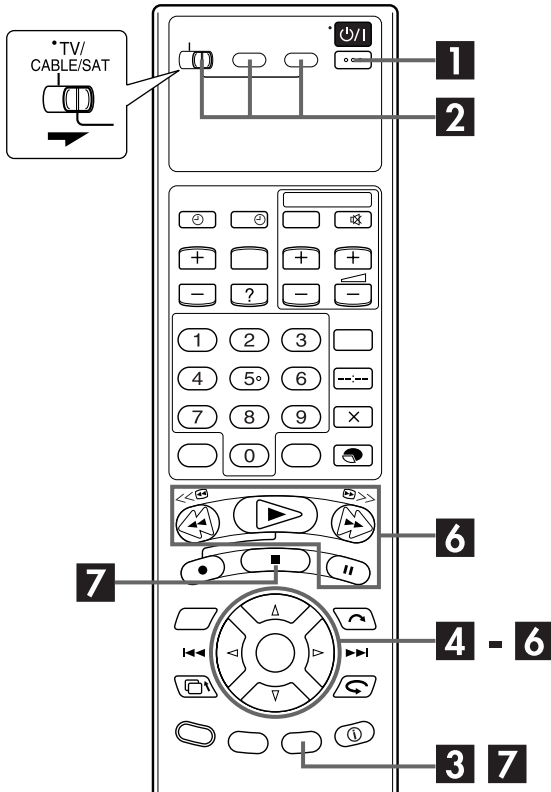

Modify Index

1 Turn on the recorder.

Press ψ/I .

2 Select the deck.

Slide **TV/CABLE/SAT** to the right, then press **HDD** or **S-VHS**.

• For the VHS deck:

Insert a cassette with the record safety tab intact.

3 Access the Navigation screen.

Press **EDIT**.

- The Navigation screen corresponding to the selected deck appears.
- **For the VHS deck:**
When "NAVIGATION" is set to "OFF" (see pg. 79), the Navigation screen does not appear.

4 Select the programme.

- 1 Press $\triangleleft \triangleright$ to move the arrow to "MODIFY" under "REC LIST", then press **OK**.
 - 2 Press $\triangleleft \triangle \triangleright \triangledown$ to move the arrow to the desired programme index, then press **OK**.
- **For the VHS deck:**
- 1 Press $\triangleleft \triangleright$ to move the arrow to "MODIFY" under "PROGRAMME", then press **OK**.
 - 2 Press $\triangleleft \triangle \triangleright \triangledown$ to move the arrow to the desired cassette index, then press **OK**.
 - 3 Press $\triangleleft \triangle \triangleright \triangledown$ to move the arrow to the desired programme index, then press **OK**.

5 Access the modify screen.

Press $\triangleleft \triangleright$ to move the arrow to "INDEX", then press **OK**.

6 Register new index.

- 1 Confirm the arrow is on "REPLACE". Playback starts in the left large window.
 - 2 Search for the needed programme picture by pressing the appropriate buttons (\triangleright , **II**, \triangleleft , or \triangleright). You can also search for the picture by turning and pressing the **JOG** dial.
 - 3 Press **OK** to register the new index. New index appears in the right window.
- When you press **OK** with the arrow on "RETURN" you can return to the previous screen.
 - While you are editing a programme in DV mode, the distortion of the picture on the small window (showing the result of the edition) does not affect the actual edited picture.

7 Return to the normal screen.

Press **EDIT**.

• For the VHS deck:

Press \blacksquare to cancel pause mode after pressing **EDIT**.

Modify Category

Perform steps **1** to **4** of "Modify Index" (☞ pg. 56) before continuing.

1 Access the modify screen.

Press ◀▶ to move the arrow to "CATEGORY", then press **OK**.

2 Select new category.

Press ◀△▷▽ to move the arrow to the desired category, then press **OK**.

3 Return to the normal screen.

Press **EDIT**.

Modify Programme Title

Perform steps **1** to **4** of "Modify Index" (☞ pg. 56) before continuing.

1 Access the modify screen.

Press ◀▶ to move the arrow to "TITLE", then press **OK**.

2 Enter new title.

Press ◀△▷▽ to move the arrow to the desired letter or command, then press **OK**. Repeat this process to complete the title.

- To select the letter to be corrected, press ◀△▷▽ to move the arrow to "<" or ">", then press **OK** repeatedly until the desired letter is selected.
- To delete the selected letter, press ◀△▷▽ to move the arrow to "DELETE", then press **OK**.
- To cancel the modification, press ◀△▷▽ to move the arrow to "CANCEL", then press **OK**. Title remains as previously set.
- You can enter up to 26 letter for each title.

3 Register new title.

Press ◀△▷▽ to move the arrow to "SAVE", then press **OK**.

4 Return to the normal screen.

Press **EDIT**.

Modify Cassette Title (available only for VHS Navigation)

Perform steps **1** to **3** of "Modify Index" (☞ pg. 56) before continuing.

1 Select the programme and access the modify screen.

- 1 Press ◀▶ to move the arrow to "MODIFY TITLE" under "LIBRARY", then press **OK**.
- 2 Press ◀△▷▽ to move the arrow to the desired cassette index, then press **OK**.

2 Enter and register new title.

Perform steps **2** to **3** of Modify Programme Title". (☞ left column)

3 Return to the normal screen.

Press **EDIT**.

Delete Programme Information

For HDD Navigation:

When you delete the registered information of a programme, the recorder delete only the programme itself on the hard disk drive. The deleted programme is never resumed.

For VCR Navigation:

When you delete the registered information of a programme, the recorder delete only the information on the hard disk drive. The programme itself cannot be deleted with VCR Navigation.

Perform steps **1** to **3** of "Modify Index" (☞ pg. 56) before continuing.

1 Select the programme and access the delete screen.

- 1 Press ◀▶ to move the arrow to "DELETE" under "REC LIST", then press **OK**.
- 2 Press ◀△▶▽ to move the arrow to the desired programme index, then press **OK**.

• For the VHS deck:

- 1 Press ◀▶ to move the arrow to "MODIFY" under "PROGRAMME", then press **OK**.
- 2 Press ◀△▶▽ to move the arrow to the desired cassette index, then press **OK**.
- 3 Press ◀△▶▽ to move the arrow to the desired programme index, then press **OK**.
- 4 Press ◀▶ to move the arrow to "DELETE", then press **OK**.

- A message appears for your confirmation.

2 Confirm the deletion.

Press ◀▶ to select "DELETE", then press **OK**.

- When you cancel the deletion, select "CANCEL", then press **OK**.

3 Return to the normal screen.

Press **EDIT**.

Delete Cassette Information (available only for VHS Navigation)

Perform steps **1** to **3** of "Modify Index" (☞ pg. 56) before continuing.

1 Select the programme and access the delete screen.

- 1 Press ◀▶ to move the arrow to "DELETE" under "LIBRARY", then press **OK**.
- 2 Press ◀△▶▽ to move the arrow to the desired cassette index, then press **OK**.

2 Confirm the deletion.

Press ◀▶ to move the arrow to "DELETE", then press **OK**.

3 Return to the normal screen.

Press **EDIT**.

Divide Programme (available only for HDD Navigation)

Perform steps **1** to **3** of "Modify Index" (☞ pg. 56) before continuing.

1 Select the programme and access the divide screen.

- 1 Press ◀▶ to move the arrow to "DIVIDE" under "REC LIST", then press **OK**.
- 2 Press ◀△▶▽ to move the arrow to the desired programme index, then press **OK**.

2 Locate the divide point.



- 1 Confirm the arrow is on "DIVIDE". Playback starts in the left large window.
- 2 Press the appropriate buttons (▶, ||, ►►, or ◀◀) to search for the divide point. You can also search for the divide point by turning and pressing the **JOG** dial.
- 3 Press **OK** at the divide point. The first picture (start) of the newly created programme appears in the right bottom window.
 - To play the first 10 seconds of the newly created programme, press ◀▶ to move the arrow to "PREVIEW", then press **OK**.
 - To cancel the divide point and set another one, press ◀▶ to move the arrow to "RETRY", press **OK**, then perform step 2 again.
 - While you are editing a programme in DV mode, the distortion of the picture on the small window (showing the result of the edition) does not affect the actual edited picture.

3 Register the new programme.

Press ◀▶ to move the arrow to "OK", then press **OK**.

4 Return to the normal screen.

Press **EDIT**.

NOTE:

The indexes of programmes in record, registered in the play list, or recorded using daily/weekly timer recording do not appear in the list window in step 1 and you cannot select these programmes to divide.

Play List Features

A play list is a collection of the scenes selected from original recorded programmes. A play list can be freely edited and played back without ever changing any original recorded data. A play list includes information such as the beginning and ending time of the scenes, indexes for checking the contents of the recorded data, category information, and more. Playback according to the play list you have created allows you to enjoy various combinations of video images from programmes recorded on the hard disk drive.

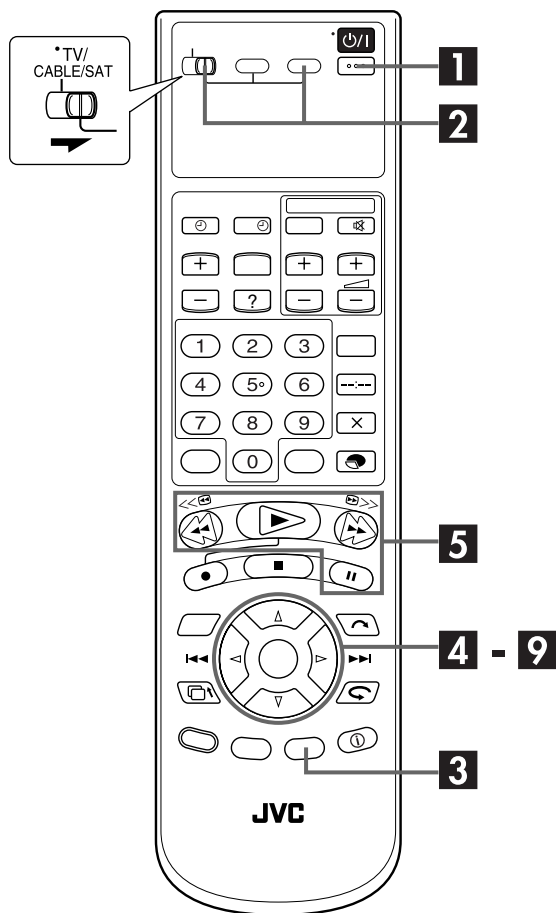

Create Play List

1 Turn on the recorder.

Press TV/CABLE/SAT .

2 Select the deck.

Slide **TV/CABLE/SAT** to the right, then press **HDD**.

3 Access the Navigation screen.

Press **EDIT**.

4 Select the programme and access the play list screen.

- 1 Press \triangle \square \triangleright \triangleright to move the arrow to "CREATE" under "PLAY LIST", then press **OK**.
 - 2 Press \triangle \square \triangleright \triangleright to move the arrow to the original programme index for the play list to reference, then press **OK**.
- Playback of the selected programme starts in the left large window.

5 Select the desired scene.

- 1 Confirm the arrow is on "IN/OUT". The picture for the beginning of the selected scene appears in the left bottom "IN" window.
- 
- 2 Press the appropriate buttons (\triangleright , **II**, $\triangleright\triangleright$, or $\triangleleft\triangleleft$) to search for the desired point. You can also search for the desired point by turning and pressing the **JOG** dial.
 - 3 Press **OK** when beginning picture of the desired scene is found.
 - 4 Perform steps 1 to 3 again to locate the ending picture for the desired scene. The picture selected as the ending scene appears in the right bottom "TO" window.
- The selected scene information (original programme number, beginning time and ending time) appears in the scene list and playback of the programme after the selected scene starts.
 - While your are editing a programme in DV mode, the distortion of the picture on the small window (showing the result of the edition) does not affect the actual edited picture.

6 Select other scenes.

Repeat step 5 as required.

- To select a scene in another programme, press \triangle \square \triangleright \triangleright to move the arrow to "SELECT PROG.", then press **OK**. After that, repeat steps 2 of 4 and 5.

7 Confirm the play list.

Press $\triangleleft \triangle \triangleright \triangleright$ to move the arrow to "PREVIEW", then press **OK**.

- Playback of current play list starts in the left large window.

8 Register the selected scenes.

Press $\triangleleft \triangle \triangleright \triangleright$ to move the arrow to "OK", then press **OK**.

9 Return to the normal screen.

Press $\triangleleft \triangleright$ to move the arrow to "EXIT", then press **OK**.

- When you edit the play list, press $\triangleleft \triangleright$ to move the arrow to "MODIFY", then press **OK**.
- To play back the play list you have created, refer to "Scan for Beginning of Programme (or Play List)" (☞ pg. 25).

NOTE:

You cannot include scenes recorded in DV mode and scenes recorded in another mode in the same play list.

Edit Scenes

You can change beginning and ending scene time in the play list.

Perform steps **1** to **3** of "Create Play List" (☞ pg. 60) before continuing.

1 Select the play list.

- 1 Press $\triangleleft \triangle \triangleright \triangleright$ to move the arrow to "MODIFY" under "PLAY LIST", then press **OK**.
- 2 Press $\triangleleft \triangle \triangleright \triangleright$ to move the arrow to the desired play list index, then press **OK**.

2 Access the play list screen.

Press $\triangleleft \triangle \triangleright \triangleright$ to move the arrow to "SCENE", then press **OK**.

3 Select the beginning or ending time.

- 1 Press $\triangleleft \triangle \triangleright \triangleright$ to move the arrow to "MODIFY", then press **OK**.
- 2 Press $\triangleleft \triangle \triangleright \triangleright$ to move the arrow to the desired beginning/ending time, then press **OK**.



4 Change the beginning or ending time.

Perform step **3** of "Create Play List".

- To cancel the change, press $\triangleleft \triangle \triangleright \triangleright$ to move the arrow to "RETRY", then press **OK**.

5 Register the modified play list.

Press $\triangleleft \triangle \triangleright \triangleright$ to move the arrow to "OK", then press **OK**.

6 Return to the normal screen.

Press $\triangleleft \triangleright$ to move the arrow to "EXIT", then press **OK**.

- To continue to edit the play list, press $\triangleleft \triangleright$ to move the arrow to "MODIFY", then press **OK**.

Move scenes

You can change the order of the scenes in a play list.

Perform steps **1** to **3** of "Create Play List" (☞ pg. 60), then steps **1** and **2** of "Edit Scenes" (☞ pg. 61) before continuing.

1 Select the scene.

- 1 Press $\triangleleft \triangle \triangleright \triangleright$ to move the arrow to "MOVE", then press **OK**.
- 2 Press $\triangle \triangleright$ to move the arrow to the desired scene to move in the scene list, then press **OK**.

2 Select the insert destination.

Press $\triangle \triangleright$ to move the arrow to the desired scene that is to be inserted next to the inserted scene selected in step **1**, then press **OK**.

- The selected scene moves down after inserted scene.
- To cancel move scene operation, press $\triangleleft \triangle \triangleright \triangleright$ to move the arrow to "RETRY", then press **OK**.

3 Register the modified play list.

Press $\triangleleft \triangle \triangleright \triangleright$ to move the arrow to "OK", then press **OK**.

4 Return to the normal screen.

Press $\triangleleft \triangleright$ to move the arrow to "EXIT", then press **OK**.

- To continue to edit the play list, press $\triangleleft \triangleright$ to move the arrow to "MODIFY", then press **OK**.

Delete scenes

Perform steps **1** to **3** of "Create Play List" (☞ pg. 60), then steps **1** and **2** of "Edit Scenes" (☞ pg. 61) before continuing.

1 Delete the scene.

- 1 Press ◀ ▶ ▷ ▽ to move the arrow to "DELETE", then press **OK**.
- 2 Press △ ▽ to move the arrow to the desired scene to be deleted in the scene list, then press **OK**.
 - To cancel delete scene operation, press ◀ ▶ ▷ ▽ to move the arrow to "RETRY", then press **OK**.

2 Register the modified play list.

Press ◀ ▶ ▷ ▽ to move the arrow to "OK", then press **OK**.

3 Return to the normal screen.

Press ◀ ▶ to move the arrow to "EXIT", then press **OK**.

- To continue to edit the play list, press ◀ ▶ to move the arrow to "MODIFY", then press **OK**.

Modify Index

- 1 Perform steps **1** to **3** of "Create Play List" (☞ pg. 60).
- 2 Perform step **1** of "Edit Scenes" (☞ pg. 61).
- 3 Perform steps **5** to **7** of "Modify Index" (☞ pg. 56).
 - For this procedure, "programme" described in step **6** of "Modify Index" must be read as "play list".

Modify Category

- 1 Perform steps **1** to **3** of "Create Play List" (☞ pg. 60).
- 2 Perform step **1** of "Edit Scenes" (☞ pg. 61).
- 3 Perform steps **1** to **3** of "Modify Category" (☞ pg. 57).

Modify Play List Title

- 1 Perform steps **1** to **3** of "Create Play List" (☞ pg. 60).
- 2 Perform step **1** of "Edit Scenes" (☞ pg. 61).
- 3 Perform steps **1** to **4** of "Modify Programme Title" (☞ pg. 57).

Delete Play List

Perform steps **1** to **3** of "Create Play List" (☞ pg. 60) before continuing.

1 Select the play list and access the delete screen.

- 1 Press ◀ ▶ to move the arrow to "DELETE" under "PLAY LIST", then press **OK**.
- 2 Press ◀ ▶ ▷ ▽ to move the arrow to the desired play list index, then press **OK**.

2 Confirm the deletion.

Press ◀ ▶ to move the arrow to "DELETE", then press **OK**.

3 Return to the normal screen.

Press **EDIT**.

Dubbing

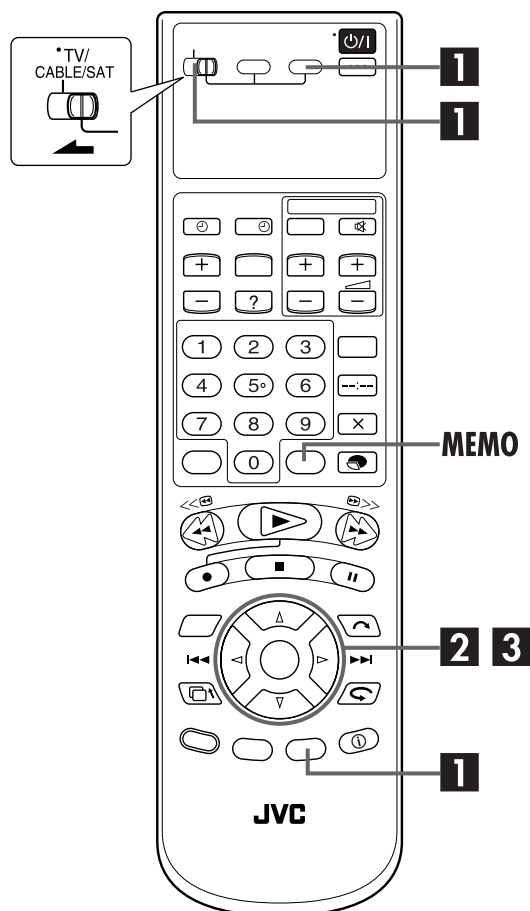

Easy Dubbing from HDD deck to VHS deck

Because this recorder includes both HDD deck and VHS deck, you can easily use it for dubbing up to eight programmes (or play lists) without connecting any other equipment.

1 Access the HDD Navigation screen.

Slide TV/CABLE/SAT to the right, then press HDD, then press **EDIT**.

2 Access the Easy Dubbing screen.

Press ◀ ▶ ▷ ▼ to move the arrow to "EDITING", then press **OK**.

3 Select the programme(s).

Press ◀ ▶ ▷ ▼ to move the arrow to the desired programme index, then press **OK** when you dub only one programme (or play list). The message for preparing a cassette appears.



- When you want to select more programmes, press **MEMO** instead of pressing **OK** after selecting the desired programme. The playback order numbers appear on the index. After all the programmes (or play lists) desired for dubbing are selected, press **OK**.
- If you want to correct playback order, move the arrow to the desired index and press **MEMO**. The number is deleted and the recorder automatically renumbers the other programmes (or play lists).
- If you want to cancel the current playback order, press **X**.

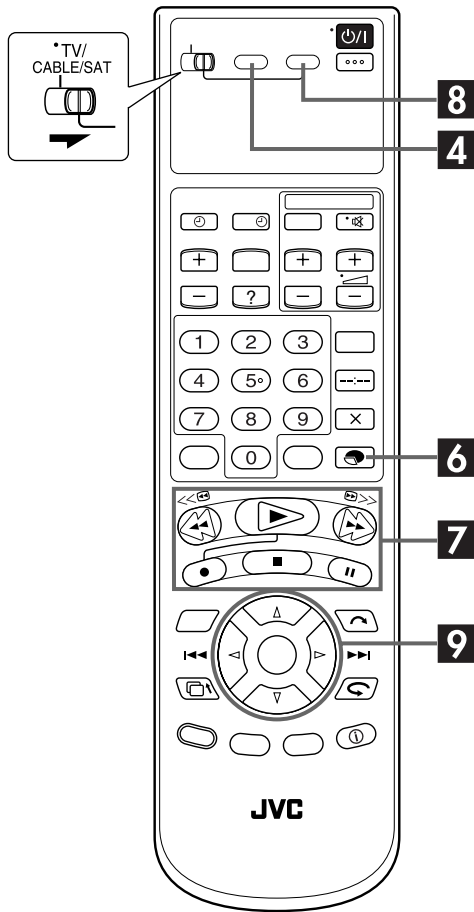

4 Select the VHS deck.

Press **S-VHS**.

5 Load a cassette.

Insert a cassette with the record safety tab intact.

6 Set the recording speed.

Press **MODE**.

7 Locate the start point.

- 1 Search for the point where you want to start dubbing by pressing **▶**, **▶▶** or **◀◀** then press **■**.
- 2 Press **●** and **||** simultaneously to enter the Record-Pause mode.

8 Select the HDD deck.

Press **HDD**. The Easy Dubbing screen appears again.

9 Start dubbing.

Press **◀▶** to move the arrow to "DUB START", then press **OK**. When the dubbing completes successfully, the message "DUBBING COMPLETED" appears on the TV screen.

- To stop dubbing, press **■**.
- Once the dubbing is stopped, it can not be resumed. In this case, the message appears on the TV screen.

NOTE:

If you start dubbing without setting the VHS deck to Record Pause mode in step 7, you can watch the preview.

Normal Dubbing

(from HDD to VHS)

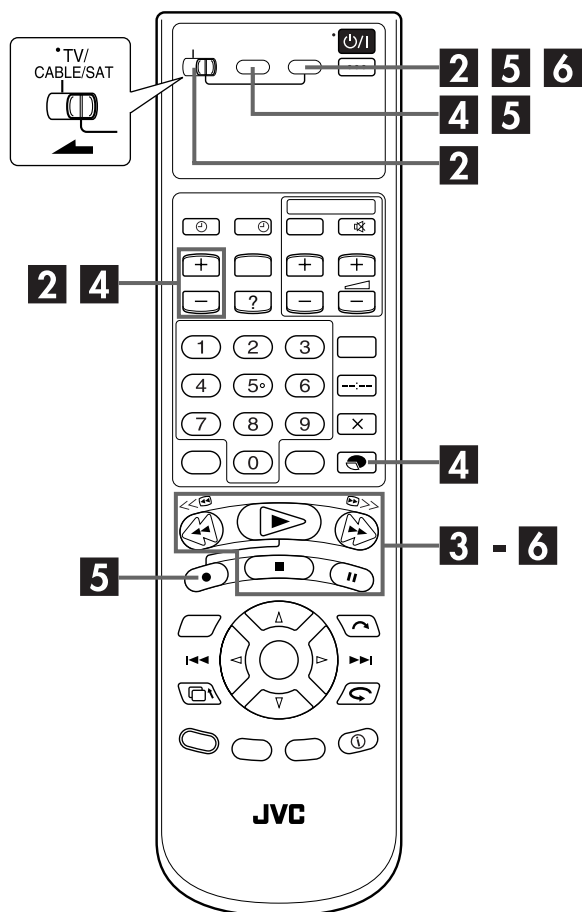

You can dub selected scenes from the HDD deck to a cassette, starting and stopping wherever you wish.

1 Load a cassette.

Insert a cassette with the record safety tab intact.

2 Prepare the HDD deck for dubbing.

- 1 Slide **TV/CABLE/SAT** to the right, then press **HDD** and select the programme to be dubbed. You can select the programme by HDD Navigation. (pg. 24)
- 2 Press **VCR PR+/-** to set the channel other than "DUB".

3 Locate the start point.

- 1 Search for the point where you want to start dubbing by pressing **▶**, **▶▶** or **◀◀** then press **■**.
- 2 Press **◀◀** a little, then press **▶** to start playback.
- 3 Press **||** to pause playback a little before the start point.

4 Prepare the VHS deck for dubbing.

- 1 Press **S-VHS**.
- 2 Press **VCR PR+/-** to set the channel "DUB".
- 3 Press **MODE** to select tape speed.
- 4 Search for the point where you want to start dubbing by pressing **▶**, **▶▶** or **◀◀** then press **■**.

5 Start dubbing.

- 1 Press **HDD** and **▶** to start playback.
- 2 Press **S-VHS** and **●** (● and ▶ on the remote control) to start dubbing.

6 End dubbing.

Press **■**. Then press **HDD** and press **■**.

NOTES:

- There may be a discrepancy of several seconds between where you intend editing to start, and where it actually starts.
- The superimposed indication during the operation or dubbing is not recorded.

Normal Dubbing

(from VHS to HDD)

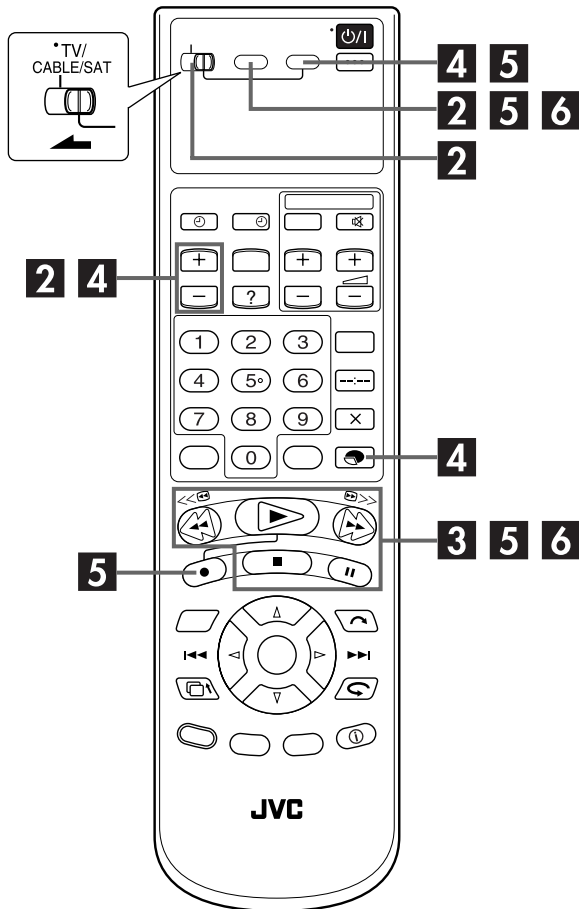

You can dub selected scenes from a cassette to the HDD deck, starting and stopping wherever you wish.

1 Load a cassette.

Insert a cassette with the record safety tab intact.

2 Prepare the VHS deck for dubbing.

- 1 Slide **TV/CABLE/SAT** to the right, then press **S-VHS** and select the programme to be dubbed. You can select the programme by VCR Navigation. (pg. 36)
- 2 Press **VCR PR+/-** to set the channel other than "DUB".
 - Set "PICTURE CONTROL" to "EDIT" (pg. 81).

3 Locate the start point.

- 1 Search for the point where you want to start dubbing by pressing **>**, **>>** or **<<** then press **■**.
- 2 Press **<<** a little, then press **>** to start playback.
- 3 Press **||** to pause playback a little before the start point.

4 Prepare the HDD deck for dubbing.

- 1 Press **HDD**.
- 2 Press **VCR PR+/-** to set the channel "DUB".
- 3 Press **MODE** to select recording speed.

5 Start dubbing.

- 1 Press **S-VHS** and **>** to start playback.
- 2 Press **HDD** and **●** (**●** and **>** on the remote control) to start dubbing.
 - To enter Record-Pause mode, press and hold **●** and press **||** on the remote control. To resume recording, press and hold **●** and press **>** on the remote control.

6 End dubbing.

Press **■** twice. Then press **S-VHS** and press **■**.

NOTES:

- There may be a discrepancy of several seconds between where you intend editing to start, and where it actually starts.
- The superimposed indication during the operation or dubbing is not recorded.
- For HDD deck, the recording pause takes effect only when the recorder is recording on the HDD deck with the channel set to "L-1", "F-1", or "DUB". The recording pause is released in 5 minutes automatically. Picture and sound may be distorted at the point where the recording pause is released.
- Dubbing copyright guarded tape is not possible.
- When you select "EDIT" to dub tapes in step 2, be sure to select "AUTO" (or "NORM" when "B.E.S.T." is set to "OFF") after you finish dubbing the tapes.

Edit From A Camcorder

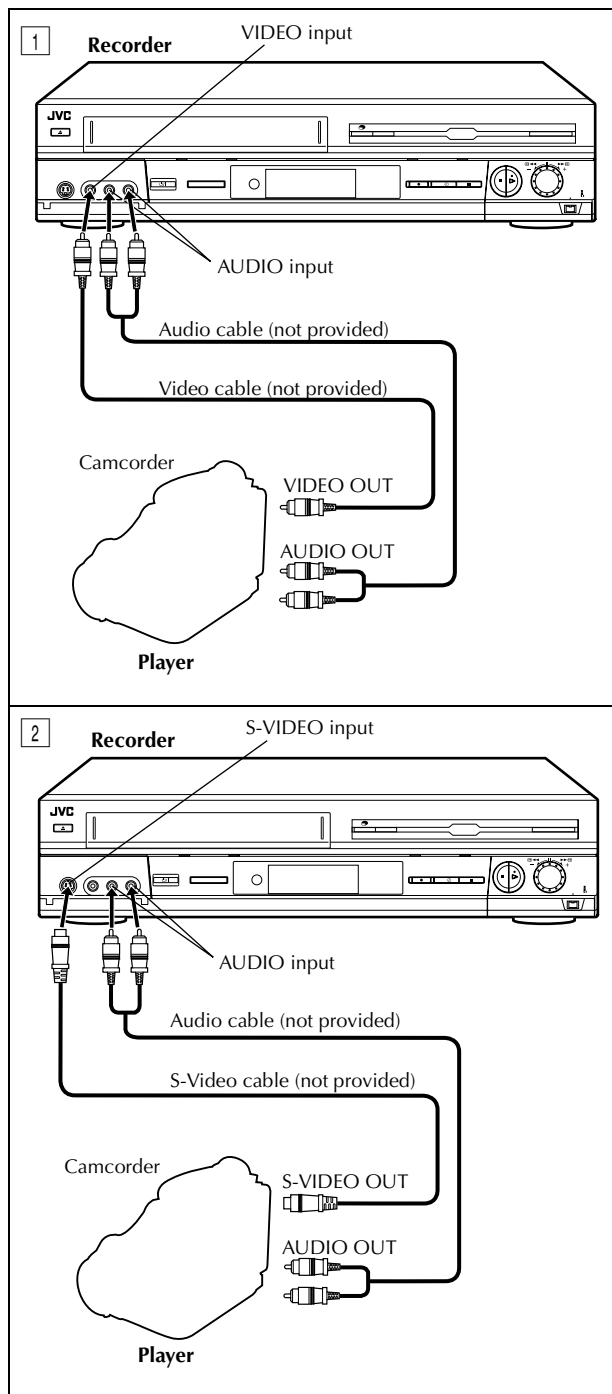

You can use a camcorder as the source player and your recorder as the recording deck.

1 Make connections.

- 1 If the camcorder has no S-VIDEO output connector ... connect the camcorder's AUDIO OUT and VIDEO OUT connectors to the recorder's front panel AUDIO and VIDEO input connectors.
- 2 If the camcorder has an S-VIDEO output connector ... connect the camcorder's AUDIO OUT and S-VIDEO OUT connectors to the recorder's front panel AUDIO and S-VIDEO input connectors.
 - When using a monaural camcorder, connect its AUDIO OUT connector to the AUDIO L input connector on your recorder.
 - **For the VHS deck:**
When a Master Edit Control-equipped JVC camcorder is used, the camcorder is capable of controlling the recorder. Refer to the camcorder's instruction manual for operating procedure.

2 Select the recording deck.

Slide **TV/CABLE/SAT** to the right, then press **HDD** or **S-VHS**.

3 Set the recorder's input mode.

Press **AUX** (number key "0") and/or **VCR PR** to select "F-1".

- Set "F-1 INPUT" to "VIDEO" for the VIDEO input connector, or "S-VIDEO" for the S-VIDEO input connector, depending on the connector being used (ⓘ pg. 69).

4 Set the edit mode. (VHS deck only)

See "PICTURE CONTROL" on page 81.

5 Start the camcorder.

Engage the Play mode of the camcorder.

6 Start the recorder.

Engage the Record mode of the recorder.

NOTES:

- All necessary cables can be obtained from your dealer.
- When you select "EDIT" to dub tapes in step 4, be sure to select "AUTO" (or "NORM" when "B.E.S.T." is set to "OFF") after you finish dubbing the tapes.
- For HDD deck, the recording pause takes effect only when the recorder is recording on the HDD deck with the channel set to "L-1", "F-1", or "DUB". The recording pause is released in 5 minutes automatically. Picture and sound may be distorted at the point where the recording pause is released.
- It is not possible to record only the audio of the connected equipment (without pictures) on the HDD deck.

Output/Input Set

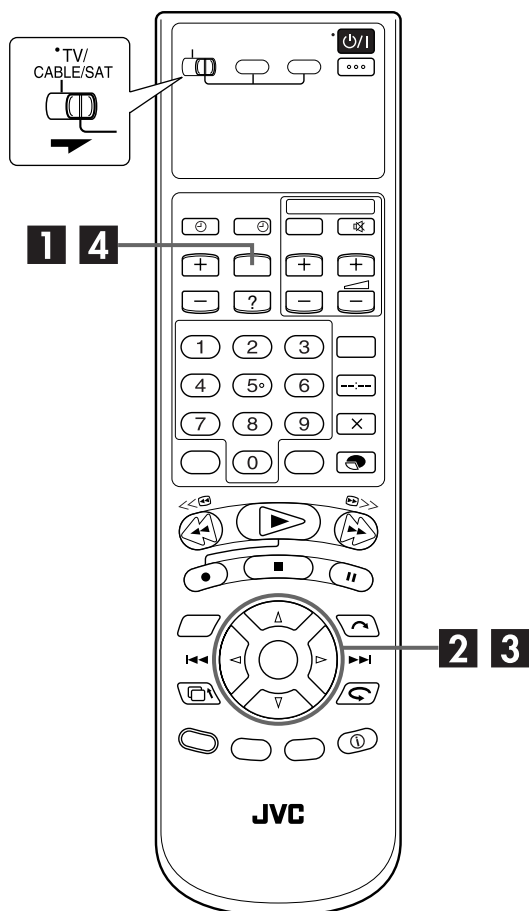

L-1 OUTPUT and L-1 INPUT Setting

The L-1 IN/OUT connector accepts and delivers either a composite signal (regular video signal) or a Y/C signal (a signal in which the luminance and chrominance signals are separated). Set "L-1 OUTPUT" and "L-1 INPUT" to the appropriate mode depending on the type of appliance connected to the recorder's L-1 IN/OUT connector.

1 Access the Main Menu screen.

Press **MENU**.

2 Access the Input/Output Set screen.

- 1 Press \triangleleft \triangleright to move the arrow to "FUNCTION SET UP", then press ∇ .
- 2 Press \triangleleft \triangleright to move the arrow to "INPUT/OUTPUT".

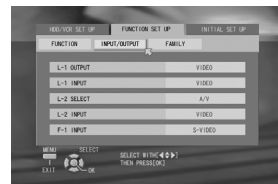

3 Select the output or input mode for the L-1 IN/OUT connector.

- 1 Press \triangle ∇ to move the arrow to "L-1 OUTPUT" or "L-1 INPUT", then press **OK**.
- 2 Press \triangle ∇ to select the appropriate setting, then press **OK**.

* The default setting is **bold** in the table below.

■ L-1 OUTPUT

VIDEO: If a connected appliance's input is compatible only with regular video signals, set to "VIDEO".

S-VIDEO: If a connected appliance's input is compatible with Y/C signals, set to "S-VIDEO". You can obtain high-quality S-VHS picture. (For connection, be sure to use a 21-pin SCART cable that is compatible with the Y/C signal.)

■ L-1 INPUT

VIDEO: If a connected appliance's output is compatible only with regular video signals, set to "VIDEO".

S-VIDEO: If a connected appliance's output is compatible with Y/C signals, set to "S-VIDEO". You can obtain high-quality S-VHS picture. (For connection, be sure to use a 21-pin SCART cable that is compatible with the Y/C signal.)

4 Return to the normal screen.

Press **MENU**.

NOTES:

- If "L-1 OUTPUT" is set to "S-VIDEO", it is impossible to set "L-1 INPUT" to "S-VIDEO".
- If "L-2 SELECT" is set to "DECODER", it is impossible to set "L-1 INPUT" to "S-VIDEO".

L-2 SELECT and L-2 INPUT Setting

Set "L-2 SELECT" and "L-2 INPUT" to the appropriate mode depending on the type of appliance connected to the recorder's L-2 IN/DECODER connector.

Perform steps **1** and **2** of "L-1 OUTPUT and L-1 INPUT Setting" on page 68.

1 Select the input mode for the L-2 IN/DECODER connector.

- 1 Press Δ / ∇ to move the arrow to "L-2 SELECT", then press **OK**.
- 2 Press Δ / ∇ to select the appropriate setting, then press **OK**.

* The default setting is **bold** in the table below.

■ L-2 SELECT

- A/V:** To use this recorder as the recording deck with the player connected to the L-2 IN/DECODER connector, or to use the satellite receiver connected to the L-2 IN/DECODER connector.
- DECODER:** To use a decoder connected to the L-2 IN/DECODER connector.
- SAT:** To view a satellite programme with the TV set while the recorder is turned off. (pg. 76)

■ L-2 INPUT VIDEO:

- VIDEO:** If a connected appliance's output is compatible only with regular video signals, set to "VIDEO".
- S-VIDEO:** If a connected appliance's output is compatible with Y/C signals, set to "S-VIDEO". You can obtain high-quality S-VHS picture. (For connection, be sure to use a 21-pin SCART cable that is compatible with the Y/C signal.)

2 Return to the normal screen.

Press **MENU**.

NOTES:

- If you have a satellite receiver or a decoder connected to the L-2 IN/DECODER connector, be sure to set "L-2 SELECT" back to appropriate mode after editing.
- If you are not connecting a satellite receiver or a decoder to the L-2 IN/DECODER connector, leave "L-2 SELECT" set to "A/V".
- The default setting is "A/V"; if the recorder's memory backup has expired due to a power cut or because the AC was removed from the recorder, "A/V" will be automatically selected when the power is restored to the recorder. If you are using a satellite receiver or a decoder, be sure to set "L-2 SELECT" back to appropriate mode.
- When "L-2 SELECT" is set to "SAT", "SAT" appears on TV screen or front display panel instead of "L-2" or "L2".
- If "L-1 OUTPUT" is set to "S-VIDEO", it is impossible to set "L-2 SELECT" to "DECODER".

F-1 INPUT Setting

Set "F-1 INPUT" to the appropriate mode depending on the connector (VIDEO or S-VIDEO) being used on the front panel.

Perform steps **1** and **2** of "L-1 OUTPUT and L-1 INPUT Setting" on page 68.

1 Select the input mode for the VIDEO/S-VIDEO connector.

- 1 Press Δ / ∇ to move the arrow to "F-1 INPUT", then press **OK**.
- 2 Press Δ / ∇ to select the appropriate setting, then press **OK**.

* The default setting is **bold** in the table below.

■ F-1 INPUT VIDEO:

- VIDEO:** When connecting an appliance to the VIDEO input connector, set to "VIDEO".
- S-VIDEO:** When connecting an appliance to the S-VIDEO input connector, set to "S-VIDEO".

2 Return to the normal screen.

Press **MENU**.

Edit To Or From Another Video Recorder

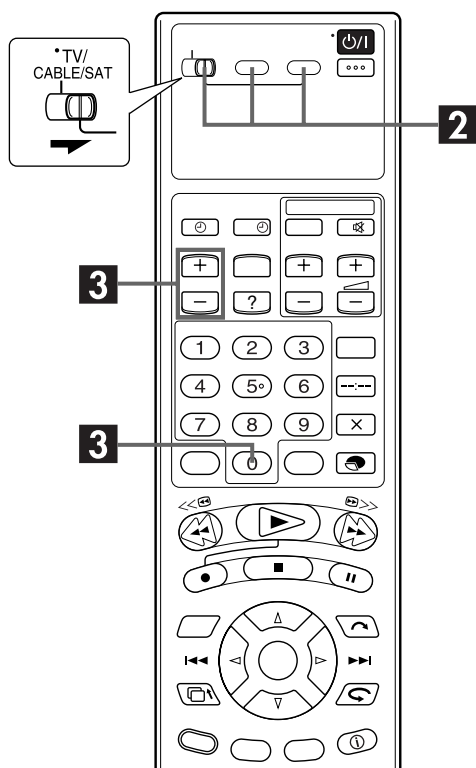

Advantages of S-VHS video recorders

You can edit from VHS to S-VHS, S-VHS to VHS, or, from S-VHS to S-VHS.

- From VHS to S-VHS: Record VHS playback signals in the S-VHS mode. Although the picture quality is inherently limited by that of the original, the edited tape has better picture quality than those made by VHS-to-VHS editing.
- From S-VHS to VHS: Because the picture quality of the source material is very high, the edited tape has better picture quality than those made by VHS-to-VHS editing.
- From S-VHS to S-VHS: All signals will be transferred with minimum degradation.

You can use your recorder as the source player or as the recording deck.

1 Make connections.

Connect the player's 21-pin SCART connector to the recorder's 21-pin SCART connector as illustrated on page 71.

- 1 When using your recorder as the source player ... connect its L-1 IN/OUT connector to the recording deck.
- 2 When using your recorder as the recording deck ... connect its L-1 IN/OUT or L-2 IN/DECODER connector to the source player.
- 3 If another recorder is compatible with the Y/C signal ... connect your recorder's L-1 IN/OUT connector to another recorder.

With 3 connection ...

- When using your recorder as the recording deck, set "L-1 INPUT" to "S-VIDEO" and "L-2 SELECT" to "AV" (☞ pg. 68, 69).
- When using your recorder as the source player, set "L-1 OUTPUT" to "S-VIDEO" (☞ pg. 68).

2 Select the recording deck.

Slide TV/CABLE/SAT to the right, then press **HDD** or **S-VHS**.

3 Set the input mode of recording deck.

With this video recorder, press **AUX** (number key "0") and/or **VCR PR** to select "L-1" for the L-1 IN/OUT connector, or "L-2" for the L-2 IN/DECODER connector, depending on the connector being used.

- When using another recorder as the recording deck, refer to its instruction manual.
- When using the L-2 IN/DECODER connector, set "L-2 SELECT" to "AV" (☞ pg. 69).

4 Set the edit mode.

See "PICTURE CONTROL" on page 81.

5 Start the source player.

Engage the Play mode of the source player.

6 Start the recording deck.

Engage the Record mode of the recording deck.

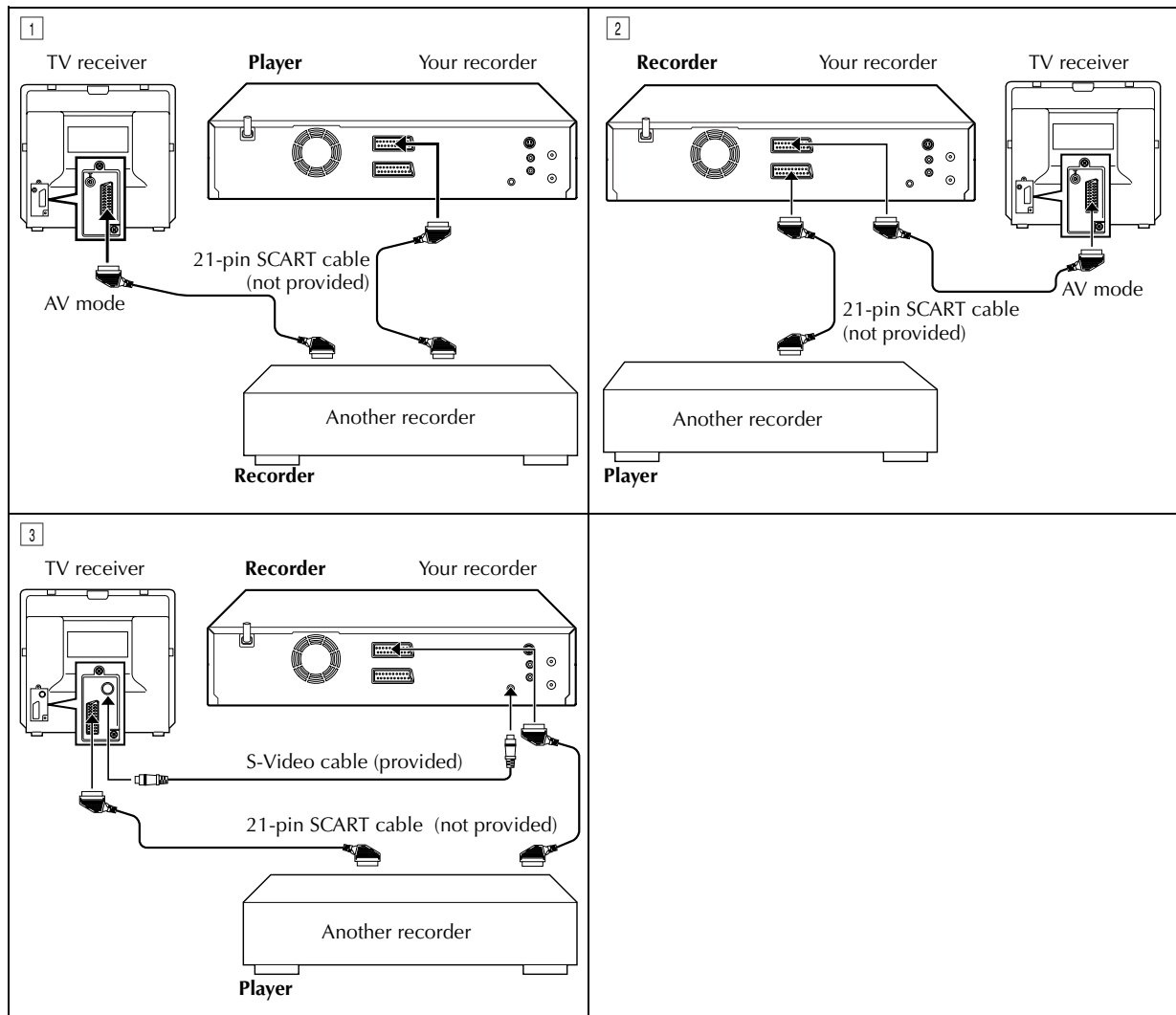

NOTES:

- All necessary cables can be obtained from your dealer.
- For Y/C signal input/output, be sure to use a 21-pin SCART cable that is compatible with the Y/C signal.
- When you select "EDIT" to dub tapes in step **4**, be sure to select "AUTO" (or "NORM" when "B.E.S.T." is set to "OFF") after you finish dubbing the tapes.
- When you use this recorder as the source player for editing, be sure to set "O.S.D." to "OFF" before starting (☞ pg. 82).
- If you are using another recorder with S-Video and AUDIO input/output connectors, you can connect those connectors to this recorder's S-VIDEO and AUDIO input/output connectors.
 - When using your recorder as the source player ...
 - ... connect its rear panel S OUT and AUDIO OUT connectors to the recording deck's S-Video and Audio input connectors.
 - When using your recorder as the recording deck ...
 - ... connect its front panel S-VIDEO and AUDIO input connectors to the source player's S-Video and Audio output connectors. Then, set the recorder's input mode to "F-1", and set "F-1 INPUT" to "S-VIDEO" (☞ pg. 69).

DV Dubbing

You can dub programmes from a camcorder or DV equipment connected to the recorder with a DV cable. The recorder's remote control allows you the limited control of the connected camcorder or DV equipment functions during dubbing.

NOTE:

When you use a PC connecting to the DV IN/OUT connector, we do not assure the normal operation of this recorder.

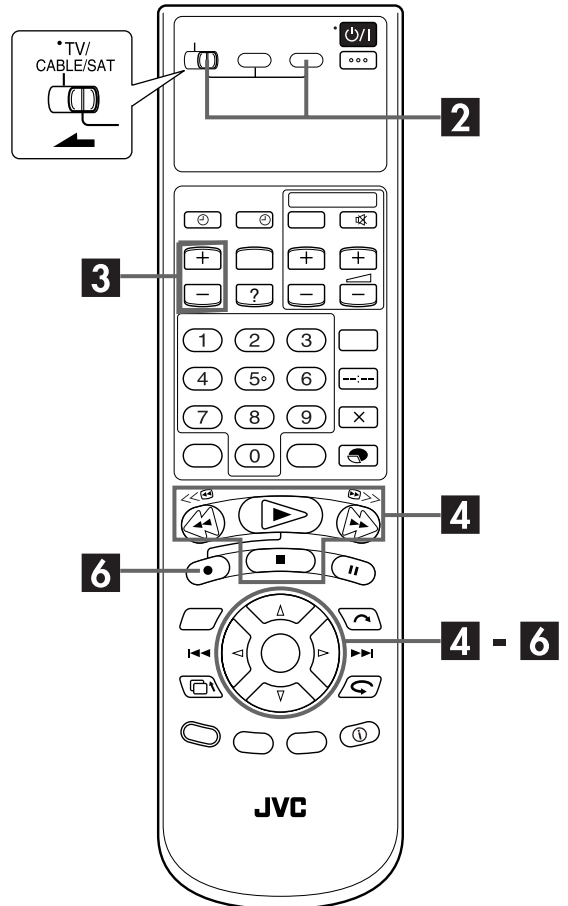
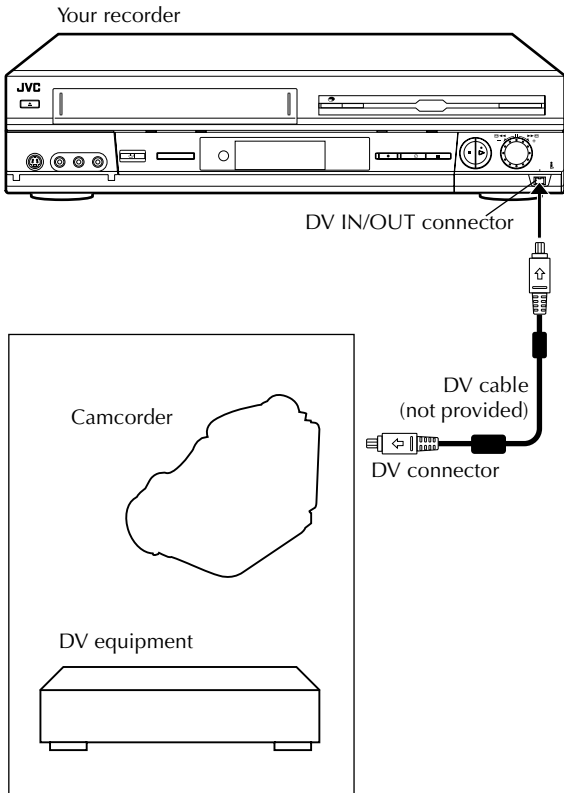

1 Make connections.

Connect the camcorder to the DV IN/OUT connector on the recorder's front panel.

2 Select the HDD deck.

Slide TV/CABLE/SAT to the right, then press **HDD**.



3 Prepare the HDD deck for dubbing.



Press **VCR PR+/-** to set the channel to "D-1".

- The on-screen display for DV dubbing appears.
- Recording speed is automatically set to DV and "DV" appears under the HDD capacity graph.

4 Prepare the DV equipment for dubbing.

- 1 Press $\triangleleft \triangleright$ to move the arrow to , then press **OK** to display the remote icon (facing to the right) for the DV equipment.
- 2 Search for the point from where you want to start dubbing by pressing \blacktriangleright , $\blacktriangleright\blacktriangleright$, or $\blacktriangleleft\blacktriangleleft$, then press **■**.
 - If you select the camcorder's sound mode ("SOUND1", "SOUND2", or "MIX"), during playback of the camcorder, press $\triangleleft \triangleright$ to move the arrow to , then press **OK** repeatedly until the desired mode appears on the TV screen (see pg. 79). Note that this selection is not available when the source programme is recorded in 16BIT mode.

5 Start dubbing.

Press $\triangleleft \triangleright$ to move the arrow to , then press **OK**.

- Playback on the external DV equipment and recording on the HDD deck should start simultaneously.
- When "NO SIGNAL HDD ENTERS RECORD STANDBY MODE" or "CAN NOT RECORD CAN NOT RECOGNIZE CONNECTED DEVICE" appears, the HDD deck stops recording.
- Original DV information other than just time code is also recorded to the HDD along with the programme.



6 End dubbing.

Press $\triangleleft \triangleright$ to move the arrow to , then press **OK**.

When you dub from DV equipment other than a camcorder

- 1 Perform step **1** to **3**.
- 2 Search for the point from where you want to start dubbing, then stop on the DV equipment.
 - If you pause the DV equipment in this step, a few second's still picture will be recorded at the beginning of the recorded programme.
- 3 Set the input mode to "DV INPUT" on the DV equipment.
 - If you select an input mode other than "DV INPUT", unwanted pictures may be recorded at the beginning of the recorded programme.
- 4 Perform step **5** to **6**.

To skip unwanted part of the source picture

- 1 Press **OK** to stop both equipment, then press \triangleleft to move the arrow to .
- 2 Search for the point where you want to restart dubbing by pressing \blacktriangleright , $\blacktriangleright\blacktriangleright$, or $\blacktriangleleft\blacktriangleleft$, then press **■**.
- 3 Press \triangleright to move the arrow to , then press **OK** to restart dubbing.

NOTES:

- It is recommended that you locate the dubbing start point a little before the actual start point on the external DV equipment in step **2** since the beginning of the programme (a few frames) won't be recorded. And you may encounter unwanted pictures inserted at the beginning of the recorded programme. In such cases, edit the recorded programme to delete the unwanted part by using divide and delete features. (see pg. 58)
- When you dub a programme on the recorder to the connected DV equipment, refer to the operating instructions supplied with the DV equipment.
- When the playback picture is distorted or noise appears on the picture, attach a separately sold ferrite core to the DV cable.
- When you dub a programme that was recorded in a recording speed other than "DV" ("SP", "LP", "EP", or "SEP") on the HDD deck into a connected DV equipment, the dubbed programme will be recorded in 16BIT mode. In such a case, note that you cannot replace the sound of the dubbed programme with Audio dubbing feature.

Audio Dubbing

Audio Dubbing replaces the sound of a recorded programme in the recording speed of "DV" on the HDD deck with the sound played back from external audio equipment.

ATTENTION:

Audio dubbing is only possible for the programme having the recording speed of "DV" (12BIT) on the HDD deck.

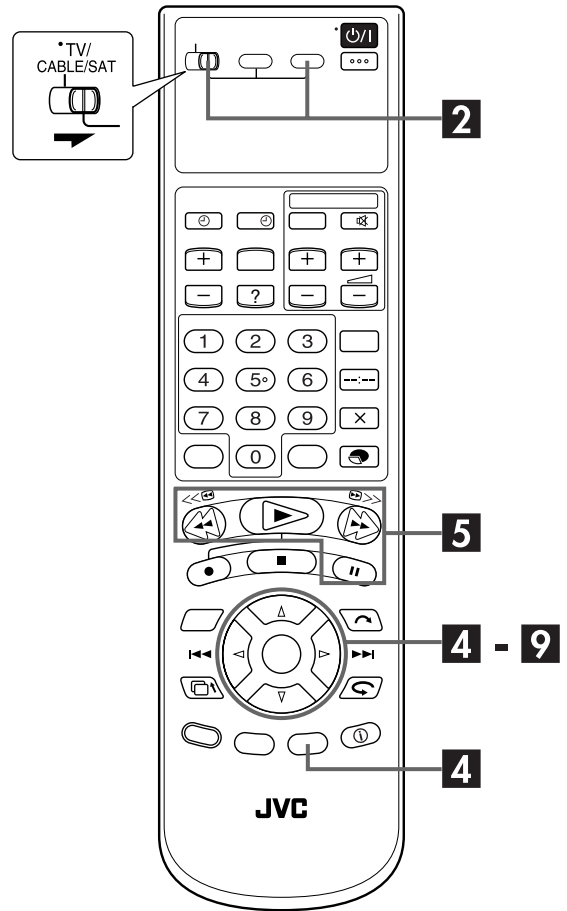
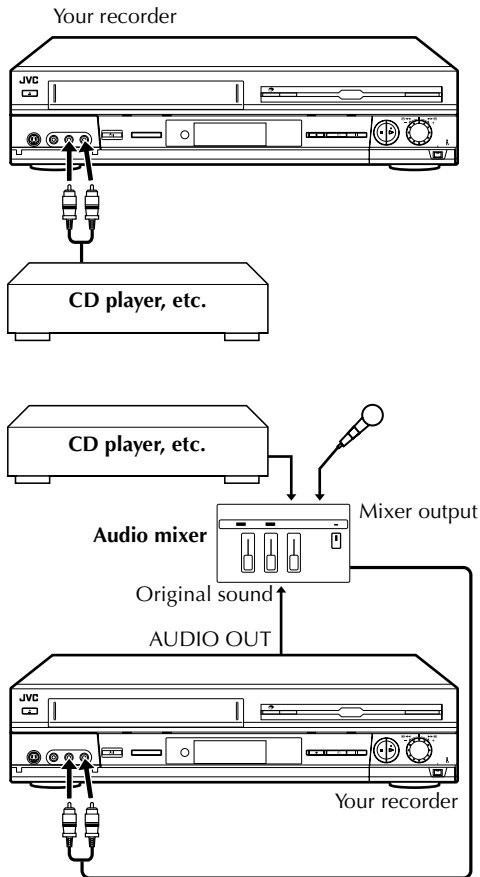

1 Make connections.

Connect an audio component to the AUDIO L + R input connectors on the recorder's front panel.

- When connecting a monaural audio component, use only the recorder's AUDIO L input connector.

2 Select the HDD deck.

Slide TV/CABLE/SAT to the right, then press **HDD**.

3 Select the audio track to monitor the recorded programme's original sound.

Set "AUDIO MDE" to "SOUND1". (pg. 78, 79)

4 Select the programme and access the A. DUB screen.

- 1 Press **EDIT**.
- 2 Press $\triangleleft \triangle \triangleright \nabla$ to move the arrow to "A. DUB", then press **OK**.
- Only the programmes having the recording speed of DV (12BIT) on the HDD appear in the list.
- 3 Press $\triangleleft \triangle \triangleright \nabla$ to move the arrow to the desired programme index, then press **OK**.
- The index of the selected programme appears in the left large window.

5 Prepare the audio component.

Search for the point where you want to start playback and pause playback.

6 Select the desired scene.



- 1 Press $\triangle \nabla$ to move the arrow to "AUDIO SELECT", then press **OK**.
- 2 Press $\triangleleft \triangleright$ to select "HDD", then press **OK**.
- 3 Press $\triangle \nabla$ to move the arrow to "IN/OUT", then press \blacktriangleright to start playback.
- 4 Press the appropriate buttons (\blacktriangleright , \parallel , $\blacktriangleright\blacktriangleright$, or $\blacktriangleleft\blacktriangleleft$) to search for the desired point. You can also search for the point by turning and pressing the **JOG** dial.

- 5 Press **OK** when beginning picture of the desired scene is found. The picture for the selected scene appears in the left bottom "IN" window.

- To cancel the setting, press $\triangleleft \triangle \triangleright \nabla$ to move the arrow to "CANCEL", then press **OK**.
- 6 Perform steps 4 to 5 again to locate the ending picture of the desired scene. The picture for the ending of the selected scene appears in the right bottom "OUT" window.
- While you are editing a programme in DV mode, the distortion of the picture on the small window (showing the result of the edition) does not affect the actual edited picture.

7 Start audio dubbing.

- 1 Press $\triangleleft \triangle \triangleright \nabla$ to move the arrow to "EXECUTE", then press **OK**.
- Countdown images appears 5 seconds before the beginning of the scene.
- You can select the monitoring sound from among the recorded original sound ("SOUND 1"), the sound of the external audio component ("SOUND 2"), and both "SOUND 1" and "SOUND 2" at the same time ("MIX"). Press $\triangle \nabla$ to move the arrow to "AUDIO MONITOR", press **OK**, press $\triangleleft \triangleright$ to select the desired sound, then press **OK**.
- 2 At the actual beginning of the scene, start playback on the audio component.
- Countdown images appears 5 seconds before the ending of the scene.
- 3 Stop playback on the audio component.
- When you play and check the dubbed programme, press $\triangleleft \triangleright$ to move the arrow to "PREVIEW", then press **OK**.
- When you quite dubbing or previewing, press $\triangle \nabla$ to move the arrow to "STOP", then press **OK**.

8 Confirm the edited scene.

Press $\triangleleft \triangle \triangleright \nabla$ to move the arrow to "CONFIRM", then press **OK**.

9 Return to the normal screen.

- Press $\triangleleft \triangleright$ to move the arrow to "EXIT", then press **OK**.
- To edit other programmes, press $\triangleleft \triangleright$ to move the arrow to "CONTINUE", press **OK**, then perform steps 4 to 9.

NOTES:

Audio Dubbing is also possible using the rear panel L-1 IN/OUT or L-2 IN/DECODER connector. When using these 21-pin SCART connectors, be sure to select the appropriate input mode in the A.DUB screen as follows;

- 1 After step 4, press $\triangleleft \triangle \triangleright \nabla$ to move the arrow to "INPUT SELECT", then press **OK**.
- 2 Press $\triangleleft \triangleright$ to select "L-1" or "L-2", then press **OK**.
- When "HDD" is selected as "AUDIO SELECT" option, the sound of the original programme selected in step 4 is heard during audio dubbing. If you wish to monitor sound from the external audio component, perform the following procedure;
- 1 Press $\triangleleft \triangle \triangleright \nabla$ to move the arrow to "AUDIO SELECT", then press **OK**.
- 2 Press $\triangleleft \triangleright$ to select the input connector ("L-1", "L-2", or "F-1") to which the external audio component is connected, then press **OK**.

Connecting To A Satellite Receiver

Simple Connections

This is an example of simple connection if your TV has one 21-pin AV input (SCART) connector.

Connect the satellite receiver to the L-2 IN/DECODER connector, then connect the L-1 IN/OUT connector to the TV's connector.

NOTES:

- Be sure to use a 21-pin SCART cable (not an S-Video cable) for the satellite receiver connection.
- Set "L-2 SELECT" to "A/V" (☞ pg. 69).
- You can use Automatic Satellite Programme Recording function (☞ pg. 51) with this connection.
- To record a programme via the satellite receiver, select L-2 mode by pressing **AUX** (number key "0") and/or **VCR PR** so that "L-2" appears on the front display panel.
- For details, refer to the instruction manual of the satellite receiver.

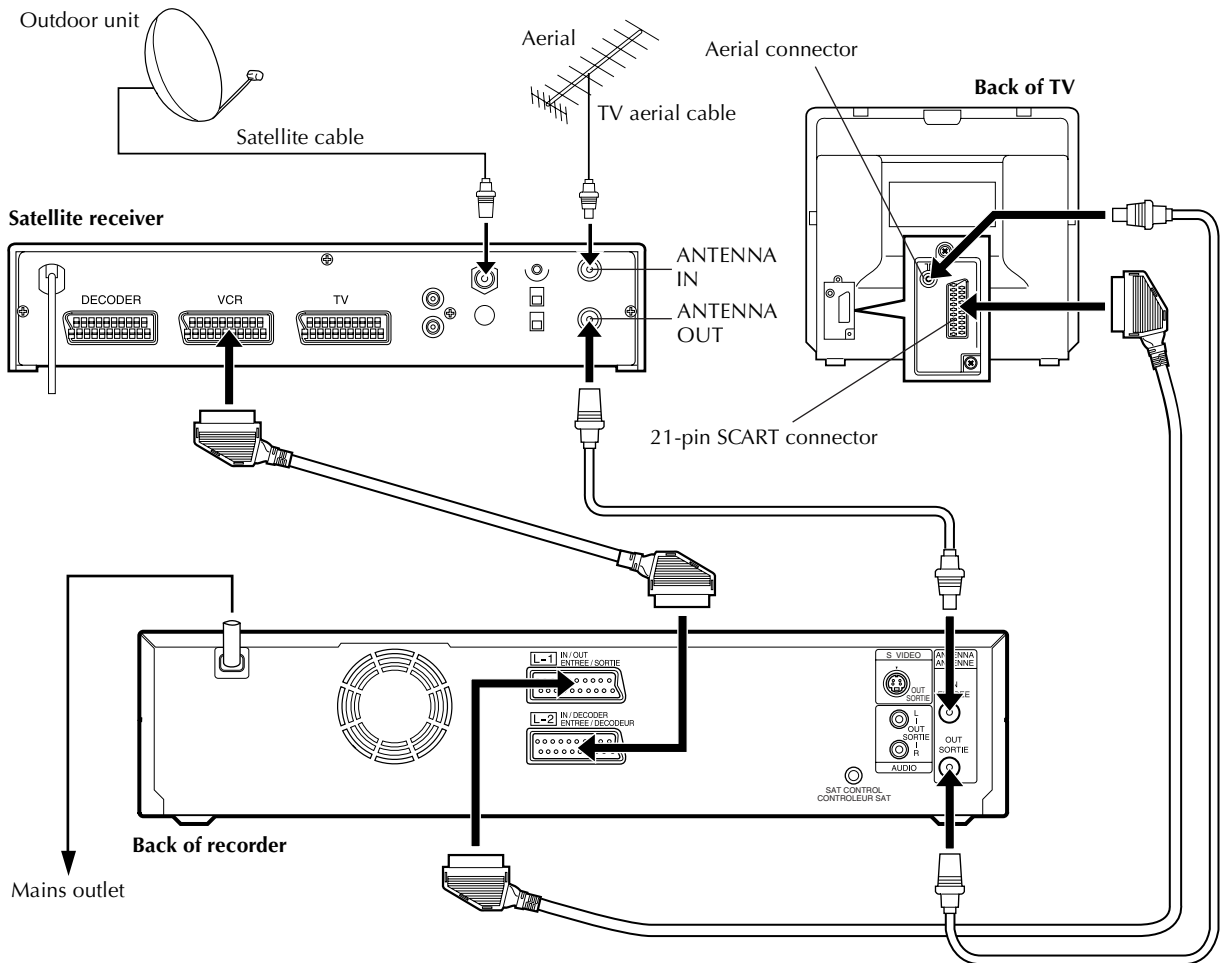

IMPORTANT

When you set "L-2 SELECT" to "SAT" (☞ pg. 69), it is possible to view a satellite broadcast with the TV set to its AV mode even if the recorder is turned off. When the recorder is in Stop mode or recording, press **TV/VCR** on the remote control to turn off the VCR indicator on the front display panel.

- If you turn on the recorder when the satellite receiver's power is off, nothing appears on the TV screen. In this case, turn on the satellite receiver, or set the TV to its TV mode, or press **TV/VCR** on the remote control to set the recorder to the video mode.

Connecting/Using A Stereo System

These instructions enable you to connect your video recorder to your Hi-Fi stereo system (if you have one) and listen to the soundtrack through the stereo.

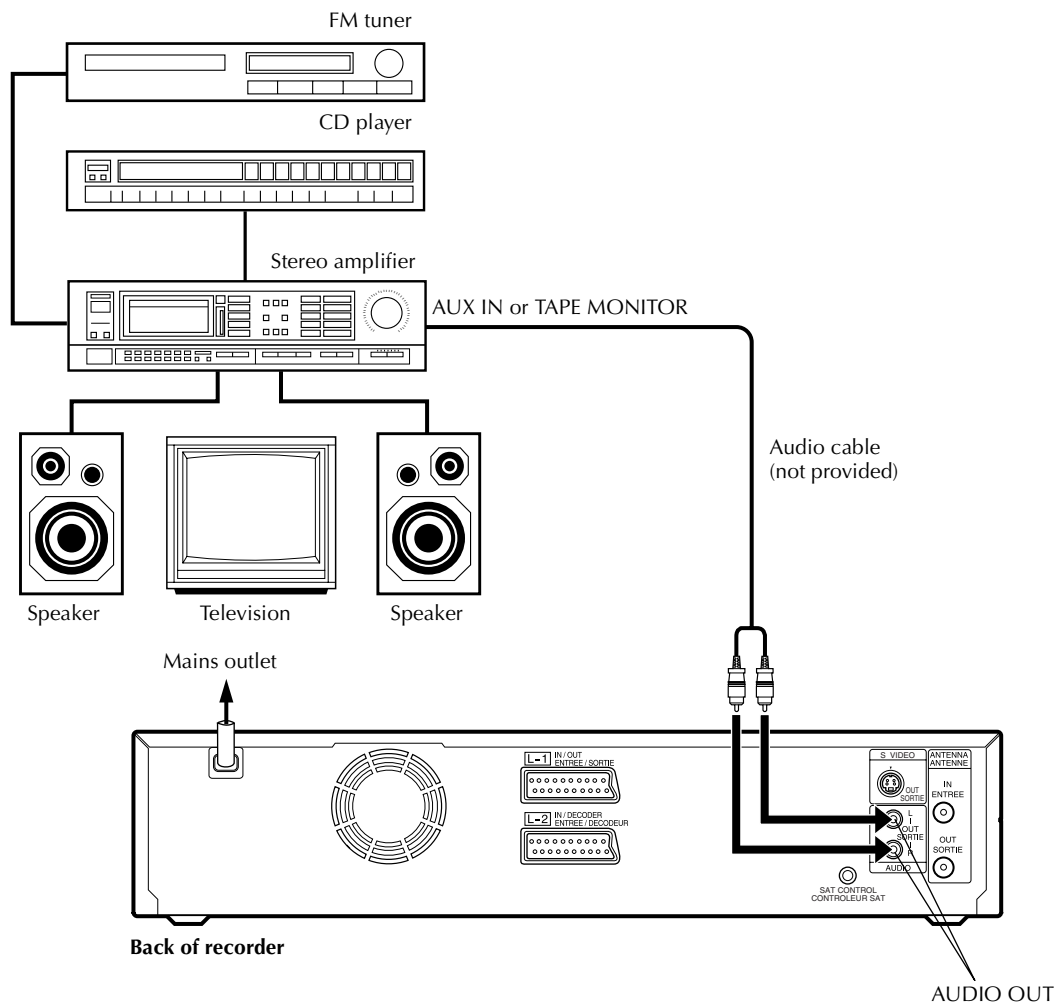

Make connections.

Connect the AUDIO OUT L and R connectors on your video recorder to the AUX IN or TAPE MONITOR connectors on your stereo system's receiver or amplifier.

NOTE:

When listening to sound through the connected stereo system, turn the TV's volume down completely.

CAUTIONS:

- This recorder has a dynamic range of more than 80 dB with regards to its Hi-Fi audio capability. It is recommended that you check the maximum level if you are going to listen to the Hi-Fi audio signals through a stereo amplifier. A sudden surge in the input level to the speakers may damage them.
- Some speakers and televisions are specially shielded to prevent television interference. If both are of the non-shielded type, do not place the speakers adjacent to the TV set as this can adversely affect the video playback picture.

Mode Set

- Turn on the TV and select the AV mode.
- Slide **TV/CABLE/SAT** switch to the right.

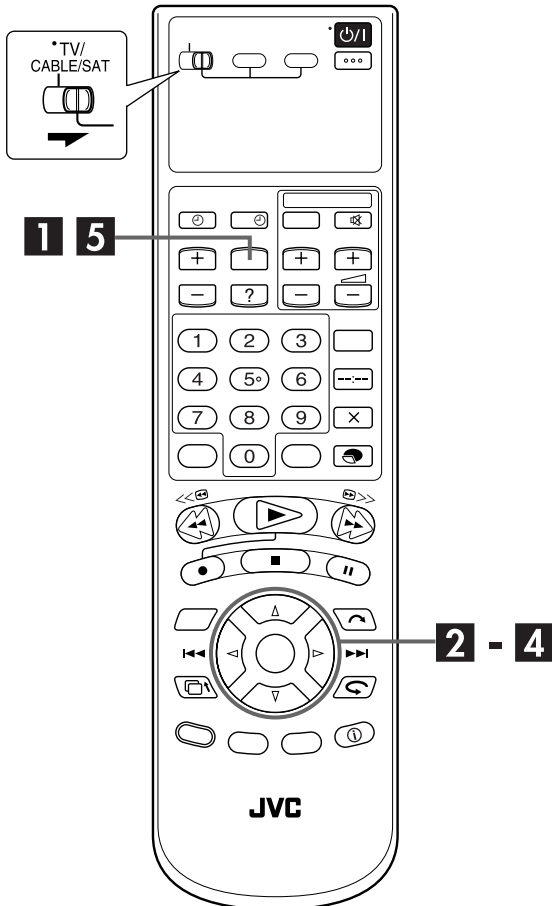

You can change various mode settings on the TV screen by following the procedure described below. The table below shows the structure of the menu system.

HDD/VCR SET UP	HDD SET UP 1 (☞ pg. 79) HDD SET UP 2 (☞ pg. 79) VCR SET UP 1 (☞ pg. 79) VCR SET UP 2 (☞ pg. 81)
FUNCTION SET UP	FUNCTION (☞ pg. 82) INPUT/OUTPUT (☞ pg. 68) FAMILY (☞ pg. 27)
INITIAL SET UP	TUNER SET (☞ pg. 86) INITIAL SET (☞ pg. 19, 83, 84)

- For each mode setting, see pages 79 to 82.
- The procedure shows how to set "LIVE MEMORY" to "3HR" on the "HDD SET UP 1" screen as an example.

1 Access the Main Menu screen.

Press **MENU**.

2 Access the HDD Set Up screen.

- 1 Press $\triangleleft \triangleright$ to move the arrow to "HDD/VCR SET UP", then press ∇ .
- 2 Press $\triangleleft \triangleright$ to move the arrow to "HDD SET UP 1", then press **OK**.

3 Select the mode.

Press $\triangle \nabla$ to move the arrow to "LIVE MEMORY", then press **OK**.

4 Select the mode setting.

Press $\triangle \nabla$ to select "3HR", then press **OK**.

5 Return to the normal screen.

Press **MENU**.

HDD SET UP 1

* The default setting is **bold** in the table below.

<p>■ LIVE MEMORY OFF 30MIN 1HR 3HR</p>	<p>When this function is set to "30MIN", "1HR" or "3HR", hard disk drive illumination lights blue and you can apply the selected time length to the "Live Memory Features" (ⓘ pg. 28).</p>
<p>■ AUDIO REC NICAM MONO</p>	<p>When this function is set to "NICAM", the NICAM audio programmes will be recorded. When this function is set to "MONO", the Standard (monaural) audio programmes will be recorded.</p> <p>NOTE: <i>This function works only on NICAM bilingual programme.</i></p>
<p>■ JUMP TIME 15 MIN 30 MIN 1 HR</p>	<p>You can locate a scene ahead or behind of the currently viewed one by jumping a selected time interval during playback (or Live Memory Playback) or recording (or Live Memory Recording).</p>

HDD SET UP 2

* The default setting is **bold** in the table below.

<p>■ DV AUDIO REC 12BIT 16BIT</p>	<p>Select the appropriate mode before recording to the HDD deck.</p> <p>12BIT: Enables Audio Dubbing later. 16BIT: Audio Dubbing later is impossible but recorded sound quality is higher than "12BIT".</p> <p>NOTES:</p> <ul style="list-style-type: none"> • When input mode is set to "D-1", you cannot change "DV AUDIO REC" setting.
<p>■ AUDIO MODE SOUND1 SOUND2 MIX</p>	<p>Select the appropriate mode when playing back an audio-dubbed programme on the HDD deck.</p> <p>SOUND1: Original recorded sound SOUND2: Audio-dubbed sound MIX: Original recorded sound and Audio-dubbed sound</p> <p>NOTES:</p> <ul style="list-style-type: none"> • When "AUDIO MODE" is set to "MIX", both the main and sub audio tracks will be audible on bilingual tapes. • To select only the main audio or only the sub audio track on bilingual tapes, set "AUDIO MODE" to "SOUND1".

VCR SET UP 1

* The default setting is **bold** in the table below.

<p>■ NAVIGATION ON OFF</p>	<p>When a programme is recorded on the cassette with this function set to "ON", you can use VCR Navigation (ⓘ pg. 36, 55).</p>
--	--

VCR SET UP 1 (cont.)

* The default setting is **bold** in the table below.

<p>■ S-VHS ET ON OFF</p>	<p>You can record in SP mode on VHS cassettes with S-VHS picture quality. Tapes recorded using this function can be played back on a recorder equipped with the S-VHS ET function. When this function is set to "ON", the S-VHS indicator lights up on the front display panel.</p> <p>NOTES:</p> <ul style="list-style-type: none"> ● You can activate the S-VHS ET function only before you start recording on a VHS cassette. ● Before recording, make sure that "B.E.S.T." is set to "ON". (☞ pg. 81) ● You cannot activate the S-VHS ET function... <ul style="list-style-type: none"> ... while recording is in progress. ...while timer-recording or Instant Timer Recording (☞ pg. 33, 46, 48) is in progress. ...while B.E.S.T. (☞ pg. 45) is in progress. ● The S-VHS ET function does not work... <ul style="list-style-type: none"> ...with S-VHS cassettes. ...with recordings in LP mode. ● To keep the highest quality recording and playback pictures over a long period of time, S-VHS recording on S-VHS cassettes is recommended. ● Use of high grade tapes is recommended for S-VHS ET recordings. On some tapes, picture quality will not improve even if the S-VHS ET function is used. Check the recording quality before you start important recordings. ● You can play back a tape recorded using the S-VHS ET function on most of S-VHS recorders and of VHS recorders equipped with SQPB (S-VHS QUASI PLAYBACK) function. (Notice some recorders are not compatible with the S-VHS ET function.) ● While playing back a tape recorded using the S-VHS ET function on some recorders, noise may appear. (If playback picture becomes blurred or interrupted, use a cleaning cassette.) ● In the variable speed search, still, slow-motion or frame-by-frame playback modes (☞ pg. 39), noise may appear. If these modes are performed frequently on a tape recorded using the S-VHS ET function, the tape may be damaged and the picture may be deteriorated.
<p>■ S-VHS AUTO OFF</p>	<p>Your recorder can record in S-VHS (Super VHS), S-VHS ET or VHS.</p> <p>● To record in S-VHS: Set "S-VHS" to "AUTO". Then, insert a cassette marked "S-VHS". The S-VHS indicator lights up on the front display panel. The S-VHS recording mode is selected.</p> <p>● To record in S-VHS ET on a VHS cassette: Set "S-VHS ET" to "ON". (See above)</p> <p>● To record in VHS: Insert a cassette marked "VHS". Set "S-VHS ET" to "OFF". (See above) The VHS recording mode is automatically selected regardless of the "S-VHS" mode setting.</p> <p>● To record in VHS on an S-VHS cassette: Insert a cassette marked "S-VHS". The S-VHS indicator lights up on the front display panel. Then, set "S-VHS" to "OFF". The S-VHS indicator goes off. The VHS recording mode is selected.</p> <p>NOTE: When playing back a tape that has been recorded in S-VHS or S-VHS ET, the S-VHS indicator lights up on the front display panel regardless of the "S-VHS" mode setting.</p>

<p>■ AUTO SP→LP TIMER ON OFF</p>	<p>When this function is set to “ON”, the recorder automatically switches to LP mode to allow complete recording if there is not enough tape to record the entire programme while timer-recording in SP mode.</p> <p>For Example . . . Recording a programme of 210 minutes in length onto a 180-minute tape</p> <table border="1" data-bbox="330 251 922 311"> <tr> <td style="text-align: center;">Approximately 150 minutes</td> <td style="text-align: center;">Approximately 60 minutes</td> </tr> <tr> <td style="text-align: center;">SP mode</td> <td style="text-align: center;">LP mode</td> </tr> </table> <p style="text-align: center;">Total 210 minutes</p> <p>Make sure you set this function to “ON”, before the timer-recording starts.</p> <p>NOTES:</p> <ul style="list-style-type: none"> ● If you have programmed the recorder to timer-record 2 or more programmes, the second programme and those thereafter may not fit on the tape if you set “AUTO SP→LP TIMER” to “ON”. In this case, make sure the mode is not engaged, then set the tape speed manually during timer programming. ● In order to ensure that the recording fits on the tape, this feature may leave a slight non-recorded section at the end of the tape. ● There may be some noise and sound disturbance at the point on the tape where the recorder switches from SP to LP mode. ● The Auto SP→LP Timer feature is not available during ITR (Instant Timer Recording), and the feature will not work properly with any tapes longer than E-180, or with some tapes of shorter lengths. ● If you perform timer recording with both PDC and the Auto SP→LP Timer activated, and the programme goes beyond its originally scheduled length, there may be times when the programme cannot be recorded in its entirety. 	Approximately 150 minutes	Approximately 60 minutes	SP mode	LP mode
Approximately 150 minutes	Approximately 60 minutes				
SP mode	LP mode				

VCR SET UP 2

* The default setting is **bold** in the table below.

<p>■ B.E.S.T. ON OFF</p>	<p>You can set the B.E.S.T. (Biconditional Equalised Signal Tracking) system to “ON” or “OFF” (ⓘ pg. 45).</p>
<p>■ PICTURE CONTROL AUTO EDIT SOFT SHARP</p>	<p>This feature helps you to adjust the playback picture quality according to your preference. Normally select “AUTO”.</p> <p>AUTO: Provides the optimised picture benefits of the B.E.S.T. Picture System. EDIT: Minimizes picture degradation during editing (recording and playback). SOFT: Reduces image coarseness when viewing overplayed tapes containing a lot of noise. SHARP: Clearer, sharper-edged picture when viewing images with lots of flat, same-coloured surfaces such as cartoons.</p> <p>NOTES:</p> <ul style="list-style-type: none"> ● When you select “EDIT”, “SOFT” or “SHARP”, the selected mode will not change until you select another mode. ● When you select “EDIT” to dub tapes, be sure to select “AUTO” after you finish dubbing the tapes. ● When “B.E.S.T.” is “OFF”, “PICTURE CONTROL” switches automatically from “AUTO” to “NORM”.
<p>■ VIDEO STABILIZER ON OFF</p>	<p>When this function is set to “ON”, you can automatically correct vertical vibration in the picture when playing back unstable recordings made on another recorder.</p> <p>NOTES:</p> <ul style="list-style-type: none"> ● When you finish viewing a tape, be sure to set this function to “OFF”. ● Regardless of the setting, this function has no effect during recording and during special effects playback. ● The on-screen display may jitter vertically when this function is set to “ON”. ● To watch recordings with close-caption, set this function to “OFF”.

FUNCTION

* The default setting is **bold** in the table below.

<p>■ O.S.D. ON OFF</p>	<p>When this function is set to "ON", various operational indicators appear on the TV screen.</p> <p>NOTES:</p> <ul style="list-style-type: none"> • When you use this recorder as the source player for editing, be sure to set "O.S.D." to "OFF" before starting. • During playback, the operation mode indicators may be disturbed depending on the type of tape being used.
<p>■ AUTO TIMER ON OFF</p>	<p>When this function is set to "ON", the timer is automatically engaged when the recorder power is turned off, and automatically disengaged when the recorder is powered back on.</p> <p>NOTE:</p> <p>For safety, when "AUTO TIMER" is set to "OFF", all other recorder functions are disabled while the Timer mode is engaged. To disengage the timer, press ⊖ (TIMER).</p>
<p>■ DIRECT REC ON OFF</p>	<p>When this function is set to "ON", you can easily start recording the programme that you are watching on your TV. Press and hold ● and press ► on the remote control, or press ● on the recorder.</p> <p>NOTES:</p> <ul style="list-style-type: none"> • When you use the Direct Rec function, be sure to use a TV offering T-V LINK, etc. and connect a fully-wired 21-pin SCART cable between the recorder and the TV (☞ pg. 12). • If "DIRECT REC" is set to "OFF", the ● button functions as described in "Basic Recording" (☞ pg. 22, 34). • During the Direct Rec, "--" appears on the front display panel. • If a programme is recorded with the Direct Rec, the station name will not be registered for the Navigation. "-----" will be displayed for the station name. • Even if there is no power supply for more than 10 minutes, the recorder keeps the setting. • If you use the remote control of your TV to record the programme with the Direct Rec, the programme will be recorded on the HDD deck, even if you select the VHS deck. In this case, first few seconds of the programme will not be recorded.
<p>■ POWER SAVE ON OFF</p>	<p>When this function is set to "ON", you can reduce the power consumption while the recorder is turned off.</p> <p>NOTES:</p> <ul style="list-style-type: none"> • During Power Save mode ... <ul style="list-style-type: none"> ... the front display panel will be turned off. ... the Just Clock function (☞ pg. 84) does not work. ... the picture may be distorted momentarily when you turn on/off the recorder. • Power Save does not work when ... <ul style="list-style-type: none"> ... the recorder is in the Timer mode. ... the recorder's power is turned off after timer-recording or Instant Timer Recording. ... the Automatic Satellite Programme Recording mode is engaged. (☞ pg. 51) ... "L-2 SELECT" is set to "DECODER" or "SAT". (☞ pg. 69) • When this function is set to "ON", any i.LINK device connected to the DV IN/OUT connector cannot be recognized. As a result, it is not possible to record a programme using the digital turner's timer function. • It takes some time for the recorder to complete initialize after you turn on recorder power.

VIDEO PLUS+® System Setup

IMPORTANT

Normally, Auto Set Up (pg. 14), Preset Download (pg. 16) or Auto Channel Set (pg. 86) sets the Guide Program numbers automatically. You need to set the Guide Program numbers manually only in the following cases.

- When timer-programming with the VIDEO PLUS+ system, the channel position, where the station you wish to record is received on your recorder, is not selected,
OR
when you add a channel after Auto Set Up, Preset Download or Auto Channel Set has taken place,
—Set the Guide Program number for that station manually.
- When you wish to timer-record a satellite programme with the VIDEO PLUS+ system,
—Set the Guide Program numbers for all satellite broadcasts received on your satellite receiver.

- Turn on the TV and select the AV mode.
- Slide TV/CABLE/SAT switch to the right.

Guide Program Number Set

1 Access the Main Menu screen.

Press **MENU**.

2 Access the Initial Set screen.

- 1 Press $\triangleleft \triangleright$ to move the arrow to "INITIAL SET UP", then press ∇ .
- 2 Press $\triangleleft \triangleright$ to move the arrow to "INITIAL SET", then press **OK**.

3 Access the Guide Program Set screen.

Press $\triangle \nabla$ to move the highlight bar (pointer) to "GUIDE PROG SET", then press **OK** or \triangleright .

4 Enter the Guide Program number.

Press $\triangle \nabla$ to enter the Guide Program number for the desired station as shown in the TV listings. Then press **OK** or \triangleright .



(Example) When inputting the Guide Program number 4 for CH4.

5 Enter the receiving channel position number.

Press the number key "0" to select "TV PROC" or "SAT". Then press $\triangle \nabla$ to input the number of the recorder's channel position on which the Guide Program number's broadcast is received by the recorder or the satellite receiver. Then press **OK** or \triangleright .

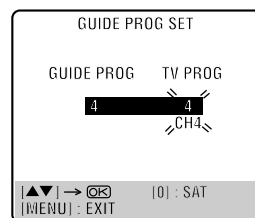

(Example) If CH4 is received on channel position 2.

- To timer-record a satellite programme with the VIDEO PLUS+ system, you need to install the provided Satellite Controller and perform the procedure described in "Satellite Receiver Control Setting" (pg. 18).
- Repeat steps 4 and 5 as necessary.

6 Return to the normal screen.

Press **MENU**.

Guide Program Number

"Guide Program (GUIDE PROG) number" refers to the assigned TV station numbers, according to broadcast area, for the VIDEO PLUS+ timer recording. The Guide Program numbers can be found in most TV listings.

Clock Set

- Turn on the TV and select the AV mode.
- Slide **TV/CABLE/SAT** switch to the right.

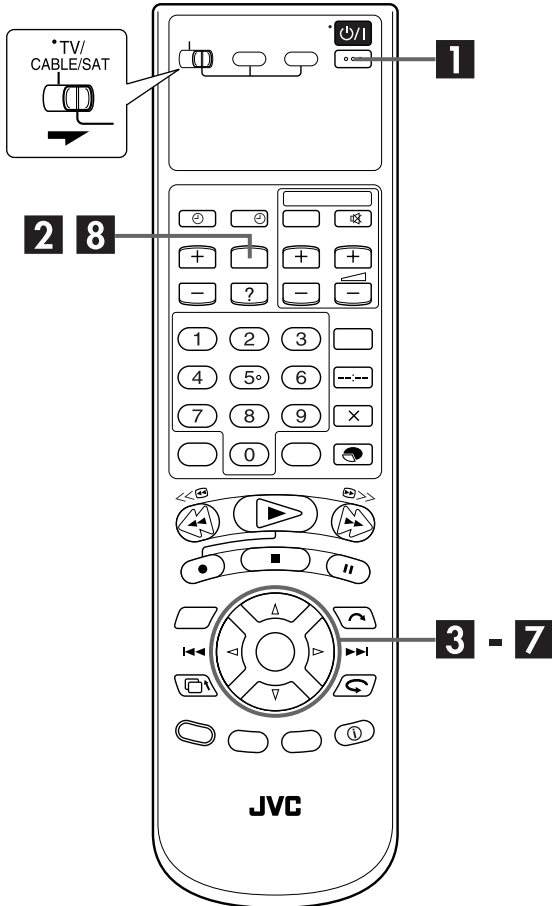

Just Clock

The Just Clock function provides accurate time keeping through automatic adjustments at regular intervals, by reading data from a PDC signal.

The Just Clock option can be set "ON" or "OFF" at the Clock Set screen (the default setting is "OFF"). Press **OK** until the Just Clock setting begins blinking, then press $\Delta\nabla$ to change the setting.

IMPORTANT: If you turn off Just Clock, the accuracy of your recorder's built-in clock may be reduced, which could adversely effect timer recording. We recommend you to keep Just Clock on. In cases where the clock setting data from a PDC signal is incorrect, however, you are advised to keep Just Clock set to "OFF".

IMPORTANT

If you performed Auto Set Up (pg. 14) or Preset Download (pg. 16), without ever having set the clock previously, the recorder's built-in clock is also set automatically.

Perform the following steps only if —

—Auto Clock Set has not been performed correctly by Auto Set Up, Preset Download or Auto Channel Set.

OR

—the recorder's memory backup has expired.

OR

—you want to change Just Clock setting (pg. "Just Clock" in the left column).

1 Turn on the recorder.

Press P/I .

2 Access the Main Menu screen.

Press **MENU**.

3 Access the Initial Set screen.

- 1 Press $\triangleleft \triangleright$ to move the arrow to "INITIAL SET UP", then press ∇ .
- 2 Press $\triangleleft \triangleright$ to move the arrow to "INITIAL SET", then press **OK**.

4 Access the Clock Set screen.

Press $\Delta\nabla$ to move the highlight bar (pointer) to "CLOCK SET", then press **OK** or \triangleright . The Clock Set screen appears.

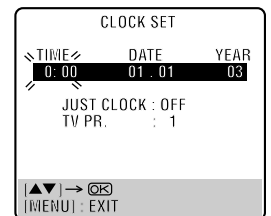
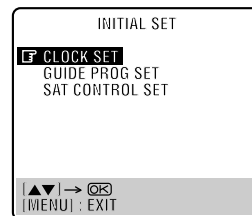

5 Set the date and time.

Press $\Delta\nabla$ to set the time, then press **OK** or \triangleright . The "DATE" display begins blinking. Repeat the same procedure to set the date and year.

- When you set the time, press and hold $\Delta\nabla$ to change the time by 30 minutes.
- When you set the date, press and hold $\Delta\nabla$ to change the date by 15 days.

6 Set Just Clock.

The default setting is "OFF". Set as desired by pressing $\Delta\nabla$, then press **OK** or \triangleright .

- For the Just clock function, refer to "Just Clock" on page 84.
- If you set to "OFF", you can disregard the next step as you won't be able to receive regular clock adjustments.

7 Set the source channel position for clock data.

The recorder is preset to receive clock setting and adjustment data from channel position 1. Press $\Delta\nabla$ to set the channel position to the number representing the station transmitting clock setting data, then press **OK** or \triangleright .

8 Start the clock operation.

Press **MENU**.

NOTES:

- *Just Clock* (when set to "ON") adjusts the recorder's built-in clock every hour, except for 23:00, 0:00, 1:00 and 2:00.
- *Just Clock* is not effective when ...
 - ... the recorder's power is on.
 - ... the recorder is in the Timer mode.
 - ... a difference of more than 3 minutes exists between the built-in clock's time and the actual time.
 - ... the recorder is in the Automatic Satellite Programme Recording mode (☞ pg. 51).
 - ... "L-2 SELECT" is set to "SAT" (☞ pg. 69).
- If *Just Clock* is set to "ON", the recorder's clock is automatically adjusted at the start/end of Summer Time.
- *Just Clock* may not function properly depending on the reception condition.

Tuner Set

Turn on the TV and select the AV mode.

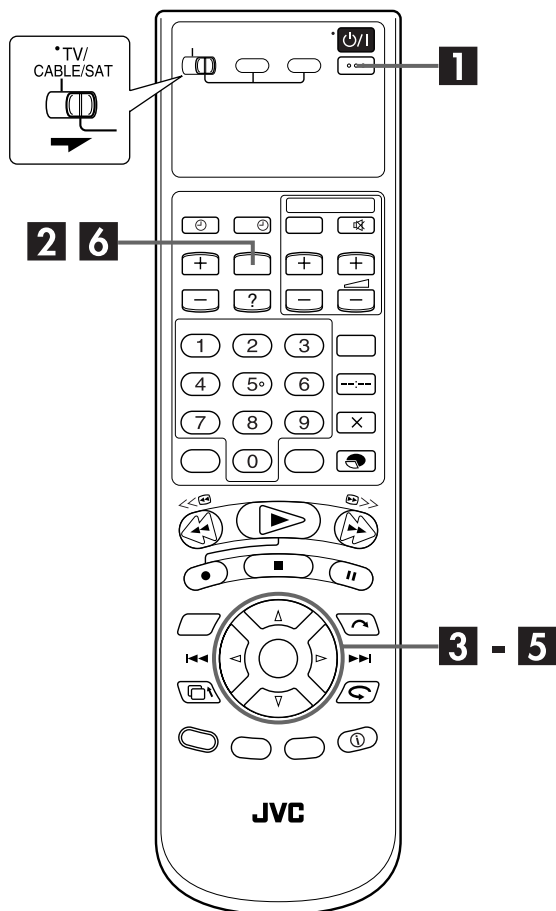

IMPORTANT

Perform the following steps only if —
 — Auto Channel Set has not been set correctly by Auto Set Up or by Preset Download (pg. 14, 16).
 — you have moved to a different area or if a new station starts broadcasting in your area.

Your recorder needs to memorize all necessary stations in channel positions in order to record TV programmes. Auto Channel Set automatically assigns all receivable stations in your area to call them up by using the **VCR PR** buttons without going through any vacant channels.

Auto Channel Set

1 Turn on the recorder.

Press **⏻/I**.

2 Access the Main Menu screen.

Press **MENU**.

3 Access the Tuner Set screen.

- 1 Press **◀▶** to move the arrow to "INITIAL SET UP", then press **▽**.
- 2 Press **◀▶** to move the arrow to "TUNER SET", then press **OK**.

4 Perform Auto Channel Set.

Press **△▽** to move the highlight bar (pointer) to "AUTO CH SET", then press **OK** or **▶ ▽** twice.

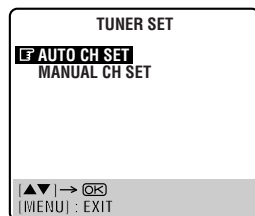

- When you have connected the video recorder to a TV offering T-V Link via a fully-wired 21-pin SCART cable (pg. 12), the recorder automatically performs the Preset Download and the T-V LINK screen will appear (pg. 16).

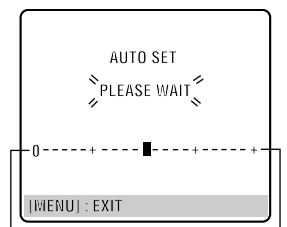





- The Auto Set screen appears, and remains on screen while the recorder searches for receivable stations. As Auto Channel Set progresses, the "█" mark on the TV screen moves from left to right. Wait until the TV screen as shown in step **5** appears.

5 View the Confirmation screen.

After "SCAN COMPLETED" is displayed on the TV screen for about 5 seconds, the





Confirmation screen looking like the one to the right

appears. The stations your recorder located appear on a Confirmation screen — channel positions (PR),

channels (CH) and station names (ID —  pg. 91). The blueback screen and the programme currently being broadcast by the blinking station appear alternately for 8 seconds each. To view the next page, use the     button on the remote control.

- The Guide Program numbers will also be set automatically during Auto Channel Set.

PR	CH	ID	PR	CH	ID
01	26	BBC1	08	----	----
02	33	BBC2	09	----	----
03	23	ITV	10	----	----
04	30	CH4	11	----	----
05	37	CH5	12	----	----
06	----	----	13	----	----
07	----	----	14	----	----



  |
 : EDIT
 : DELETE
 [MENU] : EXIT

6 Return to the normal screen.

Press **MENU**.

- Using the Confirmation screen, you can skip or add channel positions, enter station names and perform other operations. Refer to pages 88 – 90 for the procedures.
- Depending on reception conditions, the stations may not be stored in order, and the station names may not be stored correctly.

IMPORTANT

- In certain reception conditions, station names may not be stored correctly, and Auto Guide Program Number Set may not work properly. If the Guide Program numbers are not set properly when you timer-record a TV programme using the VIDEO PLUS+ system, the recorder will record a TV programme of a different station. When programming the timer using the VIDEO PLUS+ system, be sure to check the desired channel is selected correctly ( pg. 46, "VIDEO PLUS+ Timer Programming").
- Your video recorder memorizes all detected stations even if reception of some of them is poor. You can delete those stations with an unacceptable picture ( pg. 89, "Delete A Channel").

NOTES:

- Fine tuning is performed automatically during Auto Channel Set. If you want to perform tuning manually, refer to page 90.
- If you perform Auto Channel Set when the aerial cable is not connected properly, "SCAN COMPLETED –NO SIGNAL–" appears on the TV screen in step **5**. When this happens, make sure of the aerial connection and press **OK**; Auto Channel Set will take place again.

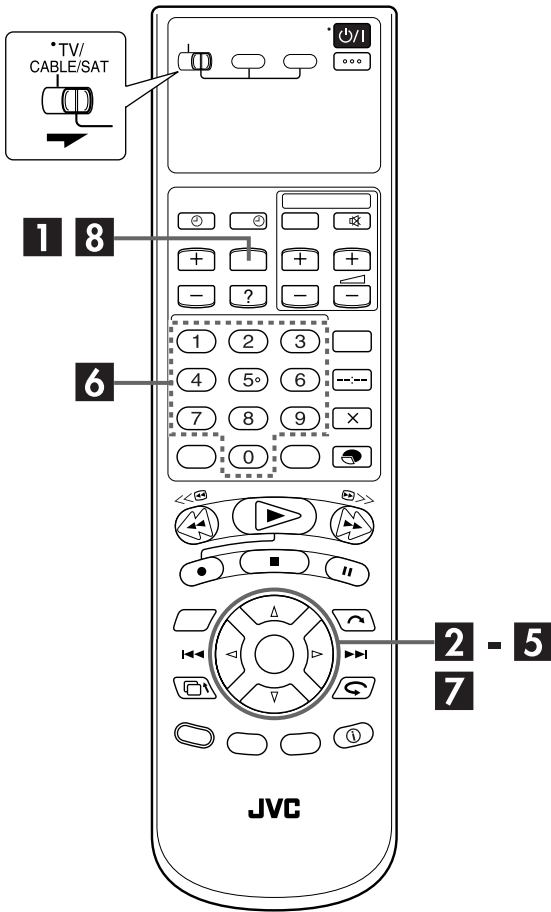

Manual Channel Set

Store channels that were not stored during Auto Set Up (pg. 14), Preset Download (pg. 16) or Auto Channel Set (pg. 86).

1 Access the Main Menu screen.

Press **MENU**.

2 Access the Tuner Set screen.

- 1 Press $\triangleleft \triangleright$ to move the arrow to "INITIAL SET UP", then press ∇ .
- 2 Press $\triangleleft \triangleright$ to move the arrow to "TUNER SET", then press **OK**.

3 Access the Confirmation screen.

Press $\triangle \nabla$ to move the highlight bar (pointer) to "MANUAL CH SET", then press **OK** or \triangleright . The Confirmation screen appears.

4 Select the channel position.

Press $\triangleleft \triangle \triangleright \nabla$ until an open position in which you want to store a channel begins blinking, then press **OK**. The Manual Channel Set screen appears.

- The blueback screen and the programme currently being broadcast by the selected channel appear alternately for 8 seconds each.

PR	CH	ID	PR	CH	ID
01	26	BBC1	08	----	----
02	33	BBC2	09	----	----
03	23	ITV	10	----	----
04	30	CH4	11	----	----
05	37	CH5	12	----	----
06	----	----	13	----	----
07	----	----	14	----	----

$\blacktriangle \blacktriangledown \blacktriangleleft \blacktriangleright$: EDIT
 $\rightarrow \times$: DELETE
 [MENU] : EXIT

(Example) To store in position 06.

5 Select the band.

Press $\triangle \nabla$ to change the band between CH (regular) and CC (cable), then press \triangleright .

PR	CH	ID	FINE	DECODER
06	CH21	----	+/-	OFF

$\blacktriangle \blacktriangledown$: SELECT
 $\blacktriangleleft \blacktriangleright$: CURSOR \leftrightarrow
 [OK] : OK
 [MENU] : EXIT

6 Input the channel.

Press the **number keys** to input the channel number you want to store.

- Input "0" before any single number entries.
- To input the registered station name (ID – [pg. 91](#)), press \triangleright until "----" (ID setting) begins blinking, then press $\triangle\nabla$.
- For fine tuning adjustment, press \triangleright until "+/–" begins blinking, then press $\triangle\nabla$. While tuning, "+" or "–" appears.
- When "L-2 SELECT" is set to "A/V" or "SAT", the "DECODER" setting cannot be changed ([pg. 69](#)).

7 Enter new channel information.

Press **OK** and the Confirmation screen appears.

- Repeat steps **4** – **7** as necessary.

8 Close the Confirmation screen.

Press **MENU**.

- To change positions, see "Change Station Channel Position" ([pg. 89](#)).
- If you wish to set station names other than the ones registered in your recorder, see "Set Stations (B)" ([pg. 90](#)).

ATTENTION

Guide Program numbers are not set when channels are stored manually. If an attempt is made at timer programming with the VIDEO PLUS+ system in this state, "GUIDE PROGRAM IS NOT SET SET GUIDE PROG THEN RETRY" appears on the TV screen; set the Guide Program Numbers ([pg. 83](#)) manually.

Delete A Channel

Perform steps **1** and **2** of "Manual Channel Set" on page 88 to access the Confirmation screen before continuing.

1 Select the item.

Press \triangle \triangleright ∇ until the item you want to delete begins blinking.

2 Delete a channel.

Press **X**.

- The item directly beneath the cancelled one moves up one line.
- Repeat steps **1** and **2** as necessary.

3 Close the Confirmation screen.

Press **MENU**.

Change Station Channel Position

Perform steps **1** and **2** of "Manual Channel Set" on page 88 to access the Confirmation screen before continuing.

1 Select the item.

Press \triangle \triangleright ∇ until the item you want to move begins blinking. Then press **OK** and the station name (ID) and its channel (CH) number begin blinking.

2 Select the new position.

Press \triangle \triangleright ∇ to move the station to the new channel position, then press **OK**.

Example: If you moved the station in position 4 to position 2, the stations originally in positions 2 and 3 each move down one space.

PR	CH	ID	PR	CH	ID
01	26	BBC1	08	----	----
02	23	ITV	09	----	----
03	30	CH4	10	----	----
04	33	BBC2	11	----	----
05	37	CH5	12	----	----
06	----	----	13	----	----
07	----	----	14	----	----

$\left[\blacktriangle \blacktriangleright \blacktriangledown \blacktriangleleft \right]$: MOVE
 $\left[\text{OK} \right]$: MANUAL CH SET
 [MENU] : EXIT

➔

PR	CH	ID	PR	CH	ID
01	26	BBC1	08	----	----
02	33	BBC2	09	----	----
03	23	ITV	10	----	----
04	30	CH4	11	----	----
05	37	CH5	12	----	----
06	----	----	13	----	----
07	----	----	14	----	----

$\left[\blacktriangle \blacktriangleright \blacktriangledown \blacktriangleleft \right]$: MOVE → $\left[\text{OK} \right]$
 [MENU] : EXIT

- Repeat steps **1** and **2** as necessary.

3 Close the Confirmation screen.

Press **MENU**.

Set Stations (A)

Set station names that are registered in your recorder.

Perform steps **1** and **2** of "Manual Channel Set" on page 88 to access the Confirmation screen before continuing.

1 Select the item.

Press \triangle ∇ until the item you want begins blinking.

2 Access the Manual Channel Set screen.

Press **OK** twice.

3 Select the new station.

Press \triangleright until the station name (ID) begins blinking, then press \triangle ∇ until the new station's name (ID) you want to store begins blinking. Registered station names (see pg. 91) appear as you press \triangle ∇ .

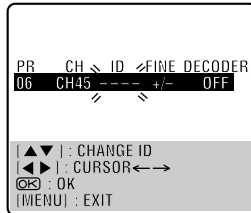

4 Switch the stations.

Press **OK**.

- The Confirmation screen appears.
- Repeat steps **1** – **4** as necessary.

5 Close the Confirmation screen.

Press **MENU**.

Set Stations (B)

Set station names other than the ones registered in your recorder.

Perform steps **1** and **2** of "Manual Channel Set" on page 88 to access the Confirmation screen and then perform steps **1** and **2** of "Set Stations (A)" in the left column before continuing.

1 Select the character for station name.

Press \triangleright until the first letter of the station name begins blinking.

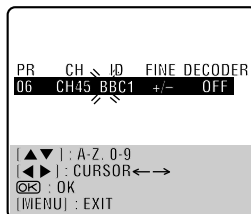

2 Enter the new character.

Press \triangle ∇ to cycle through the characters (A–Z, 0–9, –, *, +, _ (space)) and stop when the desired character is indicated, then press \triangleright to enter. Enter the remaining

characters the same way (maximum of 4). After entering all characters, press **OK**.

- The Confirmation screen appears.
- If you make a mistake, press \triangleleft until the incorrect character begins blinking. Then enter the correct character by pressing \triangle ∇ .

3 Close the Confirmation screen.

Press **MENU**.

NOTE:

The characters available for the station name (ID) are A–Z, 0–9, –, *, +, _ (space) (maximum of 4).

Fine-Tuning Channels Already Stored

Perform steps **1** and **2** of "Manual Channel Set" on page 88 to access the Confirmation screen before continuing.

1 Select the channel to fine-tune.

Press \triangleleft \triangle \triangleright ∇ until the channel you want to tune begins blinking.

2 Access the Manual Channel Set screen.

Press **OK** twice. The Manual Channel Set screen appears.

3 Perform tuning.

Press \triangleright until "+/–" begins blinking, then press \triangle ∇ until the picture is its clearest. Then press **OK**.

- The Confirmation screen appears.
- Repeat steps **1** – **3** as necessary.

4 Close the Confirmation screen.

Press **MENU**.

TV Station And ID List

STATION NAME	ID*
Anglia TV	ANGL
ARD	ARD
ARTE	ARTE
BBC Group	BBC
BBC1	BBC1
BBC2	BBC2
Berlin 1	BLN1
Berlin 2	BLN2
Border TV	BORD
Bayern1	BR1
Bayern3	BR3
BRT1	BRT1
BRT2	BRT2
Children Ch	CHLD
Canal +	CH+
CNN	CNN
Channel TV	CHNL
Central TV	CNTR
Channel 4	CH 4
Channel 5	CH 5
DRS	DRS
DR TV	DRTV
DSF	DSF
Euronews	EURN
Euronews	EURO
Eurosports	EURS
France1	FR1
France2	FR2
France3	FR3
Granada TV	GRNA
Grampian TV	GRMP
Hessen1	HR1
Hessen3	HR3
HRT	HRT
HTV	HTV
ITV Network	ITV
Kabelkanal	KABL
London	LNDN
MDR	MDR
MTV	MTV
Nord3	N3
NDR1	NDR1
NDR3	NDR3
NED1	NED1
NED2	NED2
NED3	NED3
Network 2	NET2
NRK	NRK
N-TV	N-TV
Offener Kanal	OKAN
ORF1	ORF1
ORF2	ORF2
ORF3	ORF3
OWL 3	OWL3
Premiere	PRMI
PR07	PR07
RAI1	RAI1
RAI2	RAI2
RAI3	RAI3
RB1	RB1
RB3	RB3
Rikisutvarpid-S	RKPS
RTBF 1	RTB1
RTBF 2	RTB2
RTE 1	RTE1
RTL	RTL
RTL 2	RTL2
RTP	RTP

STATION NAME	ID*
SAT	SAT
SAT 1	SAT1
Scottish TV	SCOT
SC4	SC4
SDR	SDR
SDR1	SDR1
SFB1	SFB1
SFB3	SFB3
SKY	SKY
Sky One	SKY1
Sky Net	SKYN
Sport	SPRT
SR 1	SR1
Super RTL	SRTL
STV Test	STVT
STV 1	STV1
STV 2	STV2
Suedwest3	SWR
SWF 1	SWF1
Schweiz4	SWZ4
TYNE TEES	TEES
Text	TEXT
TF1	TF1
TNT int	TNT
TRT int	TRT
TSI	TSI
TSR	TSR
TSW	TSW
TVE	TVE
TV Polonia	TVPA
TVP 1	TVP1
TVP 2	TVP2
TVS	TVS
TV2	TV2
TV5	TV5
Tele Zurich	TZUR
Ulster TV	ULST
Veronica	VERN
VIVA	VIVA
VIVA2	VIV2
VOX	VOX
VTM	VTM
VT4	VT4
West1	WDR1
West3	WDR3
YLE 1	YLE1
YLE 2	YLE2
Yorkshire TV	YORK
ZDF	ZDF
Zurich 1	ZUR1
3SAT	3SAT

* The "ID" abbreviation is what is shown on-screen in lieu of the station name. The "ID" abbreviation is listed in the Confirmation screen and is displayed on the TV screen when the recorder is tuned to a different station.

TV Station Channel Number Guide

Only the main stations are listed. There are in addition many relay stations, and full lists are available from the BBC and ITV.

	BBC1	BBC2	ITV	CH4	CH5		BBC1	BBC2	ITV	CH4	CH5
London & South-East						North-West					
Bluebell Hill.....	40	46	43	65	—	Caldbeck.....	30	34	28	32	56
Crystal Palace.....	26	33	23	30	37	Winter Hill.....	55	62	59	65	48
Dover.....	50	56	66	53	—	North-East					
Heathfield.....	49	52	64	67	—	Bilsdale West Moor.....	33	26	29	23	35
Oxford.....	57	63	60	53	49	Chatton.....	39	45	49	42	—
South-West						Pontop Pike.....	58	64	61	54	68
Beacon Hill.....	57	63	60	53	—	Scotland					
Caradon Hill.....	22	28	25	32	—	Angus.....	57	63	60	53	—
Huntshaw Cross.....	55	62	59	65	67	Black Hill.....	40	46	43	50	37
Redruth.....	51	44	41	47	37	Sandale.....	22	—	—	—	—
Stockland Hill.....	33	26	23	29	—	Caldbeck.....	—	34	28	32	56
Channel Islands						Creigkelly.....	31	27	24	21	48
Fremont Point.....	51	44	41	47	—	Darvel.....	33	26	23	29	35
South						Durris.....	22	28	25	32	67
Hannington.....	39	45	42	66	35	Eitshal.....	33	26	23	29	—
Midhurst.....	61	55	58	68	—	Keelylang Hill.....	40	46	43	50	—
Rowridge.....	31	24	27	21	—	Knock More.....	33	26	23	29	—
West						Rosemarkie.....	39	45	49	42	67
Mendip.....	58	64	61	54	37	Rumster Forest.....	31	27	24	21	—
East						Selkirk.....	55	62	59	65	52
Sandy Heath.....	31	27	24	21	39	Wales					
Sudbury.....	51	44	41	47	35	Blaenplwyf.....	31	27	24	21	56
Tacolneston.....	62	55	59	65	52	Carmel.....	57	63	60	53	—
Midlands						Llanddona.....	57	63	60	53	—
Ridge Hill.....	22	28	25	32	35	Moel-y-Parc.....	52	45	49	42	—
Sutton Coldfield.....	46	40	43	50	37	Presely.....	46	40	43	50	37
The Wrekin.....	26	33	23	29	35	Wenvoe.....	44	51	41	47	—
Waltham.....	58	64	61	54	35	Northern Ireland					
North						Brougher Mountain.....	22	28	25	32	—
Belmont.....	22	28	25	32	56	Divis.....	31	27	24	21	37
Emley Moor.....	44	51	47	41	37	Limavady.....	55	62	59	65	—

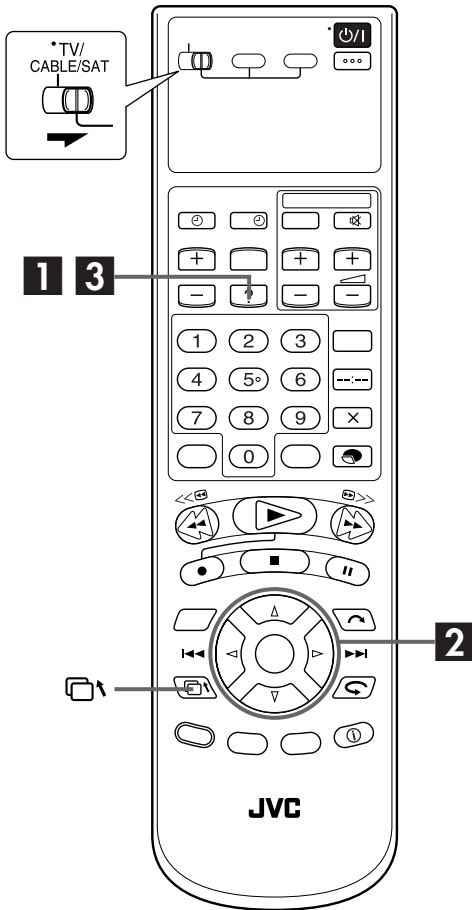

Help Function

Use this function if you encounter problems while operating this recorder.



1 Access the Help screen.

Press **?**.

- An INDEX screen that contains the most common needed topics (headings) relating to the current status appears. Topics with the  icon refer to HDD deck operations and with the  icon refer to those for the VHS deck.

2 Browse the INDEX and read the help page.

Press Δ ∇ to search for the item that describes the solution to your problem, then press **OK**.

- The selected help page appears.
- You can also browse help pages by pressing Δ ∇ .
- To return to a previous page, press .

3 Return to the normal screen.

Press **?**.

NOTE:

You cannot perform playback, recording, timer recording, or other normal operations while accessing the help screen.

Before requesting service for a problem, use this chart and see if you can repair the trouble yourself. Small problems are often easily corrected, and this can save you the trouble of sending your video recorder off for repair.

POWER

SYMPTOM	POSSIBLE CAUSE	CORRECTIVE ACTION
1. No power is supplied to the recorder.	● The mains power cord is disconnected.	Connect the mains power cord.
2. The clock is functioning properly, but the recorder cannot be powered.	● "⊖" is displayed on the front display panel with "AUTO TIMER" set to "OFF".	Press the ⊖ button to turn the "⊖" indicator off.
3. The remote control won't function.	● The batteries are discharged.	Replace the dead batteries with new ones.

TAPE TRANSPORT

SYMPTOM	POSSIBLE CAUSE	CORRECTIVE ACTION
1. During recording, the tape does not run. "○" lights up and the channel display blinks on the front display panel.	● The recorder is in the Record Pause mode.	Press ► to resume recording.
2. The tape will not rewind or fast-forward.	● The tape is already fully rewound or fast-forwarded.	Check the cassette.

PLAYBACK

SYMPTOM	POSSIBLE CAUSE	CORRECTIVE ACTION
1. The playback picture does not appear while the tape is running.	● The TV receiver is not set to the AV mode.	Set the TV to its AV mode.
2. Noise appears during visual search.	● This is normal.	
3. Noise appears during normal playback.	● The automatic tracking mode is engaged.	Try manual tracking. (☞ pg. 41)
4. The playback picture is blurred or interrupted while TV broadcasts are clear or "USE CLEANING CASSETTE" message appears on the screen.	● The video heads may be dirty.	Use a dry cleaning cassette ECL-3F or consult your JVC dealer.
5. Breaks are noticeable in Hi-Fi soundtrack.	● The automatic tracking mode is engaged.	Try manual tracking. (☞ pg. 41)

RECORDING

SYMPTOM	POSSIBLE CAUSE	CORRECTIVE ACTION
1. Recording cannot be started.	● There is no cassette loaded, or the cassette loaded has had its record safety tab removed.	Insert a cassette, or using adhesive tape, cover the hole where the tab was removed.
2. TV broadcasts cannot be recorded.	● "L-1", "L-2", "F-1", "D-1", "DUB" or "SAT" has been selected as the input mode.	Set to the desired channel.

SYMPTOM	POSSIBLE CAUSE	CORRECTIVE ACTION
3. Tape-to-tape editing is not possible.	<ul style="list-style-type: none"> ● The source (another video recorder, camcorder) has not been properly connected. ● All necessary power switches have not been turned on. ● The input mode is not correct. 	<p>Confirm that the source is properly connected.</p> <p>Confirm that all units' power switches are turned on.</p> <p>Set the input mode to "L-1", "L-2" or "F-1".</p>
4. Camcorder recording is not possible.	<ul style="list-style-type: none"> ● The camcorder has not been properly connected. ● The input mode is not correct. 	<p>Confirm that the camcorder is properly connected.</p> <p>Set the input mode to "L-1", "L-2" or "F-1".</p>
5. "○" and "▷" on the front display panel won't stop blinking.	<ul style="list-style-type: none"> ● The end of the tape was reached during recording. 	<ul style="list-style-type: none"> ● The programme may not have been recorded in its entirety. Next time make sure you have enough time on the tape to record the entire programme.

TIMER RECORDING

SYMPTOM	POSSIBLE CAUSE	CORRECTIVE ACTION
1. Timer recording won't work.	<ul style="list-style-type: none"> ● The clock and/or the timer have been set incorrectly. ● The timer is not engaged. 	<p>Re-perform the clock and/or timer settings.</p> <p>Press ⊖ and confirm that "⊖" is displayed on the front display panel.</p>
2. Timer programming is not possible.	<ul style="list-style-type: none"> ● Timer recording is in progress. 	<p>Timer programming can't be performed while a timer recording is in progress. Wait until it finishes.</p>
3. "⊖" on the front display panel or S-VHS indicator won't stop blinking.	<ul style="list-style-type: none"> ● The timer is engaged but there's no cassette loaded. ● The cassette is ejected, then the recorder is powered off automatically after the end of the tape is reached during timer recording. 	<p>Load a cassette with the record safety tab intact.</p>
4. "⊖", "○" and "▷" on the front display panel won't stop blinking.	<ul style="list-style-type: none"> ● The loaded cassette has had its record safety tab removed. ● The end of the tape was reached during timer recording. 	<p>Remove the cassette and cover the hole with adhesive tape, or insert a cassette with the record safety tab intact.</p> <p>The programme may not have been recorded in its entirety. Next time make sure you have enough time on the tape to record the entire programme.</p>

TIMER RECORDING (cont.)

SYMPTOM	POSSIBLE CAUSE	CORRECTIVE ACTION
5. "⊖" blinks for 10 seconds and the Timer mode is disengaged.	<ul style="list-style-type: none"> • ⊖ has been pressed when there are no programs in memory. 	Check the programmed data and re-program as necessary, then press ⊖ again.
6. The VIDEO PLUS+ system does not timer-record properly.	<ul style="list-style-type: none"> • The recorder's channel positions have been set incorrectly. 	Refer to "Guide Program Number Set" (☞ pg. 83) and re-perform the procedure.
7. "○" and "▷" on the front display panel won't stop blinking.	<ul style="list-style-type: none"> • The end of the tape was reached during Instant Timer Recording. 	The programme may not have been recorded in its entirety. Next time make sure you have enough time on the tape to record the entire programme.
8. "⊗", "○" and "▷" on the front display panel won't stop blinking.	<ul style="list-style-type: none"> • The loaded cassette has had its record safety tab removed. • The end of the tape was reached during Automatic Satellite Programme Recording. 	Remove the cassette and cover the hole with adhesive tape, or insert a cassette with the record safety tab intact. The programme may not have been recorded in its entirety. Next time make sure you have enough time on the tape to record the entire programme.

OTHER PROBLEMS

SYMPTOM	POSSIBLE CAUSE	CORRECTIVE ACTION
1. Whistling or howling is heard from the TV during camcorder recording.	<ul style="list-style-type: none"> • The camcorder's microphone is too close to the TV. • The TV's volume is too high. 	Position the camcorder so its microphone is away from the TV. Turn the TV's volume down.
2. When scanning channels, some of them are skipped over.	<ul style="list-style-type: none"> • Those channels have been designated to be skipped. 	If you need the skipped channels, restore them (☞ pg. 88).
3. The channel cannot be changed.	<ul style="list-style-type: none"> • Recording is in progress. 	Press II to pause the recording, change channels, then press ▶ to resume recording.
4. Channel settings that were made manually seem to have changed or disappeared.	<ul style="list-style-type: none"> • After the manual settings were made, Auto Channel Set was performed. 	Perform manual setting again.
5. No channels are stored in the recorder's memory.	<ul style="list-style-type: none"> • The TV aerial cable was not connected to the recorder when Auto Set Up was performed. • The fully-wired 21-pin SCART cable was not connected between TV and the recorder when Preset Download was performed. 	Turn off the recorder once and connect the TV aerial cable to the recorder properly, then turn on the recorder again. Then perform Auto Set Up again. (☞ pg. 14) Turn off the recorder once and connect the fully-wired 21-pin SCART cable to the recorder properly, then turn on the recorder again. Then perform Preset Download again. (☞ pg. 16)
6. The remote control won't operate the TV or satellite receiver.	<ul style="list-style-type: none"> • The remote control brand setting is incorrect. 	Re-set the remote control to the correct brand. (☞ pg. 53, 54)
7. A programme that has a title "Found 001" is recorded unexpectedly on the HDD deck.	<ul style="list-style-type: none"> • The power was cut off because of a power failure, etc. while the recorder was working. 	Delete the "Found 001" programme. (☞ pg. 58)

ON-SCREEN MESSAGES

MESSAGE	DESCRIPTION
CAN NOT MODIFY LIVE MEMORY TIME, MORE CAPACITY NEEDED DELETE UNWANTED PROGRAMME THEN RETRY	There is not enough memory on the hard disk drive for Live Memory Playback. To increase the free space, dub some programmes to cassettes or delete the unwanted programmes. (☞ pg. 63, 58)
DO YOU WANT TO DELETE SELECTED PROGRAMME?	Appears when you tried to delete the selected programme from the hard disk drive. Make sure you really want to delete the programme. (☞ pg. 58)
DO YOU WANT TO DELETE SELECTED PROGRAMME INFORMATION?	Appears when you tried to delete the selected programme information from the hard disk drive. Make sure you really want to delete the programme information. (☞ pg. 58)
DO YOU WANT TO DELETE SELECTED CASSETTE INFORMATION?	Appears when you tried to delete the selected cassette's all information from the hard disk drive. Make sure you really want to delete the cassette's information. (☞ pg. 58)
INSERT CASSETTE	Appears when you tried to modify the information for VCR Navigation, but the cassette is not loaded. To modify the information for VCR Navigation, the cassette must be loaded. (☞ pg. 56)
CAN NOT MODIFY INDEX	It is not possible to modify the index of a programme while the hard disk drive is in recording. Wait until the recording finishes or stop recording to modify the index. (☞ pg. 56)
NO CASSETTE	For VCR Navigation, load a cassette before pressing NAVIGATION . (☞ pg. 37)
"NAVIGATION" IS SET TO "OFF"	For VCR Navigation, set "NAVIGATION" to "ON" on the "VCR SET UP 1" screen, then press NAVIGATION . (☞ pg. 37, 79)
UNABLE TO SET TIMER PROGRAMME DUE TO SHORTAGE OF CAPACITY DELETE UNWANTED PROGRAMME FROM HDD	There is not enough memory on the hard disk drive for recording. To increase the free space, dub some programmes to cassettes or delete the unwanted programmes. (☞ pg. 58)
PROGRAMME FULL DELETE UNWANTED TIMER PROGRAMME	You can programme this recorder to timer-record as many as 16 programmes. To programme more, you need to cancel a timer programme already set. (☞ pg. 50)
PLEASE ADJUST CLOCK BEFORE TIMER PROGRAMMING	To set the timer programme, the clock must be set in advance. (☞ pg. 84)
GUIDE PROGRAM IS NOT SET SET GUIDE PROGRAM THEN RETRY	To set the timer programme using the VIDEO PLUS+ system, the Guide Program number must be set in advance. (☞ pg. 83)
PLUSCODE NO. ERROR CONFIRM PLUSCODE NO. THEN RETRY	An invalid PLUSCODE number is input. (☞ pg. 46)

ON-SCREEN MESSAGES (cont.)

MESSAGE	DESCRIPTION
PROGRAMME NOT COMPLETED PROGRAMME OVERLAPPED PLEASE CONFIRM AND MODIFY	The timer programme you set is overlapping with another timer programme. (☞ pg. 50)
TIMER PROGRAMMING STOPPED	Appears when you stop setting timer programme.
PROGRAMME COMPLETED PRESS "OK" THEN [⓪] TO ENTER TIMER STANDBY MODE	Timer programming is completed properly.
TIMER RECORDING WILL START WITHIN 5 MIN INSERT CASSETTE AND PRESS [⓪]	The recorder is not in the timer-standby mode. The timer recording will start in about 5 minutes.
REMAINING CAPACITY IS SMALL DELETE UNWANTED PROGRAMME FROM HDD	The remaining capacity of the hard disk drive is in short for the current recording. (☞ pg. 58)
CAPACITY IS FULL, RECORDING STOPPED	The recording stopped due to the shortage of the free space on the hard disk drive.
CAPACITY IS FULL, UNABLE TO RECORD DELETE UNWANTED PROGRAMME FROM HDD	The recording cannot be started due to the shortage of the free space on the hard disk drive. (☞ pg. 58)
TITLE MEMORY IS FULL, UNABLE TO RECORD DELETE UNWANTED PROGRAMME FROM HDD	The remaining capacity is full for registration for the Navigation system. The recording cannot be started even though the capacity for the recording is enough. (☞ pg. 58)
COPY PROHIBITED, UNABLE TO RECORD ON HDD	It is not possible to record a copy-protected programme.
NO PROGRAMME TO PLAYBACK	There is no recorded programme on the hard disk drive.
UNABLE TO GO BACK ANYMORE	It is not possible to go back beyond the start point of the recording for Live Memory Playback. (☞ pg. 29)
DUBBING COMPLETED	Appears when Easy Dubbing is completed. (☞ pg. 63)
DUBBING STOPPED	Appears when Easy Dubbing is stopped. (☞ pg. 63)
TAPE ENDED, DUBBING STOPPED	Appears when the tape ends during Easy Dubbing. (☞ pg. 63)
COPY PROHIBITED	It is not possible to dub a copy-protected programme.
IMPOSSIBLE DURING DV DUBBING OR RECORDING IN DV MODE	When input mode is set to "D-1" or during recording in the recording speed of DV, other operations such as playback of another programme, etc. are not possible.
CAN NOT SELECT PROGRAMME RECORDED IN DV MODE	During recording, you cannot playback another programme recorded in the recording speed of DV.
CAN NOT SELECT PROGRAMME RECORDED OTHER THAN IN DV MODE	When you create a play list, you cannot include scenes recorded in the recording speed of DV and scenes recorded in another mode in the same play list.

PLAYBACK

- Q. What happens if the end of the tape is reached during playback or search?**
- A. The tape is automatically rewound to the beginning.
- Q. During search, slow, still and frame-by-frame playback, I can't hear any audio. What's the problem?**
- A. This is normal.
- Q. Can the video recorder indefinitely remain in the still mode?**
- A. No. It stops automatically after 5 minutes to protect the heads.
- Q. When returning from variable-speed search to normal playback, the picture is disturbed. Should I be concerned about this?**
- A. No, it is normal.
- Q. Sometimes, during Index Search, the video recorder can't find the programme I want to see. Why not?**
- A. There may be index codes too close together.

RECORDING

- Q. When I pause and then resume a recording, the end of the recording before the pause is overlapped by the beginning of the continuation of recording. Why does this happen?**
- A. This is normal. It reduces distortion at the pause and resume points.
- Q. Can the video recorder indefinitely remain in the Record-Pause mode?**
- A. No. The video recorder goes to its Stop mode automatically after 5 minutes to protect the heads.
- Q. What happens if the tape runs out during recording?**
- A. The video recorder stops recording, and "○" and "▷" on the front display panel won't stop blinking.

TIMER RECORDING

- Q. "○" and "⊙" remain lit on the front display panel. Is there a problem?**
- A. No. This is a normal condition for a timer recording in progress.
- Q. Can I programme the timer while I'm watching a tape or a TV broadcast?**
- A. You won't see the picture as it is replaced by the on-screen menu, but the audio from the programme or tape you're viewing can be heard.

GENERAL

Power requirement : AC 220 V – 240 V~, 50 Hz/60 Hz
 Power consumption
 Power on : 42 W
 Power off : 12 W
 Temperature
 Operating : 5°C to 40°C
 Storage : -20°C to 60°C
 Operating position : Horizontal only
 Dimensions (WxHxD)
 : 435 mm x 98 mm x 357 mm
 Weight : 5.3 kg
 Input/Output : 21-pin SCART connectors:
 IN/OUT x 1, IN/DECODER x 1
 RCA connectors:
 VIDEO IN x 1, AUDIO IN x 1,
 AUDIO OUT x 1
 S-Video connectors:
 IN x 1, OUT x 1
 DV connector:
 IN/OUT x 1 (4-pin.IEEE1394
 conformity, digital input/output)

HDD DECK VIDEO/AUDIO

Video format : MPEG2 (VBR)
 Audio format : MPEG1 Layer2
 Maximum recording time (approx.)
 (DV) : 6 hours
 (SP) : 20 hours
 (LP) : 28 hours
 (EP) : 56 hours
 (SEP) : 80 hours

VHS DECK VIDEO/AUDIO

Signal system : PAL-type colour signal and CCIR
 monochrome signal, 625 lines
 50 fields
 Recording system : DA4 (Double Azimuth) head helical
 scan system
 Format : S-VHS/VHS PAL standard
 Signal-to-noise ratio: 45 dB
 Horizontal resolution
 : 250 lines (VHS)
 400 lines (S-VHS)
 Frequency range : 70 Hz to 10,000 Hz (Normal audio)
 20 Hz to 20,000 Hz (Hi-Fi audio)
 Maximum recording time
 (SP) : 240 min. with E-240 video cassette
 (LP) : 480 min. with E-240 video cassette

TUNER/TIMER

TV channel storage capacity
 : 99 positions (+AUX position)
 Tuning system : Frequency synthesized tuner
 Channel coverage : VHF 44.5 MHz – 143 MHz/
 143 MHz – 470 MHz
 UHF 470 MHz – 862 MHz
 Memory backup time
 : Approx. 10 min.

ACCESSORIES

Provided accessories
 : RF cable,
 21-pin SCART cable,
 Satellite Controller,
 Infrared remote control unit,
 "AA" battery x 2

*Specifications shown are for SP mode (VHS) unless otherwise specified.
 E. & O.E. Design and specifications subject to change without notice.*

ATTENTION

This recorder contains microcomputers. External electronic noise or interference could cause malfunctioning. In such cases, switch the recorder off and unplug the mains power cord. Then plug it in again and turn the recorder on. Take out the cassette. After checking the cassette, operate the unit as usual.

Check Contents

CHECK ALL THE CONTENTS SHOWN BELOW

Video Cassette Recorder

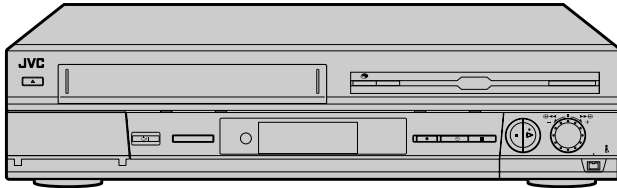

RF Cable

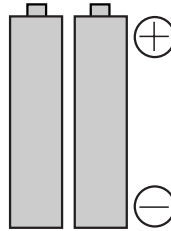

"AA" Batteries (x 2)

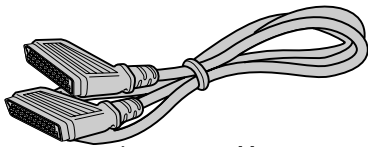

21-pin SCART Cable



Satellite Controller

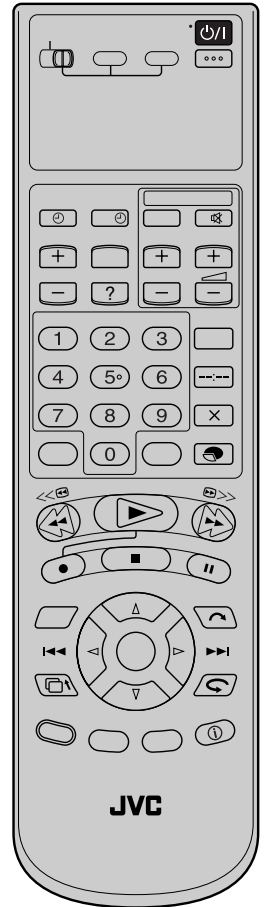

Infrared Remote Control Unit

A	
Audio Dubbing	74
Auto Channel Set	86
Auto Set Up	14
AUTO SP→LP TIMER	81
AUTO TIMER	82
Automatic Satellite Programme Recording	51
B	
B.E.S.T. Picture System	45, 81
C	
Change Station Channel Position	89
Check, cancel and change programmes	50
Clock Set	84
Connecting To A Satellite Receiver	76
D	
Delete A Channel	89
DIRECT REC	21, 82
Dubbing	63
DV Dubbing	72
E	
EDITING	55
Elapsed Recording Time Indication	43
Express Timer Programming	48
F	
F-1 INPUT	69
Fine-Tuning Channels Already Stored	90
G	
Guide Program Number Set	83
I	
Index Search	40
Instant Timer Recording (ITR)	33, 42
J	
Jump search	31
Just Clock	84
L	
L-1 INPUT	68
L-1 OUTPUT	68
L-2 INPUT	69
L-2 SELECT	69
Live Memory Playback	28
Live Memory Recording	29
M	
Manual Channel Set	88
Manual Tracking	41
Mode Set	78
Modify Information	56
N	
Next Function Memory	40
Normal Dubbing (from HDD to VHS)	65
Normal Dubbing (from VHS to HDD)	66
O	
O.S.D.	82
ON-SCREEN DISPLAY	8, 10
Output/Input Set	68
P	
PDC Recording	49
PICTURE CONTROL	81
Play List Features	60
Playback with HDD Navigation	24
Playback with VHS Navigation	36
POWER SAVE	82
Preset Download	16
R	
Record One Programme While Watching Another	33, 42
Recording Resume Function	42
RECORDING/PLAYBACK ON HDD DECK	22
RECORDING/PLAYBACK ON VHS DECK	34
Repeat Playback	32, 40
S	
Satellite Controller	18
Satellite Receiver Control Setting	18
Set Stations (A)	90
Set Stations (B)	90
Slow Motion	30, 39
Soundtrack Selection	32, 41
Still Picture/Frame-By-Frame Playback	30, 39
Super VHS ET (S-VHS ET)	43, 80
S-VHS	70, 80
T	
Tape Position Indicator	10
Tape Remaining Time	43
TIMER RECORDING	46
Tuner Set	86
T-V LINK	21
TV Station And ID List	91
TV Station Channel Number Guide	92
V	
Variable Speed Search	30, 39
VIDEO PLUS+® System Setup	83
VIDEO PLUS+® Timer Programming	46
VIDEO STABILIZER	81



Free Manuals Download Website

<http://myh66.com>

<http://usermanuals.us>

<http://www.somanuals.com>

<http://www.4manuals.cc>

<http://www.manual-lib.com>

<http://www.404manual.com>

<http://www.luxmanual.com>

<http://aubethermostatmanual.com>

Golf course search by state

<http://golfingnear.com>

Email search by domain

<http://emailbydomain.com>

Auto manuals search

<http://auto.somanuals.com>

TV manuals search

<http://tv.somanuals.com>