

JVC



DVD & HDD VIDEO RECORDER

DR-MH30S/ DR-MH20S

FIRST
See
AUTO SET UP
on PAGE 18

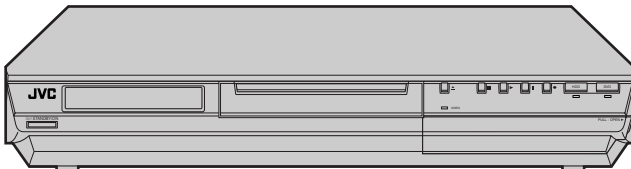

HDD

DVD
VIDEO
RAM/RW

COMPACT
disc
SUPER VIDEO

dts
DIGITAL OUT

DOLBY
DIGITAL

SHOWVIEWTM
DELUXE



INSTRUCTIONS

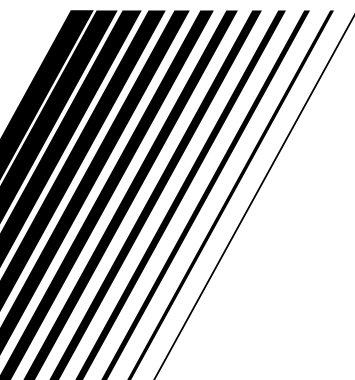

LPT0923-001B

EN

Safety Precautions

The rating plate and the safety caution are on the rear of the unit.

WARNING: DANGEROUS VOLTAGE INSIDE

WARNING: TO PREVENT FIRE OR SHOCK HAZARD, DO NOT EXPOSE THIS UNIT TO RAIN OR MOISTURE.

CAUTION:

A UNIT IS A CLASS 1 LASER PRODUCT. HOWEVER THIS UNIT USES A VISIBLE LASER BEAM WHICH COULD CAUSE HAZARDOUS RADIATION EXPOSURE IF DIRECTED. BE SURE TO OPERATE THE UNIT CORRECTLY AS INSTRUCTED.

WHEN THIS UNIT IS PLUGGED INTO THE WALL OUTLET, DO NOT PLACE YOUR EYES CLOSE TO THE OPENING OF THE DISC TRAY AND OTHER OPENINGS TO LOOK INTO THE INSIDE OF THIS UNIT.

USE OF CONTROLS OR ADJUSTMENTS OR PERFORMANCE OF PROCEDURES OTHER THAN THOSE SPECIFIED HEREIN MAY RESULT IN HAZARDOUS RADIATION EXPOSURE.

DO NOT OPEN COVERS AND DO NOT REPAIR YOURSELF. REFER SERVICING TO QUALIFIED PERSONNEL.

IMPORTANT:

- Please read the various precautions on page 2 and 3 before installing or operating the unit.
- It should be noted that it may be unlawful to re-record pre-recorded tapes, DVDs, or discs without the consent of the owner of copyright in the sound or video recording, broadcast or cable programme and in any literary, dramatic, musical, or artistic work embodied therein.

CAUTION:

- When you are not using the unit for a long period of time, it is recommended that you disconnect the power cord from the mains outlet.
- Dangerous voltage inside. Refer internal servicing to qualified service personnel. To prevent electric shock or fire hazard, remove the power cord from the mains outlet prior to connecting or disconnecting any signal lead or aerial.



- Manufactured under licence from Dolby Laboratories. "Dolby" and double-D symbol are trademarks of Dolby Laboratories.
- "DTS" and "DTS Digital Out" are trademarks of Digital Theater Systems, Inc.
- SHOWVIEW is a registered trademark of Gemstar Development Corporation. The SHOWVIEW system is manufactured under licence from Gemstar Development Corporation.
- This product incorporates copyright protection technology that is protected by method claims of certain U.S. patents and other intellectual property rights owned by Macrovision Corporation and other rights owners. Use of this copyright protection technology must be authorized by Macrovision Corporation, and is intended for home and other limited viewing users only unless otherwise authorized by Macrovision Corporation. Reverse engineering or disassembly is prohibited.

CLASS 1 LASER PRODUCT

REPRODUCTION OF LABELS

WARNING LABEL INSIDE OF THE UNIT

CAUTION	VISIBLE AND INVISIBLE LASER RADIATION WHEN OPEN. AVOID EXPOSURE TO BEAM. DO NOT STARE INTO BEAM OR VIEW DIRECTLY WITH OPTICAL INSTRUMENTS.
ADVARSEL	SYNLIG OG USYNLIG LASERSTRÅLING VED ÅBNING. UNDGÅ UDSAETTEELSE FOR STRÅLING SE IKKE IND I STRÅLEN - HELLER IKKE MED OPTISKE INSTRUMENTER.
ADVARSEL	SYNLIG OG USYNLIG LASERSTRÅLING NÅR DEKSEL ÅPNES. UNDGÅ EKSPONERING FOR STRÅLEN STIRR IKKE INN I STRÅLEN ELLER SE DIREKTE MED OPTISKE INSTRUMENTER.
VARO!	AVATTAESSA OLET ALTTIINA NÄKYVÄÄ JA NÄKYMÄTÖN LASERSÄTEILYLLE. ÄLÄ TUIJOTA SÄTEESEEN ÄLÄKÄ KATSO SITÄ OPTISEN LAITTEEN LÄPI.
VARNING	SYNLIG OCH OSYNLIG LASERSTRÅLNING NÅR DENNA DEL ÄR ÖPPNAD. STRÅLEN ÄR FARLIG STIRRA EJ IN I STRÅLEN OCH BETRAKTA EJ STRÅLEN MED OPTISKA INSTRUMENT.

For Italy:

"It is declared that this product, brand JVC, conforms to the Ministry Decree n. 548 of 28 Aug.'95 published in the Official Gazette of the Italian Republic n. 301 of 28 Dec.'95"

The STANDBY/ON O/I button does not completely shut off mains power from the unit, but switches operating current on and off. "O" shows electrical power standby and "I" shows ON.

When the equipment is installed in a cabinet or a shelf, make sure that it has sufficient space on all sides to allow for ventilation (10 cm or more on both sides, on top and at the rear).

When discarding batteries, environmental problems must be considered and the local rules or laws governing the disposal of these batteries must be followed strictly.

Failure to heed the following precautions may result in damage to the unit, remote control or disc.

1. **DO NOT place the unit —**
 - in an environment prone to extreme temperatures or humidity.
 - in direct sunlight.
 - in a dusty environment.
 - in an environment where strong magnetic fields are generated.
 - on a surface that is unstable or subject to vibration.
2. **DO NOT block the unit's ventilation openings or holes.**
(If the ventilation openings or holes are blocked by a newspaper or cloth, etc., the heat may not be able to get out.)
3. **DO NOT place heavy objects on the unit or remote control.**
4. **DO NOT place anything which might spill on top of the unit or remote control.**
(If water or liquid is allowed to enter this equipment, fire or electric shock may be caused.)
5. **DO NOT expose the apparatus to dripping or splashing.**
6. **DO NOT use this equipment in a bathroom or places with water. Also DO NOT place any containers filled with water or liquids (such as cosmetics or medicines, flower vases, potted plants, cups, etc.) on top of this unit.**
7. **DO NOT place any naked flame sources, such as lighted candles, on the apparatus.**
8. **AVOID violent shocks to the unit during transport.**

MOISTURE CONDENSATION

Moisture in the air will condense on the unit when you move it from a cold place to a warm place, or under extremely humid conditions—just as water droplets form on the surface of a glass filled with cold liquid. In conditions where condensation may occur, disconnect the unit's power plug from the wall and keep it disconnected for a few hours to let the moisture dry, then turn on the unit.

ATTENTION:**To mobile phone users:**

Using a mobile phone in the vicinity of the unit may cause picture vibration on the TV screen or change the screen to a blue back display.

On placing the unit:



Some TVs or other appliances generate strong magnetic fields. Do not place such appliances on top of the unit as it may cause picture disturbance.

DISC INFORMATION	5	EDITING	56
About Discs	5	High Speed Dubbing (From HDD To DVD)	56
INDEX	10	Just Dubbing (From HDD To DVD)	56
INSTALLING YOUR NEW UNIT	17	Manual Dubbing (From HDD To DVD)	57
Basic Connections	17	Original Dubbing (From DVD To HDD)	57
INITIAL SETTINGS	18	DV Dubbing	58
Auto Set Up	18	Edit From A Camcorder	59
Preset Download	19	Edit To Or From Another Recorder	60
Language	21	Output/Input Set	61
Monitor Set	22	Digital Audio Dubbing	62
SAT CONTROL SET	23	REMOTE CONTROL	63
Satellite Receiver Control Setting	23	Remote Control Functions	63
BASIC OPERATIONS ON DVD DECK	25	SYSTEM CONNECTIONS	65
Basic Playback	25	Connecting To A Satellite Receiver	65
Playback Features	26	Connecting To A Dolby Digital Decoder Or An Amplifier With Built-in DTS	66
Using The On-screen Bar	30	SUBSIDIARY SETTINGS	67
Parental Lock	34	Mode Set	67
Basic Recording	35	Scan Mode Set	69
Recording Features	36	ShowView™ System Setup	70
BASIC OPERATIONS ON HDD DECK	38	Tuner Set	70
Basic Recording	38	Clock Set	73
Recording Features	39	Format A Disc (DVD Deck Only)	74
Basic Playback	40	Finalise A Disc (DVD Deck Only)	75
Playback Features	40	Help Function	76
Live Memory Playback	41	Tray Lock (DVD Deck Only)	76
TIMER RECORDING	44	TROUBLESHOOTING	77
ShowView™ Timer Programming	44	SPECIFICATIONS	81
Manual Timer Programming	46	APPENDIX	82
Automatic Satellite Programme Recording	48	LIST OF TERMS	86
NAVIGATION	49		
Library Database Navigation	49		
Modify Original Information	50		
Modify Play List Information	52		
Modify Library Information	54		
Playback With MP3/WMA/JPEG Navigation	55		

About Discs

Recordable/playable Discs

You can use discs with the following logos for recording and playback.

 <p>DVD-RAM 12 cm: 4.7 GB/9.4 GB 8 cm: 1.4 GB/2.8 GB Ver. 2.0/2x speed Ver. 2.1/1x – 2x speed</p>	 <p>DVD-RW 12 cm: 4.7 GB/9.4 GB Ver. 1.1/1x – 2x speed (Video mode/VR mode)</p>
 <p>DVD-R 12 cm: 4.7 GB 8 cm: 1.4 GB Ver. 2.0/1x – 4x speed (Video mode)</p>	

- The above table is based on the information as of February 2004.
- Recording and playback may not be performed depending on the characteristics and condition of the disc used, leading to unsatisfactory results. Using discs manufactured by JVC is recommended since they have been tested to be compatible with this unit.

DVD-RAM Discs

It is only possible to use discs which conform with DVD-RAM standard Version 2.0 or 2.1.

- It is impossible to record on DVD-RAM discs which do not conform to this standard. If you use a disc formatted under a different standard version, format it on this unit before use.
- It may not be possible to record, play back, edit or dub a DVD-RAM disc even if it conforms to the standard if it was recorded or edited on the devices from other manufacturers or on a PC, or if it has far too many titles, or if there is very little available capacity remaining on the disc.
- DVD-RAM discs recorded on this unit cannot be played back on an incompatible DVD player.
- It is possible to record copy-once programmes of digital broadcasts only onto 4.7/9.4 GB DVD-RAM discs (2.8 GB DVD-RAM discs are not compatible).

DVD-R/RW Discs

It is only possible to use DVD-R discs which conform with DVD-R standard Version 2.0.

When a DVD-R/RW disc (Video mode) is finalised (pg. 75), it can be played back on a standard DVD player as a DVD VIDEO disc.

When a DVD-RW disc (VR mode) is finalised (pg. 75), it can be played back on a standard DVD player compatible with the VR mode of DVD-RW discs.

Before finalising —

— it is possible to record on unrecorded areas of the disc, edit the disc title and programme titles, and delete programmes.

- It is impossible to record or edit DVD-R/RW discs recorded on other devices even if they have not been finalised.
- It is impossible to overwrite recorded areas of DVD-R discs.
- Available recording capacity does not increase even if a recorded programme is deleted from a DVD-R disc.

After finalising —

After a DVD-R/RW disc (Video mode) has been finalised, it is possible to play back the recorded programmes (video and/or audio) on a standard DVD video player as a DVD VIDEO disc.

- Edited titles are displayed as the “DVD menu” in video mode.
- It is impossible to record, edit or delete the data either in video mode or in VR mode.
- Either in video mode or in VR mode, although the disc can be played back on DVD players from other manufacturers, sometimes it may not be possible to play back depending on the disc and recording conditions.
- It is impossible to record on CD-R/RW or DVD-R discs used for authoring.
- It is impossible to record onto DVD-R/RW (Video mode) discs broadcasts that allow you to copy once. The copy once programmes can only be recorded onto DVD-RW discs formatted in VR mode.

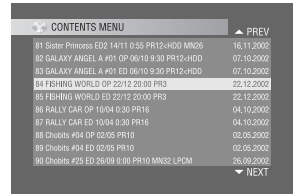







NOTE:

The following may result if you play back a DVD-R disc recorded on another unit.

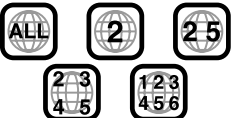
- The disc does not play.
- A mosaic pattern (block noise) appears on the screen.
- Video or audio may be dropped out.
- The unit stops during playback.

Discs For Playback Only

You can use discs with the following logos for playback only.

 <p>DVD VIDEO</p> <p>(example of region code indications)</p> 	<p>Video CD/Super Video CD</p>  
 <p>Audio CD CD-DA files</p>	 <p>CD-R CD-DA/JPEG/ MP3 files</p>
 <p>CD-RW CD-DA/JPEG/ MP3 files</p>	 <p>CD-ROM JPEG/MP3 files</p>

- Playback may not be performed depending on the characteristics and condition of the disc used.
- DTS Audio CDs can also be played back (An optional DTS decoder is required).
- MP3 and JPEG discs can be played back on this unit only when they have been recorded in the ISO9660 or Joliet format and finalised.
- JPEG files that can be played back on this unit must conform to JFIF/Baseline process, and the maximum resolution of a JPEG file is 2,812 x 2,112 pixels.
- CD-R/RW discs recorded in music CD format need to be finalised to play back on this unit.
- Operation and audio quality of this unit are not guaranteed for discs that do not conform to the Compact Disc specification (CD-DA). Before you play back a CD, check for the CD logo and read the notes on the package to confirm that it conforms to the Compact Disc specification.
- Depending on the intentions of the author of the software, recording conditions of DVD discs and Video CD/SVCD discs may be restricted. Since this unit plays back discs according to the intentions of the author of the software as indicated on the disc, some functions may not operate as commanded.
- When switching from the first layer to the second layer of double-layered DVD VIDEO discs, the image and sound may be momentarily distorted. This is not a malfunction.
- DVD-AUDIO discs compatible with DVD video players can be played.
- Super Audio CDs (SACD) compatible with conventional CD players can be played.

Unplayable Discs

The following types of discs cannot be played using this unit. Do not attempt to play back any kind of disc that is damaged (cracked, warped, or repaired with adhesive tape) or discs in unusual shapes (heart-shaped, octagonal, or other forms). If such discs are accidentally played back, it may cause noise that can lead to speaker damage.

- CD-ROM discs (including PHOTO-CD and CD-G)
- Discs recorded in Packet Write (UDF) format
- 1.3-GB double density CDs (DDCD)
- High density CDs (HDCD)

The following discs also cannot be played back.

- Discs of a region number other than "2"
- DVD-RAM (2.6 GB/5.2 GB)
- DVD-RAM (TYPE1)









Region Number

The world is divided into 6 regions for DVD VIDEO discs. DVD VIDEO discs are assigned a region number to indicate which region they may be played back in. A disc cannot be played back on this unit unless the region number of the disc matches that of the unit. The region number for this unit is "2". Only discs whose region number includes "2" or "ALL" can be played back such as shown below.

Examples of DVD VIDEO labels which can be played back using this unit.



Marks of discs in this instruction manual

 <p>Allows operation with a DVD-RAM disc.</p>	 <p>Allows operation with a Video CD/Super Video CD (SVCD) disc.</p>
 <p>Allows operation with a DVD-R disc.</p>	 <p>Allows operation with an Audio CD disc.</p>
 <p>Allows operation with a DVD-RW disc.</p>	 <p>Allows operation with a disc including MP3 files.</p>
 <p>Allows operation with a DVD VIDEO disc.</p>	 <p>Allows operation with a disc including JPEG files.</p>

Recording Medium And Format

DVD-RAM

- Recording and erasing can be performed as many times as possible on a disc.
- Editing can be performed after recording, such as deleting unwanted parts.
- While recording, it is possible not only to start playback of a programme currently being recorded, but also to watch another programme previously recorded.

DVD-RW (VR mode)

- Recording and erasing can be performed as many times as possible on a disc.
- Editing can be performed after recording, such as deleting unwanted parts.

DVD-RW (Video mode)

- Can be played back on other DVD players.
- New recording can be performed by erasing all the data on a disc once played back.

DVD-R

- Can be played back on other DVD players.
- Suitable when keeping a recorded disc for a long time.

File Structure Of Discs

DVD VIDEO

Typically, DVD VIDEO discs are made up of larger units called "titles". Each title has a number (title number) that can be used to select desired titles. Titles are further divided into units called "chapters". Each chapter has a number (chapter number) that can also be used to select desired chapters. Note that some discs are not divided into titles and chapters.

When you record a programme on a DVD-RAM/RW (VR mode) disc

A single recording session results in a single title (a single chapter). However, chapter marks are automatically inserted when recording is paused, or audio changes from monaural to stereo due to commercial breaks, etc. It is also possible to insert chapter marks at desired locations during playback. (pg. 27)

When you record a programme on a DVD-R/RW (Video mode) disc

A single recording session results in a single title (a single chapter). However, chapter marks are automatically inserted when recording is paused, or audio changes due to commercial breaks, etc. It is also possible to insert chapter marks at desired locations during either recording or playback. Once the disc has been finalised, these chapter marks are deleted and new chapter marks are assigned automatically approximately every 5 minutes.

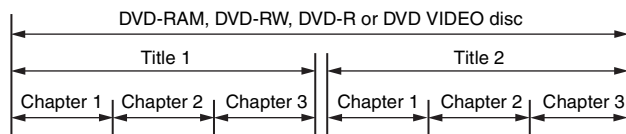

- In Video mode, even before finalising, it is impossible to perform editing operations other than changing the disc name and/or title names and deleting programmes and/or titles.
- After finalising, it is impossible to perform editing operations.

Audio CD/Video CD/SVCD

Typically, Audio CD discs are divided into separate tracks each containing one song. Each track is assigned a number. For example, the third track is Track 3. The same is true for Video CD/SVCD discs.

However, some discs are not divided into tracks.

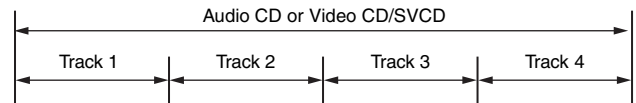

JPEG/MP3 Disc (CD-R/RW/ROM)

MP3/JPEG files put in directories nested in several levels on a disc will be organized as if they were put in single level directories (groups) by the MP3/JPEG Navigation of this unit. (pg. 55)

File structure of a disc before starting the MP3/JPEG Navigation

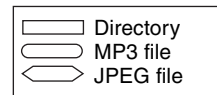
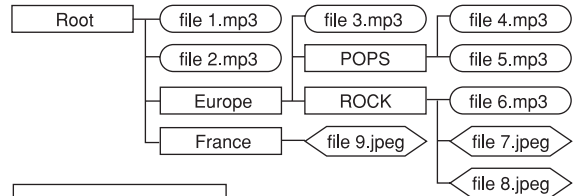

File structure of the disc after starting the MP3/JPEG Navigation

Files are automatically grouped as follows and displayed on the MP3/JPEG Navigation screen. Data is displayed in the alphabetical order of file name. Files are grouped based on roots.

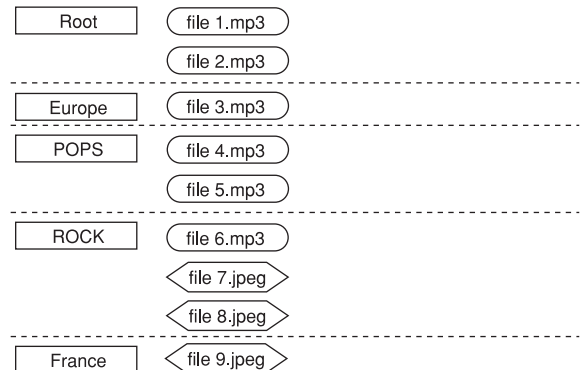

- This unit can recognise up to 9 hierarchies including directories and files. Also, it can recognise up to 250 files in each group, and up to 99 groups on a disc.

NOTES:

Video CD/SVCD discs that support Playback Control (PBC)

The contents of a disc are recorded into several hierarchies, and played back according to the instructions on the screen while navigating through the hierarchies. It is also possible to playback recorded tracks consecutively without activating the PBC function even when playing a PBC-compatible disc. (pg. 29)

Regarding the contents recorded on discs

Some files may not be played back depending on the file types and other factors.

DVD VIDEO Marks

Sometimes marks are printed on a DVD disc and/or on its packaging to indicate information regarding the contents and functions of the disc. Check the marks indicating the contents and functions of the disc. Note, however, that in some cases a disc may not include a mark even for a function it supports.

Marks related to video

	Number of subtitles		Number of angles
	Recorded under the standard 4:3 aspect ratio		Screen includes black bands at the top and the bottom of image which has a standard 4:3 aspect ratio (letter box)
	Video playback is in Wide video mode (16:9) on wide televisions, but in letter box on televisions with standard 4:3 aspect ratio.		
	Video playback is in Wide video mode (16:9) on wide televisions, but pan and scan is used on televisions with standard 4:3 aspect ratio (either the left or right side of the image is cut-out).		

Marks related to audio

	Number of audio tracks
	Dolby Digital mark It has been developed by Dolby Laboratories as a digital surround system.
	DTS (Digital Theater Systems) You can enjoy DTS audio if you connect an amplifier with a built-in DTS decoder to the DIGITAL OUT connector of the unit.

Placing A Disc

Opening the disc tray

Press to open the disc tray.

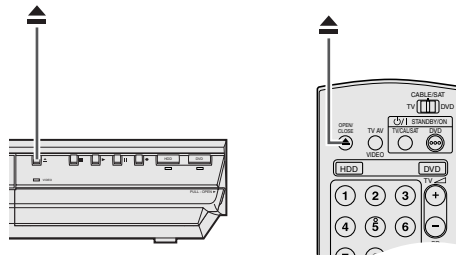

- Pressing the button again closes the disc tray.
- Use the buttons to open and close the disc tray.
- Do not block the disc tray with your hand while it is opening or closing as this may result in hardware failure.
- Do not place unplayable discs or any object other than a disc on the disc tray.
- Do not press down strongly on the disc tray or place any heavy objects on it.

Discs without cartridges

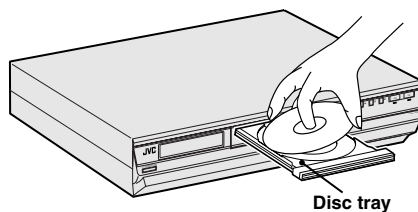

Place the disc on the disc tray with the label side facing up. Since disc size changes depending on the disc to be played back, be sure to correctly align the disc with the grooves for its size. If the disc is not in its groove, it may be scratched or otherwise damaged. To insert an 8 cm disc, place it according to the inner groove.

DVD-RAM discs contained in cartridges

Double-sided discs:

Remove the disc from the cartridge. Align the disc with the grooves on the disc tray as shown in the illustration and insert with the side you wish to play back or record facing down. If you insert the disc with "Side A" facing down, programmes are recorded on the side A.

Single-sided discs:

Remove the disc from the cartridge. Align the disc with the grooves on the disc tray as shown in the illustration and insert with the label side facing up.

Care And Handling Of Discs

How to handle discs

When handling a disc, do not touch the surface of the disc. Since discs are made of plastic, they are easily damaged. If a disc gets dirty, dusty, scratched or warped, the images and sound will not be picked up correctly, and such a disc may cause the unit to malfunction.

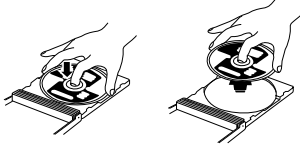

Label side

Do not damage the label side, stick paper to or use any adhesives on its surface.

Recording side

Make sure that discs are not scratched and dirty on the recording side before use. Scratches and dirt on the recording side of a disc may hinder proper playback and recording. Also be careful that a DVD-RAM disc may get scratched or dirt when removed from cartridge then put back in after use.

Storage

Make sure that discs are kept in their cases. If discs are piled on top of one another without their protective cases, they can be damaged. Do not put discs in a location where they may be exposed to direct sunlight, or in a place where the humidity or temperature is high. Avoid leaving discs in your car!

Maintenance of discs

If there are fingerprints or other dirt adhering to a disc, wipe with a soft dry cloth, moving from the centre outwards.

If a disc is difficult to clean, wipe with a cloth moistened with water. Never use record cleaners, petrol, alcohol or any anti-static agents.



CAUTION:

Sometimes during playback, noise may appear or images may be garbled. This is sometimes due to the disc. (It may not be up to industry standards.)

These symptoms are caused by the discs, not by the malfunction of the unit.

Front View

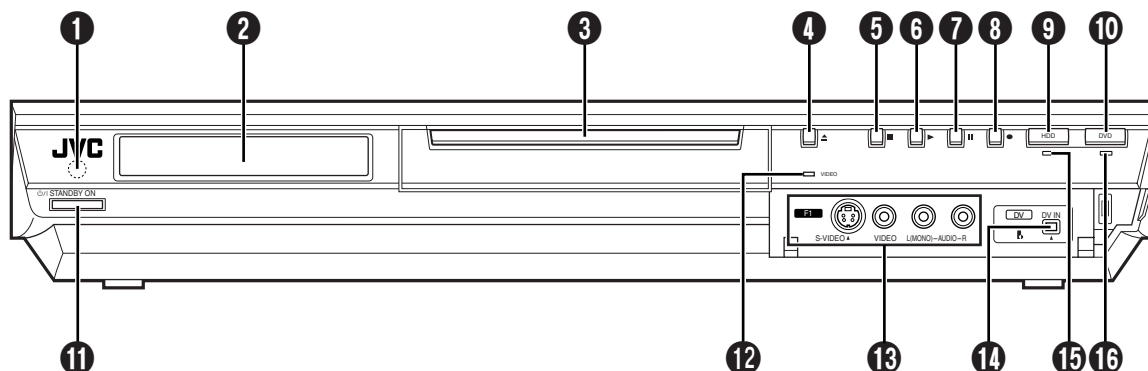

- ❶ Infrared Beam Receiving Window
- ❷ Front Display Panel ☞ pg. 12
- ❸ Disc Tray
- ❹ Open/Close Button (▲) ☞ pg. 8
- ❺ Stop Button (■) ☞ pg. 25, 40
- ❻ Play Button (▶) ☞ pg. 25, 40
- ❼ Pause Button (||) ☞ pg. 25, 40
- ❽ Record Button (●) ☞ pg. 35, 38
- ❾ HDD Button ☞ pg. 38
- ❿ DVD Button ☞ pg. 25

- ❶ Standby/On Button (⏻/⏻)
- ❷ Video Lamp (VIDEO) ☞ pg. 36, 39
- ❸ S-Video/Video/Audio Input Connectors (S-VIDEO/VIDEO/AUDIO (L/R)) ☞ pg. 59
- ❹ DV Input connector (DV IN (i*)) ☞ pg. 58
- * i.Link refers to the IEEE1394-1995 industry specification and extensions thereof. The i.Link logo is used for products compliant with the i.Link standard.
- ❺ HDD Lamp ☞ pg. 38
- ❻ DVD Lamp ☞ pg. 25

To access covered connectors, pull and open the connector cover.

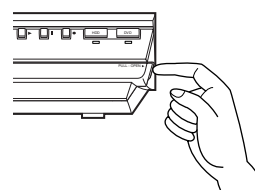

Rear View

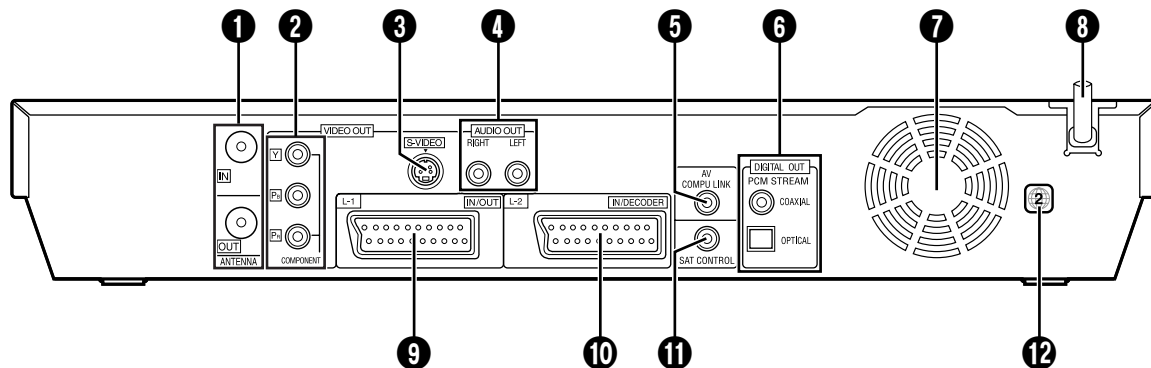

- 1** Antenna Connectors (ANTENNA IN/OUT) ↗ pg. 17
- 2** Component Video Output Connectors (COMPONENT VIDEO OUT) ↗ pg. 17
- 3** S-video Output Connector (S-VIDEO OUT) ↗ pg. 17, 60
- 4** Audio Output Connectors (AUDIO OUT (RIGHT/LEFT)) ↗ pg. 60
- 5** AV COMPU LINK Connector*
* Not function with this unit.
- 6** Digital Audio Output Connectors (DIGITAL OUT (COAXIAL/OPTICAL)) ↗ pg. 62, 66
- 7** Cooling Fan
 - This prevents the temperature from rising inside the unit. Do not remove it.
 - Install the unit so as not to block the area around the fan.
 - The cooling fan on the rear of the unit may be activated even if the unit is turned off in the following cases;
 - In the Automatic Satellite Programme Recording standby mode (↗ pg. 48), slightly before the starting time of VPS/PDC recording (↗ pg. 45)
 - If you connect the decoder or the satellite receiver to L-2 IN/DECODER and if "L-2 SELECT" is set to "DECODER" or "SAT VIDEO" or "SAT S-VIDEO". (↗ pg. 61)
 - when "JUST CLOCK" is set to "ON" (↗ pg. 73)
(Set "JUST CLOCK" to "OFF" if you mind the noise of the fan.)
- 8** Mains Power Cord ↗ pg. 17
- 9** L-1 Input/Output Connector (L-1 IN/OUT) ↗ pg. 17, 60, 61, 65, 66
- 10** L-2 Input/Decoder Connector (L-2 IN/DECODER) ↗ pg. 23, 60, 65, 66
- 11** Satellite Control Connector (SAT CONTROL) ↗ pg. 23
- 12** Region Number Label ↗ pg. 6

Front Display Panel

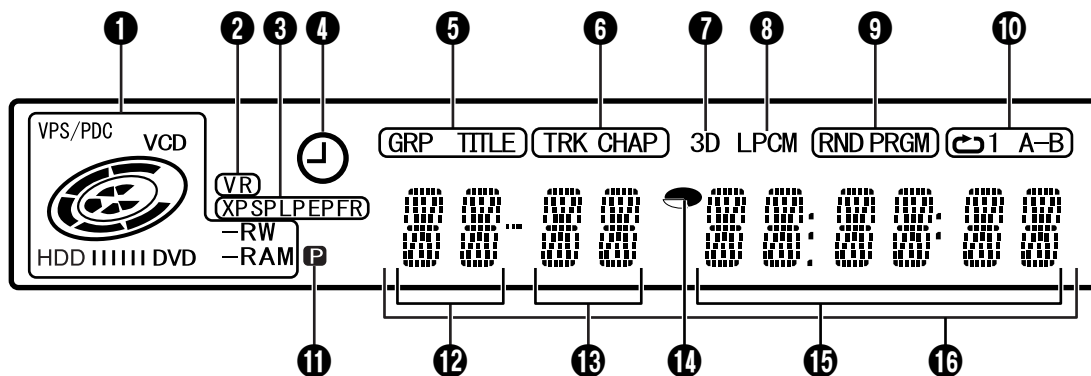
**1** VPS/PDC Indicator [pg. 45](#)

Appears when checking if the station being received transmits a VPS/PDC signal.

Disc Type Indicator

When a disc is loaded, the type of the disc is indicated.

Disc Status Indicator

When a disc is running, the disc marks rotate.

During High-Speed Search: Rotate faster than normal playback.
During Slow Motion: Rotate slower than normal playback.
While recording: Inner red ring lights in the same way as normal playback. During Instant Timer Recording (ITR), inner red ring lights slowly blink.

While paused: Disc marks blink when either recording or playing back.

While stopped: Disc marks all light.
While resume stopped: Disc marks all blink.
While the disc tray opened: Disc marks all light out.
No disc on the disc tray: Disc marks all light out.

2 VR Mode Indicator [pg. 74](#)

Lights when a DVD-RW disc is formatted in VR mode.

3 Recording Mode Indicator (XP/SP/LP/EP/FR) [pg. 35](#)

Blinks when recording mode is being set.
While "FR" is blinking, the left 3 digits of the Multi Display (**12**) indicate setting values ranging from "60" to "480". After the value has been set, only "FR" lights.

4 VPS/PDC Recording Indicator [pg. 45](#)

Lights when the VPS/PDC recording function is activated.

5 Group/Title Indicator (GRP/TITLE)

"GRP" or "TITLE" lights depending on a disc loaded while the left 2 digits of the Multi Display (**12**) indicate the numbers explained below.

"GRP": Total number of groups or group number being played back are displayed on the Multi Display.

"TITLE": Total number of titles or title number being played back are displayed on the Multi Display.

6 Track/Chapter Indicator (TRK/CHAP)

"TRK" or "CHAP" lights depending on a disc loaded while the 3rd and 4th digits from the left of the Multi Display (**13**) indicate the numbers explained below.

"TRK": Total number of tracks or track number being played back are displayed on the Multi Display.

"CHAP": Chapter number being played back are displayed on the Multi Display.

7 Simulated Surround Effect Indicator (3D) [pg. 32](#)

Lights when a simulated surround effect is set to "3D-ON" on the on-screen bar.

8 Linear PCM Indicator (LPCM)

Lights when "XP MODE REC AUDIO" is set to "LINEAR PCM" ([pg. 68](#)) for recording with HDD, DVD-RAM, DVD-R and DVD-RW discs, and when Linear PCM audio is played.

9 Random/Programme Playback Mode Indicator (RND/PRGM) [pg. 33](#)

"RND": Lights when Random Playback mode is set.

"PRGM": Lights when Programme Playback mode is set.

10 Repeat Mode Indicator (1/A-B) [pg. 31](#)

Select Repeat Playback mode on the on-screen bar.
"1": Whole disc is played back repeatedly.
"1": A single title/chapter/track is played back repeatedly.
"A-B": The selected part (A-B) is played back repeatedly.
No display: Repeat Playback mode is off.

11 Video Output Indicator (P) [pg. 69](#)

No display: Indicates that interlace mode is engaged.

P: Indicates that progressive mode is engaged.

(**Example**) P lights when video output mode is in progressive mode.

12 Group/Title Number Display**13** Track/Chapter Number Display

14 Remaining Time/Elapsed Time Indicator [pg. 28, 36](#)
Lights when remaining time of DVD-RAM, DVD-R and DVD-RW discs is displayed, and lights out when elapsed time is displayed. The right 6 digits of the Multi Display (**16**) indicate elapsed or remaining time of each track.

No display: Indicates elapsed time of the disc.

Displayed: Indicates remaining time of the disc.

15 Remaining Time/Elapsed Time Display [pg. 28, 36](#)**16** Multi Display

Displays clock, received channel, elapsed time, and remaining time. Also displays status of the unit (NO DISC/OPEN/CLOSE/READING).

Remote Control

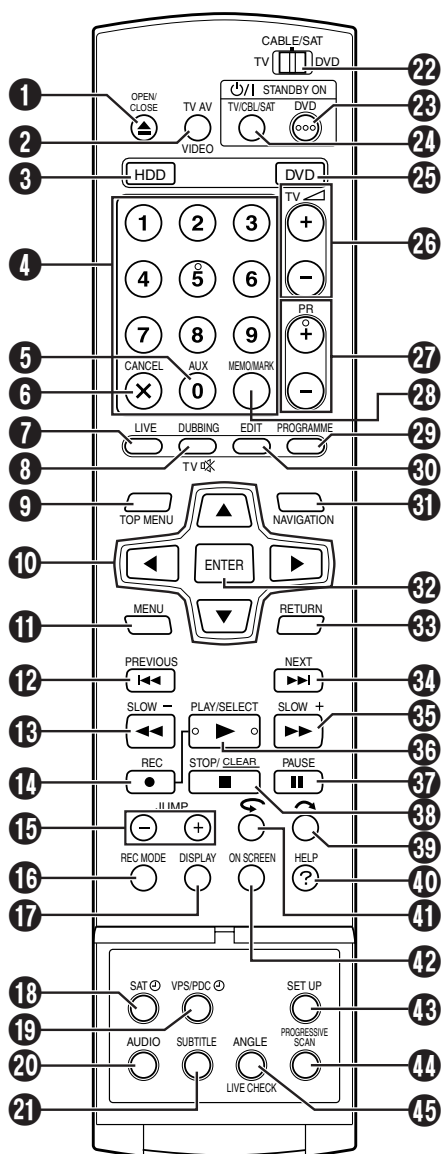

- 1 Open/Close Button (▲) ☞ pg. 8
- 2 TV AV/VIDEO Button ☞ pg. 36, 39
- 3 HDD Button ☞ pg. 38
- 4 Number Keys ☞ pg. 23, 35, 38
- 5 Auxiliary Button (AUX) ☞ pg. 46, 70
- 6 Cancel Button (X (CANCEL)) ☞ pg. 44
- 7 Live Button (LIVE) ☞ pg. 42
- 8 Dubbing Button (DUBBING) ☞ pg. 56
TV Muting Button (TV 🔇) ☞ pg. 63
- 9 Top Menu Button (TOP MENU) ☞ pg. 26
- 10 $\triangle \nabla \triangleleft \triangleright$ Buttons ☞ pg. 21
- 11 Menu Button (MENU) ☞ pg. 26
- 12 Reverse Skip Button (◀◀) ☞ pg. 26, 42, 43
Previous Button (PREVIOUS) ☞ pg. 29
- 13 Reverse Search Button (◀◀) ☞ pg. 26, 42
Reverse Slow Button (SLOW -) ☞ pg. 27
- 14 Record Button (●) ☞ pg. 35, 38
- 15 Jump Button (JUMP +/-) ☞ pg. 43
- 16 Recording Mode Button (REC MODE) ☞ pg. 35, 38
- 17 Display Button (DISPLAY) ☞ pg. 28, 36
- 18 Automatic Satellite Programme Recording Button (SATⓄ) ☞ pg. 48

- 19 VPS/PDC Recording Button (VPS/PDCⓄ) ☞ pg. 45
- 20 Audio Button (AUDIO) ☞ pg. 29
- 21 Subtitle Button (SUBTITLE) ☞ pg. 28
- 22 TV/CABLE/SAT/DVD switch ☞ pg. 21
- 23 DVD Standby/On Button (DVD Ⓞ/|)
- 24 TV/CBL/SAT Standby/On Button (TV/CBL/SAT Ⓞ/|) ☞ pg. 63
- 25 DVD Button ☞ pg. 25
- 26 TV Volume Buttons (TV \triangleleft +/-) ☞ pg. 63
- 27 Programme Buttons (PR +/-) ☞ pg. 35, 63
- 28 Memo Button (MEMO) ☞ pg. 50, 53
Mark Button (MARK) ☞ pg. 27
- 29 Programming Button (PROGRAMME) ☞ pg. 44, 46, 47
- 30 Edit Button (EDIT) ☞ pg. 50
- 31 Navigation Button (NAVIGATION) ☞ pg. 49
- 32 Enter Button (ENTER) ☞ pg. 21
- 33 Return Button (RETURN) ☞ pg. 29, 44
- 34 Forward Skip Button (▶▶) ☞ pg. 26, 42, 43
Next Button (NEXT) ☞ pg. 29
- 35 Forward Search Button (▶▶) ☞ pg. 26, 42
Forward Slow Button (SLOW +) ☞ pg. 27
- 36 Play Button (▶) ☞ pg. 25, 40
Select Button (SELECT) ☞ pg. 25, 50
- 37 Pause Button (||) ☞ pg. 25, 40
- 38 Stop Button (■) ☞ pg. 25, 40
Clear Button (CLEAR) ☞ pg. 31, 44
- 39 Skip Search Button (◀) ☞ pg. 27, 42
- 40 Help Button (?) ☞ pg. 76
- 41 One Touch Replay Button (↺) ☞ pg. 42
- 42 On-Screen Button (ON SCREEN) ☞ pg. 14, 30
- 43 Set Up Button (SET UP) ☞ pg. 21
- 44 Progressive Scan Button (PROGRESSIVE SCAN) ☞ pg. 69
- 45 Angle Button (ANGLE) (DVD deck only) ☞ pg. 28
Live Check Button (LIVE CHECK) ☞ pg. 42

How To Use

Before use, insert two R6 size batteries into the remote control with the polarity (⊕ and ⊖) matched correctly as indicated on the battery compartment or on the lid.

The remote control can operate most of your unit's functions, as well as basic functions of TV sets and satellite receivers of JVC and other brands. (☞ pg. 63, 64)

- Point the remote control toward the receiving window.
- The maximum operating distance of the remote control is about 8 m.

NOTE:

If the remote control doesn't work properly, remove its batteries, wait a short time, replace the batteries and then try again.

On-Screen Display (DVD deck)

When "SUPERIMPOSE" is set to "AUTO" and **ON SCREEN** on the remote control is pressed, various operational indicators appear on the TV screen. To clear the operational indicators, press **ON SCREEN** twice.

When playing back a recorded title

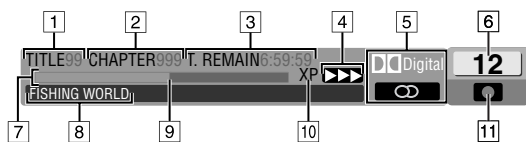

- 1 Playback title number
- 2 Playback chapter number
- 3 Disc remaining time
- 4 Current status (playback)
- 5 Audio mode
- 6 Current received (recording) channel position number (On playback background)
- 7 Bar meter
- 8 Name of title (or play list) currently being played back
- 9 Current playback point
- 10 Recorded mode
- 11 Live Memory mode (recording)

When recording

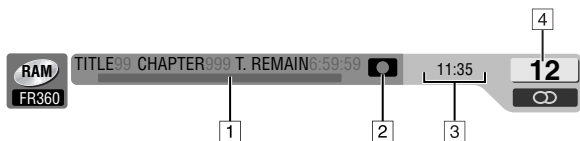

- 1 Recording point
- 2 Current status (recording)
- 3 Current time
- 4 Recording channel number

When pressing REC MODE

(Appears for eight seconds.)

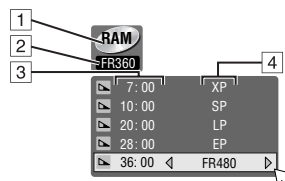

- 1 Disc type
- 2 Current recording speed
- 3 Remaining disc time for each recording speed
- 4 Recording speed

When pressing ● during recording



- 1 Recording time for Instant Timer Recording (ITR) mode

On-Screen Display (HDD deck)

When "SUPERIMPOSE" is set to "AUTO" and **ON SCREEN** on the remote control is pressed, various operational indicators appear on the TV screen. To clear the operational indicators, press **ON SCREEN** twice.

When playing back a recorded title

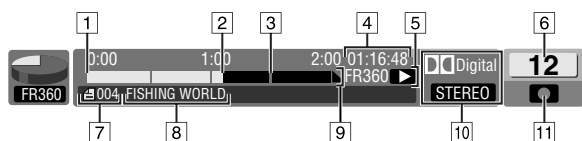

- 1 Title start
- 2 Current playback point
- 3 Title end
- 4 Elapsed playing time
- 5 Play mode
- 6 Current received (recording) channel position number (On playback background)
- 7 Recorded title (or play list) number currently being played back
- 8 Name of title currently being played back
- 9 Time scale (This title is an hour and a half long.)
- 10 Audio mode
- 11 Live Memory mode (recording)

When watching a programme on air

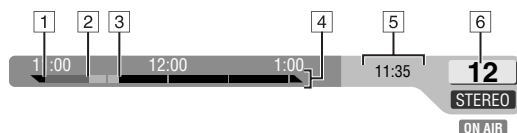

- 1 Possible start point from where Live Memory Playback can be performed
- 2 Possible start point from where Live Memory Recording can be performed (Received channel has changed at this point.)
- 3 Currently viewed point
- 4 Time scale
- 5 Current time
- 6 Current received channel position number

When using Live Memory playback

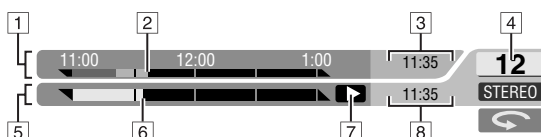

- 1 Time scale for Temporary Recording
- 2 Current Temporary Recording point
- 3 Current time
- 4 Current playback channel position number
- 5 Time scale for Live Memory Playback
- 6 Current playback point
- 7 Live Memory playback mode
- 8 Current playback time

When recording



- 1 Live Memory Recording point
- 2 Live Memory Recording mode

When pressing REC MODE

(Appears for eight seconds.)

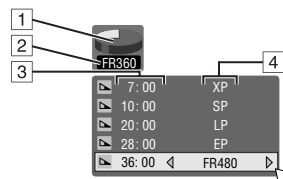

- 1 HDD capacity graph
- 2 Current recording speed
- 3 Remaining HDD time for each recording speed
- 4 Recording speed

When pressing ● during recording

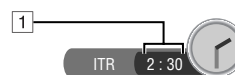

- 1 Recording time for Instant Timer Recording (ITR) mode

On-Screen Display (DV Dubbing)

When capturing images from the external DV equipment

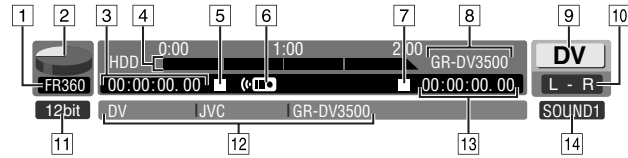

- 1 Recording speed
- 2 HDD capacity graph
- 3 HDD time counter
- 4 Recording time scale
- 5 HDD mode
- 6 Remote control mode
- 7 Connected DV equipment mode
- 8 Connected DV equipment model information
- 9 Input channel
- 10 Sound mode
- 11 Sound input bit-rate*
- * Indicates the sound bit-rate of the connected DV equipment
- 12 Connected DV equipment information*
- * Maker name and model name, etc. may not appear depending on the connected equipment.
- 13 Time counter for the connected DV equipment
- 14 Sound monitor mode

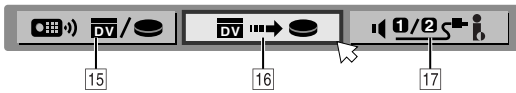

- 15 Remote control switch
- 16 Auto capture button
- 17 Sound monitor switch



- 18 Elapsed recording time

Basic Connections

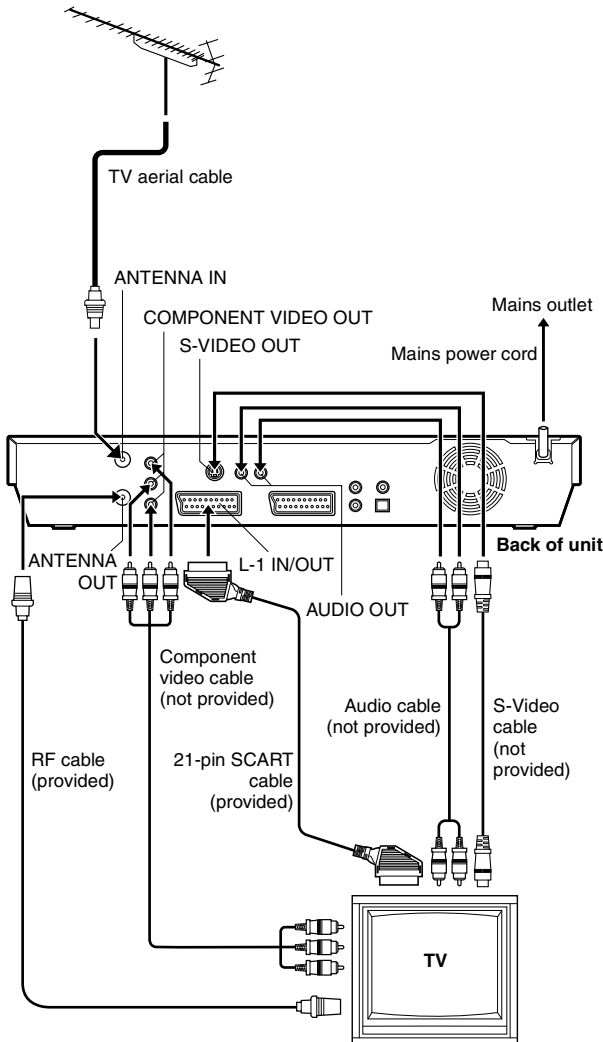

It's essential that your unit be properly connected.

ATTENTION:

Your TV must have a 21-pin AV input connector (SCART) for the basic connection to the unit.

THESE STEPS MUST BE COMPLETED BEFORE ANY VIDEO OPERATION CAN BE PERFORMED.

- 1** Make sure the package contains all of the accessories listed in "SPECIFICATIONS" on page 81.
- 2** Place the unit on a stable, horizontal surface.
- 3** Connect the unit to a TV depending on the TV and cables you use.

■ **Basic Connection**

To connect to a TV with 21-pin SCART input connector —

- 1** Disconnect the TV aerial cable from the TV.
 - 2** Connect the TV aerial cable to the ANTENNA IN connector on the rear panel of the unit.
 - 3** Connect the ANTENNA OUT connector on the rear panel of the unit and the TV's aerial connector with the provided RF cable.
 - 4** Connect the L-1 IN/OUT connector on the rear panel of the unit and the TV's 21-pin SCART connector with a provided 21-pin SCART cable.
- The L-1 IN/OUT connector accepts and delivers either a composite signal (regular video signal), Y/C signal or RGB signal.
 - Set your TV to the VIDEO (or AV), Y/C, or RGB mode according to the type of your TV's SCART connector.

■ **S-Video Connection**

To connect to TV's S-VIDEO input and AUDIO input connectors —

- 1** Perform **1** – **3** in "Basic Connection".
 - 2** Connect the unit's S-VIDEO OUT connector to the TV's S-VIDEO input connector.
 - 3** Connect the unit's AUDIO OUT connectors to the TV's AUDIO input connectors.
- You can obtain high-quality S-VHS pictures.
 - With S-VIDEO connection, you cannot use the Preset Download function. (⌚ pg. 19)
 - If your TV is not stereo-capable, use the unit's AUDIO OUT connectors to connect to an audio amplifier for Hi-Fi stereo sound reproduction.

■ **Component Video Connection**

To connect to TV's component video input connectors —

- 1** Perform **1** – **3** in "Basic Connection".
 - 2** Connect the unit's COMPONENT VIDEO OUT connectors to the TV's component video input connectors.
 - 3** Connect the unit's AUDIO OUT connectors to the TV's AUDIO input connectors.
- You can obtain high-quality component video pictures.
 - If your TV is not stereo-capable, use the unit's AUDIO OUT connectors to connect to an audio amplifier for Hi-Fi stereo sound reproduction.
 - By using the component video connection, you can view the images in the progressive mode. For switching to the progressive mode, refer to "Scan Mode Set" (⌚ pg. 69).

NOTE:

Select an appropriate option of "L-1 OUTPUT" as follows (⌚ pg. 61):

When your TV's SCART connector accepts:	Set "L-1 OUTPUT" to:
Composite signals	"SCART VIDEO"
Y/C signal (separated luminance (brightness) and chrominance (colour) signals)	"SCART S-VIDEO"
RGB signal	"SCART RGB"
Component video signal	"COMPONENT"

- 4** Plug the end of the mains power cord into a mains outlet.
 - "LOADING" blinks on the front display panel when the AC plug of the mains power cord is connected into a mains outlet and it takes approximately 50 seconds for the unit to be turned on. This is not a malfunction.

Auto Set Up

Auto Channel Set/Auto Clock Set/Auto Guide Program Number Set

After the $\psi/1$ button on the unit (or DVD $\psi/1$ on the remote control) is pressed for the first time to turn on the unit, by simply selecting your country*, the Auto Set Up function sets the tuner channels, clock** and Guide Program numbers automatically.

* If you live in Belgium (BELGIUM) or Switzerland (SUISSE), you also need to select your language.

** If you live in Hungary (MAGYARORSZÁG), Czech Republic (ČESKÁ REPUBLIKA), Poland (POLSKA) or other countries in Eastern Europe (OTHER EASTERN), set the clock manually.

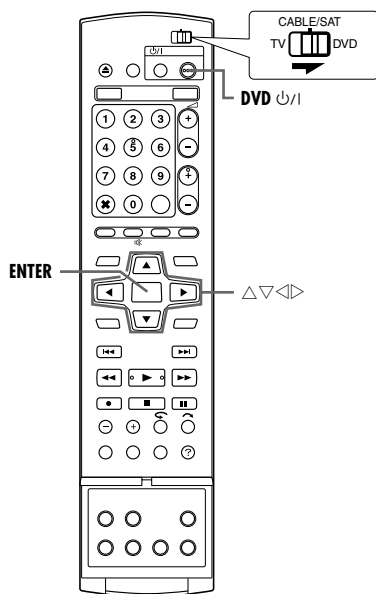
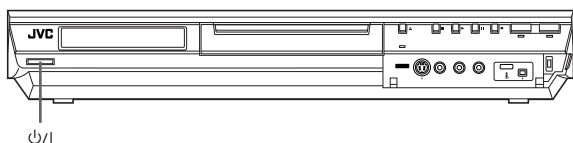

Before starting, make sure of the following:

- The TV aerial cable should be connected to the unit.
- The unit's mains power cord should be connected to a mains outlet.
- Turn on the TV and select the AV mode.
- Slide the TV/CABLE/SAT/DVD switch to DVD.

1 Press $\psi/1$ on the unit or DVD $\psi/1$ on the remote control to turn on the unit. The Country Set display appears on the TV screen.

2 Press $\triangle \nabla \triangleleft \triangleright$ to select your country's name, then press **ENTER**. The Language Set display appears on the TV screen.

NOTES:

- If you have selected BELGIUM or SUISSE, go to step 3.
- If you have selected MAGYARORSZÁG, ČESKÁ REPUBLIKA, POLSKA or OTHER EASTERN, press **ENTER**. The Clock Set screen appears. Set the clock manually (pg. 73), then go to step 4.
- If you have selected any other country name, go to step 4.

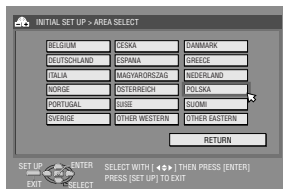

3 Press $\triangle \nabla \triangleleft \triangleright$ to select the language of your choice, then press **ENTER**. The AUTO SET/T-V LINK display appears on the TV screen.

4 Press $\triangleleft \triangleright$ to select "AUTO SET", then press **ENTER**. The AUTO SET screen will appear.

ATTENTION:

"AUTO" blinks on the front display panel; do NOT press any button on the unit or remote control until the front display panel shows "--:--" as illustrated on page 20.

- When you have connected the unit to a TV offering T-V Link via a fully-wired 21-pin SCART cable (pg. 17) and the TV is turned on, the unit automatically performs the Preset Download (pg. 19) even if you select "AUTO SET" for Auto Set Up function.

ATTENTION:

Once you have performed Auto Set Up, even if the unit's memory backup has expired, all the stored stations and their Guide Program numbers remain in the unit's memory and the unit will not perform Auto Set Up again. The unit only performs Auto Clock Set when the unit is turned on.

If you have moved to a different area, perform each setting as required.

- Tuner setting (pg. 70)
- Clock setting (pg. 73)

If a new station starts broadcasting in your area, perform tuner setting. (pg. 70)

NOTES:

- In areas where no TV station transmits a PDC (Programme Delivery Control) signal, the unit can perform neither Auto Clock Set nor Auto Guide Program Number Set.
- If there is a power cut, or if you press $\psi/1$ or **SET UP** while Auto Set Up is in progress, Auto Set Up will be interrupted; be sure to turn off the unit power once and try again from step 1.
- Auto Clock Set may not function properly depending on the reception condition.
- If no sound accompanies the picture or the audio sounds unnatural on some channels that have been stored by Auto Set Up, the TV system setting for those channels may be incorrect. Select the appropriate TV system for those channels. (pg. 72, "INFORMATION")

After "Auto Set Up" is completed, perform "Monitor Set" on page 22.

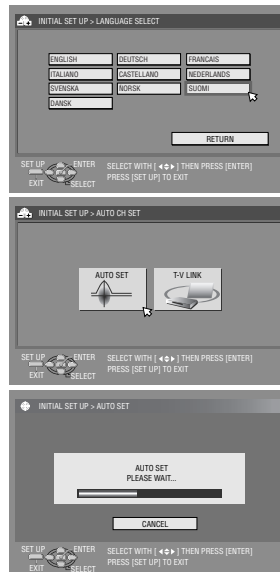

Preset Download

Auto Channel Set by Downloading from TV/Auto Clock Set/Auto Guide Program Number Set

ATTENTION:

You can use this function only with a TV offering T-V Link, etc.* Be sure to use a fully-wired 21-pin SCART cable.

* Compatible with TVs offering T-V Link, EasyLink, Megalagic, SMARTLINK, Q-Link or DATA LOGIC via a fully-wired 21-pin SCART cable. The degree of compatibility and available functions may differ by system.

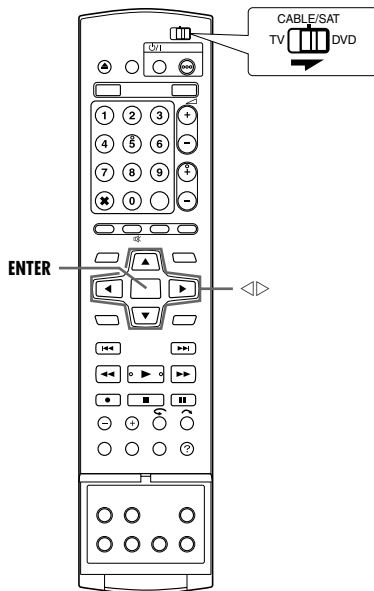

If you have connected the unit to your TV via a 21-pin SCART cable (☞ pg. 17), the unit will automatically perform Preset Download instead of the Auto Set Up in step 4 on page 18. After downloading, the unit sets the clock and Guide Program numbers automatically.

- Slide the TV/CABLE/SAT/DVD switch to DVD.
- Perform steps 1 to 3 of "Auto Set Up" (☞ pg. 18) before continuing.

1 Press ◀▶ to select "T-V LINK" and press ENTER. The T-V LINK screen will appear.

ATTENTION:

Preset positions on the front display panel increase from "PR 1"; do NOT press any button on the unit or remote control until the front display panel shows clock time, "PR 1" or "--:--" as illustrated on page 20.

- When Preset Download is completed, "COMPLETED" appears for about 5 seconds, then the normal screen appears.
- If you press any button on the unit or remote control while downloading is in progress, it will be interrupted.

NOTES:

- For details, refer to the instruction manual of your TV.
- In the area where no TV station transmits a PDC (Programme Delivery Control) signal, the unit can perform neither Auto Clock Set nor Auto Guide Program Number Set.
- If there is a power cut, or if you press ⏻ or SET UP while downloading or set up is in progress, it will be interrupted; be sure to turn off the unit power once and try again from the beginning.
- Auto Clock Set may not function properly depending on the reception condition.
- On this unit, the characters available for station names (ID) are A–Z, 0–9, –, *, + and _ (space). Some names of downloaded stations may differ from those of your TV. (☞ pg. 72)

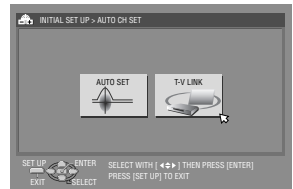

After "Preset Download" is completed, perform "Monitor Set" on page 22.

Results Of Auto Set Up/Preset Download Appearing On The Front Display Panel

If both Auto Channel Set and Auto Clock Set have been performed successfully, the correct current time is displayed.

PR 1 20:00

Turn on the TV and select its AV mode, then make sure that all necessary stations have been stored in the unit's memory by using the PR +/- button(s).

- If station names (ID – pg. 85) have also been stored in the unit's memory, the station name will be displayed at the top right corner of the TV screen for about 5 seconds when the unit is tuned to a different station.
- If you want to set the tuner manually such as to add or skip channels, to change channel positions, or to set or change station names, see pages 71 – 72.

If Auto Channel Set has succeeded but Auto Clock Set has not, "PR 1" (channel position) is displayed.

PR 1 -:-:-

OR
If both Auto Channel Set and Auto Clock Set have failed, "-:-:-" is displayed.

- 1 Turn on the TV and select its AV mode, then make sure that all necessary stations have been stored in the unit's memory by using the PR +/- button(s).
- If station names (ID – pg. 85) have also been stored in the unit's memory, the station name will be displayed at the top right corner of the TV screen for about 5 seconds when the unit is tuned to a different station.
- If you want to set the tuner manually such as to add or skip channels, to change channel positions, or to set or change station names, see pages 71 – 72.
- 2 Perform "Clock Set" on page 73.

ATTENTION:

After making sure the cables are connected properly, turn off the unit's power once, then turn the unit's power back on again. The Country Set display appears on the TV screen; perform "Auto Set Up" on page 18 or "Preset Download" on page 19 again.

IMPORTANT:

- To check if the Guide Program numbers have been set correctly, perform the SHOWVIEW Timer Programming. (pg. 44)
- In certain reception conditions, station names may not be stored correctly, and auto Guide Program Number Set may not work properly. If the Guide Program numbers are not set properly when you timer-record a TV programme using the SHOWVIEW system, the unit will record a TV programme of a different station. When programming the timer using the SHOWVIEW system, be sure to check the desired channel is selected correctly. (pg. 44, "ShowView™ Timer Programming")
- Your unit memorizes all detected stations even if reception of some of them is poor. You can delete those stations with an unacceptable picture. (pg. 72, "Delete A Channel")

INFORMATION

Language for the on-screen display

Auto Set Up also selects the language automatically for the on-screen display depending on the Country setting you have made in step 2 on page 18 (unless you have selected BELGIUM or SUISSE), as shown below.

SUOMI → SUOMI	ITALIA → ITALIANO
PORTUGAL → ENGLISH	MAGYARORSZÁG → ENGLISH
DEUTSCHLAND → DEUTSCH	ESPAÑA → CASTELLANO
POLSKA → ENGLISH	NEDERLAND → NEDERLANDS
NORGE → NORSK	GREECE → ENGLISH
SVERIGE → SVENSKA	OTHER WESTERN → ENGLISH
DANMARK → DANSK	OTHER EASTERN → ENGLISH
ÖSTERREICH → DEUTSCH	
ČESKÁ REPUBLIKA → ENGLISH	

If you want to change the language setting manually, see "On-screen Language Set" on page 21.

Just Clock

Your unit is equipped with the Just Clock function which provides accurate time keeping through automatic adjustments at regular intervals, by reading data from a PDC signal. If you want to take advantage of this function, simply set it to "ON". (pg. 73)

T-V Link Functions

When you connect the unit to your TV via a fully-wired 21-pin SCART cable (pg. 17), the following functions are available. You can use these functions only with a TV offering T-V Link, etc.* For details, refer to the instruction manual of your TV.

* Compatible with TVs offering T-V Link, EasyLink, Megaloc, SMARTLINK, Q-Link or DATA LOGIC via a fully-wired 21-pin SCART cable. The degree of compatibility and available functions may differ by system.

TV Auto Power On

The TV will turn on and be set to its AV mode automatically whenever you start playback.

For details, refer to the instruction manual of your TV.

Unit Auto Standby

You can use your TV's remote control to turn off the unit. For details, refer to the instruction manual of your TV.

Direct Rec

You can easily start recording the programme that you are watching on your TV. When you use this function, set "DIRECT REC" to "ON". (pg. 68)

Language

- Turn on the unit.
- Turn on the TV and select the AV mode.
- Slide the **TV/CABLE/SAT/DVD** switch to **DVD**.

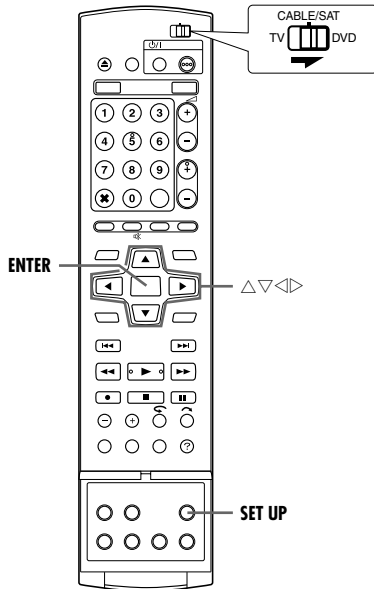

On-screen Language Set

This unit offers you the choice to view on-screen messages in 10 different languages.

- 1 Press **SET UP** to access the Main Menu screen.
- 2 Press $\triangleleft \triangleright$ to select "FUNCTION SET UP", then press ∇ .
- 3 Press $\triangleleft \triangleright$ to select "DISPLAY SET", then press ∇ .
- 4 Press $\triangle \nabla$ to select "ON SCREEN LANGUAGE", then press **ENTER**.
- 5 Press $\triangle \nabla$ to select your desired language, then press **ENTER**.
- 6 Press **SET UP** to complete the setting.

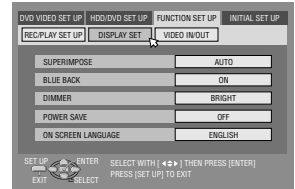

Menu/Audio/Subtitle Language Set (DVD deck only)

Some DVD discs contain the DVD menu display, audio and subtitles in multiple languages. With these discs, you can set the default language as you like.

- The procedure shows how to set "MENU LANGUAGE" as an example.

- 1 Press **SET UP** to access the Main Menu screen.
- 2 Press $\triangleleft \triangleright$ to select "DVD VIDEO SET UP", then press ∇ .
- 3 Press $\triangleleft \triangleright$ to select "LANGUAGE SET", then press ∇ .
- 4 Press $\triangle \nabla$ to select "MENU LANGUAGE", then press **ENTER**.
- 5 Press $\triangle \nabla$ to select your desired language, then press **ENTER**.
- 6 Press **SET UP** to complete the setting.

- See "Language Code List" (pg. 82).

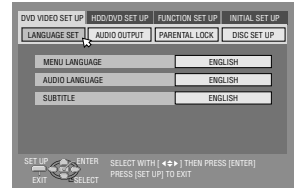

NOTE:

When the selected language is not available on the disc, the disc's default menu language is played back.

Monitor Set

You can select the monitor type depending on the TV used when you play back DVD VIDEO discs recorded for wide-screen TVs.

- Turn on the unit.
- Turn on the TV and select the AV mode.
- Slide the **TV/CABLE/SAT/DVD** switch to **DVD**.

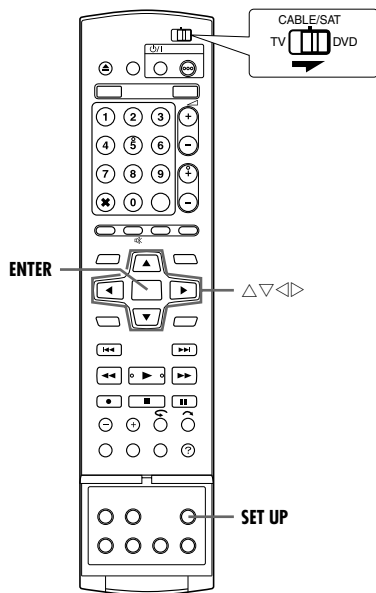

- 1 Press **SET UP** to access the Main Menu screen.
 - You cannot set the monitor type during recording or playback.
- 2 Press $\triangleleft \triangleright$ to select "FUNCTION SET UP", then press ∇ .
- 3 Press $\triangleleft \triangleright$ to select "VIDEO IN/OUT", then press ∇ .
- 4 Press $\triangle \nabla$ to select "MONITOR TYPE", then press **ENTER**.
- 5 Press $\triangle \nabla$ to select the desired option, then press **ENTER**.
- 6 Press **SET UP** to complete the setting.

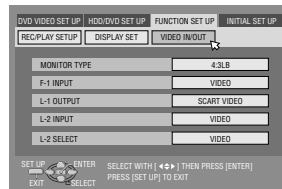

* The **boldface** settings below indicate the settings at your purchase.

■ MONITOR TYPE — **4:3LB** / 4:3PS / 16:9 AUTO / 16:9 FIX

4:3LB (Letter Box conversion): Select this when the aspect ratio of your TV is 4:3 (conventional TV). While viewing a wide screen picture, the black bars appear on the top and the bottom of the screen.

4:3PS (Pan&Scan): Select this when the aspect ratio of your TV is 4:3 (conventional TV). While viewing a wide screen picture, the black bars do not appear; however, the left and right edges of the pictures will not be shown on the screen.

16:9 AUTO (Wide television conversion): Select this when the aspect ratio of your TV is 16:9 (wide TV).

16:9 FIX (Wide television conversion): Select this when the aspect ratio of your TV is fixed to 16:9 (wide TV). The unit automatically adjusts the screen width of the output signal correctly when playing back a picture whose aspect ratio is 4:3.

Pan&Scan/Letter Box

In general, DVD VIDEO disc are produced for a wide-screen TV with 16:9 aspect ratio.

Material with this ratio will not fit to a TV with 4:3 aspect ratio. There are two styles to display the image, "Pan&Scan" (PS) and "Letter Box" (LB).

Pan&Scan

The right and left side of the image are cut off. The image fills the screen.

- The picture will be shown in the "4:3LB" mode depending on the disc even if the "4:3PS" mode is selected.



Letter Box

Black bands appear at the top and bottom of the image. The image itself appears in 16:9 aspect ratio.



Satellite Receiver Control Setting

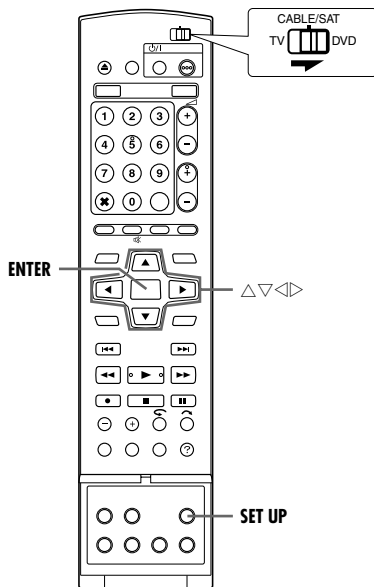
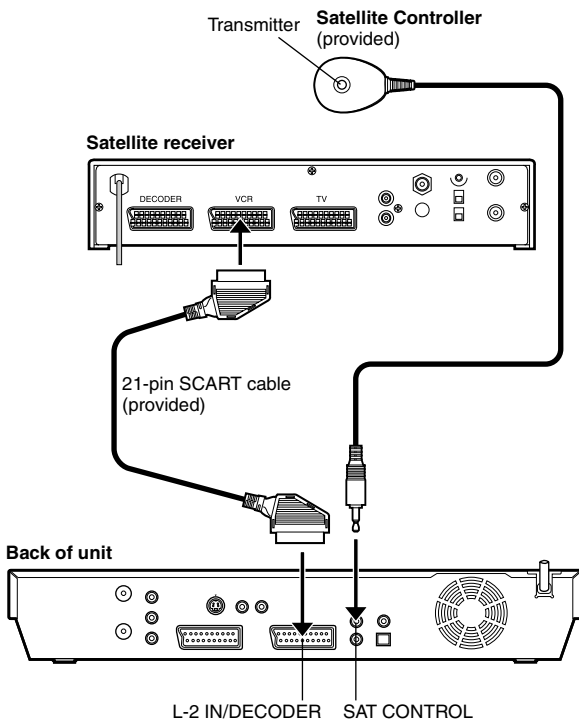
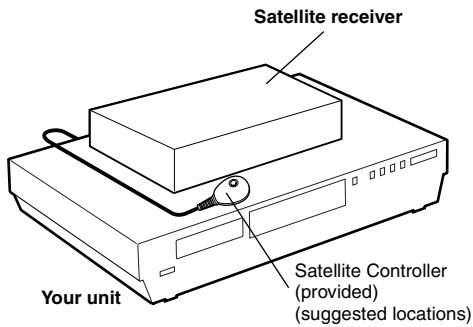

The following procedure is required if you receive satellite channels through a satellite receiver. Approximately 20 seconds before the SHOWVIEW timer programming (pg. 44) or Manual Timer programming (pg. 46) starts, the unit sets its input mode to "L-2" and automatically switches the satellite receiver's channels using the provided Satellite Controller.

Installing Satellite Controller

- 1 Place the Satellite Controller so that the path between its transmitter and the satellite receiver's remote sensor is unobstructed.
- 2 Fix securely using the adhesive strip attached on the back of the Satellite Controller.
- 3 Be sure to connect the unit's L-2 IN/DECODER connector to the satellite receiver's 21-pin SCART connector.

NOTE:

When connecting your satellite receiver, refer to its instruction manual.

- 4 Connect the Satellite Controller to the SAT CONTROL connector on the rear panel.

Setting Satellite Receiver's Brand And Channel

After installation, set the satellite receiver's brand and channel correctly; otherwise, the Satellite Controller cannot work correctly.

- Turn on the unit.
- Turn on the TV and select the AV mode.
- Slide the **TV/CABLE/SAT/DVD** switch to **DVD**.

- 1 Turn on the satellite receiver's power.
- 2 Press **SET UP** to access the Main Menu screen.
- 3 Press **◀▶** to select "INITIAL SET UP", then press **∇**.
- 4 Press **◀▶** to select "TUNER SET", then press **∇**.
- 5 Press **∇∇◀▶** to select "SAT CONTROL SET", then press **ENTER**.
- 6 Press **∇∇** to select "BRAND", then press **ENTER**.
- 7 Press **∇∇** to select the brand code from the list on page 24, then press **ENTER**.
 - If the unit is in playback or recording mode, you cannot set the brand code.
- 8 Press **∇∇** to select "PROGRAMME", then press **ENTER**.
- 9 Press **∇∇** to select one of the channel positions on the satellite receiver, then press **ENTER**.
 - You can select the channel position between 1 to 999.
- 10 Press **∇∇** to select "TEST", then press **ENTER**. The unit enters the Test mode.

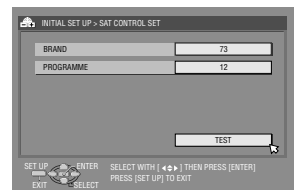
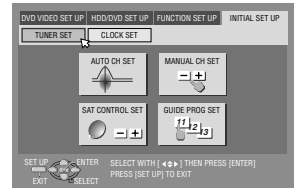

11 Check the result of the test.

If the satellite receiver's channel number has been changed to the same one as you set in step 9

Press <|> to select "YES", then press **ENTER** to finish the Sat Control Set mode.

If the satellite receiver's channel number has not been changed correctly

Press <|> to select "NO", then press **ENTER**. Then perform the procedure again from step 6.

BRAND NAME	CODE
JVC	73
AMSTRAD	60, 61, 62, 63, 92
ASTON	97
CANAL SATELLITE	81
CANAL +	81
D-BOX	85
ECHOSTAR (VIA DIGITAL)	82
FINLUX	68
FORCE	89
GALAXIS	88
GRUNDIG	64, 65, 102
HIRSCHMANN	64, 78, 99
HUMAX	88
ITT NOKIA	68
JERROLD	75
KATHREIN	70, 71, 96
LUXOR	68
MASCOM	93
MASPRO	70
NOKIA	87, 94
PACE	65, 67, 74, 86, 92, 97
PANASONIC	74, 92
PHILIPS	66, 84, 101
RADIX	78
RFT	69
SABA	97
SAGEM	83, 90
SALORA	68
SAMSUNG	83
SIEMENS	64
SKYMASTER	69, 98
TECHNISAT	66, 100
THOMSON	97
TPS	83
TRIAx	91
WISI	64

NOTES:

- The Satellite Controller may not work with all types of satellite receiver.
- For some satellite receivers, you need to set its channel input mode to 2-digit.
- If your satellite receiver has more than two channel modes, be sure to set to "All Channel Mode". For details, refer to the instruction manual of the satellite receiver.
- When selecting the satellite receiver's channel (☞ step 9), signals from the remote control may interfere with signals transmitted from the Satellite Controller. In this case, move the remote control as close to the unit's infrared beam receiving window as possible.

Basic Playback



- Turn on the unit.
- Turn on the TV and select the AV mode.
- Slide the TV/CABLE/SAT/DVD switch to DVD.

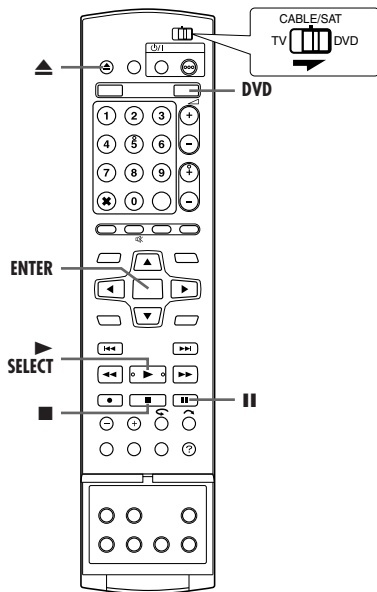
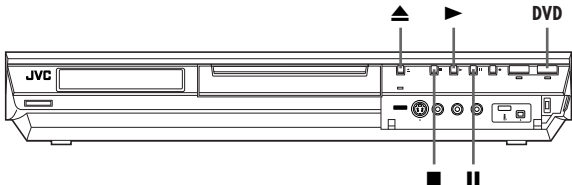

- ATTENTION:**
- It takes approximately 30 seconds to read a disc depending on the type and condition of the disc since this unit is multi-disc compatible (DVD-RAM, DVD-RW, DVD-R). It may even take several minutes when a disc is dirty, scratched or warped.
 - It may take a few seconds to start playback. This is not a malfunction.
 - Forward/reverse high-speed search and other operations cannot be performed while playback is stopped.

To play back an MP3/JPEG disc, see “Playback With MP3/WMA/JPEG Navigation” (pg. 55).

- 1 Load a disc.
 - For details, refer to “Placing A Disc” (pg. 8).
 - Pressing **▶** also closes the disc tray.
 - Playback begins automatically if an auto-playback DVD disc is loaded.
 - 2 Press **DVD** so that the DVD lamp lights up on the unit.
 - 3 Press **▶** to start playback.
 - If you load a DVD disc whose region code does not match the unit, “REGION CODE ERROR” appears on the TV screen. For details, refer to “Region Number” (pg. 6).
 - If “CAN NOT PLAY BACK DISC UNDER CURRENT SETTING” appears on the TV screen, refer to “Parental Lock” (pg. 34).
 - With Video CD/SVCD discs with PBC control or some DVD discs, the menu display may appear on the TV screen after starting playback. In this case, select an item which you want to play back from the menu. Otherwise, the playback cannot go forward. Refer to “Playback Control (PBC) Function” (pg. 29) or “Locating A Desired Scene Using The DVD Menu” (pg. 26).
 - The Library Database Navigation also enables you to search and select the desired titles. (pg. 50)
 - 4 Press **⏸** to pause playback.
 - To resume normal playback, press **▶**.
 - 5 Press **■** to stop playback.
 - When a recordable disc is played, playback stops and a programme received with the unit’s tuner resumes on the TV screen.
 - When a playback-only disc is played, playback stops and the still image at the time you press **■** remains on the TV screen. Pressing **■** again resumes a programme received with the unit’s tuner.
 - If **▲** is pressed during playback, playback stops, then the disc tray opens.
- NOTES:**
- When the Library Database Navigation screen appears, choose a thumbnail image of the desired title on the TV screen, then press **SELECT** (▶) or **ENTER**. (pg. 50)
 - It is not possible to playback the DVD disc recorded in 96 kHz on DVD during recording or Live Memory Playback on HDD.

Playback Features

- Turn on the unit.
- Turn on the TV and select the AV mode.
- Slide the **TV/CABLE/SAT/DVD** switch to **DVD**.
- Press **DVD** so that the DVD lamp lights up on the unit.

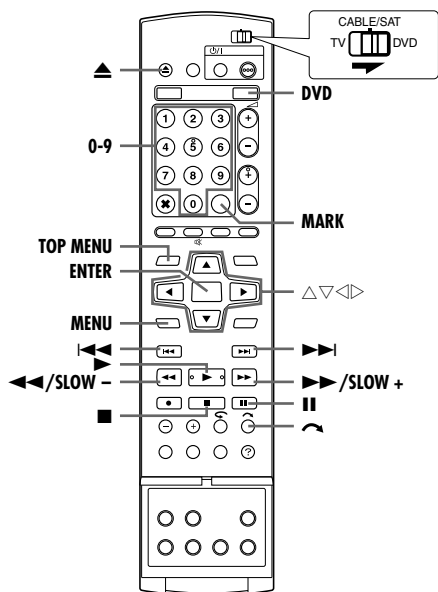

Locating A Desired Scene Using The DVD Menu



DVD VIDEO/finalised DVD-R/-RW (Video mode) discs may have top menu and disc menu.

Top menu

DVD discs generally have their own menus which show the disc contents. These menus contain various items such as titles of a movie, names of songs, or artist information. You can locate a desired scene by using the top menu displayed on the TV screen. Press **TOP MENU** to access the top menu.

Disc menu

Disc menus include playback data (angle menu, subtitle menu, etc.) specific to each title.

Press **MENU** to access the disc menu.

1 Press **TOP MENU** or **MENU** to access the DVD menu.

2 Press $\Delta \nabla \triangleleft \triangleright$ to select a desired title, then press **ENTER**. Playback starts.

- It may be possible to select the desired item using the **number keys** depending on the menu display.



Example:

NOTE:

When "0" appears on the TV screen in step 1, the disc does not have a top menu or disc menu.

Locating The Start Point Of The Item Or Skip The Item



Press $\triangleleft \triangleleft$ or $\triangleright \triangleright$ during playback.

- Pressing $\triangleright \triangleright$ locates the start point of the item or skips the item for forward direction, then resumes playback.
- Pressing $\triangleleft \triangleleft$ locates the start point of the item or skips the item for reverse direction, then resumes playback.

When a DVD-RAM/RW/R disc is played

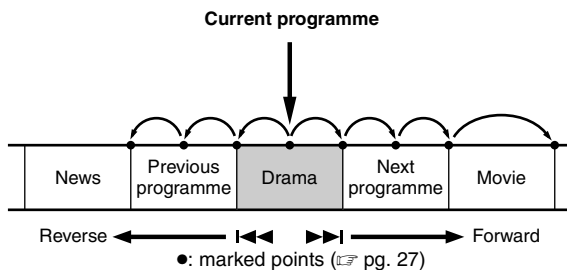

Example:

To locate the beginning of the next item, press $\triangleright \triangleright$ once.
To locate the beginning of the current item, press $\triangleleft \triangleleft$ once.
To locate the beginning of the previous item, press $\triangleleft \triangleleft$ three times.

When a DVD VIDEO, Audio CD or Video CD/SVCD disc is played

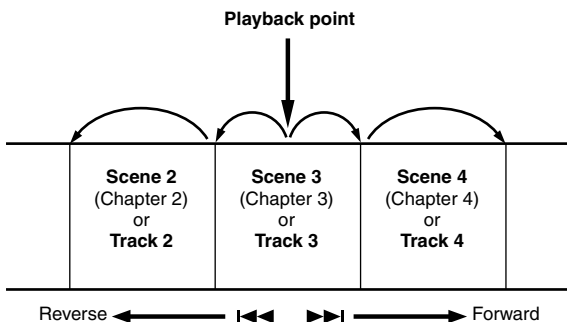

Example:

To locate the beginning of the next item, press $\triangleright \triangleright$ once.
To locate the beginning of the current item, press $\triangleleft \triangleleft$ once.

High-Speed Search



During playback, press $\triangleright \triangleright$ for forward high-speed search, or $\triangleleft \triangleleft$ for reverse high-speed search.

- Each press of the button increases the search speed for each direction.
- To resume normal playback, press \triangleright .

For Audio CD

You can perform 4 levels of speed search with $\triangleright \triangleright$ and $\triangleleft \triangleleft$. (Audio is active also during high-speed search.) You cannot perform slow motion for each direction.

Still Picture/Frame-By-Frame Playback



- 1 Press **II** to pause during playback.
- 2 Press **SLOW -** (◀◀) or **SLOW +** (▶▶) to activate frame-by-frame playback.
 - Each press of **SLOW -** (◀◀) or **SLOW +** (▶▶) advances/reverses the still picture frame by frame.
 - Frame-by-frame playback for reverse direction cannot be performed with Video CD/SVCD discs.
 - To resume normal playback, press ▶.

Slow Motion



- 1 Press **II** to pause during playback.
- 2 Press **SLOW -** (◀◀) or **SLOW +** (▶▶) for 2 or more seconds.
 - Each press of **SLOW -** (◀◀) or **SLOW +** (▶▶) increases the slow motion speed for each direction (from 1/16 to 1/2 times the normal speed).
 - Slow motion for reverse direction cannot be performed with Video CD/SVCD discs.

Skip Search





- During playback, press .
- Each press initiates an approximately 30-second period of fast-motion playback. Normal playback resumes automatically.

Resume Function



- It is possible to memorize the position where you stop playback and resume playback from that position.
- Be sure to set "RESUME" to "ON" or "DISC RESUME". (☞ pg. 68)
- 1 Press **■** during playback to memorize a resume point.
 - The unit enters Resume Stop mode and memorizes the position where you have stopped playback as a resume point. (The inside of the disc status indicator on the front display panel blinks while memorising.)
 - The unit retains a memory of the resume points of the last 30 discs played back, even though they have been ejected if "RESUME" is set to "DISC RESUME". (☞ pg. 68)
 - To clear the resume points: (The inside of the disc status indicator stops blinking and lights.)

When "RESUME" is set to "ON":

- Press  to turn off the unit.
- Press  to take out the disc.
- Press **■** in stop mode.
- Press **TOP MENU** to display the top menu, then start playback by selecting an item, etc.
- Press **MENU** to display the disc menu, then start playback by selecting an item, etc.

When "RESUME" is set to "DISC RESUME":

- Set "RESUME" to "OFF". (☞ pg. 68)
- Press **■** in stop mode.
- Press **TOP MENU** to display the top menu, then start playback by selecting an item, etc.
- Press **MENU** to display the disc menu, then start playback by selecting an item, etc.

- 2 Press **▶** in stop mode to resume playback. The unit starts playback from the resume point.

NOTES:

- "DISC RESUME" setting works on DVD VIDEO, VCD, SVCD and already finalised DVD-R/DVD-RW (video mode) discs. For other types of discs, the function under "ON" setting will be applied even if "RESUME" is set to "DISC RESUME". (☞ pg. 68)
- If you stop the playback of a disc for which a resume point has already been memorized, the memory will be updated with the new resume point.
- After the unit has memorized the resume points for 30 discs, remembering a new resume point will cause the unit to delete the oldest memorized point. Stopping playback of a disc for which a resume point is already stored may change the order in which the points are stored. This may potentially change the order in which points are deleted.
- When the unit memorizes a resume point for a disc, it also remembers audio language, subtitle and angle settings.
- This function may not work for some Video CD/SVCDs.
- When "RESUME" is changed to "ON" or "OFF" (☞ pg. 68), resume points of the discs memorized with "RESUME" set to "DISC RESUME" will be cleared.
- Resume points are memorized for each side of a double-sided disc.

Marking Positions To Play Back Again Later



It is possible to mark positions (up to 999 points) where you want to play back once again later, and start playback from a marked position. Marking onto DVD-RAM/RW/R discs when recording is helpful to locate a start point when you play back the discs later.

To mark positions:

- During playback, press **MARK** at positions you want to mark.
- "MARK" appears on the TV screen. You can easily locate the marked positions using **◀◀** or **▶▶** when you play back the disc.



To delete the marked positions:

- While paused, press **◀◀** or **▶▶** to locate a marked position you want to delete, then press **MARK**.
- Crossed "MARK" appears on the TV screen, and the marked position is deleted.



NOTES:

- When a monaural programme changes to a stereo programme while recording, a mark signal is automatically recorded.
- When a DVD-R/RW (Video mode) disc is finalised, marked points marked before finalising will be deleted, and programmes will be divided automatically into "chapters" approximately every 5 minutes. (☞ pg. 75)

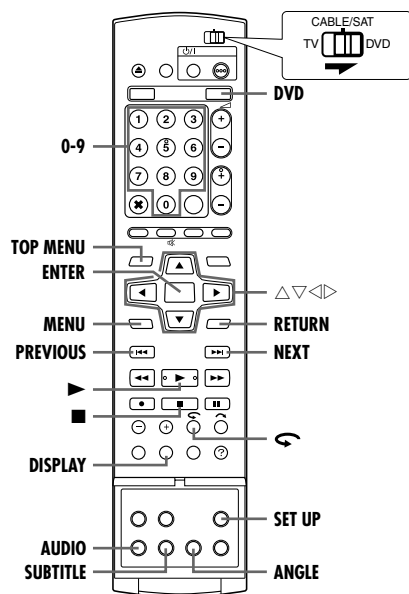

Checking The Time Information



You can check time information of a disc on the front display panel and the TV screen.

Each press of **DISPLAY** changes the display as follows:

■ DVD-RAM/DVD-R/DVD-RW

During recording

Clock time (front display panel only) → Current title elapsed time

→ Disc remaining time* → (back to the beginning)

* only discs before finalising

● Clock time is displayed only when a recordable disc is played back.

During playback

Each title elapsed time → Current title elapsed time →

Disc remaining time* → (back to the beginning)

* only discs before finalising

In stop mode or during playback

● In FR mode, it is possible to set recording time in detail using $\triangleleft \triangleright$.
(\rightarrow pg. 37)

● It is not possible to switch the recording mode during playback or while recording.

■ DVD VIDEO/Video CD/SVCD/Audio CD

During playback

Current track elapsed time → Current track remaining time → Total

elapsed time → Total remaining time → (back to the beginning)

In stop mode

0:00 → Playback time of track 1 → 0:00 → Total length of a disc →
(back to the beginning)

NOTE:

When a PBC-compatible Video CD/SVCD disc is loaded, deactivate the PBC function. (\rightarrow pg. 29)

Angle Selection



You can enjoy a variety of scene angles if a DVD VIDEO disc contains "multi-angle" parts, where the same scene was shot from different angles.

If the disc contains "multi-angle" parts, "ANGLE" appears on the TV screen at the beginning of the "multi-angle" part.

1 Press **ANGLE** during playback.

The angle selection display appears on the TV screen.



When 3 scene angles are contained.

2 Press **ANGLE** or $\triangleleft \triangleright$ to select your desired angle.

- Each time you press **ANGLE** or $\triangleleft \triangleright$, the angle changes.
- When "ANGLE" appears on the TV screen, the current scene is not recorded from multiple angles. In addition, some discs prohibit angle selection.
- To clear the angle selection display, press **ENTER**. In addition, the angle selection display disappears automatically if no operation is done for 10 seconds.

Subtitle Selection



Some DVD VIDEO discs contain more than one subtitle language, from among which you can choose the desired subtitle language. "SUBTITLE" appears on the TV screen at the beginning of the part where more than one subtitle language are recorded.

1 Press **SUBTITLE** during

playback. The subtitle selection display appears on the TV screen.



When 3 subtitle languages are contained.

● Each time you press **SUBTITLE**, the subtitle display is switched on and off.

2 Press $\triangleleft \triangleright$ to select your desired language.

● To clear the subtitle selection display, press **ENTER**.

NOTES:

- When "SUBTITLE" appears on the TV screen, no subtitle language is recorded.
- When the subtitle language won't be changed with the procedure above, change the subtitle on a disc menu displayed by pressing **MENU**.

Audio Language/Sound Selection



Some DVD VIDEO discs contain the multiple audio language or sound. You can select the desired audio language or sound. For some Video CD/SVCD discs, you can switch the audio channel to choose Karaoke either with or without the vocal.

1 Press **AUDIO** during playback. The Audio Language/Sound selection display appears.



When 3 audio languages are contained.

2 Press **AUDIO** or $\triangleleft \triangleright$ to select your desired audio language/sound.

- Each time you press **AUDIO** or $\triangleleft \triangleright$, the audio language/sound changes.
- To clear the Audio Language/Sound selection display, press **ENTER**.

NOTES:

- When "S" appears on the TV screen, no audio language is recorded.
- When the audio language won't be changed with the procedure above, change the audio on a disc menu displayed by pressing **MENU**.
- It is only possible to select the audio language in stop mode. The audio language cannot be selected during playback.

Audio Channel Selection



When watching bilingual programmes or playing discs on which you recorded bilingual or stereo programmes, you can choose the desired audio channel.

- When "SUPERIMPOSE" is set to "AUTO", you can confirm on the TV screen the audio channel you have chosen. (pg. 69)
- Each time you press **AUDIO**, the audio channel changes.



TRACK	USE
On-Screen Display	
	For main and sub audio of bilingual programme
	For main audio of bilingual programme
	For sub audio of bilingual programme
	For stereo discs
	For audio of left channel
	For audio of right channel

NOTE:

It is not possible for DVD-R/DVD-RW (Video mode) disc playback to switch the audio channel. The audio channel is played back as set in "VIDEO MODE RECORDING AUDIO" setting. (pg. 68)

When you can't switch the audio channel of a bilingual programme

When the unit is connected with a digital audio device using an optional optical cable and "DIGITAL AUDIO OUT" is set to "DOLBY DIGITAL/PCM", it is not possible to switch the audio channel of a bilingual programme recorded on a DVD-RAM or DVD-RW (VR mode) disc. (pg. 66) In this case, perform the following steps using the remote control to switch "DIGITAL AUDIO OUT" from "DOLBY DIGITAL/PCM" to "PCM ONLY".

- 1 Press **SET UP** to access the Main Menu screen.
- 2 Press $\triangleleft \triangleright$ to select "DVD VIDEO SET UP", then press ∇ .
- 3 Press $\triangleleft \triangleright$ to select "AUDIO OUTPUT", then press ∇ .
- 4 Press $\triangle \nabla$ to select "DIGITAL AUDIO OUT", then press **ENTER**.
- 5 Press $\triangle \nabla$ to select "PCM ONLY", then press **ENTER**. (pg. 67)
- 6 Press **SET UP** to complete the setting.
- 7 Press **AUDIO** to select the desired audio channel.

Playback Control (PBC) Function



Some Video CD/SVCD discs support the PBC function. PBC is an abbreviation of "Play Back Control". A Video CD/SVCD disc recorded with PBC has its own menus, such as a list of the songs on the disc. You can locate a specific scene by using the menu.

- 1 Press \blacktriangleright in stop mode. The PBC menu appears.
- 2 Press the **number keys** to enter the number of the desired scene. The unit starts playback of the selected item.
 - "PBC" appears on the front display panel.
 - When "NEXT" or "PREVIOUS" appears on the TV screen: Pressing **NEXT** ($\blacktriangleright \blacktriangleright$) advances to the next page. Pressing **PREVIOUS** ($\blacktriangleleft \blacktriangleleft$) returns to the previous page.
 - You can return to the menu by pressing **RETURN**.
 - The method of the operation is different depending on the disc.

NOTES:

- If you want to playback a PBC-compatible Video CD/SVCD disc without activating the PBC function, start playback in stop mode by using the **number keys**, instead of the \blacktriangleright button, to choose the track, then press **ENTER**.
- To activate the PBC function when a PBC-compatible Video CD/SVCD disc is being played back without the PBC function, press **TOP MENU**, or press \blacksquare then press \blacktriangleright .

To Move Back The Playback Position Slightly (One Touch Replay Function)



You can move back the playback position slightly.

- 1 Press \curvearrowright .
 - Each press skips back for approximately 7 seconds and resumes playback.
 - Pressing while paused skips back for approximately 7 seconds and resumes pause.

Using The On-screen Bar



The on-screen bar allows you to control various playback functions. Some of the functions operated on Navigation Menu can be controlled on the On-screen bar.

ATTENTION:
The on-screen bar can also be used for the HDD deck.

Be sure to clear Library Database Navigation screen by pressing **NAVIGATION**.

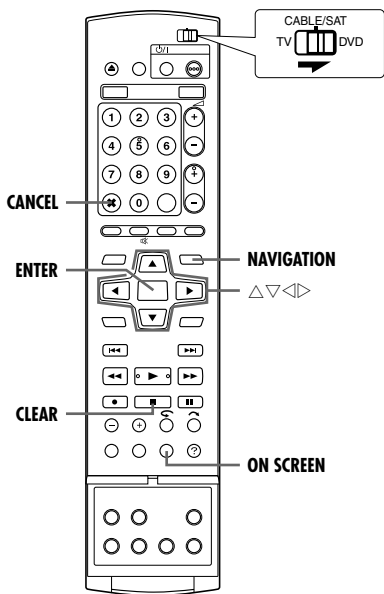

- 1 Disc type.
- 2 Select this for Repeat Playback. (pg. 31)
- 3 Select this for A-B Repeat Playback. (pg. 31)
- 4 Select this for search function. (pg. 31)
- 5 Select this for time search function. (pg. 32)
- 6 Select this to switch Simulated Surround Effect function. (pg. 32)
- 7 Select this for Picture Control function. (pg. 32)
- 8 Select this to switch picture source type. (pg. 33)
- 9 Current status area for the selected item.
- 10 Select this for Programme Playback. (pg. 33)
- 11 Select this for Random Playback. (pg. 33)
- 12 Select this to control the switching interval of the slide show. (pg. 33)

NOTE:

Although examples of the on-screen bar are provided here only for 3 types of discs, the on-screen bar will be displayed for whichever disc indicated in the left column.

Basic Operation On The On-screen Bar

Example: When selecting Picture Control function of DVD

During playback or while stopped

1 Press **ON SCREEN** twice to access the on-screen bar. The item currently selected is highlighted and pointed by

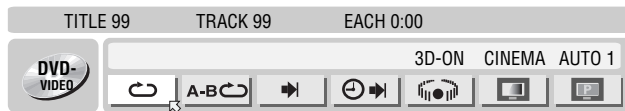

2 Press to select "Picture Control", then press **ENTER**. The pop-up window appears under the selected item.

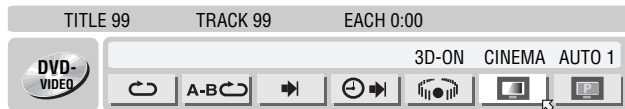

3 Press to select the desired option, then press **ENTER**.

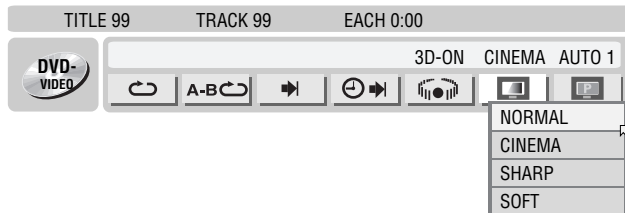

How To Access The On-screen Bar

1 Press **ON SCREEN** twice whenever a disc is loaded.

Contents of the on-screen bar during playback

DVD VIDEO

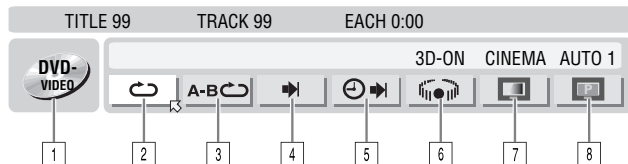

Video CD/SVCD

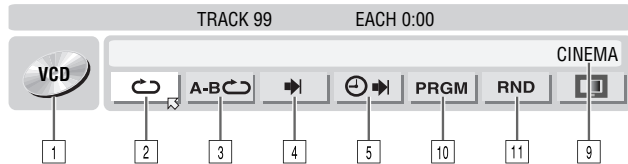

JPEG disc

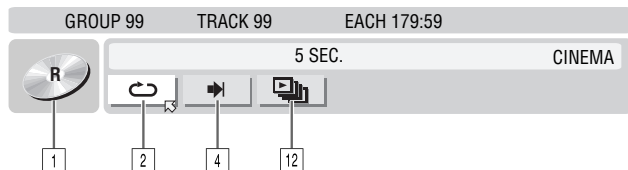

To clear the on-screen bar

Press **ON SCREEN**.

NOTE:

See the corresponding pages for details on each menu item.

Repeat Playback



You can repeat playback as you like according to the type of disc.

- 1 Press **ON SCREEN** twice to access the on-screen bar.
- 2 Press $\triangleleft \triangleright$ to select " \curvearrowright ", then press **ENTER**. The pop-up window appears under the selected item.

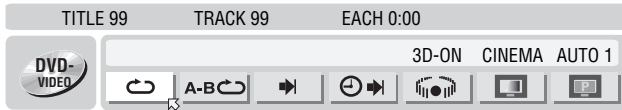

- 3 Press $\triangle \nabla$ repeatedly to select the desired Repeat mode, then press **ENTER**.

DVD-RAM/RW/R

OFF: Repeat playback is not performed.

ALL REPEAT: The whole disc is played back repeatedly.

TITLE REPEAT: The current title is played back repeatedly.

DVD VIDEO

OFF: Repeat playback is not performed.

TITLE REPEAT: The current title is played back repeatedly.

CHAPTER REPEAT: The current chapter is played back repeatedly.

Audio CD/Video CD/SVCD/JPEG/MP3

OFF: Repeat playback is not performed.

ALL REPEAT: The whole disc is played back repeatedly.

GROUP REPEAT*: The current group is played back repeatedly.

TRACK REPEAT*: The current track is played back repeatedly.

* "GROUP REPEAT" cannot be selected for Audio CD and Video CD/SVCD discs.

* "TRACK REPEAT" cannot be selected for JPEG discs.

To clear the on-screen bar

Press **ON SCREEN**.

To cancel Repeat Playback

Repeat the above procedure from step 1, select "OFF" in step 3, then press **ENTER**.

NOTES:

- Repeat Playback is not possible for a Video CD/SVCD with PBC function.
- Repeat Playback may not work properly depending on the type of the disc being used.

A-B Repeat Playback



You can repeat the desired part.

During playback

- 1 Press **ON SCREEN** twice to access the on-screen bar.
- 2 Press $\triangleleft \triangleright$ to select " \curvearrowright ".
- 3 Press **ENTER** at the beginning of the desired part you want to repeat (point A). The elapsed playing time of the point A appears.

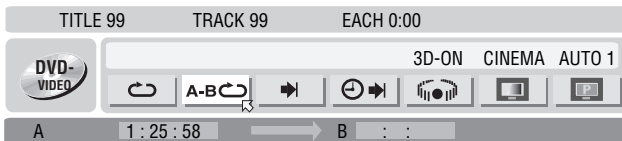

- 4 Press **ENTER** at the end of the desired part you want to repeat (point B). The elapsed playing time of the point B appears.

- The selected part of the disc (between point A and B) is played repeatedly.

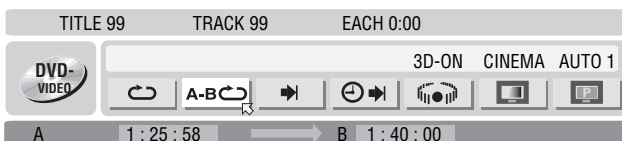

To clear the on-screen bar

Press **ON SCREEN**.

To cancel A-B Repeat Playback

Press $\triangleleft \triangleright$ to select " \curvearrowright ", then press **ENTER**.

NOTES:

- A-B Repeat Playback may not work properly depending on the type of disc being used.
- The subtitles recorded around the A-B point may not appear.
- When the end of the item is reached before the end point is set, the on-screen bar disappears from the TV screen. In such a case, repeat the procedure from step 1.
- The point B must be set at least 3 seconds after the point A.
- When playing back a DVD, A-B Repeat Playback is possible only within the same title.
- " \curvearrowright " cannot be selected during Programme and Random Playback.
- " \curvearrowright " cannot be selected while stopped.

Locating The Beginning Of A Desired Selection



You can locate the beginning of a title, chapter, group or track.

During playback or while stopped

- 1 Press **ON SCREEN** twice to access the on-screen bar.
 - 2 Press $\triangleleft \triangleright$ to select " \blacktriangleright ", then press **ENTER**.
 - 3 Press $\triangle \nabla$ to select the desired item, then press **ENTER**.
- Skip this step for Video CD/SVCD and Audio CD.

For DVD-RAM/RW/R, DVD VIDEO

"TITLE SEARCH" or "CHAPTER SEARCH" is selectable. ("TITLE SEARCH" only is selectable while stopped.)

For JPEG, MP3

"GROUP SEARCH" or "TRACK SEARCH" is selectable.

For Video CD/SVCD, Audio CD

"TRACK" is selectable.

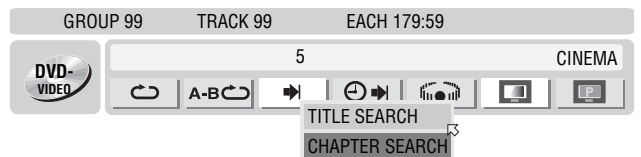

- 4 Press the **number keys** to enter the desired item number, then press **ENTER**.

- Playback starts from the selected section.

Examples:

- 1 To select track 5, press the **number key "5"**.
- 2 To select track 15, press the **number key "1"** and "**5"**.
- 3 To select track 25, press the **number key "2"**, then "**5"**.

If you have specified a wrong selection

Press **CANCEL (X)** or **CLEAR (■)** to clear the wrong number, then enter the correct one before you press **ENTER** in this step.

To clear the on-screen bar

Press **ON SCREEN**.

NOTES:

- When " \odot " is displayed on the TV screen in step 4, the chapter you have selected is not contained in the disc, or chapter search does not work on the disc.
- Before you press **ENTER**, playback may start automatically when you enter the section's number depending on the disc.
- This function is not possible for a Video CD/SVCD with PBC function.

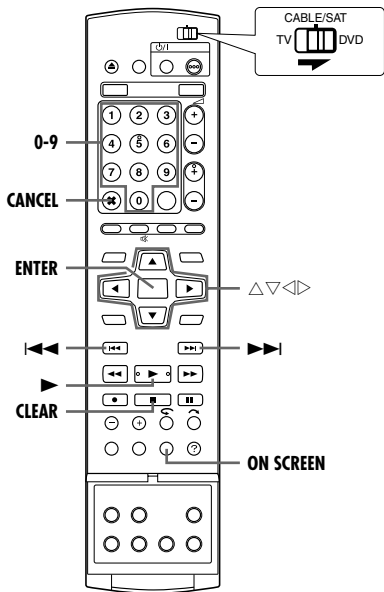

Time Search



You can play back a disc from the desired point by specifying the elapsed playing time from the beginning of a programme (DVD-RAM, DVD-R, DVD-RW, DVD VIDEO and HDD) or a disc (Video CD/SVCD and Audio CD).

- 1 Press **ON SCREEN** twice to access the on-screen bar.
- 2 Press $\triangleleft \triangleright$ to select “⌚▶”, then press **ENTER**. The pop-up window appears under the selected item.

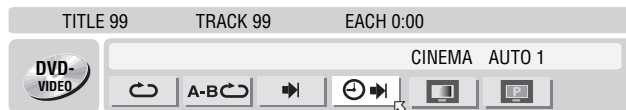

- 3 Press the **number keys** to enter the time, then press **ENTER**. Playback starts from the specified time.

Example:
To play back from a point 12 (minutes): 50 (seconds) elapsed.

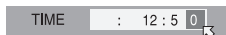

If you have specified a wrong selection,
Press **CANCEL** (X) (for the last entered number) or **CLEAR** (■) (for whole numbers) to clear the wrong number, then enter the correct one(s) before you press **ENTER** in this step.

To clear the on-screen bar
Press **ON SCREEN**.

- NOTES:**
- When “⌚” is displayed on the TV screen in step 3, you have selected a point that exceeds the recording time of the disc.
 - Some DVD VIDEO discs do not contain time information, and it is not possible to use the Time Search function. In such cases, “⌚” is displayed on the TV screen as well.
 - This function is not possible for a Video CD/SVCD with PBC function.

Simulated Surround Effect



It is possible to get a simulated surround effect from your stereo system. You can enjoy the virtual surround sound with your 2-channel stereo system.

- 1 Press **ON SCREEN** twice to access the on-screen bar.
- 2 Press $\triangleleft \triangleright$ to select “⌚▶”, then press **ENTER**.
 - Above the selected item, “3D-ON” appears and Simulated Surround Effect is activated.
 - Each time you press **ENTER**, “3D-ON” appears and disappears alternately.

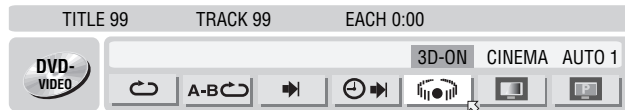

To clear the on-screen bar
Press **ON SCREEN**.

To cancel the simulated surround effect
Press **ENTER** to clear “3D-ON” from the screen.

- NOTES:**
- Simulated Surround Effect works correctly only when playing back a title recorded in multichannels.
 - Simulated Surround Effect does not affect the DVD VIDEO bitstream signal from the DIGITAL OUT connectors.
 - When Simulated Surround Effect is activated, the settings of “ANALOG AUDIO OUT” and “D. RANGE CONTROL” are disabled. (pg. 67)

Adjusting The Picture Quality



You can obtain optimal picture quality by selecting an appropriate picture mode.

- 1 Press **ON SCREEN** twice to access the on-screen bar.
- 2 Press $\triangleleft \triangleright$ to select “🖥️”, then press **ENTER**. The pop-up window appears under the selected item.

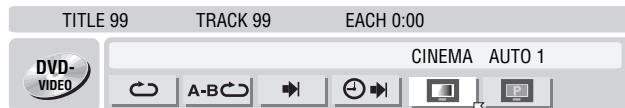

- 3 Press $\triangle \nabla$ to select the desired option, then press **ENTER**.

NORMAL: Normally select this option.
CINEMA: Suitable for a movie disc, etc.
SHARP: Clearer, sharper-edged picture when viewing images with lots of flat, same-coloured surfaces such as cartoons.
SOFT: Select this option when too much noise appears.

To clear the on-screen bar
Press **ON SCREEN**.

Setting The Progressive Mode



You can obtain optimal picture quality by selecting whether the content on the disc is processed by field (video source) or by frame (film source).

- 1 Press **ON SCREEN** twice to access the on-screen bar.
- 2 Press $\triangleleft \triangleright$ to select "PRGM", then press **ENTER**. The pop-up window appears under the selected item.

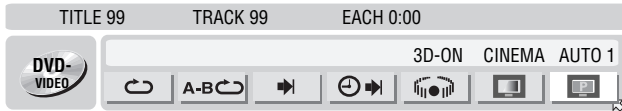

- 3 Press $\triangle \nabla$ to select the desired option, then press **ENTER**.

AUTO 1: Used to play a disc containing both video and film source materials. This system recognizes the source type (video or film) of the current disc according to the disc information. Normally select this option.

AUTO 2: Almost the same as the "AUTO 1", but the processing of the scenes with movement is different. Select "AUTO 1" or "AUTO 2" to your preference.

FILM: Suitable for playing back a progressive scanned film source disc.

VIDEO: Suitable for playing back a video source disc. The outlines on the played back pictures will be soft.

To clear the on-screen bar

Press **ON SCREEN**.

NOTE:

When the progressive mode is set, be sure to set "L-1 OUTPUT" to "COMPONENT". (pg. 61) Progressive scan is output only from COMPONENT VIDEO OUT connector.

Programme Playback



You can programme up to 30 tracks (Video CD/SVCD or Audio CD) to play back in the desired order.

While stopped

- 1 Press **ON SCREEN** twice to access the on-screen bar.
- 2 Press $\triangleleft \triangleright$ to select "PRGM", then press **ENTER**. The programme table appears under on-screen bar.

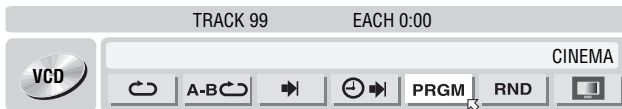

- 3 Press the **number keys** to enter the track numbers in the desired order.

Examples:

- 1 To select track 5, press the **number key "5"** and **ENTER**.
- 2 To select track 15, press the **number key "1"** and **"5"**.
- 3 To select track 25, press the **number key "2"** and **"5"**.



If you have specified a wrong selection

Press **CANCEL (X)**. The last selection is erased.

Or press **CLEAR (■)**. The whole selection is erased.

- 4 Press **▶**. Playback starts in the programmed order.

- When all of the programmed tracks have been played back, Programme Playback stops, but the programmed information remains.
- To add tracks to the end of the programme, perform steps 1 through 3.
- During Programme Playback, pressing **▶▶** skips to the next selection of the programme. Pressing **◀◀** returns to the beginning of the current selection.

To clear the on-screen bar and the contents of the programme
Press **ON SCREEN**.

To cancel Programme Playback

Press $\triangleleft \triangleright$ to select "PRGM", then press **ENTER**.

NOTE:

Programme Playback is not possible depending on the type of disc.

Random Playback



You can play back all the tracks on the disc in random order.

While stopped

- 1 Press **ON SCREEN** twice to access the on-screen bar.
- 2 Press $\triangleleft \triangleright$ to select "RND", then press **ENTER**. Playback starts in random order.

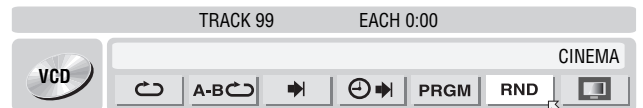

To clear the on-screen bar

Press **ON SCREEN**.

To cancel Random Playback

Perform steps 1 and 2.

NOTE:

The same track will not be played back more than once during Random Playback.

Select The Switching Interval Of The Slide Show



You can control the switching interval of the slide show.

- 1 Press **ON SCREEN** twice to access the on-screen bar.
- 2 Press $\triangleleft \triangleright$ to select "5 SEC.", then press **ENTER**. The pop-up window appears under the selected item.

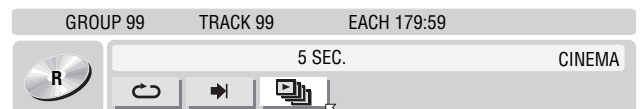

- 3 Press $\triangle \nabla$ to select the desired option, then press **ENTER**.

- Each time you press $\triangle \nabla$, the interval changes as follows:
5 SEC. ↔ 10 SEC. ↔ 15 SEC. ↔ 20 SEC. ↔ 25 SEC. ↔ 30 SEC. ↔ (Back to the beginning)

To clear the on-screen bar

Press **ON SCREEN**.

Parental Lock



This function restricts playback of DVD VIDEO discs which contain violent (and other) scenes according to the level set by the user. For example, if a movie which includes violent scenes supports the parental lock feature, such scenes which you do not want to let children view can be cut or replaced by other scenes.

- Turn on the unit.
- Turn on the TV and select the AV mode.
- Slide the **TV/CABLE/SAT/DVD** switch to **DVD**.
- Press **DVD** so that the DVD lamp lights up on the unit.

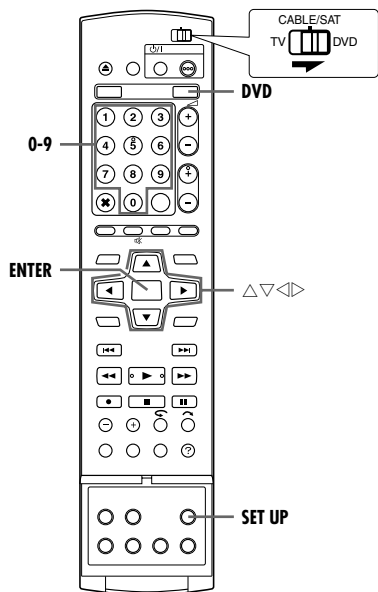

To Set Parental Lock For The First Time

While stopped

- 1 Press **SET UP** to access the Main Menu screen.
- 2 Press $\triangleleft \triangleright$ to select "DVD VIDEO SET UP", then press ∇ .
- 3 Press $\triangleleft \triangleright$ to select "PARENTAL LOCK", then press ∇ .

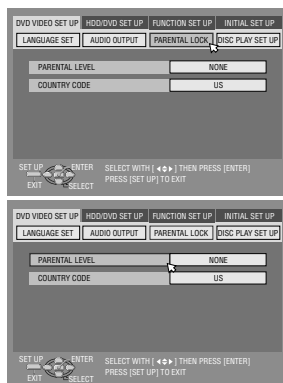

- 4 Press $\triangle \nabla$ to select "PARENTAL LEVEL", then press **ENTER**.
- 5 Press $\triangle \nabla$ to select the desired level, then press **ENTER**.
 - The smaller the value of level is, the more restrictive the Parental Lock level becomes.
 - Select "NONE" to cancel the restriction.

- 6 Press the **number keys** to enter your desired four-digit number, then press **ENTER**.
 - If you made a mistake, enter a correct number again.
- 7 Press $\triangle \nabla$ to select "COUNTRY CODE", then press **ENTER**.
- 8 Press $\triangle \nabla$ to select your country code, then press **ENTER**.
 - If you do not need to change your country code, jump to 10.
 - See "Country/Area Code List for Parental Lock" (pg. 83).

9 Press the **number keys** to enter the same password as in step 6 above, then press **ENTER**.

10 Press **SET UP** to complete the setting.

NOTE:

Remember your password, or make a note of it.

To Change The Settings

You can change the Parental Lock settings later.

1 Perform steps 1 to 3 of "To Set Parental Lock For The First Time" to access the "PARENTAL LOCK" screen before continuing.

To change the level

2 Press $\triangle \nabla$ to select "PARENTAL LEVEL", then press **ENTER**.

3 Press $\triangle \nabla$ to select the desired level, then press **ENTER**.

To change the country code

4 Press $\triangle \nabla$ to select "COUNTRY CODE", then press **ENTER**.

5 Press $\triangle \nabla$ to select your country code, then press **ENTER**.

- See "Country/Area Code List for Parental Lock" (pg. 83).

6 Press the **number keys** to enter the same password as in step 6 of "To Set Parental Lock For The First Time", then press **ENTER**.

7 Press **SET UP** twice to complete the setting.

NOTE:

If you forget your password, enter "8888" in step 6.

To Temporarily Release Parental Lock

When you set the Parental Lock level strictly, some discs may not be played back at all. When you insert such a disc and try to play it back, the confirmation screen appears on the TV screen, asking you whether you want Parental Lock to be temporarily released or not.

1 Load a disc.

- If the disc is rated higher than the selected level, the confirmation screen appears.

2 Press $\triangleleft \triangleright$ to select "YES", then press **ENTER**.

- If you select "NO", you cannot play back that disc.

3 Press the **number keys** to enter the same password as in step 6 of "To Set Parental Lock For The First Time", then press **ENTER**.

- When you enter the correct password, the Parental Lock is released and the unit starts playback.

- If you enter a wrong password, "ENTRY ERROR" appears on the TV screen. Enter the correct password.

- If you have successively entered wrong password three times, "ENTRY ERROR CAN NOT CHANGE PASSWORD" appears on the TV screen. In such a case, press **ENTER**. The disc will stop. Then play back the disc again, and try the procedure again from step 1.

NOTE:

If you forget your password, enter "8888" in step 3.

Basic Recording



- Turn on the unit.
- Turn on the TV and select the AV mode.
- Slide the TV/CABLE/SAT/DVD switch to DVD.

ATTENTION:
It is not possible to record programmes on a DVD-R disc which has already been finalised.

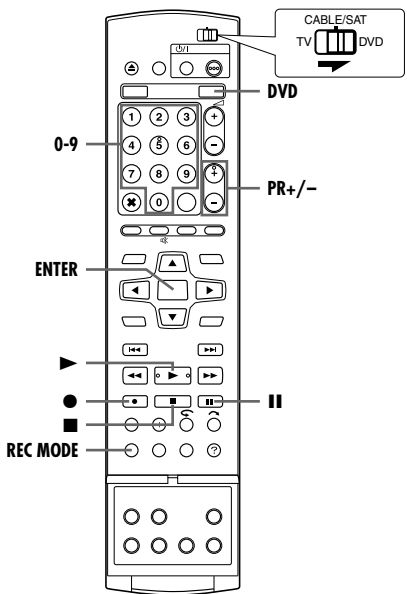
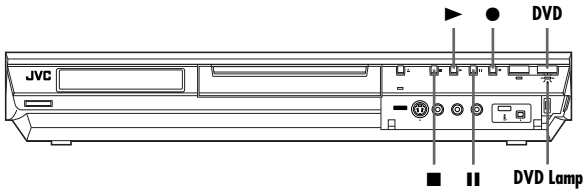

- 1 Load a recordable disc.
 - For details, refer to "Placing A Disc" (pg. 8).
- 2 Press **DVD** so that the DVD lamp lights up on the unit.
- 3 Press **PR +/-** or the **number keys** to select the channel you wish to record.
- 4 Press **REC MODE** repeatedly to select the recording mode, then press **ENTER**.
 - Each time you press **REC MODE**, the recording mode changes as follows:
 XP → SP → LP → EP → FR60-FR360* → FR420, FR480 →
 (Back to the beginning)
 - * The value is selectable from 1 to 6 hours in 5-min. increment by pressing **<|>** repeatedly after selecting "FR60-FR360". To change the value in 30-min. increments, press and hold **<|>**.
 - For details on the recording mode, see the right column.
- 5 Press **●** on the unit to start recording. Or press and hold **●** and press **▶** on the remote control.
- 6 Press **●** and **||** simultaneously to pause recording.
 - To resume recording, press **●** and **▶** simultaneously.
- 7 Press **■** twice to stop recording.
 - It takes about 10 seconds to end the writing session when you stop recording.

- NOTES:**
- It is recommended to format a DVD-RAM disc before use if you use the disc on this unit for the first time.
 - When using a brand-new DVD-RW disc, format the disc either in VR mode or in Video mode. (pg. 74)
 - Recordings made on DVD-R/RW disc must be finalised to play back on other DVD players. Perform "Finalise A Disc (DVD Deck Only)" (pg. 75).
 - You can record up to 99 programmes and 999 play lists on each disc.
 - Some programmes can only be recorded one time.
 - When recording is started, an index of the first part of recording is automatically recorded. (pg. 49) To record satellite programmes, refer to page 48. To delete the index, refer to page 51.
 - Recording sometimes may stop or cannot be performed even if there is enough available capacity remaining on the disc.
 - It is not possible to record both on DVD and on HDD simultaneously.

Recording Mode
MPEG2 format is used as recording format. As a guide for picture quality, the "bps" unit is used to represent how much data can be recorded per second. The larger this value is, the better the picture quality becomes but more capacity is required for the recording. Select XP or SP for programmes where quick movement occurs, such as sports programmes, and LP or EP for talk shows, etc. with relatively less movement.

The recording modes for a 4.7 GB disc are set as follows:

Recording mode	Recording amount (approx.)	Maximum recording time (approx.)
XP	10 Mbps	1 hour
SP	5 Mbps	2 hours
LP	2 Mbps	4 hours
EP	1.6 Mbps	6 hours
FR60-FR360 (pg. 37)	The amount varies depending on the selected time.	1 - 6 hours
FR420		7 hours
FR480		8 hours

- For details on FR mode, refer to "Free Rate Function" (pg. 37).

Recording Resume Function

If there is a power outage during recording, Instant Timer Recording (ITR) (pg. 36) or timer recording (pg. 44, 46), the recording will resume automatically when power is restored to the unit unless the unit's memory backup has expired.

Recording Features



- Turn on the unit.
- Turn on the TV and select the AV mode.
- Slide the **TV/CABLE/SAT/DVD** switch to **DVD**.
- Press **DVD** so that the DVD lamp lights up on the unit.

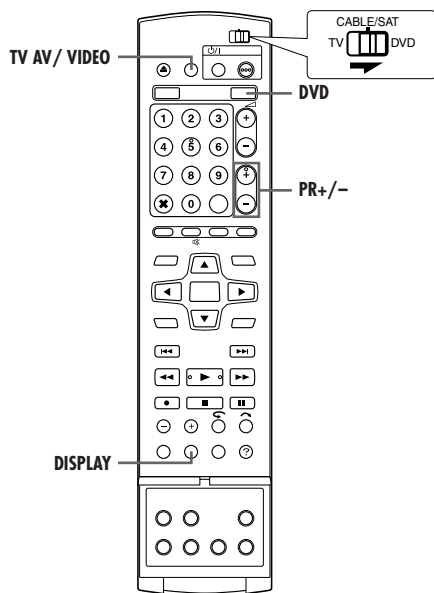
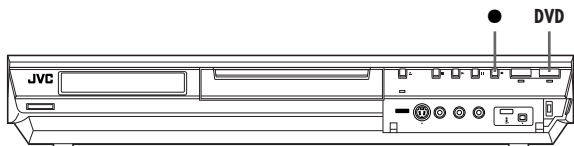

Instant Timer Recording (ITR)

This easy method lets you record for from 30 minutes to 6 hours (selectable in 30-min. increments), and shuts the unit off after recording is finished.

- 1 Press **●** on the unit to start recording.
- 2 Press **●** again to engage the ITR mode.
 - On the front display panel, "0:30" appears.
- 3 If you want to record for more than 30 minutes, press **●** to extend the time. Each press extends recording time by 30 minutes.

NOTES:

- You can only perform ITR using the **●** button on the unit.
- If "DIRECT REC" is set to "ON" in the menu, Instant Timer Recording (ITR) function does not work. (☞ pg. 68)
- When the recording capacity becomes full during timer recording or Instant Timer Recording, the unit automatically performs "Relief Recording" (☞ pg. 46).

Watch Another Programme While Recording On The Unit

While recording is going on, you can watch another programme on the TV by using the TV's tuner.

NOTE:

It is required that the remote control is set to be able to operate the TV in advance. (☞ pg. 63)

- 1 During recording, press **TV AV/VIDEO** to select TV mode.
 - Video mode is disengaged and the video lamp (VIDEO) on the unit is turned off.
 - The programme received on the TV's tuner is displayed on the TV screen.

2 Slide the **TV/CABLE/SAT/DVD** switch to **TV**.

3 Press **PR +/-** repeatedly to select the desired channel.

NOTE:

If a decoder is connected to the unit (☞ pg. 66), you can select a scrambled channel as well as other normal channels.

Elapsed Recording Time And Disc Remaining Time Indication

During recording, press **DISPLAY** repeatedly until the desired indication appears on the front display panel.

- Each time you press **DISPLAY**, the time indication changes as follows:
Elapsed recording time → Disc remaining time → Clock → (Back to the beginning)

Free Rate Function

To record the entire programme, the unit automatically sets the appropriate recording mode depending on the combination of the total time of the programme to be recorded and either the remaining disc space or the specified recording time (from 60 minutes to 480 minutes).

■ **To record the entire programme within the actual remaining disc space (DVD deck only)**

Select "FR (JUST)" in a recording mode selection procedure.

- Note that this function is available only for timer programming recording (☞ pg. 44, 46) and dubbing from HDD to DVD (☞ pg. 56).

■ **To record the entire programme by specifying the desired recording time**

Select "FR60–FR360", "FR420" or "FR480" in a recording mode selection procedure. (☞ pg. 35, 38, 44, 46)

■ **To record a 25-min. long daily programme five times just on the same DVD disc for example**

Perform "ShowView™ Timer Programming" (☞ pg. 44) procedure. Be sure to set the recording mode to "FR125" and set Weekly/Daily Rec Function to "MON–FRI" in step 8 to fit the total recording time to the whole disc space.

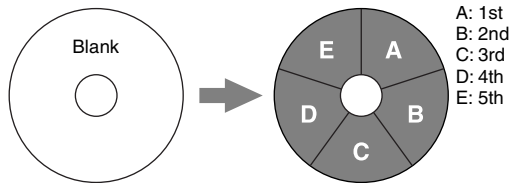

When the same programme is recorded in SP mode instead of in "FR125", the 5th programme cannot be recorded.

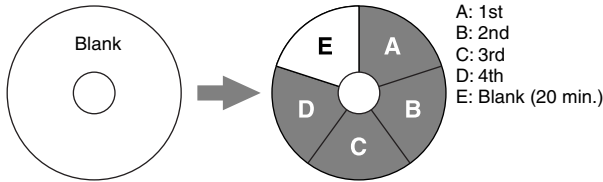

NOTES:

- You can programme this unit to timer-record, regardless of the disc remaining time. When the disc remaining time is not enough, the unit performs "Relief Recording" (☞ pg. 46). To avoid this, make sure of the disc remaining time before setting timer-programming. **(Example)** If you programmed to timer-record for 60 minutes in SP mode on a 120-minute disc, the disc remaining time would be 30 minutes in XP mode, 60 minutes in SP mode, 120 minutes in LP mode, 180 minutes in EP mode, and 240 minutes in FR480 mode. Timer-recording will not complete beyond these remaining times.
- The maximum recording time of FR (JUST) mode is the same as the recording time of FR480 mode. When timer-programming a long programme in FR (JUST) mode on a disc whose remaining time is short, it is recommended checking the disc remaining time in FR480 mode to see if the remaining time is enough for the programme.
- Even if more than one programme are timer-programmed in FR (JUST) mode, only the first one is recorded.
- In order to ensure that the recording fits on the disc, this feature may leave a slight non-recorded section at the end of the disc.
- There may be some noise and sound disturbance at the point on the disc where the unit switches the mode.

Receiving Stereo And Bilingual Programmes

Your unit is equipped with a Sound-Multiplex decoder (A2) and a Digital stereo sound decoder (NICAM) making reception of stereo and bilingual broadcasts possible.

When the channel is changed, the type of broadcast being received will be displayed on the TV screen for a few seconds.

Type of Broadcast Being Received	On-screen Display
A2 Stereo	
A2 Bilingual	
Regular Monaural	
NICAM Stereo	
NICAM Bilingual	
NICAM Monaural	

NOTES:

- "SUPERIMPOSE" must be set to "AUTO". Otherwise the on-screen displays will not appear. (☞ pg. 69)
- If the quality of stereo sound being received is poor, the broadcast might be received in monaural with better quality.

Selection Of The Audio Channel To Be Recorded On A Disc

When a programme is recorded on a DVD-RAM or DVD-RW disc in VR mode, all audio channels of the receiving programme are recorded on the disc. When you record a programme on a DVD-R or DVD-RW disc in video mode, select the desired audio channel ("NICAM" or "MONO") to be recorded on the disc. (☞ pg. 68)

NOTE:

Before playing back a programme recorded in stereo, or a bilingual programme, refer to "Audio Channel Selection" on page 29.

Basic Recording

- Turn on the unit.
- Turn on the TV and select the AV mode.
- Slide the **TV/CABLE/SAT/DVD** switch to **DVD**.

ATTENTION:

The HDD on the unit requires approximately 20 seconds to start up after the unit has been turned on, during which no operation can be made.

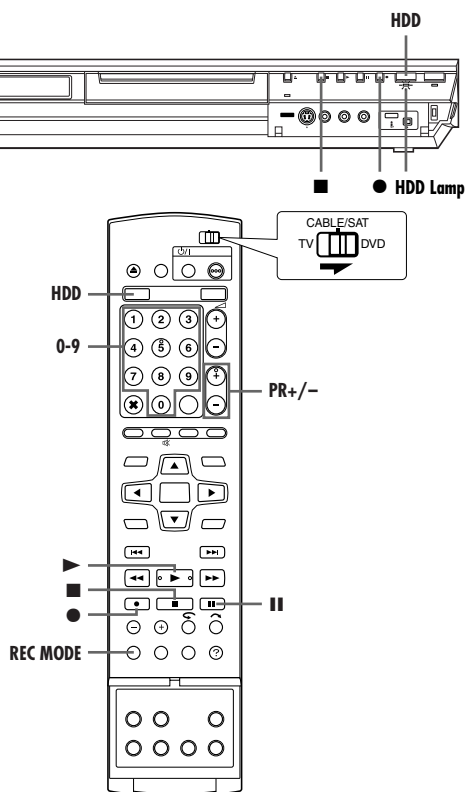

- 1 Press **HDD** so that the HDD lamp lights up on the unit.
- 2 Press **PR +/-** or the **number keys** to select the channel you wish to record.
- 3 Press **REC MODE** repeatedly to select the recording mode, then press **ENTER**.
 - Each time you press **REC MODE**, the recording mode changes as follows:
 XP → SP → LP → EP → FR60–FR360* → FR420, FR480 →
 (Back to the beginning)
 - * The value is selectable from 1 to 6 hours in 5-min. increment by pressing **<D>** repeatedly after selecting "FR60–FR360". To change the value in 30-min. increments, press and hold **<D>**.
- 4 Press **●** on the unit to start recording. Or press and hold **●** and press **▶** on the remote control.
- 5 Press **■** twice to stop recording.
 - Pressing **■** once displays the confirmation message to stop recording. Press **■** again to terminate recording.

NOTES:

- Continuous recording for over 48 hours is not possible.
- It is not possible to record both on DVD and on HDD simultaneously.

Pause recording on HDD deck

It is not possible to pause recording. Pressing **■** initiates Live Memory Playback.

However, it is still possible to pause recording only when recording the channels of external sources ("L-1", "L-2", "F-1", and "DV"). Press and hold **●**, then press **■** on the remote. To resume recording, press and hold **●**, then press **▶** on the remote. No operation can be made with the buttons on the unit.

Recording Mode

MPEG2 format is used as recording format. As a guide for picture quality, the "bps" unit is used to represent how much data can be recorded per second. The larger this value is, the better the picture quality becomes but more capacity is required for the recording. Select XP or SP for programmes where quick movement occurs, such as sports programmes, and LP or EP for talk shows, etc. with relatively less movement.

Recording mode	Recording amount (approx.)	Maximum recording time (approx.)
XP	10 Mbps	1 hour
SP	5 Mbps	2 hours
LP	2 Mbps	4 hours
EP	1.6 Mbps	6 hours
FR60–FR360 (☞ pg. 37)	The amount varies depending on the selected time.	1 – 6 hours
FR420		7 hours
FR480		8 hours

- For details on FR mode, refer to "Free Rate Function" (☞ pg. 37).

Recording Resume Function

If there is a power outage during recording, Instant Timer Recording (ITR) (☞ pg. 39) or timer recording (☞ pg. 44, 46), the recording will resume automatically when power is restored to the unit unless the unit's memory backup has expired.

Recording Features

- Turn on the unit.
- Turn on the TV and select the AV mode.
- Slide the **TV/CABLE/SAT/DVD** switch to **DVD**.
- Press **HDD** so that the HDD lamp lights up on the unit.

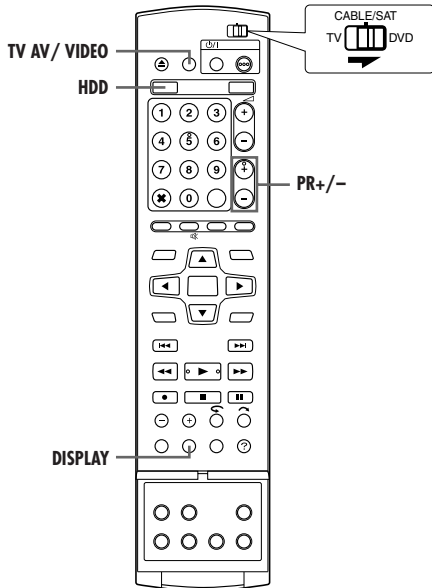
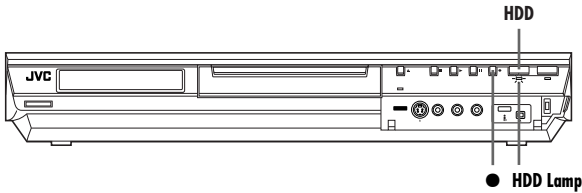

Instant Timer Recording (ITR)

This easy method lets you record for from 30 minutes to 6 hours (selectable in 30-min. increments), and shuts the unit off after recording is finished.

- 1 Press ● on the unit to start recording.
- 2 Press ● again to engage the ITR mode.
 - On the front display panel, "0:30" appears.
- 3 If you want to record for more than 30 minutes, press ● to extend the time. Each press extends recording time by 30 minutes.

NOTES:

- You can only perform ITR using the ● button on the unit.
- If "DIRECT REC" is set to "ON" in the menu, Instant Timer Recording (ITR) function does not work. (☞ pg. 68)
- When the recording capacity becomes full during timer recording or Instant Timer Recording, the unit is automatically shut off.

Watch Another Programme While Recording On The Unit

While recording is going on, you can watch another programme on the TV by using the TV's tuner.

NOTE:

It is required that the remote control is set to be able to operate the TV in advance. (☞ pg. 63)

- 1 During recording, press **TV AV/VIDEO** to select TV mode.
 - Video mode is disengaged and the video lamp (VIDEO) on the unit is turned off.
 - The programme received on the TV's tuner is displayed on the TV screen.
- 2 Slide the **TV/CABLE/SAT/DVD** switch to **TV**.
- 3 Press **PR +/-** repeatedly to select the desired channel.

NOTE:

If a decoder is connected to the unit (☞ pg. 66), you can select a scrambled channel as well as other normal channels.

Elapsed Recording Time And Disc Remaining Time Indication

During recording, press **DISPLAY** repeatedly until the desired indication appears on the front display panel.

- Each time you press **DISPLAY**, the time indication changes as follows:
Elapsed recording time → Disc remaining time → Clock → (Back to the beginning)

Receiving Stereo And Bilingual Programmes

Your unit is equipped with a Sound-Multiplex decoder (A2) and a Digital stereo sound decoder (NICAM) making reception of stereo and bilingual broadcasts possible.

When the channel is changed, the type of broadcast being received will be displayed on the TV screen for a few seconds.

Type of Broadcast Being Received	On-screen Display
A2 Stereo	
A2 Bilingual	
Regular Monaural	
NICAM Stereo	
NICAM Bilingual	
NICAM Monaural	

NOTES:

- "SUPERIMPOSE" must be set to "AUTO". Otherwise the on-screen displays will not appear. (☞ pg. 69)
- If the quality of stereo sound being received is poor, the broadcast might be received in monaural with better quality.

Selection Of The Audio Channel To Be Recorded On A Disc

When a programme is recorded on a DVD-RAM or DVD-RW disc in VR mode, all audio channels of the receiving programme are recorded on the disc. When you record a programme on a DVD-R or DVD-RW disc in video mode, select the desired audio channel ("NICAM" or "MONO") to be recorded on the disc. (☞ pg. 68)

NOTE:

Before playing back a programme recorded in stereo, or a bilingual programme, refer to "Audio Channel Selection" on page 29.

Basic Playback

- Turn on the unit.
- Turn on the TV and select the AV mode.
- Slide the **TV/CABLE/SAT/DVD** switch to **DVD**.

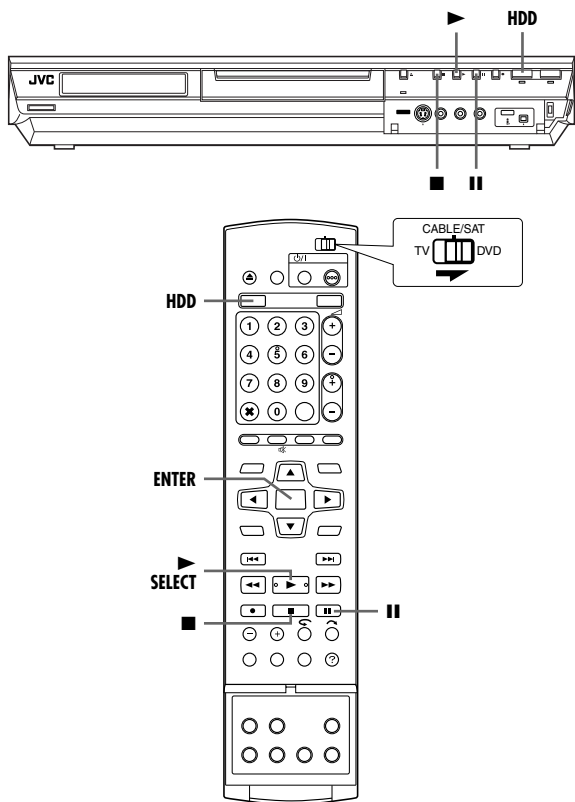

ATTENTION:

- It may take a few seconds to start playback. This is not a malfunction.
- Forward/reverse high-speed search and other operations cannot be performed while playback is stopped.

- 1 Press **HDD** so that the HDD lamp lights up on the unit.
- 2 Press **▶** to start playback.
 - The Library Database Navigation also enables you to search and select the desired programmes. (☞ pg. 50)
- 3 Press **⏸** to pause playback.
 - To resume normal playback, press **▶**.
- 4 Press **■** to stop playback.

NOTE:

When the Library Database Navigation screen appears, choose a thumbnail image of the desired title on the TV screen, then press **SELECT(▶)** or **ENTER**. (☞ pg. 50)

Playback Features

- Turn on the unit.
- Turn on the TV and select the AV mode.
- Slide the **TV/CABLE/SAT/DVD** switch to **DVD**.
- Press **HDD** so that the HDD lamp lights up on the unit.

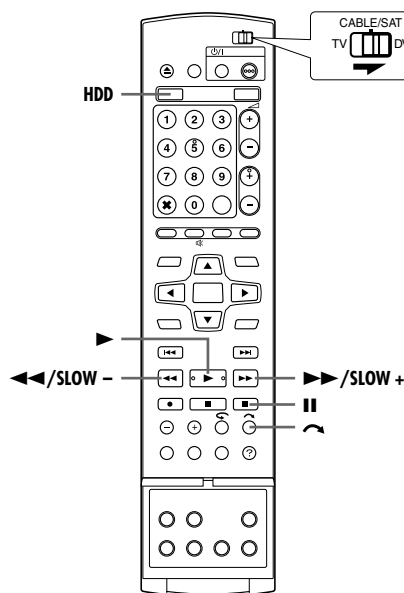

High-Speed Search

During playback, press **▶▶** for forward high-speed search, or **◀◀** for reverse high-speed search.

- Each press of the button increases the search speed for each direction.
- To resume normal playback, press **▶**.

Still Picture/Frame-By-Frame Playback

- 1 Press **⏸** to pause during playback.
- 2 Press **SLOW - (◀◀)** or **SLOW + (▶▶)** to activate frame-by-frame playback.
 - Each press of **SLOW - (◀◀)** or **SLOW + (▶▶)** advances/reverses the still picture frame by frame.
 - To resume normal playback, press **▶**.

Slow Motion

- 1 Press **⏸** to pause during playback.
- 2 Press **SLOW - (◀◀)** or **SLOW + (▶▶)** for 2 or more seconds.
 - Each press of **SLOW - (◀◀)** or **SLOW + (▶▶)** increases the slow motion speed for each direction (from 1/16 to 1/2 times the normal speed).

Skip Search

During playback, press **↶**.

- Each press initiates an approximately 30-second period of fast-motion playback. Normal playback resumes automatically.

Live Memory Playback

- Turn on the unit.
- Turn on the TV and select the AV mode.
- Slide the **TV/CABLE/SAT/DVD** switch to **DVD**.
- Press **HDD** so that the HDD lamp lights up on the unit.

This unit records pictures onto the hard disc, instead of video tapes, then plays back the pictures recorded on the disc. This makes it possible to achieve high-speed writing and read-out that has not been possible with conventional VCRs, enabling recording and playback simultaneously.

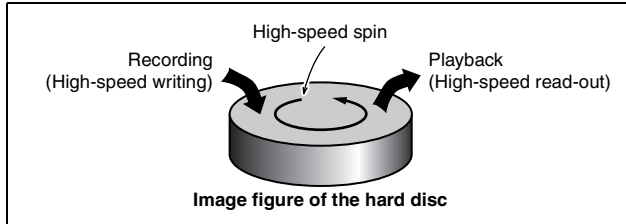

It is called "Live Memory Playback" to start playback of the programme being recorded, with a time-lag between a recording point and a playback point, as shown in the figure below.

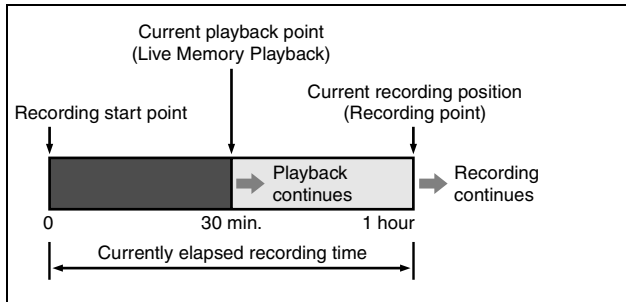

Not only can this unit play back a programme previously recorded while recording or timer recording another programme, but the unit also allows you to play back from the beginning of a programme while continuing to record the same programme.

Temporary recording for Live Memory

This unit automatically records the channel being received, within the specified range of time, to the reserved space on the hard disc. The time range can be set for 30 minutes, 1 hour, and 3 hours. (☞ pg. 68)

NOTE:

Previous temporary recordings will be overwritten since the unit is always recording the channel being received. Thus, it is not possible to play back TV programmes recorded beyond the specified range of time since they are already overwritten. To avoid this in order to save titles, perform normal recording (☞ pg. 38), timer recording (☞ pg. 44, 46), or Live Memory Recording (☞ pg. 43).

About limitation on temporary recording

The temporary recording for Live Memory is cancelled in the following cases, and will start all over again when it is to resume.

- When the power is turned off
- When the system is powered again after a power failure was occurred
- When normal recording, timer recording, Live Memory Recording, or Automatic Satellite Programme Recording (☞ pg. 48) is performed
- When the "LIVE MEMORY" setting is changed (☞ pg. 68)
- When tuner channel setting is performed (☞ pg. 70)
- When dubbing is performed by pressing **DUBBING** (☞ pg. 56)
- When "DV" is selected by pressing **PR +/-** (☞ pg. 58)

Recording/playback Status Display

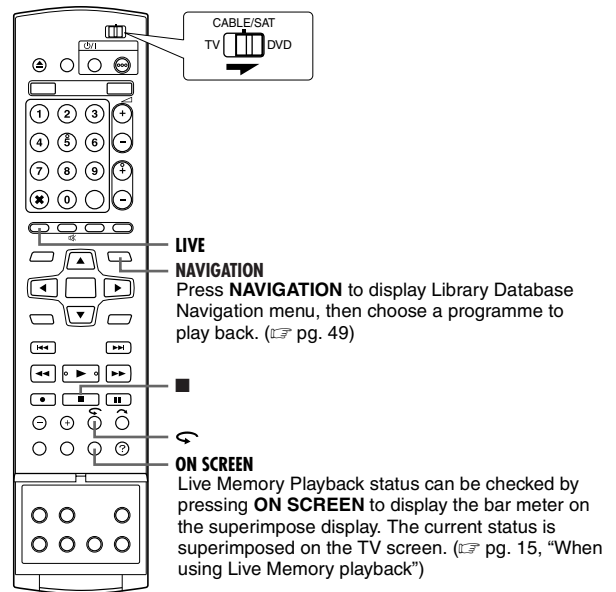

NOTES:

- Live Memory Playback cannot be performed for approximately 30 seconds after recording has started.
- Although high-speed search up to approximately 30 seconds before the current recording point is possible during Live Memory Playback, once the current recording point is reached, the unit resumes normal playback and maintains a delay of approximately 30 seconds so that recording and playback can continue.
- When using Live Memory Playback during timer recording, playback continues even after the end of the recording.
- When using Live Memory Playback during timer recording, playback is automatically stopped just before recording starts, and then recording starts when the time arrives for the next timer-programme.
- It is impossible to perform ITR even if you press ● during Live Memory Playback. (☞ pg. 39)
Press ■ to display the programme being recorded, then perform ITR settings.
- Playback may be paused for a moment during Live Memory Playback, which does not interfere with recording.
- Live Memory Playback cannot be performed while recording the source from DV input. (☞ pg. 58, "DV Dubbing")
- When **LIVE CHECK** is pressed to display the picture currently being recorded, the picture size may not be correct.
- Press ● or **LIVE** to stop Live Memory Playback.
- Live Memory Playback cannot be performed, even if the "LIVE MEMORY" is set to other than OFF in "HDD SET UP", because temporary recording on HDD stops during recording on DVD.

Buttons To Be Used During Live Memory Playback

- Turn on the unit.
- Turn on the TV and select the AV mode.
- Slide the **TV/CABLE/SAT/DVD** switch to **DVD**.
- Press **HDD** so that the HDD lamp lights up on the unit.

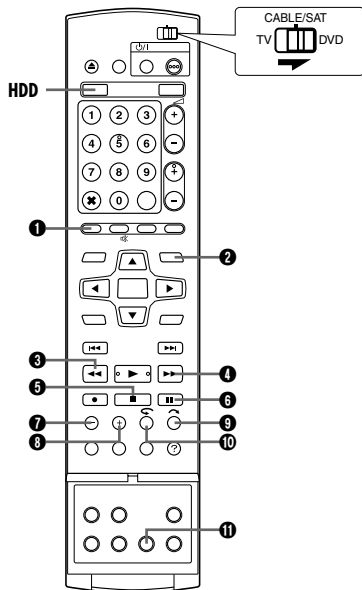

1 LIVE

Returns to on air programme screen. When a confirmation message appears by pressing this button during timer programming or title editing, etc., follow the instruction to return to the previous screen.

2 NAVIGATION

Displays Library Database Navigation menu. You can choose a title to play back.

3 ◀◀

- Each press of the button during playback advances the playback speed in 5 steps for reverse direction.

Available only when paused

- Each press of the button reverses the still picture frame by frame.
- Pressing down for 2 or more seconds reverses playback at 1/16 times the normal speed. Then, each press of the button reverses slow-motion at 1/16 times, 1/4 times and 1/2 times the normal playback.

4 ▶▶

- Each press of the button during playback advances the playback speed in 4 steps for forward direction.

Available only when paused

- Each press of the button advances the still picture frame by frame.
- Pressing down for 2 or more seconds advances playback at 1/16 times the normal speed. Then, each press of the button advances slow-motion at 1/16 times, 1/4 times and 1/2 times the normal playback.

5 ■

- Pressing once during Live Memory Playback or Live Memory Recording returns to the screen on air.
- Pressing twice during recording stops recording and returns to the screen on air.

6 II

Pressing once pauses playback (still picture playback). Pressing repeatedly advances the still picture frame by frame.

7 JUMP –

Each press of the button during playback or Live Memory Playback jumps back for the selected time interval and resumes playback. (☞ pg. 43, “Jump Search”)

8 JUMP +

Each press of the button during playback or Live Memory Playback jumps forward for the selected time interval and resumes playback. (☞ pg. 43, “Jump Search”)

9 ↷

Pressing once skips forward for approximately 30 seconds and resumes playback. Pressing repeatedly skips forward continuously as many times as pressed. It is useful when skipping over unwanted sections.

10 ↶

Pressing once skips back for approximately 30 seconds and resumes playback. Pressing repeatedly skips back for approximately 7 seconds continuously as many times as pressed. It is useful when watching sports programmes, etc.

11 LIVE CHECK

Pressing once displays the picture currently being recorded and the one being played back simultaneously. Pressing successively clears the Live Check window and displays only the picture currently being played back. You can check, for example, if the programme you are recording has already finished.

To Play Back The Previous Part Of The Channel Currently Recording or Watching

You can play back the previous part of the channel you are recording or watching (temporarily recorded on the background) from the desired point. (☞ pg. 41, "Temporary recording for Live Memory")

- 1 Press **⏮** or **⏪** to locate the point to start playback from.
 - Each press of **⏮** increases the reverse search speed.
- 2 Press **▶** to start Live Memory Playback.
- 3 Press **■** to stop Live Memory Playback.
 - The on-air screen resumes.

NOTES:

- You can use various playback features during Live Memory Playback. (☞ pg. 40)
- If you have started actual recording by pressing **●**, pressing **■** in step 3 only resumes the on-air screen. To stop actual recording, press **■** again.

To Record From The Previous Part Of The Channel Currently Watching (Live Memory Recording)

You can start recording from the previous part of the channel you are currently watching (temporarily recorded on the background). (☞ pg. 41, "Temporary recording for Live Memory")

- 1 Press **⏮** or **⏪** to locate the point to start recording from.
 - Each press of **⏮** increases the reverse search speed.
- 2 Press **●** on the unit to start Live Memory Recording. Or press and hold **●** and press **▶** on the remote control.
- 3 Press **■** to stop Live Memory Recording.
 - The on-air screen resumes.

NOTES:

- You cannot use Live Memory Recording for channels other than the channel you are currently watching.
- Recording speed is automatically set to SP mode when Live Memory Recording is started.
- Temporarily recorded data prior to the beginning of Live Memory Recording is erased when Live Memory Recording started.

To Move Back The Playback Position Slightly While Recording (One Touch Replay Function)

You can move back the playback position while continuing to record or timer record.

Press **↶**.

- Each press skips back for approximately 7 seconds and resumes playback.
- Pressing while paused skips back for approximately 7 seconds and resumes pause.

To Resume Playback Of A TV Broadcast From The Paused Point

You can resume playback of a TV broadcast you were recording or watching from the point you have paused.

- 1 Press **⏸** to pause a TV broadcast.
 - Recording continues when recording.
- 2 Press **▶** to start Live Memory Playback.
 - Playback resumes from the paused position.
- 3 Press **■** to resume the on-air screen.

1.5x Speed Search

You can play back a title quickly. (This feature can also be performed with normal playback.) 1.5x speed search cannot be performed during recording on HDD or DVD.

- 1 Press **⏮** to locate the point to start 1.5x speed search from.
- 2 Press **▶** to resume playback.
- 3 Press **▶▶** once.
 - Pressing **ON SCREEN** displays "+X1.5" on the top right corner of the screen.

NOTE:

When the unit is connected with a digital audio device using an optional optical cable, set "DIGITAL AUDIO OUT" to "PCM ONLY". (☞ pg. 29)

Jump Search

You can locate a scene ahead or behind the current one by jumping scenes according to selected time intervals (☞ pg. 68) during playback (or Live Memory Playback). This feature is also available during recording (or Live Memory Recording) or when watching a TV received programme.

Press **JUMP -** or **JUMP +**.

- To advance forward or back, press **JUMP -** or **JUMP +** repeatedly within 5 seconds of each press to continue jump.
- When you cannot advance any farther (beginning or end of programme reached), the message "UNABLE TO GO BACK ANYMORE" appears on the screen and the on-air screen resumes. In such a case, press **⏮**, **⏪** or **■**.

Example 1:

Playback search when jump interval is set to 30 MIN jumps

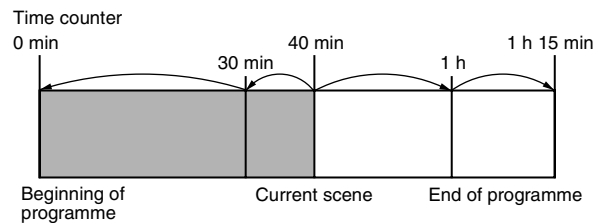

Example 2:

Recording search when jump interval is set to 15 MIN jumps

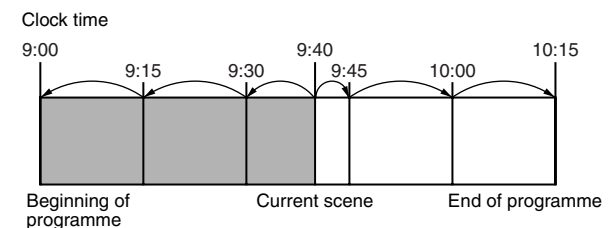

SHOWVIEW™ Timer Programming

You can programme this unit to timer-record as many as 32 programmes.

With the SHOWVIEW system, timer programming is greatly simplified because each TV programme has a corresponding code number which your unit is able to recognize.

You can use the remote control to enter the SHOWVIEW number.

- Make sure that the unit's built-in clock is set properly.
- Turn on the unit.
- Turn on the TV and select the AV mode.
- Slide the **TV/CABLE/SAT/DVD** switch to **DVD**.

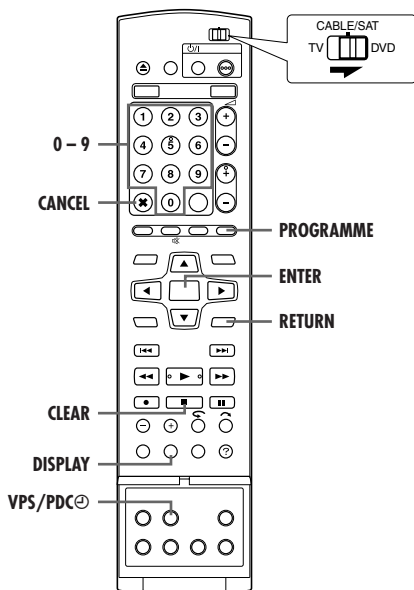

- 1 Load a recordable disc if recording to DVD.
- 2 Press **PROGRAMME** to access the programme top screen.
- 3 Press $\Delta \nabla \triangleleft \triangleright$ to select "SHOWVIEW", then press **ENTER**.
 - When "PROGRAMME FULL DELETE UNWANTED TIMER PROGRAMMES" appears on the TV screen, you need to cancel some of the reserved programmes. (pg. 47)
- 4 Press the **number keys** to enter the SHOWVIEW number of a programme you wish to record.

OR

Press $\Delta \nabla \triangleleft \triangleright$ to select the desired number key on the screen, then press **ENTER**. Repeat to enter all needed numbers.



- 5 Press $\Delta \nabla$ to select "RECORD TO", then press **ENTER**. Press $\Delta \nabla$ to select the desired recording deck, then press **ENTER**.
- 6 Press $\Delta \nabla \triangleleft \triangleright$ to select "CONFIRM", then press **ENTER**.
 - If the number you entered is invalid, "SHOWVIEW NO. ERROR CONFIRM SHOWVIEW NO. THEN RETRY" appears on the TV screen. Input a valid SHOWVIEW number.
 - If "GUIDE PROGRAMME IS NOT SET SET GUIDE PROGRAM THEN RETRY" appears on the TV screen, set Guide Program Numbers manually. (pg. 70)

7 The SHOWVIEW number you entered and the matching timer-recording information are displayed on the TV screen. Check the programme data.

- To cancel this setting, press **RETURN**.

IMPORTANT:

Make sure the channel position number you wish to record is displayed; if not, see "ShowView™ System Setup" (pg. 70) and set the Guide Program number correctly.

8 Press $\Delta \nabla$ to select the desired recording option as required. Press $\Delta \nabla$ to select the desired setting, then press **ENTER**.

- "INPUT TITLE" (pg. 50, "Modify Title Name")
- "CATEGORY" (pg. 51, "Modify Category")
- "VPS/PDC" (pg. 45, "VPS/PDC Recording")
- "WEEKLY/DAILY" (pg. 45, "Weekly/Daily Recording")
- "REC MODE" (pg. 35, "Recording Mode")

9 Press $\Delta \nabla$ to select "OK", then press **ENTER** to access the Programme Confirmation screen.

10 Press $\triangleleft \triangleright$ to select "EXIT", then press **ENTER** to complete timer programming.

- To programme another timer, press $\triangleleft \triangleright$ to select "CONTINUE", then press **ENTER**.
- If "PROGRAMME OVERLAPPED" appears on the TV screen, see page 47.

NOTES:

- There may be cases that SHOWVIEW Timer Programming function prolongs the stop time of the programming.
- When two successive programmes are recorded on a DVD-RW disc with SHOWVIEW Timer Programming function, the beginning of the second one may be left off the recording.
- If the copy limited programme is received during timer-recording, the unit enters Record Pause mode. Recording starts again if it is switched to a recordable broadcast during the time you programmed.

IMPORTANT:

If you have moved to a different area or if a broadcasting station's channel number has been changed, the wrong channel number will be displayed on the SHOWVIEW programme screen in step 7. When this happens, set the correct Guide Program number for that station. (pg. 70, "ShowView™ System Setup")

Satellite Receiver Users

To timer-record a satellite broadcast using the SHOWVIEW system:

- 1 Perform "Satellite Receiver Control Setting" (pg. 23).
- 2 Perform "ShowView™ Timer Programming" (pg. 44).
- 3 Leave the satellite receiver's power on.

Weekly/Daily Recording

You can record programmes with one of the following weekly/daily timer settings.

For the HDD deck

When you select a mode other than ONCE, the space on the hard disk drive is saved for new recordings by overwriting previous recordings. To prevent loss of a needed recording, backup programmes you wish to save by dubbing them to DVD discs before overwriting previous recordings. Or save the title of weekly/daily programmes to avoid overwriting of a previous week/day. (pg. 47)

ONCE (One Time Recording)

In this mode a programme will not be automatically overwritten. WEEKLY (OVERWRITE) (Weekly Recording/Weekly Overwrite) When the set weekly programme is broadcast, the programme recorded last week is automatically deleted and overwritten by the new programme. Save the title of each programme you wish to save, then the recorded programme is saved and will not be overwritten by the new programme.

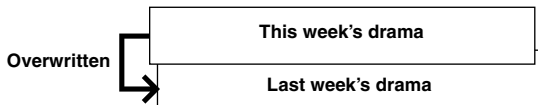

MON-SUN (FOR A WEEK)/ MON-SAT (FOR A WEEK)/ MON-FRI (FOR A WEEK) (Daily Recording/Weekly Overwrite) When the set weekly programme is broadcast, the programme recorded on the same day last week is automatically deleted and overwritten by the new programme. Save the title of each programme you wish to save, then the recorded programme is saved and will not be overwritten by the new programme.

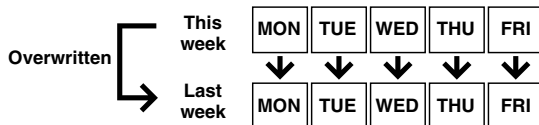

MON-SUN (OVERWRITE)/ MON-SAT (OVERWRITE)/ MON-FRI (OVERWRITE) (Daily Recording/Daily Overwrite)

When the set daily programme is broadcast, yesterday's programme is automatically deleted and overwritten by the new programme. Save the title of each programme you wish to save, then the recorded programme is saved and will not be overwritten by the new programme.

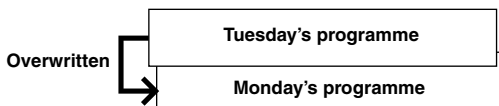

For the DVD deck

ONCE (One Time Recording)

WEEKLY (Weekly Recording)

MON-SUN/ MON-SAT/ MON-FRI (Daily Recording)

VPS/PDC Recording

Now available from some TV stations, PDC (Programme Delivery Control) and VPS (Video Programme System) are services designed to assure safe, accurate timer recording. With this system, special code signals are transmitted together with the audio/video signals. These code signals control your video unit and have precedence over the advertised times you may have preset into the timer. This means that your unit will start and stop recording when the preset TV programmes actually start and end — even if the broadcast time of a preset TV programme is changed.

NOTES:

- Make sure to press **VPS/PDC** after completing timer programming procedure to activate the VPS/PDC recording function.
- When you use Manual Timer Programming, set the start time (VPS or PDC time) exactly as advertised in the TV listing. A different time than advertised will result in no recording.
- VPS/PDC recording is also possible when a satellite receiver or a cable system is connected to L-2 IN/DECODER connector on your unit.
- VPS/PDC recording is also possible via the L-1 IN/OUT connector.

How to check if the station being received transmits a VPS/PDC signal

- 1 Hold down **DISPLAY** for about 5 seconds. "VPS/PDC" appears blinking on the front display panel. If a VPS/PDC signal is detected from the station, "VPS/PDC" will stop blinking. If no VPS/PDC signal is detected from the station, "VPS/PDC" will blink at a slower rate.
- 2 Press **DISPLAY** again to return to normal display.

Manual Timer Programming

You can programme this unit to timer-record as many as 32 programmes.

If you do not know the SHOWVIEW number for the programme you wish to record, use the following procedure to set your unit to timer-record the programme.

- Make sure that the unit's built-in clock is set properly.
- Turn on the unit.
- Turn on the TV and select the AV mode.
- Slide the **TV/CABLE/SAT/DVD** switch to **DVD**.

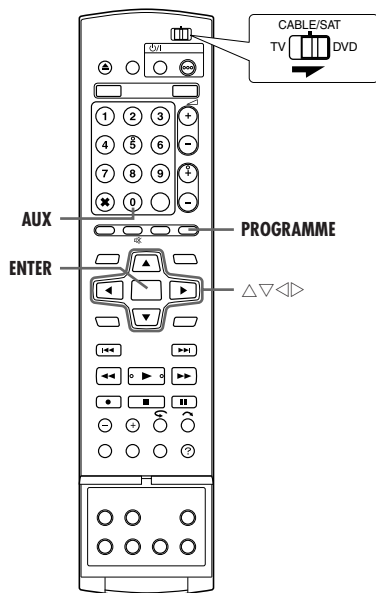

- 1 Load a recordable disc if recording to DVD.
- 2 Press **PROGRAMME** to access the programme top screen.
- 3 Press $\Delta \nabla \triangleleft \triangleright$ to select "CALENDAR PR.", then press **ENTER**.
 - When "PROGRAMME FULL DELETE UNWANTED TIMER PROGRAMMES" appears on the TV screen, you need to cancel some of the reserved programmes. (☞ pg. 47)
- 4 Press $\Delta \nabla \triangleleft \triangleright$ to select the desired date, then press **ENTER**.
- 5 Press $\Delta \nabla$ to select "RECORD TO", then press **ENTER**. Press $\Delta \nabla$ to select the desired recording deck, then press **ENTER**.

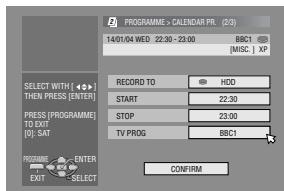

6 Press $\Delta \nabla$ to select "START", then press **ENTER**. Press $\Delta \nabla$ to set the desired start time, then press **ENTER**.

- Each press of $\Delta \nabla$ advances/goes back the start time in 1-min. increments.
 - To advance/go back the start time in 30-min. increments, press and hold $\Delta \nabla$.
- 7 Press $\Delta \nabla$ to select "STOP", then press **ENTER**. Press $\Delta \nabla$ to set the desired stop time, then press **ENTER**.
- Each press of $\Delta \nabla$ advances/goes back the stop time in 1-min. increments.
 - To advance/go back the stop time in 30-min. increments, press and hold $\Delta \nabla$.

8 Press $\Delta \nabla$ to select "TV PROG", then press **ENTER**. Press $\Delta \nabla$ to select the desired channel.

9 Press $\Delta \nabla$ to select "CONFIRM", then press **ENTER**.

10 Set the other recording options as required.

- Refer to step 8 in "ShowView™ Timer Programming" (☞ pg. 44).

11 Press $\Delta \nabla$ to select "OK", then press **ENTER** to access the Programme Confirmation screen.

12 Press $\triangleleft \triangleright$ to select "EXIT", then press **ENTER** to complete timer programming.

- To programme another timer, press $\triangleleft \triangleright$ to select "CONTINUE", then press **ENTER**.

- If "PROGRAMME OVERLAPPED" appears on the TV screen, see page 47.

NOTES:

- When two successive programmes are recorded on a DVD-RW disc with Manual Timer Programming function, the beginning of the second one may be left off the recording.
- If the copy limited programme is received during timer-recording, the unit enters Record Pause mode. Recording starts again if it is switched to a recordable broadcast during the time you programmed.

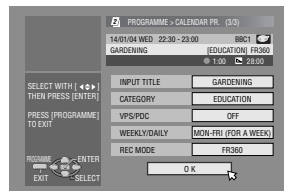

Satellite Receiver Users

To timer-record a satellite broadcast using Manual Timer Programming:

- 1 Perform "Satellite Receiver Control Setting" (☞ pg. 23).
- 2 Perform "Manual Timer Programming" (☞ pg. 46). In step 8, press **AUX** to change "TV PROG" to "SAT". Then press $\Delta \nabla$ to enter the channel position for the satellite broadcast.
- 3 Leave the satellite receiver's power on.

Relief Recording

When a programme that is set for the DVD deck cannot be recorded properly, the programme is recorded to the HDD deck instead in the same recording mode as set.

- If the remaining capacity of the hard disc is not sufficient, the programme is recorded to the DVD deck until the remaining capacity of the DVD disc lasts.
- If "JUST" is selected for the recording mode, the current recording mode for the DVD deck is applied.

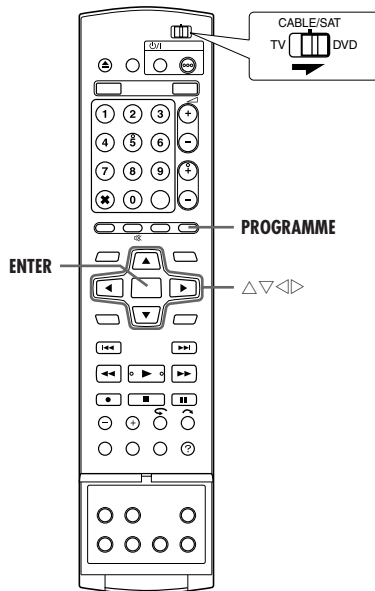

Check Programmes

To check the whole list of programmes

- 1** Press **PROGRAMME** to access the programme top screen.
- 2** Press $\Delta \nabla \triangleleft \triangleright$ to select "PROGRAMME LIST", then press **ENTER**.
 - The details of a selected programme appear on the top of the screen.
 - The daily programme of a title is listed as one programme.

To check the list of programmes by date

- 1** Press **PROGRAMME** to access the programme top screen.
- 2** Press $\Delta \nabla \triangleleft \triangleright$ to select "CALENDAR LIST", then press **ENTER**.
- 3** Press $\Delta \nabla$ to select the desired date, then press **ENTER**.

Cancel And Change Programmes

- Repeat steps in "Check Programmes" to select a programme before proceeding.

To cancel the programme

- 1** Press $\Delta \nabla \triangleleft \triangleright$ to select "CANCEL", then press **ENTER**.

To modify the programme settings

- 1** Press $\Delta \nabla \triangleleft \triangleright$ to select "MODIFY", then press **ENTER**.
- 2** Change the settings of the desired recording options as required.
 - Refer to steps 4 – 12 in "Manual Timer Programming" (pg. 46).

To skip the weekly/daily programmes to the next week/day

It is easy to temporarily cancel weekly/daily programmes of a week/day.

- 1** Press $\Delta \nabla \triangleleft \triangleright$ to select "PROGRAMME SKIP", then press **ENTER**.

- 2** Press $\triangleleft \triangleright$ to select "SKIP", then press **ENTER** twice.

To save the titles of weekly/daily programmes (HDD Deck Only)

Use this function to avoid overwriting titles of weekly/daily programmes of a previous week/day.

- 1** Press $\Delta \nabla \triangleleft \triangleright$ to select "TITLE SAVE", then press **ENTER**.
- 2** Press $\triangleleft \triangleright$ to select "SAVE", then press **ENTER** twice.

NOTE:

This function is available only when the remaining capacity of the hard disc is sufficient.

Automatic Satellite Programme Recording

This function allows you to automatically record a satellite programme which is timer-programmed on your external satellite receiver. Connect a satellite receiver to the unit's L-2 IN/DECODER connector and programme the timer on the satellite receiver. The unit starts or stops recording by the signals input from the satellite receiver. After recording, the unit's power shuts off automatically.

ATTENTION:

- Be sure not to turn on the satellite receiver before the programme is executed; otherwise, the unit will start recording when the satellite receiver's power is turned on.
- If you have connected another appliance other than a satellite receiver to the L-2 IN/DECODER connector, be sure not to engage the Automatic Satellite Programme Recording mode; otherwise, the unit will start recording when the connected appliance's power is turned on.
- Automatic Satellite Programme Recording and timer-recording cannot be done at the same time.

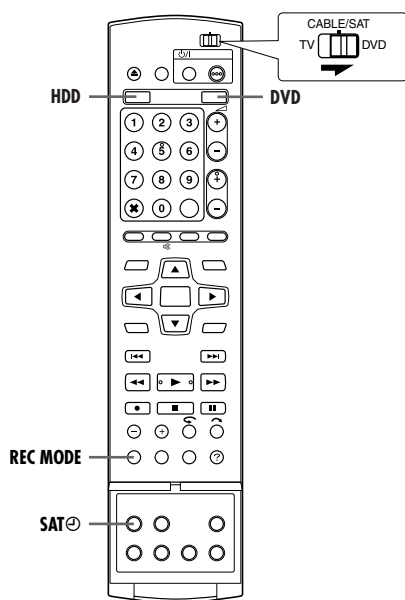
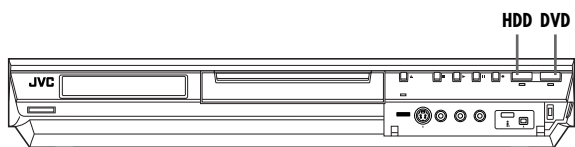

- Make sure the satellite receiver is connected to the unit's L-2 IN/DECODER connector.
- Programme the timer on the satellite receiver.
- Slide the TV/CABLE/SAT/DVD switch to DVD.

- 1 Press **HDD** or **DVD** to choose the recording deck.
- 2 Set "L-2 SELECT" to "SAT VIDEO" or "SAT S-VIDEO". (pg. 61)
 - Also refer to "IMPORTANT" on page 65.
- 3 Press **REC MODE** repeatedly to set the recording mode.
- 4 Press and hold **SAT@** for about 2 seconds to engage the Automatic Satellite Programme Recording mode. "SAT@" appears on the front display panel.

NOTES:

- To disengage the Automatic Satellite Programme Recording mode, press **SAT@**.
- If the unit's power is off, it is not possible to engage the Automatic Satellite Programme Recording mode.
- In step 4, if "SAT@" blinks quickly on the front display panel even though your satellite receiver's power is off, Automatic Satellite Programme Recording will not work properly with that satellite receiver*. If this is the case, perform "Manual Timer Programming" (pg. 46) to timer-record a satellite programme.
 - * Some satellite receivers output signals even if the power is off. Automatic Satellite Programme Recording is not possible with those satellite receivers.
- "SAT@" blinks on the front display panel while Automatic Satellite Programme Recording is in progress.
- For timer programming of the satellite receiver, refer to the instruction manual of the satellite receiver.
- Automatic Satellite Programme Recording is not possible if your satellite receiver does not have a timer.
- Pressing the unit's **ON/OFF** button while Automatic Satellite Programme Recording is in progress turns off the unit's power and disengages the Automatic Satellite Programme Recording mode.
- If there are more than one satellite programmes you wish to record with Automatic Satellite Programme Recording, it is not possible to set different recording modes for each programme.
- Depending on the type of satellite receiver, the unit may not record a slight portion of the beginning of the programme or may record slightly longer than the actual length of the programme.
- If you engage the Automatic Satellite Programme Recording mode when the satellite receiver's power is on, the unit will not start Automatic Satellite Programme Recording even though "SAT@" blinks on the front display panel. When the satellite receiver shuts off once and is turned back on again, the unit starts recording.
- You can also record a programme from your cable system in the same way if the system has a timer.
- Just Clock (pg. 73) does not work when the Automatic Satellite Programme Recording mode is engaged.

Library Database Navigation



The Library Database Navigation enables you to search and select the desired titles recorded on the HDD deck and the DVD deck very easily.

You can record up to 99 titles on a disc.

Each time a title is recorded, the information of the title is registered for the Library Database Navigation automatically. So, you can confirm the information of the titles recorded with the Library Database Navigation screen. And, you can also select one of the titles recorded using the Library Database Navigation.

The following screen appears as the Library Database Navigation screen when you press **NAVIGATION**. You can move the arrow to select the desired position on the screen by pressing $\Delta \nabla \triangleleft \triangleright$ on the remote control.

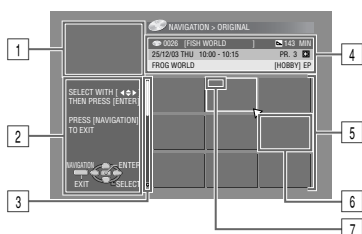

- 1 Playback screen
(Indicates currently received TV programme.)
- 2 Guidance for operations
- 3 Scroll bar
(Appears when there are over nine registered titles (or play lists). The scroll bar only indicates that there are more titles (or play lists) hidden off the current screen display. To show hidden titles (or play lists), press $\Delta \nabla \triangleleft \triangleright$ repeatedly.)
- 4 Recording information for the title indicated by the arrow
- 5 Index list
(Thumbnail still of each title)
Thumbnail still is not to be played back.
- 6 Index
 - : Indicates no index is registered.
 - : Indicates title in standby for timer recording.
 - : Indicates no title is registered.
- 7 Icons
(Indicate the record condition of each title.)

The Icons and their meanings

	This title is write-protected.
	This title has stereo sounds.
	This title was recorded with timer recording.
	This title is Weekly Recording/Weekly Overwrite.
	This title is Daily Recording/Daily Overwrite.
	This title is Daily Recording/Weekly Overwrite.
	This title has not been played back.
	This title is copy-protected.
	This title was just once recordable (copy-once title).

Using Library Database Navigation system, you can easily modify registered information, edit the title or play list, as well as search for the beginning of each title.

About registration of information

The following information is automatically registered for each title when ordinary recording or timer recording is performed, then stored in an area specified on the unit.

- index* (reduced pictures to show programme titles)
- programme title*
- category*
- date and time
- channel
- recording mode
- length of recording time

The items marked with an asterisk (*) can be easily modified and registered again after recording by using Library Database Navigation system.

The limitations of registration

You can register information up to 99 titles for the DVD deck and 200 titles for the HDD deck.

When the amount of information is at the limits of registration, you cannot record new titles any more. In this case, you need to delete old titles to register new one. (pg. 51)

NOTES:

- Once a DVD-R/RW (Video mode) disc has been finalised, the displays for original and play list do not appear. Only display for library appears.
- When you move the title recorded on HDD to DVD, the icon will be changed to .
- Sound of received channel may be interrupted while the Library Database Navigation screen is displayed.

Scan For Beginning Of Title

- Turn on the TV and select the AV mode.
- Slide the **TV/CABLE/SAT/DVD** switch to **DVD**.
- Press **HDD** or **DVD** to choose the corresponding deck.
- Load a DVD disc to scan.

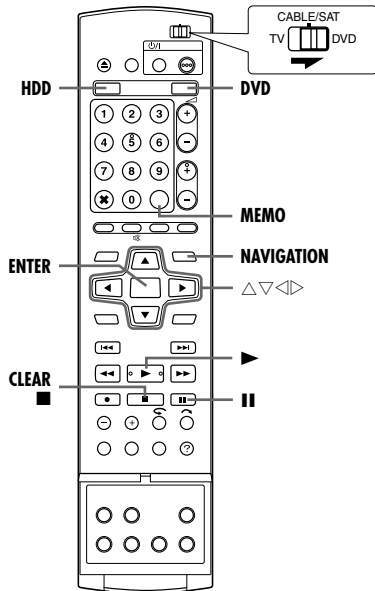

You can scan the beginning of the title easily with the Library Database Navigation.

1 Press **NAVIGATION**. The Library Database Navigation screen appears.

2 Press $\Delta \nabla \triangleleft \triangleright$ to select "ORIGINAL", then press **ENTER**.

3 Press $\Delta \nabla \triangleleft \triangleright$ to select the index (small pictures) of the desired title, then press **ENTER**.

• When you want the plural titles to be played back continuously, press **MEMO** after selecting the desired title. The numbers of the playback order appear on the index. You can select up to 8 titles.

• When you want to correct the order, move the arrow to the desired index and press **MEMO**. The number disappears and the unit re-numbers the other programmes automatically.

• When you want to cancel the order, press **CLEAR** (■).

4 Press $\triangleleft \triangleright$ to select "BEGINNING", then press **ENTER**.

• To repeat playback of a selected title, press $\triangleleft \triangleright$ to select

"REPEAT", then press **ENTER**.

• To resume playback from the point where playback was previously stopped, press $\triangleleft \triangleright$ to select "RESUME", then press **ENTER**.

5 Press **II** to pause playback.

• To resume normal playback, press \blacktriangleright .

6 Press ■ to stop playback.

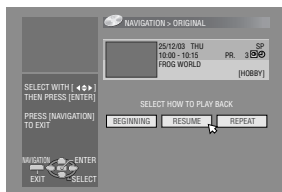
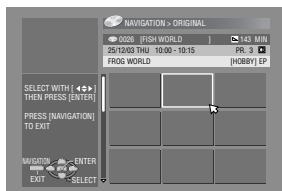

Modify Original Information



- Turn on the TV and select the AV mode.
- Slide the **TV/CABLE/SAT/DVD** switch to **DVD**.
- Press **HDD** or **DVD** to choose the corresponding deck.
- Load a DVD disc to modify.

ATTENTION:

It is not possible to modify discs recorded on DVD units from other manufacturers.

Modify Index

1 Press **EDIT**. The Editing screen appears.

2 (DVD deck only) Press $\Delta \nabla \triangleleft \triangleright$ to select "MODIFY" under "ORIGINAL/PLAY LIST", then press **ENTER**.

3 Press $\Delta \nabla \triangleleft \triangleright$ to select "MODIFY" under "ORIGINAL", then press **ENTER**.

4 Press $\Delta \nabla \triangleleft \triangleright$ to select one title you want to modify, then press **ENTER**.

5 Press $\triangleleft \triangleright$ to select "INDEX".

6 Search for the picture from the title by pressing the appropriate buttons (\triangleleft , \blacktriangleright , \triangleright , or **II**). The pictures of the title appear on the left window.

7 Confirm the arrow is on "REPLACE", then press **ENTER** to register new index. New index appears on the right window.

• When you press **ENTER** with the arrow on "RETURN" you can return to the previous screen.

8 Press **EDIT** to return to the normal screen.

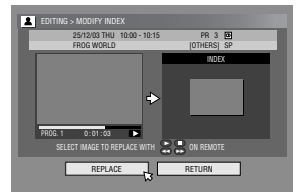

Modify Title Name

1 Perform steps 1 – 4 of "Modify Index" (pg. 50) before continuing.

2 Press $\Delta \nabla \triangleleft \triangleright$ to select "NAME", then press **ENTER**.

3 Press $\Delta \nabla \triangleleft \triangleright$ to select the desired letter or command, then press **ENTER**. Repeat this process to complete the name.

• To correct a letter, press $\Delta \nabla \triangleleft \triangleright$ to select "DELETE", then press **ENTER**.

• You can enter the letters up to 64.

4 Press $\Delta \nabla \triangleleft \triangleright$ to select "SAVE", then press **ENTER**.

5 Press **EDIT** to return to the normal screen.

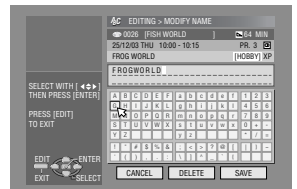

Modify Category

- 1 Perform steps 1 – 4 of “Modify Index” (☞ pg. 50) before continuing.
- 2 Press $\Delta \nabla \triangleleft \triangleright$ to select “CATEGORY”, then press **ENTER**.
- 3 Press $\Delta \nabla \triangleleft \triangleright$ to select the desired category, then press **ENTER**.
- 4 Press **EDIT** to return to the normal screen.

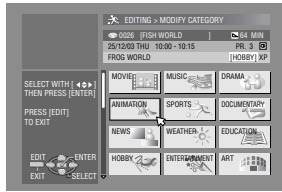

Protect Title (DVD deck only)

You can protect titles to prevent accidental erasure of the important titles.

- 1 Perform steps 1 – 3 of “Modify Index” (☞ pg. 50) before continuing.
- 2 Press $\Delta \nabla \triangleleft \triangleright$ to select “PROTECT”, then press **ENTER**.
- 3 Press $\Delta \nabla \triangleleft \triangleright$ to select a title you want to protect, then press **ENTER**.
- 4 Press $\triangleleft \triangleright$ to select “PROTECT”, then press **ENTER**. “” appears.
 - To cancel the protection, repeat 3 – 4 again. In step 4, select “CANCEL PROTECT”, then press **ENTER**.
- 5 Press **EDIT** to return to the normal screen.

NOTE:

All the titles on a disc will be deleted once the disc is formatted even if they are protected titles. (☞ pg. 51)

Delete Title

You cannot record any more with Library Database Navigation once the registered titles on the disc reach 99 titles for the DVD deck and 200 titles for the HDD deck. Deleting unnecessary titles after dubbing or other operations can increase remaining time and available recording capacity. (For DVD-R discs, although it is possible to delete recorded titles, available recording capacity does not increase.) The deleted title is never resumed. Play lists and title information in the unit’s library are also deleted.

- 1 Press **EDIT**. The Editing screen appears.
- 2 Press $\Delta \nabla \triangleleft \triangleright$ to select “DELETE” under “ORIGINAL”, then press **ENTER**.
- 3 Press $\Delta \nabla \triangleleft \triangleright$ to select one title you want to delete, then press **ENTER**.
- 4 Press $\triangleleft \triangleright$ to select “DELETE”, then press **ENTER**.
 - When you cancel the deletion, select “CANCEL”, then press **ENTER**.
- 5 Press **EDIT** to return to the normal screen.

Delete Unwanted Part Of The Title (DVD deck only)

You can delete unwanted part of the title.

- 1 Perform steps 1 – 3 of “Modify Index” (☞ pg. 50) before continuing.
- 2 Press $\Delta \nabla \triangleleft \triangleright$ to select “DEL SCENE”, then press **ENTER**.
- 3 Press $\Delta \nabla \triangleleft \triangleright$ to select one title whose unwanted part you want to delete, then press **ENTER**.
- 4 The playback pictures appear in the window on the screen. The elapsed playing time starts counting with the arrow on “IN”.
- 5 Find the point where you want the deletion to begin, then press **ENTER** with the arrow on “IN”. The edit-in time is fixed and the elapsed playing time starts counting again.
- 6 Find the point where you want the deletion to end, then press **ENTER** with the arrow on “OUT”. The edit-out time is fixed.
 - Press $\triangleleft, \triangleright, \gg, \ll, \lll, \ggg$ or **II** to find the edit-in and edit-out points.
- 7 Press $\triangleleft \triangleright$ to select “PREVIEW”, then press **ENTER** to preview the edited title.
- 8 Press $\triangleleft \triangleright$ to select “OK”, then press **ENTER**.
 - If you do not want to delete the scene, press **EDIT** or **RETURN**.

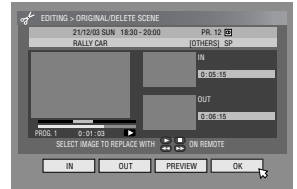

To modify the points

- 1 Press **EDIT** or **RETURN**.
- 2 Repeat steps 4 – 8 as necessary.

- 9 Press $\triangleleft \triangleright$ to select “DELETE”, then press **ENTER**. The selected scene is deleted.

- To cancel the deletion, press $\triangleleft \triangleright$ to select “CANCEL”, then press **ENTER**.

- 10 Press **EDIT** to return to the normal screen.

NOTES:

- There may be a discrepancy of several seconds between the scene you intend to edit, and the scene which is actually edited.
- Available recording capacity may not match the deleted part after deletion.

Divide Title

- 1 Press **EDIT**. The Editing screen appears.
- 2 Press $\triangle \nabla \triangleleft \triangleright$ to select "DIVIDE", then press **ENTER**.
- 3 Press $\triangle \nabla \triangleleft \triangleright$ to select a title to divide, then press **ENTER**.
- 4 Locate a point to divide by pressing the appropriate buttons (\triangleleft , \triangleright , \blacktriangleright , or **II**).
- 5 Confirm the arrow is on "DIVIDE", then press **ENTER** at the dividing point.
 - The first picture (start) of the newly created title appears in the bottom right window.
- 6 Press $\triangleleft \triangleright$ to select "PREVIEW", then press **ENTER**.
 - The first several seconds of the newly created title is played back, then the playback pauses at the dividing point.
 - To undo the division, press $\triangleleft \triangleright$ to select "RETRY", then press **ENTER**. Repeat the above procedure to locate another point to divide.
- 7 Press $\triangleleft \triangleright$ to select "OK", then press **ENTER**.
- 8 Press **EDIT** to return to the normal screen.

NOTE:

There may be a discrepancy of several seconds between the scene you intend to edit, and the scene which is actually edited.

Modify Chapter

You can create and delete chapter marks in titles.

- 1 Perform steps 1 – 4 of "Modify Index" (pg. 50) before continuing.
- 2 Press $\triangle \nabla \triangleleft \triangleright$ to select "CHAPTER", then press **ENTER**.
- 3 Confirm the arrow is on "MARK", then press **ENTER** at positions you want to mark.
 - The newly created chapter is displayed.
 - To undo the marking, press $\triangleleft \triangleright$ to select "RETRY", then press **ENTER**. Repeat the above procedure to locate another point to mark.
- 4 Press \triangleright , and press $\triangleleft \triangleright$ or \blacktriangleright to select one chapter you want to delete, then press **II**.
- 5 Press $\triangleleft \triangleright$ to select "ERASE", then press **ENTER**.
 - The selected chapter is deleted.
 - To undo the deletion, press $\triangleleft \triangleright$ to select "RETRY", then press **ENTER**. Repeat the above procedure to locate another point to delete.
- 6 Press **EDIT** to return to the normal screen.

NOTE:

There may be a discrepancy of several seconds between the scene you intend to edit, and the scene which is actually edited.

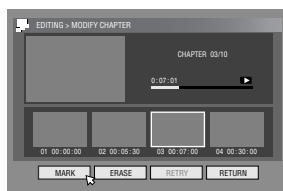

Modify Play List Information



- Turn on the TV and select the AV mode.
- Slide the **TV/CABLE/SAT/DVD** switch to **DVD**.
- Press **HDD** or **DVD** to choose the corresponding deck.
- Load a DVD disc to modify.

ATTENTION:

It is not possible to modify discs recorded on DVD units from other manufacturers.

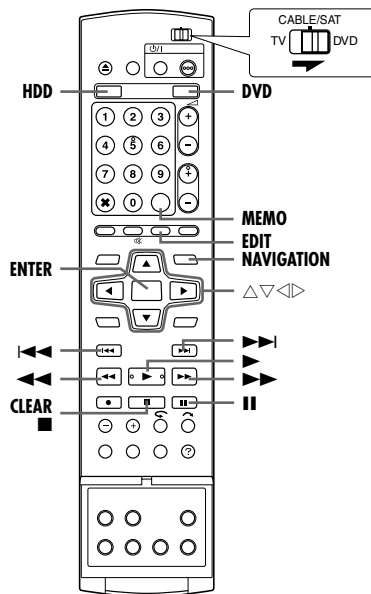

Play List

It is a collection of the scenes. A play list can be freely edited and played back without ever changing any original recording data. Using the random access of a disc (which allows video data to be instantly read no matter where it is on the disc), a play list includes information such as the timer counter for the playback start point and end point, indexes for checking the contents of recorded data, category information, and more. Playback according to a play list you have created allows you to enjoy various combinations of video images from a single title.

Create Play List

- 1 Press **EDIT**. The Editing screen appears.
- 2 (DVD deck only) Press $\Delta \nabla \triangleleft \triangleright$ to select "MODIFY" under "ORIGINAL/PLAY LIST", then press **ENTER**.
- 3 Press $\Delta \nabla \triangleleft \triangleright$ to select "CREATE", then press **ENTER**.
- 4 Press $\Delta \nabla \triangleleft \triangleright$ to select a title that includes scenes to be included in a play list, then press **ENTER**.
- 5 The playback pictures appear in the window on the screen. The elapsed playing time starts counting with the arrow on "IN/OUT".
- 6 Find the point where you want the created play list to begin, then press **ENTER** with the arrow on "IN/OUT". The edit-in time is fixed and the elapsed playing time starts counting again.
- 7 Find the point where you want the created play list to end, then press **ENTER** with the arrow on "IN/OUT". The edit-out time is fixed.
 - Press $\blacktriangleleft, \blacktriangleright, \blacktriangleright, \blacktriangleleft, \blacktriangleright, \blacktriangleright$ or **II** to find the edit-in and edit-out points.
 - The edit-out point must come after the edit-in point.
- 8 Press $\Delta \nabla \triangleleft \triangleright$ to select "PREVIEW", then press **ENTER** to preview the play list.
- 9 Press $\Delta \nabla \triangleleft \triangleright$ to select "OK", then press **ENTER**. The play list is created.

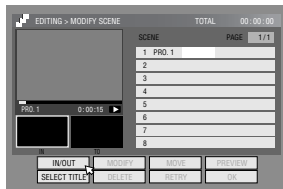

To modify the points

- 1 Press $\triangleleft \triangleright$ to select "MODIFY", then press **ENTER**.
- 2 Repeat steps 5 – 9 as necessary.

- 10 Press $\triangleleft \triangleright$ to select "EXIT", then press **ENTER** to return to the normal screen.

NOTES:

- There may be a discrepancy of several seconds between the scene you intend to edit, and the scene which is actually edited.
- The title, index and category of the play list can be modified in the same way as "ORIGINAL". (pg. 50)
- You can modify the play list that has just been created here by adding, moving, or deleting unwanted parts to create a digest edition, etc.

Edit Scenes

- 1 Press **EDIT**. The Editing screen appears.
- 2 Press $\Delta \nabla \triangleleft \triangleright$ to select "MODIFY" under "PLAY LIST", then press **ENTER**.
- 3 Press $\Delta \nabla \triangleleft \triangleright$ to select a play list to modify, then press **ENTER**.
- 4 Press $\Delta \nabla \triangleleft \triangleright$ to select "SCENE", then press **ENTER**.
- 5 Press $\Delta \nabla \triangleleft \triangleright$ to select "MODIFY", then press **ENTER**.
- 6 Press $\Delta \nabla \triangleleft \triangleright$ to select a scene to modify, then press **ENTER**.
- 7 Perform steps 5 – 10 in "Create Play List" (pg. 53).

Add scenes

- 1 Perform steps 1 – 3 in "Edit Scenes" (pg. 53) before continuing.
- 2 Press $\Delta \nabla \triangleleft \triangleright$ to select "SELECT TITLE", then press **ENTER**.
- 3 Perform steps 4 – 10 in "Create Play List" (pg. 53).

Move Scenes

- 1 Perform steps 1 – 3 of "Edit Scenes" (pg. 53) before continuing.
- 2 Press $\Delta \nabla \triangleleft \triangleright$ to select "MOVE", then press **ENTER**.
- 3 Press $\Delta \nabla \triangleleft \triangleright$ to select a scene to move, then press **ENTER**.
- 4 Press $\Delta \nabla \triangleleft \triangleright$ to select another scene to which the scene is to be moved, then press **ENTER**.
 - To cancel the move, press $\Delta \nabla \triangleleft \triangleright$ to select "RETRY", then press **ENTER**.
- 5 Perform steps 8 – 10 in "Create Play List" (pg. 53).

Delete Scenes

- 1 Perform steps 1 – 4 of "Create Play List" (pg. 53) before continuing.
- 2 Press $\Delta \nabla \triangleleft \triangleright$ to select "DELETE", then press **ENTER**.
- 3 Press $\Delta \nabla \triangleleft \triangleright$ to select a scene to delete, then press **ENTER**.
- 4 Perform steps 8 – 10 in "Create Play List" (pg. 53).

Play Back Play List

- 1 Press **NAVIGATION**. The Library Database Navigation screen appears.
- 2 Press $\Delta \nabla \triangleleft \triangleright$ to select "PLAY LIST", then press **ENTER**.
- 3 Press $\Delta \nabla \triangleleft \triangleright$ to select the index (small pictures) of the desired play list, then press **ENTER**.
 - When you want the plural play lists to be played back continuously, press **MEMO** after selecting the desired play lists. The numbers of the playback order appear on the index. You can select up to 30 play lists.
 - When you want to correct the order, move the arrow to the desired index and press **MEMO**. The number disappears and the unit numbers the other play lists automatically.
 - When you want to cancel the order, press **CLEAR** (■).
- 4 Press $\triangleleft \triangleright$ to select "BEGINNING", then press **ENTER**. The playback starts.
- 5 Press **II** to pause playback.
 - To resume normal playback, press \blacktriangleright .
- 6 Press **■** to stop playback.



Delete Play List

- 1 Press **EDIT**. The Editing screen appears.
- 2 Press $\Delta \nabla \triangleleft \triangleright$ to select "DELETE" under "PLAY LIST", then press **ENTER**.
- 3 Press $\Delta \nabla \triangleleft \triangleright$ to select one play list you want to delete, then press **ENTER**.
- 4 Press $\triangleleft \triangleright$ to select "DELETE", then press **ENTER**.
 - When you cancel the deletion, select "CANCEL", then press **ENTER**.
- 5 Press **EDIT** to return to the normal screen.

NOTE:

Even if a play list is deleted, the titles recorded and the library information are not affected at all.

Modify Index

- 1 Perform steps 1 – 3 of "Edit Scenes" (pg. 53) before continuing.
- 2 Perform steps 5 – 8 of "Modify Index" (pg. 50).

Modify Play List Name

- 1 Perform steps 1 – 3 of "Edit Scenes" (pg. 53) before continuing.
- 2 Perform steps 2 – 5 of "Modify Title Name" (pg. 50).

Modify Category

- 1 Perform steps 1 – 3 of "Edit Scenes" (pg. 53) before continuing.
- 2 Perform steps 2 – 4 of "Modify Category" (pg. 51).

Modify Library Information



Title information can be registered in the unit's memory for up to 600 DVD discs, 2,000 titles. It is helpful when finding a desired title (or play list) by sorting according to the sort options registered during (or after) recording.

- Turn on the TV and select the AV mode.
- Slide the **TV/CABLE/SAT/DVD** switch to **DVD**.
- Press **HDD** or **DVD** to choose the corresponding deck.

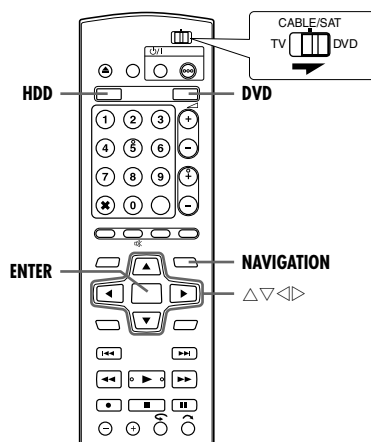

Scan For Title From Library

- 1 Press **NAVIGATION**. The Library Database Navigation screen appears.
- 2 Press $\Delta \nabla \triangleleft \triangleright$ to select the appropriate sort button to sort the information, then press **ENTER**.
 - "DATE" : Sort by date
 - "DISC No." : Sort by disc number
 - "CATEGORY" : Sort by category
 - "NAME" : Sort by name
 - "DATE" and "DISC No." are available for the DVD deck only.
- 3 Press $\Delta \nabla \triangleleft \triangleright$ to select the desired title, then press **ENTER**.
 - Playback begins automatically after the selected title is located.

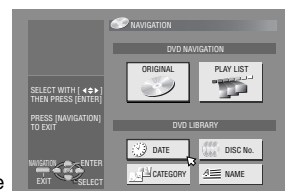

NOTE:

If a disc registered in the library is recorded or modified on DVD units from other manufacturers, it may become impossible to operate properly.

Register Disc

When a disc that is not registered in the library is loaded, a message appears confirming if the disc should be registered. If registering, perform the following procedure.

- 1 Press $\triangleleft \triangleright$ to select "REGISTER", then press **ENTER** to confirm the registration.
- 2 Press **NAVIGATION** to return to the normal screen.

NOTES:

- It is not possible to register discs formatted on devices other than JVC's DVD recorders.
- It is not possible to register discs recorded on devices other than JVC's DVD recorders.
- It is not possible to register discs when "SAVE AS LIBRARY" is set to "OFF". (pg. 68)

Playback With MP3/WMA/JPEG Navigation



This unit can play back discs that MP3/WMA sound files and JPEG image files taken with digital still cameras or other devices are recorded.

The MP3/WMA/JPEG Navigation enables you to search and select the desired files recorded on CD-R/RW or CD-ROM discs very easily.

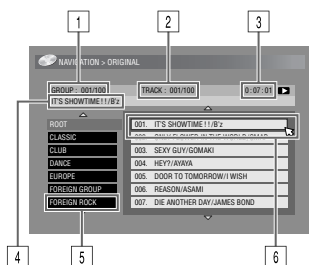

- 1 Selected group number/total number of groups on the disc
- 2 Selected file number/total number of files in the group that contains the selected file
- 3 Elapsed time (MP3 only)
- 4 Name of the selected file
- 5 Group name
- 6 Selected file

NOTE:

If there are more than 100 files the rest files are not displayed. In such a case, press **ON SCREEN** to display them on the TV screen.

Locating The Desired Group And Tracks

- 1 Load a disc.
- 2 Press **NAVIGATION**.
- 3 Press $\Delta \nabla \triangleleft \triangleright$ to select "ORIGINAL", then press **ENTER**.
- 4 Press $\Delta \nabla$ to select the desired group, then press **ENTER**.

- A list of files in the selected group appears.



- 5 Press $\Delta \nabla$ to select the desired item, then press **ENTER**. The unit starts playback from the selected item.

- The unit stops when all items in the selected group are played back.

NOTES:

- If you press **SELECT** (\blacktriangleright) instead of **ENTER** in step 4, the unit starts playback from the first file of the group.
- JPEG files are played back as a slide show at the set intervals. (pg. 33)
- If a file name includes any 2-byte character, the unit may not show the file name correctly.
- The order of the groups and items shown in steps 4 and 5 may differ from the order shown on your PC.



Dubbing

- Turn on the unit.
- Turn on the TV and select the AV mode.
- Slide the **TV/CABLE/SAT/DVD** switch to **DVD**.

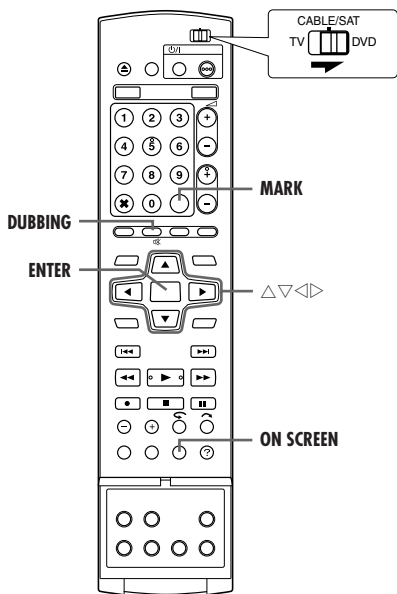

NOTE:

It is not possible to dub simultaneously when timer-programming is set. Select either dubbing or timer-programming.

High Speed Dubbing (From HDD To DVD)

It is possible to dub the original recordings and/or play lists on the HDD deck to DVD discs. The dubbing is performed in high speed, keeping the original transfer rate.

NOTES:

- After accessing the Dubbing Menu screen, it is not possible to take out a disc.
- It is not possible to dub copy-once titles in Video mode.
- When the dubbing is finished, the data will be moved from HDD to DVD.
- When you cancel dubbing a copy-once title during dubbing, the original recording on the HDD deck remains and the title copied to a DVD disc is deleted.
- It is not possible to dub play lists which contain copy-once titles.
- It is not possible to dub the following programmes to DVD-R/RW disc (Video mode):
 - which contains more than one audio language.
 - which is on the play list.
 - which is edited (also Live Memory Recording).
 - which is recorded in LP mode or FP155-FP240 mode.
- Recording may not be performed in the highest speed depending on the characteristics of the disc used.

- 1 Load a recordable disc.
- 2 Press **DUBBING** to access the Dubbing Menu screen.
- 3 Press $\Delta \nabla \triangleleft \triangleright$ to select "HIGH SPEED", then press **ENTER**.
- 4 Press $\Delta \nabla \triangleleft \triangleright$ to select indexes (small pictures) of desired original recordings and/or play lists, then press **MARK**. After selecting all indexes you want to dub, press **ENTER**.
 - You can select up to 8 original recordings and/or play lists.
- 5 Press $\triangleleft \triangleright$ to select "EXECUTE" or "AUTO POWER OFF", then press **ENTER**. The dubbing screen appears for 5 seconds. To display the dubbing screen again, press **ON SCREEN**.

EXECUTE: Select this to continue the dubbing operations.

AUTO POWER OFF: Select this to continue the dubbing operations and turn off the unit after dubbing. While the dubbing screen is displayed, you can also select this mode by pressing **DUBBING**.

CANCEL: Select this to cancel dubbing operation.

NOTES:

- Play lists are dubbed as programmes.
- In Video mode, if the selected play list includes the scenes recorded in the different transfer rate, the dubbing is performed in the highest transfer rate of the scenes in the selected play list.
- It is not possible during dubbing to play back on HDD or DVD or to set timer-programming.

Just Dubbing (From HDD To DVD)

By using Just Dubbing function, when dubbing all selected original recordings and/or play lists, the unit automatically sets the appropriate recording mode depending on the combination of the total time of the selected recordings and/or play lists to be dubbed and the available disc space.

- 1 Load a recordable disc.
- 2 Press **DUBBING** to access the Dubbing Menu screen.
- 3 Press $\Delta \nabla \triangleleft \triangleright$ to select "JUST", then press **ENTER**.
- 4 Perform steps 4 – 5 of "High Speed Dubbing (From HDD To DVD)".

NOTES:

- Play lists are dubbed as programmes.
- In Video mode, if the selected play list includes the scenes recorded in the different transfer rate, the dubbing is performed in the highest transfer rate of the scenes in the selected play list. However, the lower transfer rate cannot be dubbed in the higher transfer rate.
- It is not possible during dubbing to play back on HDD or DVD or to set timer-programming.

Manual Dubbing (From HDD To DVD)

It is possible to perform dubbing in the desired transfer rate.

- 1 Load a recordable disc.
- 2 Press **DUBBING** to access the Dubbing Menu screen.
- 3 Press $\Delta \nabla < \triangleright$ to select "MANUAL", then press **ENTER**.
- 4 Perform step 4 of "High Speed Dubbing (From HDD To DVD)". The Manual Dubbing screen appears.
- 5 Press $\Delta \nabla$ to select "REC MODE", then press **ENTER**. Press $\Delta \nabla$ to select the desired option, then press **ENTER**. The confirmation screen appears.

NOTES:

- In Video mode, if the selected play list includes the scenes recorded in the different transfer rate, the dubbing is performed in the highest transfer rate of the scenes in the selected play list. However, the lower transfer rate cannot be dubbed in the higher transfer rate.
- It is not possible during dubbing to play back on HDD or DVD or to set timer-programming.

Original Dubbing (From DVD To HDD)

It is possible to dub the original recordings on DVD discs to the HDD deck.

- 1 Load a disc you want to dub.
- 2 Press **DUBBING** to access the Dubbing Menu screen.
- 3 Press $\Delta \nabla < \triangleright$ to select "TITLE", then press **ENTER**.
- 4 Press $\Delta \nabla < \triangleright$ to select indexes (small pictures) of desired original recordings and/or play lists, then press **MARK**. After selecting all indexes you want to dub, press **ENTER**.
 - You can select up to 8 original recordings and/or play lists.
- 5 Press $\Delta \nabla$ to select "EXECUTE" or "AUTO POWER OFF", then press **ENTER** to start dubbing.

EXECUTE: Select this to continue the dubbing operations.

AUTO POWER OFF: Select this to continue the dubbing operations and turn off the unit after dubbing.

CANCEL: Select this to cancel dubbing operation.

- 6 Press $< \triangleright$ to select "EXECUTE", then press **ENTER** for confirmation. The dubbing screen appears for 5 seconds.

NOTES:

- It is not possible to dub play lists on DVD discs.
- It is not possible to dub pre-recorded DVD VIDEO discs.

About Disc Remaining Display

The unit displays the time information for dubbing by bar meter. By comparing the disc remaining time and the necessary time for dubbing of the selected items, it is possible to check if the dubbing can be performed completely or not.

When performing the High Speed Dubbing

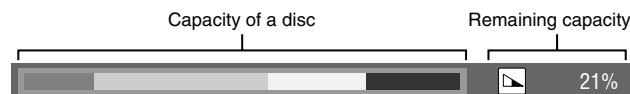

Dark green: Length of already recorded item

Light green: Length of selected item

Yellow: Length of the item now being selected by arrow

Red: Excess over the capacity

When performing the Just Dubbing



- The unit displays the status on the assumption that the selected items are dubbed in the lowest transfer rate.
- The total time of a loaded disc is displayed on the right of the bar meter.

When performing the Manual Dubbing



- The unit displays the status on the assumption that the selected items are dubbed in the lowest transfer rate.
- The available highest transfer rate is displayed on the right of the bar meter.

NOTE:

The bar meter moves up and down regularly, but this is not a malfunction.

DV Dubbing

You can dub programmes from a camcorder or DV equipment connected to the unit with a DV cable. The unit's remote control allows you the limited control of the connected camcorder or DV equipment functions during dubbing.

NOTES:

- Use the DV cable VC-VDV 204U for connection.
- When you connect a PC to the DV IN connector, we do not assure the normal operation of this unit.

Your unit



DV IN connector

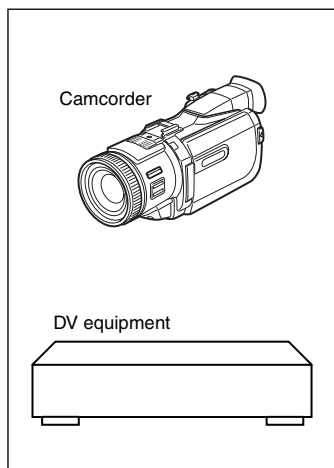

Camcorder

DV cable
(VC-VDV 204U)
(not provided)

DV connector

DV equipment

1 Connect a camcorder or DV equipment to the DV IN connector on the unit's front panel.

2 Press **HDD**.

3 Press **PR +/-** to set the channel to "DV".

4 Press **ON SCREEN**.

- The on-screen display for DV dubbing appears.

5 Press $\triangleleft \triangleright$ to select , then press **ENTER** to display the remote icon (facing to the right) for the DV equipment.

6 Press $\triangleleft \triangleright$ to select , then press **ENTER** repeatedly until the desired sound track appears on the TV screen.

AUDIO 1: Select this to record the original stereo sound played back on the connected DV equipment.

AUDIO 2: Select this to record the dubbed stereo sound played back on the connected DV equipment.

MIX: Select this to record the sound of both "AUDIO 1" and "AUDIO 2".

- Note that this selection is not available when the source programme is recorded in 16BIT (48 kHz) mode.

7 Press **REC MODE** repeatedly to set the recording mode.

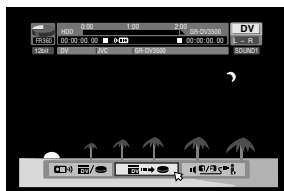

8 Locate the point from where you want to start dubbing, then stop or pause playback by pressing the following buttons on the remote control: \blacktriangleright , $\blacktriangleright\blacktriangleright$, \blacktriangleleft , \blacksquare , \parallel

- To play back in slow speed (1/10 of the normal speed), press \parallel to pause playback, then press \blacktriangleleft or \blacktriangleright .
- To play back frame-by-frame, press \parallel to pause playback, then press \parallel repeatedly. Each press of \parallel advances a frame.
- To change the playback direction, press \blacktriangleleft or \blacktriangleright .

9 Press $\triangleleft \triangleright$ to select , then press **ENTER**. The dubbing starts.

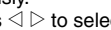
- Playback on the external DV equipment and recording on the unit should start simultaneously.
- To pause dubbing, press $\triangleleft \triangleright$ to select , then press **ENTER**. Both the unit and the external DV equipment pause dubbing. Pressing \parallel on the unit also works the same way.

10 Press $\triangleleft \triangleright$ to select , then press **ENTER**. Then press \blacksquare . The DV equipment stops.

11 Press $\triangleleft \triangleright$ to select , then press **ENTER**.

12 Press \blacksquare twice on the remote control to stop dubbing.

- Both the unit and the external DV equipment stop dubbing.

NOTES:

- Dubbing copyright guarded programmes is not possible.
- Original DV informations such as the recording date and time are not recorded.
- The superimposed indication during the operation or dubbing is not recorded.
- If the dubbing is paused while the channel is set to "DV", you cannot switch channels.

When you dub from DV equipment other than a camcorder

1 Perform step 1 to 4.

2 Locate the point from where you want to start dubbing, then stop on the DV equipment.

- If you pause the DV equipment in this step, a few second's still picture will be recorded at the beginning of the recorded programme.

3 Set the input mode to "DV INPUT" on the DV equipment.

- If you select an input mode other than "DV INPUT", unwanted pictures may be recorded at the beginning of the recorded programme.

4 Perform step 9 to 12.

To skip unwanted part of the source picture

Press **ENTER** to stop both equipment, then press $\triangleleft \triangleright$ to select .

Locate the point where you want to restart dubbing by pressing \blacktriangleright , $\blacktriangleright\blacktriangleright$, or \blacktriangleleft , then press \blacksquare .

Press $\triangleleft \triangleright$ to select , then press **ENTER** to restart dubbing.

Edit From A Camcorder

You can use a camcorder as the source player and your unit as the recording deck.

1 If the camcorder has no S-VIDEO output connector:

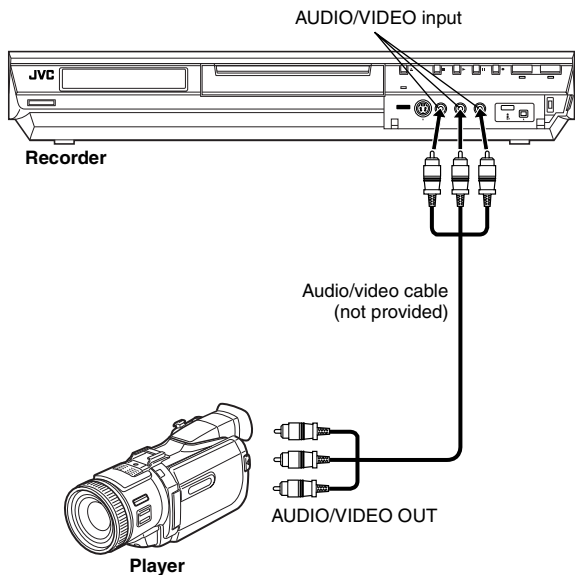

2 If the camcorder has an S-VIDEO output connector:

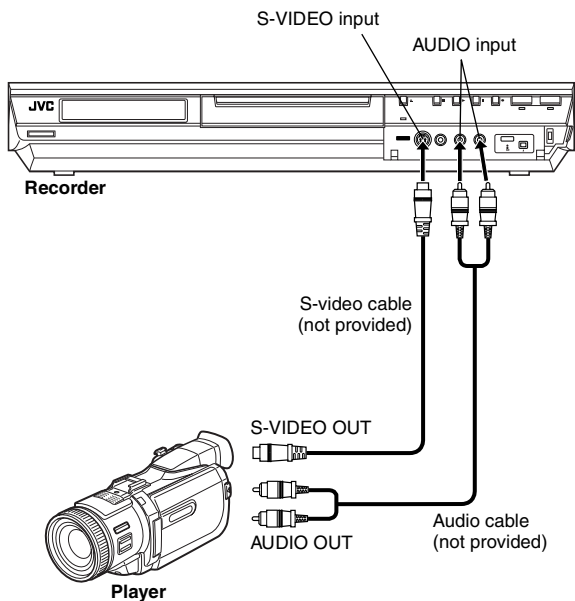

- Slide the **TV/CABLE/SAT/DVD** switch to **DVD**.

1 Make connections.

- 1 If the camcorder has no S-VIDEO output connector:
 - connect the camcorder's AUDIO/VIDEO OUT connectors to the unit's AUDIO/VIDEO input connectors on the front panel.
 - When using a monaural camcorder, connect its AUDIO OUT connector to the AUDIO L input connector on your unit.
- 2 If the camcorder has an S-VIDEO output connector:
 - connect the camcorder's AUDIO OUT and S-VIDEO OUT connectors to the unit's AUDIO and S-VIDEO input connectors on the front panel.

2 Press **HDD** or **DVD** repeatedly to select the recording deck.

3 Press **PR +/-** to select "F-1".

- Set "F-1 INPUT" to "VIDEO" for the VIDEO input connector, or "S-VIDEO" for the S-VIDEO input connector, depending on the connector being used. (pg. 62)

4 Press **REC MODE** repeatedly to set the recording mode.

5 Start playback on the camcorder slightly before the actual point from where you wish to start dubbing.

6 Press **●** on the unit to start recording. Or press and hold **●** and press **▶** on the remote control. The dubbing starts.

7 Press **■** on the unit, then stop playback on the camcorder.

NOTES:

- All necessary cables can be obtained from your dealer.
- Refer to the camcorder's instruction manual for operating procedure.
- The quality of dubbed picture becomes poorer than that of the original.

Edit To Or From Another Recorder

You can use your unit as the source player or as the recording deck.

NOTE:

When using another recorder as the recording deck, refer to its instruction manual.

1 When using your unit as the source player:

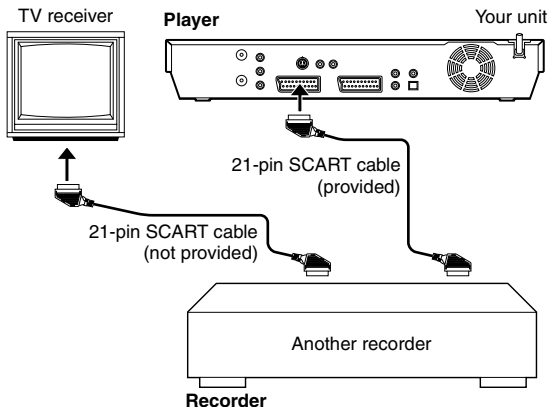

2 When using your unit as the recording deck:

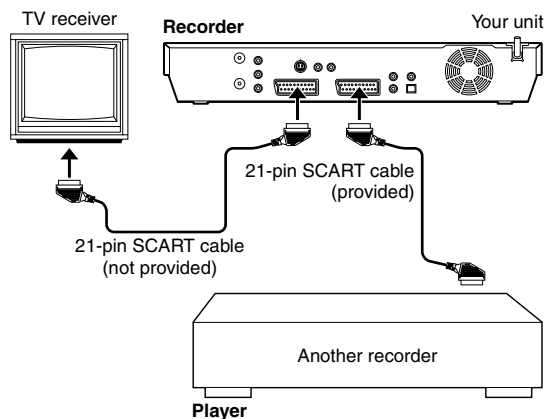

- Slide the **TV/CABLE/SAT/DVD** switch to **DVD**.

1 Connect another recorder's 21-pin SCART connector to the unit's 21-pin SCART connector as illustrated.

- 1 When using your unit as the source player:
 - connect its L-1 IN/OUT connector to the recording deck.
- 2 When using your unit as the recording deck:
 - connect its L-2 IN/DECODER connector to the source player.

- If another recorder is compatible with the Y/C signal:
 - when using your unit as the source player, set "L-1 OUTPUT" to "SCART S-VIDEO". (⌚ pg. 61)
 - when using your unit as the recording deck, set "L-2 SELECT" to "S-VIDEO". (⌚ pg. 61)

2 When using this unit as the recording deck, press **HDD** or **DVD** to select the recording deck.

3 When using this unit as the recording deck, press **PR +/-** to select "L-2".

- Set "L-2 SELECT" to "VIDEO" or "S-VIDEO". (⌚ pg. 61)

4 When using this unit as the recording deck, press **REC MODE** repeatedly to set the recording mode.

5 Engage the Play mode of the source player.

6 Engage the Record mode of the recording deck.

7 Stop recording on the recording deck, then stop playback on the source player.

NOTES:

- All necessary cables can be obtained from your dealer.
- For Y/C signal input/output, be sure to use a 21-pin SCART cable that is compatible with the Y/C signal.
- When you use this unit as the source player for editing, be sure to set "SUPERIMPOSE" to "OFF" before starting. (⌚ pg. 69)
- If you are using another recorder with S-Video and Audio output connectors, connect its S-Video and Audio output connectors to this unit's S-VIDEO and AUDIO input connectors on the front panel. Then, set the unit's input mode to "F-1" in step 3, and set "F-1 INPUT" to "S-VIDEO". (⌚ pg. 62)

Output/Input Set

- Turn on the TV and select the AV mode.
- Slide the **TV/CABLE/SAT/DVD** switch to **DVD**.

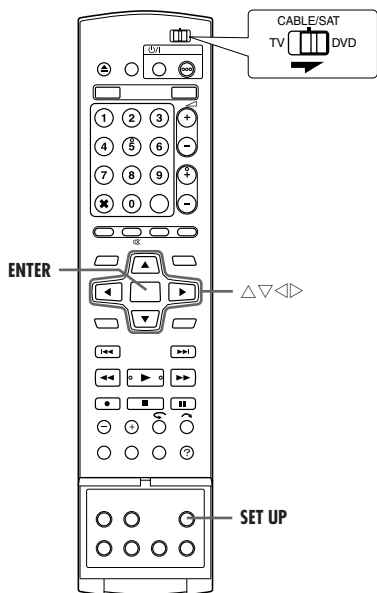

L-1 Output And L-1 Input Setting

The L-1 IN/OUT connector accepts and delivers either a composite video signal (regular video signal) or a Y/C signal (a signal in which the luminance and chrominance signals are separated). Set "L-1 OUTPUT" and "L-1 INPUT" to the appropriate mode depending on the type of appliance connected to the unit's L-1 IN/OUT connector.

- 1 Press **SET UP** to access the Main Menu screen.
- 2 Press $\triangleleft \triangleright$ to select "FUNCTION SET UP", then press ∇ .
- 3 Press $\triangleleft \triangleright$ to select "VIDEO IN/OUT", then press ∇ .
- 4 Press $\triangleleft \triangleright$ to select "L-1 OUTPUT" or "L-1 INPUT", then press **ENTER**.
- 5 Press $\triangleleft \triangleright$ to select the appropriate setting, then press **ENTER**.
- 6 Press **SET UP** to complete the setting.

* The **boldface** settings below indicate the settings at your purchase.

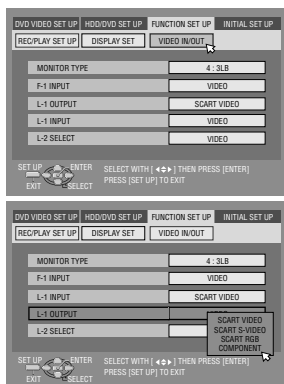

L-1 OUTPUT — SCART VIDEO / SCART S-VIDEO / SCART RGB / COMPONENT

SCART VIDEO: If a connected appliance's input is compatible only with regular video signals, set to "SCART VIDEO".

SCART S-VIDEO: If a connected appliance's input is compatible with Y/C signals, set to "SCART S-VIDEO". You can obtain high-quality picture. (For connection, be sure to use a 21-pin SCART cable that is compatible with the Y/C signal.)

SCART RGB: If a connected appliance's input is compatible with RGB signals, set to "SCART RGB". You can obtain a high-quality RGB picture.

COMPONENT: If a connected appliance's input is compatible with Y/PB/PR signals, set to "COMPONENT". You can obtain a high-quality Y/PB/PR picture. Switch the TV to the input that you can watch component video pictures.

L-1 INPUT — VIDEO / S-VIDEO

VIDEO: If a connected appliance's output is compatible only with regular video signals, set to "VIDEO".

S-VIDEO: If a connected appliance's output is compatible with Y/C signals, set to "S-VIDEO". You can obtain a high-quality picture. (For connection, be sure to use a 21-pin SCART cable that is compatible with the Y/C signal.)

NOTES:

- If "L-1 OUTPUT" is set to "SCART S-VIDEO", "SCART RGB" or "COMPONENT", it is not possible to set "L-1 INPUT" to "S-VIDEO".
- If "L-2 SELECT" is set to "DECODER", it is not possible to set "L-1 INPUT" to "S-VIDEO".
- If "L-2 SELECT" is set to "DECODER", it is only possible to set "L-1 OUTPUT" to "SCART VIDEO".
- Component video signals are not output from the L-1 IN/OUT connector.
- When Progressive scan mode is engaged, it is not possible to select the setting of "L-1 OUTPUT". (☞ pg. 69)

L-2 Select Setting

Set "L-2 SELECT" to the appropriate mode depending on the type of appliance connected to the unit's L-2 IN/DECODER connector.

- 1 Perform steps 1 and 2 of "L-1 Output And L-1 Input Setting" on the left column.
- 2 Press $\triangleleft \triangleright$ to select "L-2 SELECT", then press **ENTER**.
- 3 Press $\triangleleft \triangleright$ to select the appropriate setting, then press **ENTER**.
- 4 Press **SET UP** to complete the setting.

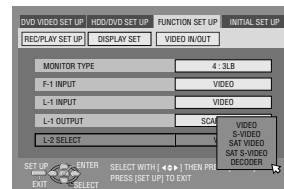

* The **boldface** settings below indicate the settings at your purchase.

L-2 SELECT — VIDEO / S-VIDEO / SAT VIDEO / SAT S-VIDEO / DECODER

Select "VIDEO" or "S-VIDEO" to use this unit as the recording deck with the player connected to the L-2 IN/DECODER connector, or to use the satellite receiver connected to the L-2 IN/DECODER connector.

VIDEO: If a connected appliance's output is compatible only with regular video signals, set to "VIDEO".

S-VIDEO: If a connected appliance's output is compatible with Y/C signals, set to "S-VIDEO". You can obtain high-quality picture. (For connection, be sure to use a 21-pin SCART cable that is compatible with the Y/C signal.)

Select "SAT VIDEO" or "SAT S-VIDEO" to view a satellite programme with the TV set while the unit is turned off. (☞ pg. 65)

SAT VIDEO: If a connected satellite receiver's output is compatible only with regular video signals, set to "SAT VIDEO".

SAT S-VIDEO: If a connected satellite receiver's output is compatible with Y/C signals, set to "SAT S-VIDEO". You can obtain a high-quality S-VHS picture. (For connection, be sure to use a 21-pin SCART cable that is compatible with the Y/C signal.)

DECODER: To use a decoder connected to the L-2 IN/DECODER connector.

NOTES:

- If you have a satellite receiver or a decoder connected to the L-2 IN/DECODER connector, be sure to set "L-2 SELECT" back to appropriate mode after editing.
- If you are not connecting a satellite receiver or a decoder to the L-2 IN/DECODER connector, leave "L-2 SELECT" set to "VIDEO".
- When "L-2 SELECT" is set to "SAT VIDEO" and "SAT S-VIDEO", "SAT" appears on the TV screen or front display panel instead of "L-2".
- If "L-1 OUTPUT" is set to "SCART S-VIDEO", it is not possible to set "L-2 SELECT" to "DECODER" or "SAT VIDEO".
- If "L-1 OUTPUT" is set to "SCART RGB", it is not possible to set "L-2 SELECT" to "DECODER" or "SAT S-VIDEO".
- If "L-1 OUTPUT" is set to "COMPONENT" and "L-2 SELECT" to "SAT VIDEO", "SAT S-VIDEO" or "DECODER", be sure to connect the L-1 IN/OUT connector with a TV.

F-1 Input Setting

Set "F-1 INPUT" to the appropriate mode depending on the connector (VIDEO or S-VIDEO) being used on the front panel.

1 Perform steps 1 and 2 of "L-1 Output And L-1 Input Setting" (pg. 61).

2 Press Δ / ∇ to select "F-1 INPUT", then press **ENTER**.

3 Press Δ / ∇ to select the appropriate setting, then press **ENTER**.

4 Press **SET UP** to complete the setting.

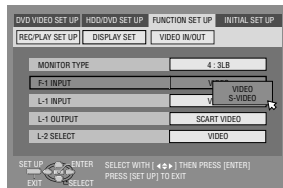

* The **boldface** settings below indicate the settings at your purchase.

F-1 INPUT — VIDEO / S-VIDEO

VIDEO: When connecting an appliance to the VIDEO input connector, set to "VIDEO".

S-VIDEO: When connecting an appliance to the S-VIDEO input connector, set to "S-VIDEO".

Digital Audio Dubbing

You can dub selected audio from a DVD or Audio CD disc to a digital audio device.

However, it is not possible to dub copy-protected discs.

- Turn on the TV and select the AV mode.
- Slide the **TV/CABLE/SAT/DVD** switch to **DVD**.

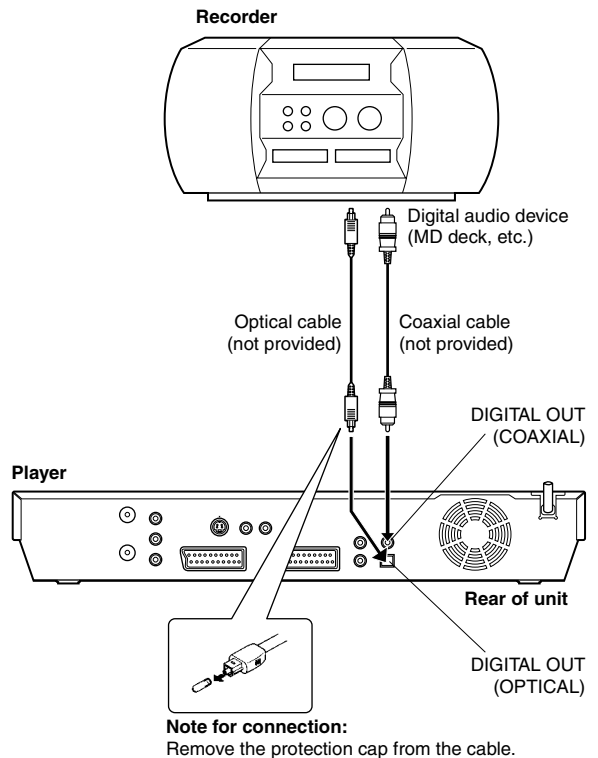
Example: Dubbing to an MD

1 Connect the unit and a digital audio device using either an optional optical cable or an optional coaxial cable.

2 Place a disc on the unit and load an MD on the connected digital audio device.

3 Select the audio to be dubbed.

4 Start playback slightly before the actual point from where you wish to start dubbing.

5 Press **II** to pause playback.

6 Select the input mode on the connected digital audio device.

7 Press **▶** to start playback on the unit.

8 Start recording on the digital audio device.

9 Stop recording on the digital audio device. Then press **■** to stop playback on the unit.

NOTE:

There may be a discrepancy of several seconds between where you intend editing to start, and where it actually starts.

Remote Control Functions

Remote Control 1/2/3/4 Code Switching

The remote control is capable of controlling four JVC video units independently. Each of the units can respond to one of four codes (1, 2, 3 or 4). The remote control is preset to send 3 code signals because your unit is initially set to respond to 3 code signals. You can easily modify your unit to respond to 1, 2 or 4 code signals.

Slide the TV/CABLE/SAT/DVD switch to DVD.

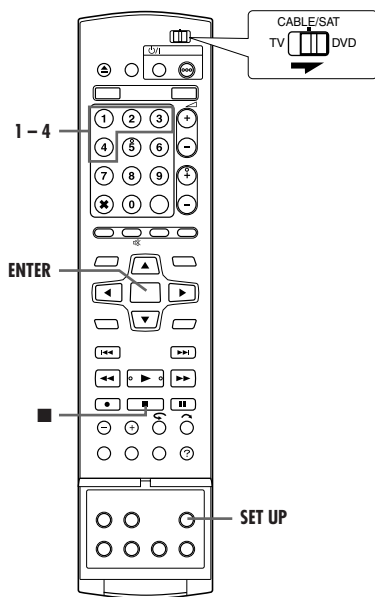
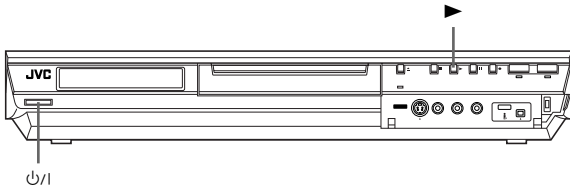

- Keep pressing **SET UP** down during step 1.
- 1** Press the **number key "1"** for 1, **"2"** for 2, **"3"** for 3 or **"4"** for 4 to change the remote control code, then press **ENTER**.
- 2** Press **⏻** on the unit to turn off the unit.
- 3** Press **▶** on the unit for over 5 seconds while the unit is turned off. The code currently set appears on the front display panel.
- 4** Press **■** on the remote control to change the unit's code. The code currently set on the remote control blinks on the front display panel for approximately 5 seconds, and is applied to the unit.

NOTE:
When "POWER SAVE" is set to "ON" (pg. 69), it is not possible to change the remote code.

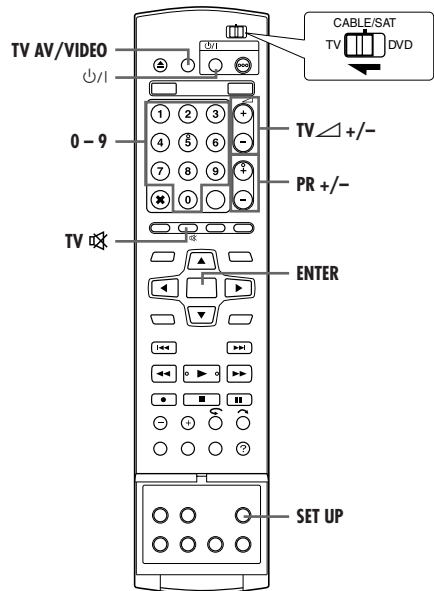

TV Multi-Brand Remote Control

Your remote control can operate the basic functions of your TV set. In addition to JVC TVs, other manufacturer's TVs can also be controlled.

- Turn off the TV using its remote control.
- Slide the **TV/CABLE/SAT/DVD** switch to **TV**.

IMPORTANT:

Although the provided remote control unit is compatible with JVC televisions, as well as many other models, it may not work with your TV, or in some instances, may have limited function capability.

- Keep pressing **SET UP** down during step 1.
- 1** Enter your TV's brand code using the **number keys**, then press **ENTER**.
- 2** Press **⏻** on the unit's remote control to turn on the TV and try operations (step 3).
- Once you have set the remote control to operate the TV, you do not have to repeat this step until you replace your remote control's batteries.
- Some brands of TVs have more than one code. If the TV does not function with one code, try entering another.
- 3** Press the corresponding buttons to operate the TV: **⏻**, **TV AV/VIDEO**, **PR +/-**, **TV AV/VIDEO +/-**, **TV AV**, **number keys**.
- For some brands of TVs, you must press **ENTER** after having pressed the **number keys**.

BRAND NAME	CODE
JVC	01, 03
HITACHI	10
MAGNAVOX	02
MITSUBISHI	03
PANASONIC	04, 11
RCA	05
SHARP	06
SONY	07
SAMSUNG	12
SANYO	13
SEARS	13
TOSHIBA	08
ZENITH	09

Satellite Receiver Multi-Brand Remote Control

Your remote control can operate the basic functions of your satellite receiver set. In addition to JVC satellite receivers, other manufacturer's satellite receivers can also be controlled.

- Slide the **TV/CABLE/SAT/DVD** switch to **CABLE/SAT**.

IMPORTANT:

Although the provided remote control unit is compatible with JVC satellite receivers, as well as many other models, it may not work with your satellite receiver, or in some instances, may have limited function capability.

- Keep pressing **SET UP** down during step 1.

1 Enter your satellite receiver's brand code using the **number keys**, then press **ENTER**.

2 Press $\psi/1$ on the unit's remote control to turn on the satellite receiver and try operations (→ step 3).

- Once you have set the remote control to operate the satellite receiver, you do not have to repeat this step until you replace your remote control's batteries.
- Some brands of satellite receivers have more than one code. If the satellite receiver does not function with one code, try entering another.

3 Press the corresponding buttons to operate the satellite receiver: $\psi/1$, **PR +/-**, **number keys**.

- For some brands of satellite receivers, you must press **ENTER** after having pressed the **number keys**.
- The **number keys** may not function with some satellite receivers.

BRAND NAME	CODE
JVC	73
AMSTRAD	60, 61, 62, 63, 92
CANAL SATELLITE	81
CANAL +	81
D-BOX	85
ECHOSTAR (VIA DIGITAL)	82
FINLUX	68
FORCE	89
GALAXIS	88
GRUNDIG	64, 65, 102
HIRSCHMANN	64, 78, 99
HUMAX	88
ITT NOKIA	68
KATHREIN	70, 71, 96
LUXOR	68
MASCOM	93
MASPRO	70
NOKIA	87, 94
PACE	65, 67, 74, 86, 92
PANASONIC	74, 92
PHILIPS	66, 84, 101
RADIX	78
RFT	69
SABA	97
SAGEM	83, 90
SALORA	68
SAMSUNG	83
SIEMENS	64
SKYMASTER	69, 98
TECHNISAT	66, 100
THOMSON	97
TPS	83
TRIAX	91
WISI	64

Connecting To A Satellite Receiver

Simple Connections

This is an example of a simple connection if your TV has one 21-pin AV input (SCART) connector.

Connect the satellite receiver to the L-2 IN/DECODER connector, then connect the L-1 IN/OUT connector to the TV's connector.

NOTES:

- Set "L-2 SELECT" to "VIDEO" or "S-VIDEO". (☞ pg. 61)
- You can use the Automatic Satellite Programme Recording function (☞ pg. 48) with this connection.
- To record a programme via the satellite receiver, select L-2 mode by pressing **PR +/-** so that "L-2" appears on the front display panel.
- For details, refer to the instruction manual of the satellite receiver.

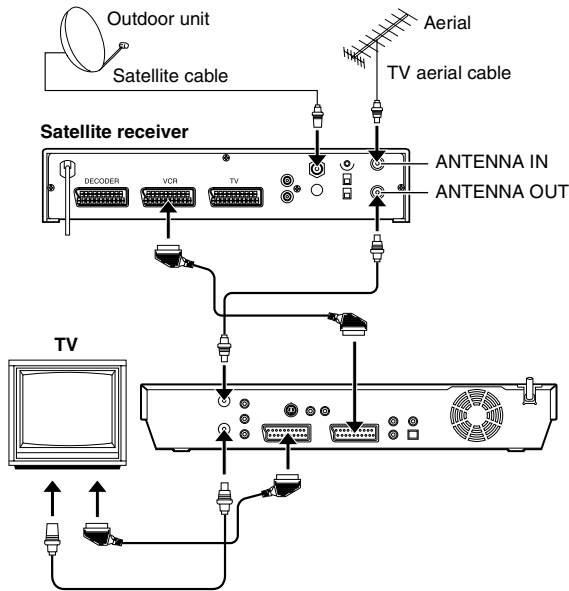

IMPORTANT

When you set "L-2 SELECT" to "SAT VIDEO" or "SAT S-VIDEO" (☞ pg. 61), it is possible to view a satellite broadcast with the TV set to its AV mode even if the unit is turned off. When the unit is in Stop mode or recording, press **TV AV/VIDEO** on the remote control to turn off the VIDEO lamp on the unit.

- If you turn on the unit when the satellite receiver's power is off, nothing appears on the TV screen. In this case, turn on the satellite receiver, or set the TV to its TV mode, or press **TV AV/VIDEO** on the remote control to set the unit to the AV mode.

Perfect Connections (Recommended)

This is an example of recommended connections if your TV has two 21-pin AV input (SCART) connectors.

Connect the decoder to the satellite receiver's connector if you have a decoder, L-1 IN/OUT connector to TV's connector, and L-2 IN/DECODER connector to the satellite receiver's connector. Then connect the satellite receiver and TV.

NOTES:

- Set "L-2 SELECT" to "VIDEO" or "S-VIDEO". (☞ pg. 61)
- You can use the Automatic Satellite Programme Recording function (☞ pg. 48) with this connection.
- To record a programme via the satellite receiver, select L-2 mode by pressing **PR +/-** so that "L-2" appears on the front display panel.
- To receive a scrambled broadcast, descramble the signal with the decoder connected to the satellite receiver.
- For details, refer to the instruction manual of the satellite receiver and decoder.

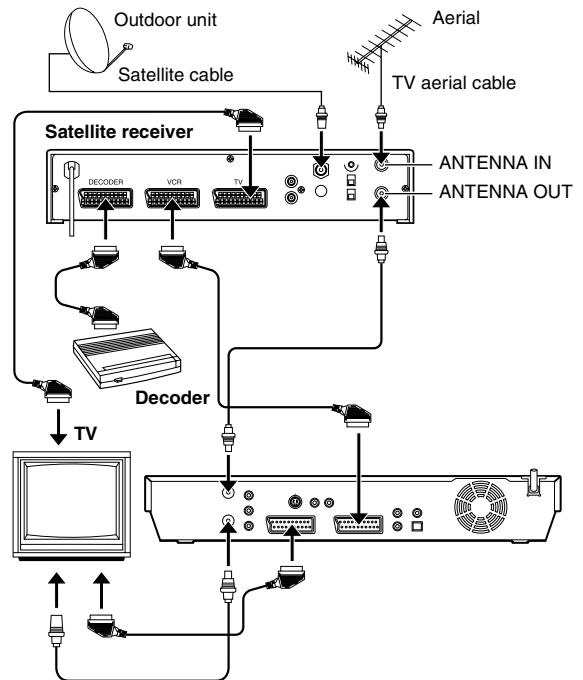

Connecting To A Dolby Digital Decoder Or An Amplifier With Built-in DTS

These instructions enable you to connect your unit to a Dolby Digital decoder or an amplifier with built-in DTS.

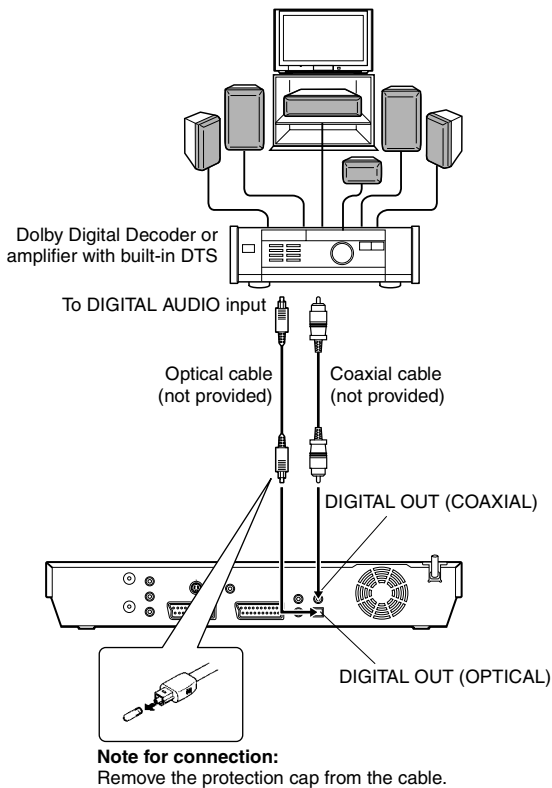

1 Connect the unit and a Dolby Digital decoder or an amplifier with built-in DTS using either an optional optical cable or an optional coaxial cable.

NOTES:

- For Dolby Digital sound, set "DIGITAL AUDIO OUT" to "DOLBY DIGITAL/PCM". (☞ pg. 67)
- For DTS sound, set "DIGITAL AUDIO OUT" to "STREAM/PCM". (☞ pg. 67)

CAUTIONS:

- This unit has a dynamic range of more than 110 dB with regards to its Hi-Fi audio capability. It is recommended that you check the maximum level if you are going to listen to the Hi-Fi audio signals through a stereo amplifier. A sudden surge in the input level to the speakers may damage them.
- Some speakers and televisions are specially shielded to prevent television interference. If both are of the non-shielded type, do not place the speakers adjacent to the TV set as this can adversely affect the playback picture.

When you can't switch the audio channel of a bilingual programme

When the unit is connected with a digital audio device using an optional optical cable and "DIGITAL AUDIO OUT" is set to "DOLBY DIGITAL/PCM", it is not possible to switch the audio channel of a bilingual programme recorded on a DVD-RAM or DVD-RW (VR mode) disc. In this case, perform the following steps using the remote control to switch "DIGITAL AUDIO OUT" from "DOLBY DIGITAL/PCM" to "PCM ONLY". (☞ pg. 29)

- 1 Press **SET UP** to access the Main Menu screen.
- 2 Press ◀ ▶ to select "DVD VIDEO SET UP", then press ▼.
- 3 Press ◀ ▶ to select "AUDIO OUTPUT", then press ▼.
- 4 Press ▲ ▼ to select "DIGITAL AUDIO OUT", then press **ENTER**.
- 5 Press ▲ ▼ to select "PCM ONLY", then press **ENTER**. (☞ pg. 67)
- 6 Press **SET UP** to complete the setting.
- 7 Press **AUDIO** to select the desired audio channel.

Connecting/Using A Decoder

The L-2 IN/DECODER connector can be used as an input connector for an external decoder (descrambler). Simply connect a decoder and you can enjoy a variety of programming that is available through scrambled channels.

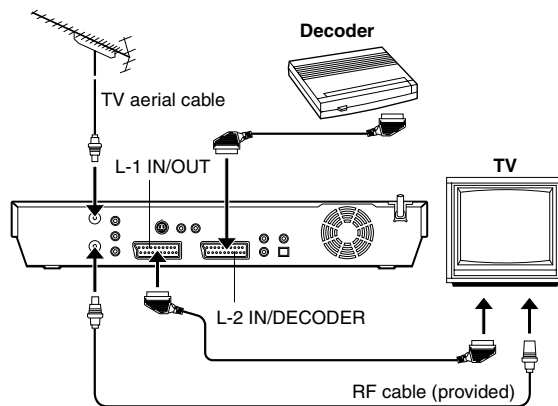

- 1 Set "L-2 SELECT" to "DECODER". (☞ pg. 61)
- 2 Connect your unit's L-2 IN/DECODER connector to the decoder's 21-pin SCART connector using a 21-pin SCART cable.
- 3 Perform the procedure as described in "When Receiving A Scrambled Broadcast" (☞ pg. 72).

Mode Set

- Turn on the unit.
- Turn on the TV and select the AV mode.
- Slide the **TV/CABLE/SAT/DVD** switch to **DVD**.

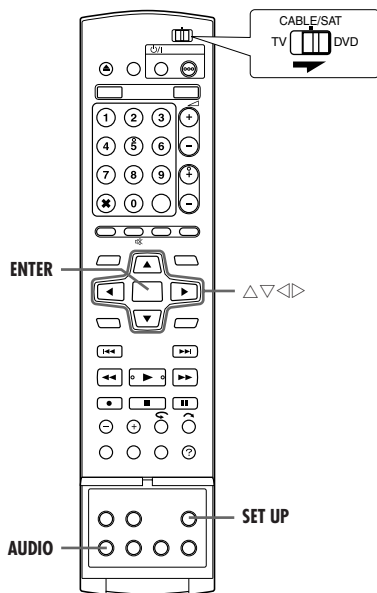

Various modes of this unit are categorized into menus nested in 2 levels shown in the following table. To change the settings of these modes, find the desired mode in the menu (for details on each menu, see pages 67 through 68), then follow the procedure below.

DVD VIDEO SET UP	LANGUAGE SET (☞ pg. 21) AUDIO OUTPUT (☞ pg. 67) PARENTAL LOCK (☞ pg. 34) DISC PLAY SET UP (☞ pg. 68)
HDD/DVD SET UP	HDD SET UP (☞ pg. 68) DVD SET UP (☞ pg. 68) DISC SET UP (☞ pg. 74, 75)
FUNCTION SET UP	REC/PLAY SET UP (☞ pg. 68) DISPLAY SET (☞ pg. 69) VIDEO IN/OUT (☞ pg. 22, 61)
INITIAL SET UP	TUNER SET (☞ pg. 70) CLOCK SET (☞ pg. 73)

- The procedure below shows how to set the desired option of the "AUDIO REC" mode as an example.

- 1 Press **SET UP** to access the Main Menu screen.
- 2 Press $\triangleleft \triangleright$ to select "FUNCTION SET UP", then press ∇ .
- 3 Press $\triangleleft \triangleright$ to select "REC/PLAY SET UP", then press ∇ .
- 4 Press $\triangle \nabla$ to select "AUDIO REC", then press **ENTER**.
- 5 Press $\triangle \nabla$ to select the desired option, then press **ENTER**.
- 6 Press **SET UP** to complete the setting.

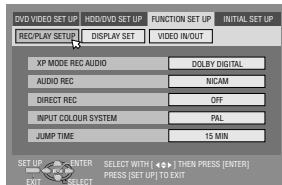

* The **boldface** settings below indicate the settings at your purchase.

AUDIO OUTPUT

■ DIGITAL AUDIO OUT — DOLBY DIGITAL/PCM / STREAM/PCM / PCM ONLY

Set to the appropriate mode according to the type of the device connected to DIGITAL OUT connector.

DOLBY DIGITAL/PCM: Select this when you connect the digital input connector of a Dolby Digital decoder or an amplifier with a built-in Dolby Digital decoder.

STREAM/PCM: Select this when you connect the digital input connector of an amplifier with a built-in DTS, Dolby Digital, or MPEG multichannel decoder.

PCM ONLY: Select this when you connect the linear PCM digital input of other audio equipment (amplifier, MD or DAT deck, etc.).

NOTES:

- This setting functions also when HDD is active.
- If you watch or play back a title which contains multiple audio languages, select "PCM ONLY" in advance and choose main or sub audio with **AUDIO**.

■ ANALOG AUDIO OUT — STEREO / DOLBY SURROUND

Select the appropriate setting to accommodate the unit to the connected A/V equipment. This function takes effect when a DVD VIDEO disc is played back.

STEREO: Select this when listening to conventional two-channel stereo audio with the unit's AUDIO OUT connectors connected to a stereo amplifier/receiver or TV set, or in case you want to record the audio from a DVD VIDEO disc to a Mini Disc, etc.

DOLBY SURROUND: Select this when listening to multichannel surround audio with the unit's AUDIO OUT connectors connected to an amplifier/receiver with a built-in surround decoder or a surround decoder.

■ D. RANGE CONTROL — NORMAL / WIDE RANGE / TV MODE

The dynamic range (the difference between the loudest sound and the quietest one) can be compressed during playback of a programme encoded in Dolby Digital format.

This function takes effect when a DVD VIDEO disc recorded in Dolby Digital format is played back at low or middle volume.

NORMAL: Normally select this setting to activate this function.

WIDE RANGE: Select this to deactivate this function when you enjoy wide dynamic range programme.

TV MODE: Select this when you hear the sound through the TV's speaker(s).

NOTES:

- This function takes no effect on programmes other than that recorded in Dolby Digital format.
- This function does not work when Simulated Surround Effect is activated. (☞ pg. 32)
- The effect of "NORMAL" and "WIDE RANGE" may not be different depending on discs.

■ OUTPUT LEVEL — STANDARD / LOW

You can lower the output level of analog audio to accommodate the unit to the connected A/V equipment.

STANDARD: Normally select this setting.

LOW: The output level of analog audio is lowered.

DISC PLAY SET UP**■ RESUME — OFF / ON / DISC RESUME**

When this function is set to "ON" or "DISC RESUME", you can use the resume function. (☞ pg. 27)

OFF: You cannot use the resume function.

ON: You can start playback from the resume point of the placed disc.

DISC RESUME: The unit retains a memory of the resume points of the last 30 discs played back, even though they have been ejected.

NOTE:

"DISC RESUME" setting works on DVD VIDEO, VCD, SVCD and already finalised DVD-R/DVD-RW (video mode) discs. For other types of discs, the function under "ON" setting will be applied even if "RESUME" is set to "DISC RESUME".

HDD SET UP**■ LIVE MEMORY — OFF / 30 MIN / 1 HR / 3 HR**

When this function is set to "30 MIN", "1 HR" or "3 HR", you can apply the selected time length to "Temporary recording for Live Memory" (☞ pg. 41).

DVD SET UP**■ SAVE AS LIBRARY — OFF / ON**

When this function is set to "ON", the recording information is automatically stored in the library. For details, refer to "Modify Library Information" (☞ pg. 54).

■ CONTINUOUS PLAY — OFF / ON

When this function is set to "ON", multiple titles on a disc are played back continuously one after another.

■ VIDEO MODE RECORDING ASPECT — PRIORITIZE 4:3 / PRIORITIZE 16:9

This is the setting for the aspect ratio used when you dub titles to DVD discs in video mode. If the titles you want to dub are recorded in both 16:9 and 4:3, you must select one aspect ratio.

PRIORITIZE 4:3: If you select "PRIORITIZE 4:3", even a title recorded in 16:9 is dubbed in 4:3.

PRIORITIZE 16:9: If you select "PRIORITIZE 16:9", even a title recorded in 4:3 is dubbed in 16:9.

■ VIDEO MODE RECORDING AUDIO — MAIN / SUB

This is the setting for the audio channel to be selected when dubbing titles to DVD discs in video mode. Select either one of the two settings if the titles to be dubbed have two audio channels.

MAIN: Select this to dub the main channel.

SUB: Select this to dub the sub channel.

■ MP3 & WMA / JPEG — MP3 & WMA / JPEG

You can select files to play back, when both MP3/WMA files and JPEG files are recorded on a disc.

MP3 & WMA: Select this to play back MP3/WMA files.

JPEG: Select this to play back JPEG files.

REC/PLAY SET UP**■ XP MODE REC AUDIO — DOLBY DIGITAL / LINEAR PCM**

You can select the audio format when you record a title in XP mode. When this function is set to "LINEAR PCM", you can obtain a high-quality audio sound.

DOLBY DIGITAL: To record in Dolby Digital format.

LINEAR PCM: To record in Linear PCM format.

■ AUDIO REC — NICAM / MONO

You can select the desired NICAM audio channel to be recorded on a DVD-R/RW (Video mode) disc.

NICAM: To record the main and sub language of NICAM audio.

MONO: To record the standard (monaural) sound of NICAM audio.

NOTE:

This function works only for the NICAM bilingual programme.

■ DIRECT REC — OFF / ON

When this function is set to "ON", you can easily start recording the programme that you are watching on your TV. Press and hold ● and press ► on the remote control, or press ● on the unit.

NOTES:

- When you use the Direct Rec function, be sure to use a TV offering T-V LINK, etc. and connect a fully-wired 21-pin SCART cable between the unit and the TV. (☞ pg. 17)
- If "DIRECT REC" is set to "OFF", the ● button functions as described in "Basic Recording" (☞ pg. 35, 38).
- During Direct Rec, "--" appears on the front display panel.
- If a programme is recorded with the Direct Rec, the station name will not be registered in the library. "-- --" will be displayed for the station name.
- Even if there is no power supply for more than 60 minutes, the unit keeps the setting.

■ INPUT COLOUR SYSTEM — PAL / SECAM

You can play back PAL discs, or record PAL and SECAM signals on this unit. Select the appropriate colour system.

PAL: To record PAL signals.

SECAM: To record SECAM signals.

■ JUMP TIME — 15 MIN / 30 MIN / 1 HR

You can locate a scene ahead of or behind the currently viewed one by jumping a selected time interval during playback (or Live Memory Playback) or recording (or Live Memory Recording). For details, refer to "Jump Search" (☞ pg. 43).

DISPLAY SET

■ SUPERIMPOSE — OFF / AUTO

When this function is set to "AUTO", various operational indicators appear on the TV screen. Messages appear in the selected language. (☞ pg. 21)

OFF: To turn off superimposed indications.

AUTO: To superimpose operational indications for approximately five seconds just after the corresponding operation.

NOTES:

- Even when "SUPERIMPOSE" is set to "OFF", you can display the various operational indicators by pressing **ON SCREEN**. To clear the operational indicators, press **ON SCREEN** again.
- When you use this unit as the source player for editing, be sure to set "SUPERIMPOSE" to "OFF" before starting. (☞ pg. 60)
- When you select "AUTO", during playback, the operation mode indicators may be disturbed depending on the type of disc being used.

■ BLUE BACK — ON / OFF

When this function is set to "ON", the TV screen becomes all blue when receiving a channel not in use.

NOTE:

When you want to receive an unstable channel with poor signals, set this function to "OFF".

■ DIMMER — BRIGHT / DIMMED1 / DIMMED2 / OFF

You can change the brightness of the front display panel.

BRIGHT: Normally select this.

DIMMED1/DIMMED2: To change the brightness level. (Blue lamp on the front display panel becomes dimmer.)

OFF: To dim the front display panel. (Blue lamp on the front display panel is turned off.)

■ POWER SAVE — OFF / ON

When this function is set to "ON", you can reduce the power consumption while the unit is turned off.

NOTES:

- During Power Save mode —
 - the front display panel will be turned off.
 - the Just Clock function (☞ pg. 73) does not work.
- Power Save does not work when —
 - the unit is in the Timer mode.
 - the unit's power is turned off after timer-recording or Instant Timer Recording.
 - the Automatic Satellite Programme Recording mode is engaged. (☞ pg. 48)
 - "L-2 SELECT" is set to "DECODER", "SAT VIDEO" or "SAT S-VIDEO". (☞ pg. 61)
- It takes some time for the unit to complete initialisation after you turn on the unit power, with "WAKE UP" blinking on the front display panel.

■ ON SCREEN LANGUAGE

This unit offers you the choice to view on-screen messages in 10 different languages. Though Auto Set Up selects the language automatically (☞ pg. 20), you can change the language setting manually as required.

For details, refer to "On-screen Language Set" (☞ pg. 21).

Scan Mode Set

If you connect the unit and TV with Component Video Connection (☞ pg. 17), you can select the scan mode from two modes: Interlaced scan mode which is used in the conventional TV system, and Progressive scan mode which enables reproduction of higher-quality images.

■ Interlaced scan

In the conventional video system, a picture is shown on the display monitor in two halves. The Interlaced scan system places lines of the second half of the picture in-between lines of the first half of the picture.

■ Progressive scan

Progressive scan displays all the horizontal lines of a picture at one time, as a single frame. This system can convert the interlaced video from DVD into progressive format for connection to a progressive display. It dramatically increases the vertical resolution.

ATTENTION:

Your TV needs to be compatible with PAL Progressive.

- Turn on the unit.
- Turn on the TV and select the AV mode.
- Slide the **TV/CABLE/SAT/DVD** switch to **DVD**.

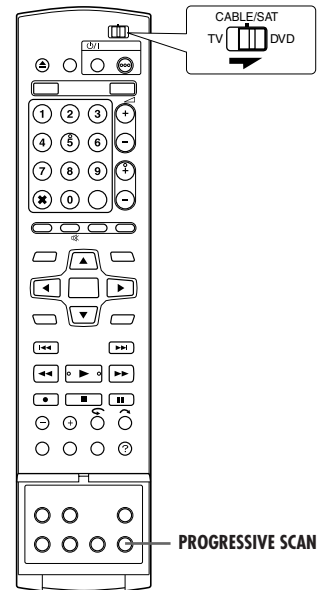

1 Press **PROGRESSIVE SCAN** for 3 or more seconds.

- Video output indicator (P) lights on the front display panel if Progressive scan mode has been established. (☞ pg. 12)
- Each press of **PROGRESSIVE SCAN** for 3 or more seconds switches the scan mode.

NOTES:

- When the progressive mode is set, be sure to set "L-1 OUTPUT" to "COMPONENT". (☞ pg. 61) Progressive scan is output only from COMPONENT VIDEO OUT connector.
- Interlaced scan mode is the setting at your purchase.
- Interlaced scan mode might be suitable depending on video material.
- Scan mode cannot be set while menu screen is displayed.
- When Progressive scan mode is engaged, no video signal is output from S-VIDEO OUT connector and L-1 IN/OUT connector.

SHOWVIEW™ System Setup

IMPORTANT:

Normally, Auto Set Up (pg. 18), Preset Download (pg. 19) or Auto Channel Set (pg. 70) sets the Guide Program numbers automatically. You need to set the Guide Program numbers manually only in the following cases.

- When timer-programming with the SHOWVIEW system, the channel position, where the station you wish to record is received on your unit, is not selected, **OR** when you add a channel after Auto Set Up, Preset Download or Auto Channel Set has taken place, —Set the Guide Program number for that station manually.
- When you wish to timer-record a satellite programme with the SHOWVIEW system, —Set the Guide Program numbers for all satellite broadcasts received on your satellite receiver.

- Turn on the unit.
- Turn on the TV and select the AV mode.
- Slide the **TV/CABLE/SAT/DVD** switch to **DVD**.

Guide Program Number Set

- 1 Press **SET UP** to access the Main Menu screen.
- 2 Press $\triangleleft \triangleright$ to select "INITIAL SET UP", then press ∇ .
- 3 Press $\triangleleft \triangleright$ to select "TUNER SET", then press ∇ .
- 4 Press $\triangle \nabla \triangleleft \triangleright$ to select "GUIDE PROG SET", then press **ENTER**.

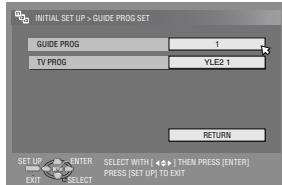
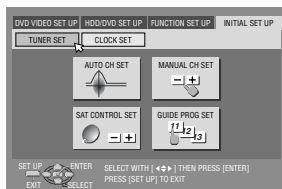

- 5 Press $\triangle \nabla$ to select "GUIDE PROG", then press **ENTER**.
- 6 Press $\triangle \nabla$ to select the Guide Program number for the desired station as shown in the TV listings. Then press **ENTER**.
 - To change the Guide Program number in 10 increments, press and hold $\triangle \nabla$.
- 7 Press $\triangle \nabla$ to select "TV PROG", then press **ENTER**. Press $\triangle \nabla$ to select the number of the unit's channel position on which the Guide Program number's broadcast is received by the unit or the satellite receiver. Then press **ENTER**.
 - Pressing **AUX** changes "TV PROG" to "SAT".
 - To timer-record a satellite programme with the SHOWVIEW system, you need to install the provided Satellite Controller and perform the procedure described in "Satellite Receiver Control Setting" (pg. 23).
 - Repeat steps 5 – 7 as necessary.
- 8 Press **SET UP** to complete the setting.

Guide Program Number

"Guide Program (GUIDE PROG) number" refers to the assigned TV station numbers, according to broadcast area, for the SHOWVIEW timer recording. The Guide Program Numbers can be found in most TV listings.

Tuner Set

Your unit needs to memorise all necessary stations in channel positions in order to record TV programmes. Auto Channel Set automatically assigns all receivable stations in your area to call them up by using the **PR +/-** buttons without going through any vacant channels.

- Turn on the unit.
- Turn on the TV and select the AV mode.
- Slide the **TV/CABLE/SAT/DVD** switch to **DVD**.

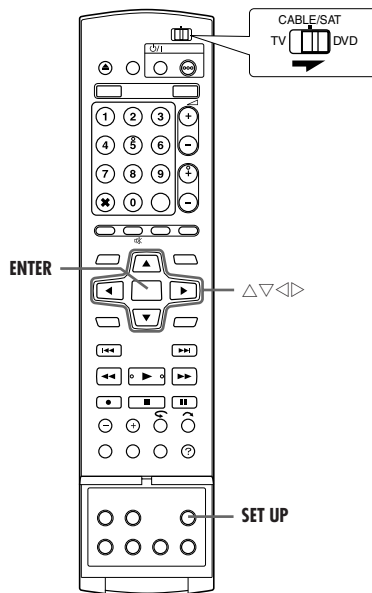

IMPORTANT:

Perform the following steps only if —
 — Auto Channel Set has not been set correctly by Auto Set Up or by Preset Download. (pg. 18, 19)
 — you have moved to a different area or if a new station starts broadcasting in your area.

Auto Channel Set

- 1 Press **SET UP** to access the Main Menu screen.
- 2 Press $\triangleleft \triangleright$ to select "INITIAL SET UP", then press ∇ .
- 3 Press $\triangleleft \triangleright$ to select "TUNER SET", then press ∇ .
- 4 Press $\triangle \nabla \triangleleft \triangleright$ to select "AUTO CH SET", then press **ENTER**.
- 5 Press $\triangle \nabla \triangleleft \triangleright$ to select your country's name, then press **ENTER**.
- 6 Press $\triangle \nabla \triangleleft \triangleright$ to select the language of your choice.
- 7 Press **ENTER** twice.

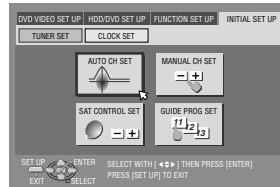

- When you have connected the unit to a TV offering T-V Link via a fully-wired 21-pin SCART cable (pg. 17), the unit automatically performs the Preset Download and the T-V LINK screen will appear. (pg. 19)
- The Auto Set screen appears, and remains on screen while the unit searches for receivable stations.

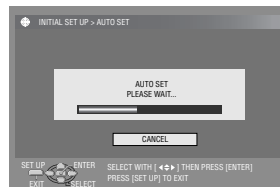

8 View the Confirmation screen. "AUTO SET COMPLETED" or "SCAN COMPLETED" is displayed on the TV screen.

9 Press **SET UP** to complete the setting.

- Using the Confirmation screen, you can skip or add channel positions, enter station names and perform other operations. Refer to pages 71 – 72 for the procedures.
- Depending on reception conditions, the stations may not be stored in order, and the station names may not be stored correctly.
- For information on scrambled broadcasts, refer to "When Receiving A Scrambled Broadcast" (☞ pg. 72).

IMPORTANT:

- In certain reception conditions, station names may not be stored correctly, and Auto Guide Program Number Set may not work properly. When the Guide Program numbers are not set properly, the programme that you do not intend to record will be timer-recorded by the SHOWVIEW system of the unit. When programming the timer using the SHOWVIEW system, be sure to check the desired channel is selected correctly. (☞ pg. 44, "ShowViewTM Timer Programming")
- Your unit memorises all receivable stations even if reception of some of them is poor. You can delete those stations with an unacceptable picture from the list. (☞ pg. 72, "Delete A Channel")

NOTES:

- Fine tuning is performed automatically during Auto Channel Set. If you want to perform tuning manually, refer to "Fine-Tuning Channels Already Stored" (☞ pg. 72).
- If you perform Auto Channel Set when the aerial cable is not connected properly, "SCAN COMPLETED –NO SIGNAL–" appears on the TV screen in step 8. In such a case, make sure of the aerial connection and press **ENTER**; Auto Channel Set will start again.
- If no sound accompanies the picture or the audio sounds unnatural on some channels that have been stored by Auto Set Up, the TV system setting for those channels may be incorrect. Select the appropriate TV system for those channels. (☞ pg. 72, "INFORMATION")

Manual Channel Set

Store channels that were not stored during Auto Set Up (☞ pg. 18), Preset Download (☞ pg. 19) or Auto Channel Set (☞ pg. 70).

1 Press **SET UP** to access the Main Menu screen.

2 Press $\triangleleft \triangleright$ to select "INITIAL SET UP", then press ∇ .

3 Press $\triangleleft \triangleright$ to select "TUNER SET", then press ∇ .

4 Press $\triangle \nabla \triangleleft \triangleright$ to select "MANUAL CH SET", then press **ENTER**. The Manual Channel Set screen appears.

5 Press $\triangleleft \triangleright$ to select "EDIT", then press **ENTER**.

6 Press $\triangle \nabla \triangleleft \triangleright$ to select a blank position in which you want to store a channel, then press **ENTER**. The Confirmation screen appears.

7 Press $\triangle \nabla$ to select "BAND", then press **ENTER**.

(Example) To store in position 12.

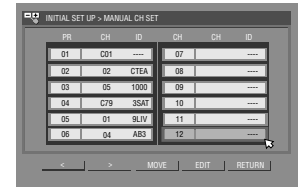

The programme currently received on the selected channel position appears behind the confirmation screen.

8 Press $\triangle \nabla$ to change the band between CH (regular) and CC (cable), then press **ENTER**.

9 Press $\triangle \nabla$ to select "CH", then press **ENTER**.

10 Press $\triangle \nabla$ to input the channel number you want to store.

- To enter the registered station name (☞ pg. 85), press $\triangle \nabla$ to select "ID", then press **ENTER**. Press $\triangle \nabla$.
- For fine tuning adjustment, press $\triangle \nabla$ to select "FINE", then press **ENTER**. Press $\triangle \nabla$ to perform fine-tuning.
- When storing a channel that sends scrambled broadcasts, press $\triangle \nabla$ to select "DECODER", then press **ENTER**. Press $\triangle \nabla$ to set "DECODER" to "ON" ("OFF" is the default setting).
- When "L-2 SELECT" is set to "VIDEO", "S-VIDEO", "SAT VIDEO" or "SAT S-VIDEO", the "DECODER" setting cannot be changed. (☞ pg. 61)

11 Press **ENTER** to enter new channel information. The Confirmation screen appears.

12 Press **SET UP** to close the Confirmation screen.

- To change positions, see "Change Station Channel Position" (☞ pg. 72).
- If you wish to set station names other than the ones registered in your unit, see "Set Stations (B)" (☞ pg. 72).

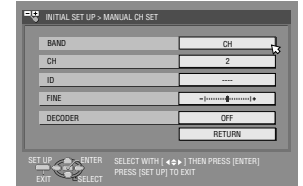

ATTENTION:

Guide Program numbers are not set when channels are stored manually. (☞ pg. 70, "ShowViewTM System Setup")

Delete A Channel

- 1 Perform steps 1 – 5 of “Manual Channel Set” (☞ pg. 71).
- 2 Press $\Delta \nabla \triangleleft \triangleright$ to select the channel you want to delete.
- 3 Press **X** to delete a channel. The channel next to the cancelled one moves up one line.
 - Repeat steps 2 – 3 as necessary.
- 4 Press **SET UP** to close the Confirmation screen.

Change Station Channel Position

- 1 Perform steps 1 – 4 of “Manual Channel Set” (☞ pg. 71).
- 2 Press $\triangleleft \triangleright$ to select “MOVE”, then press **ENTER**.
- 3 Press $\Delta \nabla \triangleleft \triangleright$ to select the channel you want to move, then press **ENTER**.
- 4 Press $\Delta \nabla \triangleleft \triangleright$ to select the new channel position, then press **ENTER**.

Example: If you moved the station in position 4 to position 2, the stations originally in positions 2 and 3 each move down one space.

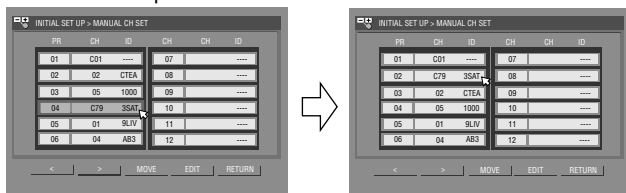

- Repeat steps 3 – 4 as necessary.
- 5 Press **SET UP** to close the Confirmation screen.

When Receiving A Scrambled Broadcast

- 1 Set “L-2 SELECT” to “DECODER”. (☞ pg. 61)
- 2 Perform steps 1 – 5 of “Manual Channel Set” (☞ pg. 71).
- 3 Press $\Delta \nabla \triangleleft \triangleright$ to select the channel position broadcasting scrambled programmes, then press **ENTER**. The Confirmation screen appears.
- 4 Press $\Delta \nabla$ to select “DECODER”, then press **ENTER**.
- 5 Press $\Delta \nabla$ to set “DECODER” to “ON”, then press **ENTER**.
- 6 Press **RETURN** to return to the Manual Channel Set screen.
 - Repeat steps 3 – 5 as necessary.
- 7 Press **SET UP** to close the Confirmation screen.

INFORMATION

If you live in Eastern Europe, “TV SYSTEM” setting appears instead of “DECODER” setting on the Manual Channel Set screen. When you can see the picture but can hear no audio, select appropriate TV system (D/K or B/G). Normally, TV programmes are broadcast as follows.

For Eastern Europe : D/K

For Western Europe : B/G

- 1 Select a country in Eastern Europe in step 5 of “Auto Channel Set” (☞ pg. 70).
- 2 Press $\Delta \nabla$ to select “TV SYSTEM” in step 7 of “Manual Channel Set” (☞ pg. 71).
- 3 Press $\Delta \nabla$ to select appropriate TV System (D/K or B/G).

Set Stations (A)

Set station names that are registered in your unit.

- 1 Perform steps 1 – 5 of “Manual Channel Set” (☞ pg. 71).
- 2 Press $\Delta \nabla \triangleleft \triangleright$ to select the channel you want to modify, then press **ENTER**. The Confirmation screen appears.
- 3 Press $\Delta \nabla$ to select “ID”, then press **ENTER**.
- 4 Move the arrow to the left ID selection column. Registered station names (ID) (☞ pg. 85) appear as you press $\Delta \nabla$.
- 5 Press **ENTER** to select the desired ID, then press **ENTER** again to select “OK”.
- 6 Press **RETURN** to return to the Manual Channel Set screen.
 - Repeat steps 2 – 5 as necessary.
- 7 Press **SET UP** to close the Confirmation screen.

Set Stations (B)

Set station names other than the ones registered in your unit.

- 1 Perform steps 1 – 5 of “Manual Channel Set” (☞ pg. 71).
- 2 Press $\Delta \nabla \triangleleft \triangleright$ to select the channel you want to modify, then press **ENTER**. The Confirmation screen appears.
- 3 Press $\Delta \nabla$ to select “ID”, then press **ENTER**.
- 4 Press $\Delta \nabla \triangleleft \triangleright$ to select the desired characters (A–Z, 0–9, –, *, +, _ (space)), then press **ENTER**.
 - Enter the remaining characters the same way (maximum of 4).
- 5 After entering all characters, press $\Delta \nabla \triangleleft \triangleright$ to select “OK”, then press **ENTER**.
- 6 Press **RETURN** to return to the Manual Channel Set screen.
 - Repeat steps 2 – 5 as necessary.
- 7 Press **SET UP** to close the Confirmation screen.

NOTE:

The characters available for the station name (ID) are A–Z, 0–9, –, *, +, _ (space) (maximum of 4).

Fine-Tuning Channels Already Stored

- 1 Perform steps 1 – 5 of “Manual Channel Set” (☞ pg. 71).
- 2 Press $\Delta \nabla \triangleleft \triangleright$ to select the channel you want to fine-tune, then press **ENTER**. The Confirmation screen appears.
- 3 Press $\Delta \nabla$ to select “FINE”, then press **ENTER**.
- 4 Press $\Delta \nabla$ until the picture appears in its best quality, then press **ENTER**.
 - Repeat steps 2 – 4 as necessary.
- 5 Press **RETURN** to return to the Manual Channel Set screen.
- 6 Press **SET UP** to close the Confirmation screen.

Clock Set

IMPORTANT:

If you performed Auto Set Up (pg. 18) or Preset Download (pg. 19), without ever having set the clock previously, the unit's built-in clock is also set automatically. Perform the following steps only if —
— Auto Clock Set has not been performed correctly by Auto Set Up or Preset Download.

OR

— you want to change Just Clock setting. ("Just Clock" in the right column)

- Turn on the unit.
- Turn on the TV and select the AV mode.
- Slide the **TV/CABLE/SAT/DVD** switch to **DVD**.

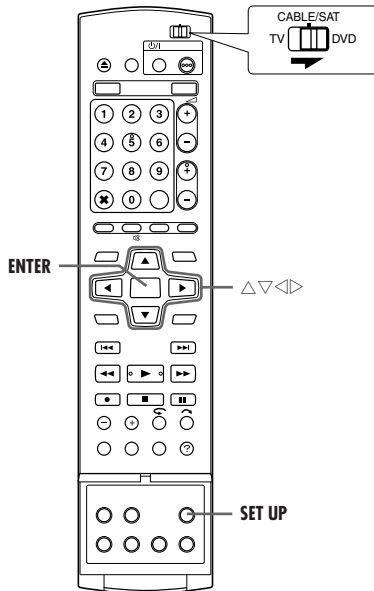

- 1 Press **SET UP** to access the Main Menu screen.
- 2 Press $\triangleleft \triangleright$ to select "INITIAL SET UP", then press ∇ .
- 3 Press $\triangleleft \triangleright$ to select "CLOCK SET", then press ∇ .

NOTE:

When you have selected **MAGYARORSZÁG, ČESKÁ REPUBLIKA, POLSKA** or **OTHER EASTERN** for the country setting (pg. 18), you cannot use Just Clock function. Skip steps 5 and 6.

- 4 Press $\triangle \nabla$ to select "YEAR", then press **ENTER**. Press $\triangle \nabla$ to set the year, then press **ENTER**.

- Repeat the same procedure to set the date and time.
- When you set the date, press and hold $\triangle \nabla$ to change the date by 15 days.
- When you set the time, press and hold $\triangle \nabla$ to change the time by 30 minutes.

- 5 Press $\triangle \nabla$ to select "JUST CLOCK", then press **ENTER**. Press $\triangle \nabla$ to set to the desired mode, then press **ENTER**.

- The default setting is "OFF".
- For the Just clock function, refer to "Just Clock" on the right column.
- If you set to "OFF", you can disregard the next step as you won't be able to receive regular clock adjustments.

- 6 Press $\triangle \nabla$ to select "TV PROGRAMME", then press **ENTER**. Press $\triangle \nabla$ to set the channel position to the number representing the station transmitting clock setting data, then press **ENTER**.

- The unit is preset to receive clock setting and adjustment data from channel position 1.

- 7 Press **SET UP** to start the clock operation.

NOTES:

- Just Clock (when set to "ON") adjusts the unit's built-in clock every hour, except for 23:00, 0:00, 1:00 and 2:00.
- Just Clock is not effective when:
 - the unit's power is on.
 - the unit is in the Timer mode.
 - a difference of more than 3 minutes exists between the built-in clock's time and the actual time.
 - the unit is in the Automatic Satellite Programme Recording mode. (pg. 48)
 - the unit is in the Power Save mode. (pg. 69)
 - "L-2 SELECT" is set to "SAT VIDEO" or "SAT S-VIDEO". (pg. 61)
- If Just Clock is set to "ON", the unit's clock is automatically adjusted at the start/end of Summer Time.
- Just Clock may not function properly depending on the reception condition.

Just Clock

The Just Clock function provides accurate time keeping through automatic adjustments at regular intervals, by reading data from a PDC signal.

The Just Clock option can be set to "ON" or "OFF" at the Clock Set screen (the default setting is "OFF").

IMPORTANT:

If you turn off Just Clock, the accuracy of your unit's built-in clock may be reduced, which could adversely effect timer recording. We recommend you to keep Just Clock on. In cases where the clock setting data from a PDC signal is incorrect, however, you are advised to keep Just Clock set to "OFF".

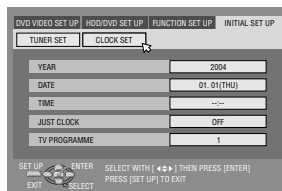

Format A Disc (DVD Deck Only)



Some DVD-RAM/RW discs are unformatted. Format the disc when you use an unformatted disc or you want to delete all recordings and data on the disc.

ATTENTION:

- When a disc is formatted, all recordings and data are erased. It is impossible to restore them.
- Never turn off the unit or disconnect the mains power cord while "NOW FORMATTING..." is displayed on the TV screen.

- Turn on the unit.
- Turn on the TV and select the AV mode.
- Slide the **TV/CABLE/SAT/DVD** switch to **DVD**.
- Load a DVD-RAM/RW disc to format.

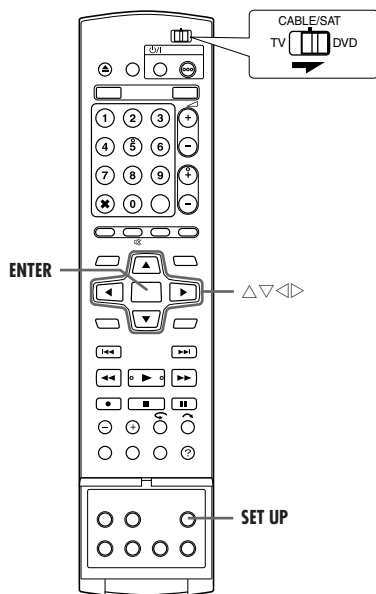

Format A DVD-RAM Disc

- 1 Press **SET UP** to access the Main Menu screen.
- 2 Press $\triangleleft \triangleright$ to select "HDD/DVD SET UP", then press ∇ .
- 3 Press $\triangleleft \triangleright$ to select "DISC SET UP", then press ∇ .
- 4 Press $\triangle \nabla \triangleleft \triangleright$ to select "FORMAT", then press **ENTER**. Press $\triangleleft \triangleright$ to select "OK", then press **ENTER**.
- 5 Press $\triangleleft \triangleright$ to select "OK", then press **ENTER**.

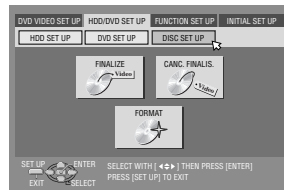

Format A DVD-RW Disc

- 1 Perform steps 1 to 3 of "Format A DVD-RAM Disc" on the above before continuing.
- 2 Press $\triangle \nabla \triangleleft \triangleright$ to select "FORMAT", then press **ENTER**. Press $\triangleleft \triangleright$ to choose "VR MODE" or "VIDEO MODE", then press **ENTER** when "DISC WILL BE FORMATTED" appears on the TV screen.
 - "VR MODE": To be chosen when you want to record, erase, or edit data on the disc repeatedly.
 - "VIDEO MODE": To be chosen when you want to erase all the data on the disc once played back to record new data, or play back the disc on other DVD players.
- 3 Press $\triangleleft \triangleright$ to select "OK", then press **ENTER**.

NOTES:

- It is impossible to format Version 1.0 DVD-RW discs in Video mode.
- It is impossible to format DVD-R discs.
- All the titles on a disc will be deleted once the disc is formatted even if they are protected titles. (pg. 51)

Finalise A Disc (DVD Deck Only)



Finalising DVD-R/RW discs recorded on this unit makes it possible for the discs to be played back on other DVD players. DVD-RW discs are finalised in the mode that the discs were formatted, enabling playback on compatible DVD players.

Title names input in the Library Database Navigation are registered as title names in the DVD menu. (ⓘ pg. 50)

- Turn on the unit.
- Turn on the TV and select the AV mode.
- Slide the **TV/CABLE/SAT/DVD** switch to **DVD**.
- Load a DVD-R/RW disc to finalise.

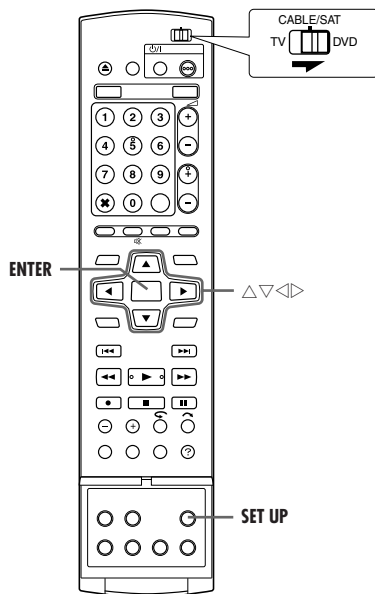

Before finalising

- It is possible to record on a blank space.
- It is possible to enter title names. (ⓘ pg. 50)
- It is possible to delete titles. (ⓘ pg. 51)
- It is impossible to overwrite recorded areas of DVD-R discs.
- Available recording capacity does not increase even if a recorded title is deleted from a DVD-R disc.
- It is impossible to record or edit DVD-R/RW discs recorded on other devices even if they have not been finalised.

After finalising (For DVD-R/RW (Video mode) discs)

- Video and audio that have been recorded by then are recorded in conformity to the DVD Video standard, enabling you to play back the discs as DVD VIDEO discs.
- Although DVD-R/RW discs finalised on this unit become playable on DVD players compatible with DVD-R/RW discs, some discs still may not play, for which JVC cannot take responsibility.
- Marked points marked before finalising will be deleted, and titles will be divided automatically into "chapters" approximately every 5 minutes. (ⓘ pg. 27)
- Depending on the DVD players and DVD-R/RW discs used, and on the conditions of recording, it may not be possible to play back the discs. In this case, play back the discs on this unit.
- Additional recordings become impossible.

Finalise A DVD-R/RW Disc

1 Perform steps **1** to **3** of "Format A DVD-RAM Disc" (ⓘ pg. 74) before continuing.

2 Press $\Delta \nabla \triangleleft \triangleright$ to select "FINALIZE", then press **ENTER**. Press $\triangleleft \triangleright$ to select "OK", then press **ENTER**.

3 Press $\triangleleft \triangleright$ to select "OK", then press **ENTER**.

4 Press **SET UP** to return to the normal screen.

- Menu screen is cleared.
- Once a DVD-R/RW (Video mode) disc has been finalised, the displays for original and play list do not appear. Only display for library appears.
- Once a DVD-RW (VR mode) disc has been finalised, it can be played on DVD players compatible with VR mode.

Cancel The Finalisation Of A DVD-RW Disc

1 Load a DVD-RW disc to cancel the disc finalisation, and perform steps **1** to **3** of "Format A DVD-RAM Disc" (ⓘ pg. 74) before continuing.

2 Press $\Delta \nabla \triangleleft \triangleright$ to select "CANC. FINALIZ.", then press **ENTER**.

3 Press $\triangleleft \triangleright$ to select "OK", then press **ENTER**.

4 Press **SET UP** to return to the normal screen.

- When the disc finalisation is cancelled, the mode in which the disc was formatted is restored, making the disc recordable. (ⓘ pg. 7, 74)



Help Function

Use this function if you encounter problems while operating this unit.

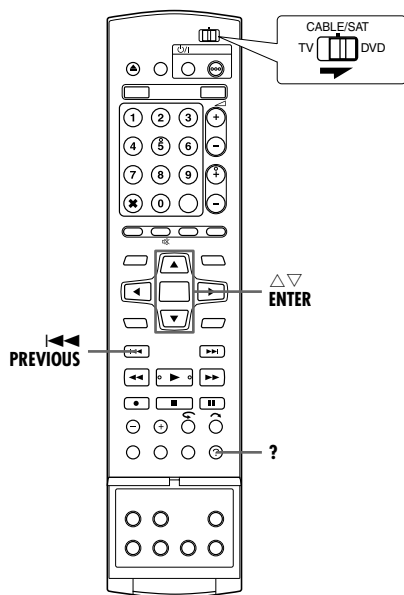
- Turn on the unit.
- Turn on the TV and select the AV mode.
- Slide the **TV/CABLE/SAT/DVD** switch to **DVD**.



1 Press **?** to access the help screen.

- An INDEX screen that contains the most common needed topics (headings) relating to the current status appears. Topics with the  icon refer to HDD deck operations and with the  icon refer to those for the DVD deck.

2 Press $\Delta \nabla$ to search for the item that describes the solution to your problem, then press **ENTER**.

- The selected help page appears.
- You can also browse help pages by pressing $\Delta \nabla$.
- To return to a previous page, press **RETURN**.

3 Press **?** to return to the normal screen.

NOTE:

You cannot perform playback, recording, timer recording, or other normal operations while accessing the help screen.



Tray Lock (DVD Deck Only)

You can lock the disc tray to prohibit the unwanted disc ejection by children.

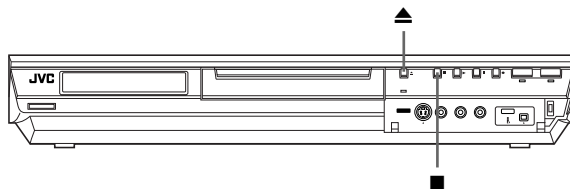

- Turn off the unit.



To lock tray

While the unit is turned off, press and hold , then press  on the unit. "LOCKED" appears on the front display panel and the disc tray is locked.

To unlock tray

While the unit is turned off, press and hold , then press  on the unit. "UNLOCK" appears on the front display panel.

Before requesting service for a problem, use this chart and see if you can solve the trouble yourself. Small problems are often easily solved, and this can save you the trouble of sending your unit off for repair.

Initialising (DVD Deck Only)

Malfunction occurs on the unit.

→ Press O/I to turn off the unit, press and hold O/I , then press \blacksquare for two seconds or more.

General

No power is supplied to the unit.

- The AC power plug is disconnected from the mains outlet.
- Connect the AC power plug to the mains outlet securely. (☞ pg. 17)

The remote control does not work properly.

- Remove the batteries, wait for 5 minutes or more, then load the batteries again.
- The setting of the remote control code is inappropriate.
- Set the same remote control code (1, 2, 3, or 4) on both the unit and the remote control. (☞ pg. 63)
- The batteries are discharged.
- Replace the dead batteries with new ones.

Dubbing from the external equipment is not possible.

- The source (another video recorder, camcorder) has not been properly connected.
- Confirm that the source is properly connected.
- All necessary power switches have not been turned on.
- Confirm that all units' power switches are turned on.
- The setting of the input channel position is inappropriate.
- Select the input channel position ("F-1", "L-1", or "L-2") that corresponds to the input terminal connected to the external equipment. (☞ pg. 60)

The on-screen display superimposed on the programme played back/received on this unit is recorded when you dub the programme to an external recording equipment.

→ Set "SUPERIMPOSE" to "OFF". (☞ pg. 69)

The unit does not operate.

- There are cases when the operation is prohibited on the disc.
- Lightning or static electricity may cause malfunction of the unit.
- Press O/I to turn the power off, then press the button again to turn the power on.

Playback (DVD Deck)

The DVD deck cannot be operated.

- The DVD deck is not selected.
- Press **DVD** so that the DVD lamp lights up on the unit.

Images do not appear on the TV screen.

- The TV receiver's channel selector is not set to the AV mode.
- Set the TV to its AV mode.
- When interlace scanned programme is played back, progressive scan mode is selected.
- Press and hold **PROGRESSIVE SCAN** until **P** disappears from the front display panel. (☞ pg. 69)

Playback does not start or stop immediately after playback is started by pressing \blacktriangleright .

On the front display panel, "NO DISC" appears.

- The disc is loaded upside down.
- Place the disc on the disc tray with the playback surface facing down. (☞ pg. 8)
- A disc not being compatible with the unit is loaded.
- Load a playable disc on the unit. (☞ pg. 5)
- A dirty disc is loaded.
- Clean the disc. (☞ pg. 9)
- Defective disc is loaded.
- Replace the warped or scratched disc with a normal one.

Images are blurred or distorted when you start High-Speed Search.

→ Images are blurred or distorted at the point where the playback speed changes and this is not a malfunction of the unit.

Playback does not start.

→ Playback does not start for approximately 30 seconds after recording is stopped and this is not a malfunction of the unit.

Playback does not start when you select a title or a chapter.

- The Parental Lock is engaged and the disc is rated higher than the set level.
- Release the Parental Lock temporarily or change the set level. (☞ pg. 34)

Playback (HDD Deck)

The HDD deck cannot be operated.

- The HDD deck is not selected.
- Press **HDD** so that the HDD lamp lights up on the unit.

Recording (DVD Deck)

The desired programme cannot be recorded.

- The channel position does not correspond to that in the receiving area.
- Set the correct channel position for the receiving broadcast. (☞ pg. 70)

Recording cannot be made.

- No disc or a disc not being compatible with the unit is loaded.
- Load a recordable disc on the unit. (☞ pg. 5)
- The disc loaded is not formatted.
- Format the disc. (☞ pg. 74)
- A finalised DVD-R disc is loaded.
- Recording cannot be made on finalised discs. Load a recordable disc on the unit.
- The disc is full or does not have enough space for the title to be recorded.
- Clear unnecessary titles on the disc or load a blank disc. (☞ pg. 51)
- The DVD-RAM disc loaded has had its protect tab slid to the protect position.
- Release the protect tab. (☞ pg. 8)

Recording (HDD Deck)

TV broadcasts cannot be recorded.

- "L-1", "L-2" or "F-1" has been selected as the input mode.
- Set to the desired channel.

Camcorder recording is not possible.

- The camcorder has not been properly connected.
- Confirm that the camcorder is properly connected.
- The input mode is not correct.
- Set the input mode to "F-1". (☞ pg. 59)

Timer Recording

Timer programming cannot be made.

- Date and time is not correct.
- Set date and time correctly. (☞ pg. 73)
- Timer recording is in progress.
- Timer programming can't be performed while a timer recording is in progress. Wait until it finishes.

Timer programming recording does not start.

- Date and time is not correct.
- Set date and time correctly. (☞ pg. 73)

SHOWVIEW Timer Programming cannot be made.

- Date and time set on the unit is not correct.
- Set date and time correctly. (☞ pg. 73)
- The channel position does not correspond to that in the receiving area.
- Set the correct channel position for the receiving broadcast. (☞ pg. 70)

The SHOWVIEW system does not timer-record properly.

- The unit's channel positions have been set incorrectly.
- Refer to "ShowView™ System Setup" (☞ pg. 70) and re-perform the procedure.

Automatic Satellite Programme Recording does not start.

- The satellite receiver is not connected properly to this unit.
- Connect the satellite receiver to the L-2 IN/DECODER connector properly. (☞ pg. 48)

On the front display panel, "– : –" appears.

- Power failure occurred.
- Set date and time correctly. (☞ pg. 73)

"PROGRAMME FULL" appears on the TV screen during timer programming.

- 32 programmes have already been timer programmed.
- Clear unnecessary programmes on the unit, then try timer programming again. (☞ pg. 47)

The disc space does not increase when recorded titles are cleared.

- The PC's data recorded on a DVD-RAM drive cannot be cleared on this unit.
- Format the disc. (When the disc is soiled, wipe the disc with a soft dry cloth before formatting.) (☞ pg. 9, 74)

Other Problems

The image of the TV broadcast appears distorted on the TV screen.

For basic/S-video connection

→ Press **PROGRESSIVE SCAN** for 3 or more seconds so that the Video output indicator (**P**) lights off on the front display panel.

For component video connection

→ Press **PROGRESSIVE SCAN** for 3 or more seconds so that the Video output indicator (**P**) lights up on the front display panel.

Whistling or howling is heard from the TV during camcorder recording.

- The camcorder's microphone is too close to the TV.
- Position the camcorder so its microphone is away from the TV.
- The TV's volume is too high.
- Turn the TV's volume down.

When scanning channels, some of them are skipped over.

- Those channels have been designated to be skipped.
- If you need the skipped channels, restore them. (↗ pg. 70)

The channel cannot be changed.

- Recording or Live Memory recording* is in progress.
- Press **II** to pause the recording, change channels, then press **▶** to resume recording.

* HDD deck only

Channel settings that were made manually seem to have changed or disappeared.

- After the manual settings were made, Auto Channel Set was performed.
- Perform "Clock Set" (↗ pg. 73).

On-screen Message

**DISC NOT REGISTERED IN THE LIBRARY
REGISTER DISC?**

- A disc that is not registered in the library has been inserted. Register the disc as necessary. (↗ pg. 54)

INSERT DISC XXXX

- Appears when a title that has been selected in the library is not contained in the loaded disc.

**CAN NOT RECORD OR MAKE PLAY LIST
DELETE UNWANTED TITLES**

- Recording and/or editing cannot be performed.
- The number of titles exceeds 99.
- The number of play lists exceeds 999.

SET CLOCK BEFORE TIMER PROGRAMMING

- To set the timer programme, the clock must be set in advance. (↗ pg. 73)

**PROGRAMME FULL
DELETE UNWANTED TIMER PROGRAMMES**

- You can programme this unit to timer-record as many as 32 programmes. To programme more, you need to cancel a timer programme already set. (↗ pg. 47)

DISC NOT LOADED

- Operation has been attempted when a disc is not loaded, or loaded upside down. (↗ pg. 8)

**DISC NOT RECORDABLE
INSERT RECORDABLE DISC**

- When a playback-only disc or a finalised disc is loaded, ● has been pressed. (↗ pg. 5)

**SHOWVIEW NO. ERROR
CONFIRM SHOWVIEW NO. THEN RETRY**

- An invalid SHOWVIEW number has been input. (☞ pg. 44)

**GUIDE PROGRAM IS NOT SET
SET GUIDE PROGRAM THEN RETRY**

- To set the timer programme using the SHOWVIEW system, the Guide Program number must be set in advance. (☞ pg. 70)

**CAN NOT SET SHOWVIEW TIMER PROGRAMMING DURING
TIMER RECORDING OR INSTANT TIMER RECORDING**

- Appears when you tried to input a SHOWVIEW number during timer recording or instant timer recording.

**REGION CODE ERROR
CHECK DISC**

- A disc loaded cannot be played back on this unit since the region number of the disc does not match that of the unit. (☞ pg. 6)

**UNREADABLE DISC
CHECK DISC**

- When an incompatible disc is loaded, ► has been pressed. (☞ pg. 6)

**COULD NOT FORMAT THE DISC
CHECK THE DISC**

- Formatting is not complete since the disc may be dirty or damaged. Take out the disc, clean it and retry. (☞ pg. 9, 74)

CAN NOT FINALISE THIS DISC

- Finalising is not complete since the disc may be dirty or damaged. Take out the disc, clean it and retry. (☞ pg. 9, 75)

**CAN NOT CANCEL FINALISATION
OF THIS DISC**

- Cancelling disc finalisation is not complete since the disc may be dirty or damaged. Take out the disc, clean it and retry. (☞ pg. 9, 75)

PRESS [STOP] AGAIN TO STOP RECORDING

- During Live Memory playback, ■ has been pressed. (☞ pg. 42)

TIMER RECORDING COMPLETED

- Timer recording has finished during Live Memory playback.

**PLAYBACK WILL STOP
THEN TIMER RECORDING WILL START**

- Timer recording finished during Live Memory playback, then the next timer recording is about to begin while playback continues.

**COPY PROHIBITED
CAN NOT RECORD**

- An attempt has been made to record copy-protected contents.
- An attempt has been made to record copy-once contents on a disc that is not CPRM compatible, such as DVD-R.

**COPY PROHIBITED
CAN NOT PLAY**

- The unit has detected invalid contents at the start or in the middle of playback.

**THE i.LINK DEVICE THAT YOU HAVE CONNECTED IS NOT
RECOGNIZED
MAKE SURE THAT THE DEVICE IS CONNECTED PROPERLY AND
POWERED ON**

- An attempt has been made to start DV dubbing when a digital video camera is not properly connected to the unit.
- Check the connection. (☞ pg. 58)

GENERAL**Power requirement**

AC 220 V – 240 V~, 50 Hz/60 Hz

Power consumption

Power on: 37 W

Power off: 19.3 W

Temperature

Operating: 5°C to 40°C

Storage: –20°C to 60°C

Operating position

Horizontal only

Dimensions (WxHxD)

435 mm x 70 mm x 345.5 mm

Weight

6.1 kg

Input/Output

S-video input:

Y: 0.8 – 1.2 Vp-p, 75 ohms

C: 0.2 – 0.4 Vp-p, 75 ohms

S-video output:

Y: 1.0 Vp-p, 75 ohms

C: 0.3 Vp-p, 75 ohms

Video input: 0.5 – 2.0 Vp-p, 75 ohms (pin jack)

Audio input:

–8 dB, 50 kilohms (pin jack)

Corresponding to mono (left)

Audio output: –8 dB, 1 kilohms (pin jack)

i.Link: 4-pin for DV input

Component video output:

Y: 1.0 Vp-p, 75 ohms

Cb/Cr, Pb/Pr: 0.7 Vp-p, 75 ohms

Corresponding to copy protection

Digital audio output:

Optical: –18 dBm, 660 nm

Coaxial: 0.7 Vp-p, 75 ohms

Corresponding to Dolby Digital and DTS Digital Surround

Bit stream

Selectable in digital audio output setting menu

RCA connectors:

IN x 1, OUT x 1

VIDEO/AUDIO (DVD Deck)**Recording time**

Maximum 8 hours (with 4.7 GB disc)

(XP): Approx. 1 hour

(SP): Approx. 2 hours

(LP): Approx. 4 hours

(EP): Approx. 6 hours

(FR): Approx. 1 hour – 8 hours

Audio recording system

Dolby Digital (2 ch)

Linear PCM (XP mode only)

Video recording compression system

MPEG2 (CBR/VBR)

VIDEO/AUDIO (HDD Deck)**Video recording compression system**

MPEG2 (VBR)

Audio recording system

Dolby Digital (2 ch)

Linear PCM (XP mode only)

Recording time

		DR-MH30S	DR-MH20S
HDD capacity		160 GB	80 GB
Recording Time			
	XP	1 hour	Approx. 34 hours
	SP	2 hours	Approx. 68 hours
	LP	4 hours	Approx. 136 hours
	EP	6 hours	Approx. 204 hours
	FR480	8 hours	Approx. 272 hours
			Approx. 136 hours

TUNER/TIMER**Signal system**PAL-type colour signal and CCIR monochrome signal, 625 lines
50 fields**TV channel storage capacity**

99 positions (+AUX position)

Tuning system

Frequency synthesized tuner

Channel coverage

VHF 47 MHz – 89 MHz/

104 MHz – 300 MHz/

302 MHz – 470 MHz

UHF 470 MHz – 862 MHz

Memory backup time

Approx. 60 seconds

ACCESSORIES**Provided accessories**

RF cable,

21-pin SCART cable,

Satellite Controller,

Infrared remote control unit,

“R6” battery x 2

E. & O.E. Design and specifications subject to change without notice.

ATTENTION:

This unit contains microcomputers. External electronic noise or interference could cause malfunctioning. In such cases, switch the unit off and unplug the mains power cord. Then plug it in again and turn the unit on. Take out the disc. After checking the disc, operate the unit as usual.

Language Code List

AA	Afar	IK	Inupiak	RN	Kirundi
AB	Abkhazian	IN	Indonesian	RO	Rumanian
AF	Afrikaans	IS	Icelandic	RU	Russian
AM	Ameharic	IW	Hebrew	RW	Kinyarwanda
AR	Arabic	JI	Yiddish	SA	Sanskrit
AS	Assamese	JW	Javanese	SD	Sindhi
AY	Aymara	KA	Georgian	SG	Sangho
AZ	Azerbaijani	KK	Kazakh	SH	Serbo-Croatian
BA	Bashkir	KL	Greenlandic	SI	Singhalese
BE	Byelorussian	KM	Cambodian	SK	Slovak
BG	Bulgarian	KN	Kannada	SL	Slovenian
BH	Bihari	KO	Korean (KOR)	SM	Samoan
BI	Bislama	KS	Kashmiri	SN	Shona
BN	Bengali, Bangla	KU	Kurdish	SO	Somali
BO	Tibetan	KY	Kirghiz	SQ	Albanian
BR	Breton	LA	Latin	SR	Serbian
CA	Catalan	LN	Lingala	SS	Siswati
CO	Corsican	LO	Laothian	ST	Sesotho
CS	Czech	LT	Lithuanian	SU	Sundanese
CY	Welsh	LV	Latvian, Lettish	SW	Swahili
DZ	Bhutani	MG	Malagasy	TA	Tamil
EL	Greek	MI	Maori	TE	Telugu
EO	Esperanto	MK	Macedonian	TG	Tajik
ET	Estonian	ML	Malayalam	TH	Thai
EU	Basque	MN	Mongolian	TI	Tigrinya
FA	Persian	MO	Moldavian	TK	Turkmen
FJ	Fiji	MR	Marathi	TL	Tagalog
FO	Faroese	MS	Malay (MAY)	TN	Setswana
FY	Frisian	MT	Maltese	TO	Tonga
GA	Irish	MY	Burmese	TR	Turkish
GD	Scots Gaelic	NA	Nauru	TS	Tsonga
GL	Galician	NE	Nepali	TT	Tatar
GN	Guarani	OC	Occitan	TW	Twi
GU	Gujarati	OM	(Afan) Oromo	UK	Ukrainian
HA	Hausa	OR	Oriya	UR	Urdu
HI	Hindi	PA	Panjabi	UZ	Uzbek
HR	Croatian	PL	Polish	VI	Vietnamese
HU	Hungarian	PS	Pashto, Pushto	VO	Volapuk
HY	Armenian	PT	Portuguese	WO	Wolof
IA	Interlingua	QU	Quechua	XH	Xhosa
IE	Interlingue	RM	Rhaeto-Romance	YO	Yoruba
				ZU	Zulu

Country/Area Code List for Parental Lock

AD	Andorra	CK	Cook Islands	GN	Guinea
AE	United Arab Emirates	CL	Chile	GP	Guadeloupe
AF	Afghanistan	CM	Cameroon	GQ	Equatorial Guinea
AG	Antigua and Barbuda	CN	China	GR	Greece
AI	Anguilla	CO	Colombia	GS	South Georgia and the South Sandwich Islands
AL	Albania	CR	Costa Rica	GT	Guatemala
AM	Armenia	CU	Cuba	GU	Guam
AN	Netherlands Antilles	CV	Cape Verde	GW	Guinea-Bissau
AO	Angola	CX	Christmas Island	GY	Guyana
AQ	Antarctica	CY	Cyprus	HK	Hong Kong
AR	Argentina	CZ	Czech Republic	HM	Heard Island and McDonald Islands
AS	American Samoa	DE	Germany	HN	Honduras
AT	Austria	DJ	Djibouti	HR	Croatia
AU	Australia	DK	Denmark	HT	Haiti
AW	Aruba	DM	Dominica	HU	Hungary
AZ	Azerbaijan	DO	Dominican Republic	ID	Indonesia
BA	Bosnia and Herzegovina	DZ	Algeria	IE	Ireland
BB	Barbados	EC	Ecuador	IL	Israel
BD	Bangladesh	EE	Estonia	IN	India
BE	Belgium	EG	Egypt	IO	British Indian Ocean Territory
BF	Burkina Faso	EH	Western Sahara	IQ	Iraq
BG	Bulgaria	ER	Eritrea	IR	Iran (Islamic Republic of)
BH	Bahrain	ES	Spain	IS	Iceland
BI	Burundi	ET	Ethiopia	IT	Italy
BJ	Benin	FI	Finland	JM	Jamaica
BM	Bermuda	FJ	Fiji	JO	Jordan
BN	Brunei Darussalam	FK	Falkland Islands (Malvinas)	JP	Japan
BO	Bolivia	FM	Micronesia (Federated States of)	KE	Kenya
BR	Brazil	FO	Faroe Islands	KG	Kyrgyzstan
BS	Bahamas	FR	France	KH	Cambodia
BT	Bhutan	FX	France, Metropolitan	KI	Kiribati
BV	Bouvet Island	GA	Gabon	KM	Comoros
BW	Botswana	GB	United Kingdom	KN	Saint Kitts and Nevis
BY	Belarus	GD	Grenada	KP	Korea, Democratic People's Republic of
BZ	Belize	GE	Georgia	KR	Korea, Republic of
CA	Canada	GF	French Guiana	KW	Kuwait
CC	Cocos (Keeling) Islands	GH	Ghana	KY	Cayman Islands
CF	Central African Republic	GI	Gibraltar	KZ	Kazakhstan
CG	Congo	GL	Greenland	LA	Lao People's Democratic Republic
CH	Switzerland	GM	Gambia	LB	Lebanon
CI	Côte d'Ivoire				

LC	Saint Lucia	NU	Niue	SZ	Swaziland
LI	Liechtenstein	NZ	New Zealand	TC	Turks and Caicos Islands
LK	Sri Lanka	OM	Oman	TD	Chad
LR	Liberia	PA	Panama	TF	French Southern Territories
LS	Lesotho	PE	Peru	TG	Togo
LT	Lithuania	PF	French Polynesia	TH	Thailand
LU	Luxembourg	PG	Papua New Guinea	TJ	Tajikistan
LV	Latvia	PH	Philippines	TK	Tokelau
LY	Libyan Arab Jamahiriya	PK	Pakistan	TM	Turkmenistan
MA	Morocco	PL	Poland	TN	Tunisia
MC	Monaco	PM	Saint Pierre and Miquelon	TO	Tonga
MD	Moldova, Republic of	PN	Pitcairn	TP	East Timor
MG	Madagascar	PR	Puerto Rico	TR	Turkey
MH	Marshall Islands	PT	Portugal	TT	Trinidad and Tobago
ML	Mali	PW	Palau	TV	Tuvalu
MM	Myanmar	PY	Paraguay	TW	Taiwan
MN	Mongolia	QA	Qatar	TZ	Tanzania, United Republic of
MO	Macau	RE	Réunion	UA	Ukraine
MP	Northern Mariana Islands	RO	Romania	UG	Uganda
MQ	Martinique	RU	Russian Federation	UM	United States Minor Outlying Islands
MR	Mauritania	RW	Rwanda	US	United States
MS	Montserrat	SA	Saudi Arabia	UY	Uruguay
MT	Malta	SB	Solomon Islands	UZ	Uzbekistan
MU	Mauritius	SC	Seychelles	VA	Vatican City State (Holy See)
MV	Maldives	SD	Sudan	VC	Saint Vincent and the Grenadines
MW	Malawi	SE	Sweden	VE	Venezuela
MX	Mexico	SG	Singapore	VG	Virgin Islands (British)
MY	Malaysia	SH	Saint Helena	VI	Virgin Islands (U.S.)
MZ	Mozambique	SI	Slovenia	VN	Viet Nam
NA	Namibia	SJ	Svalbard and Jan Mayen	VU	Vanuatu
NC	New Caledonia	SK	Slovakia	WF	Wallis and Futuna Islands
NE	Niger	SL	Sierra Leone	WS	Samoa
NF	Norfolk Island	SM	San Marino	YE	Yemen
NG	Nigeria	SN	Senegal	YT	Mayotte
NI	Nicaragua	SO	Somalia	YU	Yugoslavia
NL	Netherlands	SR	Suriname	ZA	South Africa
NO	Norway	ST	Sao Tome and Principe	ZM	Zambia
NP	Nepal	SV	El Salvador	ZR	Zaire
NR	Nauru	SY	Syrian Arab Republic	ZW	Zimbabwe

TV Station And ID List

The "ID" abbreviation is what is shown on-screen in lieu of the station name. The "ID" abbreviation is listed in the Confirmation screen and is displayed on the TV screen when the unit is tuned to a different station.

ID	STATION NAME
1000	TV1000
3SAT	3SAT
9LIV	9LIVE
AB3	AB3
ADLT	ADULT
ANIM	ANIMAL PLANET
ANT3	ANTENA3
ARD	ARD
ARTE	ARTE
ATV	MAGYAR ATV
B1	BERLIN 1
BBC	BBC GROUP
BBC1	BBC1
BBC2	BBC2
BBCW	BBC WORLD
BIO+	TV BIO+
BLOO	BLOOMBERG
BR3	BAYERN3
C+	CANAL PLUS
C1	PORTUGUSES
C9	VALENCIA
CAN5	CANALE5
CANV	KETNET CANVAS
CANZ	KANAAL Z
CH4	CHANNEL4
CH5	CHANNEL5
CHLD	CHILD
CINE	CINEMA
CLUB	TELECLUB
CMT	CMT
CNN	CNN
CSUR	ANDALUCIA
CT1	CT 1
CT2	CT 2
DISC	DISCOVERY
DK1	DENMARK1
DK2	DENMARK2
DK4	DENMARK4
DR1	DR TV
DR2	DR2
DSF	DSF
DUNA	DUNA TV
ETB1	ETB1
ETB2	ETB2
ETV	ETV
EUNW	EURO NEWS
EURO	EURONEWS
EUSP	EUROSPORTS
FEMM	FEMMAN
FILM	FILM
FNET	FILMNET
FR2	France2
FR3	France3
FR5	France5
GALA	GALAVISION
HBO	HBO
HR3	HESSEN3
HSEU	H.S.EURO
INFO	INFO-KANAL
ITA1	ITALIA1
ITA7	ITALIA7
ITV1	ITV

ID	STATION NAME
JIM	JIM TV
JSTV	JSTV
KA2	KA2
KAB1	KABEL1
KAN2	KANAL2
KAN5	KANAL5
KBH	KBH.KANAL
KIKA	KINDER.KANAL
LA7	LA7
LIB	LIBERTY TV
LOCA	LOCAL
M6	M6
MBC	MBR
MCM	MCM
MDR	MDR
MOVE	MOVIE
MTV	MTV
MTV1	MTV1
MTV2	MTV2
MTV3	MTV3
NGEO	NATIONAL.G
N24	NEWS24
N3	NORD3
N-TV	N-TV
NBC	NBC SUPER
NDR	NDR
NED1	NED1
NED2	NED2
NED3	NED3
NET5	NETWORK5
NEWS	
NICK	NICKELODEON
NOVA	NOVA
NRK1	NRK
NRK2	NRK2
ODE	ODEON
ORF1	ORF1
ORF2	ORF2
PHOE	PHOENIX
POLS	POL SAT
PREM	PREMIERE
PRIM	PRIMA TV
PRO7	PRO7
RAI1	RAI1
RAI2	RAI2
RAI3	RAI3
RET4	RETE4
RTB1	TELE21
RTB2	RTBF1 or 2
RTL	RTL
RTL2	RTL2
RTL4	RTL4
RTL5	RTL5
RTL7	RTL7
RTLK	RTLK
RTP	RTP
RTV4	RTV4
SAT1	SAT1
SBS6	SBS
SERV	Service
SF1	SF1
SF2	SF2

ID	STATION NAME
SHOW	SHOW
SIC	SOCIEDADE
SKY	SKY CHANNEL
SKYN	SKY NEWS
SPEK	SPEKTRUM
SPRT	SPORT
SRTL	SUPER RTL
STAR	STAR-TV
SVT1	SVT1
SVT2	SVT2
SV24	NEWS
SWR	SUEDWEST3
TCC	TCC
TCM	TCM
TELE	TELE
TELE5	TELE5
TF1	TF1
TM	TV DE MADRID
TMC	TELEMONTECARLO
TMF	TMF
TNT	TNT INT
TRT	TRT INT
TSI1	TSI
TSI2	TSI2
TSR1	TSR
TSR2	TSR2
TV1	BRTN TV1
TV2	TV2
TV2Z	TV2 ZULU
TV3	TV3
TV3+	TV3 PLUS
TV4	TV4
TV5	TV5
TV6	TV6
TV8	TV8
TVE1	TVE1
TVE2	TVE2
TVG	TV GALICIA
TVI	TV INDEPENDENT
TVN	TV NORGE
TV24	TVN24
TVP1	TVP1
TVP2	TVP2
TV P	TV POLONIA
V8	V8
VCR	VIDEO
VH-1	VH-1
VIT	VITAYA
VIVA	VIVA
VIV2	VIVA2
VMTV	VIDEO MUSIC
VOX	VOX
VSAT	VIASAT3
VT4	VT4
VTM	VTM
WDR3	West3
WRLD	WORLD
YLE1	YLE1
YLE2	YLE2
YORN	YORIN
ZDF	ZDF
ZTV	ZTV

A	
A-B Repeat Playback	31
Adjusting The Picture Quality	32
Angle Selection	28
Audio Channel Selection	29
Audio Language/Sound Selection	29
Auto Channel Set	70
C	
Cancel And Change Programmes	47
Check Programmes	47
D	
Delete Title	51
Disc menu	26
Disc Remaining Time	36, 39
Disc Resume	68
Discs For Playback Only	6
DVD menu	26
E	
Elapsed Recording Time Indication	36, 39
F	
File Structure Of Discs	7
Free Rate Function	37
G	
Guide Program Number	70
H	
High-Speed Search	26, 40
I	
Instant Timer Recording (ITR)	36, 39
Interlaced scan	69
J	
Jump Search	43
Just Clock	73
L	
Letter Box	22
Live Memory	41
Live Memory Recording	43
M	
Manual Channel Set	71
Marking Positions To Play Back Again Later	27
Menu/Audio/Subtitle Language Set	21

O	
One Touch Replay	29, 43
On-screen Bar	30
On-screen Language Set	21
P	
Pan&Scan	22
Play List	52
Playback Control (PBC)	29
Programme Playback	33
Progressive scan	69
R	
Random Playback	33
Recordable/playable discs	5
Recording Medium And Format	7
Recording Mode	35, 38
Recording Resume Function	35, 38
Region Number	6
Register Disc	54
Relief Recording	46
Repeat Playback	31
Resume Function	27
S	
Select The Switching Interval Of The Slide Show	33
Setting The Progressive Mode	33
Simulated Surround Effect	32
Skip Search	27, 40
Slow Motion	27, 40
Still Picture/Frame-By-Frame Playback	27, 40
Subtitle Selection	28
T	
Temporary Recording	41
Time Search	32
Top menu	26
U	
Unplayable Discs	6
V	
VPS/PDC Recording	45

EN

DR-MH30S/
DR-MH20S

JVC
VICTOR COMPANY OF JAPAN, LIMITED

Free Manuals Download Website

<http://myh66.com>

<http://usermanuals.us>

<http://www.somanuals.com>

<http://www.4manuals.cc>

<http://www.manual-lib.com>

<http://www.404manual.com>

<http://www.luxmanual.com>

<http://aubethermostatmanual.com>

Golf course search by state

<http://golfingnear.com>

Email search by domain

<http://emailbydomain.com>

Auto manuals search

<http://auto.somanuals.com>

TV manuals search

<http://tv.somanuals.com>