

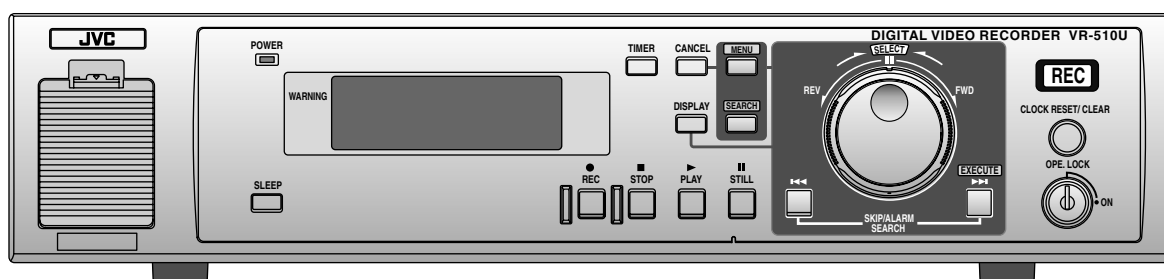

DIGITAL VIDEO RECORDER

VR-510U

INSTRUCTIONS



For Customer Use:

Enter below the Serial No. which is located on the rear of cabinet. Retain this information for future reference.

Model No. **VR-510U**

Serial No. _____

IMPORTANT SAFEGUARDS

1. Read all of these instructions.
2. Save these instructions for later use.
3. All warnings on the product and in the operating instructions should be adhered to.
4. Unplug this appliance system from the wall outlet before cleaning. Do not use liquid cleaners or aerosol cleaners. Use a damp cloth for cleaning.
5. Do not use attachments not recommended by the appliance manufacturer as they may cause hazards.
6. Do not use this appliance near water – for example, near a bathtub, washbowl, kitchen sink, or laundry tub, in a wet basement, or near a swimming pool, etc.
7. Do not place this appliance on an unstable cart, stand, or table. The appliance may fall, causing serious injury to a child or adult, and serious damage to the appliance.
Use only with a cart or stand recommended by the manufacturer, or sold with the appliance. Wall or shelf mounting should follow the manufacturer's instructions, and should use a mounting kit approved by the manufacturer.
An appliance and cart combination should be moved with care. Quick stops, excessive force, and uneven surfaces may cause the appliance and cart combination to overturn.
8. Slots and openings in the cabinet and the back or bottom are provided for ventilation, and to insure reliable operation of the appliance and to protect it from overheating, these openings must not be blocked or covered. The openings should never be blocked by placing the appliance on a bed, sofa, rug, or other similar surface. This appliance should never be placed near or over a radiator or heat register. This appliance should not be placed in a built-in installation such as a bookcase unless proper ventilation is provided.
9. This appliance should be operated only from the type of power source indicated on the marking label. If you are not sure of the type of power supplied to your home, consult your dealer or local power company. For appliance designed to operate from battery power, refer to the operating instructions.
10. This appliance system is equipped with a 3-wire grounding type plug (a plug having a third (grounding) pin). This plug will only fit into a grounding-type power outlet. This is a safety feature. If you are unable to insert the plug into the outlet, contact your electrician to replace your obsolete outlet. Do not defeat the safety purpose of the grounding plug.
11. For added protection for this product during a lightning storm, or when it is left unattended and unused for long periods of time, unplug it from the wall outlet and disconnect the antenna or cable system. This will prevent damage to the product due to lightning and power-line surges.
12. Do not allow anything to rest on the power cord. Do not locate this appliance where the cord will be abused by persons walking on it.
13. Follow all warnings and instructions marked on the appliance.
14. Do not overload wall outlets and extension cords as this can result in fire or electric shock.
15. Never push objects of any kind into this appliance through cabinet slots as they may touch dangerous voltage points or short out parts that could result in a fire or electric shock. Never spill liquid of any kind on the appliance.
16. Do not attempt to service this appliance yourself as opening or removing covers may expose you to dangerous voltage or other hazards. Refer all servicing to qualified service personnel.
17. Unplug this appliance from the wall outlet and refer servicing to qualified service personnel under the following conditions:
 - a. When the power cord or plug is damaged or frayed.
 - b. If liquid has been spilled into the appliance.
 - c. If the appliance has been exposed to rain or water.
 - d. If the appliance does not operate normally by following the operating instructions. Adjust only those controls that are covered by the operating instructions as improper adjustment of other controls may result in damage and will often require extensive work by a qualified technician to restore the appliance to normal operation.
 - e. If the appliance has been dropped or the cabinet has been damaged.
 - f. When the appliance exhibits a distinct change in performance – this indicates a need for service.
18. When replacement parts are required, be sure the service technician has used replacement parts specified by the manufacturer that have the same characteristics as the original part. Unauthorized substitutions may result in fire, electric shock, or other hazards.
19. Upon completion of any service or repairs to this appliance, ask the service technician to perform routine safety checks to determine that the appliance is in safe operating condition.

PORTABLE CART WARNING
(symbol provided by RETAC)



S3126A

SAFETY PRECAUTIONS



CAUTION

RISK OF ELECTRIC SHOCK
DO NOT OPEN



CAUTION: TO REDUCE THE RISK OF ELECTRIC SHOCK,
DO NOT REMOVE COVER (OR BACK).
NO USER-SERVICEABLE PARTS INSIDE.
REFER SERVICING TO QUALIFIED SERVICE PERSONNEL



ATTENTION

RISQUE D'ELECTROCUTION
NE PAS OUVRIR



ATTENTION: POUR EVITER TOUT RISQUE D'ELECTROCUTION
NE PAS OUVRIR LE BOITIER.
AUCUNE PIECE INTERIEURE N'EST
A REGLER PAR L'UTILISATEUR.
SE REFERER A UN AGENT QUALIFIE EN CAS DE PROBLEME.



The lightning flash with arrowhead symbol, within an equilateral triangle, is intended to alert the user to the presence of uninsulated "dangerous voltage" within the product's enclosure that may be of sufficient magnitude to constitute a risk of electric shock to persons.



The exclamation point within an equilateral triangle is intended to alert the user to the presence of important operating and maintenance (servicing) instructions in the literature accompanying the appliance.

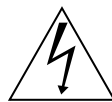

Le symbole de l'éclair à l'intérieur d'un triangle équilatéral est destiné à alerter l'utilisateur sur la présence d'une "tension dangereuse" non isolée dans le boîtier du produit. Cette tension est suffisante pour provoquer l'électrocution de personnes.



Le point d'exclamation à l'intérieur d'un triangle équilatéral est destiné à alerter l'utilisateur sur la présence d'opérations d'entretien importantes au sujet desquelles des renseignements se trouvent dans le manuel d'instructions.

*Ces symboles ne sont utilisés qu'aux Etats-Unis.

WARNING:
TO REDUCE THE RISK OF FIRE OR ELECTRIC SHOCK, DO NOT EXPOSE THIS APPLIANCE TO RAIN OR MOISTURE.

This unit should be used with 120 V AC only.

CAUTION:
To prevent electric shocks and fire hazards, DO NOT use any other power source.

NOTE:

The rating plate (serial number plate) is on the bottom of the unit.

INFORMATION

This equipment has been tested and found to comply with the limits for a Class B digital device, pursuant to Part 15 of the FCC Rules. These limits are designed to provide reasonable protection against harmful interference in a residential installation. This equipment generates, uses, and can radiate radio frequency energy and, if not installed and used in accordance with the instructions, may cause harmful interference to radio communications. However, there is no guarantee that interference will not occur in a particular installation.

If this equipment does cause harmful interference to radio or television reception, which can be determined by turning the equipment off and on, the user is encouraged to try to correct the interference by one or more of the following measures:

- Reorient or relocate the receiving antenna.
- Increase the separation between the equipment and receiver.
- Connect the equipment into an outlet on a circuit different from that to which the receiver is connected.
- Consult the dealer or an experienced radio/TV technician for help.

CAUTION

CHANGES OR MODIFICATIONS NOT APPROVED BY JVC COULD VOID USER'S AUTHORITY TO OPERATE THE EQUIPMENT.

THIS DEVICE COMPLIES WITH PART 15 OF THE FCC RULES. OPERATION IS SUBJECT TO THE FOLLOWING TWO CONDITIONS: (1) THIS DEVICE MAY NOT CAUSE HARMFUL INTERFERENCE, AND (2) THIS DEVICE MUST ACCEPT ANY INTERFERENCE RECEIVED, INCLUDING INTERFERENCE THAT MAY CAUSE UNDESIRED OPERATION.

AVERTISSEMENT:
POUR EVITER LES RISQUES D'INCENDIE OU D'ELECTROCUTION, NE PAS EXPOSER L'APPAREIL A L'HUMIDITE OU A LA PLUIE.

Ce magnétoscope ne doit être utilisé que sur du courant alternatif en 120 V.

ATTENTION:
Afin d'éviter tout risque d'incendie ou d'électrocution, ne pas utiliser d'autres sources d'alimentation électrique.

REMARQUE:

La plaque d'identification (numéro de série) se trouve sur le panneau arrière de l'appareil.

WARNING ON LITHIUM BATTERY

The battery used in this device may present a fire or chemical burn hazard if mistreated. Do not recharge, disassemble, heat above 100°C (212°F) or incinerate.

Replace battery with Matsushita Electric CR2032, use of another battery may present a risk of fire or explosion.

- Dispose of used battery promptly.
- Keep away from children.
- Do not disassemble and do not dispose of in fire.

**INFORMATION (FOR CANADA)
RENSEIGNEMENT (POUR CANADA)**

This Class B digital apparatus complies with Canadian ICES-003.

Cet appareil numérique de la Class B est conforme à la norme NMB-003 du Canada.

Thank you for purchasing the JVC VR-510U digital video recorder.

CONTENTS

1. INTRODUCTIONS	
1-1 Precautions	5
2. CONTROLS, CONNECTIONS AND DISPLAY	
2-1 Front panel	6
2-2 Rear panel	7
2-3 Display	8
3. CONNECTIONS	
3-1 Recording video signals from a camera	9
3-2 Connecting more than one camera (using an external switcher)	10
3-3 Connecting signal input/output terminals	11
4. PREPARATION	
4-1 Installing a battery	12
4-2 Power supply	12
4-3 Setting the date and time	13
4-4 Daylight-saving time compensation	13
5. ON-SCREEN DISPLAY/MENU SWITCHES	
5-1 On-screen display	14
5-2 Menu switches	15
Menu flow	15
Jog/shuttle dial operation	16
Display	17
Setting	18
5-3 Menu switch details	19
6. RECORDING	
6-1 Basic operation	22
Recording system <Normal recording> <Repeat recording>	22
6-2 Program timer recording	23
Weekly timer	23
Timer-recording for 24 hours or more	24
Daily timer	25
Estimated recordable duration	26
6-3 Holiday timer recording	27
6-4 Alarm recording	28
Repeat recording during alarm recording	28
6-5 Sensor recording	29
Pre-sensor recording	29
6-6 Recording with an external activation signal	30
6-7 Automatic restart of recording after power failure	30
7. PLAYBACK AND SPECIAL-EFFECTS PLAYBACK	
7-1 Basic operation	31
Playback	31
Simultaneous Playback mode	31
7-2 Jog/shuttle playback	32
7-3 Skip search	33
Time search	33
Event search	34
Alarm search	34
7-4 Alarm or day/time direct search	35
8. HARD DISK CONTROL	
8-1 Hard disk maintenance	36
Scanning the disk	36
Formatting	37
9. TROUBLESHOOTING	
9-1 Error indication	38
9-2 No error indication	39
10. RS-232C INTERFACE	
10-1 Specifications	40
10-2 Protocols and commands	40
10-3 Commands	42
11. OTHERS	
11-1 Recording time	47
11-2 Signal input/output terminals	48
11-3 Specifications	49

1 INTRODUCTION

Major features

● Large-capacity hard disk (80 GB)

Large-capacity hard disk enables high-quality/high-capacity recording/playback. (Can be increased up to 160 GB)

● Simultaneous recording/playback mode

You can play or back up programs even during recording.

● Instant picture search

You can access images at a specified date/time or alarm point instantly.

● Restoring recording after power failure

When power is restored after power failure, recording automatically re-starts in the same mode engaged before the power failure.

● Timer recording function

Up to 8 timer recording settings can be programmed, including daily and weekly.

● Alarm recording function

You can preset the VCR to automatically enter a specified recording mode whenever an alarm signal is received.

● RS-232C control

JVC cannot accept liability for loss or damage to recording that result from a malfunction of this unit or the hard drive.

Please note that it may be unlawful to use any material recorded from television broadcast programs or pre-recorded programs without the consent of the owner of copyright, except in cases where the material is recorded exclusively for personal use.

When the hard disk is replaced or the firmware is upgraded, all recorded data on the hard disk is erased.

— Characters and marks used in this text —

Caution : Additional information about a specific operation or procedure.

Memo : Information about a function or specification.

Reference : Other items or pages containing information on the topic.

1-1 Precautions

Installation and storage

● To avoid malfunctions or damage to your recorder, do not use or store it in places subject to the following conditions.

- Extreme heat or cold – temperature outside the allowable range (5°C to 40°C)
- High humidity – outside the allowable operating range (30% to 80%)
- Strong magnetic fields (generated by transformers, motors, etc.)
- Electrical waves generated by equipment such as a transceiver or cellular phone
- Dust and soil
- Vibrations
- Condensation

Handling

- To prevent unit from overheating, do not place it anything on top of any other equipment or place other equipment on top of it.
- This unit should only be operated when it is in a horizontal (flat) position.
- Avoid violent shocks to the unit.
- Do not move this unit when the power is ON. This could cause it to malfunction.
- To avoid a malfunction, do not place anything heavy such as a TV monitor on this unit.
- To clean this unit, wipe it gently with a soft cloth.

Do not use chemical solvents such as thinner or benzene to clean this unit. Doing so could damage the surface. To

remove any excessive dirt, wipe the unit with a cloth dipped in detergent and then wipe it with a dry cloth.

Transportation

- Do not apply a shock to this unit during transportation. Do not move this unit during recording or playback.

Energy saving

- When the unit is not going to be used for a long time, turn the power off to avoid unnecessary power consumption.

Hard disk

- The hard disk is a consumable item. Replacement is recommended after 30,000 hours of use (if used in a 25°C environment). For information on maintenance planning and costs, consult your nearest JVC dealer.

2 CONTROLS, CONNECTIONS AND DISPLAY

2-1 Front panel

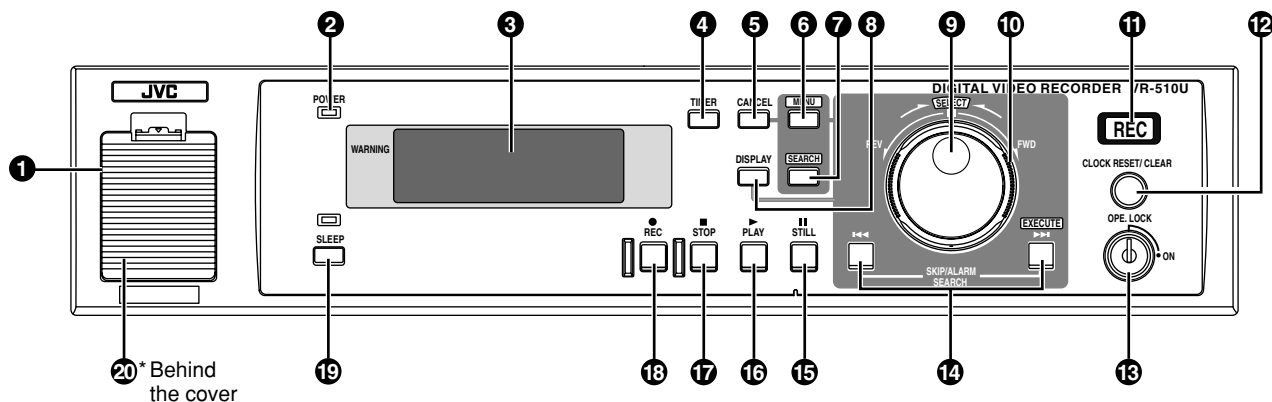

- 1 [LITHIUM BATTERY] battery box for memory backup**
Install a memory backup battery. When replacing the battery with a new one, be sure to set the date/time again.
Reference: "4-1 Installing a battery" on page 12.
- 2 [POWER] indicator**
When the [POWER] switch is turned ON, this indicator lights.
- 3 [DISPLAY PANEL]**
Shows the operation status or setting details.
Reference: "2-3 Display" on page 8.
- 4 [TIMER] button**
After programming the timer, press this button to engage the Standby mode.
Reference: "6-2 Program timer recording" on page 23.
- 5 [CANCEL] button**

 - When a line is selected on the [PROGRAM TIMER] or [HOLIDAY SET] screen, press this button to clear it.
 - When an alarm or warning occurs, press this button to stop the buzzer.

Reference: "6-2 Program timer recording" on page 26 and "6-4 Alarm recording" on page 28
- 6 [MENU] button**
Press this button in the Stop mode to display the main menu setting screen.
* The menu cannot be displayed when the **6 [TIMER]** indicator (see page 8) is on or during recording/playback.
- 7 [SEARCH] button**
Press to display the search menu for alarm search or time/date search. Pressing this button again restores the normal screen.
Reference: "7-4 Alarm or day/time direct search" on page 35.
- 8 [DISPLAY] display panel switching button**
Each time this button is pressed, the display changes in order from CLOCK to DATE to REMAIN to REC QUALITY-REC SPEED.
• Press [DISPLAY] button in any mode except Record for about 2 seconds. The recording setting display is displayed, allowing you to set recording quality/number of frames.
- 9 Jog dial**
In the Play or Still mode, use this dial for frame-by-frame playback.
Reference: "7-2 Jog/shuttle playback" on page 32.
With the menu/search screen, use this dial to set the item or value.
Reference: "Jog/shuttle dial operation" on page 16.
- 10 Shuttle search dial**
Turn to vary the playback speed in the Play or Still mode.
Reference: "7-2 Jog/shuttle playback" on page 32.
With the menu/search screen, use this dial to set the item or value.
Reference: "Jog/shuttle dial operation" on page 16.
- 11 [REC] indicator**
Lights when recording on the hard disk.
Blinks during alarm/sensor recording.
Goes out during recording if you set <REC TALLY> of <FRONT DISPLAY> to "OFF".
Reference: "5-3 Menu switch details" on page 19.
- 12 [CLOCK RESET/CLEAR] button**
In the Stop mode, press this button together with the [STOP] button to reset the second value on the internal clock.
• With 29 seconds or less, the minute value stays the same and the second value is reset to 00.
• With 30 seconds or more, the minute value is increased by 1 and the second value is reset to 00.
Pressing this button stops recording during alarm/sensor recording.
When the alarm list screen or power-off list screen is displayed, pressing this button clears the list.
Reference: "7-4 Alarm or day/time direct search" on page 35.
Use this button to cancel the [AUTO SCAN DISK] function.
Reference: "8-1 Hard disk maintenance" on page 36.
- 13 [OPE.LOCK] operation lock key**
Set to "ON" position with the provided key to lock switch operation.
Security levels can be selected with menu switch <OPERATION LOCK MODE>.

 - **ALL:** Locks all switches.
 - **REC STOP:** Prevents recording from being stopped when the **17 [STOP]** button is pressed.

* Set to "ALL" for timer recording.
Reference: "5-3 Menu switch details" on page 19.
- 14 [SKIP/ALARM SEARCH-EXECUTE] SKIP SEARCH-EXECUTE button**

 - **Skip search**
In the Stop mode, press this button to go to the start or end of a recording of the hard disk.
In the Play mode, press this button to start skip search. There are three types of skip search:

 - **Time search:** Goes to the point a specified time from the current point.
 - **Event search:** Goes to the start of an event recording.
 - **Alarm search:** Goes to the start of an alarm recording.
Reference: "7-3 Skip search" on page 33
 - **EXECUTE button**
Use this button to execute alarm direct search, day/time direct search or "disk scan"/"quick format".
Reference: "7-4 Alarm or day/time direct search" on page 35 and "8-1 Hard disk maintenance" on page 36
- 15 [STILL] button**
In the Play mode, press this button to engage the Still mode.
- 16 [PLAY] button**
Press this button to start playback.

 - **In the Stop mode:** Playback starts at the position where playback was last stopped.

* Just after the power is turned ON, playback starts from a point about 5 seconds before the end point of the last recording.

 - **In the Record mode:** Simultaneous Playback mode is engaged.
Reference: "Simultaneous Playback mode" on page 31.

2 CONTROLS, CONNECTIONS AND DISPLAY (contd.)

2-2 Rear panel

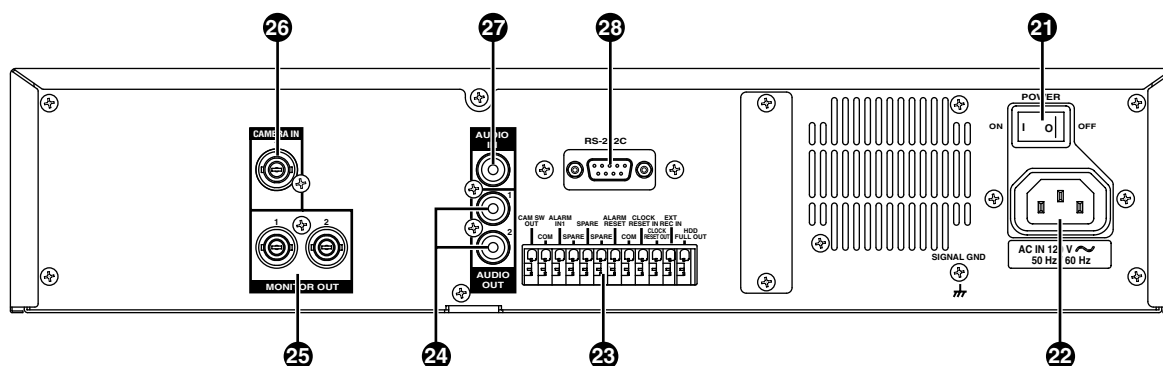

- 17 [STOP] button**
Press this button to stop operation. In the Simultaneous Playback mode, press this button to stop playback and engage the normal recording mode.
- 18 [REC] button**
Press in the Stop mode to start recording. The recording mode can be set with the menu switch.
Reference: "6-1 Basic operation" on page 22.
- 19 [SLEEP] button**
Before turning the power OFF, press this button to stop the rotation of the hard disk.
- 20 [SYSTEM RESET] button**
This button is used for servicing. Normally, you do not need to use this button.
- 21 [POWER] switch**
Turns power ON/OFF.
* Before turning the power OFF, press the **19 [SLEEP]** button to stop the rotation of the hard disk.
- 22 [AC IN] socket**
Connect to an AC 120 V outlet using the provided power cable.
- 23 Signal input/output terminal**
- CAM SW OUT
Outputs camera switch timing control signals when this unit is connected to a frame switcher.
Reference: "3-2 Connecting more than one camera (using an external switcher)" on page 10.
 - ALARM IN 1
Accepts signals to start alarm or sensor recording.
 - ALARM RESET
Accepts signals to stop recording during alarm or sensor recording.
 - CLOCK RESET IN
Connect to a master clock or the [CLOCK RESET OUT] terminal of another device. When a clock reset signal is input, this unit can be set to the master clock or the other device's clock.
When the clock reset signal is input, the clock second value is reset: .
 - With 29 seconds or less, the minute value stays the same and the second value is reset to 00.
 - With 30 seconds or more, the minute value is increased by 1 and the second value is reset to 00.
 - CLOCK RESET OUT
Outputs a clock reset signal when the internal clock is 00:00 or 12:00.
 - EXT REC IN
Recording is automatically activated by an external signal when menu switch <REC MODE> of <EXT MODE> is set to "TRIG" or "MANUAL".
Reference: "5-3 Menu switch details" on page 20.
 - HDD FULL OUT
Outputs a signal during recording when the hard disk's available space is 0% except in the following cases.
 - Menu switch <HDD FULL OUT> set to "OFF"
 - Menu switch <REPEAT REC> set to "ALL"**Reference:** "5-3 Menu switch details" on page 20.
- 24 [AUDIO OUT] audio output connector**
Outputs recorded audio during playback. In the Record or Stop mode, outputs the input audio signal. Audio is not output in the following cases.
 - When playing back signals recorded with menu switch <REC SPEED> set to "1/5" or "1/10"
 - In the Frame-by-Frame Playback, Still or Search mode
 - When playing back signals recorded with menu switch <AUDIO REC> set to "OFF"
 - When the menu is displayed
- 25 [MONITOR OUT] monitor output connector**
Outputs video signals recorded on the hard disk in the Play mode. In the Record mode, outputs video input signals from the camera or frame switcher connected to the [CAMERA IN] connector.
The picture signal from the [CAMERA IN] connector is output through the [MONITOR OUT] connector even when the power is turned OFF.
- 26 [CAMERA IN] camera input connector**
Connect to a camera.
- 27 [AUDIO IN] audio input connector**
Connect to the audio output connector of the audio source device.
- 28 [RS-232C] remote connector**
Connect a personal computer or compatible control unit for external remote operation.
Reference: "10. RS-232C INTERFACE" on page 40.

2-3 Display

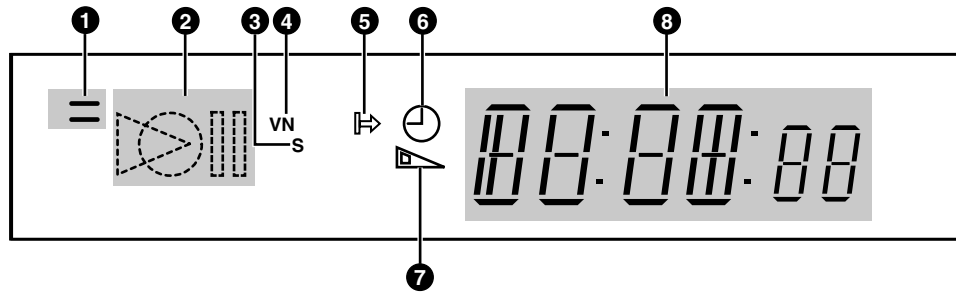

1 WARNING indication

Blinks when there is a problem with input signals, fan motor or hard disk, as well as when the battery is low.
Reference: "9-1 Error indication" on page 38.

2 Operation mode indication

Play	Still	Simultaneous play	Simultaneous still	Record
Blinks alternately				
Search or Slow Motion play		Simultaneous search or simultaneous Slow Motion play		

* Dotted line mark blinks

3 SENSOR ON indication

Lights when menu switch <REC MODE> of <ALARM/SENSOR MODE> is set to "SENSOR".

Reference: "6-5 Sensor recording" on page 29.

4 [MENU, SEARCH SET] indication

Lights during menu operation or search setting.

5 [REPEAT REC] indication

Lights when repeat recording is set.

Reference: "5-3 Menu switch details" on page 20 and "6-1 Basic operation" on page 22.

6 [TIMER] indication

Lights in the Timer Record Standby mode or during timer recording.

Reference: "6-2 Program timer recording" on page 23.

7 [REMAIN] indication

Lights when the remaining time is displayed (refer to 8 [DISPLAY] button on page 6 for more details).

8 Counter and function display

The counter is displayed in the Play or Record mode. Pressing the 8 [DISPLAY] button on the front panel (see page 6) switches the display consecutively through CLOCK, DAY, REMAIN and REC QUALITY•REC SPEED.

● SLEEP display

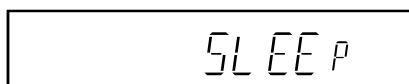

When the [SLEEP] button is pressed, the hard disk stops rotating and "SLEEP" is displayed.

* When the Record mode is engaged from the Sleep mode, the hard disk has to warm up before recording can start. No images will be recorded during this period.

● CLOCK display

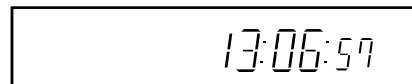

Displays the time.

During playback, the approximate time of the recording is displayed. Accuracy of the display time varies depending on the recording speed.

Reference: "4-3 Setting the date and time" on page 13.

● DAY display

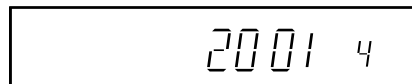

Switching with 1-second interval.

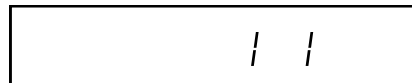

e.g.: Jan. 1, 2001 is displayed.

● REMAIN TIME display

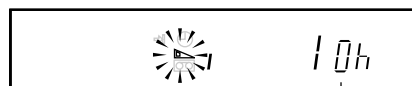

Lights

Remaining time

Displays the remaining recording time.

— Memo: —

- If REPEAT REC is set, 5 [REPEAT REC] and "REPEAT" are displayed. Remaining time is not displayed.

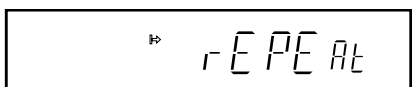

● REC QUALITY•REC SPEED display

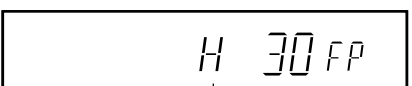

REC QUALITY REC SPEED

* The 1/2, 1/5 and 1/10 frame are shown as below.

1/2 frame:

1/5 frame:

1/10 frame:

Reference: DVR MODE in "5-3 Menu switch details" on page 19.

3 CONNECTIONS

3-1 Recording video signals from a camera

This section describes how to connect a camera and record camera signals. When more than one camera is connected, the cameras must be synchronized. Multi-camera connections are discussed in the next section.

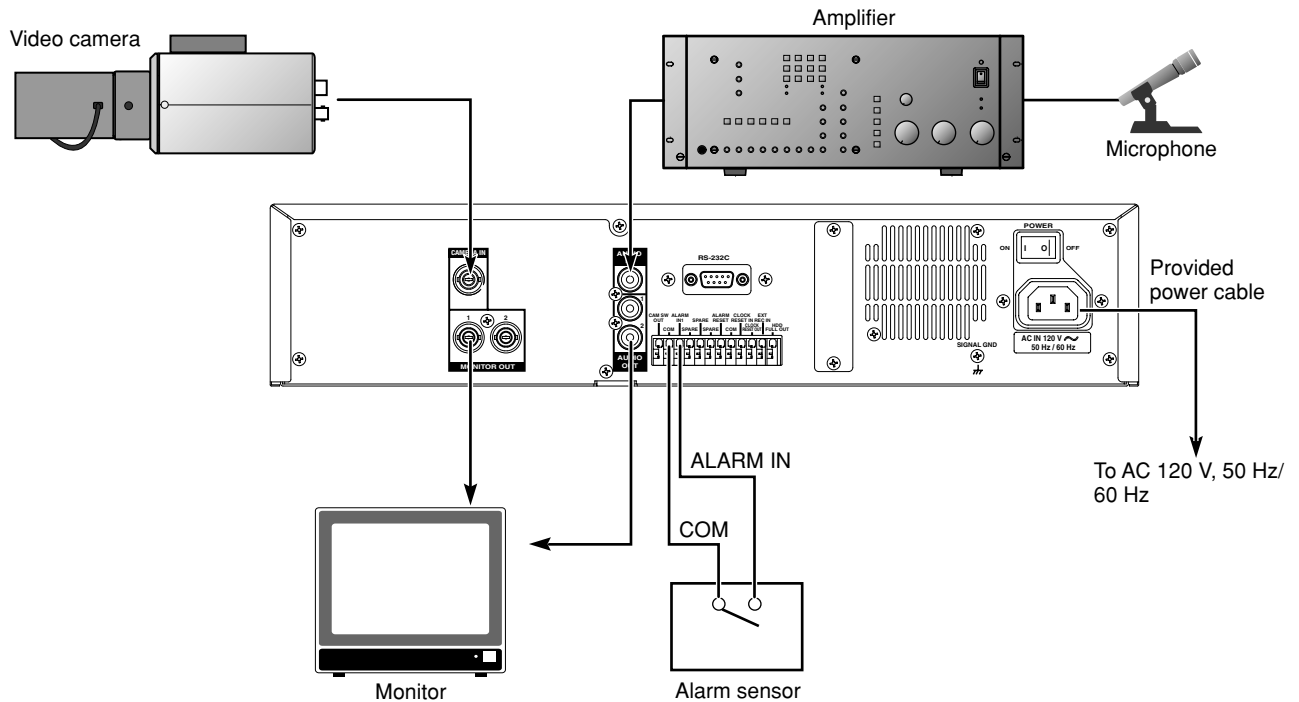

Connecting a camera

1. Connect the [MONITOR OUT] and [AUDIO OUT] connectors to the monitor's video and audio connectors.
2. Connect [CAMERA IN] connector to the video camera's video output connector.
3. To record sound, connect a microphone amplifier to the [AUDIO IN] connector.
4. To record an alarm, connect the alarm sensor to the [ALARM IN 1] and [COM] signal input/output terminals.
5. After all connections are complete, connect the power cable to the [AC IN] socket and connect the plug to an AC 120 V outlet.
6. Turn ON all connected equipment, then turn the [POWER] switch on the rear panel to ON.

Menu switch setting

Example of settings when using an alarm sensor and recording audio.

- DVR MODE
 - [REC QUALITY] set to "N"
 - [REC SPEED] set to "30"
 - [AUDIO REC] set to "ON"
- ALARM/SENSOR MODE
 - [REC MODE] set to "ALARM"

Reference: "5-3 Menu switch details" on page 19.

Caution:

- Before connecting or disconnecting any equipment, turn the power of all connected equipment OFF.

3 CONNECTIONS (contd.)

3-2 Connecting more than one camera (using an external switcher)

When an external switcher is connected to the [CAMERA IN] connector of this unit, images from multiple cameras can be recorded. Select the camera image with the switcher.

- For a connectable multiplexer (switcher), consult your JVC dealer.

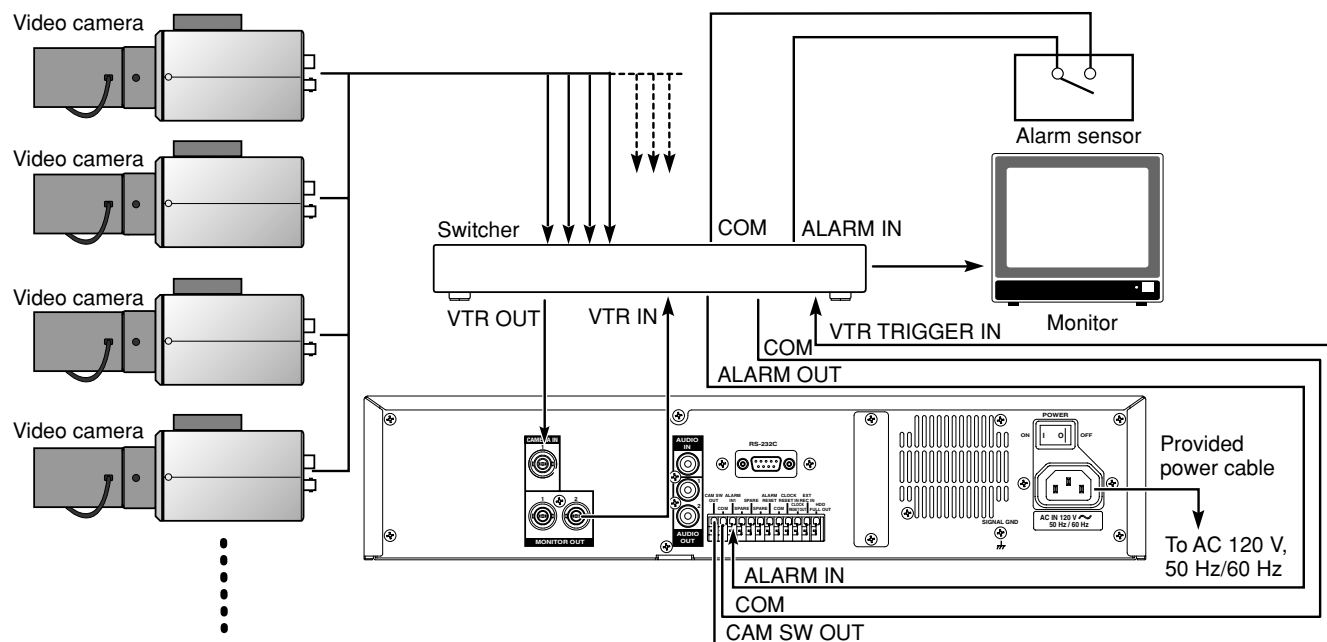

Connection procedures

1. Connect the video output connector of the frame switcher to the video input connector of the monitor.
2. Connect the camera to the [CAMERA IN] connector of the frame switcher.
* For camera connections, refer to the frame switcher's instructions.
3. Connect the frame switcher's [VTR OUT] connector to the [CAMERA IN] connector of this unit.
4. Connect the [MONITOR OUT] connector of this unit to the frame switcher's [VTR IN] connector.
5. Connect the alarm sensor to the frame switcher.
6. Connect the frame switcher's [VTR TRIGGER] and [ALARM OUT] signal input/output terminals to the [CAM SW OUT] and [ALARM IN 1] terminals of this unit.
7. After all connections are complete, connect the power cable to the [AC IN] socket and connect the plug to an AC 120 V outlet.
8. Turn ON all connected equipment, then turn the [POWER] switch on the rear panel to ON.

Menu switch setting

Example of settings when alarm recording is performed using an external switcher.

- **DVR MODE**
[REC QUALITY] set to "N"
[EXT SWITCHER] set to "ON"
- **ALARM/SENSOR MODE**
[REC MODE] set to "ALARM"
[REC DURATION] set to "MANUAL" when the alarm time is set with the switcher
This unit continues recording for about 5 seconds after the alarm duration set with the switcher has passed.

Reference: "5-3 Menu switch details" on page 19.

Caution:

- Before connecting or disconnecting any equipment, turn the power of all connected equipment OFF.
- When a field switcher is used, picture quality will be degraded if [REC QUALITY] is set to "H". In some cases, the specified camera may not be used or the playback picture may move up and down.
- As the camera switching signal is recorded, the picture on the lower section of the monitor screen may be missing. To record the external switcher's on-screen display, set the display to the upper section of the screen.

Memo:

- Select the camera with the switcher.
- The monitor picture may not be switched during jog/shuttle operation and skip search operation. This is because the playback camera number is different from the camera number selected with the switcher. To display the picture from the selected camera on the monitor, press the [PLAY] button.

3 CONNECTIONS (contd.)

3-3 Connecting signal input/output terminals

[CAM SW OUT] camera switching signal output terminal

To control the camera switching timing from this unit.

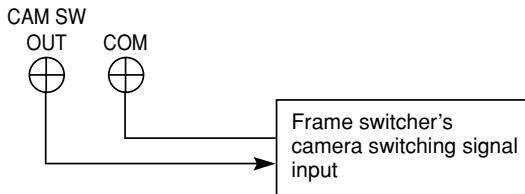

Reference: "3-2 Connecting more than one camera (using an external switcher)" on page 10.

[ALARM RESET] alarm signal reset input terminal

To stop alarm recording when a signal is received during alarm recording.

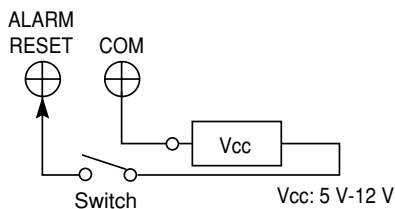

[CLOCK RESET IN] clock reset input terminal

To set the clock to the master clock or other device's clock using a signal from an external device.

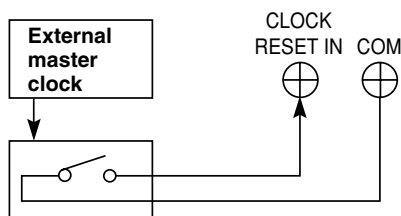

[EXT REC IN] external recording control signal input terminal

Recording can be started, stopped or controlled with an external signal.

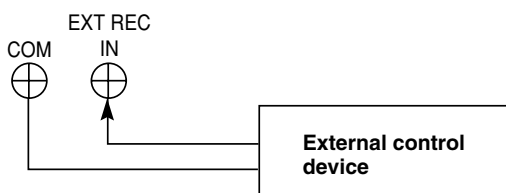

[ALARM IN] alarm signal input terminal

Starts alarm or sensor recording when a signal is received.

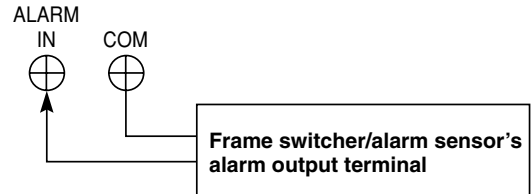

[HDD FULL OUT] HDD full-output terminal

Outputs a signal during recording when the hard disk is full.

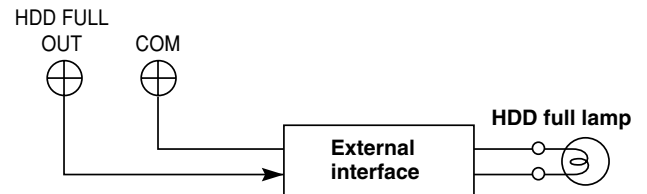

* Signal output is possible only when menu switch <HDD FULL OUT> is set to "ON" and <REPEAT REC> is not set to "OFF".

[CLOCK RESET OUT] clock reset terminal

Outputs a clock reset signal. It is possible to set the clock of the digital video recorders following this unit to that of this unit in second unit.

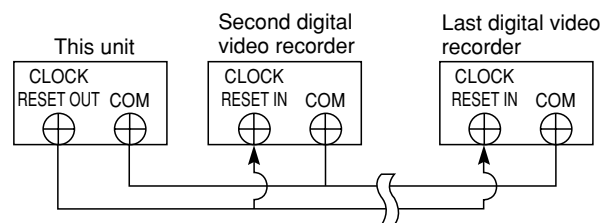

External interface specifications example

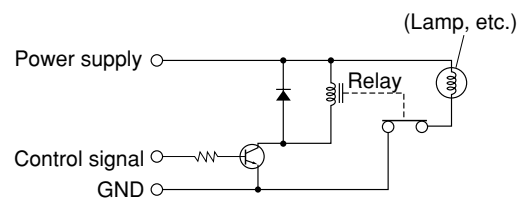

• Use each device rated for using situation.

4 PREPARATION

4-1 Installing a battery

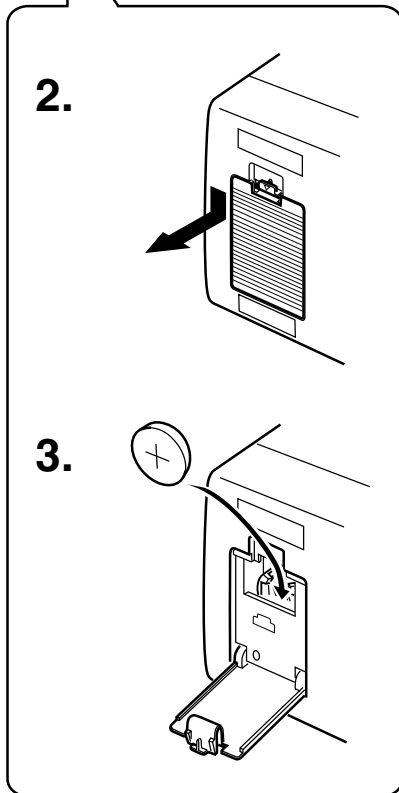
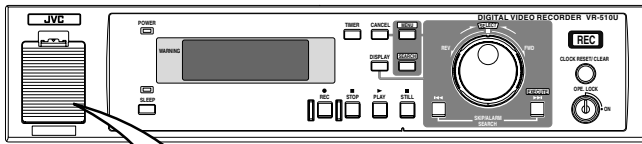

1. Turn the [POWER] switch OFF.
2. Open the battery cover.
While pushing down the pawl in the upper section of the battery cover, pull it towards you to open the cover.
3. Install a battery.
Install the provided battery (CR2032) with the + side facing you.
4. Close the battery cover.
Close it until the pawl is locked firmly.

Caution:

- When the power is supplied, do not replace the battery. Otherwise, a malfunction may occur.
- Replace the battery with a CR2032 type battery. Using any other type of battery may present a risk of fire or explosion.

Memo:

- When you replace the battery, be sure to set the date and time again.
Reference: "4-3 Setting the date and time" on page 13.
- After replacing the battery, be sure to program the program timer again because the programs are reset.
- When "LOW BATTERY" is displayed, check the battery again.

4-2 Power supply

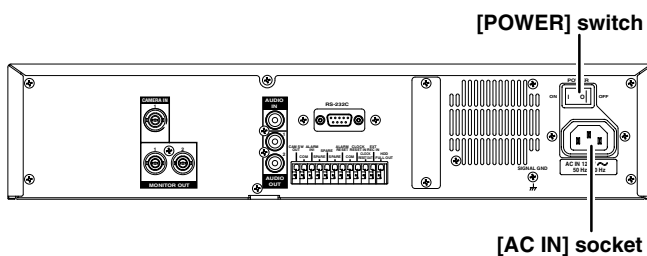

1. Connect the power cable.
Connect the provided power cable to an AC 120 V outlet.
2. Press the [POWER] switch to ON.
The system check starts for this unit and "SYSTEM LOADING ..." is displayed on the monitor.
"LoAd--" blinks on the display panel.

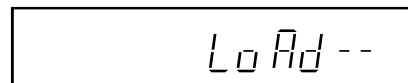

Caution:

- After all other equipment connections are complete, turn the power of this unit ON.

Memo:

- All operation functions are disabled during system check. Wait until "SYSTEM LOADING ..." goes out.

4 PREPARATION (contd.)

4-3 Setting the date and time

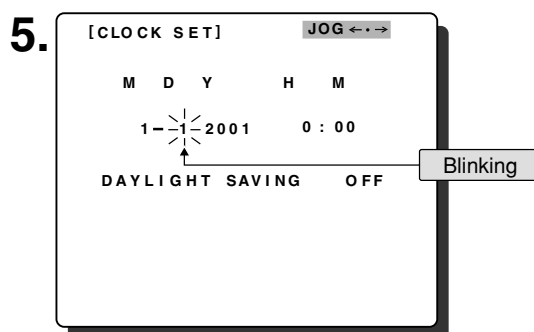
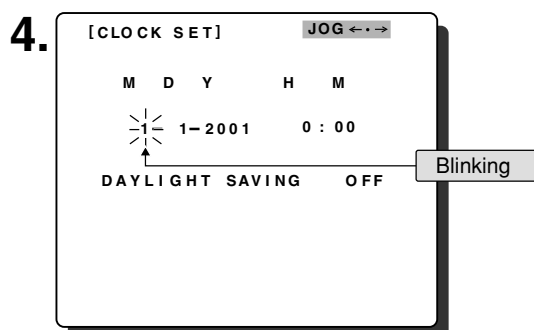
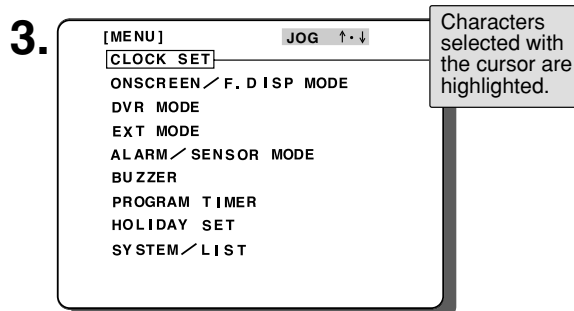
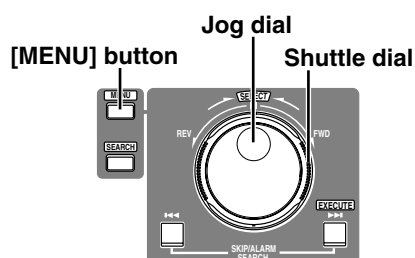

1. **Turn the power ON.**
Check the connections and press the [POWER] switch ON.
2. **Display the main menu.**
Press the [MENU] button to display the main menu screen.
Refer to "Jog/shuttle dial operation" on page 16 and set the jog dial function with the shuttle dial operation.
3. **Display the [CLOCK SET] screen.**
Set the cursor on [CLOCK SET] with [JOG ↑ ↓]. Turn the shuttle dial to display the [CLOCK SET] screen.
4. **Set the month.**
Set "month" with [JOG - +].
5. **Set the day.**
Set the blinking cursor on "D" with [JOG ← →] and set the day with [JOG - +].
6. **Set the year, hour and minute.**
Repeat the procedure for step 5 for setting.
7. **Enter.**
When all settings are complete, press the [MENU] button twice to restore the normal screen.

Note:

- If the date is changed when there is recorded data on the hard disk, make sure the recording date and time do not overlap.
Otherwise, playback operation, skip search and direct search may not function correctly.

4-4 Daylight-saving compensation

Use the <DAYLIGHT SAVING> menu switch on the CLOCK SET setting screen to turn the Daylight Saving mode ON or OFF.

When <DAYLIGHT SAVING> is "ON", the set time is advanced one hour.

- When setting the time, make sure the <DAYLIGHT SAVING> switch is "OFF".
When the unit is shipped, this switch is set to "OFF".
- Clock setting is not possible during timer recording.

During daylight-saving time

1. Set the time one hour behind the actual time.
2. After setting the time, set the <DAYLIGHT SAVING> switch to "ON".
 - The time advances one hour.
3. At the end of the daylight-saving time season, set the <DAYLIGHT SAVING> switch to "OFF".
 - The standard time is displayed.

Standard time

1. Set the clock to the actual time.
2. When the daylight-saving season starts, set the <DAYLIGHT SAVING> menu switch to "ON".
 - The display time advances one hour.

5 ON-SCREEN DISPLAY/MENU SWITCHES

5-1 On-screen display

Date, time, number of alarms and remaining hard disk capacity can be displayed on-screen. Date and time data can be recorded together with the video signals by setting the <TIME DATE REC> menu switch to "ON".

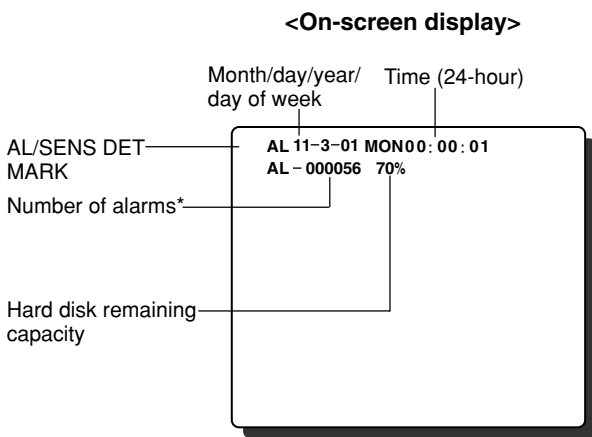
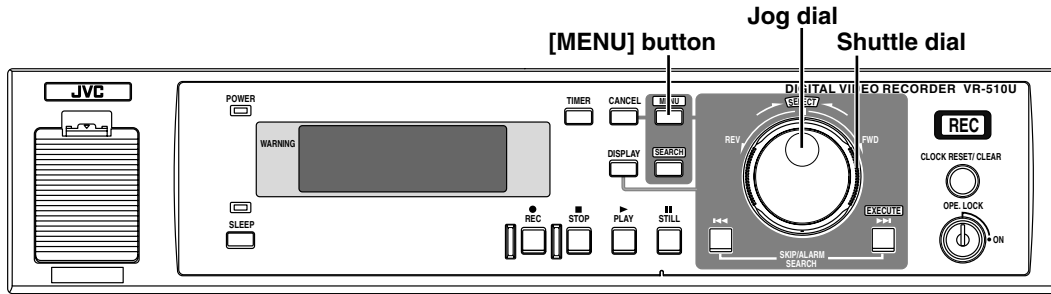

* "SN-****" is displayed in the sensor recording mode.

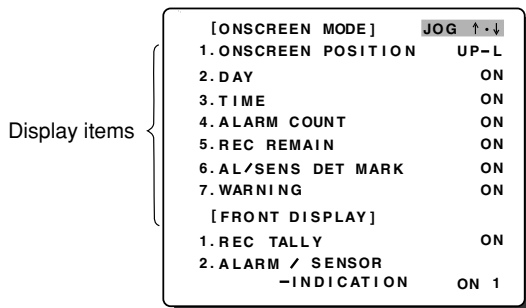
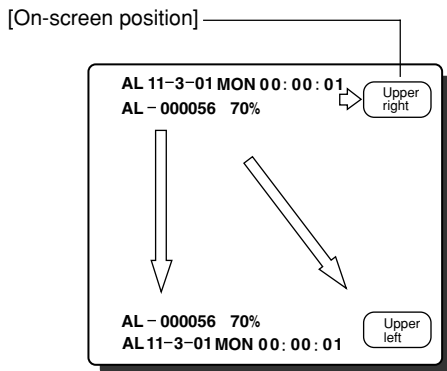

Preparation

- Connect the monitor's video signal input connector to the VR-510U's [MONITOR OUT] connector.
- 1. Turn ON this unit and the monitor.
 - When a signal is input to the video input connector, on-screen data is superimposed on the picture.
 - If no signal is input, on-screen data is superimposed on a black screen.

To change the position of the on-screen display

- Set with menu switch <ON SCREEN POSITION>.
- Reference:** "5-3 Menu switch details" on page 19.

To select the contents of the on-screen display

- Set on the [ON SCREEN MODE] screen. Set the items you want to display to "ON".
 - If you do not want to display an item, set it to "OFF".
- * For menu switch setting, refer to "Setting" in "5-2 Menu switches" on page 18.

To record the on-screen display

- Set menu switch <TIME DATE REC>, <DAY> and <TIME> to "ON".
- * If <DAY> and <TIME> are set to "OFF", the on-screen display will not be recorded even if <TIME DATE REC> is set to "ON".

5-2 Menu switches

Menu flow

Main menu screen

```
[MENU] JOG ↑↓
CLOCK SET
CNSCREEN/F.DISP MODE
DVR MODE
EXT MODE
ALARM/SENSOR MODE
BUZZER
PROGRAM TIMER
HOLIDAY SET
SYSTEM/LIST
```

```
[CLOCK SET] JOG ←→
M D Y H M
1- 1-2001 0:00
DAYLIGHT SAVING OFF
```

```
[ONSCREEN MODE] JOG ↑↓
1. ONSCREEN POSITION UP-L
2. DAY ON
3. TIME ON
4. ALARM COUNT ON
5. REC REMAIN ON
6. AL/SENS DET MARK ON
7. WARNING ON
[FRONT DISPLAY]
1. REC TALLY ON
2. ALARM / SENSOR
-INDICATION ON 1
```

```
[DVR MODE] JOG ↑↓
1. REC QUALITY NORM
2. REC SPEED 30
REC TIME 27H
3. AUDIO REC ON
4. POWER ON REC ON
5. SEARCH BUTTON TIME
6. SKIP DURATION 1HOUR
7. REPEAT REC OFF
8. TIME DATE REC ON
9. OPERATE LOCK MODE ALL
10. EXT SWITCHER ON
```

```
[EXT MODE] JOG ↑↓
1. REC MODE OFF
2. HDD FULL OUT OFF
[ALARM/SENSOR MODE]
1. REC MODE OFF
2. REC DURATION 180SEC
3. PRESENSOR REC OFF
4. PRESENSOR
-REC DURATION 10SEC
```

```
[BUZZER] JOG ↑↓
1. HDD END ON
2. ALARM/SENSOR ON
3. WARNING ON
```

```
[PROGRAM TIMER] JOG ↑↓
START END MODE PRG
SUN --:-- --:-- --:-- --:--
MON --:-- --:-- --:-- --:--
TUE --:-- --:-- --:-- --:--
WED --:-- --:-- --:-- --:--
THU --:-- --:-- --:-- --:--
FRI --:-- --:-- --:-- --:--
SAT --:-- --:-- --:-- --:--
DAY --:-- --:-- --:-- --:--
DAI LY SET SUN MON
TUE WED THU FRI SAT
```

```
[HOLIDAY SET] JOG ↑↓
START END MODE PRG
--:-- --:-- --:-- --:--
1: ---- 2: ----
3: ---- 4: ----
5: ---- 6: ----
7: ---- 8: ----
9: ---- 10: ----
11: ---- 12: ----
13: ---- 14: ----
15: ---- 16: ----
```

```
[SYSTEM] JOG ↑↓
UTILITY [80 GB]
[LIST]
HOUR METER /
POWER LOSS LIST
```

```
[UTILITY] JOG ↑↓
1. AUTO SCANDISK OFF
2. MANUAL SCANDISK OFF
3. QUICK ERASE OFF
CURRENT FORMAT STD
```

```
[HOUR METER]
HDD RUN TIME 000000H
[POWER LOSS LIST]
PL-----:-----:-----
PL-----:-----:-----
PL-----:-----:-----
PL-----:-----:-----
```

5-2 Menu switches (contd.)

Jog/shuttle dial operation

Use the jog/shuttle dial to set the menu or search menu items.

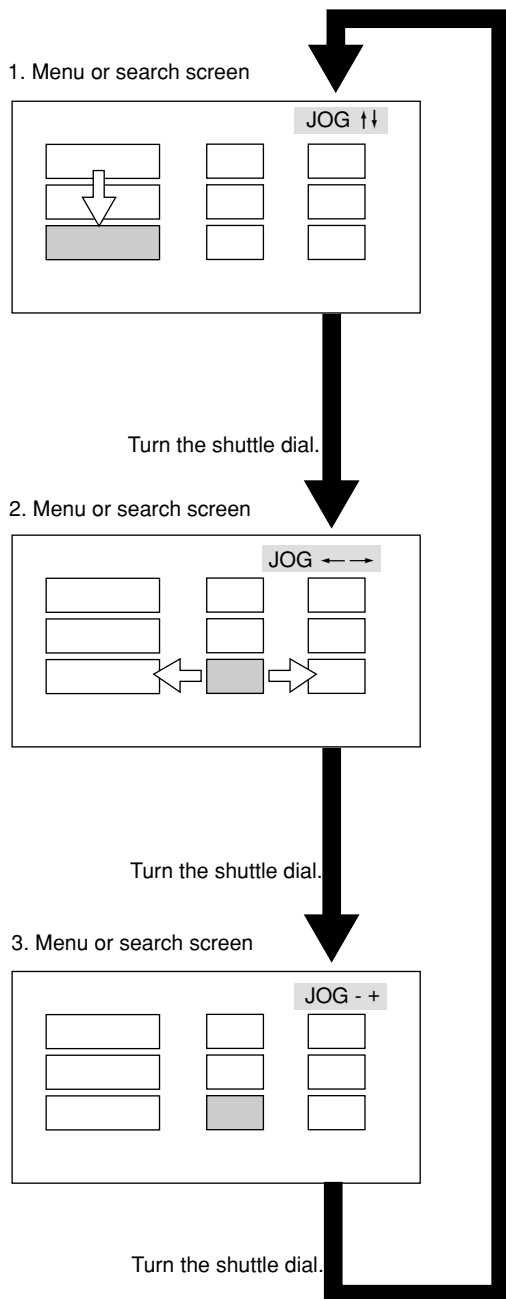
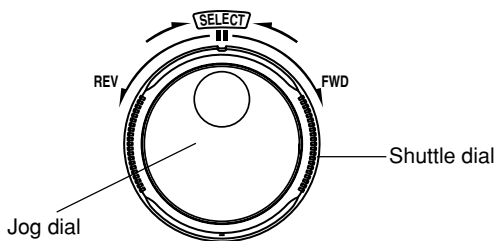

Shuttle dial operation

Turn the shuttle dial to the right or left so that it passes the SELECT position.

■ Main menu or search menu screen

- Turning the shuttle dial displays the selected main menu or search menu screen for menu switch setting.

■ Menu switch setting screen

- Each time the shuttle is turned, the jog operation function is switched.

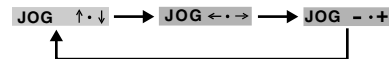

Jog dial operation

1. JOG ↑ ↓ function

Turn the jog dial to move the cursor or blinking mark up and down.

2. JOG ← → function

Turn the jog dial to move the cursor or blinking mark to the right and left.

3. JOG - + function

Turn the jog dial to change the set value.

Memo:

- For setting procedure, refer to the page 17 and on.

5-2 Menu switches (contd.)

Display

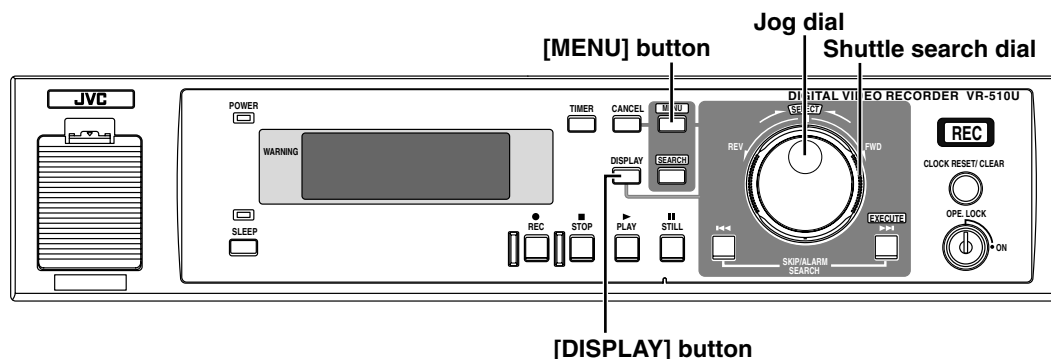

<Main menu screen>

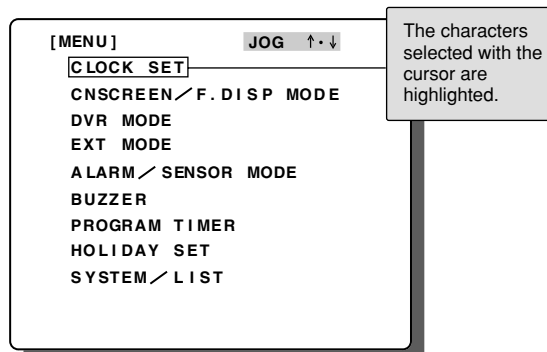

■ Connect the [MONITOR OUT] connector to the monitor's video input connector.

1. Turn this unit and the monitor ON.
2. Display the main menu screen.
Press the [MENU] button to display the main menu screen on the monitor.
Switch the jog dial function with the shuttle dial as described in "Jog/shuttle dial operation" on page 16.
3. Select the item to be set.
Turn the Jog dial (in JOG ↑ ↓ mode) to move the cursor over the desired item.
4. Display the menu switch setting screen.
Turn the shuttle dial to display the menu switch setting screen for the selected item.
5. Return to the main menu screen.
To restore the main menu screen, press the [MENU] button. Press it again to restore the normal screen.

Main menu item details

- Clock setting
To display the date and clock setting screen. Before using this unit for the first time, you must set the date and time.
Reference: "4-3 Setting the date and time" on page 13.
- On-screen display setting
To set items to be displayed on screen.
- Front display setting
These menu switches are used to set indicator lighting preferences.
- DVR mode setting
These menu switches are used to set operation preferences including recording picture quality and repeat recording/playback.
- External recording setting
These menu switches are used to specify settings for the externally activated automatic recording and switching signal output ON/OFF when the hard disk is full.
- Alarm/sensor recording setting
These menu switches are used to set alarm/sensor recording preferences.
- Buzzer setting
These menu switches switch the alarm/sensor buzzer and the full hard disk warning buzzer ON/OFF.
- Program timer setting
To display the program setting screen for timer recording.
- Holiday setting
To display the timer recording program setting screen for a specified date such as a holiday.
- System setting
These menu switches are used to set maintenance preferences such as disk scanning and formatting.

5-2 Menu switches (contd.)

Setting

<Main menu screen>

3.

[MENU]	JOG ↑·↓
CLOCK SET	
CNSCREEN / F. DISP MODE	
DVR MODE	
EXT MODE	
ALARM / SENSOR MODE	
BUZZER	
PROGRAM TIMER	
HOLIDAY SET	
SYSTEM / LIST	

The characters selected with the cursor are highlighted.

5.

[DVR MODE]	JOG ↑·↓
1. REC QUALITY	NORM
2. REC SPEED	30
REC TIME	27H
3. AUDIO REC	ON
4. POWER ON REC	ON
5. SEARCH BUTTON	TIME
6. SKIP DURATION	1HOUR
7. REPEAT REC	OFF
8. TIME DATE REC	ON
9. OPERATE LOCK MODE	ALL
10. EXT SWITCHER	ON

Select with JOG ↑·↓.

6.

[DVR MODE]	JOG ↑·↓
1. REC QUALITY	NORM
2. REC SPEED	30
REC TIME	27H
3. AUDIO REC	ON
4. POWER ON REC	ON
5. SEARCH BUTTON	TIME
6. SKIP DURATION	1HOUR
7. REPEAT REC	OFF
8. TIME DATE REC	ON
9. OPERATE LOCK MODE	ALL
10. EXT SWITCHER	ON

Select with JOG - +.

1.

REC QUALITY REC SPEED

2.

Set when this indicator blinks rapidly.

3.

Set when this indicator blinks rapidly.

■ Connect the [MONITOR OUT] connector to the monitor's video input connector.

- 1. Turn this unit and the monitor ON.**
Data is displayed on-screen.
- 2. Display the main menu screen.**
Press the [MENU] button to display the main menu screen.
Switch the jog dial function with the shuttle dial as described in "Jog/shuttle dial operation" on page 16.
- 3. Select the item to be set.**
Turn the Jog dial [JOG ↑↓] to move the cursor over the desired item.
- 4. Display the menu switch setting screen.**
Turn the shuttle dial to display the menu switch setting screen for the selected item.
- 5. Select the menu switch to be set.**
Select the menu switch item to be set with [JOG ↑↓].
- 6. Change the set value.**
Change the set value with [JOG - +].
* To change the other menu switches, press the [MENU] button to return to the main menu screen.
- 7. Quit the menu switch setting.**
When all settings are complete, press the [MENU] button twice. The normal screen is restored.

■ Set <REC QUALITY> and <REC SPEED> on the display panel.

- 1. Set the recording set display.**
Press the [DISPLAY] button for about 2 seconds (not available during recording).
The <REC SPEED> setting section blinks slowly.
Switch the jog dial function with the shuttle dial as described in "Jog/shuttle dial operation" on page 16.
- 2. Set <REC SPEED>.**
When the shuttle dial is turned, the <REC SPEED> setting section blinks rapidly. Turn the jog dial to set the required recording speed.
- 3. Set <REC QUALITY>.**
Turn the shuttle dial so that the <REC SPEED> setting section blinks slowly. Turn the jog dial so that the <REC QUALITY> setting section blinks slowly. Repeat the procedure in Step 2 to set the picture quality.
- 4. End setting.**
Press the [DISPLAY] button to restore the normal display.
* If the Record mode is engaged during setting, the normal display is automatically restored (ALARM/SENSOR MODE, etc.).

5 ON-SCREEN DISPLAY/MENU SWITCHES (contd.)

5-3 Menu switch details

The setting in [] is the factory setting.

Setting item	Menu switch	Setting value	Description
ON SCREEN MODE	ON SCREEN POSITION	[UP-L] UP-R LOW-L LOW-R	Sets the on-screen display position.
	DAY	[ON] OFF	Sets the on-screen day/month/year display. ON : Displayed. OFF: Not displayed.
	TIME	[ON] OFF	Sets on-screen clock display ON : Displayed. OFF: Not displayed.
	ALARM COUNT	[ON] OFF	Sets the on-screen alarm/sensor number display. ON : Displayed. OFF: Not displayed.
	REC REMAIN	[ON] OFF	Sets the on-screen remaining hard disk capacity display. ON : Displays the remaining capacity (does not display it when the repeat recording is set to "ON"). OFF: Does not display the remaining capacity.
	AL/SENS DET MARK	[ON] OFF	Sets whether or not the "AL" mark is displayed on screen during alarm/sensor recording. ON : Displayed. OFF: Not displayed.
	WARNING	[ON] OFF	Sets whether or not warnings are displayed on screen when an abnormality occurs. ON : Displayed. OFF: Not displayed.
FRONT DISPLAY	REC TALLY	[ON] OFF	Sets whether or not the recording indicator on the front panel lights during recording. ON : Indicator lights. OFF: Indicator does not light.
	ALARM/SENSOR INDICATION	[ON1] ON2 OFF	Sets whether or not the recording indicator blinks when an alarm/sensor signal is input. ON1 : Indicator blinks during alarm/sensor recording. ON2 : Indicator blinks when alarm/sensor recording is completed (this mode can be released with the [CANCEL] button). * ON1 and ON2 are effective only when menu switch <REC TALLY> is set to "ON". OFF: The indicator lights during alarm/sensor recording.
DVR MODE	REC QUALITY	HIGH [NORM] BASIC LOW	Sets the recording picture quality. HIGH : High-quality recording. NORM : Normal-quality recording. BASIC : Middle-quality recording. LOW : Low-quality recording. Reference: "11-1 Recording time" on page 47.
	REC SPEED	[30] 15 10 5 3 2 1 1/2 1/5 1/10	Sets the number of frames to be recorded. The displayed value shows the number of frames recorded in one second. <REC TIME> shows the available recording time on the hard disk. The amount of recording time available depends on the settings of <REC SPEED> and <REC QUALITY>, as well on the amount of free space remaining on the disk. Reference: "11-1 Recording time" on page 47.

5 ON-SCREEN DISPLAY/MENU SWITCHES (contd.)

5-3 Menu switch details (contd.)

Setting item	Menu switch	Setting value	Description
DVR MODE	AUDIO REC	[ON] OFF	Sets whether or not audio signals are recorded during recording. ON : Records audio signals. OFF: Does not record audio signals. *When menu switch <REC SPEED> is set to "1/5" or "1/10", this item will be automatically set to "OFF".
	POWER ON REC	ON [OFF]	Sets whether or not recording re-starts when the power is restored after a power failure. To automatically re-start recording, set this switch to "ON".
	SEARCH BUTTON	[TIME] ALARM EVENT	Selects the [SEARCH] button function. TIME : Executes time search when the [SEARCH] button is pressed. ALARM: Executes alarm search when the [SEARCH] button is pressed. EVENT: Executes event search when the [SEARCH] button is pressed. Reference: "7-3 Skip search" on page 33.
	SKIP DURATION	1 MINUTE 5 MINUTE 10 MINUTE 30 MINUTE [1 HOUR] 4 HOUR 1 DAY 1 WEEK	Selects the duration to skip when time search is performed.
	REPEAT REC	[OFF] AL·STOP AL·LOCK ALL	Sets whether or not repeat recording is executed. OFF : Repeat recording is not executed. AL·STOP : Repeat recording is not possible if an alarm recording is executed even once. AL·LOCK : The alarm recording is protected from overwriting during repeat recording. ALL : When no space is available for recording, previous recording are overwritten, starting with the oldest recording. Reference: "Repeat recording during alarm recording" on page 28.
	TIME DATE REC	[ON] OFF	Sets whether or not time/date is recorded during recording. ON : Records the time/date. OFF: Does not record the time/date. *If menu switches <DAY>, <TIME> and <AL/SENS DET MARK> are set to "OFF", the on-screen display is not recorded regardless of this setting.
	OPERATE LOCK MODE	[ALL] REC	Sets the lock operation when the operation lock is set to "ON". ALL : Locks all buttons on the front panel. REC : Locks the [STOP] button on the front panel so hard disk recording cannot be stopped. * Set to "ALL" for timer recording.
	EXT SWITCHER	[ON] OFF	Sets whether or not to use an external switcher. OFF: External switcher not used (no signal output from the [CAM SW OUT] terminal). ON : Uses an external switcher (signals output from the [CAM SW OUT] terminal).
EXT MODE	REC MODE	[OFF] TRIG MANUAL	Sets whether or not automatic recording is executed with an external trigger signal. OFF : Does not execute automatic recording. TRIG : Starts recording with an external signal. MANUAL : Executes recording while external signals are input.
	HDD FULL OUT	[OFF] ON	Sets whether or not the "HDD FULL" signal is output. OFF: Does not output an HDD FULL signal. ON : Outputs a signal when the remaining capacity of the hard disk is 0%. When <REPEAT REC> is set to "ALL", signals are not output.

5 ON-SCREEN DISPLAY/MENU SWITCHES (contd.)

5-3 Menu switch details (contd.)

Setting item	Menu switch	Setting value	Description
ALARM/ SENSOR MODE	REC MODE	[OFF] ALARM SENSOR	Sets the alarm or sensor recording. OFF : Does not execute alarm/sensor recording. ALARM : Executes alarm recording. SENSOR : Executes sensor recording. Reference: "6-4 Alarm recording" on page 28 and "6-5 Sensor recording" on page 29.
	REC DURATION	10 SEC 15 SEC 30 SEC 60 SEC 120 SEC [180 SEC] MANUAL	Selects the recording duration when an alarm or sensor signal is input. 10 SEC : Executes alarm/sensor recording for 10 sec. 15 SEC : Executes alarm/sensor recording for 15 sec. 30 SEC : Executes alarm/sensor recording for 30 sec. 60 SEC : Executes alarm/sensor recording for 60 sec. 120 SEC : Executes alarm/sensor recording for 120 sec. 180 SEC : Executes alarm/sensor recording for 180 sec. MANUAL : Executes alarm recording for as long as an alarm signal is input. *Recording continues about 5 seconds after the set duration has passed. (<AL/SENS DET MARK> is also shown.)
	PRESENSOR REC	[OFF] ON	Sets whether or not pre-sensor recording is executed. To execute pre-sensor recording, set this switch to "ON". Reference: "Pre-sensor recording" on page 29.
	PRESENSOR REC DURATION	[10 SEC] 30 SEC 60 SEC	Selects the recording duration when menu switch <PRESENSOR REC> is set to "ON". Reference: "Pre-sensor recording" on page 29.
BUZZER	HDD END	[OFF] ON	Sets whether or not the buzzer sounds when the hard disk is full (during recording). OFF: The HDD end buzzer does not sound. ON : The buzzer sounds.
	ALARM/SENSOR	[OFF] ON	Sets whether or not the buzzer sounds during alarm/sensor recording. OFF: The buzzer does not sound. ON : The buzzer sounds.
	WARNING	[OFF] ON	Sets whether or not the buzzer sounds when a warning occurs. OFF: The buzzer does not sound. ON : The buzzer sounds.
UTILITY	AUTO SCANDISK	[OFF] ON	Sets whether or not the disk is scanned when the power is turned ON. OFF: Disk is not scanned. *The disk is not scanned unless the Record mode is engaged before the power is turned OFF. ON : Scans the disk when the power is turned ON. Reference: "8-1 Hard disk maintenance" on page 36.
	MANUAL SCAN DISK	[OFF] ON	When this switch is set to "ON" and the [SKIP SEARCH-EXECUTE] button is pressed, the disk is scanned. Reference: "8-1 Hard disk maintenance" on page 36.
	QUICK ERASE	[OFF] STD EXTN	Selects whether the hard disk is formatted with standard or extended mode. When the disk is formatted, all existing data on the hard disk will be erased. OFF : Does not format. STD : Normally, use this position. Up to 13,000 alarm/sensor events can be recorded. EXTN : Set to this position if you want to be able to record more than 13,000 alarm/sensor events (up to about 100,000 events). * Extended formatting takes about 5 minutes to complete. Recording time is shorter than with the standard format. Reference: "8-1 Hard disk maintenance" on page 37.

6 RECORDING

6-1 Basic operation

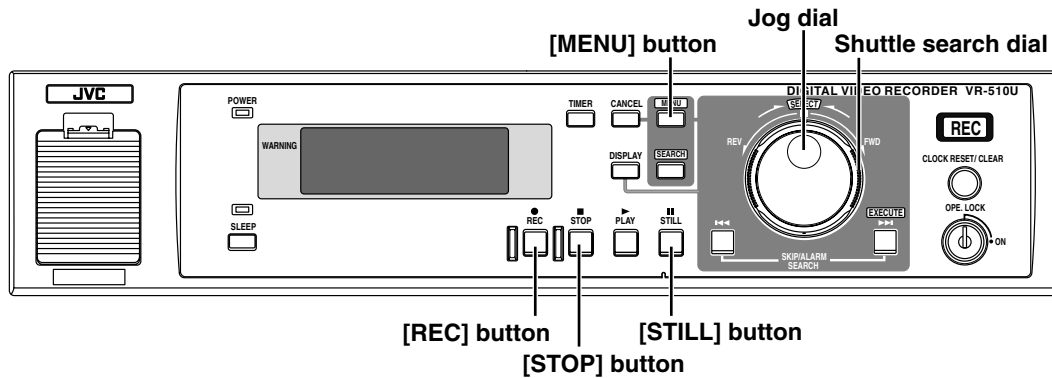

Operation

- 1. Turn the power ON.**
Check the connections and set the [POWER] switch on the rear panel to ON.
- 2. Set the menu switches.**
Set the menu switches as required. For details, refer to "Setting" on page 17. For major menu switches, refer to the description shown on the right.
- 3. Start recording.**
Press the [REC] button to start recording.
- 4. Stop recording.**
Press the [STOP] button to stop recording.

Memo:

- Recording duration can be set with a menu switch. For more details.
Reference: "11-1 Recording time" on page 47.

Major menu switches

■ [DVR MODE] menu switches

- [REC QUALITY] : Sets the recording picture quality.
- [REC SPEED] : Sets the number of fields to be recorded per second.
- [AUDIO REC] : Sets whether or not audio signals are recorded when menu switch <REC SPEED> is set to a position other than 1/5 or 1/10.
- [REPEAT REC] : Sets whether or not repeat recording is executed. When set to "AL·STOP", "AL·LOCK" or "ALL", the [REPEAT REC] indication lights on the display panel.

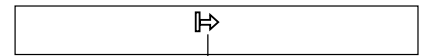

Lights

- [TIME DATE REC] : Sets whether or not time/date is recorded during recording.

Recording system

<Normal recording>

- As shown in the figure on the right, recording is performed consecutively until the hard disk is full.
- Each recorded section (Rec Start To Rec End) is called an event.
- Recording stops when the hard disk is full. Additional recording is not possible.
- * When the hard disk is full (remaining capacity is 0%), a signal is output from the [HDD FULL] terminal. (When menu switch <HDD FULL OUT> is set to "ON" and menu switch <REPEAT REC> is not set to "OFF")

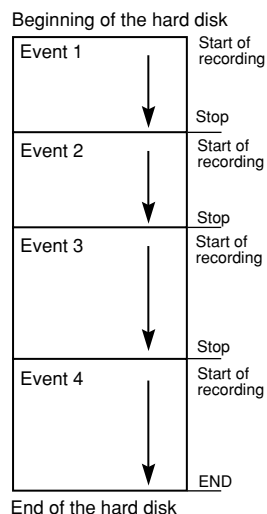

<Repeat recording>

- Allows recording to continue when the hard disk is full by overwriting the oldest previous recordings.
- Recording continues until the [STOP] button is pressed.
- In the Repeat Record mode, the on-screen hard disk remaining capacity indication is not displayed.
- When overwriting starts from the beginning of an event, the entire event will be erased.

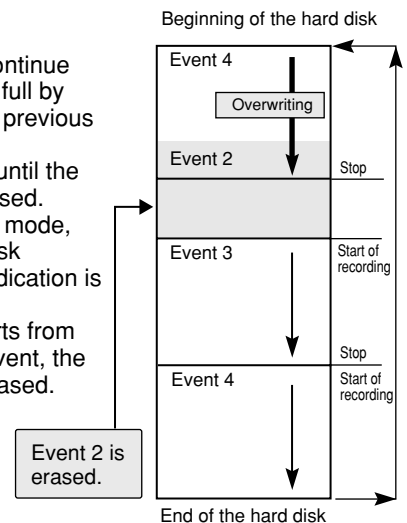

6 RECORDING (contd.)

6-2 Program timer recording

Two types of program timer recording are available: weekly and daily.

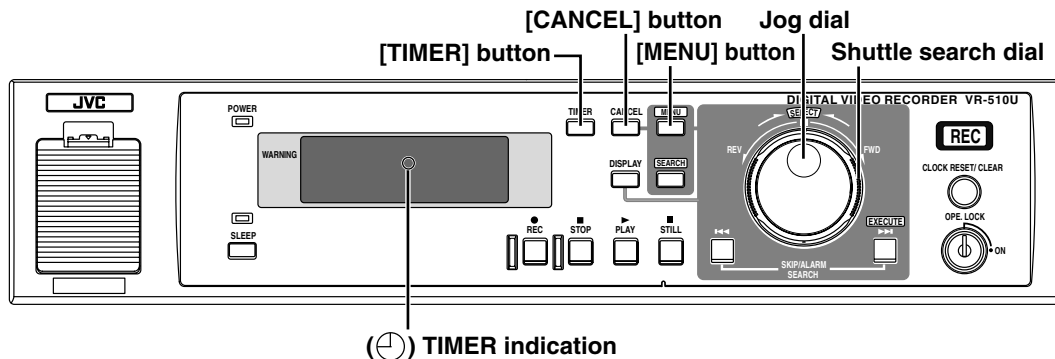

Weekly timer

4. Select with JOG - +.

[PROGRAM TIMER]	JOG ↑ ↓		
START	END	MODE	PRG
SUN	---	---	---
MON	---	---	---
TUE	---	---	---
WED	---	---	---
THU	---	---	---
FRI	---	---	---
SAT	---	---	---
DAY	---	---	---
DAI LY SET	SUN MON		
	TUE WED THU FRI SAT		

5. Set the start time.

6.

[PROGRAM TIMER]	JOG ↑ ↓		
START	END	MODE	PRG
SAT	---	---	---
MON	---	---	---
TUE	---	---	---
WED	---	---	---
THU	---	---	---
FRI	---	---	---
SAT	---	---	---
DAY	---	---	---
DAI LY SET	SUN MON		
	TUE WED THU FRI SAT		

10.

[PROGRAM TIMER]	JOG ↑ ↓		
START	END	MODE	PRG
SAT	08:00	17:00	N 10 WLY
MON	---	---	---
TUE	---	---	---
WED	---	---	---
THU	---	---	---
FRI	---	---	---
SAT	---	---	---
DAY	---	---	---
DAI LY SET	SUN MON		
	TUE WED THU FRI SAT		

Memo:

- When audio is not recorded, the [MODE] indication is reversed.

N 10 → N 10

- Turn the power ON.**
Check the connections and set the [POWER] switch on the rear panel to ON.
- Set [AUDIO REC] to ON/OFF with the <AUDIO REC> menu switch under <DVR MODE>.**
- Display the [PROGRAM TIMER] screen.**
Display the [PROGRAM TIMER] screen. For details, refer to "Setting" on page 18.
- Set the day of the week.**
Select the day of the week with [JOG - +].
- Set the start time (hours).**
Move the blinking cursor to the start time "hour" with [JOG ← →]. Set the hours with [JOG - +].
- Set the start time (minutes).**
Move the blinking cursor on the start time "minute" with [JOG ← →]. Set the minutes with [JOG - +].
- Set the stop time hours and minutes.**
Set the stop time hours and minutes as described in steps 5 and 6.
* If the stop time is earlier than or the same as the start time, the stop time is automatically set to the next day. "T" will be displayed in front of the stop time.
- Set the picture quality.**
Move the blinking cursor to [MODE] with [JOG ← →]. Then select the picture quality with [JOG - +].
H: High-quality recording
N: Normal-quality recording
B: Medium-quality recording
L: Low-quality recording
- Set frame recording mode (REC SPEED).**
Move the blinking cursor with [JOG ← →] and select <REC SPEED> with [JOG - +].
- Set the timer frequency.**
Move the blinking cursor to [PRG] with [JOG ← →]. Then, select the frequency mode with [JOG - +].
ON : Timer recording is executed once at the specified time.
WLY : Timer recording is executed every week at the specified time on the specified day of the week.
OFF : Timer recording is not executed regardless of program settings.
- End program timer setting.**
When all settings are complete, press the [MENU] button twice. The normal screen is restored.
- Engage the Timer Recording Standby mode.**
Press the [TIMER] button to engage the Timer Recording Standby mode.
The [TIMER] indication (⌚) lights on the display panel.
* To cancel or change the setting, refer to page 26.

6-2 Program timer recording (contd.)

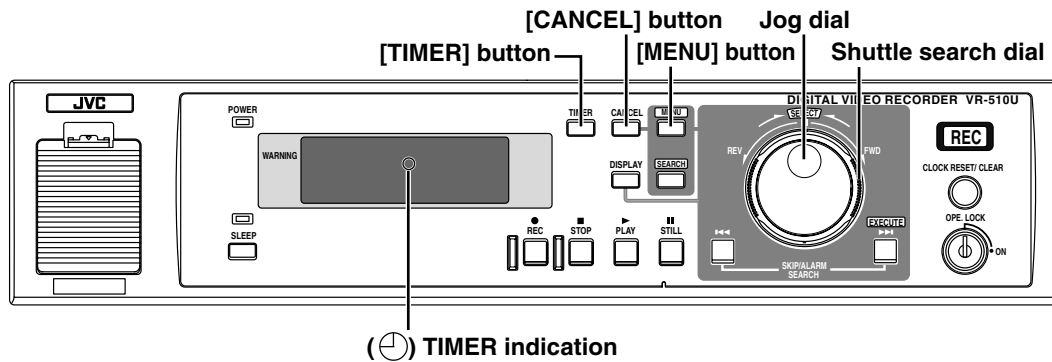

Timer-recording for 24 hours or more

Example: High-quality recording at 1/5 frame per second programmed from 9:00 p.m. Saturday to 8:00 a.m. Monday

8.

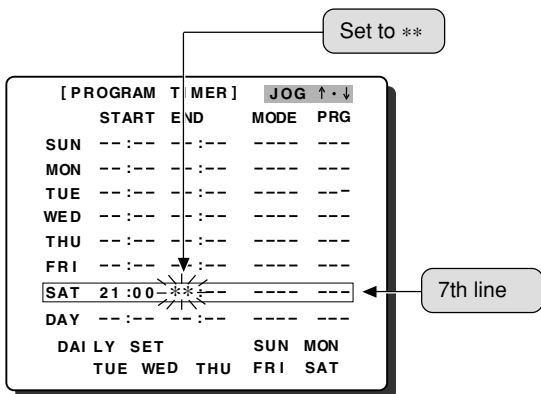

9.

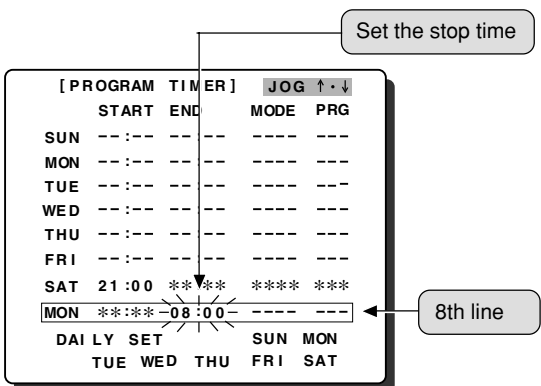

10.

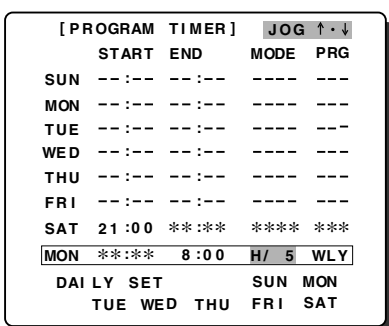

- Turn the power ON.**
Check the connections and set the [POWER] switch on the rear panel to ON.
- Set [AUDIO REC] to ON/OFF with the <AUDIO REC> menu switch under <DVR MODE>.**
- Display the [PROGRAM TIMER] screen.**
Display the [PROGRAM TIMER] screen. For details, refer to "Setting" on page 18.
- Move the cursor to the 7th line.**
Move the cursor to [SAT] on the 7th line with [JOG ↑].
- Set the day of the week.**
Set the blinking cursor on [SAT] with [JOG -].
- Set the start time (hours).**
Move the blinking cursor to the start time "hour" with [JOG ←]. Set "21" with [JOG +].
- Set the start time (minutes).**
Move the blinking cursor to the start time "minute" with [JOG →]. Set "00" with [JOG +].
- Set the stop time (hours).**
Move the blinking cursor on the "hour" for the stop time with [JOG ←]. Set "**" with [JOG +].
As you turn the jog dial, the values change as shown below.
..... "22" → "23" → "*" ← "0" ← "1" ← "2" ...
The stop time indications show "**:* * * *". The start time indications on the 8th line show "**:* * *".
- Set the stop time.**
Move the cursor to the day of the week with [JOG ←] and move it to the 8th line with [JOG ↑]. Set the day of the week (MON) and time (08:00) as described in steps 4 to 6.
- Set the picture quality.**
Move the blinking cursor to [MODE] with [JOG ←]. Select "H" with [JOG -].
- Set the number of frames for recording.**
Move the blinking cursor with [JOG →] and select "1/5" with [JOG +].
- Set timer frequency.**
Move the blinking cursor to [PRG] with [JOG ←]. Select "WLY" with [JOG +].
- End timer programming.**
When all settings are complete, press the [MENU] button twice. The normal screen is restored.
- Engage the Timer Recording Standby mode.**
Press the [TIMER] button to engage the Timer Recording Standby mode.
The [TIMER] indication (⊕) lights on the display panel.
* To cancel or change the setting, refer to page 26.

6-2 Program timer recording (contd.)

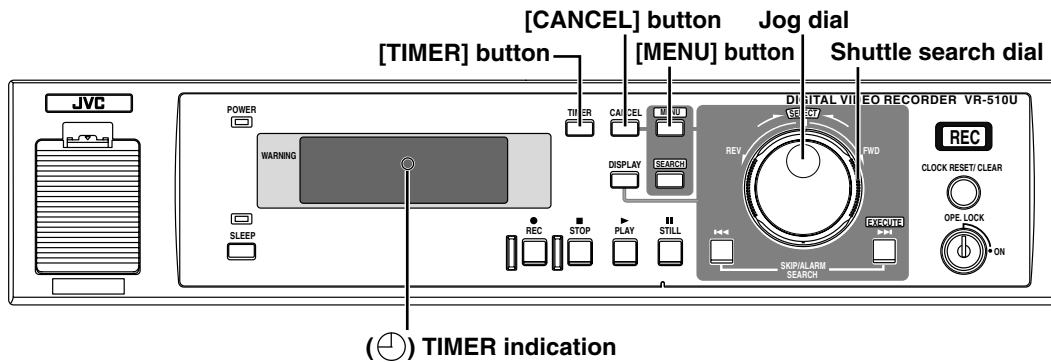

Daily timer

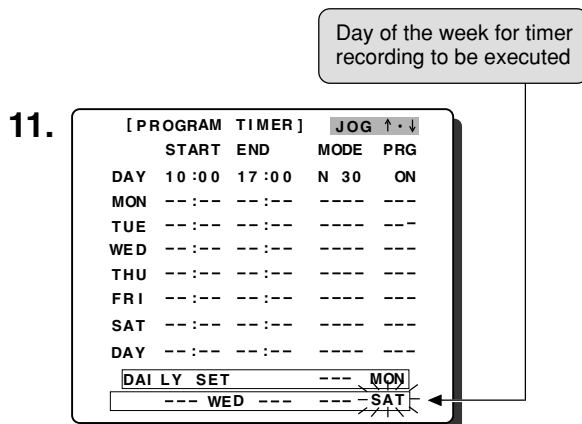
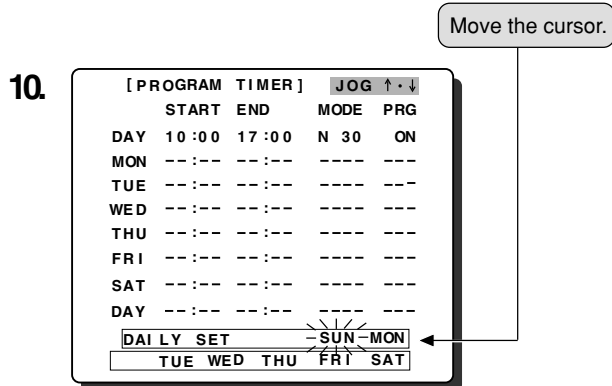
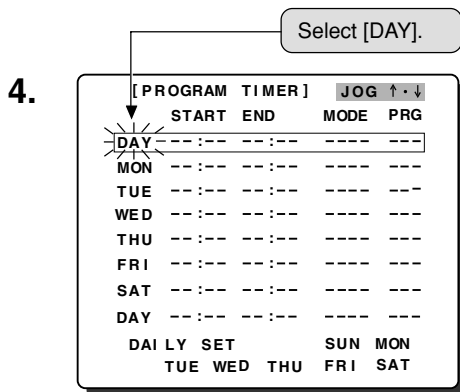

- Turn the power ON.**
Check the connections and set the [POWER] switch on the rear panel to ON.
- Set [AUDIO REC] to ON/OFF with the <AUDIO REC> menu switch under <DVR MODE>.**
- Display the [PROGRAM TIMER] screen.**
Display the [PROGRAM TIMER] screen. For details, refer to "Setting" on page 18.
- Set the day of the week.**
Set the blinking day-of-the-week to "DAILY" with [JOG - +].
- Set the start time (hours).**
Move the blinking cursor to the start time "hour" with [JOG ← →]. Set the required time with [JOG - +].
- Set the start time (minutes).**
Move the blinking cursor to the start time "minute" with [JOG ← →]. Set the required time with [JOG - +].
- Set the stop time hours and minutes.**
Set the stop time hours and minutes as described in steps 5 and 6.
- Set the picture quality.**
Move the blinking cursor to [MODE] with [JOG ← →]. Then select the picture quality with [JOG - +].
H: High-quality recording
N: Normal-quality recording
B: Medium-quality recording
L: Low-quality recording
- Set the recording frame mode (REC SPEED).**
Move the blinking cursor with [JOG ← →] and select <REC SPEED> with [JOG - +]. [PRG] is automatically set to "ON".
- Set the timer frequency.**
Move the cursor to the day-of-the-week position with [JOG ← →] and move it to [DAILY SET] with [JOG ↑ ↓].
- Select the day of the week for timer recording to be executed.**
Move the blinking cursor with [JOG ← →] and select the day of the week for timer recording with [JOG - +]. When "--" is selected, timer recording is not executed.
- End timer programming.**
When all settings are complete, press the [MENU] button twice. The normal screen is restored.
- Engage the Timer Recording Standby mode.**
Press the [TIMER] button to engage the Timer Recording Standby mode.
The [TIMER] indication (⌚) lights on the display panel.
* To cancel or change the setting, refer to page 26.

6 RECORDING (contd.)

6-2 Program timer recording (contd.)

Canceling a timer recording program

1. **Display the [PROGRAM TIMER] screen.**
Display the [PROGRAM TIMER] screen. For details, refer to "Setting" on page 18.
2. **Select the program to be canceled.**
Set the cursor on the program to be canceled with [JOG ↑↓].
3. **Cancel the program.**
Press the [CANCEL] button.
The specified program is canceled.
4. **End timer program setting.**
Press the [MENU] button twice. The normal screen is restored.

Operation in the Timer Recording Standby mode

- Press the [TIMER] button to turn off the [TIMER] indicator. You can now operate the unit normally.
- Press the [TIMER] button again to turn on the [TIMER] indicator. The Timer Recording Standby mode is engaged.
- When all timer recording programs have been executed, the [TIMER] indicator goes out.

Changing timer program settings

1. **Display the [PROGRAM TIMER] screen.**
Display the [PROGRAM TIMER] screen. For details, refer to "Setting" on page 18.
2. **Select the program to be changed.**
Set the cursor on the program to be changed with [JOG ↑↓].
3. **Select the item to change.**
Set the blinking cursor on the item you want to change with [JOG ←→].
4. **Change the contents of the program.**
Change the setting with [JOG - +].
5. **End program editing.**
Press the [MENU] button twice to restore the normal screen.

Estimated recording duration

- During normal timer recording (menu switch <REPEAT REC> set to "OFF"), recording capacity may be limited depending on the recording picture quality and recording speed. If there is not enough space available on the hard disk, the programmed recording may not be performed in its entirety. When the hard disk is full, the programmed timer recording is canceled.
- In the Repeat mode, previous recordings are overwritten. Be careful when using this mode.
- When setting timer recordings, be sure to check how much recording capacity is required for each program. For details, refer to the table below.

<Hard disk space required for one-hour recording> (STANDARD Format) (80 GB)

AUDIO REC	REC QUALITY	30 FPS	15 FPS	10 FPS	5 FPS	3 FPS	2 FPS	1 FPS	1/2 FPS	1/5 FPS	1/10 FPS
ON	HIGH	7.14%	3.57%	2.44%	1.25%	0.78%	0.54%	0.31%	0.19%		
	NORMAL	3.70%	1.85%	1.25%	0.66%	0.43%	0.31%	0.19%	0.13%		
	BASIC	2.78%	1.41%	0.96%	0.52%	0.34%	0.25%	0.16%	0.12%		
	LOW	1.85%	0.96%	0.66%	0.37%	0.25%	0.19%	0.13%	0.10%		
OFF	HIGH	7.14%	3.57%	2.33%	1.16%	0.70%	0.47%	0.23%	0.12%	0.046%	0.023%
	NORMAL	3.57%	1.79%	1.18%	0.59%	0.35%	0.23%	0.12%	0.06%	0.023%	0.012%
	BASIC	2.70%	1.33%	0.88%	0.44%	0.26%	0.18%	0.09%	0.04%	0.018%	0.009%
	LOW	1.79%	0.88%	0.59%	0.29%	0.18%	0.12%	0.06%	0.03%	0.012%	0.006%

<Hard disk space required for one-hour recording> (EXTENSION Format) (80 GB)

AUDIO REC	REC QUALITY	30 FPS	15 FPS	10 FPS	5 FPS	3 FPS	2 FPS	1 FPS	1/2 FPS	1/5 FPS	1/10 FPS
ON	HIGH	8.33%	4.17%	2.70%	1.41%	0.87%	0.61%	0.35%	0.22%		
	NORMAL	4.17%	2.08%	1.41%	0.75%	0.48%	0.35%	0.22%	0.15%		
	BASIC	3.13%	1.59%	1.08%	0.58%	0.38%	0.28%	0.18%	0.13%		
	LOW	2.08%	1.08%	0.75%	0.41%	0.28%	0.22%	0.15%	0.12%		
OFF	HIGH	8.33%	4.00%	2.63%	1.32%	0.79%	0.52%	0.26%	0.13%	0.052%	0.026%
	NORMAL	4.00%	2.00%	1.33%	0.66%	0.40%	0.26%	0.13%	0.07%	0.026%	0.013%
	BASIC	3.03%	1.49%	0.99%	0.50%	0.30%	0.20%	0.10%	0.05%	0.020%	0.010%
	LOW	2.00%	1.00%	0.66%	0.33%	0.20%	0.13%	0.07%	0.03%	0.013%	0.007%

* Actual space used may vary depending on disk conditions and the presence of alarm recordings. This table is meant as a guide only. For 160 GB, the values in the above table should be halved.

<Example>

- When a 3-hour recording is executed with <REC QUALITY> set to "HIGH", <REC SPEED> set to "30" and <AUDIO REC> set to "OFF".
7.14 (%) x 3 (hour) = 21.4 (%)
Before programming the timer recording, confirm that the remaining capacity of the hard disk is 22% or more.

6-3 Holiday timer recording

Timer recording can be performed on specified days during the year such as holidays. When holiday timer recording and programmed timer recording overlap, holiday timer recording has a priority.

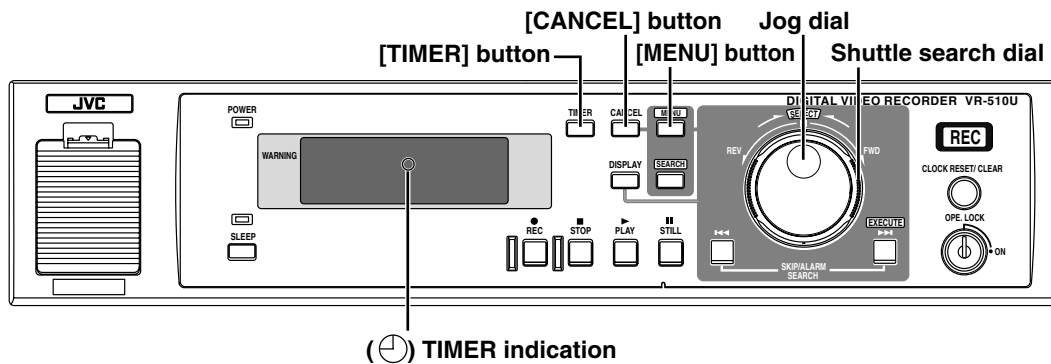

4. Set with JOG - +.

[HOLIDAY SET]		JOG ↑ ↓	
START	END	MODE	PRG
1: 0:00	2: 0:00	---	---
3: 0:00	4: 0:00	---	---
5: 0:00	6: 0:00	---	---
7: 0:00	8: 0:00	---	---
9: 0:00	10: 0:00	---	---
11: 0:00	12: 0:00	---	---
13: 0:00	14: 0:00	---	---
15: 0:00	16: 0:00	---	---

5. Set with JOG - +.

[HOLIDAY SET]		JOG ↑ ↓	
START	END	MODE	PRG
1: 0:00	2: 0:00	---	---
3: 1-15	4: 9-15	---	---
5: 2-12	6: 9-23	---	---
7: 0:00	8: 0:00	---	---
9: 0:00	10: 0:00	---	---
11: 0:00	12: 0:00	---	---
13: 0:00	14: 0:00	---	---
15: 0:00	16: 0:00	---	---

10.

[HOLIDAY SET]		JOG ↑ ↓	
START	END	MODE	PRG
0:00	23:00	N1/5	ON
1: 1-15	2: 9-15	---	---
3: 2-12	4: 9-23	---	---
5: 0:00	6: 0:00	---	---
7: 0:00	8: 0:00	---	---
9: 0:00	10: 0:00	---	---
11: 0:00	12: 0:00	---	---
13: 0:00	14: 0:00	---	---
15: 0:00	16: 0:00	---	---

- Turn the power ON.**
Check the connections and set the [POWER] switch on the rear panel to ON.
- Set [AUDIO REC] to ON/OFF with the <AUDIO REC> menu switch under <DVR MODE>.**
- Display the [HOLIDAY SET] screen.**
Display the [HOLIDAY SET] screen. For details, refer to "Setting" on page 18.
- Set the desired day.**
The cursor blinks at the setting point. Set the day with [JOG - +] and [JOG ← →].
- Set the start time (hours).**
Move the blinking cursor to the "hour" for START with [JOG ↑ ↓]. Set the required time with [JOG - +].
- Set the start time (minutes).**
Move the blinking cursor to the "minute" for START with [JOG ← →]. Set the required time with [JOG - +].
- Set the stop time hours and minutes.**
Set the hours and minutes for END as described in steps 4 and 5.
- Set the picture quality.**
Move the blinking cursor to [MODE] with [JOG ← →]. Select the picture quality with [JOG - +].
H: High-quality recording
N: Normal-quality recording
B: Medium-quality recording
L: Low-quality recording
- Set the frame mode (REC SPEED).**
Move the blinking cursor with [JOG ← →] and select <REC SPEED> with [JOG - +]. [PRG] is automatically set to "ON".
- End HOLIDAY SET.**
When all settings are complete, press the [MENU] button twice. The normal screen is restored.
- Engage the Holiday Recording Standby mode.**
Press the [TIMER] button to engage the Holiday Recording Standby mode.
The [TIMER] indication (⌚) lights on the display panel.
* To cancel or change the setting, refer to page 26.

Memo:

- Holiday recordings take priority over normal timer recordings. (Only [TIMER] indicator lights on the display panel.)
- Maximum recording for HOLIDAY SET is 24 hours.

6 RECORDING (contd.)

6-4 Alarm recording

When an alarm signal is received (via the rear panel [ALARM IN] terminal) during recording, the alarm recording mode set with the menu switch is automatically engaged.

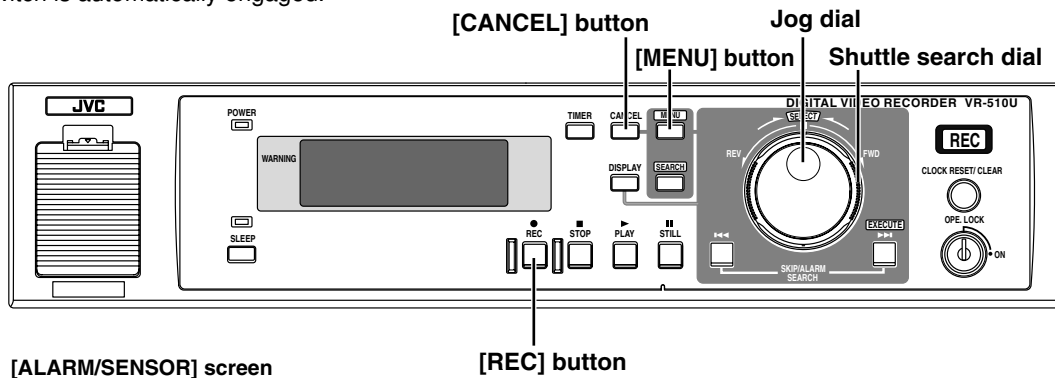

3. [ALARM/SENSOR] screen

[EXT MODE]	JOG ↑ ↓
1. REC MODE	OFF
2. HDD FULL OUT	OFF
[ALARM/SENSOR MODE]	
1. REC MODE	ALARM
2. REC DURATION	180 SEC
3. PRESENSOR REC	OFF
4. PRESENSOR	10 SEC
- REC DURATION	10 SEC

Set to "ALARM".

- 1. Connect an alarm sensor.**
Connect the alarm sensor to the rear panel [ALARM IN] terminal.
- 2. Turn the power ON.**
Check the connections and set the [POWER] switch on the rear panel to ON.
- 3. Set the menu switches.**
Set the required menu switches. For details, refer to "Setting" on page 18.

- [ALARM/SENSOR MODE]
 - [REC MODE] : Set to "ALARM".
 - [REC DURATION] : Select how long you want alarm recording to continue after an alarm signal is input.
- [BUZZER]
 - [ALARM/SENSOR] : Set to "ON" to sound the buzzer during alarm recording.

Reference: "5-3 Menu switch details" on page 21.

- 4. Start recording.**
Refer to "Basic operation" on page 22.
When an alarm signal is received, alarm recording starts (see step 3 above).

* To stop the buzzer during alarm recording, press the [CANCEL] button.

- Memo:**
- Recording continues for about 5 seconds after the set duration has passed.
 - Alarm recording speed <REC SPEED> is fixed at "30". <AUDIO REC> is fixed to "ON".
 - <REC QUALITY> setting for alarm recording is the same as the normal recording setting (used before an alarm is detected).

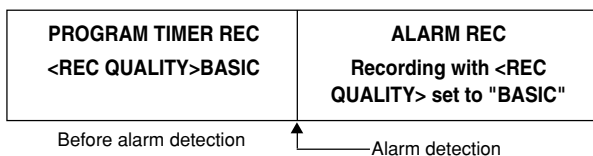

Repeat recording during alarm recording

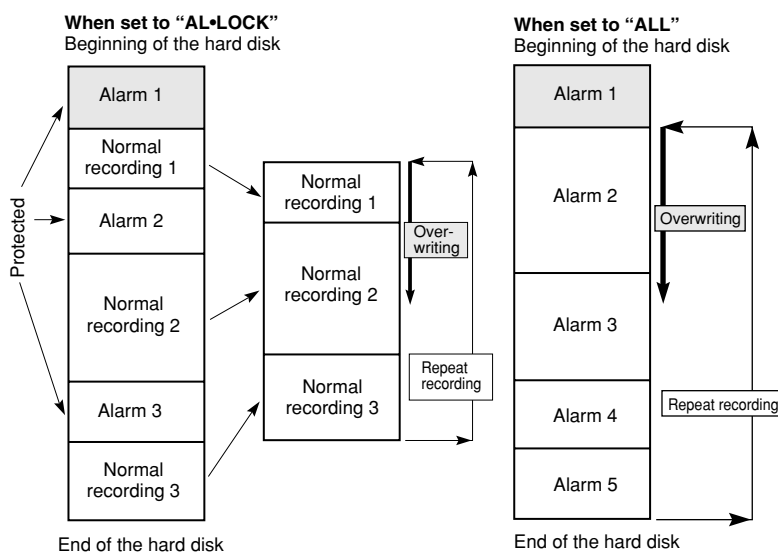

- Repeat recording is canceled if even one alarm recording is performed when menu switch <REPEAT REC> is set to "AL-STOP".
- When menu switch <REPEAT REC> is set to "AL-LOCK", alarm recorded sections are protected when repeat recording is executed.
- When menu switch <REPEAT REC> is set to "ALL", all alarm recordings are overwritten except Alarm 1.
- To erase Alarm 1, erase all alarms with the [CLEAR] button.
- If the <REC DURATION> switch in <ALARM/SENSOR MODE> is set to "MANUAL" and alarm recording continues, recording will stop when the disk is full even if menu switch <REPEAT REC> is set to "ALL".

6 RECORDING (contd.)

6-5 Sensor recording

When an alarm signal is input to the rear panel [ALARM IN] terminal in the Stop mode, sensor recording starts in the mode set with the menu switch.

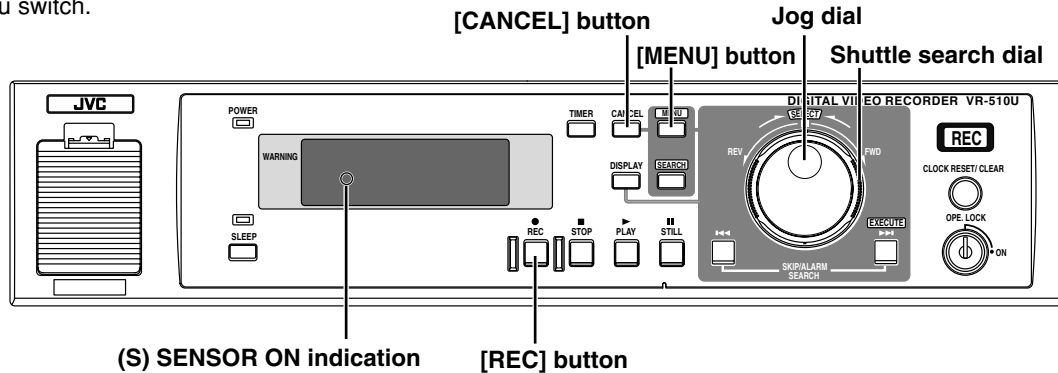

3. [ALARM/SENSOR MODE] screen

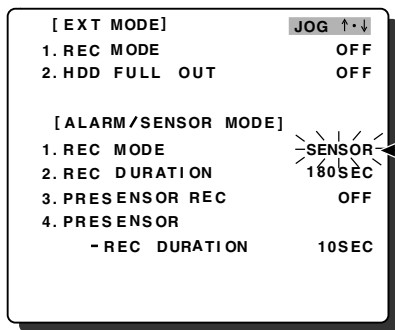

Set to "SENSOR".

Caution:

- Do not use the Sleep mode in the Sensor Recording Standby mode. If the Sleep mode is engaged, there will be a delay between the time an alarm signal is received and sensor recording starts. No images will be recorded during this period.

Memo:

- Sensor recording speed <REC SPEED> is fixed at "30". <AUDIO REC> is fixed to "ON".
- <REC QUALITY> for sensor recording is set with <DVR MODE>.

1. Connect an alarm sensor.

Connect the alarm sensor to the rear panel [ALARM IN] terminal.

2. Turn the power ON.

Check the connections and set the [POWER] switch on the rear panel to ON.

3. Set the menu switches.

Set the required menu switches. For details, refer to "Setting" on page 18.

■ [ALARM/SENSOR MODE]

- [REC MODE] : Set to "SENSOR". (S) lights on the display panel for the [SENSOR] indication.
- [REC DURATION] : Select how long you want sensor recording to continue after an alarm signal is received.
- [PRESENSOR REC] : Set to "ON" to execute pre-sensor recording.
- [PRESENSOR REC DURATION] : Set the time for pre-sensor recording.

■ [BUZZER]

- [ALARM/SENSOR] : Set to "ON" to sound the buzzer during sensor recording.

Reference: "5-3 Menu switch details" on page 21.

4. Engage the Sensor Recording Standby mode.

Engage the Stop mode. When an alarm signal is received, sensor recording starts (see step 3 above).

* To stop the buzzer during sensor recording, press the [CANCEL] button.

Pre-sensor recording

- In the Pre-sensor Recording mode, recording starts from the point before an alarm signal is input during sensor recording.

<Example>

- When <SENSOR REC> and <PRESENSOR REC> are set to "ON" and <PRESENSOR REC DURATION> is set to "30" sec.

Memo:

- Even though <PRESENSOR REC> is set to "OFF", pre-sensor recording may be performed for about 1 second.

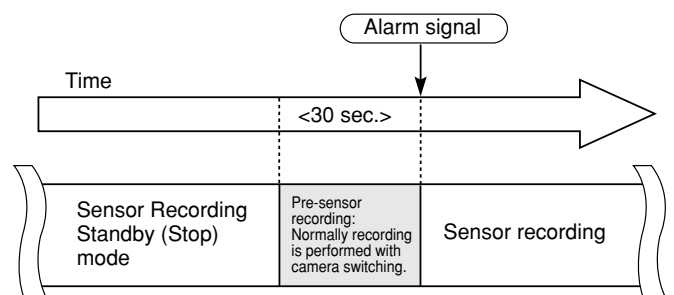

6 RECORDING (contd.)

6-6 Recording with an external activation signal

Recording can be started and stopped externally when an activation signal is input to the rear panel [EXT REC IN] terminal.

1.

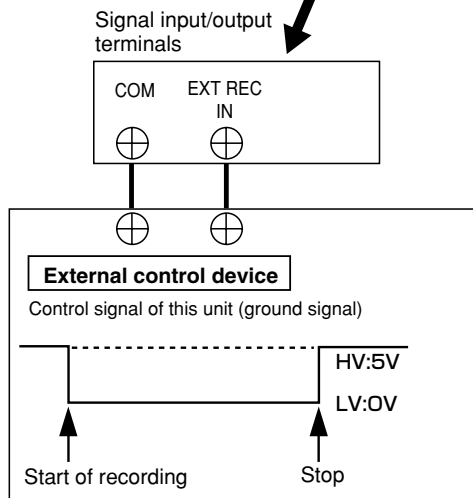
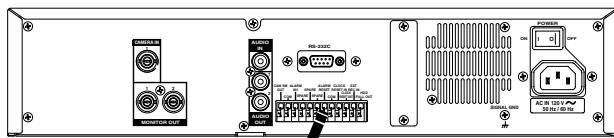

[EXT MODE] screen

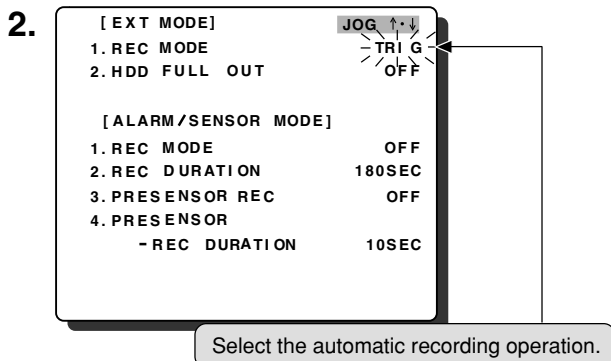

Connection

1. **Connect an external control device.**
Connect the external control device to the rear panel [EXT REC IN] and [COM] terminals.

Operation

2. **Turn the power ON.**
Check the connections and set the [POWER] switch on the rear panel to ON.
 3. **Set the menu switches.**
Set the required menu switches. For details, refer to "Setting" on page 18.
 - [DVR MODE]
 - [REC QUALITY] : Set the recording picture quality.
 - [REC SPEED] : Set the recording speed.
 - [AUDIO REC] : Sets whether or not audio signals are recorded when menu switch <REC SPEED> is set to a position other than 1/5 or 1/10.
 - [EXT MODE]
 - [REC MODE] : Set the recording mode to use when an activation signal is input.
 - When "TRIG" is selected, recording starts when a signal is input.
To stop recording, press the [STOP] button.
 - When "MANUAL" is selected, recording is performed as long as a signal is input.
- Reference:** "5-3 Menu switch details" on page 19.
4. **Engage the Stop mode.**
When an activation signal is input to the [EXT REC IN] terminal, recording starts automatically.

Memo:

- This function is disabled in the Timer Recording Standby mode.

6-7 Automatic restart of recording after power failure

If a power failure occurs, recording re-starts automatically as soon as the power supply is restored.

To activate this function, set menu switch <POWER ON REC> to "ON". When power is restored after a power outage, recording starts again in the same mode in use when power was lost.

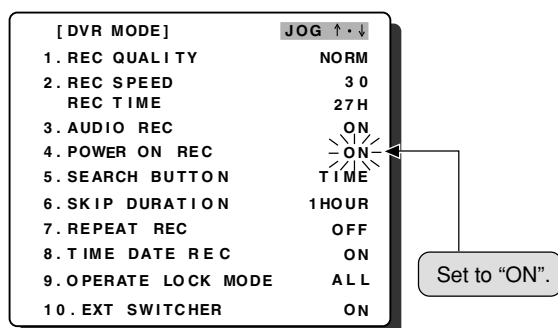

Caution:

- Because this device automatically performs a system check when power is restored after a power failure, there will be a delay before recording re-starts.

7 PLAYBACK AND SPECIAL-EFFECTS PLAYBACK

7-1 Basic operation

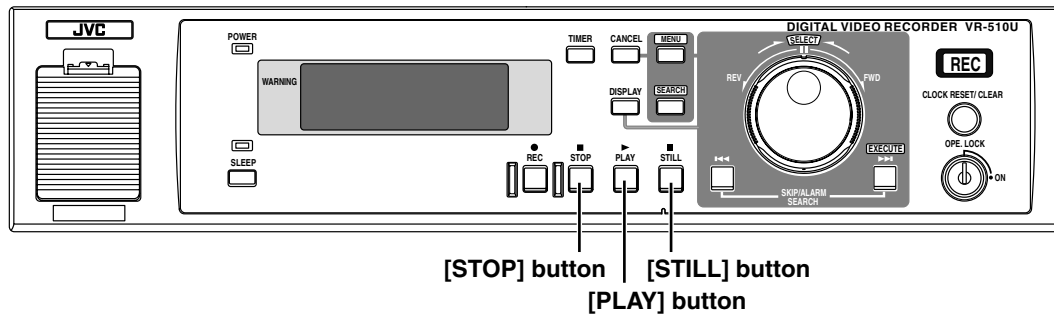

Operation

- 1. Turn the power ON.**
Check the connections and set the [POWER] switch on the rear panel to ON.
- 2. Start playback.**
Press the [PLAY] button. The [PLAY] indicator on the display panel lights and playback starts.
- 3. Stop the playback temporarily.**
Press the [STILL] button. The [STILL] indicator on the display panel lights and the Still mode is engaged.
- 4. Re-start playback.**
Press the [PLAY] button to start playback again.
- 5. Stop playback.**
Press the [STOP] button to stop playback.

Memo:

- When the <REC MODE> switch in <ALARM/SENSOR MODE> is set to "SENSOR" ("SN-***" is shown on screen), the following phenomena may occur.
 - The playback picture appears to stop for a moment or sound is interrupted.
- If no signal is input from the selected camera during recording, the picture may freeze or a black screen may be displayed.

Playback

- Press the [PLAY] button to start playback from the point where playback was last stopped.

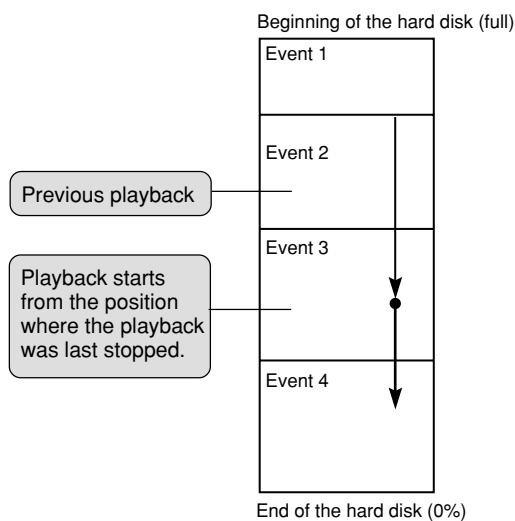

Memo:

- The screen may go black or sound may be interrupted during transitions between events.

Simultaneous Playback mode

- Lets you check a recording while recording is taking place.
- Jog/shuttle playback and skip search are available in addition to normal playback.
- When the [PLAY] button is pressed, playback starts from the point where playback was last stopped.

Memo:

- When an alarm signal is received, the playback picture may appear to stop or sound may be interrupted. However, this does not affect the recording.

7 PLAYBACK AND SPECIAL-EFFECTS PLAYBACK (contd.)

7-2 Jog/shuttle playback

Jog playback allows you to view a recording one frame at a time while shuttle playback lets you vary playback speed. These functions are useful when you want to find a specific scene or examine recorded images in more detail. The shuttle dial is the outer ring and the jog dial is the inner dial.

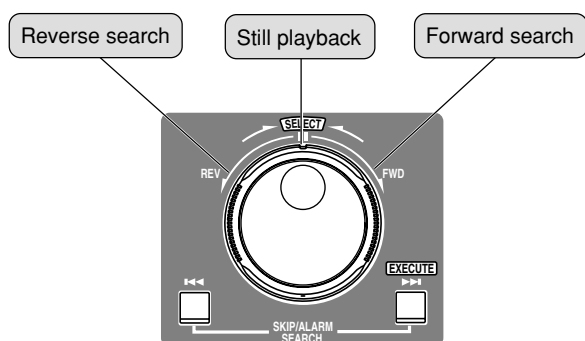
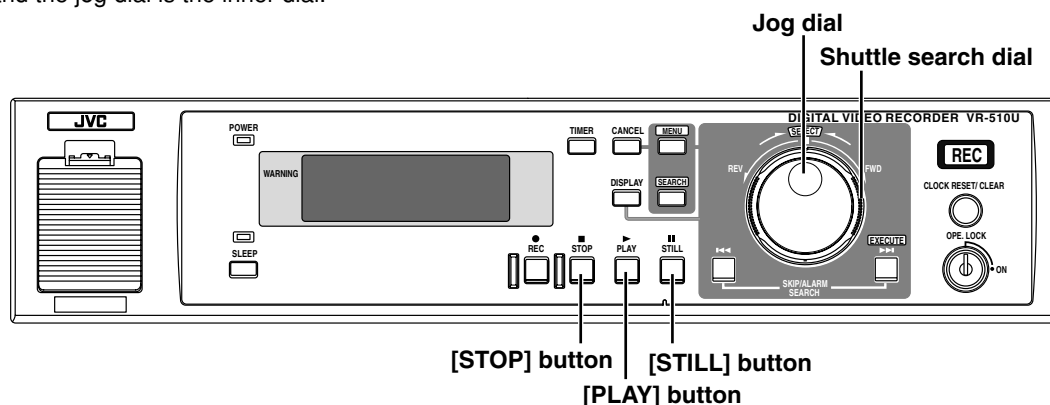

Shuttle playback operation

- 1. Start playback.**
Press the [PLAY] button to start playback.
- 2. Turn the shuttle dial.**
To advance the recorded picture, turn the shuttle dial clockwise (in the [FWD] direction). Search speed increases when you turn the dial further.
To reverse the picture, turn the shuttle dial counterclockwise (in the [REV] direction).
- 3. Stop shuttle playback.**
Press the [STOP], [STILL] or [PLAY] button to stop shuttle playback. The operation starts according to the button pressed.

<Shuttle dial position and search speed>

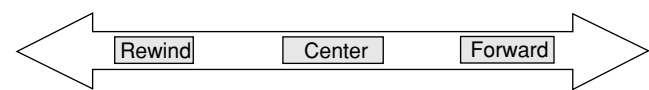

x-60 ← x-15 ← x-5 ← x-3 ← x-1 ← x-1/6 → Still picture → x 1/6 → x 1 → x 3 → x 5 → x 15 → x 60

Jog playback operation

- 1. Start playback.**
Press the [PLAY] button to start playback.
- 2. Turn the jog dial.**
To advance the recorded picture, turn the jog dial clockwise (in the [FWD] direction). To reverse the picture, turn the dial counterclockwise (in the [REV] direction). While the jog dial is turned, frame-by-frame playback is performed. When the dial is released, a still picture playback is displayed.
- 3. Stop jog playback.**
Press the [STOP] or [PLAY] button to stop jog playback. The Stop or Play mode will be engaged.

7 PLAYBACK AND SPECIAL-EFFECTS PLAYBACK (contd.)

7-3 Skip search

When the search distance is specified in the menu, the skip search is possible. This function lets you skip quickly through a series of events and check each one briefly for alarm points.

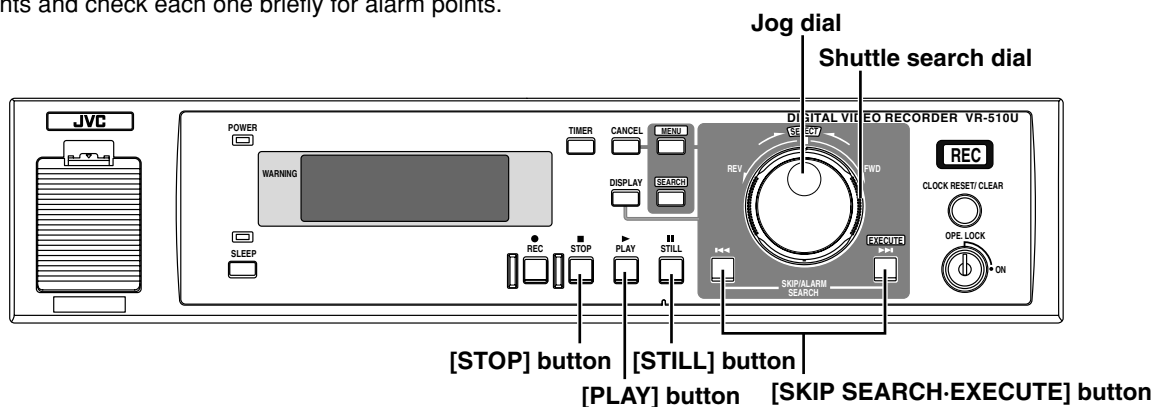

Time search

2.

[DVR MODE]	JOG ↑ ↓
1. REC QUALITY	NORM
2. REC SPEED	30
REC TIME	27H
3. AUDIO REC	ON
4. POWER ON REC	ON
5. SEARCH BUTTON	TIME
6. SKIP DURATION	1HOUR
7. REPEAT REC	OFF
8. TIME DATE REC	ON
9. OPERATE LOCK MODE	ALL
10. EXT SWITCHER	ON

Set to "TIME".

1. Turn the power ON.

Check the connections and set the [POWER] switch on the rear panel to ON.

2. Set the menu switches.

Display the [DVR MODE] screen and set the menu switches. For details, refer to "Setting" on page 18.

- [SEARCH BUTTON]: Set to "TIME".
- [SKIP DURATION]: Set the skip distance (time).

3. Start playback.

Press the [PLAY] button to start playback.

4. Execute time search.

Press the [SKIP SEARCH-EXECUTE] button to perform time search. The Still mode is engaged. To check the event, press the [PLAY] button.

About the time search

<Example>

- Menu switch <SKIP DURATION> is set to "1H".

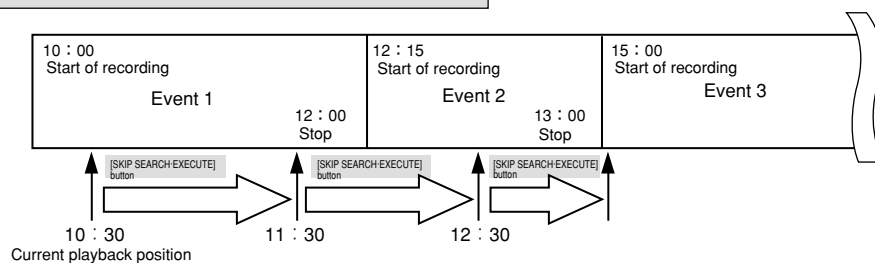

- If the current position is 10:30 and the [SKIP SEARCH-EXECUTE] button is pressed, the position jumps to 11:30.
- If the [SKIP SEARCH-EXECUTE] button is pressed again, the position jumps to 12:30 for event 2.
- If the [SKIP SEARCH-EXECUTE] button is pressed once more, the position jumps to the start of event 3 (15:00).
- If the [SKIP SEARCH-EXECUTE] button is pressed and held, it jumps to the end of recording.

Note:

- If date and time are not set, time search cannot be executed. Set the date and time beforehand.

Reference: "4-3 Setting the date and time" on page 13.

7 PLAYBACK AND SPECIAL-EFFECTS PLAYBACK (contd.)

7-3 Skip search (contd.)

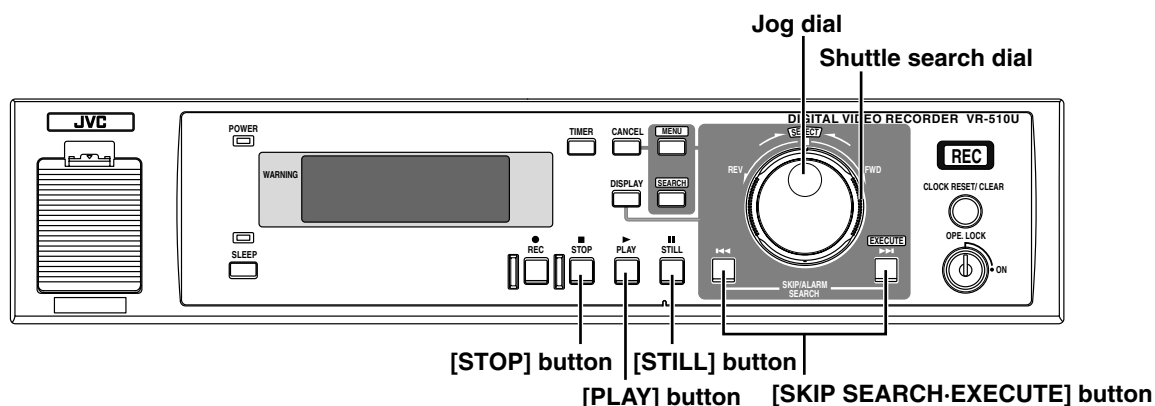

Event search

- 1. Turn the power ON.**
Check the connections and set the [POWER] switch on the rear panel to ON.
- 2. Set the menu switch.**
Display the [DVR MODE] screen and set menu switch <SEARCH BUTTON> to "EVENT". For details, refer to "Setting" on page 18.
- 3. Start playback.**
Press the [PLAY] button to start playback.
- 4. Execute event search.**
Press the [SKIP SEARCH·EXECUTE] button to perform event search. The Still mode is engaged at the start of the next event.
To check the event, press the [PLAY] button.

Alarm search

- 1. Turn the power ON.**
Check the connections and set the [POWER] switch on the rear panel to ON.
- 2. Set the menu switch.**
Display the [DVR MODE] screen and set menu switch <SEARCH BUTTON> to "ALARM". For details, refer to "Setting" on page 18.
- 3. Start playback.**
Press the [PLAY] button to start playback.
- 4. Execute the alarm search.**
Press the [SKIP SEARCH·EXECUTE] button to perform alarm search. The Still mode is engaged at the start of the next alarm recording.
To check the event, press the [PLAY] button.

About event/alarm search

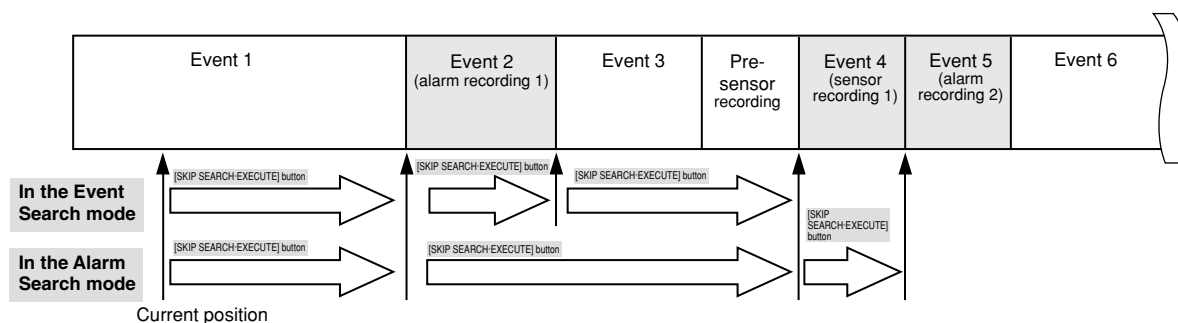

- Each time the [SKIP SEARCH·EXECUTE] button is pressed in the Event Search mode, the head jumps to the start position of the next recording regardless of whether it is a normal recording or alarm/sensor recording.
- Each time the [SKIP SEARCH·EXECUTE] button is pressed in the Alarm Search mode, the head jumps to the start position of the alarm/sensor recording.
- If the [SKIP SEARCH·EXECUTE] button is pressed continuously, the head stops at the end of the recording.
- In the Event Search or Alarm Search mode, the head cannot jump to the beginning of the pre-sensor recording.

7-4 Alarm or day/time direct search

You can access a recording by specifying the alarm number or date/time.

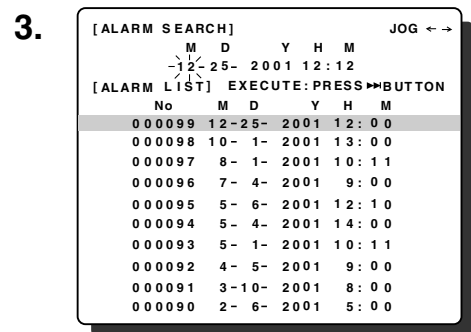
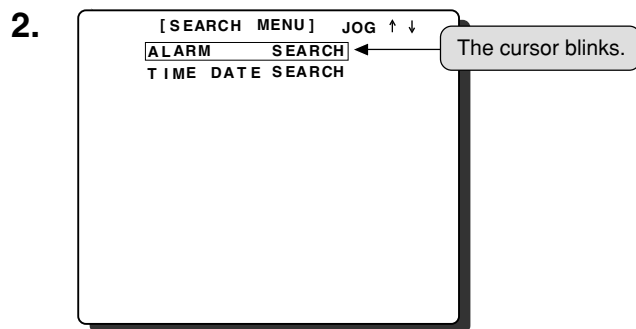

Caution:

- Be sure to clear the alarm list in the Stop mode. If you try to clear the list in any other mode, "ALARM LIST CLEAR**%" is not shown and you will be unable to check progress of the deletion procedure.
- While the alarm list is being cleared, all buttons are disabled. Clearing the alarm list can take up to 30 minutes or more. For example, if the alarm list includes 10,000 events, it takes about 5 minutes to clear the list.

Memo:

- In the Alarm/Sensor mode, jog/shuttle dial response may be slow.

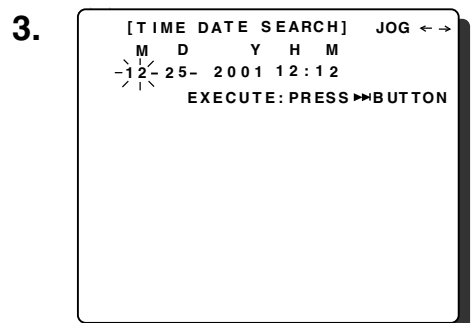
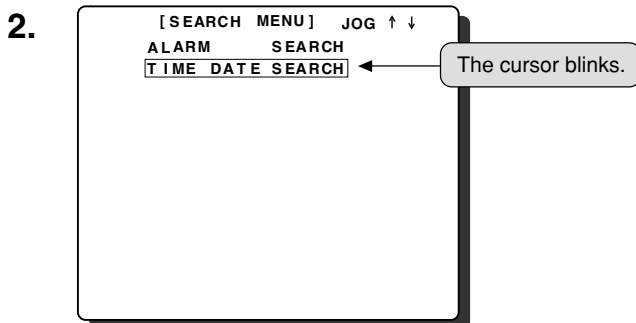

Alarm direct search

1. **Turn the power ON.**
Check the connections and set the [POWER] switch on the rear panel to ON.
2. **Display the [SEARCH MENU] button.**
Press the [SEARCH] button to display the [SEARCH MENU] screen on the monitor.
Switch the jog dial function with the shuttle dial as described in "Jog/shuttle dial operation" on page 16.
3. **Display the [ALARM SEARCH] screen.**
Set the cursor to [ALARM SEARCH] with [JOG ↑↓]. Turn the shuttle dial to display the [ALARM SEARCH] screen.
4. **Search by "month", "day", "year", "hour" and "minute".**
Operate the shuttle dial so that the month area for the search date blinks. Set "month", "day", "year", "hour" and "minute" with [JOG ←→] and [JOG - +].
5. **To search by Alarm No.**
Select the alarm No. to be searched with [JOG ↑↓].
6. **Start the search.**
Press the [SKIP SEARCH·EXECUTE] button to start the search.
When the search ends, the Still mode is engaged. To check the alarm recording section, press the [PLAY] button.

■ Clearing the alarm list

In the Stop mode, open the <ALARM SEARCH> screen and press the [CLEAR] button to clear the alarm list. "ALARM LIST CLEAR**%" is shown on the monitor.

* If recording is executed or <REC MODE> in <ALARM/SENSOR MODE> is set to "SENSOR", the list cannot be cleared. To clear the list, first set <REC MODE> to "ALARM", then call the [ALARM SENSOR] screen and press the [CLEAR] button.

Day/time direct search

1. **Turn the power ON.**
Check the connections and set the [POWER] switch on the rear panel to ON.
2. **Display the [SEARCH MENU] button.**
Press the [SEARCH] button to display the [SEARCH MENU] screen on the monitor.
Switch the jog dial function with the shuttle dial as described in "Jog/shuttle dial operation" on page 16.
3. **Display the [TIME/DATE SEARCH] screen.**
Set the cursor to [TIME/DATE SEARCH] with [JOG ↑↓]. Turn the shuttle dial to display the [TIME/DATE SEARCH] screen.
4. **Search by "month", "day", "year", "hour" and "minute".**
Set "M", "D", "Y", "H" and "M" with [JOG ←→] and [JOG - +].
5. **Start the search.**
Press the [SKIP SEARCH·EXECUTE] button to start the search.
When the search ends, the Still mode is engaged. To check the alarm recording section, press the [PLAY] button.
* If no recording matching the specified date can be found, the head jumps to the position closest to the specified date and time.

8 HARD DISK CONTROL

8-1 Hard disk maintenance

When power is interrupted (disconnection, power failure, etc.) in the Record mode or Sensor Record Standby mode, the recording information on the hard disk may be damaged. This may cause problems in recording and playback. To repair the hard disk, two disk scan functions (<AUTO SCANDISK> and <MANUAL SCAN DISK>) are available.

• <AUTO SCANDISK>

If <AUTO SCANDISK> is set to "ON", the disk is scanned automatically whenever the power is turned on or restored. To cancel disk scanning, press the [CLOCK RESET/CLEAR] button.

• <MANUAL SCAN DISK>

Execute <MANUAL SCAN DISK> from the menu. This cannot be canceled once it has been started. Do not turn the power OFF while this operation is in progress. When <AUTO SCANDISK> is set to "OFF" and the power is kept turned on for long-time recording, be sure to execute <MANUAL SCAN DISK> regularly.

It is recommended to perform <MANUAL SCAN DISK> once a month if recording is executed continuously.

Scanning the disk

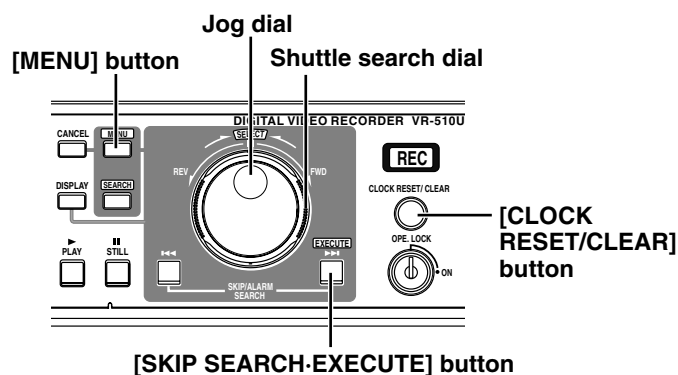

■ Scan the disk when the power is ON.

1. **Display the [UTILITY] screen.**
Display the [UTILITY] screen in the main menu [SYSTEM/LIST]. For details, refer to "Setting" on page 18.
2. **Set the menu switches.**
Set the cursor to [AUTO SCAN DISK] with [JOG ↑↓] and set to "ON" with [JOG - +].
When the setting is complete, press the [MENU] button twice to restore the normal screen.
When the power is turned ON, the disk is scanned and the "SYSTEM LOADING **%" message is displayed. Scanning progress is indicated in percentage. When disk scanning is complete, the % indication goes out. "LoAd --" blinks on the display panel.

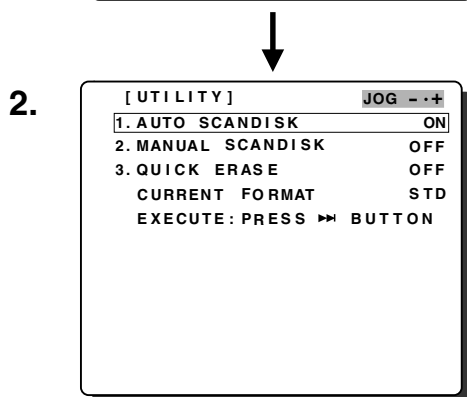
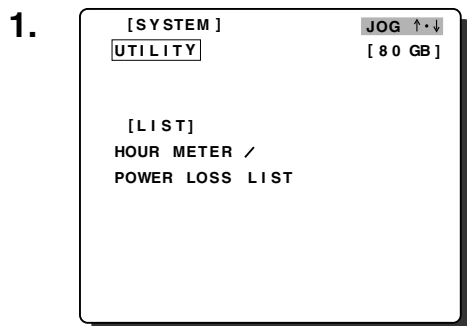
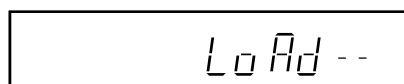

■ Scan the disk manually.

1. **Display the [UTILITY] screen.**
Display the [UTILITY] screen in the main menu [SYSTEM/LIST]. For details, refer to "Setting" on page 18.
2. **Set the menu switches.**
Set the cursor to [MANUAL SCAN DISK] with [JOG ↑↓] and set to "ON" with [JOG - +].
"EXECUTE: PRESS ►► BUTTON" is displayed on the monitor.
Reference: "5-3 Menu switch details" on page 21.
3. **Scan the disk.**
Press the [SKIP SEARCH-EXECUTE] button to start scanning the disk.
"SCAN DISK **%" is shown on the monitor.

Caution:

- Disk scanning can take up to 3 hours if the hard disk contains a lot of data.

Memo:

- Even if <AUTO SCANDISK> is set to "OFF", "SYSTEM LOADING**%" may be displayed when the power is turned ON.

8-1 Hard disk maintenance (contd.)

When the hard disk is full, re-format it in the standard or extended mode.

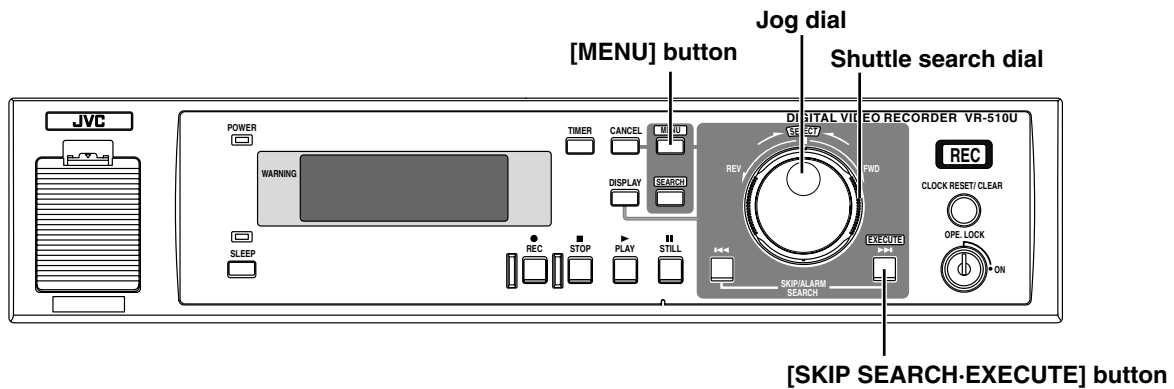

Erasing & formatting

1.

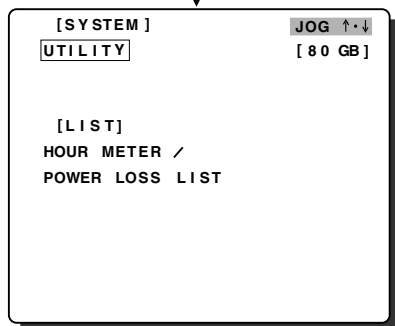
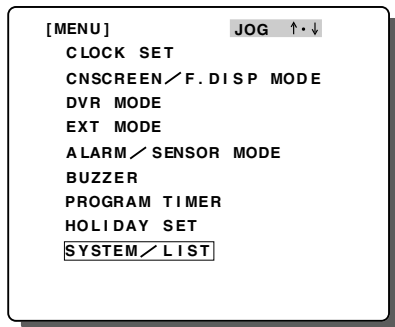

2.

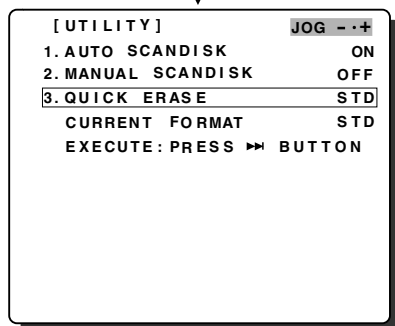

Erasing & formatting

- Display the [UTILITY] screen.**
 Display the [UTILITY] screen in the main menu [SYSTEM/LIST]. For details, refer to "Setting" on page 18.
- Set the menu switches.**
 Set the cursor to [QUICK FORMAT] with [JOG ↑] and set to "STANDARD" or "EXTENSION" with [JOG - +]. "EXECUTE: PRESS ►► BUTTON" is displayed on the monitor.
 STD : Normally, use this position. Up to 13,000 alarm/sensor events can be recorded.
 EXTEN : Set to this position if you want to be able to record more than 13,000 alarm/sensor events.
 * Extended formatting takes about 5 minutes to complete. Recording time is shorter than with the standard format.
Reference: "5-3 Menu switch details" on page 21.

Caution:

- Start-up time will be longer when the extended format is used and a large number of events have been recorded. (Start-up takes about 2 minutes with 20,000 events and about 25 minutes with 100,000 events max.)

3. Erase & format the disk.

Press the [SKIP SEARCH·EXECUTE] button to start formatting the disk.
 "FORMAT **%" is shown on the monitor.

Memo:

- When the disk is formatted, all existing data on the hard disk will be erased.

9 TROUBLESHOOTING

9-1 Error indication

Error indications are displayed on-screen whenever there is an abnormality with signal reception, the hard disk, or the menu settings (such as timer recording setting errors).

On-screen indication/ [WARNING] indication	Cause	Possible solution	Page reference
“HDD ERROR” The [WARNING] indication lights.	The hard disk is not functioning properly.	Consult your nearest JVC dealer.	—
“HDD FULL” The [WARNING] indication lights.	There is no space on the hard disk for recording. Even if the required recording time is short, the number of allowable recordable events may have been exceeded (13,000 for standard format or about 100,000 for extended format).	Format the disk to clear all data and optimize available disk space. Or, set <REPEAT REC> to “AL•STOP”, “AL•LOCK” or “ALL”. * When the disk is formatted, the recorded data is erased.	37
“LOW BATTERY” The [WARNING] indication lights.	The backup battery is not installed or need to be replaced.	Replace the battery with a new one.	12
“FAN MOTOR ERROR” The [WARNING] indication lights.	The fan motor is not functioning properly.	Consult your nearest JVC dealer.	—
“INPUT SIG ERROR” The [WARNING] indication lights.	No video signal is input.	● Engage the Stop mode and check the connections. * When “Camera abnormal” is displayed and recording continues, recording may not be performed normally. First, remove the cause of the abnormality.	9
“PLEASE SET TIMER PROGRAM”	No events are programmed for timer recording.	Check the timer program.	23

9-2 No error indication

Problem	Cause	Possible solution	Page reference
No power is supplied.	<ul style="list-style-type: none"> The power cord may be disconnected. 	<ul style="list-style-type: none"> Connect the provided power cord to a 120 V AC outlet. 	9
Operation buttons such as [REC] and [PLAY] do not respond when pressed.	<ul style="list-style-type: none"> The Operation Lock mode may be engaged. 	<ul style="list-style-type: none"> Release the Operation Lock mode. 	20
No picture is shown during playback.	<ul style="list-style-type: none"> The monitor may not be properly connected. The selected camera may not be transmitting a signal. 	<ul style="list-style-type: none"> Connect the monitor correctly. Select the camera for recording. 	9
Timer recording is not possible.	<ul style="list-style-type: none"> The clock may not be set. The Timer Standby Mode may have been turned off. Is the [TIMER] indication lit? The timer program may not be set correctly. 	<ul style="list-style-type: none"> Check the clock setting. Press the [TIMER] button to engage the Timer Recording Standby mode. Check the timer program settings. The [TIMER] indication blinks if a program cannot be executed. 	13
The menu screen can't be displayed.	<ul style="list-style-type: none"> The Timer Standby Mode may be engaged. Is the [TIMER] indication lit? The Record, Play or Simultaneous Play mode may be engaged. 	<ul style="list-style-type: none"> Press the [TIMER] button to release the timer program. Stop the operation, then press the [MENU] button. 	26
The date/time is not shown on screen.	<ul style="list-style-type: none"> <ON SCREEN MODE> may be set to "OFF". 	<ul style="list-style-type: none"> Set <ON SCREEN MODE> to "ON". 	19
The date/time is not recorded.	<ul style="list-style-type: none"> The clock may not be set. Menu switch <TIME DATE REC> may be set to "OFF". 	<ul style="list-style-type: none"> Set the clock. Set menu switch <TIME DATE REC> to "ON". 	13
The timer indication blinks.	<ul style="list-style-type: none"> The timer is not programmed or a set program cannot be executed. There may not be enough space available on the hard disk. 	<ul style="list-style-type: none"> Re-set the program timer. Re-format the hard disk to clear existing data. 	23 – 25, 37
Recording/playback is not possible.	<ul style="list-style-type: none"> Cameras may not be connected in sync. 	<ul style="list-style-type: none"> Input the signals in sync. 	10
No sound in playback.	<ul style="list-style-type: none"> <AUDIO REC> may not be "ON". 	<ul style="list-style-type: none"> Set <AUDIO REC> to "ON". If <REC SPEED> is set to "1/5" or "1/10", audio signals cannot be recorded. 	19
Skip search or direct search is not possible.	<ul style="list-style-type: none"> The clock may not be set correctly. 	<ul style="list-style-type: none"> Set the clock. 	13

10 RS-232C INTERFACE

10-1 Specifications

9-pin connector specifications

Pin No.	Signal	Operation	Signal direction
3	TXD	Transmission data	DVR → CPU
2	RXD	Reception data	DVR ← CPU
6	DSR	Data set ready	DVR ← CPU
5	GND	Signal ground	
4	DTR	Data terminal ready	DVR → CPU

Output level

OFF : -5 V or less
ON : +5 V or more

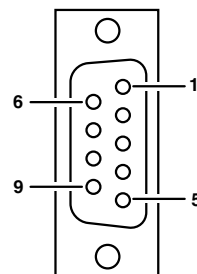

Data format

- Mode : Non-synchronous
- Character length : 8 bits
- Data rate : 9600 bps
- Parity check : None
- Stop bit : 1

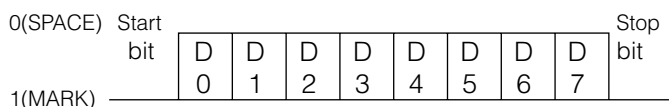

10-2 Protocols and commands

This section provides programming information needed to control the VR-510U via RS-232C.

Basic table

→ Upper ↓ Lower	0	1	2	3	4	5	6	7	8	9	A	B	C	D	E	F
0				Data 0	ENTER							ALARM FWD				
1	COMPLETE			Data 1	CLEAR ERROR							ALARM REV				
2	ERROR			Data 2												
3				Data 3												
4				Data 4												
5	NOT TARGET			Data 5								FWD SHUTTLE				
6	ALARM IN			Data 6		CLEAR						REV SHUTTLE				JVC-1 TABLE ON
7				Data 7			STATUS SENSE							STATUS SENSE		BASIC TABLE ON
8				Data 8												
9				Data 9												
A	ACK			PLAY	REV PLAY								REC			REC REQUEST
B	NAK			FWD x3	REV x3						FF					VTR INQ
C				FWD x1/6	REV x1/6						REW					
D				FWD STILL	REV STILL						FWD STEP					
E				FWD x15	REV x15				DATE SET		REV STEP	DATE SENSE				
F				STOP	STILL				TIME SET			TIME SENSE				

10 RS-232C INTERFACE (contd)

10-2 Protocols and commands (contd.)

■ JVC table 1

→ Upper ↓ Lower	0	1	2	3	4	5	6	7	8	9	A	B	C	D	E	F
0				Data 0	ENTER		TIMER ON	ONSCREEN ON		TDSKIP FWD		ALARM FWD	OPE LOCK ON	FORMAT SENSE		
1	COMPLETE ON			Data 1	CLEAR ERROR		TIMER OFF	ONSCREEN OFF		TDSKIP REV		ALARM REV	OPE LOCK OFF	DEVICE TYPE		
2	ERROR			Data 2			PROGRAM	ROM VERSION		TD SEARCH				H.METER SENSE		
3				Data 3			DOWN	POSV+		EVSKIP FWD						
4				Data 4			RIGHT	ONSCREEN SEL		EVSKIP REV				REMAIN SENSE		
5	NOT TARGET			Data 5			SET+	POSH+		PL RESET		FWD SHUTTLE		PL/AL CNT SNS		
6	ALARM IN			Data 6		CLEAR	SET-	CANCEL	PB CAM SET			REV SHUTTLE		VR STS SENSE		JVC-1 TABLE ON
7				Data 7			STATUS SENSE	EXECUTE						STATUS SENSE		BASIC TABLE ON
8				Data 8			DOWN RIGHT +	ALLIST DISP								
9				Data 9			UP LEFT -	HLD SET SP	DVR SETTING			DVR SETTING SNS	DISK UTILITY			
A	ACK			PLAY			SELECT	AL/SNMODE SET				AL/SNMODE SNS	REC			REC REQUEST
B	NAK							DVR REC MODE		FF		DVR REC SENSE				VTR INQ
C								REPEAT REC		REW		REPEAT REC				
D								REC CAM SET		FWD STEP		DVR REC CAM SNS				
E								DATE SET		REV STEP		DATE SENSE				
F				STOP	STILL	PB STOP			TIME SET			TIME SENSE				

10 RS-232C INTERFACE (contd.)

10-3 Commands

■ Preparation

Connect the RS-232C connector.

● Operation commands

The commands to operate this unit are shown below. When the signal is received normally, this unit returns ACK (0Ah) and is ready for the operation corresponding to the command received.

e.g.: Playback

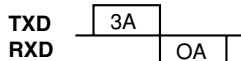

Commands	Description
3AH	PLAY: Playback
3BH	SHUTTLE FWD x 3: 3x playback (Play mode only)
3CH	SHUTTLE FWD x 1/6: 1/6x playback (Play mode only)
3DH	SHUTTLE FWD STILL: Temporal stop (Play mode only)
3EH	SHUTTLE FWD x 15: 15x playback (Play mode only)
3FH	STOP: Stop
40H	ENTER: Enter
41H	CLEAR ERROR: Clears the last numeric command received. Releases the error condition.
4AH	REV PLAY: Reverse playback
4BH	SHUTTLE REV x 3: Reverse 3x playback
4CH	SHUTTLE REV x 1/6: Reverse 1/6x playback
4DH	SHUTTLE STILL: Temporal stop
4EH	SHUTTLE REV x 15: Reverse 15x playback
4FH	STILL: Temporal stop
56H	CLEAR: Releases the current mode and error condition.
5FH	PB STOP: Stops the playback.
60H	TIMER ON: Sets the Timer mode to ON.
61H	TIMER OFF: Sets the Timer mode to OFF.
62H	PRG: Displays the timer program screen. Restores the normal screen when the timer program screen is displayed. (Effective only in the Stop mode)
63H 64H	DOWN, RIGHT: Shifts the item when the timer program/holiday timer is set or the alarm search is set.
65H 66H	SET +/-: Selects the setting after SHIFT operation.
68H 69H	DOWN RIGHT PLS/LEFT UP MNS: Corresponds to JOG operation on the alarm search screen.
70H	ON SCREEN ON: Displays on-screen display.
71H	ON SCREEN OFF: Releases on-screen display.
72H	ROM VER: Returns the ROM version in the section managing RS-232C.
73H	POS V+: Moves the on-screen display vertically.
75H	POS H+: Moves the on-screen display horizontally.
76H	CANCEL: Cancels the setting for program. Clears the alarm list on the [ALARM SEARCH] screen.
77H	EXECUTE: Execute alarm search on the alarm search screen.
78H	ALARM LIST DISPLAY: Enters the alarm search screen from the normal screen. Restores the normal screen from the alarm search screen.
79H	HOLIDAY SET DISPLAY: Displays the holiday set screen. Restores the normal screen from the holiday set screen. (Only effective in the Stop mode)
7AH	SELECT: Switches the JOG operation in the alarm search screen.
90H	TD SKIP FWD: Jumps by the search distance set in the menu X times in the forward direction. For the number of jump times X, specify 2 digits with 30-39H. (Effective only in the Play mode)

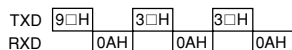

Commands	Description
91H	TD SKIP REV: Jumps by the search distance set in the menu X times in the reverse direction. For the number of jump times X, specify 2 digits with 30-39H. (Effective only in the Play mode)
92H	TD SEARCH: Jumps to the position with the specified date. Specify the "month", "day", "year", "hour" and "minute" for the date with numeric commands (10 digits).

```

TXD  92H  30H  30H  30H  30H  30H  30H  30H
RXD  0AH  0AH  0AH  0AH  0AH  0AH  0AH  0AH
    
```

93H	EVENT SKIP FWD: Jumps by the event (recording start to end) X times in the forward direction. For the number of jump times X, specify 2 digits with 30-39H. (Effective only in the Play mode)
94H	EVENT SKIP REV: Jumps by the event (recording start to end) X times in the reverse direction. For the number of jump times X, specify 2 digits with 30-39H. (Effective only in the Play mode)
ABH	FF: In Repeat Recording mode, jumps to the sector with the last time stamp and enters the Still mode. Otherwise, jumps to the last address sector of the LBA recording area and enters the Still mode. Performs alarm search, time/date search and event search in the forward direction in the Play mode (depending on the menu setting).
ACH	REW: In Repeat Recording mode, jumps to the sector with the oldest time stamp and enters the Still mode. Otherwise, jumps to the last address sector of the LBA recording area and enters the Still mode. Performs alarm search, time/date search and event search in the reverse direction in the Play mode (depending on the menu setting).
ADH	FWD STEP: Advances one frame in the Still mode.
AEH	REV STEP: Reverses one frame in the Still mode.
BOH	ALARM FWD: Advances by a specified number of alarms. Specify the search number as 2 digits with 30-39H. (Effective only in the Play mode)

```

TXD  BOH  30H  30H
RXD  0AH  0AH  0AH
    
```

B1H	ALARM REV: Reverses by a specified number of alarms. Specify the search number as 2 digits with 30-39H. (Effective only in the Play mode)
B5H	SHUTTLE FWD/REW: Specify shuttle search speeds as 1 digit with 3-3AH.

30: STILL	33: x1/6	36: x3	39: x60
31: x1/18	34: x1/2	37: x5	3A: x360
32: x1/18	35: x1	38: x15	

COH	OPE LOCK ON: Locks all operation buttons.
C1H	OPE LOCK ON: Sets the Operation Lock mode to OFF.
C9H	DISK UTILITY: Launches the disk utility by specifying this command after REC/DUB REQUEST (FAH).

```

TXD  FAH  C9H  00H
RXD  0AH  0AH  0AH
    
```

1 byte	Status details
01H	Standard format
02H	
03H	Scan disk
04H	Extension format

CAH	REC: Starts recording by specifying this command after REC/DUB REQUEST (FAH).
-----	---

10 RS-232C INTERFACE (contd.)

10-3 Commands (contd.)

● Setup commands

Sets switches on this unit. When the signal is received normally, this unit returns ACK (0Ah) and is ready to execute the command received.

Commands	Description																								
74H	<p>ON SCREEN SELECT: Switches the on-screen display details.</p> <p>TXD <table border="1"><tr><td>74H</td><td>□□H</td></tr></table> RXD <table border="1"><tr><td>0AH</td><td>0AH</td></tr></table></p> <table border="1"> <thead> <tr> <th colspan="2">1 byte</th> </tr> <tr> <th>Bit</th> <th>Status details</th> </tr> </thead> <tbody> <tr><td>7</td><td>_____</td></tr> <tr><td>6</td><td>AL/SENS DET MARK</td></tr> <tr><td>5</td><td>WARNING</td></tr> <tr><td>4</td><td>REMAIN</td></tr> <tr><td>3</td><td>ALARM</td></tr> <tr><td>2</td><td>_____</td></tr> <tr><td>1</td><td>TIME</td></tr> <tr><td>0</td><td>DATE</td></tr> </tbody> </table>	74H	□□H	0AH	0AH	1 byte		Bit	Status details	7	_____	6	AL/SENS DET MARK	5	WARNING	4	REMAIN	3	ALARM	2	_____	1	TIME	0	DATE
74H	□□H																								
0AH	0AH																								
1 byte																									
Bit	Status details																								
7	_____																								
6	AL/SENS DET MARK																								
5	WARNING																								
4	REMAIN																								
3	ALARM																								
2	_____																								
1	TIME																								
0	DATE																								
86H	<p>DVR PB CAMERA SET: Specifies which camera signal to output to the monitor.</p> <p>TXD <table border="1"><tr><td>86H</td><td>□□H</td></tr></table> RXD <table border="1"><tr><td>0AH</td><td>0AH</td></tr></table></p> <table border="1"> <thead> <tr> <th colspan="2">1 byte</th> </tr> <tr> <th>Bit</th> <th>Status details</th> </tr> </thead> <tbody> <tr><td>7 ~ 3</td><td>_____</td></tr> <tr><td>2 ~ 0</td><td> <table border="1"> <thead> <tr> <th>2-bit</th> <th>1-bit</th> <th>0-bit</th> <th>Playback camera</th> </tr> </thead> <tbody> <tr> <td>1</td> <td>0</td> <td>0</td> <td>Fixed</td> </tr> </tbody> </table> </td></tr> </tbody> </table>	86H	□□H	0AH	0AH	1 byte		Bit	Status details	7 ~ 3	_____	2 ~ 0	<table border="1"> <thead> <tr> <th>2-bit</th> <th>1-bit</th> <th>0-bit</th> <th>Playback camera</th> </tr> </thead> <tbody> <tr> <td>1</td> <td>0</td> <td>0</td> <td>Fixed</td> </tr> </tbody> </table>	2-bit	1-bit	0-bit	Playback camera	1	0	0	Fixed				
86H	□□H																								
0AH	0AH																								
1 byte																									
Bit	Status details																								
7 ~ 3	_____																								
2 ~ 0	<table border="1"> <thead> <tr> <th>2-bit</th> <th>1-bit</th> <th>0-bit</th> <th>Playback camera</th> </tr> </thead> <tbody> <tr> <td>1</td> <td>0</td> <td>0</td> <td>Fixed</td> </tr> </tbody> </table>	2-bit	1-bit	0-bit	Playback camera	1	0	0	Fixed																
2-bit	1-bit	0-bit	Playback camera																						
1	0	0	Fixed																						

Commands	Description																																																																																												
89H	<p>DVR SETTING: Sets the DVR-related status data.</p> <p>TXD <table border="1"><tr><td>89H</td><td>□□H</td><td>□□H</td><td>□□H</td></tr></table> RXD <table border="1"><tr><td>0AH</td><td>0AH</td><td>0AH</td><td>0AH</td></tr></table></p> <table border="1"> <thead> <tr> <th colspan="2">1 byte</th> </tr> <tr> <th>Bit</th> <th>Status details</th> </tr> </thead> <tbody> <tr><td>7</td><td>Time date rec 0: OFF, 1: ON</td></tr> <tr><td>6</td><td>Repeat rec 0: OFF, 1: AL•STOP, AL•LOCK, ALL</td></tr> <tr><td>5 ~ 3</td><td> <table border="1"> <thead> <tr> <th>5-bit</th> <th>4-bit</th> <th>3-bit</th> <th>Skip duration</th> </tr> </thead> <tbody> <tr><td>0</td><td>0</td><td>0</td><td>1 minute</td></tr> <tr><td>0</td><td>0</td><td>1</td><td>5 minutes</td></tr> <tr><td>0</td><td>0</td><td>0</td><td>10 minutes</td></tr> <tr><td>0</td><td>1</td><td>1</td><td>30 minutes</td></tr> <tr><td>1</td><td>0</td><td>1</td><td>1 hour</td></tr> <tr><td>1</td><td>0</td><td>0</td><td>4 hours</td></tr> <tr><td>1</td><td>0</td><td>1</td><td>1 day</td></tr> <tr><td>1</td><td>1</td><td>1</td><td>1 week</td></tr> </tbody> </table> </td></tr> <tr><td>2 ~ 1</td><td>Search button 00: Time, 01: Alarm, 10: Event</td></tr> <tr><td>0</td><td>Power ON rec 0: OFF, 1: ON</td></tr> </tbody> </table> <table border="1"> <thead> <tr> <th colspan="2">2 bytes</th> </tr> <tr> <th>Bit</th> <th>Status details</th> </tr> </thead> <tbody> <tr><td>7</td><td>Operation Lock mode 0: ALL, 1: REC</td></tr> <tr><td>6</td><td>_____</td></tr> <tr><td>5</td><td>HDD full out 0: OFF, 1: ON</td></tr> <tr><td>4 ~ 3</td><td>Ext mode 00: OFF, 1: Trig, 10: Manual</td></tr> <tr><td>2 ~ 1</td><td>Alarm/sensor indication 00: OFF, 01: ON1, 10: ON2</td></tr> <tr><td>0</td><td>Rec tally 0: OFF, 1: ON</td></tr> </tbody> </table> <table border="1"> <thead> <tr> <th colspan="2">3 bytes</th> </tr> <tr> <th>Bit</th> <th>Status details</th> </tr> </thead> <tbody> <tr><td>7</td><td>External switcher</td></tr> <tr><td>6</td><td>0: OFF, 1: ON</td></tr> <tr><td>5 ~ 4</td><td>_____</td></tr> <tr><td>3</td><td>_____</td></tr> <tr><td>2</td><td>Warning buzzer 0: OFF, 1: ON</td></tr> <tr><td>1</td><td>Alarm/sensor buzzer 0: OFF, 1: ON</td></tr> <tr><td>0</td><td>HDD end buzzer 0: OFF, 1: ON</td></tr> </tbody> </table>	89H	□□H	□□H	□□H	0AH	0AH	0AH	0AH	1 byte		Bit	Status details	7	Time date rec 0: OFF, 1: ON	6	Repeat rec 0: OFF, 1: AL•STOP, AL•LOCK, ALL	5 ~ 3	<table border="1"> <thead> <tr> <th>5-bit</th> <th>4-bit</th> <th>3-bit</th> <th>Skip duration</th> </tr> </thead> <tbody> <tr><td>0</td><td>0</td><td>0</td><td>1 minute</td></tr> <tr><td>0</td><td>0</td><td>1</td><td>5 minutes</td></tr> <tr><td>0</td><td>0</td><td>0</td><td>10 minutes</td></tr> <tr><td>0</td><td>1</td><td>1</td><td>30 minutes</td></tr> <tr><td>1</td><td>0</td><td>1</td><td>1 hour</td></tr> <tr><td>1</td><td>0</td><td>0</td><td>4 hours</td></tr> <tr><td>1</td><td>0</td><td>1</td><td>1 day</td></tr> <tr><td>1</td><td>1</td><td>1</td><td>1 week</td></tr> </tbody> </table>	5-bit	4-bit	3-bit	Skip duration	0	0	0	1 minute	0	0	1	5 minutes	0	0	0	10 minutes	0	1	1	30 minutes	1	0	1	1 hour	1	0	0	4 hours	1	0	1	1 day	1	1	1	1 week	2 ~ 1	Search button 00: Time, 01: Alarm, 10: Event	0	Power ON rec 0: OFF, 1: ON	2 bytes		Bit	Status details	7	Operation Lock mode 0: ALL, 1: REC	6	_____	5	HDD full out 0: OFF, 1: ON	4 ~ 3	Ext mode 00: OFF, 1: Trig, 10: Manual	2 ~ 1	Alarm/sensor indication 00: OFF, 01: ON1, 10: ON2	0	Rec tally 0: OFF, 1: ON	3 bytes		Bit	Status details	7	External switcher	6	0: OFF, 1: ON	5 ~ 4	_____	3	_____	2	Warning buzzer 0: OFF, 1: ON	1	Alarm/sensor buzzer 0: OFF, 1: ON	0	HDD end buzzer 0: OFF, 1: ON
89H	□□H	□□H	□□H																																																																																										
0AH	0AH	0AH	0AH																																																																																										
1 byte																																																																																													
Bit	Status details																																																																																												
7	Time date rec 0: OFF, 1: ON																																																																																												
6	Repeat rec 0: OFF, 1: AL•STOP, AL•LOCK, ALL																																																																																												
5 ~ 3	<table border="1"> <thead> <tr> <th>5-bit</th> <th>4-bit</th> <th>3-bit</th> <th>Skip duration</th> </tr> </thead> <tbody> <tr><td>0</td><td>0</td><td>0</td><td>1 minute</td></tr> <tr><td>0</td><td>0</td><td>1</td><td>5 minutes</td></tr> <tr><td>0</td><td>0</td><td>0</td><td>10 minutes</td></tr> <tr><td>0</td><td>1</td><td>1</td><td>30 minutes</td></tr> <tr><td>1</td><td>0</td><td>1</td><td>1 hour</td></tr> <tr><td>1</td><td>0</td><td>0</td><td>4 hours</td></tr> <tr><td>1</td><td>0</td><td>1</td><td>1 day</td></tr> <tr><td>1</td><td>1</td><td>1</td><td>1 week</td></tr> </tbody> </table>	5-bit	4-bit	3-bit	Skip duration	0	0	0	1 minute	0	0	1	5 minutes	0	0	0	10 minutes	0	1	1	30 minutes	1	0	1	1 hour	1	0	0	4 hours	1	0	1	1 day	1	1	1	1 week																																																								
5-bit	4-bit	3-bit	Skip duration																																																																																										
0	0	0	1 minute																																																																																										
0	0	1	5 minutes																																																																																										
0	0	0	10 minutes																																																																																										
0	1	1	30 minutes																																																																																										
1	0	1	1 hour																																																																																										
1	0	0	4 hours																																																																																										
1	0	1	1 day																																																																																										
1	1	1	1 week																																																																																										
2 ~ 1	Search button 00: Time, 01: Alarm, 10: Event																																																																																												
0	Power ON rec 0: OFF, 1: ON																																																																																												
2 bytes																																																																																													
Bit	Status details																																																																																												
7	Operation Lock mode 0: ALL, 1: REC																																																																																												
6	_____																																																																																												
5	HDD full out 0: OFF, 1: ON																																																																																												
4 ~ 3	Ext mode 00: OFF, 1: Trig, 10: Manual																																																																																												
2 ~ 1	Alarm/sensor indication 00: OFF, 01: ON1, 10: ON2																																																																																												
0	Rec tally 0: OFF, 1: ON																																																																																												
3 bytes																																																																																													
Bit	Status details																																																																																												
7	External switcher																																																																																												
6	0: OFF, 1: ON																																																																																												
5 ~ 4	_____																																																																																												
3	_____																																																																																												
2	Warning buzzer 0: OFF, 1: ON																																																																																												
1	Alarm/sensor buzzer 0: OFF, 1: ON																																																																																												
0	HDD end buzzer 0: OFF, 1: ON																																																																																												
8AH	<p>ALARM/SENSOR MODE SET: Sets alarm/sensor recording-related data</p> <p>TXD <table border="1"><tr><td>8AH</td><td>□□H</td><td>□□H</td><td>□□H</td></tr></table> RXD <table border="1"><tr><td>0AH</td><td>0AH</td><td>0AH</td><td>0AH</td></tr></table></p> <table border="1"> <thead> <tr> <th colspan="2">1 byte</th> </tr> <tr> <th>Bit</th> <th>Status details</th> </tr> </thead> <tbody> <tr><td>7</td><td>_____</td></tr> <tr><td>6 ~ 4</td><td> <table border="1"> <thead> <tr> <th>6-bit</th> <th>5-bit</th> <th>4-bit</th> <th>PRESENSOR REC DURATION</th> </tr> </thead> <tbody> <tr><td>0</td><td>0</td><td>0</td><td>10 sec.</td></tr> <tr><td>0</td><td>0</td><td>1</td><td>15 sec.</td></tr> <tr><td>0</td><td>1</td><td>0</td><td>30 sec.</td></tr> <tr><td>0</td><td>1</td><td>1</td><td>60 sec.</td></tr> <tr><td>1</td><td>0</td><td>0</td><td>120 sec.</td></tr> <tr><td>1</td><td>0</td><td>1</td><td>180 sec.</td></tr> <tr><td>1</td><td>1</td><td>0</td><td>Manual</td></tr> </tbody> </table> </td></tr> <tr><td>3 ~ 2</td><td>_____</td></tr> <tr><td>1 ~ 0</td><td> <table border="1"> <thead> <tr> <th>1-bit</th> <th>0-bit</th> <th>REC MODE</th> </tr> </thead> <tbody> <tr><td>0</td><td>0</td><td>OFF</td></tr> <tr><td>0</td><td>1</td><td>ALARM</td></tr> <tr><td>1</td><td>0</td><td>SENSOR</td></tr> </tbody> </table> </td></tr> </tbody> </table>	8AH	□□H	□□H	□□H	0AH	0AH	0AH	0AH	1 byte		Bit	Status details	7	_____	6 ~ 4	<table border="1"> <thead> <tr> <th>6-bit</th> <th>5-bit</th> <th>4-bit</th> <th>PRESENSOR REC DURATION</th> </tr> </thead> <tbody> <tr><td>0</td><td>0</td><td>0</td><td>10 sec.</td></tr> <tr><td>0</td><td>0</td><td>1</td><td>15 sec.</td></tr> <tr><td>0</td><td>1</td><td>0</td><td>30 sec.</td></tr> <tr><td>0</td><td>1</td><td>1</td><td>60 sec.</td></tr> <tr><td>1</td><td>0</td><td>0</td><td>120 sec.</td></tr> <tr><td>1</td><td>0</td><td>1</td><td>180 sec.</td></tr> <tr><td>1</td><td>1</td><td>0</td><td>Manual</td></tr> </tbody> </table>	6-bit	5-bit	4-bit	PRESENSOR REC DURATION	0	0	0	10 sec.	0	0	1	15 sec.	0	1	0	30 sec.	0	1	1	60 sec.	1	0	0	120 sec.	1	0	1	180 sec.	1	1	0	Manual	3 ~ 2	_____	1 ~ 0	<table border="1"> <thead> <tr> <th>1-bit</th> <th>0-bit</th> <th>REC MODE</th> </tr> </thead> <tbody> <tr><td>0</td><td>0</td><td>OFF</td></tr> <tr><td>0</td><td>1</td><td>ALARM</td></tr> <tr><td>1</td><td>0</td><td>SENSOR</td></tr> </tbody> </table>	1-bit	0-bit	REC MODE	0	0	OFF	0	1	ALARM	1	0	SENSOR																												
8AH	□□H	□□H	□□H																																																																																										
0AH	0AH	0AH	0AH																																																																																										
1 byte																																																																																													
Bit	Status details																																																																																												
7	_____																																																																																												
6 ~ 4	<table border="1"> <thead> <tr> <th>6-bit</th> <th>5-bit</th> <th>4-bit</th> <th>PRESENSOR REC DURATION</th> </tr> </thead> <tbody> <tr><td>0</td><td>0</td><td>0</td><td>10 sec.</td></tr> <tr><td>0</td><td>0</td><td>1</td><td>15 sec.</td></tr> <tr><td>0</td><td>1</td><td>0</td><td>30 sec.</td></tr> <tr><td>0</td><td>1</td><td>1</td><td>60 sec.</td></tr> <tr><td>1</td><td>0</td><td>0</td><td>120 sec.</td></tr> <tr><td>1</td><td>0</td><td>1</td><td>180 sec.</td></tr> <tr><td>1</td><td>1</td><td>0</td><td>Manual</td></tr> </tbody> </table>	6-bit	5-bit	4-bit	PRESENSOR REC DURATION	0	0	0	10 sec.	0	0	1	15 sec.	0	1	0	30 sec.	0	1	1	60 sec.	1	0	0	120 sec.	1	0	1	180 sec.	1	1	0	Manual																																																												
6-bit	5-bit	4-bit	PRESENSOR REC DURATION																																																																																										
0	0	0	10 sec.																																																																																										
0	0	1	15 sec.																																																																																										
0	1	0	30 sec.																																																																																										
0	1	1	60 sec.																																																																																										
1	0	0	120 sec.																																																																																										
1	0	1	180 sec.																																																																																										
1	1	0	Manual																																																																																										
3 ~ 2	_____																																																																																												
1 ~ 0	<table border="1"> <thead> <tr> <th>1-bit</th> <th>0-bit</th> <th>REC MODE</th> </tr> </thead> <tbody> <tr><td>0</td><td>0</td><td>OFF</td></tr> <tr><td>0</td><td>1</td><td>ALARM</td></tr> <tr><td>1</td><td>0</td><td>SENSOR</td></tr> </tbody> </table>	1-bit	0-bit	REC MODE	0	0	OFF	0	1	ALARM	1	0	SENSOR																																																																																
1-bit	0-bit	REC MODE																																																																																											
0	0	OFF																																																																																											
0	1	ALARM																																																																																											
1	0	SENSOR																																																																																											

10-3 Commands

Commands	Description																																																																																																										
8AH	<p>ALARM/SENSOR MODE SET: Sets alarm/sensor recording-related data</p> <p>TXD <table border="1"><tr><td>8AH</td><td>□□H</td><td>□□H</td><td>□□H</td></tr></table> RXD <table border="1"><tr><td>0AH</td><td>0AH</td><td>0AH</td><td>0AH</td></tr></table></p> <table border="1"> <tr><th colspan="4">2 bytes</th></tr> <tr><th>Bit</th><th colspan="3">Status details</th></tr> <tr><td>7</td><td colspan="3">_____</td></tr> <tr><td>6 ~ 5</td><td>6-bit</td><td>5-bit</td><td>PRESENSOR REC DURATION</td></tr> <tr><td></td><td>0</td><td>0</td><td>10 sec.</td></tr> <tr><td></td><td>0</td><td>1</td><td>30 sec.</td></tr> <tr><td></td><td>1</td><td>0</td><td>60 sec.</td></tr> <tr><td>4</td><td colspan="3">PRESENSOR REC 0: OFF, 1: ON</td></tr> <tr><td>3 ~ 0</td><td colspan="3">_____</td></tr> <tr><th colspan="4">3 bytes</th></tr> <tr><th>Bit</th><th colspan="3">Status details</th></tr> <tr><td>7 ~ 0</td><td colspan="3">_____</td></tr> </table>	8AH	□□H	□□H	□□H	0AH	0AH	0AH	0AH	2 bytes				Bit	Status details			7	_____			6 ~ 5	6-bit	5-bit	PRESENSOR REC DURATION		0	0	10 sec.		0	1	30 sec.		1	0	60 sec.	4	PRESENSOR REC 0: OFF, 1: ON			3 ~ 0	_____			3 bytes				Bit	Status details			7 ~ 0	_____																																																				
8AH	□□H	□□H	□□H																																																																																																								
0AH	0AH	0AH	0AH																																																																																																								
2 bytes																																																																																																											
Bit	Status details																																																																																																										
7	_____																																																																																																										
6 ~ 5	6-bit	5-bit	PRESENSOR REC DURATION																																																																																																								
	0	0	10 sec.																																																																																																								
	0	1	30 sec.																																																																																																								
	1	0	60 sec.																																																																																																								
4	PRESENSOR REC 0: OFF, 1: ON																																																																																																										
3 ~ 0	_____																																																																																																										
3 bytes																																																																																																											
Bit	Status details																																																																																																										
7 ~ 0	_____																																																																																																										
8BH	<p>DVR REC MODE: Sets the Record mode.</p> <p>TXD <table border="1"><tr><td>8BH</td><td>□□H</td></tr></table> RXD <table border="1"><tr><td>0AH</td><td>0AH</td></tr></table></p> <table border="1"> <tr><th colspan="4">1 byte</th></tr> <tr><th>Bit</th><th colspan="3">Status details</th></tr> <tr><td>7</td><td colspan="3">_____</td></tr> <tr><td>6</td><td colspan="3">Audio recording 0: OFF, 1: ON</td></tr> <tr><td>5 ~ 4</td><td>5-bit</td><td>4-bit</td><td>REC QUALITY</td></tr> <tr><td></td><td>0</td><td>0</td><td>HIGH</td></tr> <tr><td></td><td>0</td><td>1</td><td>NORM</td></tr> <tr><td></td><td>1</td><td>1</td><td>BASIC</td></tr> <tr><td></td><td>1</td><td>0</td><td>LOW</td></tr> <tr><td>3 ~ 0</td><td>3-bit</td><td>2-bit</td><td>1-bit</td><td>0-bit</td><td>REC SPEED</td></tr> <tr><td></td><td>0</td><td>0</td><td>0</td><td>0</td><td>30</td></tr> <tr><td></td><td>0</td><td>0</td><td>0</td><td>1</td><td>15</td></tr> <tr><td></td><td>0</td><td>0</td><td>1</td><td>0</td><td>10</td></tr> <tr><td></td><td>0</td><td>0</td><td>1</td><td>1</td><td>5</td></tr> <tr><td></td><td>0</td><td>1</td><td>0</td><td>0</td><td>3</td></tr> <tr><td></td><td>0</td><td>1</td><td>0</td><td>1</td><td>2</td></tr> <tr><td></td><td>0</td><td>1</td><td>1</td><td>0</td><td>1</td></tr> <tr><td></td><td>0</td><td>1</td><td>1</td><td>1</td><td>1/2</td></tr> <tr><td></td><td>1</td><td>0</td><td>0</td><td>0</td><td>1/5</td></tr> <tr><td></td><td>1</td><td>0</td><td>0</td><td>1</td><td>1/10</td></tr> </table>	8BH	□□H	0AH	0AH	1 byte				Bit	Status details			7	_____			6	Audio recording 0: OFF, 1: ON			5 ~ 4	5-bit	4-bit	REC QUALITY		0	0	HIGH		0	1	NORM		1	1	BASIC		1	0	LOW	3 ~ 0	3-bit	2-bit	1-bit	0-bit	REC SPEED		0	0	0	0	30		0	0	0	1	15		0	0	1	0	10		0	0	1	1	5		0	1	0	0	3		0	1	0	1	2		0	1	1	0	1		0	1	1	1	1/2		1	0	0	0	1/5		1	0	0	1	1/10
8BH	□□H																																																																																																										
0AH	0AH																																																																																																										
1 byte																																																																																																											
Bit	Status details																																																																																																										
7	_____																																																																																																										
6	Audio recording 0: OFF, 1: ON																																																																																																										
5 ~ 4	5-bit	4-bit	REC QUALITY																																																																																																								
	0	0	HIGH																																																																																																								
	0	1	NORM																																																																																																								
	1	1	BASIC																																																																																																								
	1	0	LOW																																																																																																								
3 ~ 0	3-bit	2-bit	1-bit	0-bit	REC SPEED																																																																																																						
	0	0	0	0	30																																																																																																						
	0	0	0	1	15																																																																																																						
	0	0	1	0	10																																																																																																						
	0	0	1	1	5																																																																																																						
	0	1	0	0	3																																																																																																						
	0	1	0	1	2																																																																																																						
	0	1	1	0	1																																																																																																						
	0	1	1	1	1/2																																																																																																						
	1	0	0	0	1/5																																																																																																						
	1	0	0	1	1/10																																																																																																						
8CH	<p>REPEAT REC MODE SET: Sets the repeat recording mode.</p> <p>TXD <table border="1"><tr><td>8CH</td><td>□□H</td></tr></table> RXD <table border="1"><tr><td>0AH</td><td>0AH</td></tr></table></p> <table border="1"> <tr><th colspan="4">1 byte</th></tr> <tr><th>Bit</th><th colspan="3">Status details</th></tr> <tr><td>7 ~ 2</td><td colspan="3">_____</td></tr> <tr><td>1 ~ 0</td><td>1-bit</td><td>0-bit</td><td>REPEAT REC</td></tr> <tr><td></td><td>0</td><td>0</td><td>OFF</td></tr> <tr><td></td><td>0</td><td>1</td><td>AL*STOP</td></tr> <tr><td></td><td>1</td><td>0</td><td>AL*LOCK</td></tr> <tr><td></td><td>1</td><td>1</td><td>ALL</td></tr> </table>	8CH	□□H	0AH	0AH	1 byte				Bit	Status details			7 ~ 2	_____			1 ~ 0	1-bit	0-bit	REPEAT REC		0	0	OFF		0	1	AL*STOP		1	0	AL*LOCK		1	1	ALL																																																																						
8CH	□□H																																																																																																										
0AH	0AH																																																																																																										
1 byte																																																																																																											
Bit	Status details																																																																																																										
7 ~ 2	_____																																																																																																										
1 ~ 0	1-bit	0-bit	REPEAT REC																																																																																																								
	0	0	OFF																																																																																																								
	0	1	AL*STOP																																																																																																								
	1	0	AL*LOCK																																																																																																								
	1	1	ALL																																																																																																								
8DH	<p>DVR REC CAMERA SET: Sets the camera for recording.</p> <p>TXD <table border="1"><tr><td>8DH</td><td>□□H</td></tr></table> RXD <table border="1"><tr><td>0AH</td><td>0AH</td></tr></table></p> <table border="1"> <tr><th colspan="2">1 byte</th></tr> <tr><th>Bit</th><th>Status details</th></tr> <tr><td>7 ~ 1</td><td>_____</td></tr> <tr><td>0</td><td>1: Camera recording ON</td></tr> </table>	8DH	□□H	0AH	0AH	1 byte		Bit	Status details	7 ~ 1	_____	0	1: Camera recording ON																																																																																														
8DH	□□H																																																																																																										
0AH	0AH																																																																																																										
1 byte																																																																																																											
Bit	Status details																																																																																																										
7 ~ 1	_____																																																																																																										
0	1: Camera recording ON																																																																																																										
8EH	<p>DATE SET: Sets month, day and year.</p> <p>TXD <table border="1"><tr><td>8EH</td><td>3□H</td><td>3□H</td><td>3□H</td><td>3□H</td><td>3□H</td><td>3□H</td></tr></table> RXD <table border="1"><tr><td>0AH</td><td>0AH</td><td>0AH</td><td>0AH</td><td>0AH</td><td>0AH</td><td>0AH</td></tr></table></p>	8EH	3□H	3□H	3□H	3□H	3□H	3□H	0AH	0AH	0AH	0AH	0AH	0AH	0AH																																																																																												
8EH	3□H	3□H	3□H	3□H	3□H	3□H																																																																																																					
0AH	0AH	0AH	0AH	0AH	0AH	0AH																																																																																																					
8FH	<p>TIME SET: Sets hour, minutes and seconds.</p> <p>TXD <table border="1"><tr><td>8FH</td><td>3□H</td><td>3□H</td><td>3□H</td><td>3□H</td><td>3□H</td><td>3□H</td></tr></table> RXD <table border="1"><tr><td>0AH</td><td>0AH</td><td>0AH</td><td>0AH</td><td>0AH</td><td>0AH</td><td>0AH</td></tr></table></p>	8FH	3□H	3□H	3□H	3□H	3□H	3□H	0AH	0AH	0AH	0AH	0AH	0AH	0AH																																																																																												
8FH	3□H	3□H	3□H	3□H	3□H	3□H																																																																																																					
0AH	0AH	0AH	0AH	0AH	0AH	0AH																																																																																																					

● SENSE commands

When the command is sent, this unit returns the information corresponding to the command received.

Command	Description																																				
67H D7H	<p>STATUS SENSE: Returns unit status (5 bytes).</p> <p>● 1st byte</p> <p>7 Not defined Always outputs "1".</p> <p>6 Not defined Always outputs "0".</p> <p>5 Not defined Always outputs "0".</p> <p>4 REC INHIBIT Outputs with loop recording set to OFF when no remaining capacity is available.</p> <p>3 Not defined Always outputs "0".</p> <p>2 Not defined Always outputs "0".</p> <p>1 Not defined Always outputs "0".</p> <p>0 ERROR When the command which cannot be received is received. To release this mode, input CLEAR ERROR (41H).</p> <p>● 2nd byte</p> <p>7 EE MODE Outputs video signals input from an external source.</p> <p>6 A1 EE MODE Outputs audio signals input from an external source.</p> <p>5 VIDEO MUTE Always outputs "0".</p> <p>4 AUDIO MUTE Always outputs "0".</p> <p>3 WARNING HDD warning occurs.</p> <p>2 Not defined Always outputs "0".</p> <p>1 STREAM START Detects the stream start point.</p> <p>0 STREAM END Detects the stream end point.</p> <p>● 3rd byte</p> <p>7 Not defined Always outputs "0".</p> <p>6 TIMER REC ON Timer standby is on.</p> <p>5 Not defined Always outputs "0".</p> <p>4 REPEAT Always outputs "0".</p> <p>3 Not defined Always outputs "0".</p> <p>2 REPEAT MODE During repeat recording.</p> <p>1 SEARCH MODE During search</p> <p>0 Not defined Always outputs "0".</p> <p>● 4th byte</p> <p>7 PLAY MODE During playback</p> <p>6 Not defined Always outputs "0".</p> <p>5 Not defined Always outputs "0".</p> <p>4 STOP MODE Stops playback or recording.</p> <p>3 Not defined Always outputs "1".</p> <p>2 Not defined Always outputs "0".</p> <p>1 REC MODE During recording</p> <p>0 Not defined Always outputs "0".</p> <p>● 5th byte</p> <p>7 PAUSE MODE Still pictures are played back. Always outputs "0".</p> <p>6 Not defined Always outputs "0".</p> <p>5 SHUTTLE FWD Shuttle search is being executed in the forward direction.</p> <p>4 SHUTTLE REV Shuttle search is being executed in the reverse direction.</p> <p>3 SPEED CODE3 Current running mode (see table below)</p> <p>2 SPEED CODE2 Current running mode (see table below)</p> <p>1 SPEED CODE1 Current running mode (see table below)</p> <p>0 SPEED CODE0 Current running mode (see table below)</p>																																				
	<table border="1"> <thead> <tr><th colspan="3">5-byte speed code details</th></tr> <tr><th>SPEED CODE</th><th>3210</th><th>Running mode</th></tr> </thead> <tbody> <tr><td>Bit</td><td>0000</td><td>Still pictures being played back.</td></tr> <tr><td></td><td>0010</td><td>x1/18</td></tr> <tr><td></td><td>0011</td><td>x1/6</td></tr> <tr><td></td><td>0100</td><td>x1/2</td></tr> <tr><td></td><td>0101</td><td>x1</td></tr> <tr><td></td><td>0110</td><td>x3</td></tr> <tr><td></td><td>0111</td><td>x5</td></tr> <tr><td></td><td>1000</td><td>x15</td></tr> <tr><td></td><td>1001</td><td>x60</td></tr> <tr><td></td><td>1010</td><td>x360</td></tr> </tbody> </table>	5-byte speed code details			SPEED CODE	3210	Running mode	Bit	0000	Still pictures being played back.		0010	x1/18		0011	x1/6		0100	x1/2		0101	x1		0110	x3		0111	x5		1000	x15		1001	x60		1010	x360
5-byte speed code details																																					
SPEED CODE	3210	Running mode																																			
Bit	0000	Still pictures being played back.																																			
	0010	x1/18																																			
	0011	x1/6																																			
	0100	x1/2																																			
	0101	x1																																			
	0110	x3																																			
	0111	x5																																			
	1000	x15																																			
	1001	x60																																			
	1010	x360																																			

10 RS-232C INTERFACE (contd.)

10-3 Commands (contd.)

Commands	Description																																																																																																							
B9H	<p>DVR SETTING SENSE: Returns settings status.</p> <p>TXD B9H</p> <p>RXD </p> <p>1 st byte 2nd byte 3rd byte</p> <table border="1"> <thead> <tr> <th colspan="4">1 byte</th> </tr> <tr> <th>Bit</th> <th colspan="3">Status details</th> </tr> </thead> <tbody> <tr> <td>7</td> <td colspan="3">Time date rec 0: OFF, 1: ON</td> </tr> <tr> <td>6</td> <td colspan="3">Repeat rec 0: OFF, 1: AL•STOP, AL•LOCK, ALL</td> </tr> <tr> <td>5 ~ 3</td> <td>5-bit</td> <td>4-bit</td> <td>3-bit</td> <td>Skip duration</td> </tr> <tr> <td></td> <td>0</td> <td>0</td> <td>0</td> <td>1 minute</td> </tr> <tr> <td></td> <td>0</td> <td>0</td> <td>1</td> <td>5 minutes</td> </tr> <tr> <td></td> <td>0</td> <td>0</td> <td>0</td> <td>10 minutes</td> </tr> <tr> <td></td> <td>0</td> <td>1</td> <td>1</td> <td>30 minutes</td> </tr> <tr> <td></td> <td>1</td> <td>0</td> <td>1</td> <td>1 hour</td> </tr> <tr> <td></td> <td>1</td> <td>0</td> <td>0</td> <td>4 hours</td> </tr> <tr> <td></td> <td>1</td> <td>0</td> <td>1</td> <td>1 day</td> </tr> <tr> <td></td> <td>1</td> <td>1</td> <td>1</td> <td>1 week</td> </tr> <tr> <td>2 ~ 1</td> <td colspan="3">Search button 00: Time, 01: Alarm, 10: Event</td> </tr> <tr> <td>0</td> <td colspan="3">Power ON rec 0: OFF, 1: ON</td> </tr> </tbody> </table> <table border="1"> <thead> <tr> <th colspan="2">2 bytes</th> </tr> <tr> <th>Bit</th> <th>Status details</th> </tr> </thead> <tbody> <tr> <td>7</td> <td>Operation Lock mode 0: ALL, 1: REC</td> </tr> <tr> <td>6</td> <td></td> </tr> <tr> <td>5</td> <td>HDD full out 0: OFF, 1: ON</td> </tr> <tr> <td>4 ~ 3</td> <td>Ext mode 00: OFF, 1: Trig, 10: Manual</td> </tr> <tr> <td>2 ~ 1</td> <td>Alarm/sensor indication 00: OFF, 01: ON1, 10: ON2</td> </tr> <tr> <td>0</td> <td>Rec tally 0: OFF, 1: ON</td> </tr> </tbody> </table> <table border="1"> <thead> <tr> <th colspan="2">3 bytes</th> </tr> <tr> <th>Bit</th> <th>Status details</th> </tr> </thead> <tbody> <tr> <td>7</td> <td>External switcher</td> </tr> <tr> <td>6</td> <td>0: OFF, 1: ON</td> </tr> <tr> <td>5 ~ 4</td> <td></td> </tr> <tr> <td>3</td> <td></td> </tr> <tr> <td>2</td> <td>Warning buzzer 0: OFF, 1: ON</td> </tr> <tr> <td>1</td> <td>Alarm/sensor buzzer 0: OFF, 1: ON</td> </tr> <tr> <td>0</td> <td>HDD end buzzer 0: OFF, 1: ON</td> </tr> </tbody> </table>	1 byte				Bit	Status details			7	Time date rec 0: OFF, 1: ON			6	Repeat rec 0: OFF, 1: AL•STOP, AL•LOCK, ALL			5 ~ 3	5-bit	4-bit	3-bit	Skip duration		0	0	0	1 minute		0	0	1	5 minutes		0	0	0	10 minutes		0	1	1	30 minutes		1	0	1	1 hour		1	0	0	4 hours		1	0	1	1 day		1	1	1	1 week	2 ~ 1	Search button 00: Time, 01: Alarm, 10: Event			0	Power ON rec 0: OFF, 1: ON			2 bytes		Bit	Status details	7	Operation Lock mode 0: ALL, 1: REC	6		5	HDD full out 0: OFF, 1: ON	4 ~ 3	Ext mode 00: OFF, 1: Trig, 10: Manual	2 ~ 1	Alarm/sensor indication 00: OFF, 01: ON1, 10: ON2	0	Rec tally 0: OFF, 1: ON	3 bytes		Bit	Status details	7	External switcher	6	0: OFF, 1: ON	5 ~ 4		3		2	Warning buzzer 0: OFF, 1: ON	1	Alarm/sensor buzzer 0: OFF, 1: ON	0	HDD end buzzer 0: OFF, 1: ON
1 byte																																																																																																								
Bit	Status details																																																																																																							
7	Time date rec 0: OFF, 1: ON																																																																																																							
6	Repeat rec 0: OFF, 1: AL•STOP, AL•LOCK, ALL																																																																																																							
5 ~ 3	5-bit	4-bit	3-bit	Skip duration																																																																																																				
	0	0	0	1 minute																																																																																																				
	0	0	1	5 minutes																																																																																																				
	0	0	0	10 minutes																																																																																																				
	0	1	1	30 minutes																																																																																																				
	1	0	1	1 hour																																																																																																				
	1	0	0	4 hours																																																																																																				
	1	0	1	1 day																																																																																																				
	1	1	1	1 week																																																																																																				
2 ~ 1	Search button 00: Time, 01: Alarm, 10: Event																																																																																																							
0	Power ON rec 0: OFF, 1: ON																																																																																																							
2 bytes																																																																																																								
Bit	Status details																																																																																																							
7	Operation Lock mode 0: ALL, 1: REC																																																																																																							
6																																																																																																								
5	HDD full out 0: OFF, 1: ON																																																																																																							
4 ~ 3	Ext mode 00: OFF, 1: Trig, 10: Manual																																																																																																							
2 ~ 1	Alarm/sensor indication 00: OFF, 01: ON1, 10: ON2																																																																																																							
0	Rec tally 0: OFF, 1: ON																																																																																																							
3 bytes																																																																																																								
Bit	Status details																																																																																																							
7	External switcher																																																																																																							
6	0: OFF, 1: ON																																																																																																							
5 ~ 4																																																																																																								
3																																																																																																								
2	Warning buzzer 0: OFF, 1: ON																																																																																																							
1	Alarm/sensor buzzer 0: OFF, 1: ON																																																																																																							
0	HDD end buzzer 0: OFF, 1: ON																																																																																																							
BAH	<p>ALARM/SENSOR MODE SENSE: Sets the alarm/sensor recording-related settings.</p> <p>TXD BAH</p> <p>RXD </p> <p>1st byte 2nd byte 3rd byte</p> <table border="1"> <thead> <tr> <th colspan="4">1 byte</th> </tr> <tr> <th>Bit</th> <th colspan="3">Status details</th> </tr> </thead> <tbody> <tr> <td>7</td> <td colspan="3"></td> </tr> <tr> <td>6 ~ 4</td> <td>6-bit</td> <td>5-bit</td> <td>4-bit</td> <td>Alarm/sensor recording duration</td> </tr> <tr> <td></td> <td>0</td> <td>0</td> <td>0</td> <td>10 sec.</td> </tr> <tr> <td></td> <td>0</td> <td>0</td> <td>1</td> <td>15 sec.</td> </tr> <tr> <td></td> <td>0</td> <td>1</td> <td>0</td> <td>30 sec.</td> </tr> <tr> <td></td> <td>0</td> <td>1</td> <td>1</td> <td>60 sec.</td> </tr> <tr> <td></td> <td>1</td> <td>0</td> <td>0</td> <td>120 sec.</td> </tr> <tr> <td></td> <td>1</td> <td>0</td> <td>1</td> <td>180 sec.</td> </tr> <tr> <td></td> <td>1</td> <td>1</td> <td>0</td> <td>Manual</td> </tr> <tr> <td>3 ~ 2</td> <td colspan="3"></td> </tr> <tr> <td>1 ~ 0</td> <td>1-bit</td> <td>0-bit</td> <td>REC MODE</td> </tr> <tr> <td></td> <td>0</td> <td>0</td> <td>OFF</td> </tr> <tr> <td></td> <td>0</td> <td>1</td> <td>ALARM</td> </tr> <tr> <td></td> <td>1</td> <td>0</td> <td>SENSOR</td> </tr> </tbody> </table>	1 byte				Bit	Status details			7				6 ~ 4	6-bit	5-bit	4-bit	Alarm/sensor recording duration		0	0	0	10 sec.		0	0	1	15 sec.		0	1	0	30 sec.		0	1	1	60 sec.		1	0	0	120 sec.		1	0	1	180 sec.		1	1	0	Manual	3 ~ 2				1 ~ 0	1-bit	0-bit	REC MODE		0	0	OFF		0	1	ALARM		1	0	SENSOR																															
1 byte																																																																																																								
Bit	Status details																																																																																																							
7																																																																																																								
6 ~ 4	6-bit	5-bit	4-bit	Alarm/sensor recording duration																																																																																																				
	0	0	0	10 sec.																																																																																																				
	0	0	1	15 sec.																																																																																																				
	0	1	0	30 sec.																																																																																																				
	0	1	1	60 sec.																																																																																																				
	1	0	0	120 sec.																																																																																																				
	1	0	1	180 sec.																																																																																																				
	1	1	0	Manual																																																																																																				
3 ~ 2																																																																																																								
1 ~ 0	1-bit	0-bit	REC MODE																																																																																																					
	0	0	OFF																																																																																																					
	0	1	ALARM																																																																																																					
	1	0	SENSOR																																																																																																					

Commands	Description																																																																																														
BAH	<table border="1"> <thead> <tr> <th colspan="3">2 bytes</th> </tr> <tr> <th>Bit</th> <th colspan="2">Status details</th> </tr> </thead> <tbody> <tr> <td>7</td> <td colspan="2"></td> </tr> <tr> <td>6 ~ 5</td> <td>6-bit</td> <td>5-bit</td> <td>PRESENSOR REC DURATION</td> </tr> <tr> <td></td> <td>0</td> <td>0</td> <td>10 sec.</td> </tr> <tr> <td></td> <td>0</td> <td>1</td> <td>30 sec.</td> </tr> <tr> <td></td> <td>1</td> <td>0</td> <td>60 sec.</td> </tr> <tr> <td>4</td> <td colspan="2">PRESENSOR REC 0: OFF, 1: ON</td> </tr> <tr> <td>3 ~ 0</td> <td colspan="2"></td> </tr> </tbody> </table> <table border="1"> <thead> <tr> <th colspan="2">3 bytes</th> </tr> <tr> <th>Bit</th> <th>Status details</th> </tr> </thead> <tbody> <tr> <td>7 ~ 0</td> <td></td> </tr> </tbody> </table>	2 bytes			Bit	Status details		7			6 ~ 5	6-bit	5-bit	PRESENSOR REC DURATION		0	0	10 sec.		0	1	30 sec.		1	0	60 sec.	4	PRESENSOR REC 0: OFF, 1: ON		3 ~ 0			3 bytes		Bit	Status details	7 ~ 0																																																										
2 bytes																																																																																															
Bit	Status details																																																																																														
7																																																																																															
6 ~ 5	6-bit	5-bit	PRESENSOR REC DURATION																																																																																												
	0	0	10 sec.																																																																																												
	0	1	30 sec.																																																																																												
	1	0	60 sec.																																																																																												
4	PRESENSOR REC 0: OFF, 1: ON																																																																																														
3 ~ 0																																																																																															
3 bytes																																																																																															
Bit	Status details																																																																																														
7 ~ 0																																																																																															
BBH	<p>DVR REC MODE SENSE: Returns the recording mode information.</p> <p>TXD BBH</p> <p>RXD </p> <p>1st byte</p> <table border="1"> <thead> <tr> <th colspan="2">1 byte</th> </tr> <tr> <th>Bit</th> <th>Status details</th> </tr> </thead> <tbody> <tr> <td>7</td> <td></td> </tr> <tr> <td>6</td> <td>Audio recording 0: OFF, 1: ON</td> </tr> <tr> <td>5 ~ 4</td> <td>5-bit</td> <td>4-bit</td> <td>REC QUALITY</td> </tr> <tr> <td></td> <td>0</td> <td>0</td> <td>HIGH</td> </tr> <tr> <td></td> <td>0</td> <td>1</td> <td>NORM</td> </tr> <tr> <td></td> <td>1</td> <td>1</td> <td>BASIC</td> </tr> <tr> <td></td> <td>1</td> <td>0</td> <td>LOW</td> </tr> <tr> <td>3 ~ 0</td> <td>3-bit</td> <td>2-bit</td> <td>1-bit</td> <td>0-bit</td> <td>REC SPEED</td> </tr> <tr> <td></td> <td>0</td> <td>0</td> <td>0</td> <td>0</td> <td>30</td> </tr> <tr> <td></td> <td>0</td> <td>0</td> <td>0</td> <td>1</td> <td>15</td> </tr> <tr> <td></td> <td>0</td> <td>0</td> <td>1</td> <td>0</td> <td>10</td> </tr> <tr> <td></td> <td>0</td> <td>0</td> <td>1</td> <td>1</td> <td>5</td> </tr> <tr> <td></td> <td>0</td> <td>1</td> <td>0</td> <td>0</td> <td>3</td> </tr> <tr> <td></td> <td>0</td> <td>1</td> <td>0</td> <td>1</td> <td>2</td> </tr> <tr> <td></td> <td>0</td> <td>1</td> <td>1</td> <td>0</td> <td>1</td> </tr> <tr> <td></td> <td>0</td> <td>1</td> <td>1</td> <td>1</td> <td>1/2</td> </tr> <tr> <td></td> <td>1</td> <td>0</td> <td>0</td> <td>0</td> <td>1/5</td> </tr> <tr> <td></td> <td>1</td> <td>0</td> <td>0</td> <td>1</td> <td>1/10</td> </tr> </tbody> </table>	1 byte		Bit	Status details	7		6	Audio recording 0: OFF, 1: ON	5 ~ 4	5-bit	4-bit	REC QUALITY		0	0	HIGH		0	1	NORM		1	1	BASIC		1	0	LOW	3 ~ 0	3-bit	2-bit	1-bit	0-bit	REC SPEED		0	0	0	0	30		0	0	0	1	15		0	0	1	0	10		0	0	1	1	5		0	1	0	0	3		0	1	0	1	2		0	1	1	0	1		0	1	1	1	1/2		1	0	0	0	1/5		1	0	0	1	1/10
1 byte																																																																																															
Bit	Status details																																																																																														
7																																																																																															
6	Audio recording 0: OFF, 1: ON																																																																																														
5 ~ 4	5-bit	4-bit	REC QUALITY																																																																																												
	0	0	HIGH																																																																																												
	0	1	NORM																																																																																												
	1	1	BASIC																																																																																												
	1	0	LOW																																																																																												
3 ~ 0	3-bit	2-bit	1-bit	0-bit	REC SPEED																																																																																										
	0	0	0	0	30																																																																																										
	0	0	0	1	15																																																																																										
	0	0	1	0	10																																																																																										
	0	0	1	1	5																																																																																										
	0	1	0	0	3																																																																																										
	0	1	0	1	2																																																																																										
	0	1	1	0	1																																																																																										
	0	1	1	1	1/2																																																																																										
	1	0	0	0	1/5																																																																																										
	1	0	0	1	1/10																																																																																										
BCH	<p>REPEAT REC ON MODE SENSE: Returns Repeat Recording mode settings.</p> <p>TXD BCH</p> <p>RXD </p> <p>1st byte</p> <table border="1"> <thead> <tr> <th colspan="2">1 byte</th> </tr> <tr> <th>Bit</th> <th>Status details</th> </tr> </thead> <tbody> <tr> <td>7 ~ 2</td> <td></td> </tr> <tr> <td>1 ~ 0</td> <td>1-bit</td> <td>0-bit</td> <td>REPEAT REC</td> </tr> <tr> <td></td> <td>0</td> <td>0</td> <td>OFF</td> </tr> <tr> <td></td> <td>0</td> <td>1</td> <td>AL•STOP</td> </tr> <tr> <td></td> <td>1</td> <td>0</td> <td>AL•LOCK</td> </tr> <tr> <td></td> <td>1</td> <td>1</td> <td>ALL</td> </tr> </tbody> </table>	1 byte		Bit	Status details	7 ~ 2		1 ~ 0	1-bit	0-bit	REPEAT REC		0	0	OFF		0	1	AL•STOP		1	0	AL•LOCK		1	1	ALL																																																																				
1 byte																																																																																															
Bit	Status details																																																																																														
7 ~ 2																																																																																															
1 ~ 0	1-bit	0-bit	REPEAT REC																																																																																												
	0	0	OFF																																																																																												
	0	1	AL•STOP																																																																																												
	1	0	AL•LOCK																																																																																												
	1	1	ALL																																																																																												
BDH	<p>DVR REC CAMERA SENSE: Returns recording camera status.</p> <p>TXD BDH</p> <p>RXD </p> <p>1st byte</p> <table border="1"> <thead> <tr> <th colspan="2">1 byte</th> </tr> <tr> <th>Bit</th> <th>Status details</th> </tr> </thead> <tbody> <tr> <td>7 ~ 1</td> <td></td> </tr> <tr> <td>0</td> <td>Always returns "1".</td> </tr> </tbody> </table>	1 byte		Bit	Status details	7 ~ 1		0	Always returns "1".																																																																																						
1 byte																																																																																															
Bit	Status details																																																																																														
7 ~ 1																																																																																															
0	Always returns "1".																																																																																														

10 RS-232C INTERFACE (contd.)

10-3 Commands

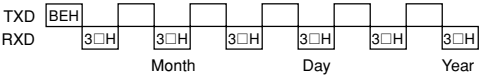
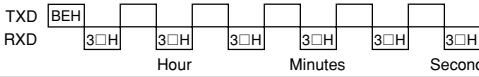
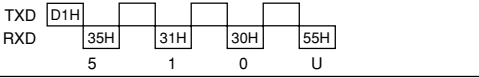
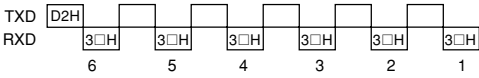
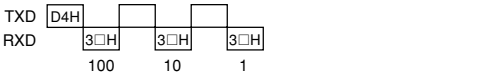
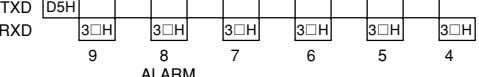
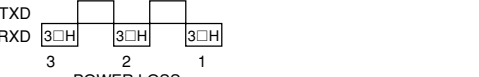
Commands	Description								
BEH	DATE SENSE: Returns current settings for month, day, and year. 								
BFH	TIME SENSE: Returns current settings for hour, minutes and seconds. 								
D0H	HDD FORMAT SENSE: Returns hard disk format information. TXD [D0H] RXD [□□H] 1st byte <table border="1" data-bbox="272 741 730 857"> <thead> <tr> <th>1 byte</th> <th>Status details</th> </tr> </thead> <tbody> <tr> <td>00H</td> <td>Not defined</td> </tr> <tr> <td>01H</td> <td>Standard format</td> </tr> <tr> <td>02H</td> <td>Extension format</td> </tr> </tbody> </table>	1 byte	Status details	00H	Not defined	01H	Standard format	02H	Extension format
1 byte	Status details								
00H	Not defined								
01H	Standard format								
02H	Extension format								
D1H	DEVICE TYPE: Returns the connected device type. 								
D2H	HOUR METER SENSE: Returns the hour meter. 								
D4H	REMAIN SENSE: Returns the remaining capacity. 								
D5H	PL/AL COUNT SENSE: Returns the number of PL/AL.  								

Commands	Description																																																								
D6H	VR STATUS SENSE: Returns DVR-related status. TXD [D6H] RXD [□□H] [□□H] [□□H] 1 st byte 2nd byte 3rd byte <table border="1" data-bbox="981 443 1439 743"> <thead> <tr> <th colspan="2">1 byte</th> </tr> <tr> <th>Bit</th> <th>Status details</th> </tr> </thead> <tbody> <tr> <td>7</td> <td>_____</td> </tr> <tr> <td>6</td> <td>Not defined Always outputs "0".</td> </tr> <tr> <td>5</td> <td>Not defined Always outputs "0".</td> </tr> <tr> <td>4</td> <td>Not defined Always outputs "0".</td> </tr> <tr> <td>3</td> <td>_____</td> </tr> <tr> <td>2</td> <td>_____</td> </tr> <tr> <td>1</td> <td>JVC TABLE 1 Returns "1" when JVC TABLE 1 is open.</td> </tr> <tr> <td>0</td> <td>LOCAL Always outputs "0".</td> </tr> </tbody> </table> <table border="1" data-bbox="981 766 1439 1146"> <thead> <tr> <th colspan="2">2 byte</th> </tr> <tr> <th>Bit</th> <th>Status details</th> </tr> </thead> <tbody> <tr> <td>7</td> <td>ScanDisk Returns "1" when the disk is being scanned.</td> </tr> <tr> <td>6</td> <td>_____</td> </tr> <tr> <td>5</td> <td>Format Returns "1" when the disk is being formatted.</td> </tr> <tr> <td>4</td> <td>HddFull Returns "1" with HDD FULL.</td> </tr> <tr> <td>3</td> <td>TrackFull Returns "1" with track full.</td> </tr> <tr> <td>2</td> <td>_____</td> </tr> <tr> <td>1</td> <td>SensorRec Returns "1" during sensor recording.</td> </tr> <tr> <td>0</td> <td>AlarmRec Returns "1" during alarm recording.</td> </tr> </tbody> </table> <table border="1" data-bbox="981 1169 1439 1415"> <thead> <tr> <th colspan="2">3 byte</th> </tr> <tr> <th>Bit</th> <th>Status details</th> </tr> </thead> <tbody> <tr> <td>7</td> <td>Not defined Returns "0".</td> </tr> <tr> <td>6</td> <td>Not defined Returns "0".</td> </tr> <tr> <td>5</td> <td>Not defined Returns "0".</td> </tr> <tr> <td>4</td> <td>Cam in Returns "1" with camera input.</td> </tr> <tr> <td>3</td> <td>Not defined Returns "0".</td> </tr> <tr> <td>2 ~ 0</td> <td>PB CAM/MONI CAM</td> </tr> </tbody> </table>	1 byte		Bit	Status details	7	_____	6	Not defined Always outputs "0".	5	Not defined Always outputs "0".	4	Not defined Always outputs "0".	3	_____	2	_____	1	JVC TABLE 1 Returns "1" when JVC TABLE 1 is open.	0	LOCAL Always outputs "0".	2 byte		Bit	Status details	7	ScanDisk Returns "1" when the disk is being scanned.	6	_____	5	Format Returns "1" when the disk is being formatted.	4	HddFull Returns "1" with HDD FULL.	3	TrackFull Returns "1" with track full.	2	_____	1	SensorRec Returns "1" during sensor recording.	0	AlarmRec Returns "1" during alarm recording.	3 byte		Bit	Status details	7	Not defined Returns "0".	6	Not defined Returns "0".	5	Not defined Returns "0".	4	Cam in Returns "1" with camera input.	3	Not defined Returns "0".	2 ~ 0	PB CAM/MONI CAM
1 byte																																																									
Bit	Status details																																																								
7	_____																																																								
6	Not defined Always outputs "0".																																																								
5	Not defined Always outputs "0".																																																								
4	Not defined Always outputs "0".																																																								
3	_____																																																								
2	_____																																																								
1	JVC TABLE 1 Returns "1" when JVC TABLE 1 is open.																																																								
0	LOCAL Always outputs "0".																																																								
2 byte																																																									
Bit	Status details																																																								
7	ScanDisk Returns "1" when the disk is being scanned.																																																								
6	_____																																																								
5	Format Returns "1" when the disk is being formatted.																																																								
4	HddFull Returns "1" with HDD FULL.																																																								
3	TrackFull Returns "1" with track full.																																																								
2	_____																																																								
1	SensorRec Returns "1" during sensor recording.																																																								
0	AlarmRec Returns "1" during alarm recording.																																																								
3 byte																																																									
Bit	Status details																																																								
7	Not defined Returns "0".																																																								
6	Not defined Returns "0".																																																								
5	Not defined Returns "0".																																																								
4	Cam in Returns "1" with camera input.																																																								
3	Not defined Returns "0".																																																								
2 ~ 0	PB CAM/MONI CAM																																																								
95H	PL RESET: Resets the PL memory and the PL number.																																																								
F6H	JVC TABLE ON: Enables JVC TABLE 1. JVC TABLE 1 is maintained until F7H command is output.																																																								
F7H	BASIC TABLE ON: Enables BASIC TABLE.																																																								
FAH	REC/DUB REQUEST: This command is sent before sending REC/UTILITY command.																																																								
FBH	VTR/DVR INQ Returns ACK to check that the connected device is DVR.																																																								

11 OTHERS

11-1 Recording time

The table below shows the recording time in each picture quality mode. Actual recording time may differ depending on the hard disk conditions so you should use these figures as guidelines only.

AUDIO REC ON (80 GB)

[Unit: Hours]

Format	Rec quality	30 FPS	15 FPS	10 FPS	5 FPS	3 FPS	2 FPS	1 FPS	1/2 FPS	1/5 FPS	1/10 FPS
Standard	HIGH	14	28	41	80	129	185	325	523		
	NORMAL	27	54	80	151	234	323	520	749		
	BASIC	36	71	104	194	295	399	614	841		
	LOW	54	104	151	271	398	520	749	960		
Extension	HIGH	12	24	37	71	115	164	289	465		
	NORMAL	24	48	71	134	208	287	462	666		
	BASIC	32	63	93	172	262	354	546	748		
	LOW	48	93	134	241	354	462	665	853		

* If audio signal recording is set to "ON", it will be automatically set to "OFF" when 1/5 fps or 1/10 fps is selected. No sound will be recorded in this case.

AUDIO REC OFF (80 GB)

[Unit: Hours]

Format	Rec quality	30 FPS	15 FPS	10 FPS	5 FPS	3 FPS	2 FPS	1 FPS	1/2 FPS	1/5 FPS	1/10 FPS
Standard	HIGH	14	28	43	86	143	215	430	861	2153	4306
	NORMAL	28	56	85	170	284	426	853	1706	4265	8531
	BASIC	37	75	113	227	379	568	1137	2275	5687	11375
	LOW	56	113	170	340	568	852	1704	3408	8520	17041
Extension	HIGH	12	25	38	76	127	191	382	765	1914	3828
	NORMAL	25	50	75	151	252	379	758	1516	3792	7584
	BASIC	33	67	101	202	337	505	1011	2022	5056	10113
	LOW	50	100	151	302	504	757	1514	3029	7574	15149

AUDIO REC ON (160 GB)

[Unit: Hours]

Format	Rec quality	30 FPS	15 FPS	10 FPS	5 FPS	3 FPS	2 FPS	1 FPS	1/2 FPS	1/5 FPS	1/10 FPS
Standard	HIGH	28	57	85	164	264	378	664	1068		
	NORMAL	56	111	163	308	478	659	1061	1528		
	BASIC	75	146	213	396	602	813	1253	1716		
	LOW	111	213	308	553	812	1061	1527	1957		
Extension	HIGH	27	54	80	156	250	357	628	1010		
	NORMAL	53	105	154	291	452	623	1004	1445		
	BASIC	71	138	202	375	569	769	1185	1624		
	LOW	105	201	291	523	768	1003	1444	1851		

* If audio signal recording is set to "ON", it will be automatically set to "OFF" when 1/5 fps or 1/10 fps is selected. No sound will be recorded in this case.

AUDIO REC OFF (160 GB)

[Unit: Hours]

Format	Rec quality	30 FPS	15 FPS	10 FPS	5 FPS	3 FPS	2 FPS	1 FPS	1/2 FPS	1/5 FPS	1/10 FPS
Standard	HIGH	29	58	87	175	292	439	878	1756	4390	8780
	NORMAL	57	115	173	347	579	869	1739	3479	8698	17397
	BASIC	77	154	231	463	773	1159	2319	4639	11598	23197
	LOW	115	231	347	694	1158	1737	3474	6949	17374	34749
Extension	HIGH	27	55	83	166	276	415	830	1661	4152	8305
	NORMAL	54	109	164	329	548	822	1645	3291	8228	16456
	BASIC	73	146	219	438	731	1097	2194	4388	10971	21942
	LOW	109	219	328	657	1095	1643	3286	6573	16434	32869

* Up to 13,000 events (standard) or 100,000 events (extension) can be recorded (including alarm/sensor events). If many short-duration alarm/sensor events are recorded, the actual recording time may be less than that shown above.

11 OTHER (contd.)

11-2 Signal input/output terminals

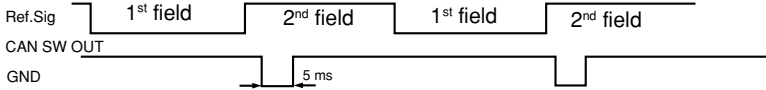
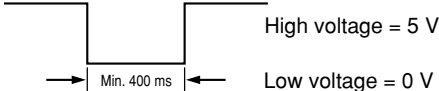
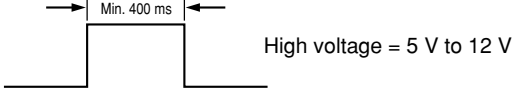
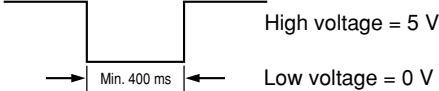
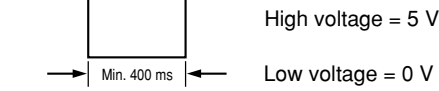
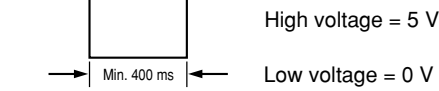
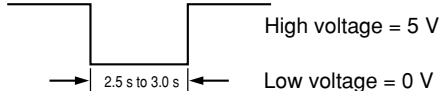
Terminals	Signal level	Remarks
[CAM SW OUT] camera switching signal output	<p>(When menu switch <REC SPEED> is set to "30")</p>  <p>Ref.Sig</p> <p>CAN SW OUT</p> <p>GND</p> <p>5 ms</p>	Open collector output
[ALARM IN 1] alarm signal input	 <p>High voltage = 5 V</p> <p>Low voltage = 0 V</p> <p>Min. 400 ms</p>	Ground input
[ALARM RESET] alarm signal reset input	 <p>High voltage = 5 V to 12 V</p> <p>Low voltage = 0 V</p> <p>Min. 400 ms</p>	High input About 47 kohms
[CLOCK RESET OUT] clock reset output	 <p>High voltage = 5 V</p> <p>Low voltage = 0 V</p> <p>Min. 400 ms</p>	Ground output
[CLOCK RESET IN] clock reset input	 <p>High voltage = 5 V</p> <p>Low voltage = 0 V</p> <p>Min. 400 ms</p>	Ground input
[EXT REC IN] external automatic recording signal input	 <p>High voltage = 5 V</p> <p>Low voltage = 0 V</p> <p>Min. 400 ms</p>	Ground input
[HDD FULL OUT] HDD full signal output	 <p>High voltage = 5 V</p> <p>Low voltage = 0 V</p> <p>2.5 s to 3.0 s</p>	Ground output Output impedance of 1 kohm or less

11 OTHER (contd.)

11-3 Specifications

<General>

- Picture compression : MPEG 2 (1 frame only)
- Recording capacity : 80 GB (can be increased up to 160 GB)
- Power supply : AC 120 V, 60 Hz
- Power consumption : 34 W
- Allowable operation temperature : 5°C to 40°C
- Allowable storage temperature : - 20°C to 60°C
- Allowable operation humidity : 30% to 80%
- Weight : Approx. 6.0 kg

<Video signal system>

- Line input : 1.0 Vp-p, 75 ohms (BNC unbalanced)
- Line output : 1.0 Vp-p, 75 ohms (BNC unbalanced)
- Effective number of pixels : 720 x 480 (high picture quality)
360 x 240 (normal picture quality)
360 x 240 (medium picture quality)
360 x 240 (low picture quality)

<Audio signal system>

- Number of tracks : 1 ch
- Line input level : - 8 dBs, 50 kohms (unbalanced)
- Line output level : - 8 dBs, 1 kohm (unbalanced)
- Frequency response : 100 Hz to 10 kHz
- Audio compression system : 32 kHz sampling, 16-bit MPEG layer 2

<Provided accessories>

- Instruction manual x 1
- Power cord x 1
- Lithium battery (CR2032) x 1 (for operation check)
- Operation lock key x 2

<Option>

SA-K51U (optional HDD kit)

* For details, consult an authorized JVC dealer.

<Dimensions>

Unit: mm (inches)

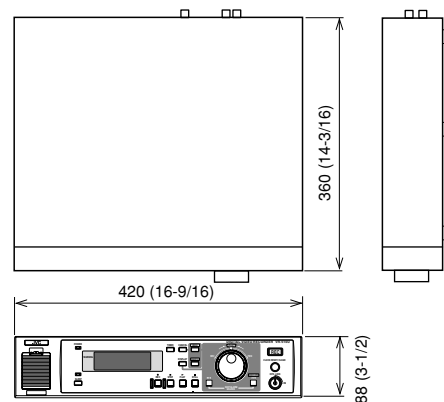

* Design and specifications subject to change without notice.



Free Manuals Download Website

<http://myh66.com>

<http://usermanuals.us>

<http://www.somanuals.com>

<http://www.4manuals.cc>

<http://www.manual-lib.com>

<http://www.404manual.com>

<http://www.luxmanual.com>

<http://aubethermostatmanual.com>

Golf course search by state

<http://golfingnear.com>

Email search by domain

<http://emailbydomain.com>

Auto manuals search

<http://auto.somanuals.com>

TV manuals search

<http://tv.somanuals.com>