

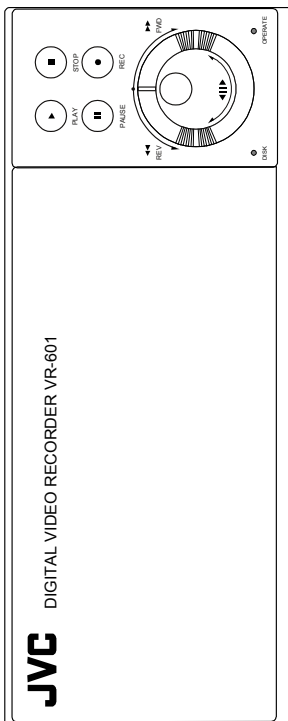

VR-601 DIGITAL VIDEO RECORDER

DIGITAL VIDEO RECORDER VR - 601

INSTRUCTION MANUAL



For Customer Use:
 Enter below the serial No. which is located on the rear of cabinet. Retain this information for future reference.

Model No. : VR-601 _____
 Serial No. : _____

Thank you for purchasing this JVC product. Before operating this unit, please read the instructions carefully to ensure the best possible performance.



JVC® is a registered trademark, owned by VICTOR COMPANY OF JAPAN, LTD.
 JVC® is a registered trademark, in Japan, the U.S.A., the U.K. and many other countries.
 © 2003 VICTOR COMPANY OF JAPAN, LIMITED

Printed in Taiwan



IMPORTANT SAFEGUARDS

- Read all of these instructions.
- Save these instructions for later use.
- All warnings on the product and in the operating instructions should be adhered to.
- Unplug this appliance system from the wall outlet before cleaning. Do not use liquid cleaners or aerosol cleaners. Use a damp cloth for cleaning.
- Do not use attachments not recommended by the appliance manufacturer as they may cause hazards.
- Do not use this appliance near water* for example, near a bathtub, washbowl, kitchen sink, or laundry tub, in a wet basement, or near a swimming pool, etc.
- Do not place this appliance on an unstable cart, stand, or table. The appliance may fall, causing serious injury to a child or adult, and serious damage to the appliance.

PORTABLE CART WARNING
(symbol provided by RETAB)



S3125A
- Use only with a cart or stand recommended by the manufacturer, or sold with the appliance.
- Wall or shelf mounting should follow the manufacturer instructions, and should use a mounting kit approved by the manufacturer.
- An appliance and cart combination should be moved with care. Quick stops, excessive force, and uneven surfaces may cause the appliance and cart combination to overturn.
- Slots and openings in the cabinet and the back or bottom are provided for ventilation, and to insure reliable operation of the appliance and to protect it from overheating; these openings must not be blocked or covered. The openings should never be blocked by placing the appliance on a bed, sofa, rug, or other similar surface. This appliance should not be placed in a built-in installation such as a bookcase unless proper ventilation is provided.
- This appliance should be operated only from the type of power source indicated on the marking label. If you are not sure of the type of power supplied to your home, consult your dealer or local power company. For appliance designed to operate from battery power, refer to the operating instructions.
- This appliance system is equipped with a 3-wire grounding type plug (a plug having a third (grounding) pin). This plug will only fit into a grounding-type power outlet. This is a safety feature. If you are unable to insert the plug into the outlet, contact your electrician to replace obsolete outlet. Do not defeat the safety purpose of the grounding plug. For added protection for this product during a lightning storm, or when it is left unattended and unused for long periods of time, unplug it from the wall outlet and disconnect the antenna or cable system. This will prevent damage to the product due to lightning and power-line surges.
- Do not allow anything to rest on the power cord. Do not locate this appliance where the cord will be abused by persons walking on it.
- Follow all warnings and instructions marked on the appliance.
- Do not overload wall outlets and extension cords as this can result in fire or electric shock.
- Never push objects of any kind into this appliance through cabinet slots as they may touch dangerous voltage points or short out parts that could result in a fire or electric shock. Never spill liquid of any kind on the appliance.
- Do not attempt to service this appliance yourself as opening or removing covers may touch dangerous voltage or other hazards. Refer all servicing to qualified service personnel.
- Unplug this appliance from the wall outlet and refer servicing to qualified service personnel under the following conditions:
 - When the power cord or plug is damaged or frayed.
 - If liquid has been spilled into the appliance.
 - If the appliance has been exposed to rain or water.
 - If the appliance does not operate normally by following the operating instructions. Adjust only those controls that are covered by the operating instructions as improper adjustment of other controls may result in damage and will often require extensive work by a qualified technician to restore the appliance to normal operation.
 - If the appliance has been dropped or the cabinet has been damaged.
 - When the appliance exhibits a distinct change in performance this indicates a need for service.
- When replacement parts are required, be sure the service technician has used replacement parts specified by the manufacturer that have the same characteristics as the original part. Unauthorized substitutions may result in fire, electric shock, or other hazards.
- Upon completion of any service or repairs to this appliance, ask the service technician to perform routine safety checks to determine that the appliance is in safe operating condition.

SAFETY PRECAUTIONS (FOR USA AND CANADA)



CAUTION
RISK OF ELECTRIC SHOCK
DO NOT OPEN



CAUTION: TO REDUCE THE RISK OF ELECTRIC SHOCK, DO NOT REMOVE COVER (OR BACK). NO USER SERVICEABLE PARTS INSIDE. REFER SERVICING TO QUALIFIED SERVICE PERSONNEL.

The lightning flash with arrowhead symbol, within an equilateral triangle, is intended to alert the user to the presence of unisolated "dangerous voltage" within the product's enclosure that may be of sufficient magnitude to constitute a risk of electric shock to persons.

The exclamation point within an equilateral triangle is intended to alert the user to the presence of important operating and maintenance (servicing) instructions in the literature accompanying the appliance.



ATTENTION
RISQUE D'ELECTROCUTION
NE PAS OUVRIER



ATTENTION: POUR EVITER TOUT RISQUE D'ELECTROCUTION NE PAS OUVRIER LE BOITIER. AUCUNE PIECE INTERIEURE N'EST A REGLER PAR L'UTILISATEUR. SE REFERER A UN AGENT QUALIFIE EN CAS DE PROBLEME.

Le symbole de foudre à l'intérieur d'un triangle équilatéral est destiné à avertir l'utilisateur sur la présence d'opérations d'entretien importantes au sujet desquelles des renseignements se trouvent dans le manuel d'instructions. Ces symboles ne sont utilisés qu'aux États-Unis.

WARNING:
TO REDUCE THE RISK OF FIRE OR ELECTRIC SHOCK, DO NOT EXPOSE THIS APPLIANCE TO RAIN OR MOISTURE.
This unit should be used with 120V AC only.

CAUTION:
To prevent electric shocks and fire hazards, DO NOT use any other power.

NOTE:
The rating plate (serial number plate) is on the rear of the unit.

AVERTISSEMENT:
POUR EVITER LES RISQUES D'INCENDIE OU D'ELECTROCUTION, NE PAS EXPOSER L'APPAREIL A L'HUMIDITE OU A LA PLUIE.
Ce magnétoscope ne doit être utilisé que sur du courant alternatif en 120V.

ATTENTION:
Afin d'éviter tout risque d'incendie ou d'électrocution, ne pas utiliser d'autres sources d'alimentation électrique.

REMARQUE:
La plaque d'identification (numéro de série) se trouve sur le panneau arrière de l'appareil.

WARNING:
The battery used in the VR-601U must be replaced by a JVC authorized service dealer only.

WARNING:
The installation of this equipment should be made by a qualified service person and should conform to all local codes.

Cet appareil numérique de la Classe A respecte toutes les exigences du Règlement sur le matériel brouilleur du Canada.

INFORMATION

This equipment has been tested and found to comply with the limits for a Class A digital device, pursuant to Part 15 of the FCC Rules. Operation of this equipment may cause interference with other radio communication equipment. This equipment is designed for use in a commercial environment. This equipment generates, uses, and can radiate radio frequency energy and, if not installed and used in accordance with the instruction manual, may cause harmful interference with radio communications. Operation of this equipment in a residential area is likely to cause harmful interference in which case the user will be required to correct the interference at his own expense.

CAUTION
CHANGES OR MODIFICATIONS NOT APPROVED BY JVC COULD VOID USER'S AUTHORITY TO OPERATE THE EQUIPMENT.

This Class A digital apparatus meets all requirements of the Canadian Interference-Causing Equipment Regulations.

CAUTION
Risk of explosion if replaced by an incorrect type. Dispose of used batteries according to the instructions.

REMARQUE:
La plaque d'identification (numéro de série) se trouve sur le panneau arrière de l'appareil.

WARNING:
The battery used in the VR-601U must be replaced by a JVC authorized service dealer only.

WARNING:
The installation of this equipment should be made by a qualified service person and should conform to all local codes.

Cet appareil numérique de la Classe A respecte toutes les exigences du Règlement sur le matériel brouilleur du Canada.

SAFETY PRECAUTIONS (FOR EUROPE AND AUSTRALIA)

Warning Notice FOR YOUR SAFETY (Australia)

1. Insert this plug only into effectively earthed three-pin power outlet.
2. If any doubt exists regarding the earthing, consult a qualified electrician.
3. Extension cord, if used, must be three-core correctly wired.

IMPORTANT (In the United Kingdom) Mains Supply (AC 230 V) WARNING – THIS APPARATUS MUST BE EARTHED

The wires in this mains lead are coloured in accordance with the following code:

GREEN-and-YELLOW : EARTH
BLUE : NEUTRAL
BROWN : LIVE

As the colours of the wires in the mains lead of this apparatus may not correspond with the coloured markings identifying the terminals in your plug, proceed as follows.

The wire which is coloured GREEN-AND-YELLOW must be connected to the terminal in the plug which is marked with the letter E or by the safety earth symbol or coloured GREEN or GREEN-AND-YELLOW. The wire which is coloured BLUE must be connected to the terminal which is marked with the letter N or which is coloured BLOCK. The wire which is coloured BROWN must be connected to the terminal which is marked with the letter L or coloured RED.

POWER SYSTEM

Connection to the mains supply

This unit operates on voltage of 220 V to 240 V AC, 50 Hz/60Hz.

WARNING:

TO REDUCE THE RISK OF FIRE OR ELECTRIC SHOCK, DO NOT EXPOSE THIS APPLIANCE TO RAIN OR MOISTURE.

CAUTION

To prevent electric shock, do not open the cabinet. No user serviceable parts inside. Refer servicing to qualified service personnel.

Note:

The rating plate and the safety caution are on the rear of the unit.

The OPERATE button does not completely shut off mains power from the unit, but switches operating current on and off.

WARNING

It should be noted that it may be unlawful to rerecord pre-recorded tapes, records, or discs without the consent of the owner of copyright in the sound or video recording, broadcast, or cable programme and in any literary, dramatic, musical or artistic work embodied therein.

CAUTION

RED colour indications on the operation panel are provided but they are not safety related. RED colour indications:
(1) For Recording Button.

Caution for AC Mains Lead

FOR YOUR SAFETY PLEASE READ THE FOLLOWING TEXT CAREFULLY.
Appropriate mains cable must be used in each local area.

FOR U.K. ONLY
If the plug supplied is not suitable for your socket outlet, it should be cut off and appropriate one fitted.



SAFETY PRECAUTIONS

Place of storage and use

Please avoid storing or using this DVR in the following places:

- Extremely hot or cold places beyond the allowable temperature for operation (5°C – 40°C).
- Humid or dry places beyond the allowable humidity range for operation (30% –80% RH).
- Dusty or sandy places.
- Places exposed to oil, smoke or steam, such as the kitchen vicinity.
- Intensely vibrating or unstable places.
- Places prone to condensation.
- Places that generate strong magnetic fields, e.g., transformer or motor.
- Places near devices that generate electric waves, e.g., transceiver or mobile phone.
- Places that generate radiation, X-rays or corrosive gases.

Maintaining the unit (Please turn off the power before performing maintenance work.)

Please wipe the unit with a soft cloth. Do not wipe it with thinner or benzene lest the surface melts or becomes dull. For stubborn stains, wipe first with a water-diluted neutral detergent and then wipe dry.

Please use the provided AC adapter to connect the DVR to a power source.

Please use the supplied power cord. Using a different type or damaged cord may cause fire or electric shock.

Hard-disk

The hard-disk is a consumable item. Replacement is recommended after 10000 hours of use (if used in a 25° C environment). For information on maintenance planning and costs, consult your nearest JVC dealer.

To save energy, be sure to turn off the system when not in use.

Handling the unit

- Please do not place heavy objects on the DVR, like a monitor or TV.
- Please keep the mobile rack into the compartment. As injury may result from fingers getting clamped.
- Please do not block the ventilation openings.
- Avoid violent shocks to the unit. Do not drop the unit.
- Please remove the AC adapter to save energy when the unit is not in use.

■ AC adapter section

IMPORTANT SAFETY INSTRUCTIONS

- 1) Read all of these instructions.
- 2) Keep these instructions.
- 3) Heed all warnings.
- 4) Follow all instructions.
- 5) Do not use this apparatus near water.
- 6) Clean only with dry cloth.
- 7) Do not block any ventilation openings. Install in accordance with the manufacturer's instructions.
- 8) Do not install near any heat sources such as radiators, heat registers, stoves, or other apparatus (including amplifiers) that produce heat.
- 9) Do not defeat the safety purpose of the polarized or grounding-type plug. A polarized plug has two blades with one wider than the other. A grounding type plug has two blades and a third grounding prong. The wide blade or the third prong are provided for your safety. If the provided plug does not fit into your outlet, consult an electrician for replacement of the obsolete outlet.
- 10) Protect the power cord from being walked on or pinched particularly at plugs, convenience receptacles, and the point where they exit from the apparatus.
- 11) Only use attachments/accessories specified by the manufacturer.
- 12) Use only with the cart, stand, tripod, bracket, or the table specified by the manufacturer, or sold with the apparatus.



When a cart is used, use caution when moving the cart/apparatus combination to avoid injury from tip-over.

- 13) Unplug this apparatus during lightning storms or when unused for long periods of time.
- 14) Refer all servicing to qualified service personnel. Servicing is required when the apparatus has been damaged in any way, such as power-supply cord or plug is damaged, liquid has been spilled or objects have fallen into the apparatus, the apparatus has been exposed to rain or moisture, does not operate normally, or has been dropped.

WARNING - To reduce the risk of fire or electric shock, do not expose this apparatus to rain or moisture. Apparatus shall not be exposed to dripping or splashing and no objects filled with liquids, such as vases, shall be placed on the apparatus.

CAUTION - These servicing instructions are for use by qualified service personnel only. To reduce the risk of electric shock, do not perform any servicing other than that contained in the operating instructions unless you are qualified to do so.

Table Of Contents

1. PRODUCT FEATURES	9
1.1 <i>Product Introduction</i>	9
1.2 <i>Product Features</i>	9
2. DESCRIPTION OF THE FRONT/REAR VIEW	10
2.1 <i>Front View</i>	10
2.2 <i>Rear View</i>	12
2.3 <i>ALARM In/Out</i>	13
3. INSTALLATION	14
3.1 <i>Basic Connection</i>	14
3.2 <i>Hard-Disk Drive Installation</i>	18
3.3 <i>System Information</i>	19
3.4 <i>Updating System Software</i>	20
4. BASIC OPERATIONS	21
4.1 <i>Configuring Recording Settings</i>	21
4.2 <i>Recording Operations</i>	24
4.3 <i>Playback Operations</i>	29
4.4 <i>Search Operations</i>	31
4.5 <i>Backup Operations</i>	35
4.6 <i>Key Lock Operation</i>	38
5. MENU SETUP	39
5.1 <i>REC-SETTING</i>	40
5.2 <i>ALARM SETTING</i>	41
5.3 <i>CLOCK / TIMER</i>	44
5.4 <i>COMMUNICATION</i>	45
5.5 <i>DISK SETTING</i>	48
5.6 <i>SYSTEM</i>	49

6. RS-232 & RS-485 PROTOCOL.....	52
6.1 Setup.....	52
6.2 Communication Protocol.....	52
7. MOBILE RACK INSTALLATION	55
8. SYSTEM DEFAULT.....	58
9. O.S.D MESSAGE.....	60
10. NETWORK VIEWER AND IMAGE VIEWER.....	61
10.1 The Network Viewer.....	61
10.2 The Image Viewer.....	69
11. INDEX TABLE.....	70
12. NETWORK CONFIGURATION	71
12.1 Cable Connections.....	71
12.2 Configure Your DVR Network Settings	72
12.3 TCP/IP Communication Software.....	74
12.4 TCP/IP installation	76
12.5 TCP/IP Configuration setting	76
12.6 Connection Testing.....	77
13. SPECIFICATIONS.....	79
14. COMPATIBLE MULTIPLIXERS	80

1. PRODUCT FEATURES

1.1 Product Introduction

This DVR is a storage media of digital video image, which uses hard-disk drives instead of VCR tapes to store video. It enables you to enjoy the extreme flexibility of digital image archiving instead of clumsy tape management, and is compatible with most multiplexers in the market. Equipped with a range of comprehensive features, such as playback picture-by-picture, quick access video recording by time and event, the upgradeable software of the system, the expandable capacities of hard drive, and much more, the DVR will make your applications far more flexible and effective than ever before. For all, the DVR is going to prove the timely substitute for Time-lapse VCR.

1.2 Product Features

- * Stores video in hard-disk drives instead of VCR tapes.
- * Maximum 2 hard-disk drive capability. (One removable)
- * Hard-disk drive hot-swapping capability.
- * Pre-alarm image recording.
- * Capable of working with various known multiplexers.
- * Time-lapse and real-time recording.
- * Refresh rate up to 60 IPS (60 IPS for PAL).
- * Image quality selectable at 4 different levels for recording.
- * Event/Timer/Alarm recording mode.
- * Quick search by time, alarm, event, and recording list.
- * Fast and slow playback of recorded video at various speeds.
- * Single-picture playback.
- * On-screen setup menu, title and system timer.
- * Password protection.
- * Disk-full warning and operation status LEDs.
- * RS-232, RS-485 communication port.
- * Remote control via RS-232, RS-485 and Ethernet ports
- * Power interruption recovery.
- * Operation-status record log.
- * Distributing live and recorded images through TCP/IP network environment.
- * Audio function included
- * Built-in SD card slot for copying image to SD card
- * Support DHCP protocol.

2. DESCRIPTION OF THE FRONT/REAR VIEW

2.1 Front View

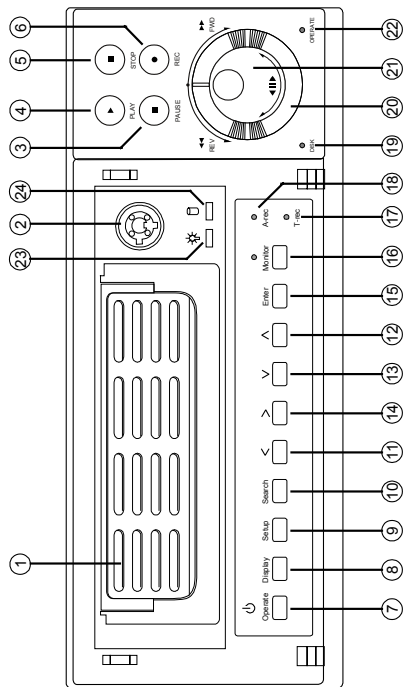

- 10 **Search button:**
Press to enter the search mode to access recorded video.
- 11,14 **Left / Right buttons:**
Press the two buttons to highlight desired items in the menu setup mode. For **Key Lock** operation, press these two buttons simultaneously once; to disable **Key Lock**, press these two buttons simultaneously again.
- 12,13 **Up / Down buttons:**
Press these two buttons to select the desired contents for programming in the setup menu mode.
- 15 **Enter Button:**
Press to enter a selected item and save the setting in the menu setup mode.
- 16 **Monitor button:**
Press to switch between a multiplexer-decoded video and the encoded video to be displayed when connected with a multiplexer. When the button light is on it indicates the unit is displaying the decoded video.(The images are not multiplexing.) In this mode, the unit doesn't display the OSD message of the unit on the screen. However, this doesn't affect the unit's OSD message which is recorded into hard-disk drives. When the button light is off it indicates the unit is displaying encoded video. (The images switch swiftly).
- 17 **T-rec Indicator:**
This indicator of the timer recording mode lights up to signal the scheduled record setting is on.
- 18 **A-rec Indicator:**
This indicator of the alarm recording mode lights up to indicate the alarm record setting is on.
- 19 **DISK Indicator:**
The indicator shows the operation status of the unit's hard-disk drives. The green light indicates the hard-disk drive is storing or retrieving data. The red light signals the hard-disk drive is filling up. The orange light indicates the hard-disk is retrieving data at disk-full status.
- 20 **Shuttle Ring:**
The shuttle can be moved forward and backward for playback in either direction. Turn this left to play a recorded video in the reverse direction at faster or slower speeds than the recorded speed. Turn this right to play a recorded video in the forward direction at faster or slower speeds than the recorded speed.
- 21 **Jog Dial:**
This dial can act in both a forward and a backward direction, as well as step by step. Turn this left to play a recorded video in the reverse direction. Turn this right to play a recorded video in the forward direction.
- 22 **OPERATE Indicator:**
Indicates the power status of the unit. The green light indicates the hard-disk drive is activating. The orange light signals the hard-disk drive is power stand by.
- 23 **Mobile Rack Power LED:**
Indicates the power status of the Mobile Rack. The green light indicates the Mobile Rack is activating.
- 24 **Mobile Rack HDD LED:**
Indicates the HDD status of the Mobile Rack. The orange light indicates the HDD is storing or retrieving data.

- 1 **Hard-disk drive compartment.**
The compartment allows you to install a hard-disk drive mostly for backup purposes. Make sure the drive is well secured with the mounting screws in the mobile rack before you put the rack into the compartment. And remember to turn on the power of the compartment by locking it.
- 2 **Hard-disk compartment lock:**
The key lock secures a hard-disk in place. Unlock the compartment before you remove the hard-disk from the slot without turning off the device.
- 3 **PAUSE button:**
In a playback display, press this to freeze the display. During the freeze, press to display one frame/field of a picture at a time in the forward direction. (Illuminate green in PAUSE mode.)
- 4 **PLAY button:**
Press to play back a recorded video from the hard-disk. (Illuminate green in PLAY mode.)
- 5 **STOP button:**
Press to stop playing back a recorded video or recording video into a hard-disk. (Illuminate green in STOP mode.)
- 6 **REC button:**
Press to start recording video into a hard-disk while in the live display mode. (Illuminate red in REC mode.)
- 7 **OPERATE button:**
Press this button for at least 3 seconds to power off. Press again to activate the device.
- 8 **DISPLAY button:**
Press to show the system operation status on the screen.
- 9 **Setup button:**
Press this to enter the setup menu. Press again to exit the setup mode.

2.2 Rear View

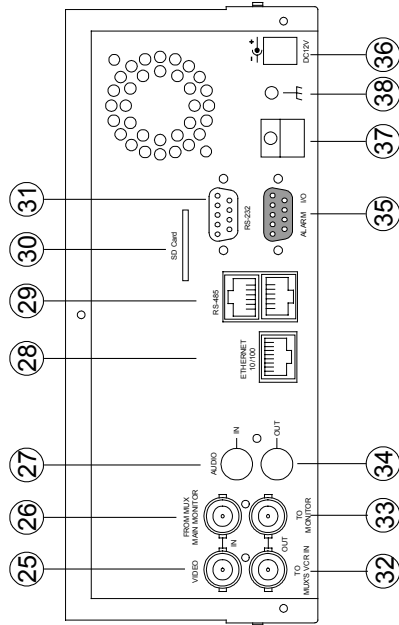

- 25 **VIDEO IN Connector:** This BNC connector is used to connect the video output from a camera or a MUX to the DVR.
- 26 **FROM MUX MAIN MONITOR Connector:** This BNC connector is used to connect the live video output from a MUX to the DVR.
- 27 **AUDIO IN Connector:** This connector is used to connect the audio output from a camera, a MUX or other devices to the DVR.
- 28 **ETHERNET 10/100 Connector:** This is one standard RJ-45 connector for 10/100 Mbps Ethernet networks.
- 29 **RS-485 Port:** The RS-485 communication ports function as connectors when two or more units are serially connected to expand the storage capacity.
- 30 **SD CARD Slot:** This is used for system software updating and archiving/accessing critical images.
- 31 **RS-232 Port:** The RS-232 communication port functions as a connector to an external control device. Please refer to **RS-232 & RS-485 Protocol** for more details.
- 32 **VIDEO OUT Connector:** The connector provides the unit's composite video signals to a MUX.
- 33 **MONITOR Connector:** The connector provides the unit's composite video or a MUX's live signal if connected to a display device.
- 34 **AUDIO OUT:** This provides the unit's audio signal to a speaker.
- 35 **ALARM I/O:** This is a 9-PIN D-SUB connector including **SWITCH OUT**, **GROUND**, **ALARM OUT**, **DISK FULL**, **RECORD IN**, **ALARM RESET**, and **ALARM IN** for connecting with external devices. Please refer to the next section for details.
- 36 **Plug Inlet:** The inlet connects to an external power supply. Connect 12 V DC UL Listed Class 2 Power Supply.
- 37 **Wire Catch:** The wire catch secures the power cord and keeps it in place (so that it does not droop or hang loosely).
- 38 **Ground Screw's:** The ground screw is for chassis terminal.

2.3 ALARM In/Out

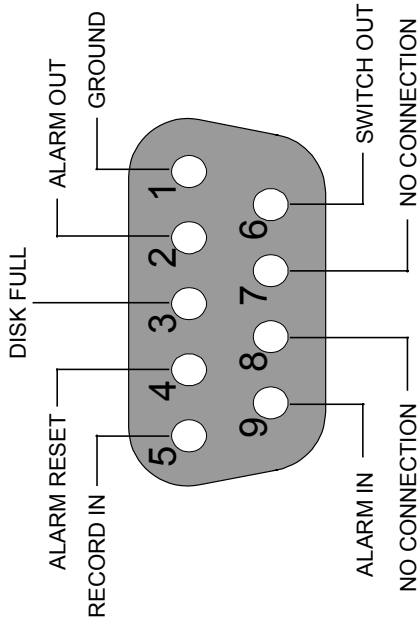

***THIS FIGURE IS LOOKED FROM THE REAR**

1. **GND:** Ground Contact.
2. **ALARM OUT (OUTPUT):** This is an alarm output trigger. Connect this to external devices such as buzzers or lights. (..... 0V/5V)
3. **DISK FULL (OUTPUT):** This is a disk full output trigger. Connect this to external devices such as buzzers or lights. (..... 0V)
4. **ALARM RESET (INPUT):** This pin connects to an alarm-clear device for clearing an alarm. (..... 0V)
5. **RECORD IN (INPUT):** This pin connects to a record trigger device for starting a record. (..... 0V)
6. **SWITCH OUT (OUTPUT):** This pin, sending out timing signals (falling / negative) to a multiplexer, connects to a multiplexer's trigger terminal so the multiplexer can switch to use the same recording speed as the DVR.
7. **NO CONNECTION**
8. **NO CONNECTION**
9. **ALARM IN (INPUT):** This is an alarm input which can be programmed in the menu system to Normally Open or Normally Closed. (..... 0V)

3. INSTALLATION

Please follow the instructions and the diagram below to set up the system.

3.1 Basic Connection

CONNECTING TO THE AC ADAPTER

Connect the provided AC adapter to the main unit.

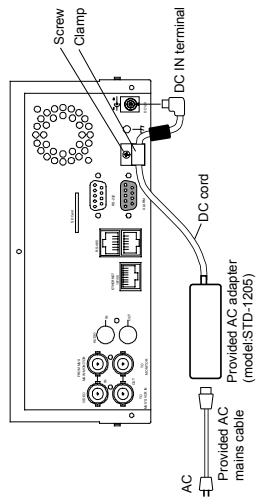

1. Connect the DC cord of the AC adapter to the DC IN terminal of the main unit.
 2. To prevent accidental disconnection of the DC cord, fasten the DC cord with a wire catch.
 - 1) Remove 1 screw followed by the wire catch.
 - 2) Insert the DC cord into the wire catch and fasten the wire catch unto the main unit.
 3. Connect the provided power cord to the AC IN terminal of the AC adapter.
 4. Connect the power cord to the power socket.
 - Power is channelled into the unit and the OPERATE indicator lights up green.
 - Press OPERATE button (7) for at least 3 seconds to power off and the OPERATE indicator lights up orange. (OPERATE OFF mode)
- The orange light signals the hard-disk drive is power stand by.

Memo

- Even in the OPERATE OFF mode, a small amount of electricity will still flow into the unit.
- When the unit is in the OPERATE OFF mode, no operation can be performed except that of the OPERATE button.
- It might show an error message "DATA ERROR" and stop recording when the condition of main power is not stable. When this is assumed, please use an uninterruptible power supply (UPS). When an error message is displayed, please reboot the VR-601 by turning the operation button OFF and ON, or unplugging and plugging the AC power line.

* About the location of the buttons, please refer to Page 10 2.1 Front View.

Note:

- Please supply power to the unit via the provided AC adapter. Do not use other power sources.
- During recording or playback, please do not unplug the DC or power cord.

CONNECTING WITH A SINGLE CAMERA

Please set the MULTIPLEXER option to OFF on the REC SETTING page in the setup menu when it is connected with a single camera. (Please refer to section 5.1 MULTIPLEXER option)

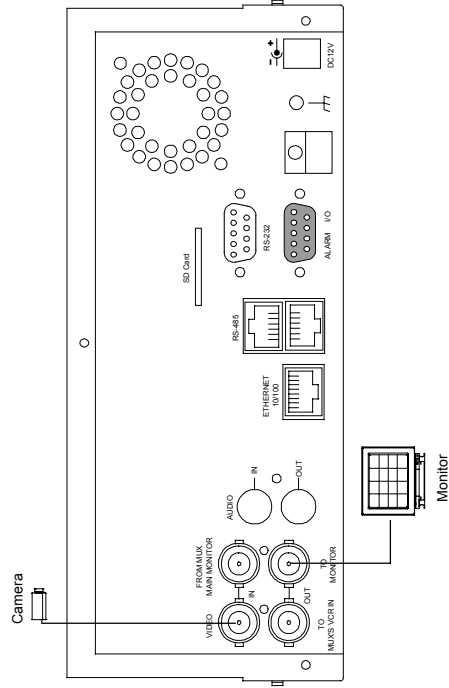

CONNECTING WITH A MULTIPLEXER

To match the multiplexer's recording speed, please set the MULTIPLEXER option to ON on the REC SETTING page in the setup menu when it is connected with a multiplexer. (Please refer to section 5.1 MULTIPLEXER option)

Caution: Some multiplexers may cause non-updated playback output. In such a case, please set recording rate at 60 F/IS or 20 F/IS.

CONNECTING WITH A QUAD

Please set the **MULTIPLIER** option to **OFF** on the **REC SETTING** page in the setup menu when it is connected with a quad. (Please refer to section 5.1 MULTIPLIER option)

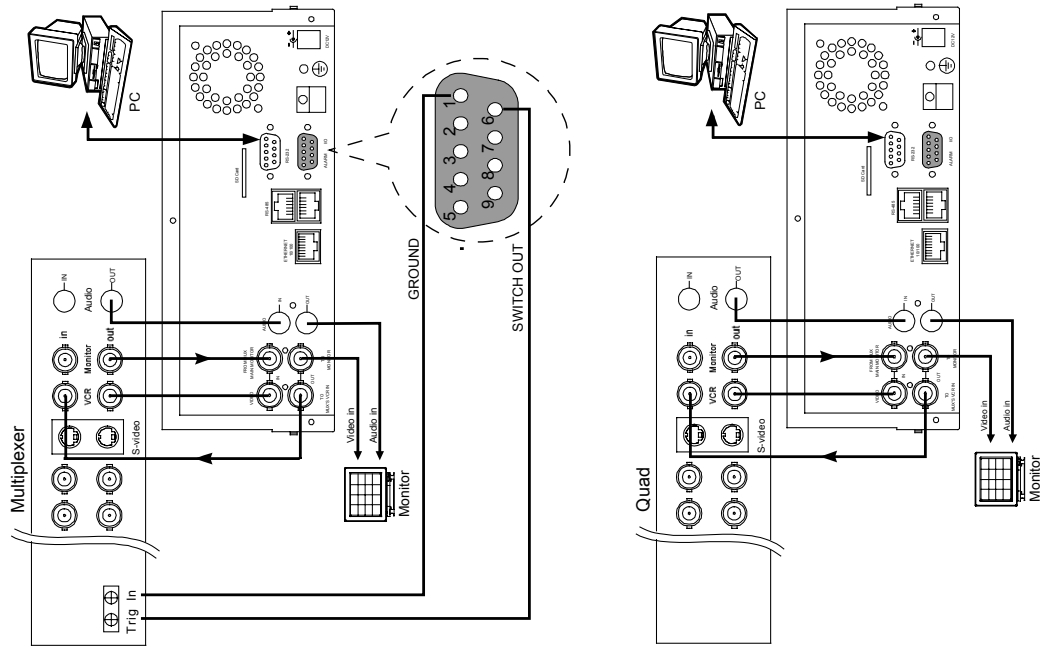

ATTACHING AN EXTERNAL DEVICE TO DVR

Connect an alarm out, alarm input, and a peripheral device as shown in the diagram below.

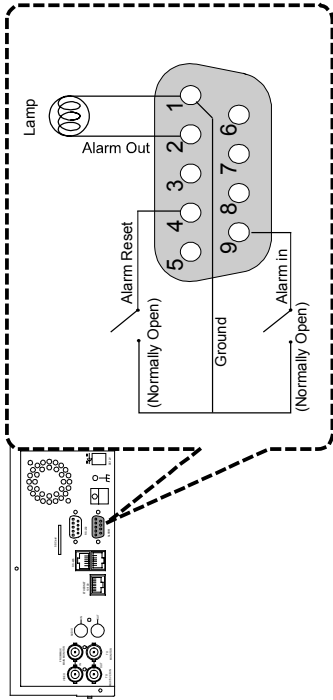

CLOCK SET

Please set the clock before operating the DVR. (For operation details, please refer to section 5.3 CLOCK/TIMER)

3.2 Hard-Disk Drive Installation

The DVR is equipped with two compartments of hard-disk drive. The unit usually comes with one hard-disk drive installed in the compartment HD1, which is default-configured as a master. If you need a second hard-disk drive to be installed in the compartment HD2 (Mobile), please contact your distributors or installers for specific instructions on how to install it. Please don't serve yourself before consulting your installers. If there is only one hard-disk drive in the mobile compartment, please set the **HD2 USAGE** option to **REC** (Please refer to section 5.5) before proceed recording function. The jumper-settings arrangement of installed hard-disk drives for the system (Table 3.2 A.) is shown in the tables below.

Table 3.2 A. The jumper settings of hard-disk drives in the system

	Location	Jumper
IDE 1	Compartment HD 1	Master (Default)
IDE 2	Compartment HD 2	Master

Table 3.2 B. Compatible hard-disk drives

Manufacturer	Model	Capacity	Rotation
Seagate	ST380020A/P	80GB	5400 RPM
	ST340810A/P	40GB	5400 RPM
Maxtor	4A160J0-1A	160GB	5400 RPM
	4R080L0-1	80GB	5400 RPM
	6Y120L0-1	120GB	7200 RPM

NOTE: Hard-disk drives not shown on this list have not been tested by the engineering team and are not recommended for use with this product. For the latest updated list on the recommended hard-disk drives, please contact your dealers or distributors.

3.3 System Information

You can display system settings information as shown on **Table 3.3 A** below at any time by pressing the **Display** button (8). In the playback mode, the recorded video information is displayed. In the live or recording mode, the Manual Recording information is displayed. However, when the DVR is displaying a decoded image from a multiplexer, you must first switch the unit to encoded image displaying (The pictures is switching swiftly and the light of **Monitor** button (6) is off) by pressing the **Monitor** button (6). Each sequential press of the **Display** button (8) displays a different message detailed in the following example. By default, the unit displays time, date, and an indicating bar of capacity status on a monitor as shown next.

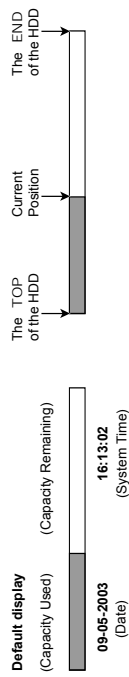

Press the **Display** button (8) once; the DVR will display the following sample message plus the default display. Press the **Display** button (8) again; the unit will not display any OSD message. Press the button one more time to back to the default display.

Table 3.3 A.

1+2: 59G	12.4 HR	NTSC	20 F/S	MUX: OFF	9K
QUALITY: BEST					
RATE: 6 HR					
HD	P	SIZE	POS		
1	Y	20 G	39.5% P		
2	Y	39 G	0.0% R		
IP : 192 . 168 . 1 . 90					
					09 . 05 . 2003 16:13:02

Description of Table 3.3 A

- (1+2: 59G): Total capacity of installed hard-disk, 59 GB
- (12.4 HR): Total 12.4 hour recording time available
- (NTSC): Timer record activated
- (20 F/S): Alarm record activated
- (MUX: OFF): Record quality setting, BEST
- (9K): NTSC system
- (RATE: 6 HR): Setting of Record time mode, 6 hours
- (20 F/S): Record speed setting, 20 fields/sec
- (MUX: OFF): Only connected to a single camera.
- (1): Audio function activated
- (2): Indicate which HDD is activated
- (9K): The image file size
- (HD): Hard-disk Compartment
- (P): Y: Hard-disk installed; . No hard-disk installed
- (SIZE 20G): The capacity of the installed hard-disk
- (POS): Percentage of system; R: Recording; P: Playback
- (IP : 192 . 168 . 1 . 90): Setting of the Ethernet communication; 192.168.1.90
- (1): External signal
- (2): Cannot operate at now

* About the location of the buttons, please refer to Page 10 2.1 Front View.

3.4 Updating System Software

If the system software of the DVR needs to be upgraded, please contact your JVC dealer.

4. BASIC OPERATIONS

This section shows you how to operate and manage the DVR when it gets in the way.

4.1 Configuring Recording Settings

Recording Time settings (Recording Rate and Picture Quality Setting)

Recording time will vary depending on the image size, recording rate, and the capacity of the hard-disk drives. Generally, the DVR comes with a built-in hard-disk drive for continuous recording from one to four weeks under most recording conditions. The table below shows the possible recording times based on a 80GB hard-disk drive at certain refresh rates and the corresponding image quality. With one or more hard-disk drive(s) in operation, please calculate the recording time using the table below in accordance with your requirement. For a NTSC unit, for example, if the unit is set to record images with **BEST** quality at a **60 fps** record rate, normally a 80GB hard-disk drive will be filled in 15 hours (See the gray area in the table). If the total capacity of 240GB hard-disk drives is in use under the same refresh rate and picture quality, it will be filled in 45 hours (3 times the rate of a 80GB hard-disk drive).

Set up the REC Time Mode when a multiplexer is connected

If a multiplexer is connected, for optimum image recording and playback, the record speed of the multiplexer must be correctly adjusted to match the DVR and set the **MULTIPLEXER** option on the setup menu to **ON**. This can be done by either of methods detailed below.

Connect the SW. OUT terminal in 9-PIN D-SUB connector on the rear panel of the DVR to the multiplexer's trigger contact. The DVR will provide the timing signal (Negative/Falling) to the multiplexer. Thus, if the DVR changes the recording speed, the multiplexer will automatically adjust the record to match. A 2-hour and 4-hour timing signal in NTSC or a 3-hour and 6-hour one in PAL is constantly negative/falling.

NTSC (MUX ON) Audio ON	Possible Recording Time HDD=80GB (hour)									
	-	-	44.4	95.8	208.5	380.6	598.5	-	-	-
Image Quality	BEST	-	-	-	-	-	-	-	-	-
	HIGH	-	-	55.3	118.8	255.7	459.6	708.9	-	-
	STANDARD	-	-	73.2	156.1	330.5	580.0	869.5	-	-
	BASIC	-	-	108.4	227.6	467.3	785.9	1124.0	-	-
Refresh Rate (Field/Sec)	60	30	20	12	5.5	2.4	1.22	0.71	1/4	1/8
REC Time Mode	2 hr	4 hr	6 hr	12 hr	24 hr	48 hr	96 hr	168 hr	480 hr	960 hr

NTSC (MUX ON)		Possible Recording Time HDD=80GB (hour)										
Audio OFF		15.0	18.0	27.1	45.1	99.3	225.9	442.7	768.0	2177.7	3262.0	4346.4
Image Quality	BEST	-	-	-	-	-	-	-	-	-	-	-
	HIGH	18.0	22.5	33.8	56.4	124.2	282.3	553.4	960.1	2722.1	4077.6	5433.0
	STANDARD	22.5	30.1	45.1	75.3	165.6	376.5	737.9	1280.1	3629.5	5436.8	7244.0
Refresh Rate (Field/Sec)	BASIC	30.1	45.1	67.7	112.9	248.4	564.7	1106.9	1920.2	5444.3	8155.2	10866.1
		60	30	20	12	5.5	2.4	1.22	0.71	1/4	1/6	1/8
REC Time Mode		2 hr	4 hr	6 hr	12 hr	24 hr	48 hr	96 hr	168 hr	480 hr	720 hr	960 hr

NTSC (MUX OFF)		Possible Recording Time HDD=80GB (hour)										
Audio ON		15.0	18.0	27.1	45.1	99.3	225.9	442.7	768.0	2177.7	3262.0	4346.4
Image Quality	BEST	-	-	-	-	-	-	-	-	-	-	-
	HIGH	18.0	22.5	33.8	56.4	124.2	282.3	553.4	960.1	2722.1	4077.6	5433.0
	STANDARD	22.5	30.1	45.1	75.3	165.6	376.5	737.9	1280.1	3629.5	5436.8	7244.0
Refresh Rate (Field/Sec)	BASIC	30.1	45.1	67.7	112.9	248.4	564.7	1106.9	1920.2	5444.3	8155.2	10866.1
		60	30	20	12	5.5	2.4	1.22	0.71	1/4	1/6	1/8
REC Time Mode		2 hr	4 hr	6 hr	12 hr	24 hr	48 hr	96 hr	168 hr	480 hr	720 hr	960 hr

NTSC (MUX OFF)		Possible Recording Time HDD=80GB (hour)										
Audio OFF		15.0	18.0	27.1	45.1	99.3	225.9	442.7	768.0	2177.7	3262.0	4346.4
Image Quality	BEST	15.0	18.0	36.1	54.2	108.4	234.9	451.8	777.1	2186.7	3271.1	4355.4
	HIGH	18.0	22.5	45.1	67.7	135.5	293.6	564.7	971.3	2733.4	4088.9	5444.3
	STANDARD	22.5	30.1	60.2	90.3	180.7	391.5	753.0	1295.1	3644.6	5451.8	7259.1
Refresh Rate (Field/Sec)	BASIC	30.1	45.1	90.3	135.5	271.0	587.3	1129.5	1942.7	5466.9	8177.8	10888.6
		60	30	20	12	5.5	2.4	1.22	0.71	1/4	1/6	1/8
REC Time Mode		2 hr	4 hr	6 hr	12 hr	24 hr	48 hr	96 hr	168 hr	480 hr	720 hr	960 hr

PAL (MUX ON)		Possible Recording Time HDD=80GB (hour)										
Audio ON		15.4	18.0	27.1	45.1	99.3	225.9	442.7	768.0	2177.7	3262.0	4346.4
Image Quality	BEST	-	-	-	-	-	-	-	-	-	-	-
	HIGH	18.0	22.8	34.2	57.0	102.7	194.0	376.6	650.6	2294.2	3435.6	4577.1
	STANDARD	22.8	30.9	46.4	77.4	139.4	263.3	511.1	882.9	3113.6	4662.7	6211.7
Refresh Rate (Field/Sec)	BASIC	30.9	45.6	68.4	114.1	205.4	388.0	753.3	1301.2	4588.5	6871.3	9154.2
		50	25	17	10	5.5	2.9	1.52	0.88	1/4	1/6	1/8
REC Time Mode		3 hr	6 hr	9 hr	12 hr	24 hr	48 hr	96 hr	168 hr	480 hr	720 hr	960 hr

PAL (MUX ON)		Possible Recording Time HDD=80GB (hour)										
Audio OFF		15.4	18.0	27.1	45.1	99.3	225.9	442.7	768.0	2177.7	3262.0	4346.4
Image Quality	BEST	-	-	-	-	-	-	-	-	-	-	-
	HIGH	18.0	22.8	34.2	57.0	102.7	194.0	376.6	650.6	2294.2	3435.6	4577.1
	STANDARD	22.8	30.9	46.4	77.4	139.4	263.3	511.1	882.9	3113.6	4662.7	6211.7
Refresh Rate (Field/Sec)	BASIC	30.9	45.6	68.4	114.1	205.4	388.0	753.3	1301.2	4588.5	6871.3	9154.2
		50	25	17	10	5.5	2.9	1.52	0.88	1/4	1/6	1/8
REC Time Mode		3 hr	6 hr	9 hr	12 hr	24 hr	48 hr	96 hr	168 hr	480 hr	720 hr	960 hr

PAL (MUX OFF)		Possible Recording Time HDD=80GB (hour)										
Audio ON		15.4	18.0	27.1	45.1	99.3	225.9	442.7	768.0	2177.7	3262.0	4346.4
Image Quality	BEST	-	-	-	-	-	-	-	-	-	-	-
	HIGH	18.0	22.8	34.2	57.0	102.7	194.0	376.6	650.6	2294.2	3435.6	4577.1
	STANDARD	22.8	30.9	46.4	77.4	139.4	263.3	511.1	882.9	3113.6	4662.7	6211.7
Refresh Rate (Field/Sec)	BASIC	30.9	45.6	68.4	114.1	205.4	388.0	753.3	1301.2	4588.5	6871.3	9154.2
		50	25	17	10	5.5	2.9	1.52	0.88	1/4	1/6	1/8
REC Time Mode		3 hr	6 hr	9 hr	12 hr	24 hr	48 hr	96 hr	168 hr	480 hr	720 hr	960 hr

PAL (MUX OFF)		Possible Recording Time HDD=80GB (hour)										
Audio OFF		15.4	18.0	27.1	45.1	99.3	225.9	442.7	768.0	2177.7	3262.0	4346.4
Image Quality	BEST	15.4	18.0	36.1	54.2	108.4	234.9	451.8	777.1	2186.7	3271.1	4355.4
	HIGH	18.0	22.8	45.6	68.4	114.1	205.4	388.0	662.0	2305.6	3447.0	4588.5
	STANDARD	22.8	30.9	61.9	92.9	154.9	278.8	526.6	898.4	3129.1	4678.2	6277.2
Refresh Rate (Field/Sec)	BASIC	30.9	45.6	91.3	136.9	228.2	410.9	776.1	1324.0	4611.3	6894.1	9177.0
		50	25	17	10	5.5	2.9	1.52	0.88	1/4	1/6	1/8
REC Time Mode		3 hr	6 hr	9 hr	12 hr	24 hr	48 hr	96 hr	168 hr	480 hr	720 hr	960 hr

NOTE: Recording times on the tables above are estimated. For actual available recording time of a recording configuration, please refer to the system information of the DVR. (Please refer to section 3.3 system information for more details.)

NOTE: No audio function at the refresh rate in NTSC: 60 fields/sec ~ 20 fields/sec, 1/4 fields/sec ~ 1/8 fields/sec.
No audio function at the refresh rate in PAL: 50 fields/sec ~ 17 fields/sec, 1/4 fields/sec ~ 1/8 fields/sec.

NOTE: An actual recording fields number could be less than the Refresh Rate on the table above.

** : For NTSC and Mux Off Mode, recording rate 20F/S would be actually 15 F/S, 12F/S would be actually 10 F/S, 5.5 F/S would be actually 5F/S.
For PAL and Mux Off Mode, recording rate 17F/S would be actually 12.5 F/S, 10F/S would be actually 8.3 F/S, 5.5 F/S would be actually 5F/S.
(This adjustment is to avoid image shaking during playback at the same speed)

4.2 Recording Operations

This section details the way to record video into hard-disk drives. Before commencing with the recording function, please configure the recording setting properly according to your needs.

4.2.1 Manual Recording

When the DVR is in live display mode, take the following steps to start recording:

- (1) In live display, press the **REC** button (6) to record video into a hard-disk drive with the corresponding programmed recording settings. The monitor should display a flashing **REC** message and the **REC** button (6) will light up indicating the DVR is in the recording status.
- (2) Press the **STOP** button (5) to stop recording any time.
- (3) To access just recorded video, please refer to section 4.4 for more details.

4.2.2 Timer Recording

Timer recording provides two periods of time each day in a weekly table which programs the DVR to turn on and off at specified times. This way the DVR will start and stop recording according to the programmed schedule. Please take the following steps to program the scheduled recording.

- (1) Press the **Setup** button (9) to enter the **MAIN MENU**.
- (2) Select the **CLOCK / TIMER** and press the **Enter** button (15) to enter the **CLOCK / TIMER** page.
- (3) Select the **TIMER - SET**.
- (4) Press the **Enter** button (15) to enter the **REC SCHEDULE** table.
- (5) ● You can set up by using the "<" button (11) and the ">" button (14) to locate the specific day/hour/minute and use the "A" button (12) and the "y" button (13) to set the day/hour/minute you wish.
 - You can also set up by using the **Shuttle Ring** and the **Jog Dial**. "⊖" is the equal of the "<" button (11), "⊕" is the equal of the ">" button (14), "⊙" is the equal of the "A" button (12) and "⊙" is the equal of the "y" button (13).
 - The time is displayed in a 24-hour clock format.
- (6) After scheduling is completed, press the **Enter** button (15) and set **OK** to save the setting or select **CANCEL** to leave the page without saving the settings.
- (7) To activate the programmed recording schedule, set the **REC ENABLE** to **ON**. As the scheduled recording is on, the red indicator of the Timer Record (17) will be on as well. To deactivate it, set to **OFF**.
- (8) Press the **STOP** button (5) during the scheduled recording to stop it at any time. If you wish to continue the scheduled recording, press the **REC** button (6) to proceed.

NOTE: You can proceed to start the scheduled recording from the current time if it is in the scheduled interlude as soon as setting is completed, and come out from menu to start recording.

NOTE: If you activate the recording function before the scheduled recording, the unit will operate recording as shown in the diagram below and keep those images in different files.



NOTE: The end time can set only a larger value than the start time. If the end time is set to 23:59, it is recordable to 0:00. If you perform Timer Recording ranging over the date, please divide timer schedule into two.

NOTE: LIVE images may be frozen. But, it isn't a failure.

* About the location of the buttons, please refer to Page 10.2.1 Front View.

4.2.3 Alarm Recording

Take the following steps to activate the programmed alarm recording. For **ALM OPERATION**, **REC RATE**, **REC QUALITY**, **AUDIO**, **ALM TYPE**, **ALM DURATION**, and **PRE-ALARM** settings, please refer to section 5.2 for more details.

- (1) Press the **Setup** button (9) to enter the **MAIN MENU**.
- (2) Select **ALARM** and press the **Enter** button (15) to enter the **ALARM SETTING**.
- (3) Set the desired **REC RATE**, **REC QUALITY**, **ALM TYPE**, and **ALM DURATION** for use. If audio is required, set **AUDIO** to **ON**. If pre-alarm recording is required, set **PRE-ALARM** to **ON**.
- (4) To activate the alarm recording, set **ALM OPERATION** to **ON**. To deactivate it, set **ALM OPERATION** to **OFF**.

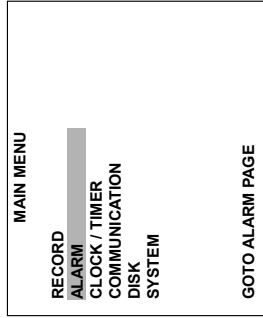
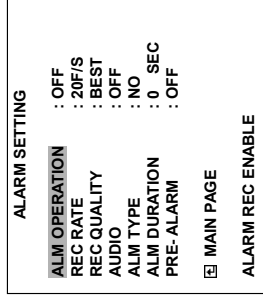
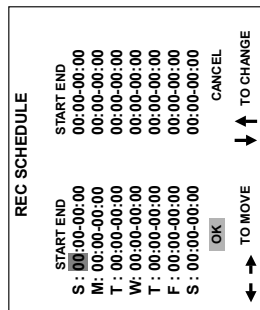
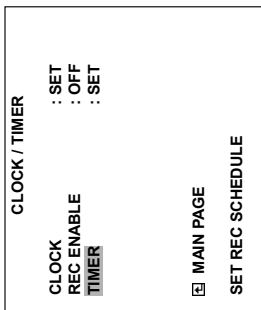
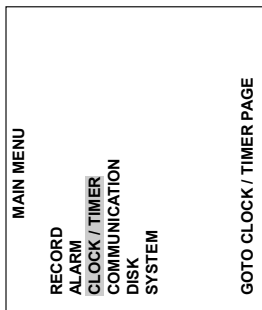
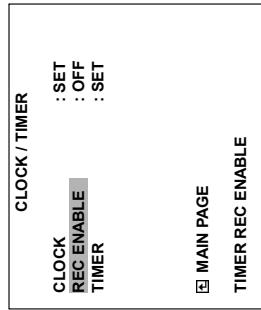
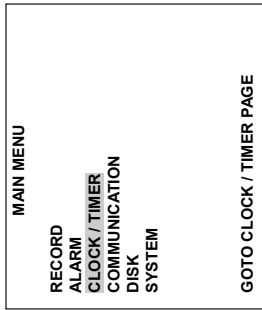

4.2.4 Externally triggered Recording

By connecting the **RECORD IN** of **ALARM I/O** on the rear panel of the DVR, you can activate/deactivate the recording function of a DVR. The file will be kept with a prefixed "R". Please refer to section 2.3 for more details.

* About the location of the buttons, please refer to Page 10 2.1 Front View.

NOTE: The status of recording operations when an alarm takes place are shown in the diagrams below.

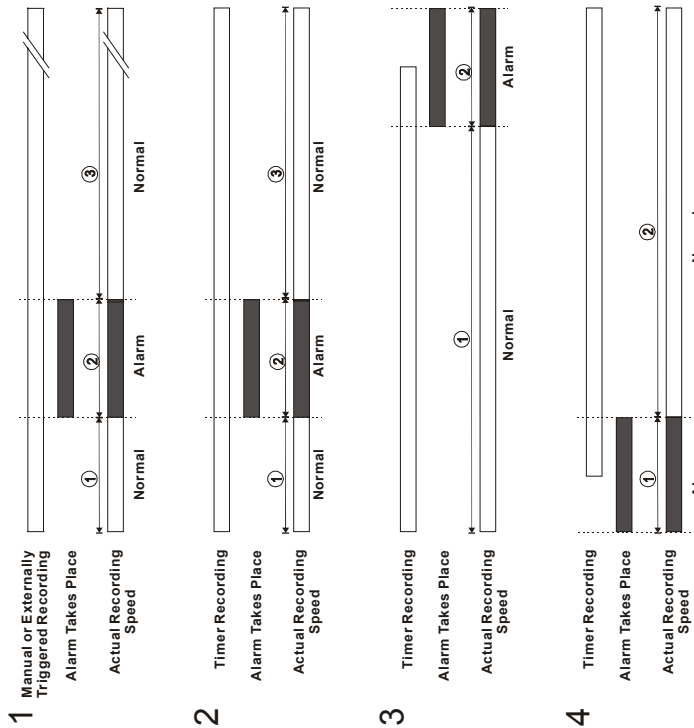

4.3 Playback Operations

This section shows you how to operate the fast, slow, and single-picture playback functions, and details how the unit is to playback a file in a different operation status. Please refer to the following paragraphs specifying the relevant details. When playing a file, the monitor should display a flashing **PLAY** message and the **PLAY** button ④ will light up indicating that the DVR is in the playback status.

Operation Status

A. From REC mode to Playback mode

(In live mode, directly press the **PLAY** button ④ to play a latest recorded video)

REC → (**STOP**) → (**PLAY**) Play the latest recorded file
 ▲ (Play to the end of the file) Show the ending message (use search functions or rewind to replay the file if required)
 ▲ (**STOP**) → (**PLAY**) Play the file from the stop position

B. Search to playback a particular recorded video

Search → (**PLAY**) Play a selected file
 ▲ (Play to the end of the file) Show the ending message (Search again or rewind to replay the file if required)
 ▲ (**STOP**) → (**PLAY**) Play the file from the stop position

C. Playback from the TOP of the HDD

(Stop: Press the "**STOP**" button for three seconds) → (**PLAY**) . Playback from the **TOP** of the HDD
 If HD2 USAGE set to **BACKUP**, playback starts from the **TOP** of the current HDD.
 If HD2 USAGE set to **REC**, playback starts from the **TOP** of HDD1.

4.3.1 Fast Forward/Reverse

There are 7 speeds available for playback: 1x, 2x, 4x, 8x, 16x, 30x and 100x
 While playing back recorded video at recorded speed:

Forward: Turn the Shuttle dial ⑳ to the right to view the recorded video in the forward direction at a speed faster than the recorded speed. Each subsequent turn of the shuttle to the right increases the forward rate, as 2x, 4x, 8x, 16x, 30x and 100x.

Reverse: Turn the Shuttle dial ⑳ to the left to view the recorded video in the reverse direction at a speed faster than the recorded speed. Each subsequent turn of the shuttle to the left increases the reverse rate, as -1x, -2x, -4x, -8x, -16x, -30x and -100x.

Normal: Release the Shuttle dial ⑳ to return to the normal speed of playback.
 * You can also operate by using "<" button ① and ">" button ④.

* About the location of the buttons, please refer to Page 10 2.1 Front View.

NOTE: When Normal playing a recorded video from a multiplexer at 60 F/S-30F/S

(50F/S~25F/S for PAL), the playback speed is half at recorded speed.

NOTE: The speed that is displayed is a standard. For example, while playing back the movie that is recorded by 60F/S (PAL, 50F/S) or recorded by complex alarm-in, the speed of

Fast Forward/Reverse may be slower than displayed speed.

NOTE: The playback speed will be displayed on the screen. However, when playing a recorded video from a multiplexer, the playback speed will only display in encoding (multiplexing) the mode. Press the Monitor button (16) to switch between decoding and encoding modes.

4.3.2 Slow Forward/Reverse

There are 4 speeds available for a slow playback: 1/2, 1/4, 1/8, 1/16.

While playing back recorded video at the recorded speed:

- (1) Press the PAUSE button (3) for the slow playback mode.
- (2) Forward: Turn the Shuttle dial (20) to the right to view the recorded video in the forward direction at a speed slower than the recorded speed. Each subsequent turn of the shuttle to the right increases the forward rate, as 1/2, 1/4, 1/8, and 1/16.
- (3) Reverse: Turn the Shuttle dial (20) to the left to view the recorded video in the reverse direction at a speed slower than the recorded speed. Each subsequent turn of the shuttle to the left increases the reverse rate, as -1/2, -1/4, -1/8, and -1/16.
- (4) Normal: Release the Shuttle dial (20) and then press the PLAY button (4) to return to the normal speed of playback.

* You can also operate by using “<” button (11) and “>” button (14).

4.3.3 Play Back Picture-by-picture

While playing back recorded video at the recorded speed:

- (1) Press the PAUSE button (3) for the picture-by-picture mode.
- (2) There are two ways, by PAUSE button or by JOG, available to play in the picture-by-picture mode, but the PAUSE button (3) can only function in a forward direction; the other, JOG dial (21), can act in both a forward and a backward direction, as well as picture-by-picture.

By PAUSE button (3):

Press the PAUSE button (3) to display one frame/field of a picture at a time in the forward direction. (When playing back video recorded by a multiplexer, each sequential press of the PAUSE button (3) will display each camera in sequence.)

By JOG dial (21):

Turn the JOG dial (21) clockwise to display one frame/field of a picture at a time in the forward direction. Turn the JOG dial (21) counterclockwise to display one frame/field of a picture at a time in the backward direction.

- (3) Press the PLAY button (4) to return to the normal speed of playback.

* About the location of the buttons, please refer to Page 10 2.1 Front View.

4.3.4 Play Back Recorded Video from a HDD of the mobile rack

To play back a recorded video from a HD2, take the following steps:

- (1) Press the Setup button (9) to enter the setup menu.
- (2) Select DISK and press the Enter button (15) to enter the DISK SETTING page.
- (3) Set the HD2 USAGE to REC and then exit the setup menu.
- (4) Use the search function to access desired recorded video. For specific operation details please refer to the next section 4.4 (Search Operations).

NOTE: If the play back is performed reversely (fast / slow / step by step) from HD2 to HD1, it might not work correctly.

4.4 Search Operations

This section shows you how to access recorded video.

4.4.1 Full List Search

Take the following steps to proceed with the full-list search function.

- (1) Press the Search button (10) to enter the search mode.
- (2) Select the FULL LIST and press the Enter button (15) to access the complete list of recorded video.
- (3) Highlight the specific recorded video of your requirement and press the Enter button (15) to display the selected video.

(Key Operation: Press the (12) “^” and (13) “v” buttons, to select a video; press the (11) “<” and (14) “>” buttons, to flip over a page.)

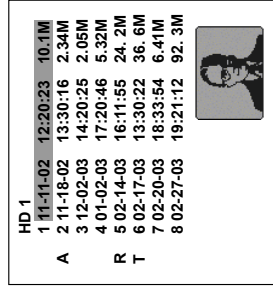
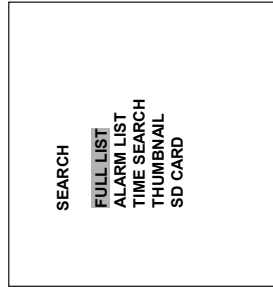

NOTE: T: Timer recording; R: External trigger recording; A: Alarm recording.

NOTE: The maximum number of lists, for a respective HDD, is 3000.

* About the location of the buttons, please refer to Page 10 2.1 Front View.

4.4.2 Alarm list Search

Take the following steps to proceed with the alarm-list search function.

- (1) Press the **Search** button **(10)** to enter the search mode.
 - (2) Select the **ALARM LIST** and press the **Enter** button **(15)** to access the complete list of alarm-event recorded video.
 - (3) Highlight the specific recorded video of your requirement and press the **Enter** button **(15)** to display the selected video.
- (Key Operation: Press the **(12)** "A" and **(13)** "V" buttons, to select a video; press the **(11)** "←" and **(14)** "→" buttons, to flip over a page.)**

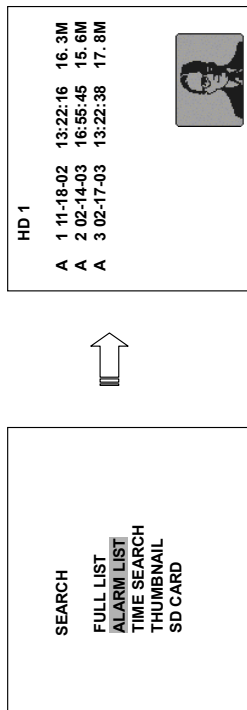

4.4.3 TIME Search

Take the following steps to proceed with the time search function.

- (1) Press the **Search** button **(10)** to enter the search mode.
- (2) Select the **TIME SEARCH** and press the **Enter** button **(15)** to access the time-setting page.
- (3) Set the time period you wish to search for the recorded video.
- (4) Press the **Enter** button **(15)** to start searching and displaying the concerned image.
- (5) If no video is found, please return to the time-setting page and repeat steps (3) and (4) again for another search.

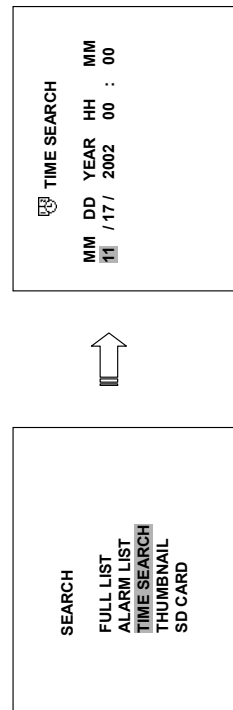

4.4.4 THUMBNAIL Search

Take the following steps to proceed with the thumbnail search function.

- (1) Press the **Search** button **(10)** to enter the search mode.
 - (2) Select the **THUMBNAIL** and press the **Enter** button **(15)** to access the thumbnail page.
 - (3) Set the date you wish to search for the recorded video.
 - (4) Press the **Enter** button **(15)** to start searching and displaying the concerned image.
- You can set up by using the "**←**" button **(11)**, the "**→**" button **(14)**, the "**A**" button **(12)** and the "**V**" button **(13)** to move eye focus.
 - You can also set up by using the **Shuttle Ring** and the **Jog Dial** to move eye focus. **(16)** is the equal of the "**←**" button **(11)**, **(17)** is the equal of the "**→**" button **(14)**, **(18)** is the equal of the "**A**" button **(12)** and **(19)** is the equal of the "**V**" button **(13)**.
- (5) There are 5 levels of recording range modes to choose from: **1 Hour, 10 Minutes, 1 Minute, 10 Seconds and 1 Second**. Select the specific field of your requirement and press the **Enter** button **(15)** to enter the next level. If you want to return the previous level, please press the **Setup** button **(9)**.
 - (6) Once reaching the critical point at any level, the user can start playback by just clicking the **PLAY** button **(4)**.

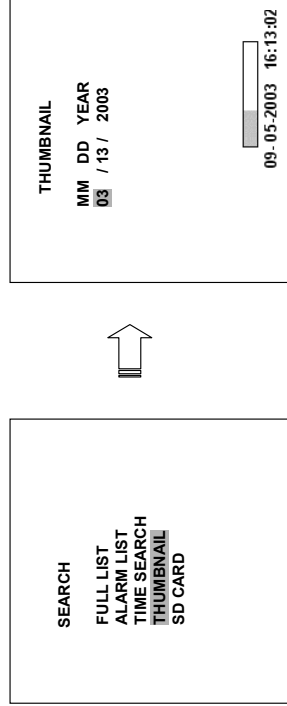

* About the location of the buttons, please refer to Page 10.2.1 Front View.

4.4.5 SD CARD Search

Take the following steps to proceed with the SD card search function.

- (1) Insert a SD Card into the SD card slot of the rear unit.
- (2) Press the **Search** button (9) to enter the search mode.
- (3) Select the **SD CARD** and press the **Enter** button (15) to access the complete list of JPG files.
- (4) Highlight the specific JPG file of your requirement and press the **Enter** button (15) to display the image.
- (5) If you need another, please return to the SD card JPG file list page and repeat steps (3) and (4) again for another search.

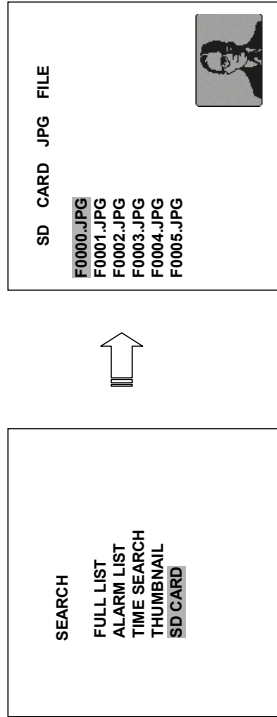

NOTE: If you would like to delete JPG file in the SD card, please return to **SD CARD JPG FILE** list page and highlight the specific JPG file of your requirement and press the **Setup** button (9), and then select the “**Yes**” to delete the image.

4.5 Backup Operations

4.5.1 Mobile Rack HD Backup

There are three ways available to duplicate the recorded video from HD 1 (Fixed HD) to HD 2 (Mobile Rack HD). Please take the following steps to proceed.

- (1) **Set HD 2 to BACKUP first. Take the following steps.**

- Press the **Setup** button (9) to enter the setup mode and select the **DISK**.
- Highlight **DISK** and press the **Enter** button (15) to enter the **DISK SETTING** page.
- Then set **HD 2 USAGE** to **BACKUP**.

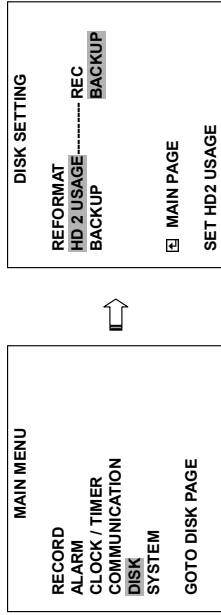

- (2) **FULL:** Duplicate all the recorded video from HD1 to HD2.

- Stay on the **DISK SETTING** page.
- Use the “**A**” and “**V**” buttons, (12) and (13), to highlight **BACKUP**, select **FULL**, then press the **Enter** button (15) to proceed.

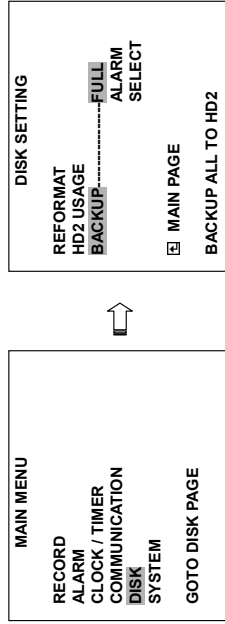

ALARM: Duplicate all the alarm-event recorded video from HD 1 to HD2.

- Stay on the **DISK SETTING** page.
- Use the “**A**” and “**V**” buttons, (12) and (13), to highlight **BACKUP**, select **ALARM**, then press the **Enter** button (15) to proceed.

* About the location of the buttons, please refer to Page 10.2.1 Front View.

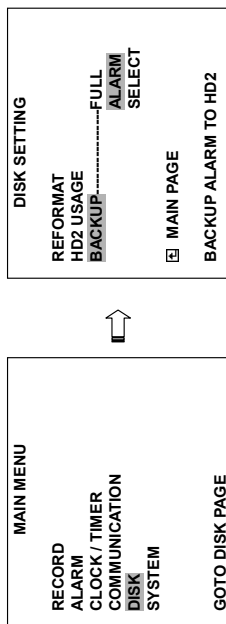

SELECT: Duplicate a particular recorded video from HD1 to HD2.

- Stay on the **DISK SETTING** page.
- Use the “▲” and “▼” buttons, **12** and **13**, to highlight **BACKUP**, select **SELECT** and then press the **Enter** button **15** to list all the recorded video.
- Press the “▲” and “▼” buttons, **12** and **13**, to select the desired clip and press the **Search** button **10** to mark it.
- After completing the selection, press the **Enter** button **15** to proceed.

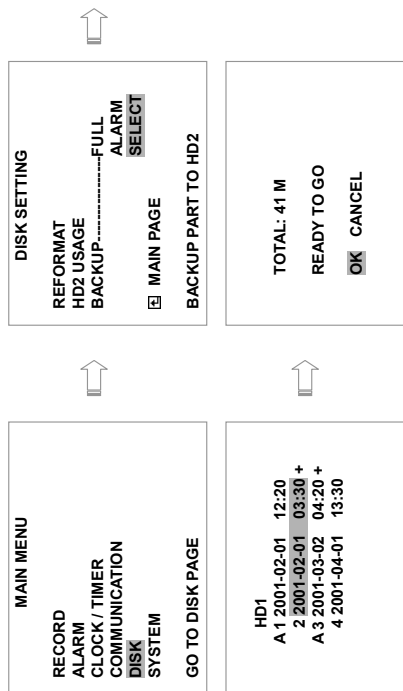

NOTE: If the capacity of HD 2 is not sufficient to store all selected video, a warning message “HD2 SPACE NOT ENOUGH” will be displayed on the screen. Please, insert a larger capacity of hard-disk drive and start the process all over again.

NOTE: The black back will remain (1/7 of screen from the bottom) after executing HD BACKUP. In such a case, it will disappear by opening the Search menu or starting playing back movies. This is not a defect.

4.5.2 Secure Digital Card (SD Card) Backup

The SD card slot of the rear unit has three functions as shown below:

1. Archive Single Image Clips into SD Card

Please take the following steps to archive a critical image in a SD card.

- (1) Insert a SD Card into the SD card slot of the rear unit.
- (2) Start playing back the recorded video. (When playing back recorded video made by a multiplexer, you must get into the multiplexing mode and display picture by picture in order to select the desired image for archiving. Press the **Monitor** button **16** to get into the multiplexing mode under this mode so that the light of the **Monitor** button **16** is off and the pictures are switching swiftly)
- (3) Press the **PAUSE** button **3** to freeze the desired pictures.
- (4) Press the **Enter** button **15** to save the image in the SD Card.
The quantity of pictures that can be stored depends on the SD card capacity. It depends on SD card capacity how many pictures can be stored. You can have the saved images printed out in any computer. The image is stored in the JPEG compressed format. If more than one clip is stored in a SD card, file names will be assigned in sequence as shown below.

```
SAVE TO J0000.JPG
SAVE TO J0001.JPG
...
SAVE TO J000N.JPG
```

2. Backup the System setting info into SD Card.

The VR-601 offers a quick setup method by using a SD card. If a user wants to set many VR-601 devices with the same settings, the VR-601 could save the whole setting in the SD card, then transfer it to another DVR.

Save the whole setting into the SD card:

- Insert a SD card into the SD card slot.
- Press the **Setup** button **9** to enter the setup mode and select the **SYSTEM**.
- Highlight **SYSTEM** and press the **Enter** button **15** to enter the **SYSTEM SETTING** page.
- Set **SD SETUP** to **SAVE**. Then the system setting info will auto save into SD card.

Table 4.5.2 A. Compatible SD Cards

Manufacturer	Capacity
Parasonic	32MB ~ 128MB
PQI	32MB ~ 128MB
Hagiwara	32MB ~ 128MB

NOTE: SD Cards not shown on this list have not been tested by the engineering team and are not recommended for use with this product. For the latest updated list on the recommended SD Cards, please contact your dealers or distributors.

* About the location of the buttons, please refer to Page 10 2.1 Front View.

Transfer the system setting info of DVR to another:

- Insert the SD card which has stored the system setting info into the DVR.
- Press the **Setup** button (9) to enter the setup mode and select the **SYSTEM**.
- Highlight **SYSTEM** and press the **Enter** button (15) to enter the **SYSTEM SETTING** page.
- Then set **SD SETUP** to **LOAD**.

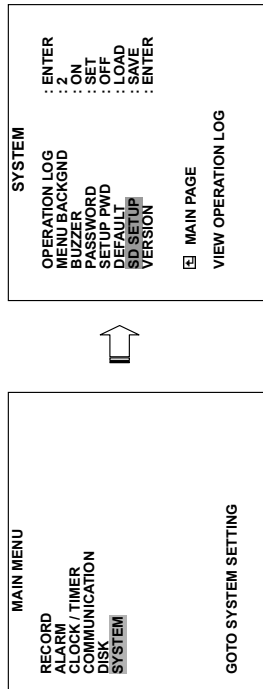

3. Updating System Software (Please refer to section 3.4 for more details.)

4.6 Key Lock Operation

The Key lock operation protects the unit against unauthorized use by disabling the entire front panel controls. Simultaneously press these two (11) “<” and (14) “>” buttons (as shown below) for at least 3 seconds to lock the unit; to release the **Key Lock**, simultaneously press these two buttons again.

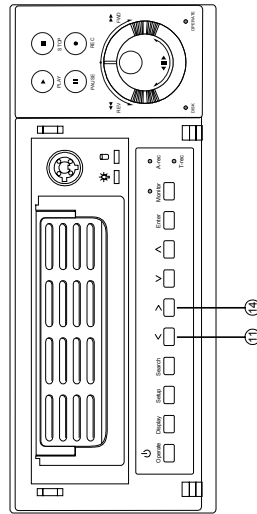

* About the location of the buttons, please refer to Page 10 2.1 Front View.

5. MENU SETUP

There are 6 categories for operation setting in the setup menu system as shown below. The following sections will instruct you step by step to configure the operation setting and state each menu's purpose and options. Press the **Setup** button (9) to access the setup menu. Once inside the menu system, the on-screen menu allows you to set up the key features of the unit. The functions of various buttons within the menu-setup mode are described in the paragraphs below.

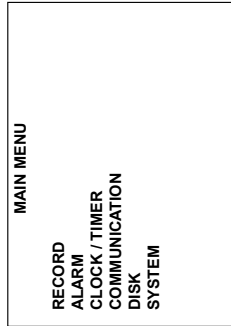

KEY FUNCTIONS

Setup button (9) :

Press to enter the setup menu. Press again to exit the setup mode.

“<” “>” buttons (12) and (13) :

Press to select the desired item or entry for setting.

“<” “>” buttons (11) and (14) :

Press to highlight the desired option or to select the context for setting.

Enter button (15) :

Press to enter the selected item and to save the setting.

Shuttle Ring (20) :

Turn to highlight the desired option or to select the context for setting.

Jog Dial (21) :

Turn to select the desired item or entry for setting.

* About the location of the buttons, please refer to Page 10 2.1 Front View.

5.1 REC SETTING

This page allows you to set the recording rate and recording quality, and enables you to continue recording when the disk is full.

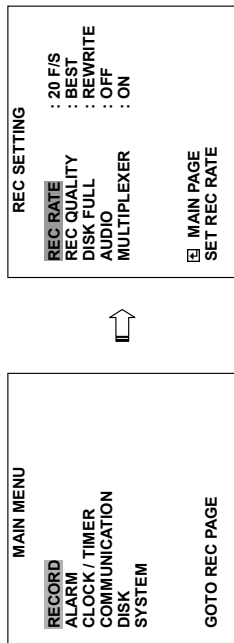

REC RATE:

This option is for adjusting the number of pictures recorded every second into a storage disk. The recording rate controls the frequency at which the number of video pictures can be recorded.

- For a NTSC unit, there are 11 different recording rates you can select from: **60F/S (60 fields per second)**, **30F/S**, **20F/S**, **12F/S**, **5.5F/S**, **2.4F/S**, **1.22F/S**, **0.71F/S**, **1 F/4S**, **1F/6S**, and **1F/8S**.
- For a PAL unit, there are 11 different recording rates you can select from: **50F/S (50 fields per second)**, **25F/S**, **17F/S**, **10F/S**, **5.5F/S**, **2.9F/S**, **1.52F/S**, **0.88F/S**, **1 F/4S**, **1F/6S**, and **1F/8S**. Please refer to the table in section 4.1 for details.

NOTE: The **60 f/s (50 f/s for a PAL unit) recording rate can only function in a 352x240 (352x288 for a PAL unit) resolution**

REC QUALITY:

This option determines the image quality to be recorded. The DVR stores images in the compressed format and allows the image quality to be altered by the image size. There are 4 levels of image quality you can select from: **BEST**, **HIGH**, **STANDARD**, and **BASIC**. Selecting the **BEST** image for use provides higher-resolution recorded images, and normally takes up more storage space than a **HIGH**, **STANDARD** or **BASIC** image does.

DISK FULL:

This option determines the way to utilize storage media in case of a full disk.

REWRITE: When the hard-disk is full, the device continues recording by displacing the old data.
STOP: When the hard-disk is full, the device will stop recording.

* About the location of the buttons, please refer to Page 10.2.1 Front View.

AUDIO:

This option determines the way to record sound if necessary.

ON: Enables AUDIO recording.

OFF: Disables AUDIO recording.

NOTE: Audio function can only be activated in the following refresh rate in NTSC(PAL):
 12(10), 5.5(5.5), 2.4(2.9), 1.22(1.52), 0.71(0.88) fields/sec

MULTIPLEXER:

For optimum image recording please set this option to **ON** when the DVR is connected to a multiplexer for use. Set this option to **OFF** when it is only connected to a single camera or Quad processor.

5.2 ALARM SETTING

This menu allows users to program the configuration of alarm recording only when an alarm input is activated. The device will record as long as the alarm input is activated.

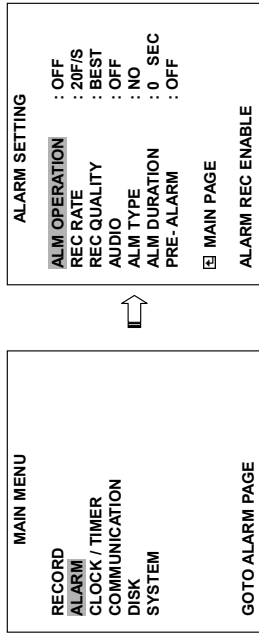

ALM OPERATION:

This option determines whether to activate/deactivate the alarm recording when it detects an alarm input.

ON: The device activates the alarm recording when it detects an alarm input.

OFF: The device ignores the alarm signal when it detects an alarm input.

NOTE: When the Alarm Operation is ON, The image software (Network Viewer) doesn't show the pictures and a message will be displayed.

REC RATE:

This option is for the purpose of adjusting the number of pictures recorded every second into a storage disk when an alarm input is activated. For a NTSC unit, there are 5 different record speeds you can select from: **60F/S (60 fields per second)**, **30F/S**, **20F/S**, **12F/S**, and **REMAIN**. For a PAL unit, there are 5 different record speeds you can select from: **50F/S (50 fields per second)**, **25F/S**, **17F/S**, **10F/S**, and **REMAIN**. If you select **REMAIN** for use, the device will record images at the same speed as set on the **REC** page.

* About the location of the buttons, please refer to Page 10.2.1 Front View.

REC QUALITY:

This option determines the image quality to be recorded when an alarm occurs. There are 4 levels of image quality to choose from: **BEST**, **HIGH**, **STANDARD**, and **BASIC**. The table below shows the level of image quality with the corresponding compression ratio and image size.

Image Quality	Compression Ratio	
	Best	High
Image Size	48KB	32KB
		21KB
		16KB

AUDIO:

This option determines the way to record sound if necessary.

ON: Enables AUDIO recording.

OFF: Disables AUDIO recording.

NOTE: Audio function can only be activated in the following refresh rate in NTSC(PAL):

12(10), 5.5(5.5), 2.4(2.9), 1.22(1.52), 0.71(0.88) fields/sec

ALM TYPE:

This option allows users to set a type of alarm input corresponding to the sensor signal in use.

NO: Normally Open. This is to be used with the type of alarm sensor whose contact remains open in normal conditions and closes in case of activation.

NC: Normally Closed. This is to be used with the type of alarm sensor whose contact remains closed in normal conditions and opens in case of activation.

ALM DURATION:

This option allows users to set alarms for a certain duration. You can select one of the six following options: **0 SEC**, **30SEC**, **1 MIN**, **5 MIN**, **10 MIN**, and **NON-STOP**.

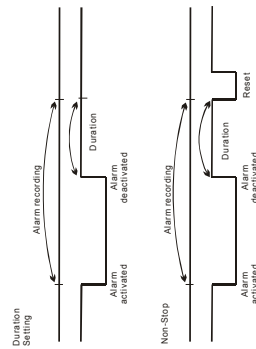

NOTE: Recording may be interrupted at the time of Alarm-in or Alarm-out. LIVE images may be interrupted at the time of Alarm-out.

PRE-ALARM:

This option determines that images prior to an alarm occurs will be recorded in the hard-disk drive. When an alarm is triggered the device will record the image prior to the alarm for 5 seconds in NTSC (**20 fields/sec) or 6 seconds in PAL (**17 fields/sec).

ON: Enables this function.

OFF: Disables this function.

NOTE: If the device is already under recording mode before alarm occur, the pre-alarm recording would not take effect.

** : For NTSC and Mux Off Mode, recording rate 20F/S would be actually 15 F/S
For PAL and Mux Off Mode, recording rate 17F/S would be actually 12.5 F/S.

(This adjustment is to avoid image shaking during playback at the same speed)

5.3 CLOCK / TIMER

The DVR provides a weekly table, consisting of two periods of time each day for scheduled recording. This option allows you to set the time each day that the DVR will start and stop recording.

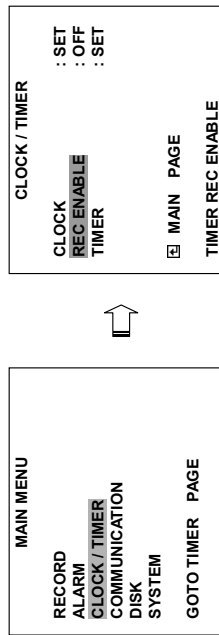

CLOCK:

This entry allows users to set the system time.

NOTE: Clock data is retained for about 3 months after the 15-hour power supply is used up (Operate On mode).

REC ENABLE:

This option enables/disables the programmed scheduled recording.

ON: Enables the scheduled recording.
OFF: Disables the scheduled recording.

TIMER:

This entry allows users to program the time each day that the DVR will start and stop recording. There are two time periods each day available for scheduling. The time is displayed in a 24-hour clock format. If there is a time overlapping showing between two continual time period settings, the device will automatically combine the two time-period settings into one combined time-period setting.

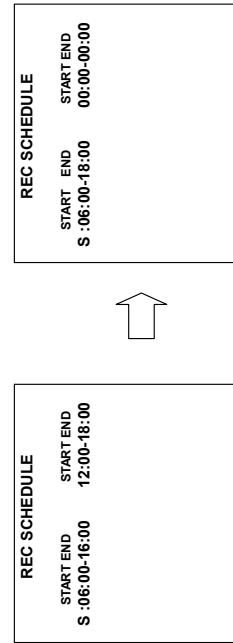

5.4 COMMUNICATION

This option allows you to configure the status of the RS-232 communication port when connected to an external device, and the Ethernet communications settings. (Please refer to the RS-232 Protocol and Network Function for more details)

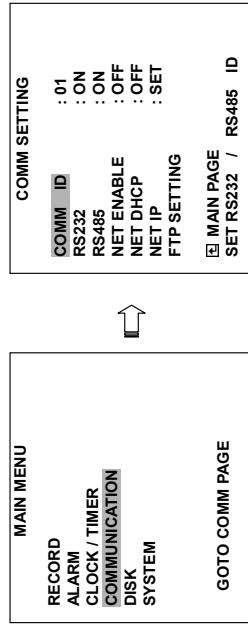

COMM ID:

Communication ID for RS-232 and RS-485 communication. After the VR-601 receives a RS-232 or RS-485 command, it checks if the <Dest ID> within the code is the same as the COMM ID, in which case the particular command can be accept.

RS-232:

The RS-232 communication port can be either in an importing or exporting mode according to your applications.

ON: Enables the RS-232 communication port. When you wish the unit to be controlled by an external device, please select this entry for use.

OFF: Disables the RS-232 communication port.

RS-485:

The RS-485 communication port can be either in an importing or exporting mode according to your applications.

ON: Enables the RS-485 communication port. When you wish the unit to be controlled by an external device, please select this entry for use.

OFF: Disables the RS-485 communication port.

NET ENABLE:

This option selects either enable or disable for the Ethernet communication port.

OFF: Disables it.

ON: Enables it.

NET DHCP:

This option selects enable or disable for the DHCP communication function.

OFF: Disables it.

ON: Enables it.

NOTE: If provided with a DHCP server, the VR-601 can get an IP automatically by setting this option to ON.

NET IP:

This option is used to configure the Ethernet communication settings. This is required for the purpose of making a network connection. Please consult with a qualified MIS professional to configure it.

IP: XXX XXX XXX XXX

MASK: XXX XXX XXX XXX

GATEWAY: XXX XXX XXX XXX

FTP SETTING:

This entry allows users to set the FTP File Transfer Protocol.

COMM SETTING COMM ID : 01 RS232 : ON RS485 : ON NET ENABLE : OFF NET DHCP : OFF NET IP : SET FTP SETTING <input checked="" type="checkbox"/> MAIN PAGE NAS FTP RECORDING		FTP SETTING ENABLE : OFF REC MODE : ALARM REC REC RATE : 1 F / 1 S ACCOUNT : SET <input checked="" type="checkbox"/> MAIN PAGE SET FTP ON / OFF
---	--	--

ENABLE:

This option is to select enable or disable for the FTP function.

ON: Enables it.

OFF: Disables it.

REC MODE:

This option determines the recording mode to be recorded when the FTP function occurs. There are 2 levels of recording mode to choose: **ALARM REC** and **ALL REC**.

ALARM REC: Only to record the alarm-event recorded video.

ALL REC: To record all the recorded video.

NOTE: When the alarm input is used, please set REC SETTING of FTP to ALARM REC.

When the alarm input is not used, please set it to ALL REC.

NOTE: If the interval between REC and the following REC is too short in ALL REC setting, or if the interval between ALARM OUT and IN is too short in ALARM REC setting, FTP might not work correctly.

REC RATE:

This option determines the recording rate to be recorded at when the FTP function occurs. There are 4 levels of recording rates to choose from: **1 F / 1 S**, **1 F / 10 S**, **1 F / 30 S** and **1 F / 60 S**.

NOTE: An actual transfer interval could be stretched in some environment.

ACCOUNT:

This option is used to configure the FTP account settings. This is required for the purpose of making a FTP connection. Please consult with a qualified MIS professional to configure it.

FTP ACCOUNT FTP IP : 192.168.001.128 USER : [dvr] PASSWORD : [00000000] PATH : [/dvr/video]	
--	--

FTP IP : Every FTP server has to own an IP address to be identified on the network. Input the IP address of the FTP server.

USER : Input the FTP user name (Login Name).

PASSWORD : Input the FTP password (Password).

PATH : Input the upload path while doing the FTP.

NOTE: For valid settings, please reboot the DVR after changing the **FTP ACCOUNT**.

5.5 DISK SETTING

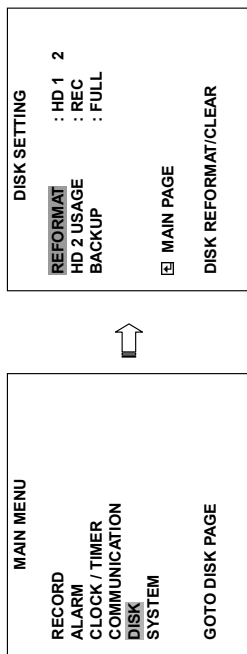

REFORMAT:

This option allows you to clear out all the data in the hard-disk drive. You will be required to enter the pre-set password before proceeding with clearing out the data. Enter the standard password "9999" if you don't set your individual password. To set your individual password, please refer to section 5.6

PASSWORD option.

HD 1 2: Clears out all the data stored in HD 1 and HD 2.

BACKUP HD: Clears out all the data stored in HD 2, which is set to backup purpose only. (This function has to be proceeded with when the **HD 2 USAGE** option is set to **BACKUP**.)

HD2 USAGE:

This option determines the way to utilize the hard-disk drive in the mobile compartment.

BACKUP: Used for data backup only, which will not be part of regular recording hard-disk drive.

REC: Used for the regular recording hard-disk drive.

NOTE: When you wish to play back a recorded video from a HD2, this option must be set to

REC. For more details, please refer to section 4.3.4.

BACKUP:

This function allows you to duplicate data from HD 1 to HD 2. Please set HD 2 as **BACKUP** first. (For operation details, please refer to section 4.5.1)

FULL: Duplicates all the recorded video from HD1 to HD2.

ALARM: Duplicates all the alarm-event recorded video from HD 1 to HD2

SELECT: Duplicates a particular recorded video from HD1 to HD2.

5.6 SYSTEM

This page is used for accessing the history of the operation status, setting the password, resuming factory default, and determining the menu display background.

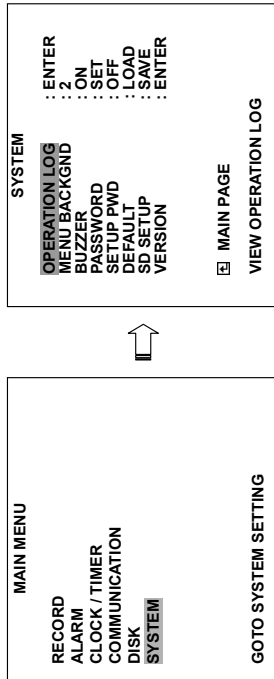

OPERATION LOG:

This log shows the history of the operation status in chronological order. What the following entries represent is detailed below.

ON: Powers up the device.

OFF: Powers off the device.

REC: Starts recording.

STOP: Ceases recording.

PLAY: Shows recorded video.

V-IN: Video input is connected.

V-LOSS: Video loss occurs.

P-LOSS: Power interruption occurs.

A-IN: Detects an alarm input.

LOCK: Disables the entire front panel controls.

UNLOCK: Releases the key lock.

UPDATE: Updates system software.

05/15/03	18:19:32 ON
05/15/03	18:19:32 OFF
05/15/03	18:19:32 REC
05/15/03	18:19:32 STOP
05/15/03	18:19:32 PLAY
05/15/03	18:19:32 V-IN
05/15/03	18:19:32 V-LOSS
05/15/03	18:19:32 P-LOSS

Note: The log keeps an operation history on a revolving basis because of a limit is 2000. When the log is full, the newly registered record of an operation will replace the existing records from the oldest one.

MENU BACKGND:

There are 3 levels of background color transparency, you can choose from : level 1 is totally transparent, level 3 is opaque, and level 2 is between level 1 and 3. The background color is used in setup menu and search function.

BUZZER:

This option determines the embedded buzzer sounding a tone to signal the following situations. A tone lasts about two seconds long.

ON: Enables buzzer.

OFF: Disables buzzer.

Situation
Alarm occurs
Video loss occurs
Disk is full
Load factory default
Buzzer set to ON
Enable/disable key/lock function
Power on /off mobile rack HDD
Backup operation complete
Timer activate/deactivate
Recording switching between HDD

PASSWORD:

This option allows you to set a password to prevent any unauthorized re-formatting of the hard-disk drives or use by a network viewer. The standard password is '9999'.

OLD PASSWORD: Enter the pre-set password (or the standard password if this is the initial setting) to access the password setting system.

NEW PASSWORD: Enter a 4-digit-number password of your choosing which will replace the pre-set password (or the standard password '9999').

SETUP PWD:

When this option is on, user must pass the password check before entering the setup menu.

ON: Enables it.

OFF: Disables it.

DEFAULT:

This option allows you to reload the factory default setting. Please do note that the password can not be changed in the factory default setting.

SD SETUP:

The VR-601 offers a quick setup method by using a SD card. If the user wants to set up many a number of the same devices with the same settings, he can save the whole settings to a SD card, then transfer to another DVR.

SAVE: Saves the whole setting to the SD card.

LOAD: Loads the whole setting from the SD card.

VERSION:

This item is in the setup menu reveal network MAC, BIOS version, and software version, and last updated date.

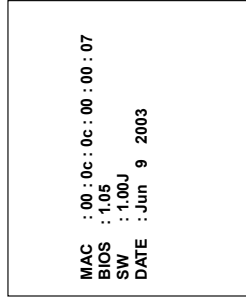

6. RS-232 & RS-485 Protocol

6.1 Setup

6.1.1 Use a Null Modem cable (the standard RS-232 9 Pin Cable with Pin 2 and Pin 3 exchanged, see pin configuration chart below for details) to connect the COM 1 on the rear panel of the DVR to a PC.
For RS-485, maximum length of cable is 400 meter, and maximum number of nodes is 16.

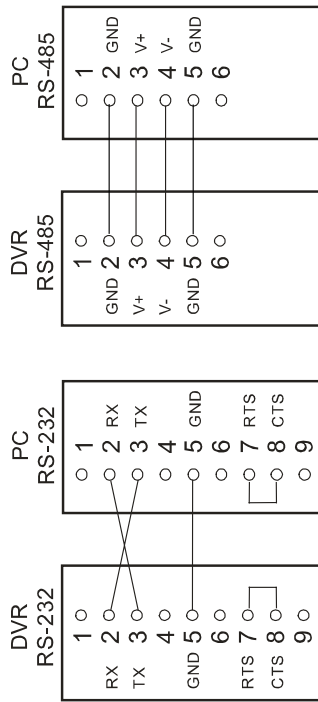

6.1.2 Set the **RS-232** or **RS-485** option to **ON** in the **COMMUNICATION** page of the setup menu.

6.1.3 Set the PC communication parameters: 9600 bps, No Parity, 8 Data Bits, 1 Stop Bit.

6.2 Communication Protocol:

6.2.0 General Command Format

<Lead Code = 0x41>, < Dest ID >, < Src ID >, <Main category>, < Second category >, {<Number of parameters>, <Parameter 1>, <Parameter 2> ...} <End Code= 0x4f>

Lead Code = 0x41
Dest ID = 0x01
Src ID = 0x20
Main Category = 0x01 Keys and Signals
= 0x02 Command
Second Category = 0x01 Handshake
= 0x02 Request Time/Set Time
= 0x06 Request System State
End Code= 0x4f

The different command types and their corresponding parameters are as follows:

6.2.1 Keys and signals

PC Send: <0x41>, <0x01>, <0x20>, <0x01>, <0x01>, <Key Value>, <0x4f>

< The value of a specific front panel key >

KEY	DEC	HEX
KEY_PLAY	1	01
KEY_STOP	3	03
KEY_PAUSE	4	04
KEY_REC	6	06
KEY_SETUP	7	07
KEY_ENTER	8	08
KEY_SEARCH	10	0A
KEY_DISPLAY	11	0B
KEY_UP	13	0D
KEY_DOWN	14	0E
KEY_LEFT	15	0F
KEY_RIGHT	16	10
KEY_MONITOR	36	24
JOG_L	128	80
JOG_R	129	81
KEY_SHUTTLE_L8	130	82 (-100x, -1/16x)
KEY_SHUTTLE_L7	131	83 (-100x, -1/16x)
KEY_SHUTTLE_L6	132	84 (-30x, -1/8x)
KEY_SHUTTLE_L5	133	85 (-16x, -1/8x)
KEY_SHUTTLE_L4	134	86 (-8x, -1/4x)
KEY_SHUTTLE_L3	135	87 (-4x, -1/4x)
KEY_SHUTTLE_L2	136	88 (-2x, -1/2x)
KEY_SHUTTLE_L1	137	89 (-1x, -1/2x)
KEY_SHUTTLE_CT	138	8A
KEY_SHUTTLE_R1	139	8B (2x, 1/2x)
KEY_SHUTTLE_R2	140	8C (4x, 1/2x)
KEY_SHUTTLE_R3	141	8D (8x, 1/4x)
KEY_SHUTTLE_R4	142	8E (16x, 1/4x)
KEY_SHUTTLE_R5	143	8F (30x, 1/8x)
KEY_SHUTTLE_R6	144	90 (100x, 1/8x)
KEY_SHUTTLE_R7	145	91 (100x, 1/16x)
SIGNAL_REC_IN	163	A3
SIGNAL_ALARM_RESET	165	A5
SIGNAL_REC_OUT	169	A9
SIGNAL_ALARM_IN	189	BD
SIGNAL_ALARM_OUT	209	D1

NOTE: If **SIGNAL_ALARM_IN** is requested, alarm recording is performed by non-stop. Please transmit **SIGNAL_ALARM_RESET** for stopping.

*About (A, B), A means the speed of **FAST** playback, B means the speed of **SLOW** playback.

6.2.2 COMMAND Types

6.2.2.0 Command (Main Category=0x02)

6.2.2.1 Handshake (Second Category=0x01)

PC Request: <0x41>, <0x01>, <0x20>, <0x02>, <0x01>, <0x00>, <0x4f>

DVR Response: <0x41>, <0x20>, <0x01>, <0x02>, <0x08>, <0x00>, <0x4f>

6.2.2.2 Request Time (Second Category=0x02)

PC Request: <0x41>, <0x01>, <0x20>, <0x02>, <0x02>, <0x00>, <0x4f>

DVR Response: <0x41>, <0x01>, <0x20>, <0x02>, <0x02>, <0x07>, <7 Time Value >, <0x4f>

The following case is an illustration of < 7 Time Value>

2001/06/20 17:05:00 = <0xD1>, <0x07>, <0x06>, <0x14>, <0x11>, <0x05>, <0x00>

6.2.2.3 Set Time (Second Category=0x02)

PC Request: <0x41>, <0x01>, <0x20>, <0x02>, <0x02>, <0x07>, <7 Time Value >, <0x4f>

The following case is an illustration of < 7 Time Value>

2001/06/20 17:05:00 = <0xD1>, <0x07>, <0x06>, <0x14>, <0x11>, <0x05>, <0x00>

DVR Act: Changing the time and date.

6.2.2.4 Request State (Second Category=0x06)

PC Request: <0x41>, <0x01>, <0x20>, <0x02>, <0x06>, <0x00>, <0x4f>

DVR Response: <0x41>, <0x20>, <0x01>, <0x02>, <0x06>, <0x01>, <0x01>, <0x01>

<System State = 0, >, <0x4f>

Description of <System State>:

STATE	DEC	HEX
STATE_STOP	0	00
STATE_REC	1	01
STATE_PLAY	3	03
STATE_SETUP	6	06
STATE_SEARCH	7	07
STATE_BACKUP	15	0F
STATE_NET_PLAY	23	17

6.2.2.5 Time Search (Second Category=0x0b)

PC Request: <0x41>, <0x01>, <0x20>, <0x02>, <0x0b>, <6 Time Value >, <0x4f>

where < 6 Time Value > = year (2 bytes, = LowByte + HighByte*256), month (1 byte),

day (1 byte), hour(1 byte),min(1 byte)

Example: to search 06/12/2002 17:00 the Time Value =

<0x42>, <0x07>, <0x06>, <0x0b>, <0x11>, <0x00> where 2003= 210(=0xd3) + 7(=0x07) * 256

NOTE: The DVR accepts RS-232 time search commands only under the live or playback Mode.

7. Mobile Rack Installation

Usually, the unit comes with one hard-disk drive installed in compartment HD 1, which is default-configured as a master. The jumper settings configuration of the installed hard-disk drives for the unit and compatible drives which can be used with this unit are listed in the table below. To install a hard-disk drive in compartment HD 2, please take the following steps.

The jumper settings of hard-disk drives for the system

IDE	Location	Jumper
IDE 1	Compartment HD 1	Master
IDE 2	Compartment HD 2	Master



1. Make sure that the key unlocked.



2. Pull the active-handle outward to remove the carrier body away from the mobile rack



3. Slide the top cover backward and remove.



4. Setting the jumper of your hard-disk drive. The way to set the jumper of the drive varies between manufacturers; please refer to the instructions on the drive to set the jumpers in the master position.



5. Attach the interface connector and the power connector to the drive. Please note the red lining of the IDE cable and the red wire of power cable must line up side by side.

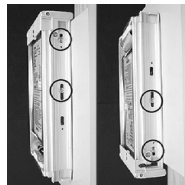

6. Place the hard-disk drive inside mobile rack. Use four of the provided screws.



7. Place the top cover back to the carrier body by sliding forward to secure.



8. Slide the carrier body back in the mobile rack.



9. Push the carrier body further into the mobile rack until fully inserted.



10. Push the active-handle inward.



11. Lock the Key.

8. System Default

MAIN MENU
RECORD
 ALARM
 CLOCK / TIMER
 COMMUNICATION
 DISK
 SYSTEM
 GOTO REC PAGE

REC SETTING
REC RATE : 20 F/S
 REC QUALITY : BEST
 DISK FULL : REWRITE
 AUDIO : OFF
 MULTIPLEXER : ON
 MAIN PAGE
 SET REC RATE

MAIN MENU
 RECORD
 ALARM
 CLOCK / TIMER
COMMUNICATION
 DISK
 SYSTEM
 GOTO COMM PAGE

COMM SETTING
COMM ID : 01
 RS232 : ON
 RS485 : ON
 NET ENABLE : OFF
 NET DHCP : OFF
 NET IP : SET
 FTP SETTING
 MAIN PAGE
 SET RS232 / RS485 ID

MAIN MENU
 RECORD
ALARM
 CLOCK / TIMER
 COMMUNICATION
 DISK
 SYSTEM
 GOTO ALARM PAGE

ALARM SETTING
ALM OPERATION : OFF
 REC RATE : 20F/S
 REC QUALITY : BEST
 AUDIO : OFF
 ALM TYPE : NO
 ALM DURATION : 0 SEC
 PRE-ALARM : OFF
 MAIN PAGE
 ALARM REC ENABLE

MAIN MENU
 RECORD
 ALARM
 CLOCK / TIMER
 COMMUNICATION
DISK
 SYSTEM
 GOTO DISK PAGE

DISK SETTING
REFORMAT : HD 1 2
 HD 2 USAGE : REC
 BACKUP : FULL
 MAIN PAGE
 DISK REFORMAT/CLEAR

MAIN MENU
 RECORD
 ALARM
CLOCK / TIMER
 COMMUNICATION
 DISK
 SYSTEM
 GOTO CLOCK / TIMER PAGE

CLOCK / TIMER
 CLOCK : SET
REC ENABLE : OFF
 TIMER : SET
 MAIN PAGE
 TIMER REC ENABLE

MAIN MENU
 RECORD
 ALARM
 CLOCK / TIMER
 COMMUNICATION
 DISK
SYSTEM
 GOTO SYSTEM SETTING

SYSTEM
OPERATION LOG : ENTER
 MENU BACKGND : 2
 BUZZER : ON
 PASSWORD : SET
 SETUP PWD : OFF
 DEFAULT : LOAD
 SD SETUP : SAVE
 VERSION : ENTER
 MAIN PAGE
 VIEW OPERATION LOG

9. O.S.D Message

No.	O.S.D Message	Meanings
1	NO DISK	No hard-disk detected after power activated
2	BATTERY LOW	Suggest change the battery and reset the system time
3	LOADING	System Boot up
4	VIDEO LOSS	Video loss
5	VIDEO IN	Video input source
6	KEY LOCKED	Key lock function is on
7	KEY UNLOCKED	Key lock function is off
8	n1 OF n2 ITEMS PROGRESS n3 %	BACKUP n1/n2 NOW n3 %
9	BACKUP COMPLETE	Backup complete
10	HD2 SPACE NOT ENOUGH	HD2 has not enough space for backup
11	NO RECORD FOR BACKUP	No backup is possible.
12	BACKUP INCOMPLETE	Backup incomplete, since the user has pressed the STOP button to stop it
13	NOT FOUND	The system cannot find a video in the Search function.
14	END	Playback of recorded video has reached the end point
15	DISK FULL	Hard-disks are full; this happens only when the DISK FULL item in the setup menu is set to STOP.
16	EMPTY	The user presses the PLAY button or uses the SEARCH function, but no video can be played.
17	SET TO NTSC, PLS RESTART	System has to be set to NTSC, please reboot. (PAL is similar)
18	SOFTWARE UPDATE	Software update
19	PLEASE RESTART	The system should be rebooted after the software has been updated
20	NO DISK	The user has pressed the Save key without putting in a SD card, or there is a disk error.
21	DATA NOT CONTINUOUS	The system finds data in installed HDs cannot be used continuously. Suggest you remove HD2 from the system.
22	DISK ATTACHED	HD2 has been attached.
23	DISK REMOVED	HD2 has been removed.
24	FAN STOPPED	The chassis fan has stopped for over 30 seconds.
25	HDn ERROR AT xxxxx	There is a hard-disk error during recording, where n is the hard-disk number and xxxxx is the hexadecimal location.
26	NOT PRESENT	When the user tries to clear a disk that was not attached in the setup menu.
27	SAVE TO DISK	Start saving to the JPEG file.
28	SAVE TO Fnmn. JPG	Save to Fnmn. JPG (where nmn= 0..999)
29	SAVE OK	Save to the JPEG is ok.
30	SD CARD WRITE PROTECT	A SD card is write-protected; or there is an error
31	WAIT . . .	The composition of the hard-disk is changing now. Or, it is saving the image into the SD card. Please wait for a while.

10. Network Viewer and Image Viewer

This section provides instructions for installing and using the Network Viewer, and Image Viewer, which are included with the VR-601. The programs can be operated by a selected PC equipped with the following requirements.

1. Intel Pentium 233MHz at least.
2. 32 MB RAM
3. Window 95, 98, NT, ME, 2000 and XP.
4. 4 MB Video card capable of 24-bit true color display.
5. 5 MB free hard-disk space for software installation.
6. 10-base T network for LAN operation.

10.1 The Network Viewer

10.1.1 Introduction to Network Viewer

The Network Viewer allows you to potentially access 16 units of the VR-601 from a remote desktop or a laptop in a TCP/IP networking environment. It can perform the following functions.

- View live images from the VR-601
- Store, search, and review recorded video from the VR-601 HDD.
- Change the regular record, event record, and timer properties.

Before you are ready to view images from a desktop, you need to have your VR-601 networked by obtaining a 10 base Ethernet data cable (Standard RJ-45) to connect the VR-601 to your LAN/WAN. Now enter the main menu to set the IP address.

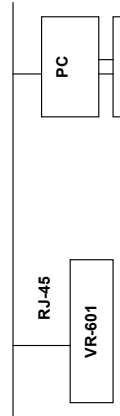

RJ-45 PIN configuration for Ethernet

PIN NO.	PIN Assignment
1.	TX +
2.	TX -
3.	RX +
4.	Not Connected
5.	Not Connected
6.	RX -
7.	Not Connected
8.	Not Connected

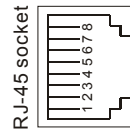

Physical specification for Ethernet

Wire Type	Cat. 5
Connector Type	RJ-45
Max. Cable Length	30 m
Hub Wiring Configuration	Straight Through
PC Wiring Configuration	Cross Over

NOTE: For more details on network connections, please refer to the following document.

10.1.2 Install the Network Viewer in your PC

Install the Network Viewer from the supported CD-R.

1. Exit all applications currently running in the selected PC.
2. Insert the supported CD-R in the CD-ROM drive. The program will execute the installation automatically. Follow the on-screen instructions to proceed with the rest of the installation procedure as they appear.
3. After the installation is complete, pop up the **START** menu from your computer, and point to **Programs / JVC Picture Viewer** to open up the program selection page as shown below. Click the **Network Viewer** tag to start the **Network Viewer** program.

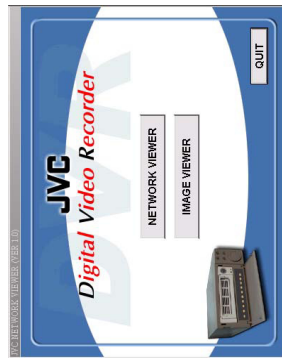

NOTE: The number of Network Viewer that can be simultaneously connected to VR-601 is one.

NOTE: If the Network Viewer needs to be upgraded, please contact your JVC dealer.

NOTE: Please make sure the TCP/IP communication software has been properly set and configured in your computer. To check your TCP/IP settings, refer to the following document.

NOTE: When the Alarm Operation is ON, The image software (Network Viewer) doesn't show the pictures and a message will be displayed.

NOTE: The maximum refresh rate on live mode (REC or STOP) is 2F/S. It depends on the network speed.

10.1.3 View the VR-601 video from a remote PC

Follow the instructions below to use the Network Viewer to browse a VR-601 video from a remote location. Upon entering the Network Viewer, the connection box will appear as follows.

1. Choose a channel number from the Channel drop-down list.
2. Assign a name for the chosen VR-601.
3. Type in the password and IP of the device and click the **Add** tag to add the device to the connection list.
4. Click the **Connect** tag to establish the connection between the devices and the computer. Click **OK** to begin viewing images.

NOTE: Upon connection, the connection status box indicates the name and IP address of the selected device. If there's a failure to connect, a "Fail" message appears on the screen right after the device IP address; otherwise an "OK" appears. To add more connections or units to the VR-601, please repeat the above instructions.

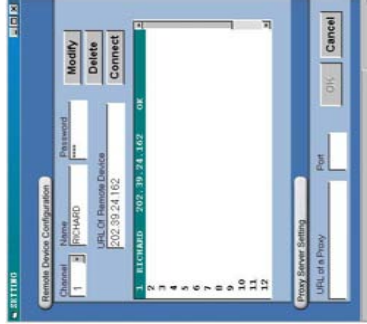

Functions	Description
● Channel	Assign a display location when you have multiple devices connected.
● Name	This box allows you to assign a name to the chosen device.
● Password	Type the preset password for making a connection.
● URL of the Remote Device	Type the IP address which you preset for the device
● URL of a Proxy	Type your proxy server address when accessing the Internet via a proxy server.
● Port	Enter the designated port setting of your proxy server.
● Modify	Click to change the settings of a chosen device.
● Delete	Click to remove the connection of a chosen device
● Connect	Click to establish the connection between the devices and the computer.
● OK	Click to access the display page of the Network Viewer
● Cancel	Click to exit the program of the Network Viewer.





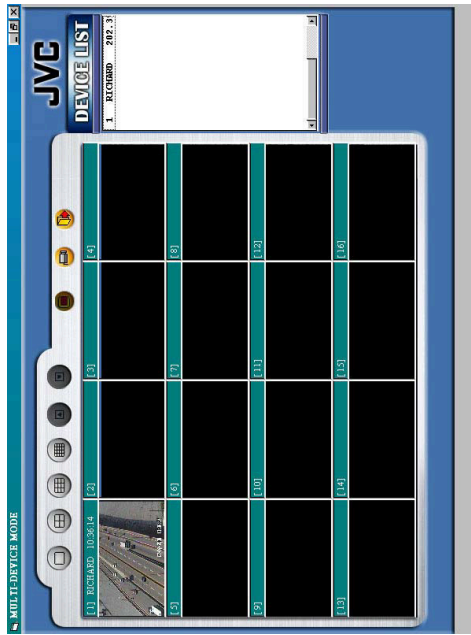

Viewing images

View all the connected devices

Once the connection has been established, click OK to enter the Multi-device mode window. (See the sample screen below) This window displays all the connected devices in the sequence which has been arranged when you established the connection.



Function Buttons

Function Buttons	Description
	Split-Screen display function bar. This allows you to display the connected device in multi-format screens of 1, 2x2, 3x3, and 4x4.
	Press to enter the selected device (the Single device display mode). Select a device from the DEVICE LIST box to enable this button.
	Press to open the device setting page to add more devices for viewing.
	Press to leave the Network Viewer program.
	Connected devices display box. This box indicates the title and IP address of all connected devices.
	Device title and image display area. Displays the title of each connected device and the time/day information of each displayed image on the top blue bar.

View single device

Follow any one of the instructions below to get into the single device mode.

1. Select the desired device from the DEVICE LIST box on the Multi-device Mode. The button will enable. Click the button to view the image of the selected device and have access to certain functional operations of the device via the network. (See the sample screen below.)
2. Double click the image display area of each screen.

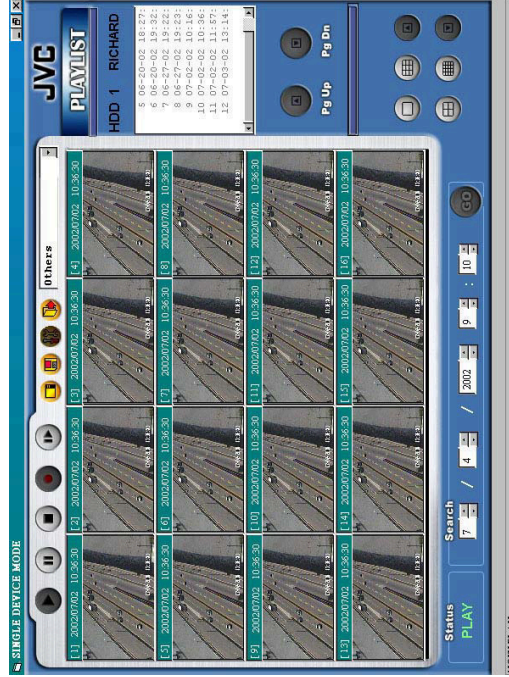

NOTE: The Network Viewer may not play back a recorded video when the number of the index table reached to 3000. In such a case, please reboot the VR-601 for regular playback.

NOTE: The Network Viewer may not operate after Backup Operations. In such a case, please perform operation of PLAY or REC by the front panel buttons in advance.

NOTE: The first image displayed might be different from the one requested. This is the specification of VR-601 and not a malfunction.

10.1.4 Change the Record & Timer Properties Via the Network

Follow the instructions below to reconfigure the record and schedule recording settings via the network.



A.

Set the regular record settings

1. When in the single-device mode, click to enter the **SETUP** page. (See the sample screen as in **A** above)
2. Select a desired recording **RATE** and **QUALITY** from the corresponding drop-down list
3. Click the **OK** tag to proceed.

Set the Alarm record settings

1. When in the single-device mode, click to enter the **SETUP** page. (See the sample screen as in **A** above)
2. Set the **ALARM SETTING** to **ON** to enable the drop-down list in the **ALARM SETTING** area.
3. Select a desired recording **RATE** and **QUALITY** from the corresponding drop-down list.
4. Click the **OK** tag to proceed.

NOTE: When the setting of **VR-601U(NTSC)** is performed from **Network Viewer**, please set **ALARM OPERATION** option to **OFF** in advance. Otherwise, the refresh rate for **VR-601E(PAL)** is displayed. In that case, please set **ALARM OPERATION** option to **OFF** and restart **Network Viewer**.

Set the record timer

1. When in the single-device mode, click to enter the **SETUP** page. (See the sample screen as in **A** above)
2. Set the **RECORD TIMER** to **ON** to enable the **RECORD TIMER** setting area. The **MODIFY** button will appear.
3. Click the **MODIFY** button to set the schedule for recording for each day. (See the sample screen below) Go to both the **START TIME** & **END TIME** boxes, enter a specific **Hour: Minute** and click **OK** to return to the **SETUP** page.
4. When all required settings are completed, click **OK** to proceed.

Function Buttons	Description
	Playback function bar.
	● Play- Click to play back a recorded video from the PLAY LIST .
	● Pause- Click to freeze the image.
	● Stop- Click to stop playing back the recorded video or cease recording.
	● REC- Click to activate the recording function of the device.
	● Step- Click to view images picture-by-picture.
	Click to return to the Multi-Device mode.
	Click to save a viewing image in the local computer.
	Click to enter the SETUP page, which allows you to program the recording rate, recording quality, and schedule recording.
	Click to exit the Network Viewer program.
	Multiplexer format list box. Select a MUX from the drop-down list which is connected with the DVR, so the Network Viewer will be able to display cameras in corresponding to the camera input of the Multiplexer. If your MUX isn't available, please select the Other Multiplexer option for use. The Viewer will display cameras in the thumbnail format. (Sequentially displaying images will appear one after another in the adjacent display/window)
	Recorded video list box. This box allows you to access all recorded video, which are stored in the HDD of the connected devices. To review a recorded video, just click an entry from the list and click the button. PgUp/PgDn: To scroll up and down the list.
	VR-601 Status Box. This box indicates the selected device status. PLAY: The device is in the playback mode. LIVE: The device is in the live display mode. WAIT: The device is processing the command. PAUSE: Pauses the image.
	This allows you to search a recorded video kept in the HDD of the device. Enter the MONTH/DAY/YEAR HOUR: MINUTE you wish to search and click GO to proceed.
	Split-Screen display function bar. This allows you to display the selected device in multi-format screens of 1, 2x2, 3x3, and 4x4.
	Image display area. Displays the images of each camera and the title and time/date information on the top blue bar. Double click the image to view a full screen of the camera.

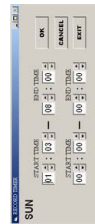

10.1.5 Archive Images to the Computer

Playback images can be stored in a local PC in the JPEG format. Follow the instructions below to save the viewed images to your PC.

1. Press **U** during playback to freeze the desired image.
2. Press **F** to enter the following sample screen.
3. Select a folder in the computer for copying images in.
4. Enter the number of images into the **NUMBER OF SAVING** box you wish to save in.
5. Click the **SAVE** tag; the program will automatically copy the displayed images into the designated folder. The images are saved in the DVRxxx.jpg file name, which is displayed in the box on the right-hand side. To view a saved image, please follow the instructions in the next section to proceed.

NOTE: Please change the recording folder if the number of images will exceed 1,000. Otherwise, VR-601 overwrites the images between 100 - 1,000 while leaving the images between 1 - 99.

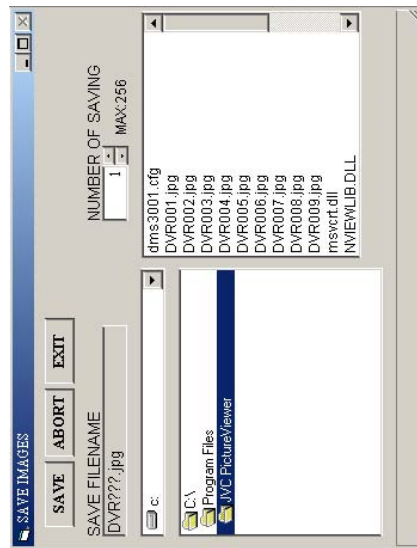

10.2 The Image Viewer

This is image integrity-protect software. It not only allows you to view an archived image from the SD card or HDD of a computer, but also protects an archived image from reproduction or interpolation. If an image isn't in the original format made by a VR-601, the Image Viewer won't display the image and instead will send a warning message "Wrong File, Can't Open". Follow the instructions below to open an archived image from a SD card or a HDD.

1. Pop up the **START** menu from your computer, and point to **Programs/JVC Picture Viewer** to open up the program selection page. Click the **Image Viewer** tag to start the **Image Viewer** program. (See a sample screen below.)
2. Select a folder where the files are kept and click a file you wish to display from the upper-right box or click the **AUTOPLAY** tag to display automatically all the files in the selected folder. Each file will be displayed for 2 seconds on the screen.
3. Click the **PRINT** tag to get a displayed image printed out from a printer.



11. Index Table

The following description details how the DVR manages an index table issue.

The DVR will generate a time index table indicating recorded data is kept in a particular HDD. This allows to individually selecting recorded data to be displayed via the alarm list search and full list search. The maximum number of lists, for a given HDD, is 3000. When the list of any given HDD is used up-and the disk is not full, The unit will still use the rest of the space for recording. In such a case, an index for the recent recorded data will be generated and the index of the next oldest data will be erased so that the list does remain 3000 in total. And the next oldest data will be kept in the index of the corresponding oldest data. For any newly-recorded data, this approach will be applied until the disk becomes full.

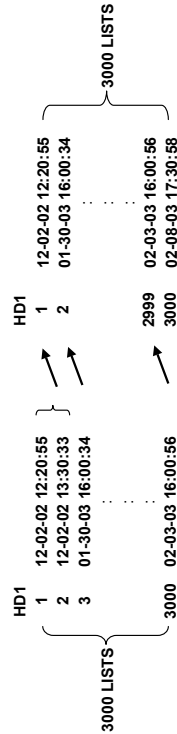

In the rewrite recording mode, when the archived hard-disk drive is full, the DVR will start overwriting the oldest data recorded. As the previous recorded data was partially overwritten by the recent recording, the indicating time index of that data will be changed corresponding to the starting time of the remaining session. The index of the session will be deleted from the table when it is fully overwritten.

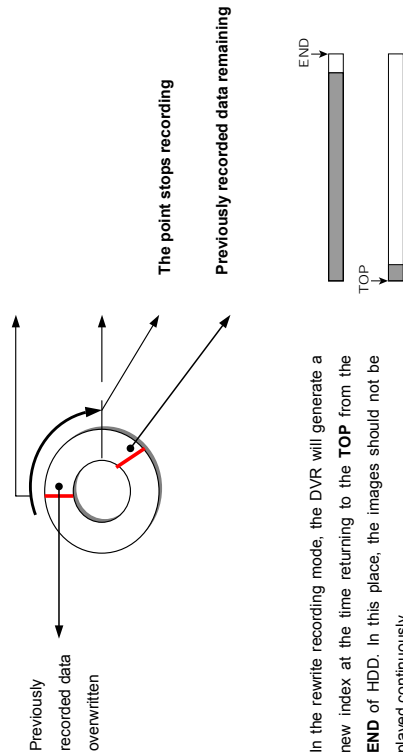

In the rewrite recording mode, the DVR will generate a new index at the time returning to the TOP from the END of HDD. In this place, the images should not be played continuously.

12. Network Configuration

12.1 Cable Connections

Please follow the instructions below to connect your DVR to a computer or a network and to choose a proper RJ-45 cable configuration for connections.

Physical specification of RJ-45 cable for Ethernet

Wire Type	Cat. 5
Connector Type	RJ-45
Max. Cable Length	30 m
Hub Wiring Configuration	Straight Through
PC Wiring Configuration	Cross Over

12.1.1 Connect to a computer

Use a crossover LAN cable to connect directly to a computer.

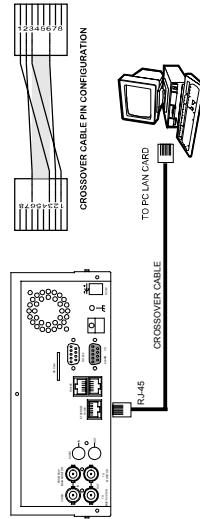

12.1.2 Connect to a LAN Hub (INTRANET)

The RJ-45 PIN configuration for connecting with a LAN Hub is shown below.

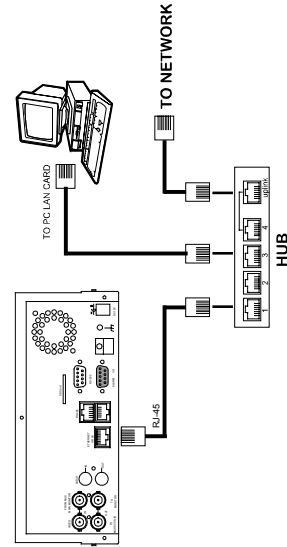

RJ-45 PIN configuration for LAN Hub

PIN NO.	PIN Assignment
1.	TX +
2.	TX -
3.	RX +
4.	Not Connected
5.	Not Connected
6.	RX -
7.	Not Connected
8.	Not Connected

12.1.3 Connect to WAN (INTERNET)

The RJ-45 PIN configuration for connecting to a WAN is the same as connecting to a LAN.

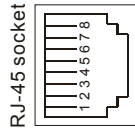
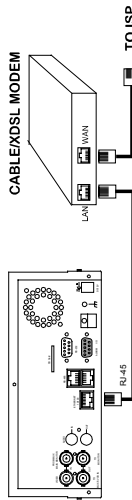

12.2 Configure Your DVR Network Settings

Upon network hardware connection, you need to activate the network function and configure the proper network settings of the DVR.

12.2.1 Enable DVR Network Function

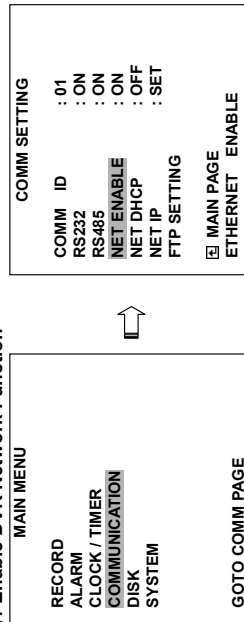

- Press the **Setup** button (9) to enter the **MAIN MENU**. Please use the “<” “>” buttons (1) and (14) to highlight **COMMUNICATION**; then press the **Enter** button (15) to enter the **COMM SETTING** page.
- Use the “<” “>” buttons (12) and (13) to highlight **NET ENABLE**; select **ON**. Then press the **Enter** button (15) to proceed.

* About the location of the buttons, please refer to **Page 10 2.1 Front View**.

12.2.2 Enable DHCP Function

- Use the “<” “>” and “v” buttons (12), and (13), to highlight **NET DHCP**; select **ON**. Then press the **Enter** button (15) to proceed.

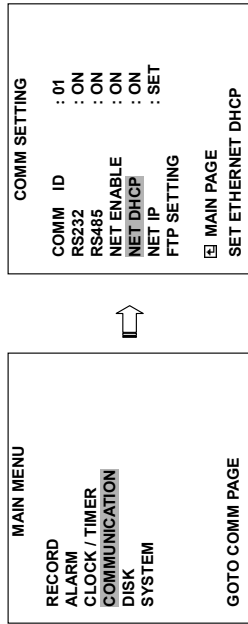

NOTE: This function can only work if the LAN which the unit is connected to has a DHCP server. If the DHCP server is working, the DVR will obtain an IP address automatically from the DHCP server. In that case please skip the section 2.3 (Set IP address) and follow section 3. (TCP/IP Communication Software).

12.2.3 Set IP Address

You don't need to set a NET IP for the unit if the LAN which the unit is connected to has a DHCP server. Otherwise, please follow the instructions given below:

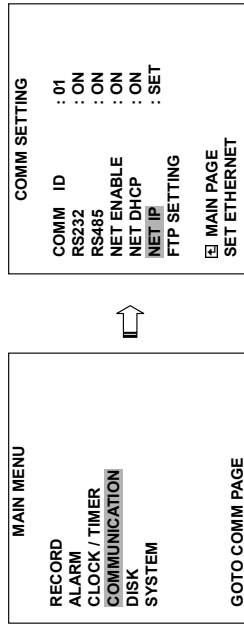

Use the “<” “>” and “v” buttons (12), and (13), to highlight the **NET IP**. Press the **Enter** button (15) to enter the **NET IP** page

- Set the **IP**, **MASK** and **GATEWAY**. Then press the **Enter** button (15) to proceed. The following is a sample setting.
 IP: 192.168.0.1
 MASK: 255.255.255.0
 GATEWAY: 0.0.0.0

* About the location of the buttons, please refer to **Page 10 2.1 Front View**.

NOTE: When only one unit of the DVR is connected to a computer or LAN, you can freely assign an IP address for the DVR. For example, there is a range of DVR IP addresses from 192.168.0.1 to 192.168.0.255. You can pick one for use from the range of the IP. It's not necessary to set MASK and GATEWAY; leave the settings as default.

When a DVR is connected to a WAN, you must acquire a unique, permanent IP address and correctly configure the MASK and GATEWAY settings according to your network architecture. If you have any questions regarding those settings, please contact a qualified MIS professional or your ISP.

NOTE: When connecting to a network, each connected DVR must be assigned a unique IP, which must be in the same class type as your network address. IP addresses are written as four sets of numbers separated by periods; for example, 192.168.0.1. Therefore, if the connected network is identified as Class C, for example, the first three sets of numbers of the DVR IP address must be the same as the network address. If the connected network is identified as Class B, the first two sets of numbers of the DVR IP address must be the same as the network address. If you have any questions regarding these settings, please contact a qualified MIS professional or your ISP.

12.3 TCP/IP Communication Software

Follow the instructions below to install the TCP/IP communication program into your computer.

- Click the Start Menu from your computer, and point to the **Settings/Control panel**.

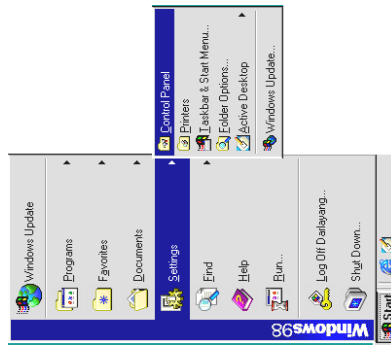

- Click the **NETWORK** icon twice to enter the **NETWORK** setting windows.



- Click on the **Configuration** tag; check if the TCP/IP is included among the network components list. If the TCP/IP is included, please process step 5. If it is not included, please follow step 4 to install the TCP/IP.

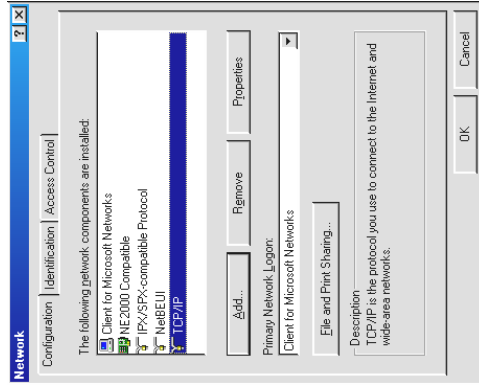

12.4 TCP/IP installation

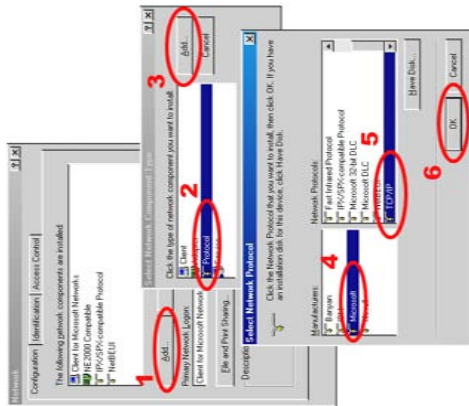

During the installation, you will be requested to insert the windows CD-ROM. After installation, the PC will be restarted.

12.5 TCP/IP Configuration setting

- Click **Start** → **Settings** → **Control Panel** → **Network**.
- Select **TCP/IP**, and then click **Properties**.
- Before processing the DVR installation in a WAN, please make sure the Internet connection works properly. If not, please contact your ISP provider.

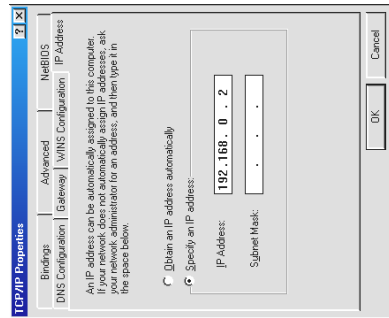
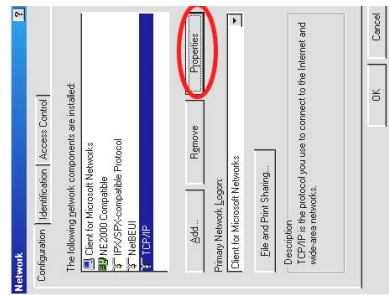

If you are using a DHCP server, please select **Obtain an IP address automatically**. Any assigned IP address for the connected DVRs must be in the same class type as the server. If there is no DHCP server, please select **specify an IP address** and type in the IP address of your PC. This IP address must be different from the DVR IP but in the same class type.

NOTE: The IP address of a DVR in a network must be unique to itself as opposed to those of the other chosen PCs, but in the same class type

12.6 Connection Testing

With the previous settings, follow the instructions below to ensure whether you have established the connection successfully.

- Click **Start** → **Programs** → **MS-DOS Prompt**

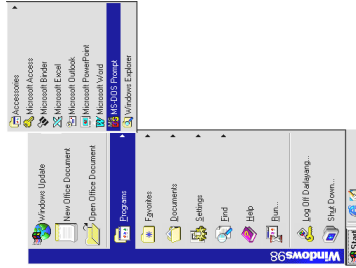

- Type in ping **192.168.0.1** then Enter. (See the sample screen below)
- **** This IP is the DVR IP address that is assigned for the connected DVR in step 2.**

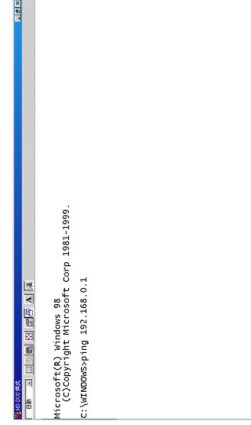

13. SPECIFICATIONS

Model Number	VR-601 U	VR-601 E
Image System	NTSC	PAL
Resolution	720 x 240 pixels 352 x 240 pixels	720 x 288 pixels 352 x 288 pixels
Video In	Composite Video In (BNC) x 1, Multiplexer Monitor In (BNC) x 1	
Video Out	Composite Video Out (BNC) x 1, Multiplexer Monitor Out (BNC) x 1	
Audio In/Out	Line In / Out (RCAx2), 16 bits, 8 kHz	
Storage Media	80 GB (can be increased up to 240 GB)	
Compression	MJPEG	
Memory Card	SD Card	
Archive	Hot Swappable Removable HD	
Watermark	Digital Signature	
Recording Rate	30 ips (720x240) 60 ips (352x240)	25 ips (720x288) 50 ips (352x288)
Image Size	Best(48KB) / High(32KB) / Standard(21KB) / Basic(16KB)	
Recording Mode	Schedule / Manual / Alarm / Circular	
Alarm Recording	Event / Pre-Alarm / Post Alarm	
Pre-Alarm Recording	100 pictures	
Playback Speeds	Frame Stepping, 1/16x, 1/8x, 1/4x, 1/2x, 1x, 2x, 4x, 8x, 16x, 30x, 100x	
Record Search	Alarm / Time / Event list / Filter(thumbnail) / SD card	
Setup Menu	Multi-layer / Network setting	
Log list	2000 records	
Alarm In/Out	1 Alarm Input / Output	
Built-in Buzzer	Yes	
Communication Port	RS-232, RS-485, and Ethernet Port	
Network Interface	Ethernet (RJ-45 10/100 base-Tx) x 1	
Network Protocol	TCP/IP, DHCP, HTTP, UDP, FTP, PPP	
Software Upgrade	Upgrade via Memory Card(SD Card) or RS-232	
Password Protection	Operation / Menu Setup / Remote Access	
Network Capabilities	Archive image as JPEG formats, Multi-brand multiplexer decoding, Remote live or recorded images	
Power Supply (AC adapter)	Input: 100V-240V, 50 Hz/60 Hz; Output: DC12V max 5A	
Dimensions	220 mm x 94 mm x 340 mm EIA 19" 2U Half Size Mountable	
Weight	About 3.9 kg	
Operation Temperature Regulation	5° C ~ 40° C (41° F ~ 104° F) FCC, CE	
Provided Accessories	AC Adapter x 1 Instruction manual x 1 Power cord x 1 CD-R x 1 Screw (#6-32UNC) x 4(see P.56), Screw (M3) x 8(not in use) Key x 2	

*Design and specifications subject to change without notice.

- If you receive a response as in the sample screen below, the connection hasn't been successfully established. Please re-check all the hardware and software installation by repeating steps 1 to 5. If you still can't establish the connection after rechecking, please contact your dealer.

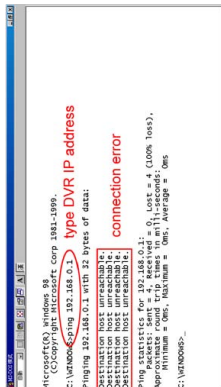

- If you receive a response as in the sample screen below, you have successfully made the connection.

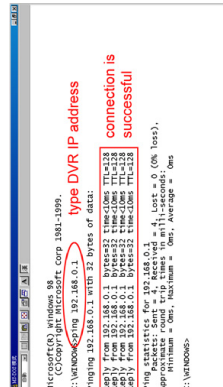

14. Compatible Multiplexers

Manufacturer	Model	N/P	Channel	COLORS	Decode on DVR	Decode on VIEWER
Sensormatic	RV2216	NTSC	16CH	COLOR	OK	OK
GYR	DSF9C	NTSC	9CH	COLOR	OK	/
ATV	DPX16	NTSC	16CH	COLOR	OK	OK
ATV	DPX9	NTSC	9CH	COLOR	OK	OK
PELCO	MX4016CD	NTSC	16CH	COLOR	OK	OK
DM	SPC2/D/N/04M	NTSC	4CH	COLOR	OK	OK
DM	SLDX16C	NTSC	16CH	COLOR	OK	OK
ROBOT	MV16	NTSC	16CH	B/W	OK	/
ROBOT	MV96	NTSC	16CH	COLOR	OK	OK
IMPAC	CBR-16CDT	NTSC	16CH	COLOR	OK	/
JPI	MP1600	NTSC	16CH	COLOR	OK	/
PANASONIC	WJ-FS616	NTSC	16CH	COLOR	OK	/
PROVIDEO	RMX-4CD	NTSC	4CH	COLOR	OK	/
PROVIDEO	RMX-16CD	NTSC	16CH	COLOR	OK	/
ATV	DPX9	PAL	9CH	COLOR	OK	OK
ATV	DPX16	PAL	16CH	COLOR	OK	OK
PELCO	MX4016CD-x	PAL	16CH	COLOR	OK	/
ENEO	VCMD-5016	PAL	16CH	COLOR	OK	/
KALATEL	CBR-16eZX	PAL	16CH	COLOR	OK	/
AVE	MULTView16CS	PAL	16CH	COLOR	OK	/
SANYO	MPX-CD92P	PAL	9CH	COLOR	OK	/
SANYO	MPX-CD163	PAL	16CH	COLOR	OK	OK

NOTE: Multiplexers not shown on this list have not been tested by the engineering team and are not recommended for use with this product. For the latest updated list on the recommended multiplexers, please contact your dealers or distributors.

Please read the followings before getting started:

PRECAUTIONS

Recording Operation Alarm Recording (P.27)

- The alarm recording is interrupted if the Video-Loss occurs during Alarm recording.

Backup Operations Mobile Rack HD Backup (P.35)

- Please operate backup (FULL / ALARM / SELECT) exclude the 2.00MB files. Otherwise backup operation may not perform correctly.

BACKUP Operations SD Card Backup (P.37)

- The maximum number of the saving images into one SD Card is 500. Please operate SD Card Backup within the object file's name (F0xxx.jpg) do not exceed 500.

Menu Setup Changing IP address (P.46)

- Please operate off and on after changing the IP address.

RS-232, RS-485 or NetViewer Operate in the Key Lock mode (P.53, P.66)

- The Playback picture reaches at the END of recorded data in HDD with key lock mode, it will continuously play back in short period near Data end and it will not stop. In such a case, please send the "STOP" command.

RS-232 & RS-485 "TIME SEARCH" command (P.54)

- When sending the "TIME SEARCH" command, please make sure to send the "STOP" command just before sending it.

NetViewer Inputting "URL Of Remote Device" (P.63)

- Do not add extra "0" when inputting "URL Of Remote Device".
(Ex. OK: 192.168.1.10, NG: 192.168.001.010)

NetViewer Save a viewing image (P.66)

- When performing successional saving images, the saving interval changes with the PC performance and the network environment.

Network Viewer Change the Record Properties (P.67)

- When the Alarm Operation is ON, The image software (Network Viewer) doesn't show the pictures and a message will be displayed.
- Please do not set up Alarm setting via the Network Viewer, if set up Alarm setting via the Network Viewer, please set up Pre-Alarm setting from MAIN MENU again. Because the displayed setup may differ from an actual setup.

Handling of the HDD

- Please do not extract the removable HDD or do not move this equipment for 15 seconds after OPERATE OFF. It may cause a failure of the HDD.

Free Manuals Download Website

<http://myh66.com>

<http://usermanuals.us>

<http://www.somanuals.com>

<http://www.4manuals.cc>

<http://www.manual-lib.com>

<http://www.404manual.com>

<http://www.luxmanual.com>

<http://aubethermostatmanual.com>

Golf course search by state

<http://golfingnear.com>

Email search by domain

<http://emailbydomain.com>

Auto manuals search

<http://auto.somanuals.com>

TV manuals search

<http://tv.somanuals.com>