

JVC

DIGITAL VIDEO CAMERA

GR-D239

Please visit our Homepage on the World Wide Web for Digital Video Camera:

<http://www.jvc.co.jp/english/cyber/>

For Accessories:

<http://www.jvc.co.jp/english/accessory/>

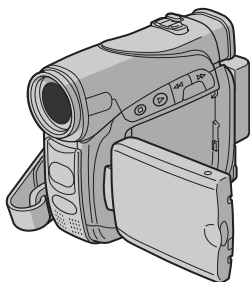

Mini **DV** PAL

Dear Customer,
Thank you for purchasing this digital video camera. Before use, please read the safety information and precautions contained in the pages 3 – 4 and 9 to ensure safe use of this product.

ENGLISH

GETTING STARTED 6

VIDEO RECORDING & PLAYBACK 17

ADVANCED FEATURES 22

REFERENCES 38

TERMS 47

INSTRUCTIONS

To deactivate the demonstration, set "DEMO MODE" to "OFF".
(☞ pg. 22, 25)

Major Features of this Camcorder

Wipe/Fader Effects

You can use the Wipe/Fader Effects to make pro-style scene transitions. (☞ pg. 33)

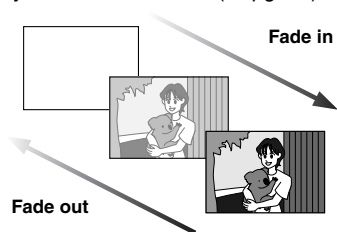

Program AE with Special Effects

For example, "SPORTS" mode allows fast-moving images to be captured one frame at a time, for vivid, stable slow-motion. (☞ pg. 34)

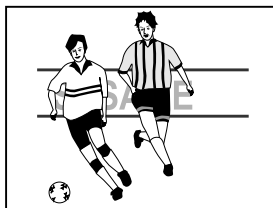

Backlight Compensation

Simply pressing the **BACK LIGHT** button brightens the image darkened by backlight. (☞ pg. 31)

- You can also select a spot metering area so that more precise exposure compensation is available. (☞ pg. 31, Spot Exposure Control)

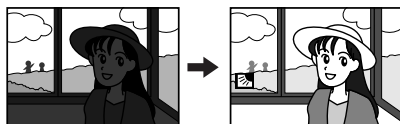

Data Battery

You can check the battery status by simply pressing the **DATA** button. (☞ pg. 12)

BATTERY CONDITION	
LEVEL	MAX TIME
100%	LCD 60min
50	FINDER 80min
0	

SAFETY PRECAUTIONS

IMPORTANT (for owners in the U.K.)
Connection to the mains supply in the United Kingdom.

DO NOT cut off the mains plug from this equipment.

If the plug fitted is not suitable for the power points in your home or the cable is too short to reach a power point, then obtain an appropriate safety approved extension lead or consult your dealer.

BE SURE to replace the fuse only with an identical approved type, as originally fitted, and to replace the fuse cover.

If nonetheless the mains plug is cut off be sure to remove the fuse and dispose of the plug immediately, to avoid possible shock hazard by inadvertent connection to the mains supply.

If this product is not supplied fitted with a mains plug then follow the instructions given below:

DO NOT make any connection to the Larger Terminal coded E or Green.

The wires in the mains lead are coloured in accordance with the following code:



Blue to N (Neutral) or Black

Brown to L (Live) or Red

If these colours do not correspond with the terminal identifications of your plug, connect as follows:

Blue wire to terminal coded N (Neutral) or coloured black.

Brown wire to terminal coded L (Live) or coloured Red.

If in doubt — consult a competent electrician.

WARNING: TO PREVENT FIRE OR SHOCK HAZARD, DO NOT EXPOSE THIS UNIT TO RAIN OR MOISTURE.

CAUTIONS:

- To prevent shock, do not open the cabinet. No user serviceable parts inside. Refer servicing to qualified personnel.
- When you are not using the AC Adapter for a long period of time, it is recommended that you disconnect the power cord from AC outlet.

CAUTION:

To avoid electric shock or damage to the unit, first firmly insert the small end of the power cord into the AC Adapter until it is no longer wobbly, and then plug the larger end of the power cord into an AC outlet.

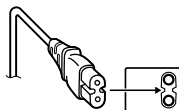

CAUTIONS:

- This camcorder is designed to be used with PAL-type colour television signals. It cannot be used for playback with a television of a different standard. However, live recording and LCD monitor/viewfinder playback are possible anywhere.
- This product includes patented and other proprietary technology and will operate only with JVC Data Battery. Use the JVC BN-VF707U/VF714U/VF733U battery packs and, to recharge them or to supply power to the camcorder from an AC outlet, use the provided multi-voltage AC Adapter. (An appropriate conversion adapter may be necessary to accommodate different designs of AC outlets in different countries.)

Caution on Replaceable lithium battery

The battery used in this device may present a fire or chemical burn hazard if mistreated.

Do not recharge, disassemble, heat above 100°C or incinerate.

Replace battery with Panasonic (Matsushita Electric), Sanyo, Sony or Maxell CR2025.

Danger of explosion or Risk of fire if the battery is incorrectly replaced.

- Dispose of used battery promptly.
- Keep away from children.
- Do not disassemble and do not dispose of in fire.

NOTES:

- The rating plate (serial number plate) and safety caution are on the bottom and/or the back of the main unit.
- The rating information and safety caution of the AC Adapter are on its upper and lower sides.

When the equipment is installed in a cabinet or on a shelf, make sure that it has sufficient space on all sides to allow for ventilation (10 cm or more on both sides, on top and at the rear).

Do not block the ventilation holes.

(If the ventilation holes are blocked by a newspaper, or cloth etc. the heat may not be able to get out.)

No naked flame sources, such as lighted candles, should be placed on the apparatus.

When discarding batteries, environmental problems must be considered and the local rules or laws governing the disposal of these batteries must be followed strictly.

The apparatus shall not be exposed to dripping or splashing.

Do not use this equipment in a bathroom or places with water.

Also do not place any containers filled with water or liquids (such as cosmetics or medicines, flower vases, potted plants, cups etc.) on top of this unit. (If water or liquid is allowed to enter this equipment, fire or electric shock may be caused.)

Do not point the lens or the viewfinder directly into the sun. This can cause eye injuries, as well as lead to the malfunctioning of internal circuitry. There is also a risk of fire or electric shock.

CAUTION!

The following notes concern possible physical damage to the camcorder and to the user.

When carrying, be sure to always securely attach and use the provided strap. Carrying or holding the camcorder by the viewfinder and/or the LCD monitor can result in dropping the unit, or in a malfunction.

Take care not to get your finger caught in the cassette holder cover. Do not let children operate the camcorder, as they are particularly susceptible to this type of injury.

Do not use a tripod on unsteady or unlevel surfaces. It could tip over, causing serious damage to the camcorder.

CAUTION!

Connecting cables (Audio/Video, S-Video, etc.) to the camcorder and leaving it on top of the TV is not recommended, as tripping on the cables will cause the camcorder to fall, resulting in damage.

SOME DO'S AND DON'TS ON THE SAFE USE OF EQUIPMENT

This equipment has been designed and manufactured to meet international safety standards but, like any electrical equipment, care must be taken if you are to obtain the best results and safety is to be assured.

DO read the operating instructions before you attempt to use the equipment.

DO ensure that all electrical connections (including the mains plug, extension leads and interconnections between pieces of equipment) are properly made and in accordance with the manufacturer's instructions. Switch off and withdraw the mains plug when making or changing connections.

DO consult your dealer if you are ever in doubt about the installation, operation or safety of your equipment.

DO be careful with glass panels or doors on equipment.

DON'T continue to operate the equipment if you are in any doubt about it working normally, or if it is damaged in any way — switch off, withdraw the mains plug and consult your dealer.

DON'T remove any fixed cover as this may expose dangerous voltages.

DON'T leave equipment switched on when it is unattended unless it is specifically stated that it is designed for unattended operation or has a standby mode. Switch off using the switch on the equipment and make sure that your family knows how to do this. Special arrangements may need to be made for infirm or handicapped people.

DON'T use equipment such as personal stereos or radios so that you are distracted from the requirements of road safety. It is illegal to watch television whilst driving.

DON'T listen to headphones at high volume, as such use can permanently damage your hearing.

DON'T obstruct the ventilation of the equipment, for example with curtains or soft furnishings. Overheating will cause damage and shorten the life of the equipment.

DON'T use makeshift stands and NEVER fix legs with wood screws — to ensure complete safety always fit the manufacturer's approved stand or legs with the fixings provided according to the instructions.

DON'T allow electrical equipment to be exposed to rain or moisture.

ABOVE ALL

- NEVER let anyone especially children push anything into holes, slots or any other opening in the case — this could result in a fatal electrical shock;
- NEVER guess or take chances with electrical equipment of any kind — it is better to be safe than sorry!

GETTING STARTED	6	ADVANCED FEATURES	22
Index.....	6	MENUS FOR DETAILED ADJUSTMENT.....	22
Provided Accessories	10	Changing The Menu Settings	22
Power.....	11	Recording Menus.....	23
Operation Mode.....	13	Playback Menus	26
Language Settings.....	14	FEATURES FOR RECORDING.....	28
Date/Time Settings	14	5-Second Recording.....	28
Grip Adjustment.....	14	Night-Scope.....	28
Viewfinder Adjustment.....	15	Snapshot (For Video Recording)	29
Brightness Adjustment Of The Display.....	15	Manual Focus.....	29
Tripod Mounting.....	15	Exposure Control.....	30
Loading/Unloading A Cassette.....	16	Iris Lock	30
VIDEO RECORDING & PLAYBACK	17	Backlight Compensation.....	31
VIDEO RECORDING	17	Spot Exposure Control.....	31
Basic Recording.....	17	White Balance Adjustment.....	32
Tape Remaining Time	17	Manual White Balance Adjustment.....	32
LCD Monitor And Viewfinder	18	Wipe Or Fader Effects	33
Zooming.....	18	Program AE With Special Effects	34
Journalistic Shooting	19	EDITING.....	35
Time Code.....	19	Dubbing To A VCR	35
Quick Review.....	19	Dubbing To A Video Unit Equipped With A DV	
Recording From The Middle Of A Tape.....	19	Connector (Digital Dubbing)	36
VIDEO PLAYBACK	20	Connection To A Personal Computer.....	37
Normal Playback.....	20	REFERENCES	38
Still Playback	20	TROUBLESHOOTING	38
Shuttle Search.....	20	USER MAINTENANCE.....	42
Blank Search	20	CAUTIONS	43
Connections To A TV Or VCR.....	21	SPECIFICATIONS.....	46
		TERMS	47

Index

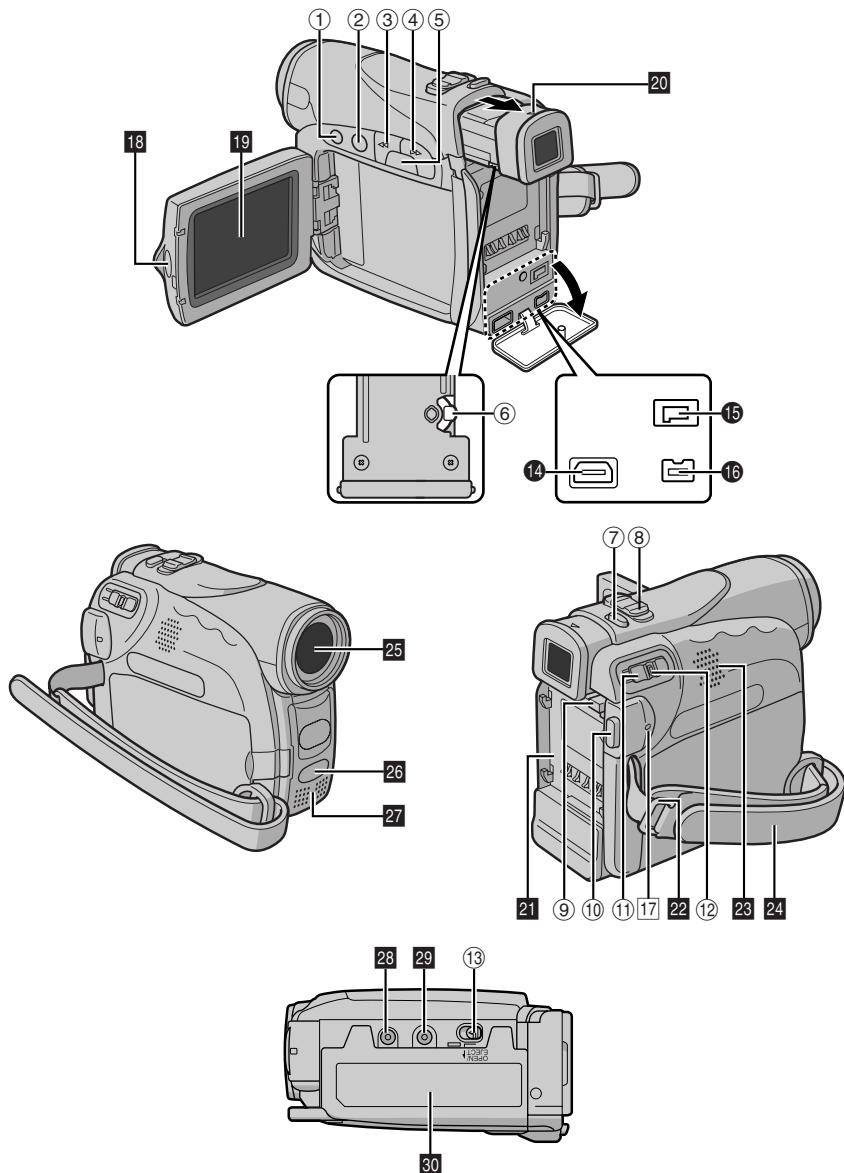

Controls

- ① Stop Button [■] (☞ pg. 20)
Backlight Compensation Button [BACK LIGHT] (☞ pg. 31)
- ② Play/Pause Button [▶/⏸] (☞ pg. 20)
Manual Focus Button [FOCUS] (☞ pg. 29)
- ③ Rewind Button [◀◀] (☞ pg. 20)
Menu select Button [-] (☞ pg. 14)
Quick Review Button [Ⓞ] (☞ pg. 19)
- ④ Fast-Forward Button [▶▶] (☞ pg. 20)
Menu select Button [+] (☞ pg. 14)
Night Button [NIGHT] (☞ pg. 28)
- ⑤ Menu Button [MENU] (☞ pg. 22)
Data Battery Button [DATA] (☞ pg. 12)
- ⑥ Dioptre Adjustment Control (☞ pg. 15)
- ⑦ Snapshot Button [SNAPSHOT] (☞ pg. 29)
- ⑧ Power Zoom Lever [T/W] (☞ pg. 18)
Speaker Volume Control [VOL. +, -] (☞ pg. 20)
- ⑨ Battery Release Button [PUSH BATT.] (☞ pg. 11)
- ⑩ Recording Start/Stop Button (☞ pg. 17)
- ⑪ Power Switch [A, M, PLAY, OFF] (☞ pg. 13)
- ⑫ Lock Button (☞ pg. 13)
- ⑬ Cassette Open/Eject Switch [OPEN/EJECT] (☞ pg. 16)

Connectors

The connectors are located beneath the covers.

- ⑭ S-Video/Audio/Video Output Connector [S/AV] (☞ pg. 21, 35)
- ⑮ DC Input Connector [DC] (☞ pg. 11)
- ⑯ Digital Video Connector [DV OUT] (i.Link*) (☞ pg. 36, 37)

* i.Link refers to the IEEE1394-1995 industry specification and extensions thereof. The  logo is used for products compliant with the i.Link standard.

Indicators

- ⑰ POWER/CHARGE Lamp (☞ pg. 11, 17)

Other Parts

- ⑱ Monitor Latch (☞ pg. 18)
- ⑲ LCD Monitor (☞ pg. 18, 19)
- ⑳ Viewfinder (☞ pg. 15)
- ㉑ Battery Pack Mount (☞ pg. 12)
- ㉒ Shoulder Strap Eyelet (☞ pg. 11)
- ㉓ Speaker (☞ pg. 20)
- ㉔ Grip Strap (☞ pg. 14)
- ㉕ Lens
- ㉖ Camera Sensor
(Be careful not to cover this area, a sensor necessary for shooting is built-in here.)
- ㉗ Stereo Microphone
- ㉘ Stud Hole (☞ pg. 15)
- ㉙ Tripod Mounting Socket (☞ pg. 15)
- ㉚ Cassette Holder Cover (☞ pg. 16)

LCD Monitor/Viewfinder Indications

During Video Recording

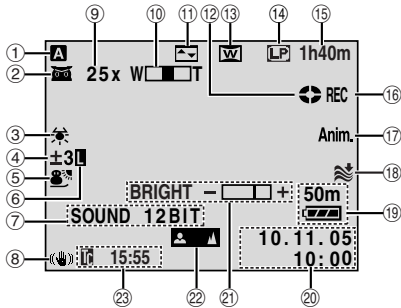

- ① Operation Mode (☞ pg. 13)
- ② : Night-Scope Indicator (☞ pg. 28)
- ③ : Gain Up Mode (☞ pg. 23)
- ④ : White Balance Indicator (☞ pg. 32)
- ⑤ : Spot Exposure Control Indicator (☞ pg. 31)
- ⑥ : Backlight Compensation Indicator (☞ pg. 31)
- ⑦ : Exposure Adjustment Indicator (☞ pg. 30)
- ⑧ : Selected Program AE With Special Effects Indicator (☞ pg. 34)
- ⑨ : Iris Lock Indicator (☞ pg. 30)
- ⑦ SOUND 12BIT/16BIT: Sound Mode Indicator (☞ pg. 23) (Appears for approx. 5 seconds after turning on the camcorder.)
- ⑧ : Digital Image Stabiliser (“DIS”) (☞ pg. 24)
- ⑨ : Approximate Zoom Ratio (☞ pg. 18)
- ⑩ : Zoom Indicator (☞ pg. 18)
- ⑪ : Selected Wipe/Fader Effect Indicator (☞ pg. 33)
- ⑫ : Tape Running Indicator (☞ pg. 17) (Rotates while tape is running.)
- ⑬ : Selected Wide Mode Indicator (☞ pg. 24)
- ⑭ : Recording Speed Mode (SP/LP) (☞ pg. 23)
- ⑮ : Tape Remaining Time (☞ pg. 17)
- ⑯ REC: (Appears during recording.) (☞ pg. 17)
- ⑰ PAUSE: (Appears during Record-Standby mode.) (☞ pg. 17)
- ⑱ PHOTO: (Appears when taking Snapshot.) (☞ pg. 29)
- ⑰ 5S/Anim.: Displays the 5-Second Recording mode or Animation recording mode. (☞ pg. 24)
- ⑱ : Wind Cut Indicator (☞ pg. 24)
- ⑲ : Battery Remaining Power Indicator (☞ pg. 40)
- ⑳ : Date/Time (☞ pg. 14)

- ⑳ Brightness Control Indicator (LCD monitor/Viewfinder) (☞ pg. 15)
- ㉑ Manual Focus Adjustment Indicator (☞ pg. 29)
- ㉒ Time Code (☞ pg. 26, 27)

During Video Playback

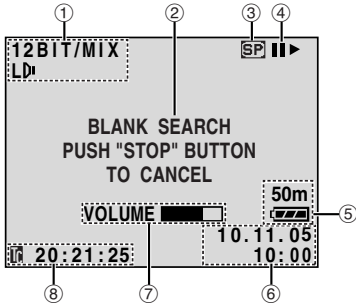

- ① Sound Mode Indicator (☞ pg. 26)
- ② Blank Search Indicator (☞ pg. 20)
- ③ Tape Speed (☞ pg. 23)
- ④ ▶: Playback
▶▶: Fast-Forward/Shuttle Search
◀◀: Rewind/Shuttle Search
⏸: Pause
⏪▶: Forward Frame-By-Frame Playback/
Slow-Motion
◀⏪: Reverse Frame-By-Frame Playback/
Slow-Motion
- ⑤ Battery Remaining Power Indicator (☞ pg. 40)
- ⑥ Date/Time (☞ pg. 26, 27)
- ⑦ VOLUME: Volume Level Indicator (☞ pg. 20)
BRIGHT: Brightness Control Indicator (LCD monitor/Viewfinder) (☞ pg. 15)
- ⑧ Time Code (☞ pg. 26, 27)

Before Using This Camcorder

Make sure you only use cassettes with the Mini DV mark .

This camcorder is designed exclusively for the digital video cassette. Only cassettes marked “Mini DV” can be used with this unit.

Remember that this camcorder is not compatible with other digital video formats.

Remember that this camcorder is intended for private consumer use only.

Any commercial use without proper permission is prohibited. (Even if you record an event such as a show, performance or exhibition for personal enjoyment, it is strongly recommended that you obtain permission beforehand.)

Before recording important video, be sure to make a trial recording.

Play back your trial recording to make sure the video and audio have been recorded properly.

We recommend cleaning your video heads before use.

If you haven't used your camcorder for a while, the heads may be dirty. We recommend periodically cleaning the video heads with a cleaning cassette (optional).

Be sure to store your cassette tapes and camcorder in the proper environment.

Video heads can become dirty more easily if your cassette tapes and camcorder are stored in a dusty area. Cassette tapes should be removed from the camcorder and stored in cassette cases. Store the camcorder in a bag or other container.

Use SP (Standard) mode for important video recordings.

LP (Long Play) mode lets you record 50% more video than SP (Standard) mode, but you may experience mosaic-like noise during playback depending on the tape characteristics and the usage environment.

So, for important recordings, we recommend using SP mode.

It is recommended that you use JVC brand cassette tapes.

Your camcorder is compatible with all brands of commercially available cassette tapes complying with the MiniDV standard, but JVC brand cassette tapes are designed and optimized to maximize the performance of your camcorder.

Also read “CAUTIONS” on pages 43 – 45.

Provided Accessories

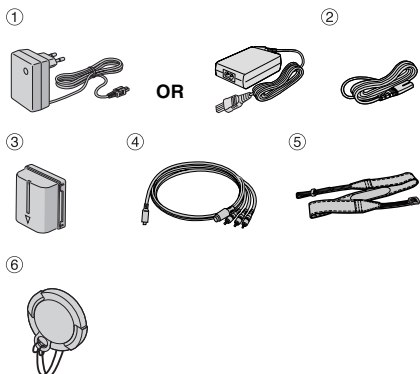

How To Attach The Lens Cap

To protect the lens, attach the provided lens cap to the camcorder as shown in the illustration.

NOTE:

To confirm the lens cap is on correctly make sure the cap is flush to the camcorder.

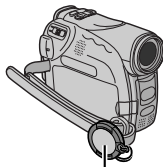

Place here during shooting.



- ① AC Adapter AP-V17E or AP-V14E
- ② Power Cord (only for AP-V14E)
- ③ Battery Pack BN-VF707U
- ④ S/AV Cable
- ⑤ Shoulder Strap (see pg. 11 for attachment)
- ⑥ Lens Cap (see the right column for attachment)

NOTES:

- In order to maintain optimum performance of the camcorder, provided cables may be equipped with one or more core filter. If a cable has only one core filter, the end that is closest to the filter should be connected to the camcorder.
- Make sure to use the provided cables for connections. Do not use any other cables.

How To Attach The Shoulder Strap

Follow the illustration.

- 1** Thread the strap through the eyelet.
- 2** Fold it back and thread it through the strap guide and the buckle.
 - To adjust the length of the strap, loosen and then tighten the strap in the buckle.
- 3** Slide the strap guide fully towards the eyelet.

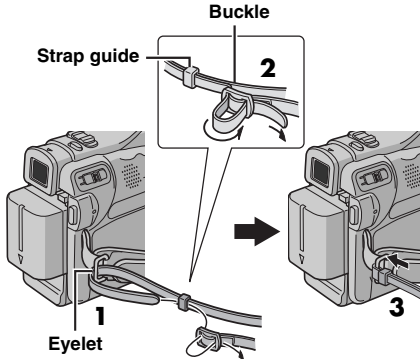

Power

This camcorder's 2-way power supply system lets you choose the most appropriate source of power. Do not use provided power supply units with other equipment.

Charging The Battery Pack

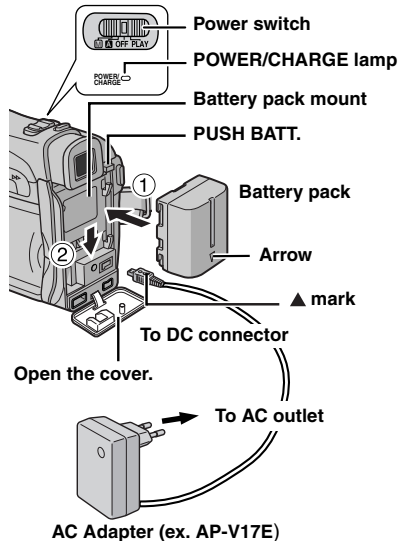

- 1** Set the Power Switch to "OFF".
- 2** With the arrow on the battery pack pointing downward, push the battery pack slightly against the battery pack mount ①.
- 3** Slide down the battery pack until it locks in place ②.
- 4** Connect the AC Adapter to the camcorder.
- 5** Connect the Power Cord to the AC Adapter. (AP-V14E only)
- 6** Plug the AC Adapter into an AC outlet. The POWER/CHARGE lamp on the camcorder blinks to indicate charging has started.
- 7** When the POWER/CHARGE lamp goes out, charging is finished. Unplug the AC Adapter from the AC outlet. Disconnect the AC Adapter from the camcorder.

To detach the battery pack

Slide the battery pack upward while pressing **PUSH BATT.** to detach it.

Battery pack	Charging time
BN-VF707U*	Approx. 1 hr. 30 min.
BN-VF714U	Approx. 2 hr. 40 min.
BN-VF733U	Approx. 5 hr. 40 min.

* Provided

NOTES:

- **This product includes patented and other proprietary technology and will operate only with JVC Data Battery. Use the JVC BN-VF707U/VF714U/VF733U battery packs. Using generic non-JVC batteries can cause damage to the internal charging circuitry.**
- If the protective cap is attached to the battery pack, remove it first.
- During charging, the camcorder cannot be operated.
- Charging is not possible if the wrong type of battery is used.
- When charging the battery pack for the first time or after a long storage period, the POWER/CHARGE lamp may not light. In this case, remove the battery pack from the camcorder, then try charging again.
- If the battery operation time remains extremely short even after having been fully charged, the battery is worn out and needs to be replaced. Please purchase a new one.
- Since the AC Adapter processes electricity internally, it becomes warm during use. Be sure to use it only in well-ventilated areas.
- Using the optional AA-VF7 Battery Charger, you can charge the BN-VF707U/VF714U/VF733U battery pack without the camcorder.
- After 5 minutes has elapsed in Record-Standby mode with the cassette inserted, the camcorder will automatically turn off its power supplied from the AC adapter. In this case, the battery charge starts if the battery is attached to the camcorder.

Using The Battery Pack

Perform steps **2 – 3** in "Charging The Battery Pack".

Maximum continuous recording time

Battery pack	LCD monitor on	Viewfinder on
BN-VF707U*	1 hr. 5 min.	1 hr. 25 min.
BN-VF714U	2 hr. 20 min.	3 hr.
BN-VF733U	5 hr. 25 min.	7 hr. 5 min.

* Provided

NOTES:

- Recording time is reduced significantly under the following conditions:
 - Zoom or Record-Standby mode is engaged repeatedly.
 - The LCD monitor is used repeatedly.
 - The playback mode is engaged repeatedly.
- Before extended use, it is recommended that you prepare enough battery packs to cover 3 times the planned shooting time.

ATTENTION:

Before detaching the power source, make sure that the camcorder's power is turned off. Failure to do so can result in a camcorder malfunction.

Data Battery System

You can check the remaining battery power and the recordable time.

- 1) Make sure the battery is attached and the Power Switch is set to "OFF".
- 2) Open the LCD monitor fully.
- 3) Press **DATA**, and the battery status screen appears.
 - It can be displayed on the viewfinder when the LCD monitor is closed.
 - It is displayed for 5 seconds if the button is pressed and released quickly, and for 15 seconds if the button is pressed and hold for several seconds.
 - If "COMMUNICATION ERROR" appears instead of the battery status even though you tried to press **DATA** several times, there may be a problem on the battery. In such a case, consult your nearest JVC dealer.

Using AC Power

Perform steps **4** – **5** in “Charging The Battery Pack”.

NOTE:

The provided AC Adapter features automatic voltage selection in the AC range from 110 V to 240 V.

About Batteries

DANGER! Do not attempt to take the batteries apart, or expose them to flame or excessive heat, as it may cause a fire or explosion.

WARNING! Do not allow the battery or its terminals to come in contact with metals, as this can result in a short circuit and possibly start a fire.

To resume the original function of the accurate battery power indication

If the battery power indication differs from the actual operating time, fully charge the battery, and then run it down. However this function may not turn back if the battery was used for a long period of time under extremely high/low temperature condition or charged too many times.

Operation Mode

To turn on the camcorder, set the Power Switch to any operation mode except “OFF” while pressing down the Lock Button located on the switch.

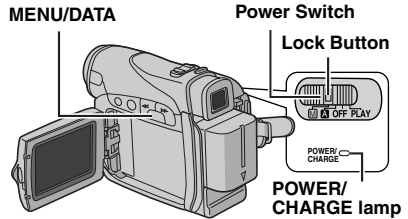

Choose the appropriate operation mode according to your preference using the Power Switch.

Power Switch Position

A (Full Auto Recording):

Allows you to record using NO special effects or manual adjustments. Suitable for standard recording.

The “**A**” indicator appears on the display.

M (Manual Recording):

Allows you to set various recording functions using the Menu. (pg. 22)

If you want more creative capabilities than Full Auto Recording, try this mode.

OFF:

Allows you to switch off the camcorder.

PLAY:

- Allows you to play back a recording on the tape.
- Allows you to set various playback functions using the Menu. (pg. 22)

Power-Linked Operation

When the Power Switch is set to "A" or "M", you can also turn on/off the camcorder by opening/closing the LCD monitor or pulling out/pushing in the viewfinder.

INFORMATION:

The following explanations in this manual suppose the use of LCD monitor in your operation. If you want to use the viewfinder, close the LCD monitor and pull out the viewfinder fully.

Language Settings

The language on the display can be changed. (pg. 22, 26, 27)

1 Set the Power Switch to "M" while pressing down the Lock Button located on the switch.

2 Open the LCD monitor fully. (pg. 18)

3 Press **MENU**. The Menu Screen appears.

4 Press + or - to select "CAMERA DISPLAY", and press **MENU**.

The CAMERA DISPLAY Menu appears.

5 Press + or - to select "LANGUAGE", and press **MENU**.

6 Press + or - to select the desired language, and press **MENU**.

7 Press + or - to select "RETURN", and press **MENU** twice. The Menu Screen closes.

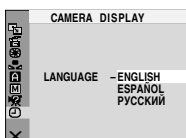
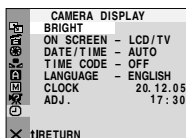

Date/Time Settings

The date/time is recorded onto the tape at all times, but its display can be turned on or off during playback. (pg. 22, 27)

1 Perform steps **1** - **4** in "Language Settings" on the left column.

2 Press + or - to select "CLOCK ADJ.", and press **MENU**. The parameter for "Day" is highlighted.

3 Press + or - to input the day, and press **MENU**. Repeat to input the month, year, hour and minute.

4 Press + or - to select "RETURN", and press **MENU** twice. The Menu Screen closes.

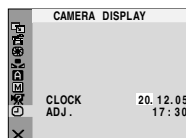

Grip Adjustment

1 Adjust the velcro strip.

2 Pass your right hand through the loop and grasp the grip.

3 Adjust your thumb and fingers through the grip to easily operate the Recording Start/Stop Button, Power Switch and Power Zoom Lever. Be sure to fasten the velcro strip to your preference.

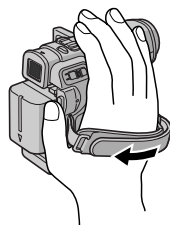

Viewfinder Adjustment

- 1 Set the Power Switch to "A" or "M" while pressing down the Lock Button located on the switch.
- 2 Make sure the LCD monitor is closed and locked. Pull out the viewfinder fully and adjust it manually for best viewability.
- 3 Turn the Dioptre Adjustment Control until the indications in the viewfinder are clearly focused.

Example:

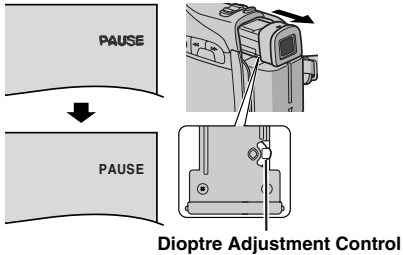

Dioptre Adjustment Control

CAUTION:

When retracting the viewfinder, take care not to pinch your fingers.

Brightness Adjustment Of The Display

- 1 Set the Power Switch to "M" or "PLAY" while pressing down the Lock Button located on the switch.
- 2 Open the LCD monitor fully. (☞ pg. 18)
 - To adjust the brightness of the viewfinder, pull out the viewfinder fully and set "PRIORITY" to "FINDER" (☞ pg. 22, 25).
- 3 Press **MENU**. The Menu Screen appears.
- 4 Press + or - to select "☺", and press **MENU**. The CAMERA DISPLAY or VIDEO DISPLAY Menu appears.
- 5 Press + or - to select "BRIGHT", and press **MENU**. The Menu Screen closes and the brightness control indicator appears.
- 6 Press + or - until the appropriate brightness is reached.
- 7 Press **MENU** to clear the brightness control indicator from the display.

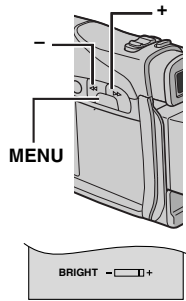

GETTING STARTED

Tripod Mounting

To attach the camcorder to a tripod, align the direction stud and screw to the mounting socket and stud hole on the camcorder. Then tighten the screw clockwise.

- Some tripods are not equipped with studs.

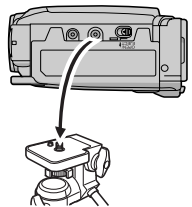

Loading/Unloading A Cassette

The camcorder needs to be powered up to load or eject a cassette.

Cassette holder

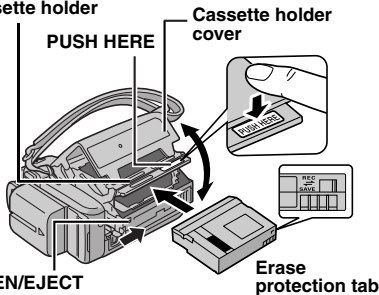

OPEN/EJECT

Make sure the window side is facing out.

Erase protection tab

1 Slide and hold **OPEN/EJECT** in the direction of the arrow, then pull the cassette holder cover open until it locks. The cassette holder opens automatically.

- Do not touch internal components.

2 Insert or remove a tape and press “PUSH HERE” to close the cassette holder.

- Be sure to press only the section labelled “PUSH HERE” to close the cassette holder; touching other parts may cause your finger to get caught in the cassette holder, resulting in injury or product damage.
- Once the cassette holder is closed, it recedes automatically. Wait until it recedes completely before closing the cassette holder cover.
- When the battery pack's charge is low, you may not be able to close the cassette holder cover. Do not apply force. Replace the battery pack with a fully charged one or use AC power before continuing.

3 Close the cassette holder cover firmly until it locks into place.

To protect valuable recordings

Slide the erase protection tab on the back of the tape in the direction of “SAVE”. This prevents the tape from being recorded over. To record on this tape, slide the tab back to “REC” before loading it.

NOTES:

- If you wait a few seconds and the cassette holder does not open, close the cassette holder cover and try again. If the cassette holder still does not open, turn the camcorder off then on again.
- If the tape does not load properly, open the cassette holder cover fully and remove the cassette. A few minutes later, insert it again.
- When the camcorder is suddenly moved from a cold place to a warm environment, wait a short time before opening the cassette holder cover.

Basic Recording

NOTE:

Before continuing, perform the procedures listed below:

- Power (⇨ pg. 11)
- Loading A Cassette (⇨ pg. 16)

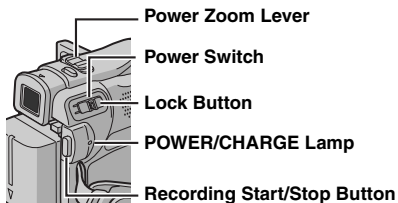

- 1 Remove the lens cap. (⇨ pg. 10)
- 2 Open the LCD monitor fully.
- 3 Set the Power Switch to "A" or "M" while pressing down the Lock Button located on the switch.
 - The POWER/CHARGE lamp lights and the camcorder enters the Record-Standby mode. "PAUSE" is displayed.
 - To record in LP (Long Play) mode, ⇨ pg. 23.
- 4 To start recording, press the Recording Start/Stop Button. "REC" appears on the display while recording is in progress.
- 5 To stop recording, press the Recording Start/Stop Button again. The camcorder re-enters the Record-Standby mode.

Approximate recording time

Tape	Recording mode	
	SP	LP
30 min.	30 min.	45 min.
60 min.	60 min.	90 min.
80 min.	80 min.	120 min.

NOTES:

- If the Record-Standby mode continues for 5 minutes, the camcorder's power shuts off automatically. To turn the camcorder on again, push back and pull out the viewfinder again or close and re-open the LCD monitor.
- When a blank portion is left between recorded scenes on the tape, the time code is interrupted and errors may occur when editing the tape. To avoid this, refer to "Recording From The Middle Of A Tape" (⇨ pg. 19).
- To turn the beep sounds off, ⇨ pg. 22, 25.

Tape Remaining Time

Approximate tape remaining time appears on the display.

"- h - - m" means the camcorder is calculating the remaining time. When the remaining time reaches 2 minutes, the indication starts blinking.

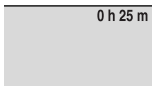

- The time required to calculate and display the remaining tape length, and the accuracy of the calculation, may vary according to the type of tape used.

LCD Monitor And Viewfinder

While using the LCD monitor:

Make sure the viewfinder is pushed back in. Pull on the end (A) of the LCD monitor and open the LCD monitor fully. It can rotate 270° (90° downward, 180° upward).

While using the viewfinder:

Make sure the LCD monitor is closed and locked. Pull out the viewfinder fully.

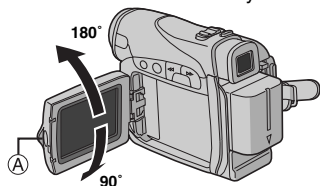

NOTES:

- The image will not appear simultaneously on the LCD monitor and the viewfinder. When the viewfinder is pulled out while the LCD monitor is opened, you can select which one to use. Set "PRIORITY" to the desired mode in SYSTEM Menu. (⇨ pg. 22, 25)
- Coloured bright spots may appear all over the LCD monitor or the viewfinder. However, this is not a malfunction. (⇨ pg. 39)

Zooming

Produces the zoom in/out effect, or an instantaneous change in image magnification.

Zoom In

Slide the Power Zoom Lever towards "T".

Zoom Out

Slide the Power Zoom Lever towards "W".

- The further you slide the Power Zoom Lever, the quicker the zoom action.

Zoom in (T: Telephoto)



Zoom out (W: Wide angle)

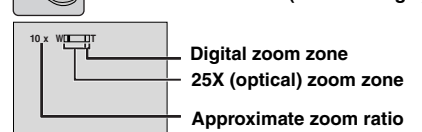

NOTES:

- Focusing may become unstable during Zooming. In this case, set the zoom while in Record-Standby, lock the focus by using the manual focus (⇨ pg. 29), then zoom in or out in Record mode.
- Zooming is possible to a maximum of 800X, or it can be switched to 25X magnification using the optical zoom. (⇨ pg. 23)
- Zoom magnification of over 25X is done through Digital image processing, and is therefore called Digital Zoom.
- During Digital zoom, the quality of image may suffer.
- Macro shooting (as close as approx. 5 cm to the subject) is possible when the Power Zoom Lever is set all the way to "W". Also see "TELE MACRO" in MANUAL Menu on page 24.
- When shooting a subject close to the lens, zoom out first. If zoomed-in in the auto focus mode, the camcorder may automatically zoom out depending on the distance between the camcorder and the subject. This will not occur when "TELE MACRO" is set to "ON". (⇨ pg. 24)

Journalistic Shooting

In some situations, different shooting angles may provide more dramatic results. Hold the camcorder in the desired position and tilt the LCD monitor in the most convenient direction. It can rotate 270° (90° downward, 180° upward).



Time Code

During recording, a time code is recorded on the tape. This code is to confirm the location of the recorded scene on the tape during playback.

Display

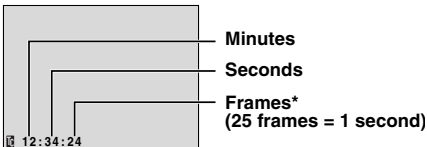

* Frames are not displayed during recording.

If recording starts from a blank portion, the time code begins counting from "00:00:00" (minute:second:frame). If recording starts from the end of a previously recorded scene, the time code continues from the last time code number. If during recording a blank portion is left partway through the tape, the time code is interrupted. When recording is resumed, the time code starts counting up again from "00:00:00". This means the camcorder may record the same time codes as those existing in a previously recorded scene. To prevent this, perform Recording From The Middle Of A Tape (pg. 19) in the following cases;

- When shooting again after playing back a recorded tape.
- When power shuts off during shooting.
- When a tape is removed and re-inserted during shooting.
- When shooting using a partially recorded tape.
- When shooting on a blank portion located partway through the tape.
- When shooting again after shooting a scene then opening/closing the cassette holder cover.

NOTES:

- The time code cannot be reset.
- During fast-forwarding and rewinding, the time code indication does not move smoothly.
- The time code is displayed only when "TIME CODE" is set to "ON". (pg. 26)

Quick Review

Enables to check the end of the last recording.

- 1) Press  during the Recording-Standby mode.
- 2) Tape is rewound for about several seconds and played back automatically, then pauses in the Recording-Standby mode for the next shot.
- Distortion may occur at start of playback. This is normal.

Recording From The Middle Of A Tape

- 1) Play back a tape or use Blank Search (pg. 20) to find the spot at which you want to start recording, then engage the Still Playback mode. (pg. 20)
- 2) Set the Power Switch to "A" or "B" while pressing down the Lock Button located on the switch, then start recording.

Normal Playback

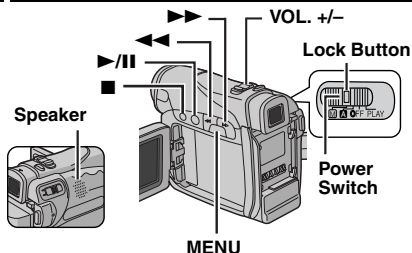

- 1 Load a cassette. (☞ pg. 16)
- 2 Set the Power Switch to "PLAY" while pressing down the Lock Button located on the switch.
- 3 To start playback, press ►/II.
- 4 To stop playback, press ■.
 - During Stop mode, press ◀◀ to rewind, or ▶▶ to fast-forward the tape.

To control the speaker volume

Slide the Power Zoom Lever (VOL. +/-) towards " +" to turn up the volume, or towards " - " to turn down the volume.

NOTES:

- The playback picture can be viewed in the LCD monitor, viewfinder or on a connected TV. (☞ pg. 21)
- If Stop mode continues for 5 minutes when power is supplied from a battery, the camcorder shuts off automatically. To turn on again, set the Power Switch to "OFF", then to "PLAY".
- When a cable is connected to the S/AV connector, the sound is not heard from the speaker.

Still Playback

Pauses during video playback.

- 1) Press ►/II during playback.
 - 2) To resume normal playback, press ►/II again.
- If still playback continues for more than about 3 minutes, the camcorder's Stop mode is automatically engaged.

Shuttle Search

Allows high-speed search in either direction during video playback.

- 1) During playback, press ►► for forward search, or ◀◀ for reverse search.
- 2) To resume normal playback, press ►/II.
 - During playback, press and hold ►► or ◀◀. The search continues as long as you hold the button. Once you release the button, normal playback resumes.
 - A slight mosaic effect appears on the display during Shuttle Search. This is not a malfunction.

ATTENTION:

During Shuttle Search, parts of the picture may not be clearly visible, particularly on the left side of the screen.



Blank Search

Helps you find where you should start recording in the middle of a tape to avoid time code interruption. (☞ pg. 19)

- 1 Load a cassette. (☞ pg. 16)
- 2 Set the Power Switch to "PLAY" while pressing down the Lock Button located on the switch.
- 3 Press **MENU**. The Menu Screen appears.
- 4 Press **MENU** to select "☐". The VIDEO Menu appears.
- 5 Press + or - to select "BLANK SRCH", and press **MENU**. The Sub Menu appears.
- 6 Press + or - to select "EXECUTE", and press **MENU**.
 - The "BLANK SEARCH" indication appears and the camcorder automatically starts reverse or forward search, then stops at the spot which is about 3 seconds of tape before the beginning of the detected blank portion.
 - To cancel Blank Search midway, press ■.

NOTES:

- Before starting Blank Search, if the current position is at a blank portion, the camcorder searches in the reverse direction. If the current position is at a recorded portion, the camcorder searches in the forward direction.
- If the beginning or end of the tape is reached during Blank Search, the camcorder stops automatically.
- A blank portion which is shorter than 5 seconds of tape may not be detected.

- The detected blank portion may be located between recorded scenes. Before you start recording, make sure there is no recorded scene after the blank portion.

Connections To A TV Or VCR

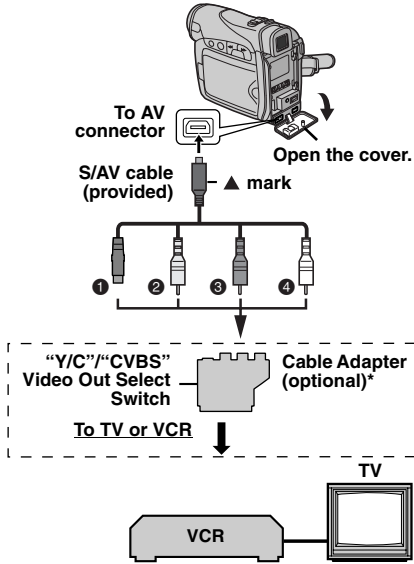

- 1 Black to S-VIDEO IN (Connect when your TV/VCR has S-VIDEO IN and A/V input connectors. In this case, it is not necessary to connect the yellow video cable.)
 - 2 Yellow to VIDEO IN (Connect when your TV/VCR has only A/V input connectors.)
 - 3 Red to AUDIO R IN**
 - 4 White to AUDIO L IN**
- * If your VCR has a SCART connector, use the cable adapter (optional).
- ** Not required for watching still images only.

NOTE:

Set the video out select switch of the cable adapter as required:

Y/C: When connecting to a TV or VCR which accepts Y/C signals and uses an S-Video cable.

CVBS: When connecting to a TV or VCR which does not accept Y/C signals and uses an audio/video cable.

- 1 Make sure all units are turned off.
- 2 Connect the camcorder to a TV or VCR as shown in the illustration.
- If using a VCR, go to step 3. If not, go to step 4.
- 3 Connect the VCR output to the TV input, referring to your VCR's instruction manual.
- 4 Turn on the camcorder, the VCR and the TV.
- 5 Set the VCR to its AUX input mode, and set the TV to its VIDEO mode.
- 6 Start playback on the camcorder. (▶ pg. 20)

To choose whether or not the following displays appear on the connected TV

- Date/Time
Set "DATE/TIME" to "AUTO", "ON" or "OFF". (▶ pg. 22, 27)
- Time Code
Set "TIME CODE" to "ON" or "OFF". (▶ pg. 22, 27)
- Indications other than date/time and time code
Set "ON SCREEN" to "OFF", "LCD" or "LCD/TV". (▶ pg. 22, 27)

NOTES:

- It is recommended to use the AC Adapter as the power supply instead of the battery pack. (▶ pg. 13)
- To monitor the picture and sound from the camcorder without inserting a tape, set the camcorder's Power Switch to "A" or "M", then set your TV to the appropriate input mode.
- Make sure you adjust the TV sound volume to its minimum level to avoid a sudden burst of sound when the camcorder is turned on.

Changing The Menu Settings

This camcorder is equipped with an easy-to-use, on-screen menu system that simplifies many of the more detailed camcorder settings. (☞ pg. 23 – 27)

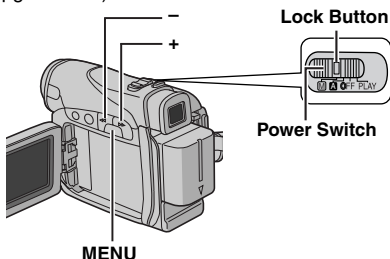

Menus without Sub Menu

- WIPE/FADER (☞ pg. 33)
- PROGRAM AE (☞ pg. 34)
- EXPOSURE (☞ pg. 30)
- W. BALANCE (☞ pg. 32)

- 1) Press + or – to select the desired parameter.
 - Example: PROGRAM AE Menu
- 2) Press **MENU**. Selection is complete. The Menu Screen returns.
 - Repeat the procedure if you wish to set other function menus.
- 3) Press **MENU**. The Menu Screen closes.

Selected menu icon blinks.

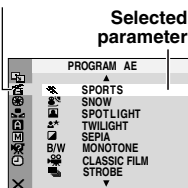

1 For Video Recording Menus:

Set the Power Switch to "M" while pressing down the Lock Button located on the switch.

For Video Playback Menus:

Set the Power Switch to "PLAY" while pressing down the Lock Button located on the switch.

- 2 Open the LCD monitor fully. (☞ pg. 18)
- 3 Press **MENU**. The Menu Screen appears.
- 4 Press + or – to select the desired function, and press **MENU**. The selected function menu appears.

Screen for Video Recording Menu

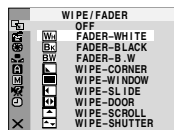

Screen for Video Playback Menu

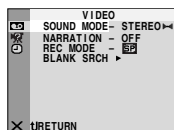

- 5 Setting procedure hereafter depends on the selected function.

Menus with Sub Menu

- CAMERA (☞ pg. 23)
- MANUAL (☞ pg. 24)
- SYSTEM (☞ pg. 25)
- CAMERA DISPLAY (☞ pg. 26)
- VIDEO (☞ pg. 26)
- VIDEO DISPLAY (☞ pg. 27)

- 1) Press + or – to select the desired function, and press **MENU**. The Sub Menu appears.

- Example: CAMERA Menu
- 2) Press + or – to select the desired parameter.
 - 3) Press **MENU**. Selection is complete.
 - Repeat the procedure if you wish to set other function menus.
 - 4) Press **MENU**. The Menu Screen returns.
 - Repeat the procedure if you wish to set other function menus.

Selected menu icon blinks.

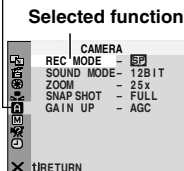

Sub Menu

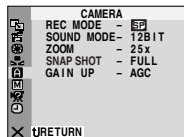
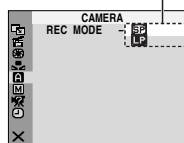

- 5) Press **MENU**. The Menu Screen closes.

Recording Menus

CAMERA

The "CAMERA" settings are effective when the Power Switch is set to both "A" and "M". However, the menu settings can be changed only when the Power Switch is set to "M".

[] = Factory-preset

REC MODE

[SP]: To record in the SP (Standard Play) mode
LP: Long Play—more economical, providing 1.5 times the recording time.

NOTES:

- If the recording mode is switched, the playback picture will be blurred at the switching point.
- It is recommended that tapes recorded in the LP mode on this camcorder be played back on this camcorder.
- During playback of a tape recorded on another camcorder, blocks of noise may appear or there may be momentary pauses in the sound.

SOUND MODE

[12BIT]: Enables video recording of stereo sound on four separate channels, and is recommended for use when performing Audio Dubbing. (Equivalent to the 32 kHz mode of previous models)

16BIT: Enables video recording of stereo sound on two separate channels. (Equivalent to the 48 kHz mode of previous models)

ZOOM

25X: When set to "25X" while using digital zoom, the zoom magnification will reset to 25X since digital zoom will be disengaged.

[100X]: Allows you to use the Digital Zoom. By digitally processing and magnifying images, zooming is possible from 25X (the optical zoom limit), to a maximum of 100X digital magnification.

800X: Allows you to use the Digital Zoom. By digitally processing and magnifying images, zooming is possible from 25X (the optical zoom limit), to a maximum of 800X digital magnification.

SNAP SHOT

[FULL]: Snapshot mode with no frame

NEGA: Nega mode

PIN-UP: Pin-Up mode

FRAME: Snapshot mode with frame



[FULL]



NEGA



PIN-UP



FRAME

For details on the procedure, refer to "Snapshot (For Video Recording)" (pg. 29).

GAIN UP

OFF: Allows you to shoot dark scenes with no picture brightness adjustment.

[AGC]: The overall appearance may be grainy, but the image is bright.

AUTO **A:** The shutter speed is automatically adjusted. Shooting a subject in low or poor lighting at slow shutter speed provides a brighter image than in the AGC mode, but the subject's movements are not smooth or natural. The overall appearance may be grainy. While the shutter speed is being automatically adjusted, " A" is displayed.

MANUAL

The "MANUAL" settings are effective only when the Power Switch is set to "M".

[] = Factory-preset

DIS

OFF: Disables the function.

[ON]: To compensate for unstable images caused by camera-shake, particularly at high magnification.

NOTES:

- Accurate stabilisation may not be possible if hand shake is excessive, or depending on the shooting condition.
- The " " indicator blinks or goes out if the Stabiliser cannot be used.
- Switch off this mode when recording with the camcorder on a tripod.

5S

[OFF]: Disables 5-Second Recording.

5S: Enables 5-Second Recording. (pg. 28)

Anim.: Allows you to record a few frames only.

By using an inanimate object and changing its position between shots, you can record the subject as though it is moving.

TELE MACRO

[OFF]: Disables the function.

ON: When the distance to the subject is less than 1 m, set "TELE MACRO" to "ON". You can shoot a subject as large as possible at a distance of approx. 40 cm.

NOTE:

Depending on the zoom position, the lens may go out of focus.

WIDE MODE

[OFF]: Records with no change in the screen ratio. For playback on a TV with a normal screen ratio.

CINEMA: Inserts black bands at the top and bottom of the screen. The indicator appears. During playback on wide-screen TVs, the black bands at the top and bottom of the screen are cut and the screen ratio becomes 16:9. When using this mode, refer to your wide-screen TV's instruction manual. During playback/recording on 4:3 TVs/LCD monitor/viewfinder, black bands are inserted at the top and bottom of the screen and the image appears like a letter boxed 16:9 movie.

SQUEEZE: For playback on TVs with an aspect ratio of 16:9. Naturally expands the image to fit the screen without distortion. The indicator appears. When using this mode, refer to your wide-screen TV's instruction manual. During playback/recording on 4:3 TVs/LCD monitor/viewfinder, the image is elongated vertically.

WIND CUT

[OFF]: Disengages the function.

ON : Helps cut down on noise created by wind. The " " indicator appears. The quality of the sound will change. This is normal.

SYSTEM

The "SYSTEM" functions which are set when the Power Switch is set to "M" are also applied when the Power Switch is set to "PLAY".

[] = Factory-preset

BEEP

OFF: Even though not heard while shooting, shutter sound is recorded on the tape.

BEEP: The beep sounds when the power is turned on or off, and at the beginning and end of recording. It also activates the shutter sound effect. (⇨ pg. 29)

[MELODY]: Instead of a beep, a melody sounds when any operation is performed. It also activates the shutter sound effect. (⇨ pg. 29)

REMOTE

OFF: Disables the remote control operations.

[ON]: Enables the remote control operations. It is recommended that this function be set to "OFF" to prevent improper operation.

DEMO MODE

OFF: Automatic demonstration will not take place.

[ON]: Demonstrates certain functions such as Program AE with special effects, etc., and can be used to confirm how these functions operate. Demonstration starts in the following cases:

- When the Menu Screen is closed after "DEMO MODE" is turned "ON".
- With "DEMO MODE" set to "ON", if there is no operation for about 3 minutes after the Power Switch is set to "A" or "M".
- Performing any operation during the demonstration stops the demonstration temporarily. If no operation is performed for more than 3 minutes after that, the demonstration will resume.

NOTES:

- If a cassette is in the camcorder, the demonstration cannot be turned on.
- "DEMO MODE" remains "ON" even if the camcorder power is turned off.
- If "DEMO MODE" remains "ON", some functions will not be available. After viewing demo, set to "OFF".

PRIORITY

[LCD]: The image is displayed on the LCD monitor when the viewfinder is pulled out while the LCD monitor is opened.

FINDER: The image is displayed in the viewfinder when the viewfinder is pulled out while the LCD monitor is opened.

CAM RESET

EXECUTE: Resets all settings to the factory-preset.

[RETURN]: Does not reset all settings to the factory-preset.

📷 CAMERA DISPLAY

- The **[CAMERA]** (CAMERA DISPLAY) settings are effective even when the Power Switch is set to **[A]**. However, the menu settings can be changed only when the Power Switch is set to **[M]**.
- The **[CAMERA]** (CAMERA DISPLAY) settings except "BRIGHT" and "LANGUAGE" are effective only for shooting.

[] = Factory-preset

BRIGHT

☞ pg. 15, "Brightness Adjustment Of The Display"

ON SCREEN

LCD: Keeps the camcorder's display (except the date, time and time code) from appearing on the connected TV screen.

[LCD/TV]: Makes the camcorder's display appear on screen when the camcorder is connected to a TV.

DATE/TIME

OFF: The date/time does not appear.

[AUTO]: Displays the date/time for approx. 5 seconds when the Power Switch is set from "OFF" to **[A]** or **[M]**.

ON: The date/time is always displayed.

TIME CODE

[OFF]: Time code is not displayed.

ON: Time code is displayed on the camcorder and on the connected TV. Frame numbers are not displayed during recording. (☞ pg. 19)

LANGUAGE

[ENGLISH] / ESPAÑOL / РУССКИЙ

The language setting can be changed. (☞ pg. 14)

CLOCK ADJ.

☞ pg. 14, "Date/Time Settings"

Playback Menus**📺 VIDEO**

[] = Factory-preset

SOUND MODE and NARRATION

During tape playback, the camcorder detects the sound mode in which the recording was made, and plays the sound back. Select the type of sound to accompany your playback picture.

According to the menu access explanation on page 22, select "SOUND MODE" or "NARRATION" from the Menu Screen and set it to the desired parameter.

SOUND MODE

[STEREO] [SPEAKERS]: Sound is output on both "L" and "R" channels in stereo.

SOUND L [L]: Sound from the "L" channel is output.

SOUND R [R]: Sound from the "R" channel is output.

NARRATION

[OFF]: Original sound is output on both "L" and "R" channels in stereo.

ON: Dubbed sound is output on both "L" and "R" channels in stereo.

MIX: Original and dubbed sounds are combined and output in stereo on both "L" and "R" channels.

REC MODE [SP] / LP

Allows you to set the video recording mode (SP or LP) depending on your preference. It is recommended you use "REC MODE" in VIDEO Menu when using this camcorder as a recorder during dubbing. (☞ pg. 35, 36)

BLANK SRCH

☞ pg. 20, "Blank Search"

🔧 SYSTEM

Each setting is linked with **[SYSTEM]**, which appears when the Power Switch is set to **[M]**.

(☞ pg. 22)

- The parameters are the same as in the description on page 25.

VIDEO DISPLAY

The  (VIDEO DISPLAY) settings are effective only for video playback except "BRIGHT" and "LANGUAGE".

- The parameters (except "OFF" in ON SCREEN settings) are the same as in the description (CAMERA DISPLAY) on page 26.

[] = Factory-preset

BRIGHT

 pg. 15, "Brightness Adjustment Of The Display"

ON SCREEN OFF / [LCD] / LCD/TV

When set to "OFF", the camcorder's display disappears.

DATE/TIME [OFF] / AUTO / ON

When set to "AUTO", the date/time are displayed in the following cases:

- When playback starts. The camcorder displays the date/time when scenes are recorded.
- When the date is changed during playback.

TIME CODE [OFF] / ON

 pg. 19, "Time Code"

LANGUAGE

[ENGLISH] / ESPAÑOL / РУССКИЙ

The language setting can be changed.

 pg. 14

5-Second Recording

Record a vacation or an important event in 5-second clips to keep the action moving. This function is available only for video recording.

1 Set "5S" to "5S". (☞ pg. 24)

- The "5S" indicator appears.

2 Press the Recording Start/Stop Button to start recording, and after 5 seconds the camcorder enters Record-Standby mode automatically.

- Even if you press the Recording Start/Stop Button again within 5 seconds after recording starts, Record-Standby mode is not engaged.

3 To exit the 5S mode, select "OFF" in step **1**.

To take a snapshot in the 5-second recording mode

Instead of pressing the Recording Start/Stop Button in step **2**, select the desired Snapshot mode in CAMERA Menu (☞ pg. 23), then press **SNAPSHOT**. The camcorder records a 5-second still. When "5S" is set to "Anim.", this function is not available.

NOTE:

When "5S" is set to "Anim.", the 5-Second Recording mode is not available. Animation recording of a few frames only is taken instead.

Night-Scope

Makes dark subjects or areas even brighter than they would be under good natural lighting. Although the recorded image is not grainy, it may look as if it is strobing due to the slow shutter speed.

1 Set the Power Switch to "M".

2 Press **NIGHT** so that the Night-Scope indicator "0.0" appears.

- The shutter speed is automatically adjusted to provide up to 25 times sensitivity.
- "A" appears beside "0.0" while the shutter speed is being automatically adjusted.

To deactivate Night-Scope

Press **NIGHT** again so that the Night-Scope indicator disappears.

NOTES:

- During Night-Scope, the following functions or settings cannot be activated and its indicator blinks or goes out:
 - Some modes of "Program AE With Special Effects" (☞ pg. 34).
 - "GAIN UP" in CAMERA Menu (☞ pg. 23).
 - "DIS" in MANUAL Menu (☞ pg. 24).
- During Night-Scope, it may be difficult to bring the camcorder into focus. To prevent this, use of a tripod is recommended.

Snapshot (For Video Recording)

This feature lets you record still images that look like photographs onto a tape.

- 1 Set the Power Switch to "M".
- 2 Set "SNAP SHOT" to the desired mode. (☞ pg. 22, 23)

3 Press **SNAPSHOT**.

- There is the sound effect of a shutter closing.
- The "PHOTO" indication appears and a still image will be recorded for approx. 6 seconds, then the camcorder re-enters the Record-Standby mode.
- You can perform Snapshot also during recording. A still image will be recorded for approx. 6 seconds, then the normal recording resumes.
- Regardless of the Power Switch position ("A" or "M"), Snapshot recording takes place using the selected Snapshot mode.

Motor Drive Mode

Keeping **SNAPSHOT** pressed in step 3 provides an effect similar to serial photography. (Interval between still images: approx. 1 second)

Manual Focus

The camcorder's Full Range AF system offers continuous shooting ability from close-up (as close as approx. 5 cm to the subject) to infinity. However, correct focus may not be obtained depending on the shooting condition. In this case, use the manual focus mode.

- 1 Set the Power Switch to "M".

2 Press **FOCUS**. The manual focus indicator appears.

3 Press + or - to focus on a subject.

- When the focus level cannot be adjusted any further or closer, "▲" or "▶" will blink.

4 Press **MENU**. Focus adjustment is complete.



Manual focus indicator

To reset to Auto Focus

Press **FOCUS** twice or set the Power Switch to "A".

Manual focus is recommended in situations listed below.

- When two subjects overlap in the same scene.
- When illumination is low.*
- When the subject has no contrast (difference in brightness and darkness), such as a flat, one-colour wall, or a clear, blue sky.*
- When a dark object is barely visible in the LCD monitor or the viewfinder.*
- When the scene contains minute patterns or identical patterns that are regularly repeated.
- When the scene is affected by sunbeams or light reflecting off the surface of a body of water.
- When shooting a scene with a high-contrast background.

* The following low-contrast warnings appear blinking: ▲, ◀, ▶ and ▶.

Exposure Control

Manual exposure control is recommended in the following situations:

- When shooting using reverse lighting or when the background is too bright.
- When shooting on a reflective natural background such as at the beach or when skiing.
- When the background is overly dark or the subject is bright.

1 Set the Power Switch to "M".

2 Set "☰" to "MANUAL". (☞ pg. 22)

- The exposure control indicator appears.

3 To brighten the image, press +. To darken the image, press -. (maximum ±6)

- +3 exposure has the same effect as the backlight compensation. (☞ pg. 31)
- -3 exposure has the same effect as when "☰" is set to "SPOTLIGHT". (☞ pg. 34)

4 Press **MENU**. Exposure adjustment is complete.

To return to automatic exposure control

Select "AUTO" in step **2**. Or, set the Power Switch to "A".

NOTES:

- You cannot use the manual exposure control at the same time when "☰" is set to "SPOTLIGHT" or "SNOW" (☞ pg. 34), or with the backlight compensation.
- If the adjustment does not cause any visible change in brightness, set "GAIN UP" to "AUTO". (☞ pg. 22, 23)

Iris Lock

Like the pupil of the human eye, the iris contracts in well-lit environments to keep too much light from entering, and dilates in dim environments to allow in more light.

Use this function in the following situations:

- When shooting a moving subject.
- When the distance to the subject changes (so its size in the LCD monitor or the viewfinder changes), such as when the subject is backing away.
- When shooting on a reflective natural background such as at the beach or when skiing.
- When shooting objects under a spotlight.
- When zooming.

1 Set the Power Switch to "M".

2 Set "☰" to "MANUAL". (☞ pg. 22)

- The exposure control indicator appears.

3 Adjust zoom so that the subject fills the LCD monitor or the viewfinder, then press and hold **MENU** for over 2 seconds. The exposure control indicator and the "L" indication appear.

4 Press **MENU**. The "L" indication changes to "L" and the iris is locked.

To return to automatic iris control

Select "AUTO" in step **2**. Or, set the Power Switch to "A".

- The exposure control indicator and "L" disappear.

To lock the exposure control and the iris

After step **2**, adjust the exposure by pressing + or -. Then lock the iris in steps **3** and **4**. For automatic locking, select "AUTO" in step **2**. The exposure control and the iris become automatic.

Backlight Compensation

Backlight compensation brightens the subject quickly.

With simple operation, backlight compensation feature brightens the dark subject portion by increasing the exposure.

1 Set the Power Switch to “M”.

2 Press **BACK LIGHT** so that the Backlight Compensation indicator “” appears.

To cancel Backlight Compensation

Press **BACK LIGHT** twice so that the “” indicator disappears.

NOTE:

Using Backlight Compensation may cause the light around the subject to become too bright and the subject to become white.

Spot Exposure Control

Selection of a spot metering area enables more precise exposure compensation. You can select one of the three metering areas on the LCD monitor/viewfinder.

1 Set the Power Switch to “M”.

2 Press **BACK LIGHT** twice so that the Spot Exposure Control indicator “” appears.

• A spot metering area frame appears at the centre of the LCD monitor/viewfinder.

3 Press + or – to select the desired spot metering area frame.

4 Press **MENU**.

- Spot Exposure Control is engaged.
- Exposure is adjusted to make the brightness of the selected area most appropriate.



To lock the iris

After step **3**, press and hold **MENU** over 2 seconds. The “” indication appears and the iris is locked.

To cancel Spot Exposure Control

Press **BACK LIGHT** once so that the “” indicator disappears.

NOTES:

- You cannot use the Spot Exposure Control at the same time with following functions.
 - “SQUEEZE” in “WIDE MODE” ( pg. 24)
 - “STROBE” in “PROGRAM AE” ( pg. 34)
 - Digital Zoom ( pg. 18)
 - Manual Exposure Control
- Depending on the shooting location and condition, optimum result may not be attained.

White Balance Adjustment

The white balance refers to the correctness of colour reproduction under various lighting. If the white balance is correct, all other colours will be accurately reproduced.

The white balance is usually adjusted automatically. However, more advanced camcorder operators control this function manually to achieve a more professional colour/tint reproduction.

To change the setting

Set "☑" to the desired mode. (☞ pg. 22)

- The selected mode indicator except "AUTO" appears.

[AUTO]: White balance is adjusted automatically.

☑ **MWB:** Adjust the white balance manually when shooting under various types of lighting. (☞ "Manual White Balance Adjustment")

☀ **FINE:** Outdoors on a sunny day.

☁ **CLOUD:** Outdoors on a cloudy day.

☛ **HALOGEN:** A video light or similar type of lighting is used.

[] = Factory-preset

To return to automatic white balance

Set "☑" to "AUTO". (☞ pg. 22)

Or, set the Power Switch to "A".

Manual White Balance Adjustment

Adjust the white balance manually when shooting under various types of lighting.

1 Set the Power Switch to "M".

2 Hold a sheet of plain white paper in front of the subject. Adjust zoom or position yourself so that the white paper fills the screen.

3 Select "MWB" in "☑ W.BALANCE" menu (☞ pg. 22), then press and hold **MENU** until ☑ begins blinking.

- When the setting is completed, ☑ stops blinking.

4 Press **MENU** twice. The Menu Screen closes and the Manual White Balance indicator ☑ is displayed.

NOTES:

- In step **2**, it may be difficult to focus on the white paper. In such a case, adjust focus manually. (☞ pg. 29)
- A subject can be shot under various types of lighting conditions indoors (natural, fluorescent, candlelight, etc.). Because the colour temperature is different depending on the light source, the subject tint will differ depending on the white balance settings. Use this function for a more natural result.
- Once you adjust white balance manually, the setting is retained even if the power is turned off or the battery removed.

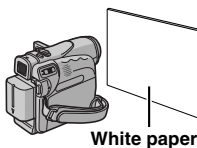

White paper

Wipe Or Fader Effects

These effects let you make pro-style scene transitions. Use them to spice up the transition from one scene to the next.

Wipe or Fader works when video recording is started or stopped.

- 1 Set the Power Switch to "M".
- 2 Set "E" to the desired mode. (pg. 22)
 - The WIPE/FADER menu disappears and the effect is reserved.
 - The selected effect indicator appears.
- 3 Press the Recording Start/Stop Button to activate the Fade-in/out or Wipe-in/out.

To deactivate the selected effect

Select "OFF" in step 2. The effect indicator disappears.

NOTES:

- You can extend the length of a Wipe or Fader by pressing and holding the Recording Start/Stop Button.
- Some Wipe/Fader Effects cannot be used with certain modes of Program AE with special effects. (pg. 34) In this case, the selected indicator blinks or goes out.

WIPE/FADER

OFF: Disables the function. (Factory-preset)

W **FADER-WHITE:** Fade in or out with a white screen.

B **FADER-BLACK:** Fade in or out with a black screen.

BW **FADER-B.W:** Fade in to a colour screen from a black and white screen, or fade out from colour to black and white.

◻ **WIPE-CORNER:** Wipe in on a black screen from the upper right to the lower left corner, or wipe out from lower left to upper right, leaving a black screen.

◻ **WIPE-WINDOW:** The scene starts in the centre of a black screen and wipes in toward the corners, or comes in from the corners, gradually wiping out to the centre.

◀ **WIPE-SLIDE:** Wipe in from right to left, or wipe out from left to right.

◀▶ **WIPE-DOOR:** Wipe in as the two halves of a black screen open to the left and right, revealing the scene, or wipe out and the black screen reappears from left and right to cover the scene.

▲ **WIPE-SCROLL:** The scene wipes in from the bottom to the top of a black screen, or wipes out from top to bottom, leaving a black screen.

◀▶ **WIPE-SHUTTER:** Wipe in from the centre of a black screen toward the top and bottom, or wipe out from the top and bottom toward the centre leaving a black screen.

Program AE With Special Effects

- 1 Set the Power Switch to "M".
- 2 Set "AE" to the desired mode. (→ pg. 22)
 - The PROGRAM AE menu disappears and the selected effect is activated.
 - The selected effect indicator appears.

To deactivate the selected effect

Select "OFF" in step 2. The effect indicator disappears.

NOTES:

- Program AE with special effects can be changed during recording or during Record-Standby.
- Some modes of Program AE with special effects cannot be used during Night-Scope.
- When a subject is too bright or reflective, a vertical streak may appear (smear phenomenon). Smear phenomenon tends to occur when "SPORTS" or any mode of "SHUTTER 1/250 – 1/4000" is selected.
- Some modes of Program AE with special effects cannot be used with certain Wipe/Fader effects. (→ pg. 33) In this case, the selected indicator blinks or goes out.

PROGRAM AE

OFF: Disables the function. (Factory-preset)

1/50 SHUTTER 1/50: The shutter speed is fixed at 1/50th of a second. Black bands that usually appear when shooting a TV screen become narrower.

1/120 SHUTTER 1/120: The shutter speed is fixed at 1/120th of a second. The flickering that occurs when shooting under a fluorescent light or mercury-vapour lamp is reduced.

**SHUTTER 1/250/ SHUTTER 1/500/
SHUTTER 1/1000/ SHUTTER 1/2000/**

SHUTTER 1/4000: These settings allow fast-moving images to be captured one frame at a time, for vivid, stable slow-motion playback by fixing shutter speed variables. Use these settings when an automatic adjustment does not work well, using **SPORTS** mode. The faster the shutter speed, the darker the picture becomes. Use the shutter function under good lighting conditions.

SPORTS

(Variable Shutter Speed: 1/250 – 1/4000):

This setting allows fast-moving images to be captured one frame at a time, for vivid, stable slow-motion playback. The faster the shutter speed, the darker the picture becomes. Use the shutter function under good lighting conditions.

 **SNOW:** Compensates for subjects that may otherwise appear too dark when shooting in extremely bright surroundings such as in the snow.

 **SPOTLIGHT:** Compensates for subjects that may otherwise appear too bright when shooting under extremely strong direct lighting such as spotlights.

 **TWILIGHT:** Makes evening scenes look more natural. White Balance (→ pg. 32) is automatically set to "☉", but can be changed to your desired setting. When Twilight is chosen, the camcorder automatically adjusts the focus from approx. 10 m to infinity. From less than 10 m, adjust the focus manually.

 **SEPIA:** Recorded scenes have a brownish tint like old photos. Combine this with the Cinema mode for a classic look.

B/W MONOTONE: Like classic black and white films, your footage is shot in B/W. Used together with the Cinema mode, it enhances the "classic film" effect.

 **CLASSIC FILM:** Gives recorded scenes a strobe effect.

 **STROBE:** Your recording looks like a series of consecutive snapshots.

 **MIRROR:** Creates a mirror image on the right half of the screen, juxtaposed to the normal image on the other half.

Dubbing To A VCR

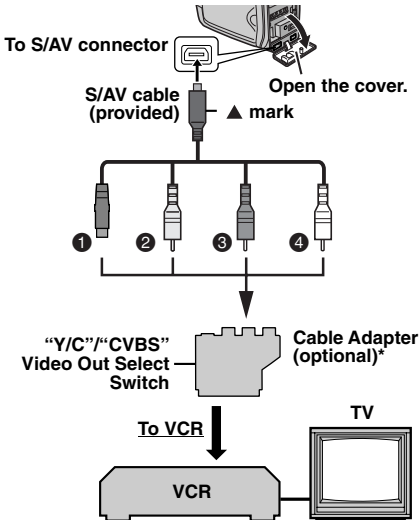

- ❶ To S-VIDEO IN**
- ❷ Yellow to VIDEO IN
- ❸ Red to AUDIO R IN
- ❹ White to AUDIO L IN

* If your VCR has a SCART connector, use the cable adapter (optional).

** Connect when your TV/VCR has an S-VIDEO IN connector. In this case, it is not necessary to connect the yellow video cable.

NOTE:

Set the video out select switch of the cable adapter as required:

Y/C: When connecting to a TV or VCR which accepts Y/C signals and uses an S-Video cable.

CVBS: When connecting to a TV or VCR which does not accept Y/C signals and uses an audio/video cable.

- 1 Following the illustrations, connect the camcorder and the VCR's input connectors.
- 2 Start playback on the camcorder. (⇨ pg. 20)
- 3 At the point you want to start dubbing, start recording on the VCR. (Refer to the VCR's instruction manual.)
- 4 To stop dubbing, stop recording on the VCR, then stop playback on the camcorder.

NOTES:

- It is recommended to use the AC Adapter as the power supply instead of the battery pack. (⇨ pg. 13)
- To choose whether or not the following displays appear on the connected TV
 - Date/time
 - Set "DATE/TIME" to "AUTO", "ON" or "OFF". (⇨ pg. 22, 27)
 - Time code
 - Set "TIME CODE" to "OFF" or "ON". (⇨ pg. 22, 27)
- Indications other than date/time and time code
 - Set "ON SCREEN" to "OFF", "LCD" or "LCD/TV". (⇨ pg. 22, 27)

Dubbing To A Video Unit Equipped With A DV Connector (Digital Dubbing)

It is also possible to copy recorded scenes from the camcorder onto another video unit equipped with a DV connector. Since a digital signal is sent, there is little if any image or sound deterioration.

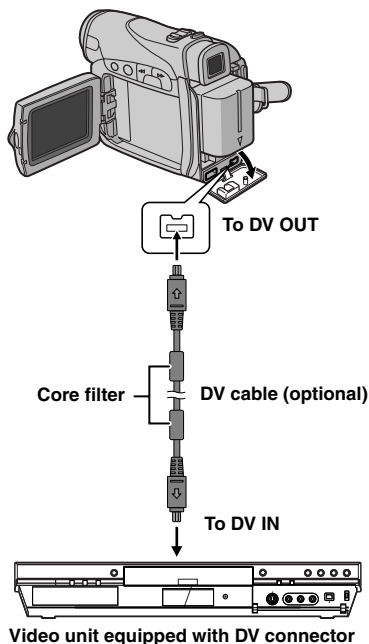

- 1** Make sure all units are turned off.
- 2** Connect this camcorder to a video unit equipped with a DV input connector using a DV cable as shown in the illustration.
- 3** Start playback on the camcorder. (☞ pg. 20)
- 4** At the point you want to start dubbing, start recording on the video unit. (Refer to the video unit's instruction manual.)
- 5** To stop dubbing, stop recording on the video unit, then stop playback on this camcorder.

NOTES:

- It is recommended to use the AC Adapter as the power supply instead of the battery pack. (☞ pg. 13)
- If a blank portion or disturbed image is played back on the player during dubbing, the dubbing may stop so that an unusual image is not dubbed.
- Even though the DV cable is connected correctly, sometimes the image may not appear in step **4**. If this occurs, turn off the power and make connections again.
- When using a DV cable, be sure to use the optional JVC VC-VDV204U DV cable.

Connection To A Personal Computer

It is also possible to transfer still/moving images to a PC with a DV connector by using the software equipped with the PC or commercially available software.

If you are using a Windows® XP, you can use Windows® Messenger to conduct video conferences over the Internet, using a camcorder. For details, refer to the help for the Windows® Messenger.

NOTES:

- It is recommended to use the AC Adapter as the power supply instead of the battery pack. (→ pg. 13)
- When using a DV cable, be sure to use the optional JVC VC-VDV206U or VC-VDV204U DV cable depending on the type of DV connector (4 or 6 pins) on the PC.
- The date/time information cannot be captured into the PC.
- Refer to the instruction manuals of the PC and Software.
- The still images can also be transferred to a PC with a DV connector-equipped capture board.
- The system may not work properly depending on the PC or capture board you are using.

When connecting the camcorder to a PC using a DV cable, make sure to follow the procedure below. Connecting the cable incorrectly may cause malfunctions to the camcorder and/or the PC.

- Connect the DV cable first to the PC, and then to the camcorder.
- Connect the DV cable (plugs) correctly according to the shape of the DV connector.

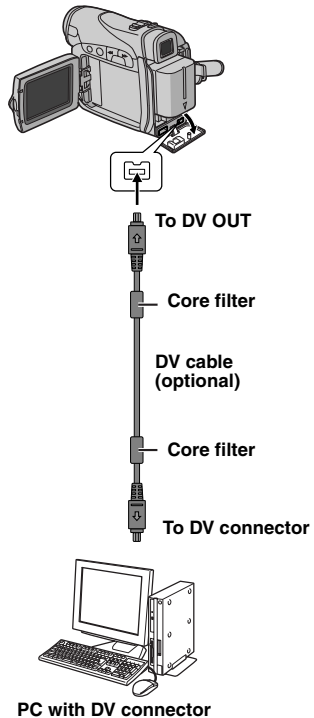

If, after following the steps in the chart below, the problem still exists, please consult your nearest JVC dealer.

The camcorder is a microcomputer-controlled device. External noise and interference (from a TV, a radio, etc.) might prevent it from functioning properly. In such cases, first disconnect its power supply unit (battery pack, AC Adapter, etc.) and wait a few minutes; and then re-connect it and proceed as usual from the beginning.

Power

No power is supplied.

- The power is not connected properly.
- Connect the AC Adapter securely. (⇨ pg. 13)
- The battery pack is not attached firmly.
- Detach the battery pack once again and re-attach it firmly. (⇨ pg. 11)
- The battery is dead.
- Replace the dead battery with a fully charged one. (⇨ pg. 11)

Video Recording

Recording cannot be performed.

- The tape's erase protection tab is set to "SAVE".
- Set the tape's erase protection tab to "REC". (⇨ pg. 16)
- "TAPE END" appears.
- Replace with new cassette. (⇨ pg. 16)
- The cassette holder cover is open.
- Close the cassette holder cover.

When shooting a subject illuminated by bright light, vertical lines appear.

- This is not a malfunction.

When the screen is under direct sunlight during shooting, the screen becomes red or black for an instant.

- This is not a malfunction.

During recording, the date/ time does not appear.

- "DATE/TIME" is set to "OFF".
- Set "DATE/TIME" to "ON". (⇨ pg. 22, 26)

The LCD monitor or viewfinder indications blink.

- Certain Wipe/Fader effects, certain modes of Program AE with special effects, "DIS" and other functions that cannot be used together are selected at the same time.
- Re-read the sections covering Wipe/Fader effects, Program AE with special effects and "DIS". (⇨ pg. 22, 24, 33, 34)

Digital Zoom does not work.

- 25X optical zoom is selected.
- Set "ZOOM" to "100X" or "800X". (⇨ pg. 23)

Video Playback

The tape is moving, but there is no picture.

- Your TV has AV input terminals, but is not set to its VIDEO mode.
- Set the TV to the mode or channel appropriate for video playback. (⇨ pg. 21)
- The cassette holder cover is open.
- Close the cassette holder cover. (⇨ pg. 16)

Blocks of noise appear during playback, or there is no playback picture and the screen becomes blue.

- Clean the video heads with an optional cleaning cassette. (⇨ pg. 44)

Advanced features

The focus does not adjust automatically.

- Focus is set to the Manual mode.
- Set Focus to the Auto mode. (⇨ pg. 29)
- The lens is dirty or covered with condensation.
- Clean the lens and check the focus again. (⇨ pg. 42)

In the 5-Second mode, recording ends before 5 seconds have elapsed.

- The 5-Second mode is set to "Anim." in MANUAL Menu.
- Set "5S" to "5S" in MANUAL Menu. (⇨ pg. 22, 28)

Snapshot mode cannot be used.

- The Squeeze mode (SQUEEZE) is selected.
- Disengage the Squeeze (SQUEEZE) mode. (⇨ pg. 22, 24)

The colour of Snapshot looks strange.

- The light source or the subject does not include white. Or there are various different light sources behind the subject.
- Find a white subject and compose your shot so that it also appears in the frame. (⇨ pg. 29)

The image taken using Snapshot is too dark.

- Shooting was performed under backlit conditions.
- Press **BACK LIGHT**. (⇨ pg. 31)

The image taken using Snapshot is too bright.

- The subject is too bright.
- Set "☐" to "SPOTLIGHT". (⇨ pg. 34)

White Balance cannot be activated.

- The Sepia (SEPIA) or Monotone (MONOTONE) mode is activated.
- Disengage the Sepia (SEPIA) or Monotone (MONOTONE) mode before setting White Balance. (⇨ pg. 34)

The Black & White Fader does not work.

- The Sepia (SEPIA) or Monotone (MONOTONE) mode is activated.
- Disengage the Sepia (SEPIA) and Monotone (MONOTONE). (⇨ pg. 34)

The image looks like the shutter speed is too slow.

- When shooting in the dark, the unit becomes highly sensitive to light when "GAIN UP" is set to "AUTO".
- If you want the lighting to look more natural, set "GAIN UP" to "AGC" or "OFF". (⇨ pg. 22, 23)

Other problems**The POWER/CHARGE lamp on the camcorder does not light during charging.**

- Charging is difficult in places subject to extremely high/low temperatures.
- To protect the battery, it is recommended to charge it in places with a temperature of 10°C to 35°C. (⇨ pg. 43)
- The battery pack is not attached firmly.
- Detach the battery pack once again and re-attach it firmly. (⇨ pg. 11)

"SET DATE/TIME!" appears.

- The date/time is not set.
- Set the date/time. (⇨ pg. 14)
- The built-in clock battery has run out and the previously set date/time has been erased.
- Consult your nearest JVC dealer for replacement.

When the image is printed from the printer, a black bar appears at the bottom of the screen.

- This is not a malfunction.
- By recording with "DIS" activated (⇨ pg. 22, 24) this can be avoided.

When the camcorder is connected via the DV connector, the camcorder does not operate.

- The DV cable was plugged/unplugged with power turned on.
- Turn the camcorder's power off and on again, then operate it.

Images on the LCD monitor appear dark or whitish.

- In places subject to low temperature, images become dark due to the characteristics of the LCD monitor. This is not a malfunction.
- Adjust the brightness and angle of the LCD monitor. (⇨ pg. 15, 18)
- When the LCD monitor's fluorescent light reaches the end of its service life, images on the LCD monitor become dark.
- Consult your nearest JVC dealer.

Coloured bright spots appear all over the LCD monitor or the viewfinder.

- The LCD monitor and the viewfinder are made with high-precision technology. However, black spots or bright spots of light (red, green or blue) may appear constantly on the LCD monitor or the viewfinder. These spots are not recorded on the tape. This is not due to any defect of the unit. (Effective dots: more than 99.99 %)

The cassette will not load properly.

- The battery's charge is low.
- Install a fully charged battery. (⇨ pg. 11)

Picture does not appear on the LCD monitor.

- The viewfinder is pulled out and "PRIORITY" is set to "FINDER".
- Push the viewfinder back in or set "PRIORITY" to "LCD". (☞ pg. 18, 22, 25)
- The LCD monitor's brightness setting is too dark.
- Adjust the brightness of the LCD monitor. (☞ pg. 15)
- If the monitor is tilted upward 180 degrees, open the monitor fully. (☞ pg. 18)

An error indication (01 – 04 or 06) appears.

- A malfunction of some kind has occurred. In this case the camcorder's functions become unusable.
- ☞ pg. 41.

Warning Indications

Displays the battery remaining power.

Remaining power level**High****Exhausted**

As the battery power comes close to nil, the battery remaining power indicator blinks.

When the battery power is exhausted, power turns off automatically.



Appears when no tape is loaded. (☞ pg. 16)

CHECK TAPE'S ERASE PROTECTION TAB

Appears when the erase protection tab is set to "SAVE" while the Power Switch is set to "A" or "M". (☞ pg. 13)

⊗ USE CLEANING CASSETTE

Appears if dirt is detected on the heads during recording. Use an optional cleaning cassette. (☞ pg. 44)

⏸ CONDENSATION, OPERATION PAUSED PLEASE WAIT

Appears if condensation occurs. When this indication is displayed, wait more than 1 hour until condensation disappears.

TAPE!

Appears if a tape is not loaded when the Recording Start/Stop Button or **SNAPSHOT** Button is pressed while the Power Switch is set to "A" or "M".

TAPE END

Appears when the tape ends during recording or playback.

SET DATE/TIME!

- Appears when the date/time is not set. (☞ pg. 14)
- The built-in clock battery has run out and the previously set date/time has been erased. Consult your nearest JVC dealer for replacement.

LENS CAP

Appears for 5 seconds after power is turned on if the lens cap is attached or when it is dark.

HDV 

Appears when pictures recorded in the HDV format are detected. The pictures in the HDV format cannot be played back with this camcorder.

**UNIT IN SAFEGUARD MODE
REMOVE AND REATTACH BATTERY**

The error indications (01, 02 or 06) show what type of malfunction has occurred. When an error indication appears, the camcorder turns off automatically. Remove the power supply (battery, etc.) and wait a few minutes for the indication to clear. When it does, you can resume using the camcorder. If the indication remains, consult your nearest JVC dealer.

**UNIT IN SAFEGUARD MODE
EJECT AND REINSERT TAPE**

The error indications (03 or 04) show what type of malfunction has occurred. When an error indication appears, the camcorder turns off automatically. Eject the cassette once and reinsert it, then check if the indication clears. When it does, you can resume using the camcorder. If the indication remains, consult your nearest JVC dealer.

Cleaning The Camcorder

Before cleaning, turn off the camcorder and remove the battery pack and AC Adapter.

To clean the exterior

Wipe gently with a soft cloth. Put the cloth in diluted mild soap and wring it well to wipe off heavy dirt. Then wipe again with a dry cloth.

To clean the LCD monitor

Wipe gently with a soft cloth. Be careful not to damage the monitor. Close the LCD monitor.

To clean the lens

Blow it with a blower brush, then wipe gently with lens cleaning paper.

NOTES:

- Avoid using strong cleaning agents such as benzine or alcohol.
- Cleaning should be done only after the battery pack has been removed or other power units have been disconnected.
- Mould may form if the lens is left dirty.
- When using a cleaner or chemically treated cloth refer to the cautions of each product.
- To clean the viewfinder, please consult your nearest JVC dealer.

Battery Packs

The supplied battery pack is a lithium-ion battery. Before using the supplied battery pack or an optional battery pack, be sure to read the following cautions:

- **To avoid hazards**

- ... do not burn.
- ... do not short-circuit the terminals. When transporting, make sure the provided battery cap is attached to the battery. If the battery cap is misplaced, carry the battery in a plastic bag.
- ... do not modify or disassemble.
- ... do not expose the battery to temperatures exceeding 60°C, as this may cause the battery to overheat, explode or catch fire.
- ... use only specified chargers.

- **To prevent damage and prolong service life**

- ... do not subject to unnecessary shock.
- ... charge in an environment where temperatures are within the tolerances shown in the chart below. This is a chemical reaction type battery — cooler temperatures impede chemical reaction, while warmer temperatures can prevent complete charging.
- ... store in a cool, dry place. Extended exposure to high temperatures will increase natural discharge and shorten service life.
- ... fully charge and then fully discharge the battery every 6 months when storing the battery pack over a long period time.
- ... remove from charger or powered unit when not in use, as some machines use current even when switched off.

Terminals

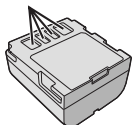

NOTES:

- It is normal for the battery pack to be warm after charging, or after use.
- Temperature Range Specifications**
- Charging: 10°C to 35°C
 Operation: 0°C to 40°C
 Storage: -20°C to 50°C
- The lower the temperature, the longer recharging takes.
 - Charging times are for a fully discharged battery pack.

Cassettes

To properly use and store your cassettes, be sure to read the following cautions:

- **During use**

- ... make sure the cassette bears the Mini DV mark.
- ... be aware that recording onto prerecorded tapes automatically erases the previously recorded video and audio signals.
- ... make sure the cassette is positioned properly when inserting.
- ... do not load and unload the cassette repeatedly without allowing the tape to run at all. This slackens the tape and can result in damage.
- ... do not open the front tape cover. This exposes the tape to fingerprints and dust.

- **Store cassettes**

- ... away from heaters or other heat sources.
- ... out of direct sunlight.
- ... where they won't be subject to unnecessary shock or vibration.
- ... where they won't be exposed to strong magnetic fields (such as those generated by motors, transformers or magnets).
- ... vertically, in their original cases.

The Benefits Of Lithium-Ion Batteries

Lithium-ion battery packs are small but have a large power capacity. However, when one is exposed to cold temperatures (below 10°C), its usage time becomes shorter and it may cease to function. If this happens, place the battery pack in your pocket or other warm, protected place for a short time, then re-attach it to the camcorder.

LCD Monitor

- **To prevent damage to the LCD monitor, DO NOT**

- ...push it strongly or apply any shocks.
- ...place the camcorder with the LCD monitor on the bottom.

- **To prolong service life**

- ...avoid rubbing it with coarse cloth.

- **Be aware of the following phenomena for LCD monitor use. These are not malfunctions**

- ...While using the camcorder, the surface around the LCD monitor and/or the back of the LCD monitor may heat up.
- ...If you leave power on for a long time, the surface around the LCD monitor becomes hot.

Main Unit

- **For safety, DO NOT**

- ...open the camcorder's chassis.
- ...disassemble or modify the unit.
- ...short-circuit the terminals of the battery pack. Keep it away from metallic objects when not in use.
- ...allow inflammables, water or metallic objects to enter the unit.
- ...remove the battery pack or disconnect the power supply while the power is on.
- ...leave the battery pack attached when the camcorder is not in use.

- **Avoid using the unit**

- ...in places subject to excessive humidity or dust.
- ...in places subject to soot or steam such as near a cooking stove.
- ...in places subject to excessive shock or vibration.
- ...near a television set.
- ...near appliances generating strong magnetic or electric fields (speakers, broadcasting antennas, etc.).
- ...in places subject to extremely high (over 40°C) or extremely low (under 0°C) temperatures.

- **DO NOT leave the unit**

- ...in places of over 50°C.
- ...in places where humidity is extremely low (below 35%) or extremely high (above 80%).
- ...in direct sunlight.
- ...in a closed car in summer.
- ...near a heater.

- **To protect the unit, DO NOT**

- ...allow it to become wet.
- ...drop the unit or strike it against hard objects.
- ...subject it to shock or excessive vibration during transportation.
- ...keep the lens directed at extremely bright objects for long periods.
- ...expose the lens and viewfinder's lens to direct sunlight.
- ...carry it by holding the LCD monitor or the viewfinder.
- ...swing it excessively when using the hand strap or the grip.
- ...swing the soft camera case excessively when the camcorder is inside it.

- **Dirty heads can cause the following problems:**



- ...No picture during playback.
- ...Blocks of noise appear during playback.
- ...During recording or playback, the Head Clog Warning indicator "⊗" appears.
- ...Recording cannot be performed properly.

In such cases, use an optional cleaning cassette. Insert it and play back. If the cassette is used more than once consecutively, damage to the video heads may result. After the camcorder plays back for about 20 seconds, it stops automatically. Also refer to the cleaning cassette's instructions.

If, after using the cleaning cassette, the problems still exist, consult your nearest JVC dealer.

Mechanical moving parts used to move the video heads and video tape tend to become dirty and worn out over time. In order to maintain a clear picture at all times, periodic check-ups are recommended after using the unit for about 1,000 hours. For periodic check-ups please consult your nearest JVC dealer.

About moisture condensation

- You have observed that pouring a cold liquid into a glass will cause drops of water to form on the glass' outer surface. This same phenomenon occurs on the head drum of a camcorder when it is moved from a cool place to a warm place, after heating a cold room, under extremely humid conditions or in a place directly subjected to the cool air from an air conditioner.
- Moisture on the head drum can cause severe damage to the video tape, and can lead to internal damage to the camcorder itself.

Serious malfunctioning

If malfunctioning occurs, stop using the unit immediately and consult your local JVC dealer.

The camcorder is a microcomputer-controlled device. External noise and interference (from a TV, a radio, etc.) might prevent it from functioning properly. In such cases, first disconnect its power supply unit (battery pack, AC Adapter, etc.) and wait a few minutes and then re-connect it and proceed as usual from the beginning.

Camcorder**For General****Power supply**

DC 11 V (Using AC Adapter)

DC 7.2 V (Using battery pack)

Power consumption

Approx. 3.2 W (LCD monitor off, viewfinder on)

Approx. 4.2 W (LCD monitor on, viewfinder off)

Dimensions (W x H x D)

56 mm x 94 mm x 112 mm (with the LCD monitor closed and the viewfinder pushed back in)

Weight

Approx. 430 g (without battery, cassette and lens cap)

Approx. 510 g (incl. battery, cassette and lens cap)

Operating temperature

0°C to 40°C

Operating humidity

35% to 80%

Storage temperature

-20°C to 50°C

Pickup

1/6" CCD

Lens

F 1.8, f = 2.2 mm to 55 mm, 25:1 power zoom lens

Filter diameter

ø27 mm

LCD monitor

2.5" diagonally measured, LCD panel/TFT active matrix system

Viewfinder

Electronic viewfinder with 0.16" black-and-white LCD

Speaker

Monaural

For Digital Video Camera**Format**

DV format (SD mode)

Signal format

PAL standard

Recording/Playback format

Video: Digital component recording

Audio: PCM digital recording, 32 kHz 4-channel (12-BIT), 48 kHz 2-channel (16-BIT)

Cassette

Mini DV cassette

Tape speed

SP: 18.8 mm/s, LP: 12.5 mm/s

Maximum recording time (using 80 min. cassette)

SP: 80 min., LP: 120 min.

For Connectors**S/AV**

S-Video output:

Y: 1.0 V (p-p), 75 Ω analogue

C: 0.29 V (p-p), 75 Ω analogue

Video output: 1.0 V (p-p), 75 Ω analogue

Audio output: 300 mV (rms), 1 kΩ analogue, stereo

DV

Output: 4-pin, IEEE1394 compliant

AC Adapter**Power requirement**

AC 110 V to 240 V~, 50 Hz/60 Hz

OutputDC 11 V , 1 A

Specifications shown are for SP mode unless otherwise indicated. E & O.E. Design and specifications subject to change without notice.

A		S	
AC Adapter	13	Snapshot Mode	23
Animation	24	Sound Mode	23, 26
B		Speaker Volume	20
Backlight Compensation	31	Specifications	46
Battery Pack	11, 13, 43	Spot Exposure Control	31
Beep	25	T	
Blank Search	20	Tape Speed (REC MODE)	23, 26
C		Telephoto Setting	24
Changing The Menu Settings	22 – 27	Time Code	19, 26
Charging The Battery Pack	11	Tripod Mounting	15
Connection To A Personal Computer	37	Troubleshooting	38
Connections To A TV Or VCR	21	W	
D		Warning Indications	40
Data Battery	12	White Balance	32
Date/Time Settings	14	Wide Mode	24
Demonstration Mode	25	Wipe Or Fader Effects	33
Digital Image Stabilisation (DIS)	24	Z	
Dubbing	35, 36	Zooming	18, 23
E		5-Second Recording	28
Exposure Control	30		
I			
Iris Lock	30		
L			
LCD Monitor and Viewfinder	15, 18		
Loading A Cassette	16		
M			
Manual Focus	29		
Motor Drive Mode	29		
N			
Night-Scope	28		
P			
Playback Sound	26		
Power-Linked Operation	14		
Program AE With Special Effects	34		
Q			
Quick Review	19		
R			
Recording Capacity			
Tape	17		

JVC

Free Manuals Download Website

<http://myh66.com>

<http://usermanuals.us>

<http://www.somanuals.com>

<http://www.4manuals.cc>

<http://www.manual-lib.com>

<http://www.404manual.com>

<http://www.luxmanual.com>

<http://aubethermostatmanual.com>

Golf course search by state

<http://golfingnear.com>

Email search by domain

<http://emailbydomain.com>

Auto manuals search

<http://auto.somanuals.com>

TV manuals search

<http://tv.somanuals.com>