

JVC

DIGITAL VIDEO CAMERA

GR-D74

Please visit our Homepage on the World Wide Web for Digital Video Camera:

<http://www.jvc.co.jp/english/cyber/>

For Accessories:

<http://www.jvc.co.jp/english/accessory/>

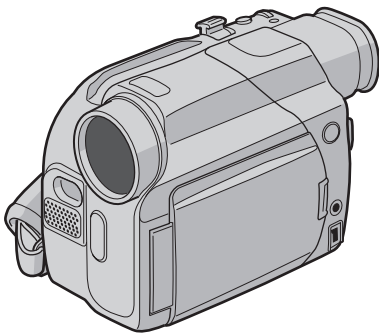

Mini DV NTSC
DSC
DIGITAL
STILL CAMERA

Dear Customer,
Thank you for purchasing this digital video camera. Before use, please read the safety information and precautions contained in the pages 2 – 3 to ensure safe use of this product.

ENGLISH

GETTING STARTED 5

**VIDEO RECORDING &
PLAYBACK 11**

**DIGITAL STILL CAMERA
(D.S.C.) RECORDING &
PLAYBACK 18**

ADVANCED FEATURES 25

REFERENCES 38

TERMS 54

For Customer Use:

Enter below the Model No. and Serial No. which is located on the bottom of the camcorder. Retain this information for future reference.

Model No. _____

Serial No. _____

To deactivate the demonstration, set "DEMO MODE" to "OFF".
(▶ pg. 25, 27)

INSTRUCTIONS

SAFETY PRECAUTIONS

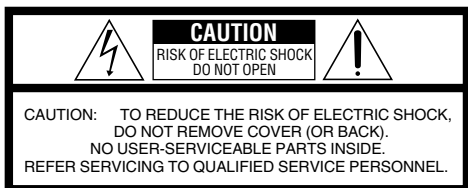

The lightning flash with arrowhead symbol, within an equilateral triangle, is intended to alert the user to the presence of uninsulated "dangerous voltage" within the product's enclosure that may be of sufficient magnitude to constitute a risk of electric shock to persons.



The exclamation point within an equilateral triangle is intended to alert the user to the presence of important operating and maintenance (servicing) instructions in the literature accompanying the appliance.

WARNING: TO PREVENT FIRE OR SHOCK HAZARD, DO NOT EXPOSE THIS UNIT TO RAIN OR MOISTURE.

NOTES:

- The rating plate (serial number plate) and safety caution are on the bottom and/or the back of the main unit.
- The rating information and safety caution of the AC Adapter are on its upper and lower sides.

CAUTIONS:

- This camcorder is designed to be used with NTSC-type color television signals. It cannot be used for playback with a television of a different standard. However, live recording and LCD monitor/viewfinder playback are possible anywhere.
- Use the JVC BN-V408U/V416U/V428U battery packs and, to recharge them or supply power to the camcorder from an AC outlet, use the provided multi-voltage AC Adapter. (An appropriate conversion adapter may be necessary to accommodate different designs of AC outlets in different countries.)

Caution on Replaceable lithium battery

The battery used in this device may present a fire or chemical burn hazard if mistreated. Do not recharge, disassemble, heat above 100°C (212°F) or incinerate.

Replace battery with Panasonic (Matsushita Electric), Sanyo, Sony or Maxell CR2025.

Danger of explosion or Risk of fire if the battery is incorrectly replaced.

- Dispose of used battery promptly.
- Keep away from children.
- Do not disassemble and do not dispose of in fire.

This product has a fluorescent lamp that contains a small amount of mercury. Disposal of these materials may be regulated in your community due to environmental considerations.

For disposal or recycling information please contact your local authorities, or the Electronics Industries Alliance:

<<http://www.eiae.org>>

When the equipment is installed in a cabinet or on a shelf, make sure that it has sufficient space on all sides to allow for ventilation (10 cm (3-15/16") or more on both sides, on top and at the rear).

Do not block the ventilation holes.

(If the ventilation holes are blocked by a newspaper, or cloth etc. the heat may not be able to get out.)

No naked flame sources, such as lighted candles, should be placed on the apparatus.

When discarding batteries, environmental problems must be considered and the local rules or laws governing the disposal of these batteries must be followed strictly.

The apparatus shall not be exposed to dripping or splashing.

Do not use this equipment in a bathroom or places with water.

Also do not place any containers filled with water or liquids (such as cosmetics or medicines, flower vases, potted plants, cups etc.) on top of this unit.

(If water or liquid is allowed to enter this equipment, fire or electric shock may be caused.)

Do not point the lens or the viewfinder directly into the sun. This can cause eye injuries, as well as lead to the malfunctioning of internal circuitry. There is also a risk of fire or electric shock.

CAUTION!

The following notes concern possible physical damage to the camcorder and to the user.

When carrying, be sure to always securely attach and use the provided strap. Carrying or holding the camcorder by the viewfinder and/or the LCD monitor can result in dropping the unit, or in a malfunction.

Take care not to get your finger caught in the cassette holder cover. Do not let children operate the camcorder, as they are particularly susceptible to this type of injury.

Do not use a tripod on unsteady or unlevel surfaces. It could tip over, causing serious damage to the camcorder.

CAUTION!

Connecting cables (Audio/Video, S-Video, etc.) to the camcorder and leaving it on top of the TV is not recommended, as tripping on the cables will cause the camcorder to fall, resulting in damage.

IMPORTANT SAFTY INSTRUCTIONS

1. Read these instructions.
2. Keep these instructions.
3. Heed all warnings.
4. Follow all instructions.
5. Do not use this apparatus near water.
6. Clean only with dry cloth.
7. Do not block any ventilation openings. Install in accordance with the manufacturer's instructions.
8. Do not install near any heat sources such as radiators, heat registers, stoves, or other apparatus (including amplifiers) that produce heat.
9. Only use attachments/accessories specified by the manufacturer.
10. Use only with the cart, stand, tripod, bracket, or table specified by the manufacturer, or sold with the apparatus. When a cart is used, use caution when moving the cart/apparatus combination to avoid injury from tip-over.
11. Unplug this apparatus during lightning storms or when unused for long periods of time.
12. Refer all servicing to qualified service personnel. Servicing is required when the apparatus has been damaged in any way, such as power-supply cord or plug is damaged, liquid has been spilled or objects have fallen into the apparatus, the apparatus has been exposed to rain or moisture, does not operate normally, or has been dropped.





Mini DV NTSC ™

MultiMediaCard

This camcorder is designed exclusively for the digital video cassette, SD Memory Card and MultiMediaCard. Only cassettes marked "Mini DV" and memory cards marked "SD" or "MultiMediaCard" can be used with this unit.

Before recording an important scene...

...make sure you only use cassettes with the Mini DV mark .

...make sure you only use memory cards with the mark  or *MultiMediaCard*.

...remember that this camcorder is not compatible with other digital video formats.

...remember that this camcorder is intended for private consumer use only. Any commercial use without proper permission is prohibited. (Even if you record an event such as a show, performance or exhibition for personal enjoyment, it is strongly recommended that you obtain permission beforehand.)

GETTING STARTED	5	ADVANCED FEATURES	25
Provided Accessories	5	MENUS FOR DETAILED ADJUSTMENT	25
Power	6	Changing The Menu Settings	25
Grip Adjustment	7	Recording Menus	26
Operation Mode	8	Playback Menus	28
Date/Time Settings	8	FEATURES FOR RECORDING	29
Viewfinder Adjustment	9	White LED Light	29
Brightness Adjustment Of The Display	9	Night Alive	29
Tripod Mounting	9	Wipe Or Fader Effects	30
Loading/Unloading A Cassette	10	Program AE With Special Effects	30
Loading/Unloading A Memory Card	10	Snapshot (For Video Recording)	31
VIDEO RECORDING & PLAYBACK	11	Auto Focus	31
VIDEO RECORDING	11	Manual Focus	32
Basic Recording	11	Exposure Control	32
LCD Monitor And Viewfinder	12	Iris Lock	32
Tape Remaining Time	12	Backlight Compensation	33
Zooming	12	White Balance Adjustment	33
Journalistic Shooting	13	Manual White Balance Adjustment	33
Self Recording	13	EDITING	34
Time Code	13	Dubbing To Or From A VCR	34
Recording From The Middle Of A Tape	13	Dubbing To Or From A Video Unit Equipped With A DV Connector (Digital Dubbing)	35
VIDEO PLAYBACK	14	Connection To A Personal Computer	36
Normal Playback	14	Audio Dubbing	37
Still Playback	14	Insert Editing	37
Shuttle Search	14	REFERENCES	38
Blank Search	14	ADDITIONAL INFORMATION	38
Playback Using The Remote Control	15	TROUBLESHOOTING	40
Connections To A TV Or VCR	17	CAUTIONS	45
DIGITAL STILL CAMERA (D.S.C.) RECORDING & PLAYBACK	18	USER MAINTENANCE	48
D.S.C. RECORDING	18	SPECIFICATIONS	49
Basic Shooting (D.S.C. Snapshot)	18	INDEX	50
Dubbing Still Images Recorded On A Tape To A Memory Card	19	TERMS	54
D.S.C. PLAYBACK	20		
Normal Playback Of Images	20		
Auto Playback Of Images	20		
Index Playback Of Files	20		
Viewing File Information	21		
Removing On-Screen Display	21		
ADDITIONAL FEATURES FOR D.S.C.	22		
Protecting Files	22		
Deleting Files	22		
Setting Print Information (DPOF Setting)	23		
Resetting The File Name	24		
Initializing A Memory Card	24		

Provided Accessories

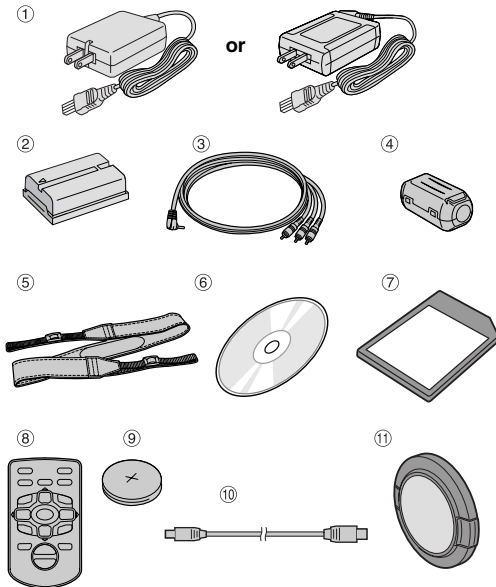

- ① AC Adapter AP-V14U or AP-V15U
- ② Battery Pack BN-V408U-B
- ③ Audio/Video Cable (ø3.5 mini-plug to RCA plug)
- ④ Core Filter (for USB Cable and optional S-Video Cable. See pg. 6 for attachment)
- ⑤ Shoulder Strap (See the right column for attachment)
- ⑥ CD-ROM
- ⑦ Memory Card 8 MB (Already inserted in the camcorder)
- ⑧ Remote Control Unit RM-V718U
- ⑨ Lithium Battery CR2025* (for remote control unit)
- ⑩ USB Cable
- ⑪ Lens Cap (See the right column for attachment)

* A lithium battery is pre-installed in the Remote Control Unit at time of shipment (with insulation sheet). To use the Remote Control Unit, remove the insulation sheet.

NOTES:

- In order to maintain optimum performance of the camcorder, provided cables may be equipped with one or more core filter. If a cable has only one core filter, the end that is closest to the filter should be connected to the camcorder.
- Make sure to use the provided cables for connections. Do not use any other cables.

How To Attach The Lens Cap

To protect the lens, attach the provided lens cap to the camcorder as shown in the illustration.

NOTE:

To confirm the lens cap is on correctly make sure the cap is flush to the camcorder.

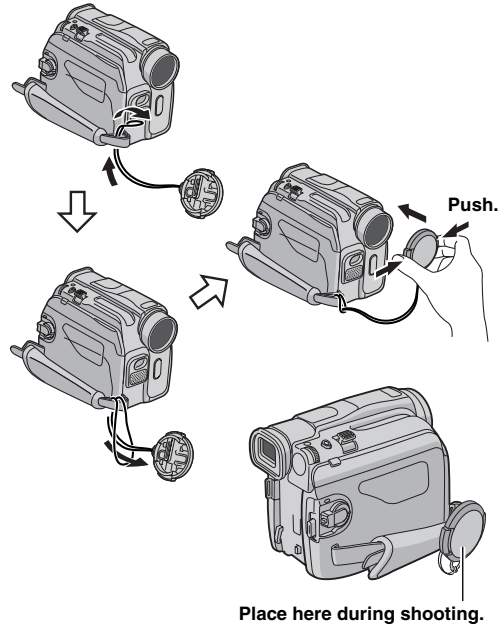

How To Attach The Shoulder Strap

Follow the illustration.

- 1 Thread the strap through the eyelet.
 - 2 Fold it back and thread it through the strap guide and the buckle.
 - 3 Slide the strap guide fully towards the eyelet.
- To adjust the length of the strap, loosen and then tighten the strap in the buckle.

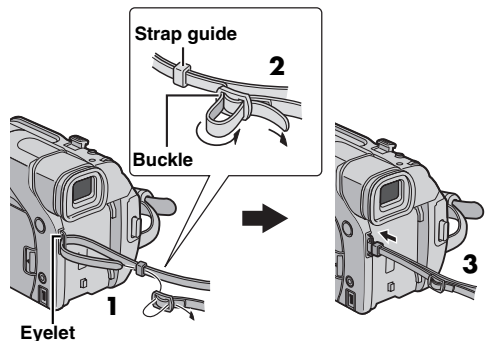

How To Attach The Core Filter (for USB Cable and optional S-Video Cable)

Attach the core filters to the cables. The core filter reduces interference.

1 Release the stoppers on both ends of the core filter.

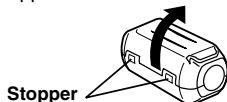

2 Run the cable through the core filter, leaving approx. 3 cm of cable between the cable plug and the core filter. Wind the cable once around the outside of the core filter as shown in the illustration.

- Wind the cable so that it is not slack.

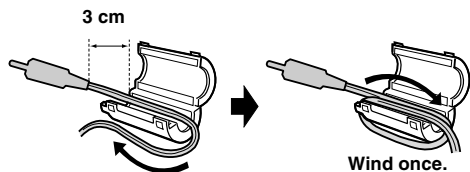

3 Close the core filter until it clicks shut.

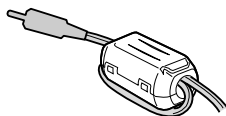

NOTES:

- Take care not to damage the cable.
- When connecting a cable, attach the end with the core filter to the camcorder.

Power

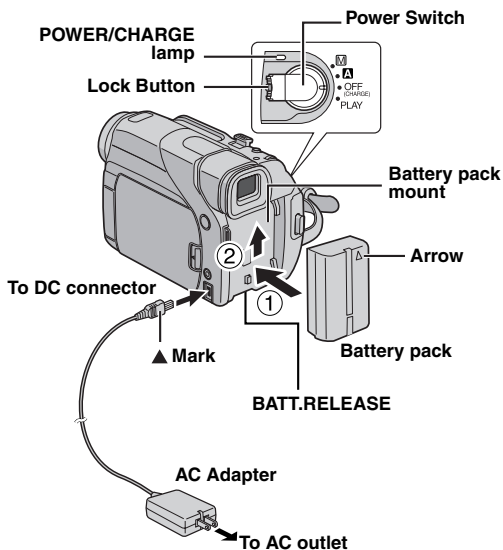

This camcorder's 2-way power supply system lets you choose the most appropriate source of power. Do not use provided power supply units with other equipment.

Charging The Battery Pack

- 1** With the arrow on the battery pack pointing upward, push the battery pack slightly against the battery pack mount ①.
- 2** Slide up the battery pack until it locks in place ②.
- 3** Set the Power Switch to "OFF (CHARGE)".
- 4** Connect the AC Adapter to the camcorder.
- 5** Plug the AC Adapter into an AC outlet. The **POWER/CHARGE** lamp on the camcorder blinks to indicate charging has started.
- 6** When the **POWER/CHARGE** lamp goes out, charging is finished. Unplug the AC Adapter from the AC outlet. Disconnect the AC Adapter from the camcorder.

To detach the battery pack

Slide the battery pack down slightly while sliding **BATT.RELEASE** to detach it.

Battery pack	Charging time
BN-V408U*	Approx. 1 hr. 30 min.
BN-V416U	Approx. 3 hr.
BN-V428U	Approx. 5 hr.

* Provided

NOTES:

- If the protective cap is attached to the battery pack, remove it first.
- During charging, the camcorder cannot be operated.

- When charging the battery pack for the first time or after a long storage period, the **POWER/CHARGE** lamp may not light. In this case, remove the battery pack from the camcorder, then try charging again.
- If the battery operation time remains extremely short even after having been fully charged, the battery is worn out and needs to be replaced. Please purchase a new one.
- **For other notes,**  **pg. 38.**

Using The Battery Pack

Perform steps **1 – 2** in “Charging The Battery Pack”.

Maximum continuous recording time

Battery pack	LCD monitor on	Viewfinder on
BN-V408U*	1 hr. 10 min.	1 hr. 40 min.
BN-V416U	2 hr. 20 min.	3 hr. 15 min.
BN-V428U	4 hr. 10 min.	5 hr. 50 min.

* Provided

NOTES:

- Recording time is reduced significantly under the following conditions:
 - Zoom or Record-Standby mode is engaged repeatedly.
 - The LCD monitor is used repeatedly.
 - The playback mode is engaged repeatedly.
 - The White LED Light is used.
- Before extended use, it is recommended that you prepare enough battery packs to cover 3 times the planned shooting time.

ATTENTION:

Before detaching the power source, make sure that the camcorder's power is turned off. Failure to do so can result in a camcorder malfunction.

Using AC Power

Connect the AC Adapter to the camcorder as shown in the illustration on page 6.

NOTES:

- The provided AC Adapter features automatic voltage selection in the AC range from 110 V to 240 V.
- Do not allow the DC terminals of the AC Adapter to come in contact with metals, as this can result in a short circuit and cause malfunction.
- **For other notes,**  **pg. 38.**

About Batteries

DANGER! Do not attempt to take the batteries apart, or expose them to flame or excessive heat, as it may cause a fire or explosion.

WARNING! Do not allow the battery or its terminals to come in contact with metals, as this can result in a short circuit and possibly start a fire.

The Benefits Of Lithium-Ion Batteries

Lithium-ion battery packs are small but have a large power capacity. However, when one is exposed to cold temperatures (below 10°C/50°F), its usage time becomes shorter and it may cease to function. If this happens, place the battery pack in your pocket or other warm, protected place for a short time, then re-attach it to the camcorder. As long as the battery pack itself is not cold, it should not affect performance. (If you're using a heating pad, make sure the battery pack does not come in direct contact with it.)

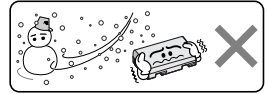

Lithium-ion is vulnerable in colder temperatures.

For other notes,  **pg. 38.**

Grip Adjustment

- 1** Adjust the velcro strip.
- 2** Pass your right hand through the loop and grasp the grip.
- 3** Adjust your thumb and fingers through the grip to easily operate the Recording Start/Stop Button, Power Switch and Power Zoom Lever. Be sure to fasten the velcro strip to your preference.

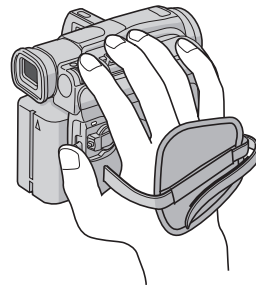

Operation Mode

To turn on the camcorder, set the Power Switch to any operation mode except "OFF (CHARGE)" while pressing down the Lock Button located on the switch.

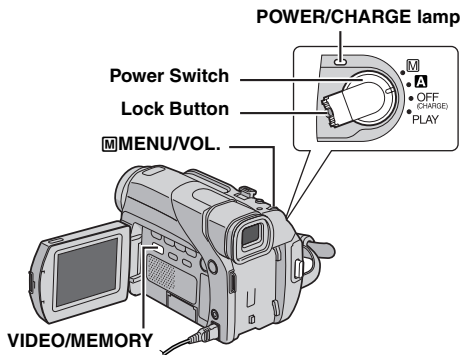

Choose the appropriate operation mode according to your preference using the Power Switch and VIDEO/MEMORY Switch.

Power Switch Position

A (Full Auto Recording):

Allows you to record using NO special effects or manual adjustments. Suitable for standard recording. The "A" indicator appears on the display.

M (Manual Recording):

Allows you to set various recording functions using the Menus. (☞ pg. 25)
If you want more creative capabilities than Full Auto Recording, try this mode.
There is no indication on the display.

OFF:

Allows you to switch off the camcorder.

PLAY:

- Allows you to play back a recording on the tape.
- Allows you to display a still image stored in the memory card or to transfer a still image stored in the memory card to a PC.
- Allows you to set various playback functions using the Menus. (☞ pg. 25)

VIDEO/MEMORY Switch Position

VIDEO:

Allows you to record on a tape or play back a tape. If "REC SELECT" is set to "▶ [VIDEO] / ▶ [MEMORY]" (☞ pg. 28), still images are recorded both on the tape and the memory card.

MEMORY:

- Allows you to record in a memory card or access data stored in a memory card.
- When the Power Switch is set to "A" or "M", the currently selected image size appears.

Power-Linked Operation

When the Power Switch is set to "A" or "M", you can also turn on/off the camcorder by opening/closing the LCD monitor or pulling out/pushing in the viewfinder.

INFORMATION:

The following explanations in this manual supposes the use of LCD monitor in your operation. If you want to use the viewfinder, close the LCD monitor and pull out the viewfinder fully.

Date/Time Settings

The date/time is recorded onto the tape at all times, but its display can be turned on or off during playback. (☞ pg. 25, 28)

1 Set the Power Switch to "M" while pressing down the Lock Button located on the switch.

2 Open the LCD monitor fully. (☞ pg. 12)

3 Press the MENU/VOL. Wheel in. The Menu Screen appears.

4 Rotate the MENU/VOL. Wheel to select "CAMERA", and press it. The CAMERA DISPLAY Menu appears.

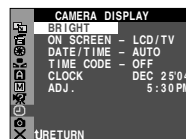

5 Rotate the MENU/VOL. Wheel to select "CLOCK ADJ.", and press it. The parameter for "Month" is highlighted.

6 Rotate the MENU/VOL. Wheel to input the month, and press it. Repeat to input the day, year, hour and minute.

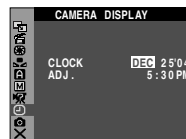

7 Rotate the MENU/VOL. Wheel to select "RETURN", and press it twice. The Menu Screen closes.

NOTE:

Even if you select "CLOCK ADJ.", if the parameter is not highlighted, the camcorder's internal clock continues to operate. Once you move the highlight bar to the first date/time parameter (month), the clock stops. When you finish setting the minute and press the MENU/VOL. Wheel in, the date and time begin operation from the date and time you have just set.

Viewfinder Adjustment

- 1 Set the Power Switch to "A" or "M" while pressing down the Lock Button located on the switch.
- 2 Make sure the LCD monitor is closed and locked. Pull out the viewfinder fully and adjust it manually for best viewability.
- 3 Turn the Diopter Adjustment Control until the indications in the viewfinder are clearly focused.

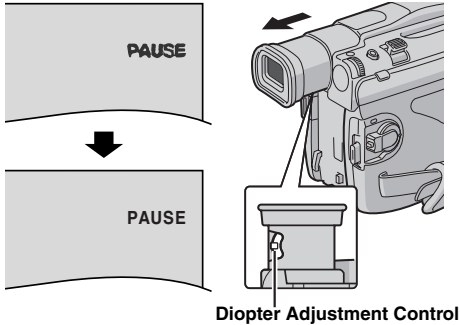

Diopter Adjustment Control

CAUTION:

When retracting the viewfinder, take care not to pinch your fingers.

Brightness Adjustment Of The Display

- 1 Set the Power Switch to "M" or "PLAY" while pressing down the Lock Button located on the switch.
- 2 Open the LCD monitor fully. (☞ pg. 12)
- 3 Press the **MENU/VOL.** Wheel in. The Menu Screen appears.
- 4 Rotate the **MENU/VOL.** Wheel to select "B", and press it. The CAMERA DISPLAY Menu appears.
- 5 Rotate the **MENU/VOL.** Wheel to select "BRIGHT", and press it. The Menu Screen closes and the brightness control indicator appears.
- 6 Rotate the **MENU/VOL.** Wheel until the appropriate brightness is reached.
- 7 Press the **MENU/VOL.** Wheel in.
 - It is also possible to adjust the brightness of the viewfinder by pulling out the viewfinder, setting "PRIORITY" in the SYSTEM Menu to "FINDER" (☞ pg. 25, 27) and adjusting as described above.

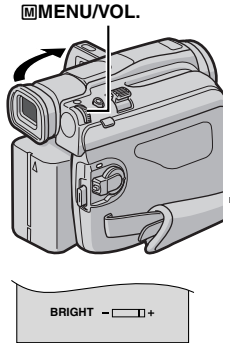

GETTING STARTED

Tripod Mounting

To attach the camcorder to a tripod, align the direction stud and screw to the mounting socket and stud hole on the camcorder. Then tighten the screw clockwise.

- Some tripods are not equipped with studs.

CAUTION:

When attaching the camcorder to a tripod, extend its legs to stabilize the camcorder. It is not advised to use small sized tripods. This may cause damage to the unit by falling over.

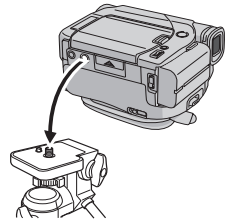

Loading/Unloading A Cassette

The camcorder needs to be powered up to load or eject a cassette.

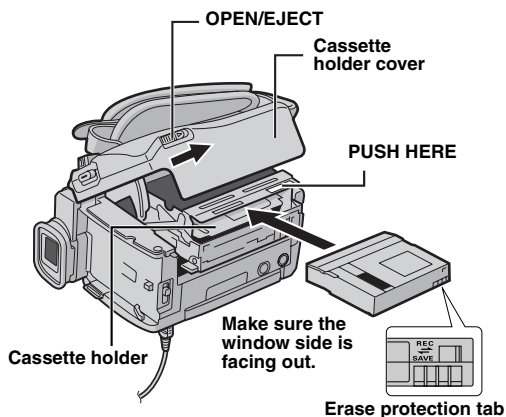

- 1** Slide and hold **OPEN/EJECT** in the direction of the arrow, then pull the cassette holder cover open until it locks. The cassette holder opens automatically.
 - Do not touch internal components.
- 2** Insert or remove a tape and press "PUSH HERE" to close the cassette holder.
 - Be sure to press only the section labeled "PUSH HERE" to close the cassette holder; touching other parts may cause your finger to get caught in the cassette holder, resulting in injury or product damage.
 - Once the cassette holder is closed, it recedes automatically. Wait until it recedes completely before closing the cassette holder cover.
 - When the battery pack's charge is low, you may not be able to close the cassette holder cover. Do not apply force. Replace the battery pack with a fully charged one or use AC power before continuing.
- 3** Close the cassette holder cover firmly until it locks into place.

Approximate recording time

Tape	Recording mode	
	SP	LP
30 min.	30 min.	45 min.
60 min.	60 min.	90 min.
80 min.	80 min.	120 min.

To switch the recording mode, refer to pages 25 and 26.

To protect valuable recordings

Slide the erase protection tab on the back of the tape in the direction of "SAVE". This prevents the tape from being recorded over. To record on this tape, slide the tab back to "REC" before loading it.

For other notes, pg. 38.

Loading/Unloading A Memory Card

The provided memory card is already inserted in the camcorder at the time of purchase.

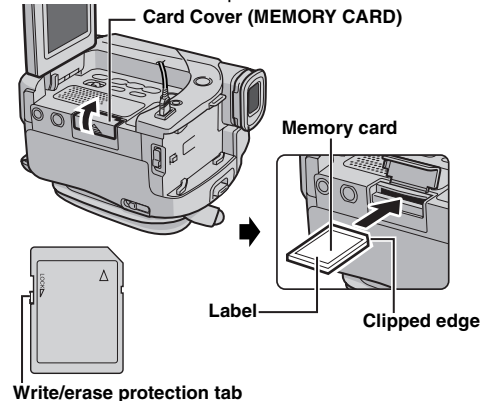

- 1** Make sure the camcorder's power is off.
- 2** Open the LCD monitor (pg. 12), then open the card cover (MEMORY CARD).
- 3** To load a memory card, firmly insert it with its clipped edge first.
 - To unload a memory card, push it once. After the memory card comes out of the camcorder, pull it out.
 - Do not touch the terminal on the reverse side of the label.
- 4** Close the card cover.

To protect valuable files (available only for SD Memory Card)

Slide the write/erase protection tab on the side of the memory card in the direction of "LOCK". This prevents the memory card from being recorded over. To record on this memory card, slide the tab back to the position opposite to "LOCK" before loading it.

NOTES:

- Be sure to use only SD Memory Cards marked "**SD**" or MultiMediaCards marked "MultiMediaCard".
- Some brands of memory cards are not compatible with this camcorder. Before purchasing a memory card, consult its manufacturer or dealer.
- Before using a new memory card, it is necessary to **FORMAT** the card. (pg. 24)

ATTENTION:

Do not insert or remove the memory card while the camcorder is turned on, as this may cause the memory card to be corrupted or cause the camcorder to become unable to recognize whether or not the card is installed.

Basic Recording

NOTE:

Before continuing, perform the procedures listed below:

- Power (⇨ pg. 6)
- Loading A Cassette (⇨ pg. 10)

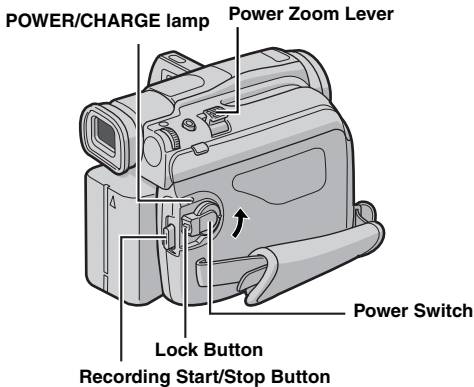
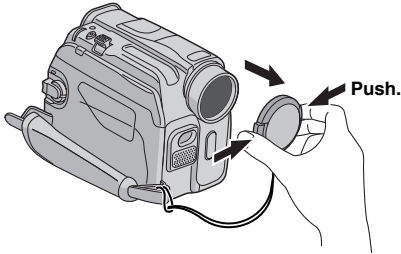

- 1 Remove the lens cap.
- 2 Open the LCD monitor fully. (⇨ pg. 12)
- 3 Set the **VIDEO/MEMORY** Switch to "VIDEO".
- 4 Set the Power Switch to "A" or "M" while pressing down the Lock Button located on the switch.
 - The **POWER/CHARGE** lamp lights and the camcorder enters the Record-Standby mode. "PAUSE" is displayed.
 - To record in LP (Long Play) mode, ⇨ pg. 25, 26.
- 5 To start recording, press the Recording Start/Stop Button. The "REC" appears on the display while recording is in progress.
- 6 To stop recording, press the Recording Start/Stop Button again. The camcorder re-enters the Record-Standby mode.

NOTES:

- The image will not appear simultaneously on the LCD monitor and the viewfinder.
- If the Record-Standby mode continues for 5 minutes, the camcorder's power shuts off automatically. To turn the camcorder on again, push back and pull out the viewfinder again or close and re-open the LCD monitor.
- LCD monitor/viewfinder indications:
 - When power is supplied from a battery: the "☐" battery indicator is displayed. (⇨ pg. 43)
 - When power is supplied from an AC outlet: the "☐" battery indicator does not appear.
- When a blank portion is left between recorded scenes on the tape, the time code is interrupted and errors may occur when editing the tape. To avoid this, refer to "Recording From The Middle Of A Tape" (⇨ pg. 13).
- To turn the beep sounds off, ⇨ pg. 25, 27.
- For other notes, ⇨ pg. 38.

LCD Monitor And Viewfinder

While using the LCD monitor:

Make sure the viewfinder is pushed back in. Press the Monitor Opening Button and open the LCD monitor fully. It can rotate 270° (90° downward, 180° upward).

While using the viewfinder:

Make sure the LCD monitor is closed and locked. Pull out the viewfinder fully.

- Be sure to pull out the viewfinder until you hear a click, otherwise it may be pushed back in during use.

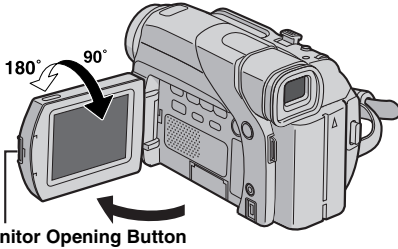

NOTES:

- The image will not appear simultaneously on the LCD monitor and the viewfinder. When the viewfinder is pulled out while the LCD monitor is opened, you can select which one to use. Set "PRIORITY" to the desired mode in SYSTEM Menu. (⇨ pg. 25, 27)
- Colored bright spots may appear all over the LCD monitor or the viewfinder. However, this is not a malfunction. (⇨ pg. 42)

Tape Remaining Time

Approximate tape remaining time appears on the display. "– h – m" means the camcorder is calculating the remaining time. When the remaining time reaches 2 minutes, the indication starts blinking.

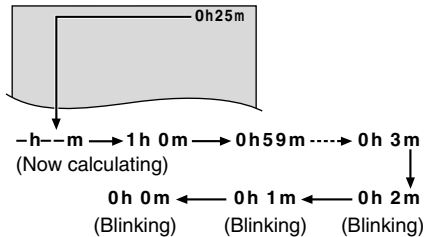

Zooming

Produces the zoom in/out effect, or an instantaneous change in image magnification.

Zoom In

Slide the Power Zoom Lever towards "T".

Zoom Out

Slide the Power Zoom Lever towards "W".

- The further you slide the Power Zoom Lever, the quicker the zoom action.

Zoom in (T: Telephoto)

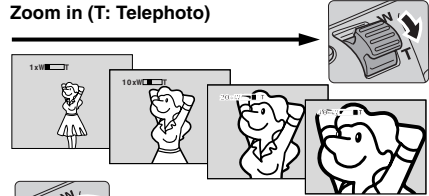

Zoom out (W: Wide angle)

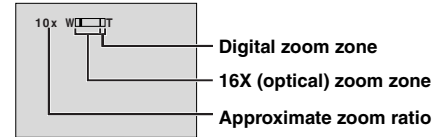
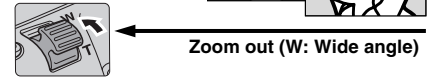

NOTES:

- Focusing may become unstable during Zooming. In this case, set the zoom while in Record-Standby, lock the focus by using the manual focus (⇨ pg. 32), then zoom in or out in Record mode.
- Zooming is possible to a maximum of 700X, or it can be switched to 16X magnification using the optical zoom. (⇨ pg. 26)
- Zoom magnification of over 16X is done through Digital image processing, and is therefore called Digital Zoom.
- During Digital zoom, the quality of image may suffer.
- Digital zoom cannot be used when the VIDEO/MEMORY Switch is set to "MEMORY".
- Macro shooting (as close as approx. 5 cm (2") to the subject) is possible when the Power Zoom Lever is set all the way to "W". Also see "TELE MACRO" in MANUAL Menu on page 26.

Journalistic Shooting

In some situations, different shooting angles may provide more dramatic results. Hold the camcorder in the desired position and tilt the LCD monitor in the most convenient direction. It can rotate 270° (90° downward, 180° upward).



Self Recording

Open the LCD monitor and tilt it upward to 180° so that it faces forward, then point the lens toward yourself and start recording.



Self Recording

Time Code

During recording, a time code is recorded on the tape. This code is to confirm the location of the recorded scene on the tape during playback.

Display

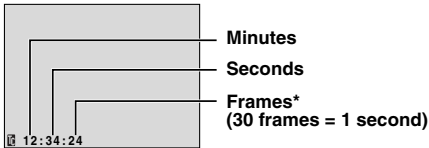

* Frames are not displayed during recording.

If recording starts from a blank portion, the time code begins counting from "00:00:00" (minute:second:frame). If recording starts from the end of a previously recorded scene, the time code continues from the last time code number.

If during recording a blank portion is left partway through the tape, the time code is interrupted. When recording is resumed, the time code starts counting up again from "00:00:00". This means the camcorder may record the same time codes as those existing in a previously recorded scene. To prevent this, perform "Recording From The Middle Of A Tape" (See the right column) in the following cases;

- When shooting again after playing back a recorded tape.
- When power shuts off during shooting.
- When a tape is removed and re-inserted during shooting.
- When shooting using a partially recorded tape.
- When shooting on a blank portion located partway through the tape.
- When shooting again after shooting a scene then opening/closing the cassette holder cover.

Recording From The Middle Of A Tape

- 1) Play back a tape or use Blank Search (☞ pg. 14) to find the spot at which you want to start recording, then engage the Still Playback mode. (☞ pg. 14)
- 2) Set the Power Switch to "⏻" or "⏮" while pressing down the Lock Button located on the switch, then start recording.

NOTES:

- The time code cannot be reset.
- During fast-forwarding and rewinding, the time code indication does not move smoothly.
- The time code is displayed only when "TIME CODE" is set to "ON". (☞ pg. 27)

When a blank portion is recorded on a tape

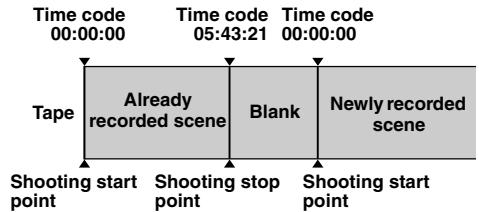

Proper recording

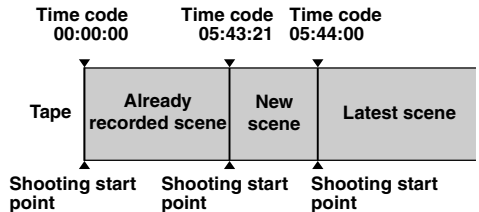

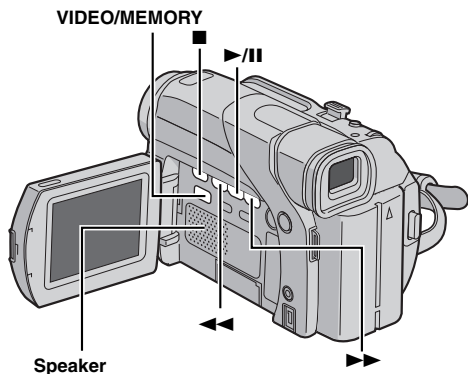
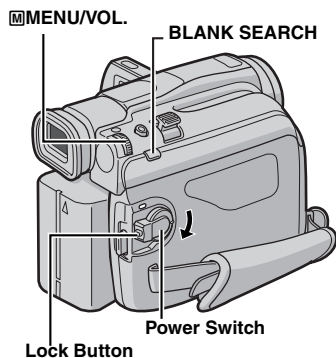

Normal Playback

- 1 Load a cassette. (☞ pg. 10)
- 2 Set the VIDEO/MEMORY Switch to "VIDEO".
- 3 Set the Power Switch to "PLAY" while pressing down the Lock Button located on the switch.
- 4 To start playback, press ►/II.
- 5 To stop playback, press ■.
 - During Stop mode, press ◀◀ to rewind, or ►► to fast-forward the tape.

To control the speaker volume

Rotate the MENU/VOL. Wheel towards "+" to turn up the volume, or towards "-" to turn down the volume.

NOTES:

- The playback picture can be viewed in the LCD monitor, viewfinder or on a connected TV. (☞ pg. 17)
- For other notes, ☞ pg. 39.

Still Playback

Pauses during video playback.

- 1) Press ►/II during playback.
- 2) To resume normal playback, press ►/II again.
 - If still playback continues for more than about 3 minutes, the camcorder's Stop mode is automatically engaged.
 - When ►/II is pressed, the image may not pause immediately while the camcorder stabilizes the still image.

Shuttle Search

Allows high-speed search in either direction during video playback.

- 1) During playback, press ►► for forward search, or ◀◀ for reverse search.
- 2) To resume normal playback, press ►/II.
 - During playback, press and hold ►► or ◀◀. The search continues as long as you hold the button. Once you release the button, normal playback resumes.
 - A slight mosaic effect appears on the display during Shuttle Search. This is not a malfunction.

ATTENTION:

During Shuttle Search, parts of the picture may not be clearly visible, particularly on the left side of the screen.



Blank Search

Helps you find where you should start recording in the middle of a tape to avoid time code interruption.

(☞ pg. 13)

- 1 Load a cassette. (☞ pg. 10)
- 2 Set the VIDEO/MEMORY Switch to "VIDEO".
- 3 Set the Power Switch to "PLAY" while pressing down the Lock Button located on the switch.
- 4 During Stop mode, press BLANK SEARCH.
 - The "BLANK SEARCH" indication appears and the camcorder automatically starts reverse or forward search, then stops at the spot which is about 3 seconds of tape before the beginning of the detected blank portion.
 - To cancel Blank Search midway, press ■.

NOTES:

- Before starting Blank Search, if the current position is at a blank portion, the camcorder searches in the reverse direction. If the current position is at a recorded portion, the camcorder searches in the forward direction.
- Blank Search does not work if "USE CLEANING CASSETTE" has appeared with the tape.
- If the beginning or end of the tape is reached during Blank Search, the camcorder stops automatically.
- A blank portion which is shorter than 5 seconds of tape may not be detected.
- The detected blank portion may be located between recorded scenes. Before you start recording, make sure there is no recorded scene after the blank portion.

Playback Using The Remote Control

The Full-Function Remote Control Unit can operate this camcorder from a distance as well as the basic operations (Playback, Stop, Pause, Fast-Forward and Rewind) of your VCR. It also makes additional playback functions possible. (☞ pg. 16)

Installing The Battery

The remote control uses one lithium battery (CR2025).

1 Pull out the battery holder by inserting a pointed instrument into the slot.

2 Insert the battery in the holder, and be sure to have the "+" mark visible.

3 Slide the holder back in until you hear a click.

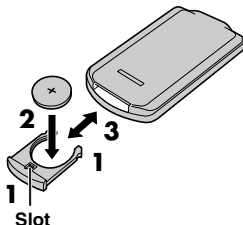

Beam Effective Area (indoor use)

When using the remote control, be sure to point it at the remote sensor. The transmitted beam's approximate effective distance for indoor use is 5 m (16 ft).

NOTE:

The transmitted beam may not be effective or may cause incorrect operation when the remote sensor is directly exposed to sunlight or powerful lighting.

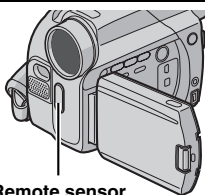

Remote sensor

Buttons And Functions

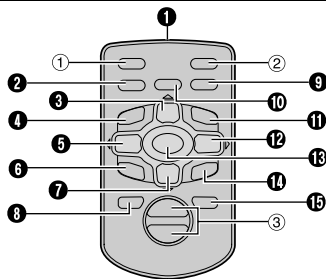

1 Infrared beam transmitting window

The following buttons are available only when the camcorder's Power Switch is set to "PLAY".

- 2 AUDIO Button (☞ pg. 25, 28)
- 3 PAUSE Button* (☞ pg. 16)
Up Button (☞ pg. 16)
- 4 SLOW Rewind Button (☞ pg. 16)
- 5 REW Button* (☞ pg. 14, 20)
Left Button (☞ pg. 16)
- 6 INSERT Button (☞ pg. 37)
- 7 STOP Button* (☞ pg. 14, 20)
Down Button (☞ pg. 16)
- 8 SHIFT Button (☞ pg. 16)
- 9 EFFECT ON/OFF Button (☞ pg. 16)
- 10 EFFECT Button (☞ pg. 16)
- 11 SLOW Forward Button (☞ pg. 16)
- 12 FF Button* (☞ pg. 14, 20)
Right Button (☞ pg. 16)
- 13 PLAY Button* (☞ pg. 14, 20)
- 14 A. DUB Button (☞ pg. 37)
- 15 DISPLAY Button (☞ pg. 17, 34)

The following buttons are available when the camcorder's Power Switch is set to "A" or "M".

- 1 S.SHOT (Snapshot) Button*
- 2 START/STOP Button*
- 3 Zoom (T/W) Buttons** (☞ pg. 12, 16)

* Functions the same as each corresponding button on the camcorder. (☞ pg. 51)

** Functions when the camcorder's Power Switch is set to "PLAY" as well.

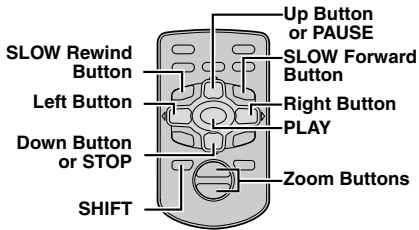

Slow-Motion Playback

Allows slow-speed search in either direction during video playback.

During normal video playback, press **SLOW** (◀| or |▶) more than approx. 2 seconds.

- After approx. 5 minutes (approx. 20 seconds with an 80-minute cassette) in Slow Rewind or approx. 5 minutes in Slow Forward, normal playback resumes.
- To pause Slow-Motion playback, press **PAUSE** (||).
- To stop Slow-Motion playback, press **PLAY** (▶).

NOTES:

- You can also engage Slow-Motion Playback from Still Playback by pressing **SLOW** (◀| or |▶) more than approx. 2 seconds.
- During Slow-Motion Playback, due to digital image processing, the picture may take on a mosaic effect.
- After **SLOW** (◀| or |▶) is pressed and held, the still image may be displayed for a few seconds, followed by a blue screen for a few seconds. This is not a malfunction.
- There may be a small margin between the slow-motion playback start point you chose and the actual start point for Slow-Motion Playback.
- During Slow-Motion Playback, there will be disturbances in video and the picture may seem unstable, especially with steady images. This is not a malfunction.

Frame-By-Frame Playback

Allows frame-by-frame search during video playback.

During normal or still playback, press **SLOW** (|▶) repeatedly for forward or **SLOW** (◀|) repeatedly for reverse. Each time **SLOW** (◀| or |▶) is pressed, the frame is played back.

Playback Zoom

Magnifies the recorded image up to 44X at any time during video playback and D.S.C. playback.

1) Press **PLAY** (▶) to start video playback. Or perform normal playback of images.



2) At the point you want to zoom in, press the Zoom Button (T).

- To zoom out, press the Zoom Button (W).



3) You can move the image on the screen around to find a particular portion of the picture. While holding down **SHIFT**, press ◀ (Left), ▶ (Right), ▲ (Up) and ▼ (Down).

- To end zoom, press and hold **W** until magnification returns to normal. Or, press **STOP** (■) and then press **PLAY** (▶) during video playback.



NOTES:

- Zoom can also be used during slow-motion and still playback.
- Due to digital image processing, the quality of the image may suffer.

Playback Special Effects

Allows you to add creative effects to the video playback image.

The effects that can be used during playback are **CLASSIC FILM**, **MONOTONE**, **SEPIA** and **STROBE**. The effects work the same in playback as they did in recording. (▶ pg. 30)

🎞️ **CLASSIC FILM:** Gives recorded scenes a strobe effect.

⚫ **B/W MONOTONE:** Like classic black and white films, your footage is shot in B/W. Used together with the Cinema mode, it enhances the "classic film" effect.

📷 **SEPIA:** Recorded scenes have a brownish tint like old photos. Combine this with the Cinema mode for a classic look.

📺 **STROBE:** Your recording looks like a series of consecutive snapshots.

1) To start playback, press **PLAY** (▶).

2) Press **EFFECT**.

The **PLAYBACK EFFECT** Select Menu appears.

3) Press **EFFECT** repeatedly to move the highlight bar to the desired effect.

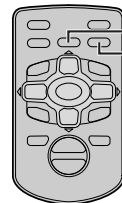

- The selected function is activated and after 2 seconds the menu disappears.
- To deactivate the selected effect, press **EFFECT ON/OFF**. To reactivate the selected effect press **EFFECT ON/OFF** again.
- To change the selected effect, repeat from step 2 above.

Connections To A TV Or VCR

These are some basic types of connections. When making the connections, refer also to your VCR and TV instruction manuals.

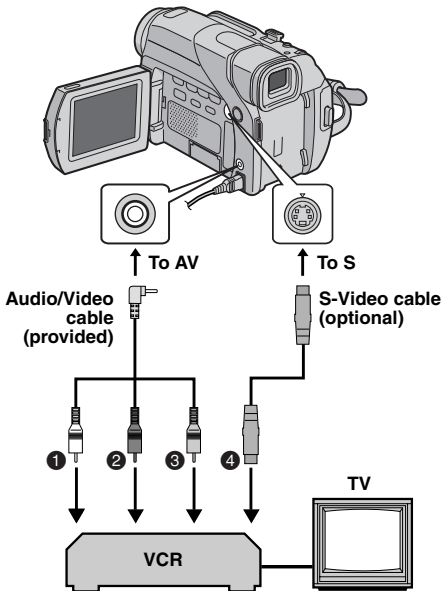

- ① White to AUDIO L IN*
- ② Red to AUDIO R IN*
- ③ Yellow to VIDEO IN**
- ④ To S-VIDEO IN***

* Not required for watching still images only.

** Connect when your TV/VCR has only A/V input connectors.

*** Connect when your TV/VCR has S-VIDEO IN and A/V input connectors. In this case, it is not necessary to connect the yellow video cable.

- 1 Make sure all units are turned off.
- 2 Connect the camcorder to a TV or VCR as shown in the illustration.
- If using a VCR, go to step 3.**
- If not, go to step 4.**
- 3 Connect the VCR output to the TV input, referring to your VCR's instruction manual.
- 4 Turn on the camcorder, the VCR and the TV.
- 5 Set the VCR to its AUX input mode, and set the TV to its VIDEO mode.

To choose whether or not the following displays appear on the connected TV

- Date/Time
 - Set "DATE/TIME" to "AUTO", "ON" or "OFF". (pg. 25, 28)
 - Or, press **DISPLAY** on the remote control to turn on/off the date indication.
- Time Code
 - Set "TIME CODE" to "ON" or "OFF". (pg. 25, 28)
- Indications other than date/time and time code
 - Set "ON SCREEN" to "OFF", "LCD" or "LCD/TV". (pg. 25, 28)

NOTES:

- It is recommended to use the AC Adapter as the power supply instead of the battery pack. (pg. 7)
- To monitor the picture and sound from the camcorder without inserting a tape or memory card, set the camcorder's Power Switch to "A" or "M", then set your TV to the appropriate input mode.
- Make sure you adjust the TV sound volume to its minimum level to avoid a sudden burst of sound when the camcorder is turned on.
- If you have a TV or speakers that are not specially shielded, do not place the speakers adjacent to the TV as interference will occur in the camcorder playback picture.
- When a cable is connected to the AV connector, the sound is not heard from the speaker.

Basic Shooting (D.S.C. Snapshot)

You can use your camcorder as a Digital Still Camera for taking snapshots. Still images are stored in the memory card.

NOTE:

Before continuing, perform the procedures listed below:

- Power (☞ pg. 6)
- Loading A Memory Card (☞ pg. 10)

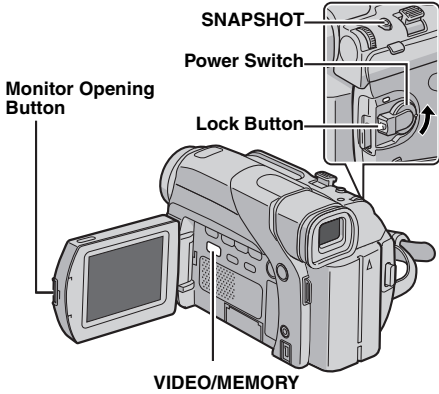

- 1 Image Size (☞ pg. 28, 52)
- 2 Shooting Icon (☞ pg. 52)
- 3 Card Icon (☞ pg. 52)
- 4 Picture Quality (☞ pg. 27, 52)
- 5 Remaining Number Of Shots (☞ pg. 52)

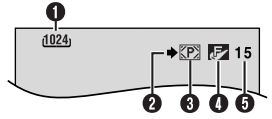

Approximate Number of Storable Images

Image Size/Picture Quality	SD Memory Card			
	8 MB*	16 MB*	32 MB*	64 MB*
640 x 480/FINE	45	95	205	405
640 x 480/STANDARD	160	295	625	1215
1024 x 768/FINE	20	45	95	190
1024 x 768/STANDARD	65	145	310	605

Image Size/Picture Quality	MultiMediaCard		
	8 MB**	16 MB*	32 MB*
640 x 480/FINE	55	105	215
640 x 480/STANDARD	190	320	645
1024 x 768/FINE	24	48	100
1024 x 768/STANDARD	75	160	320

* Optional

** Provided

- 1 Remove the lens cap.
- 2 Open the LCD monitor fully. (☞ pg. 12)
- 3 Set the **VIDEO/MEMORY** Switch to "MEMORY".
- 4 Set the Power Switch to "A" or "M" while pressing down the Lock Button located on the switch.
 - To change the Image Size and/or Picture Quality, ☞ pg. 25, 27.
- 5 Press **SNAPSHOT**. The "PHOTO" indication appears while the snapshot is being taken.
 - Still images are recorded in the snapshot mode with no frame.
 - To delete unwanted still images, refer to "Deleting Files" (☞ pg. 22).
 - When you do not want to hear the shutter sound, set "BEEP" to "OFF". (☞ pg. 25, 27)







Snapshot mode with no frame

There is the sound of a shutter closing.

Dubbing Still Images Recorded On A Tape To A Memory Card

Still images can be dubbed from a tape to a memory card.

- 1** Load a cassette. (☞ pg. 10)
- 2** Load a memory card. (☞ pg. 10)
- 3** Set the **VIDEO/MEMORY** Switch to "VIDEO".
- 4** Set the Power Switch to "PLAY" while pressing down the Lock Button located on the switch.
- 5** Set "☞  COPY" to "ON". (☞ pg. 25, 28)
- 6** Press  to start playback.
- 7** At the point you want to dub, press  again to engage Still Playback.
- 8** To dub the image, press **SNAPSHOT**.
 - The "☞  P" indication appears during dubbing.
 - The selected image is stored in the memory card.

NOTES:

- If **SNAPSHOT** is pressed in step **8** when a memory card is not loaded, the message "COPYING FAILED" is displayed.
- If an image recorded on the tape using "WIDE MODE" (☞ pg. 26) is dubbed to a memory card, the WIDE mode identifying signal is not dubbed with it.
- To use Playback Special effects with a video image you wish to dub, perform up to step **8** using the remote control (provided). (☞ pg. 16)
- Images are dubbed in 640 x 480 pixels.

Normal Playback Of Images

Images shot with the camcorder are automatically numbered, then stored in numerical order in the memory card. You can view the stored images, one at a time, much like flipping through a photo album.

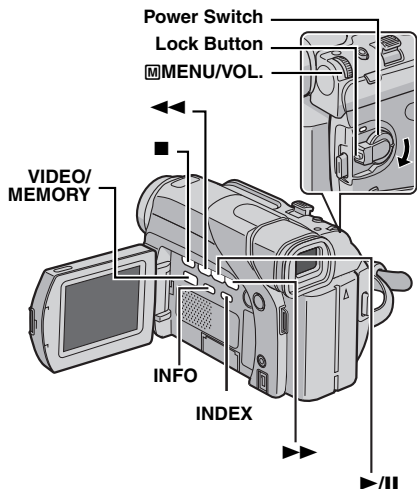

- 1 Load a memory card. (☞ pg. 10)
- 2 Set the **VIDEO/MEMORY** Switch to "MEMORY".
- 3 Set the Power Switch to "PLAY" while pressing down the Lock Button located on the switch.
 - A stored image is displayed.
- 4 Press ◀◀ to display the previous file. Press ▶▶ to display the next file.
 - Pressing **INFO** gives you details on the displayed file. (☞ pg. 21)
 - You can also look for the desired file using Index Screen. (See the right column)
 - You can turn off the on-screen playback display. (☞ pg. 21)

NOTES:

- Even if you shoot a new image after playing back a low-numbered one, this will not overwrite an existing image, because new images are automatically stored after the last-recorded one.
- Images shot in a file size other than "640 x 480" and "1024 x 768" with another devices will be displayed thumbnail images. These thumbnail images cannot be transferred to a PC.
- Images shot with devices (such as JVC GR-DVM70) that are not compatible with DCF cannot be viewed with this camcorder; "UNSUPPORTED FILE!" will be displayed.

Playback Zoom

Available only with the remote control (provided).
(☞ pg. 16)

Auto Playback Of Images

You can run through all the images stored in memory card automatically.

- 1 Perform steps 1 – 3 in "Normal Playback Of Images".
- 2 Press ▶/|| to start Auto Playback.
 - If you press ◀◀ during Auto Playback, files are displayed in descending order.
 - If you press ▶▶ during Auto Playback, files are displayed in ascending order.
- 3 To end Auto Playback, press ■.

To display the next image

To display the previous image

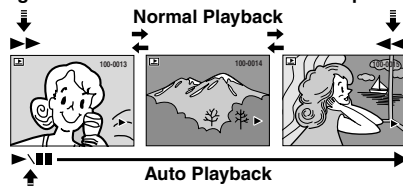

Index Playback Of Files

You can view several different files stored in the memory card at a time. This browsing capability makes it easy to locate a particular file you want.

- 1 Perform steps 1 – 3 in "Normal Playback Of Images".
- 2 Press **INDEX**. The Index Screen appears.
- 3 Rotate the **MENU/VOL.** Wheel to move the frame to the desired file.
 - Press ◀◀ to display the previous page. Press ▶▶ to display the next page.
- 4 Press the **MENU/VOL.** Wheel in. The selected file is displayed.
 - Pressing **INFO** gives you details on the displayed file. (☞ pg. 21)

Selected file



Index number

Viewing File Information

You can get the relevant file information by pressing the **INFO** Button during normal playback or Index Playback.

FOLDER: Folder name (☞ pg. 24)

FILE: File name (☞ pg. 24)

DATE: Date the file was made

SIZE: Image size

QUALITY: Picture quality

PROTECT: When set to "ON", the file is protected from accidental erasure. (☞ pg. 22)

- Press the **INFO** Button again to close the Information Screen.

NOTE:

With images shot with other devices or processed on a PC, "QUALITY: --" will be displayed.

```
FOLDER :100JVCGR
FILE   :DVC00010
DATE   :OCT 03 04
SIZE   :1024X768
QUALITY :FINE
PROTECT :OFF
```

Removing On-Screen Display

1 Perform steps **1 – 3** in "Normal Playback Of Images" (☞ pg. 20).

2 Press the **MENU/VOL.** Wheel in. The Menu Screen appears.

3 Rotate the **MENU/VOL.** Wheel to select "DISPLAY", and press it. The Sub Menu appears.

4 Rotate the **MENU/VOL.** Wheel to select "OFF", and press it. The operation mode indicator, folder/file number and battery indicator (☞) disappear.

- To display the indicators again, select "ON".

Operation mode indicator

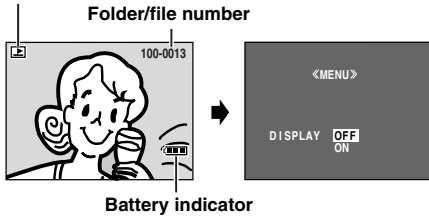

Protecting Files

The Protect mode helps prevent the accidental erasure of files.

- 1 Load a memory card. (☞ pg. 10)
- 2 Set the **VIDEO/MEMORY** Switch to "MEMORY".
- 3 Set the Power Switch to "PLAY" while pressing down the Lock Button located on the switch.
 - A stored file is displayed.
- 4 Press the **MENU/VOL.** Wheel in. The Menu Screen appears.
- 5 Make sure "PROTECT" is selected, and press the **MENU/VOL.** Wheel in. The Sub Menu appears.

To protect the currently displayed file

- 6 Rotate the **MENU/VOL.** Wheel to select "CURRENT", and press it. The PROTECT screen appears.

- 7 Press ◀◀ or ▶▶ to select the desired file.

- 8 Rotate the **MENU/VOL.** Wheel to select "EXECUTE", and press it.

- To cancel protection, select "RETURN".
- Repeat steps 7 and 8 for all files you want to protect.



To protect all files stored in the memory card

- 6 Rotate the **MENU/VOL.** Wheel to select "PROT.ALL", and press it. The PROTECT screen appears.

- 7 Rotate the **MENU/VOL.** Wheel to select "EXECUTE", and press it.

- To cancel protection, select "RETURN".

NOTES:

- If the "Ⓞ" mark appears, the currently displayed file is protected.
- When the memory card is initialized or corrupted, even protected files are deleted. If you do not want to lose important files, transfer them to a PC and save them.

To Remove Protection

Before doing the following, perform steps 1 – 5 in "Protecting Files".

To remove protection from the currently displayed file

- 6 Rotate the **MENU/VOL.** Wheel to select "CURRENT", and press it. The PROTECT screen appears.

- 7 Press ◀◀ or ▶▶ to select the desired file.

- 8 Rotate the **MENU/VOL.** Wheel to select "EXECUTE", and press it.

- To cancel selection, select "RETURN".
- Repeat steps 7 and 8 for all files you want to remove protection.

To remove protection from all files stored in the memory card

- 6 Rotate the **MENU/VOL.** Wheel to select "CANC.ALL", and press it. The PROTECT screen appears.

- 7 Rotate the **MENU/VOL.** Wheel to select "EXECUTE", and press it.

- To cancel selection, select "RETURN".

Deleting Files

Previously stored files can be deleted either one at a time or all at once.

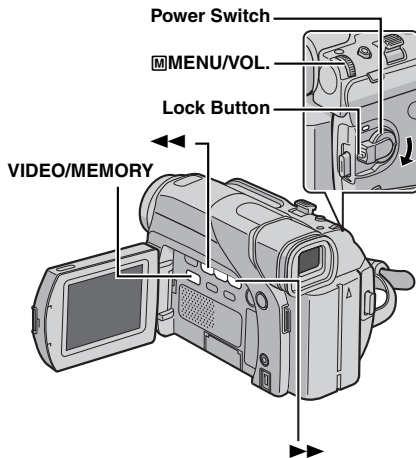

- 1 Load a memory card. (☞ pg. 10)
- 2 Set the **VIDEO/MEMORY** Switch to "MEMORY".

- 3 Set the Power Switch to "PLAY" while pressing down the Lock Button located on the switch.
 - A stored file is displayed.

- 4 Press the **MENU/VOL.** Wheel in. The Menu Screen appears.

- 5 Rotate the **MENU/VOL.** Wheel to select "DELETE", and press it. The Sub Menu appears.

To delete the currently displayed file

- 6 Rotate the **MENU/VOL.** Wheel to select "CURRENT", and press it. The DELETE screen appears.

- 7 Press ◀◀ or ▶▶ to select the desired file.

- 8 Rotate the **MENU/VOL.** Wheel to select "EXECUTE", and press it.

- To cancel deletion, select "RETURN".
- Repeat steps 7 and 8 for all files you want to delete.

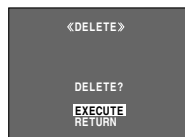

NOTE:

If the "Ⓞ" mark appears, the selected file is protected and cannot be deleted.

To delete all files stored in the memory card

6 Rotate the **MENU/VOL.** Wheel to select "ALL", and press it. The DELETE screen appears.

7 Rotate the **MENU/VOL.** Wheel to select "EXECUTE", and press it.

- To cancel deletion, select "RETURN".

NOTES:

- Protected files (pg. 22) cannot be deleted. To delete them, remove protection first.
- Once files are deleted, they cannot be restored. Check files before deleting.

CAUTION:

Do not remove the memory card or perform any other operation (such as turning off the camcorder) during deletion. Also, be sure to use the provided AC Adapter, as the memory card may be corrupted if the battery becomes exhausted during deletion. If the memory card becomes corrupted, initialize it. (pg. 24)

Setting Print Information (DPOF Setting)

This camcorder is compatible with the DPOF (Digital Print Order Format) standard in order to support future systems such as automatic printing. You can select one of the 2 print information settings for images stored in the memory card: "To Print All Still Images (One Print For Each)" or "To Print By Selecting Still Images And Number Of Prints".

NOTES:

- If you load a memory card already set as shown below in a printer compatible with DPOF, it will make prints of the selected still images automatically.
- To print images recorded on a tape, first dub them to a memory card. (pg. 19)

To Print All Still Images (One Print For Each)

- 1** Load a memory card. (pg. 10)
- 2** Set the VIDEO/MEMORY Switch to "MEMORY".
- 3** Set the Power Switch to "PLAY" while pressing down the Lock Button located on the switch.
 - A stored file is displayed.
- 4** Press the **MENU/VOL.** Wheel in. The Menu Screen appears.
- 5** Rotate the **MENU/VOL.** Wheel to select "DPOF", and press it. The Sub Menu appears.



6 Rotate the **MENU/VOL.** Wheel to select "ALL 1", and press it. The DPOF screen appears.

7 Rotate the **MENU/VOL.** Wheel to select "EXECUTE", and press it. The normal playback screen appears.

- To cancel selection, select "RETURN".



To Print By Selecting Still Images And Number Of Prints

1 Perform steps **1 – 5** in "To Print All Still Images (One Print For Each)".

2 Rotate the **MENU/VOL.** Wheel to select "CURRENT", and press it. The DPOF screen appears.

3 Press **◀** or **▶** to select the desired file.

4 Rotate the **MENU/VOL.** Wheel to select the number indication (00), and press it.

5 Select the number of prints by rotating the **MENU/VOL.** Wheel towards "+" to increase number, or towards "-" to decrease the number, and press it.

- Repeat steps **3** through **5** for the desired number of prints.
- The number of prints can be set up to 15.
- To correct the number of prints, select the image again and change the number.

6 Rotate the **MENU/VOL.** Wheel to select "RETURN", and press it. The "SAVE?" appears.

- If you did not change any settings in step **3** through **5**, the Menu Screen reappears.

7 Rotate the **MENU/VOL.** Wheel to select "EXECUTE" to save the setting you have just made, and press it.

- To cancel selection, select "CANCEL".



To Reset The Number Of Prints

1 Perform steps **1 – 5** in "To Print All Still Images (One Print For Each)".

2 Rotate the **MENU/VOL.** Wheel to select "RESET", and press it. The DPOF screen appears.

3 Rotate the **MENU/VOL.** Wheel to select "EXECUTE", and press it. The normal playback screen appears.

- To cancel selection, select "RETURN".
- The number of prints is reset to 0 for all still images.

CAUTION:

While performing the above, never disconnect power, as this may cause the memory card to be corrupted.

Resetting The File Name

By resetting the file name, a new folder will be made. The new files you are going to make will be stored in the new folder. It is convenient to separate the new files from previously made files.

- 1 Load a memory card. (☞ pg. 10)
- 2 Set the **VIDEO/MEMORY** Switch to "MEMORY".
- 3 Set the Power Switch to "PLAY" while pressing down the Lock Button located on the switch.
 - A stored file is displayed.
- 4 Press the **MENU/VOL.** Wheel in. The Menu Screen appears.
- 5 Rotate the **MENU/VOL.** Wheel to select "NO. RESET", and press it. The NO. RESET screen appears.
- 6 Rotate the **MENU/VOL.** Wheel to select "EXECUTE", and press it. The new folder (such as "101JVCGR") will be made and the file name of the next shot starts from DVC00001.

Folder and File names

Each time shooting takes place, a file name is made using a number which is larger by one than the largest number of the file names which are in use. Even if you delete an image or video clip file with a number in the middle of range, the number will not be used for a new shot; a gap will remain in the numerical sequence. If the file name reaches DVC09999, a new folder (such as "101JVCGR") will be made and the file name will start again from DVC00001.

Initializing A Memory Card

You can initialize a memory card anytime. After initializing, all files and data stored in the memory card, including those which have been protected, are cleared.

- 1 Set the **VIDEO/MEMORY** Switch to "MEMORY".
- 2 Set the Power Switch to "PLAY" while pressing down the Lock Button located on the switch.
- 3 Open the LCD monitor fully. (☞ pg. 12)
- 4 Press the **MENU/VOL.** Wheel in. The Menu Screen appears.

◀MENU▶

PROTECT
DELETE
DPOF
NO. RESET
FORMAT
DISPLAY
BRIGHT
END
- 5 Rotate the **MENU/VOL.** Wheel to select "FORMAT", and press it. The FORMAT screen appears.

◀FORMAT▶

ERASE ALL
EXISTING DATA?

EXECUTE
RETURN
- 6 Rotate the **MENU/VOL.** Wheel to select "EXECUTE", and press it. The memory card is initialized.
 - When initialization is finished, "NO IMAGES STORED" appears.
 - To cancel initialization, select "RETURN".

CAUTION:

Do not perform any other operation (such as turning off the camcorder) during initialization. Also, be sure to use the provided AC Adapter, as the memory card may be corrupted if the battery becomes exhausted during initialization. If the memory card becomes corrupted initialize it.

Changing The Menu Settings

This camcorder is equipped with an easy-to-use, on-screen menu system that simplifies many of the more detailed camcorder settings. (pg. 26 – 28)

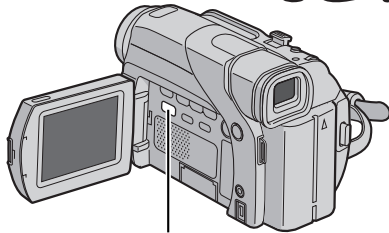
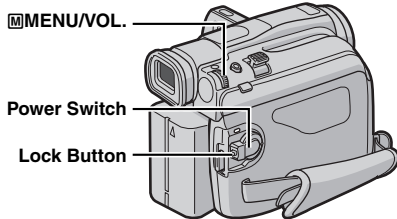

VIDEO/MEMORY

1 Set the VIDEO/MEMORY Switch and the Power Switch as follows.

For Video and D.S.C. Recording Menus:

- Set the VIDEO/MEMORY Switch to "VIDEO" or "MEMORY".
- Set the Power Switch to "M" while pressing down the Lock Button located on the switch.

For Video Playback Menus:

- Set the VIDEO/MEMORY Switch to "VIDEO".
- Set the Power Switch to "PLAY" while pressing down the Lock Button located on the switch.
- For D.S.C. Playback Menus, refer to "D.S.C. PLAYBACK" (pg. 20).

2 Open the LCD monitor fully. (pg. 12)

3 Press the MENU/VOL. Wheel in. The Menu Screen appears.

4 Rotate the MENU/VOL. Wheel to select the desired function, and press it. The selected function menu appears.

Screen for Video and D.S.C. Screen for Video Playback Recording Menu

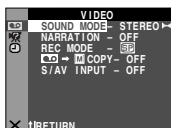
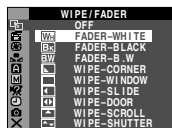

5 Setting procedure hereafter depends on the selected function.

Menus without Sub Menus

- WIPE/FADER (pg. 30)
- PROGRAM AE (pg. 30)
- EXPOSURE (pg. 32)
- W. BALANCE (pg. 33)

1) Rotate the MENU/VOL. Wheel to select the desired parameter.

- Example: PROGRAM AE Menu

2) Press the MENU/VOL. Wheel in. Selection is complete. The Menu Screen returns.

- Repeat the procedure if you wish to set other function menus.

3) Press the MENU/VOL. Wheel in again. The Menu Screen closes.

Selected menu icon blinks.

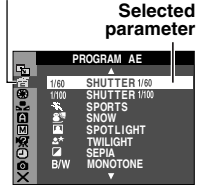

Menus with Sub Menus

- CAMERA (pg. 26)
- MANUAL (pg. 26)
- SYSTEM (pg. 27)
- CAMERA DISPLAY (pg. 27)
- DSC (pg. 27)
- VIDEO (pg. 28)
- VIDEO DISPLAY (pg. 28)

1) Rotate the MENU/VOL. Wheel to select the desired function, and press it. The Sub Menu appears.

- Example: CAMERA Menu
- 2) Rotate the MENU/VOL. Wheel to select the desired parameter.

3) Press the MENU/VOL. Wheel in. Selection is complete. Repeat the procedure if you wish to set other function menus.

4) Press the MENU/VOL. Wheel in. The Menu Screen returns.

- Repeat the procedure if you wish to set other function menus.

5) Press the MENU/VOL. Wheel in again. The Menu Screen closes.

Selected menu icon blinks.

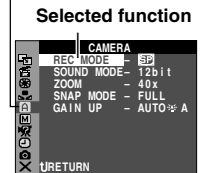

Sub Menu

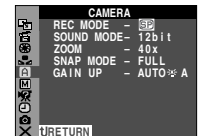
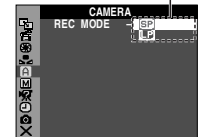

ADVANCED FEATURES

Recording Menus

CAMERA

The **[A]** settings are effective when the Power Switch is set to both **[A]** and **[M]**. However, the menu settings can be changed only when the Power Switch is set to **[M]**.

[] = Factory-preset

REC MODE

[SP]: To record in the SP (Standard Play) mode

LP: Long Play—more economical, providing 1.5 times the recording time.

NOTES:

- Audio Dubbing (⇨ pg. 37) and Insert Editing (⇨ pg. 37) are possible on tapes recorded in the SP mode.
- If the recording mode is switched, the recording picture will be blurred at the switching point.
- It is recommended that tapes recorded in the LP mode on this camcorder be played back on this camcorder.
- During playback of a tape recorded on another camcorder, blocks of noise may appear or there may be momentary pauses in the sound.

SOUND MODE

[12 bit]: Enables video recording of stereo sound on four separate channels, and is recommended for use when performing Audio Dubbing. (Equivalent to the 32 kHz mode of previous models)

16 bit: Enables video recording of stereo sound on two separate channels. (Equivalent to the 48 kHz mode of previous models)

ZOOM

16X: When set to “16X” while using digital zoom, the zoom magnification will reset to “16X” since digital zoom will be disengaged.

[40X]*: Allows you to use the Digital Zoom. By digitally processing and magnifying images, zooming is possible from 16X (the optical zoom limit), to a maximum of 40X digital magnification.

700X*: Allows you to use the Digital Zoom. By digitally processing and magnifying images, zooming is possible from 16X (the optical zoom limit), to a maximum of 700X digital magnification.

* Available only when the **VIDEO/MEMORY** Switch is set to “VIDEO”.

SNAP MODE

[FULL]: Snapshot mode with no frame

PIN-UP: Pin-Up mode

FRAME: Snapshot mode with frame



[FULL]



PIN-UP





FRAME

For details on the procedure, refer to “Snapshot (For Video Recording)” (⇨ pg. 31).

GAIN UP

OFF: Allows you to shoot dark scenes with no picture brightness adjustment.

[AGC]: The overall appearance may be grainy, but the image is bright.

AUTO A: The shutter speed is automatically adjusted. Shooting a subject in low or poor lighting at slow shutter speed provides a brighter image than in the AGC mode, but the subject's movements are not smooth or natural. The overall appearance may be grainy. While the shutter speed is being automatically adjusted, “A” is displayed.

MANUAL

The **[M]** settings are effective only when the Power Switch is set to **[M]**.

[] = Factory-preset

DIS

OFF: Disables the function.

[ON ]: To compensate for unstable images caused by camera-shake, particularly at high magnification.

NOTES:

- Accurate stabilization may not be possible if hand shake is excessive, or under the following conditions:
 - When shooting subjects with vertical or horizontal stripes.
 - When shooting dark or dim subjects.
 - When shooting subjects with excessive backlighting.
 - When shooting scenes with movement in various directions.
 - When shooting scenes with low-contrast backgrounds.
- Switch off this mode when recording with the camcorder on a tripod.
- The “” indicator blinks or goes out if the Stabilizer cannot be used.

TELE MACRO

[OFF]: Disables the function.



ON: Usually the distance to a subject where the lens is in focus depends on the zoom magnification. Unless there is a distance more than 1 m (3.3 ft) to the subject, the lens is out of focus at the maximum telephoto setting. When set to “ON”, you can shoot a subject as large as possible at a distance of approx. 60 cm (2 ft).



NOTE:

Depending on the zoom position, the lens may go out of focus.

WIDE MODE

[OFF]: Records with no change in the screen ratio. For playback on a TV with a normal screen ratio.

CINEMA* : Inserts black bands at the top and bottom of the screen. The  indicator appears. During playback on wide-screen TVs, the black bands at the top and bottom of the screen are cut and the screen ratio becomes 16:9. When using this mode, refer to your wide-screen TV's instruction manual. During playback/recording on 4:3 TVs/LCD monitor/viewfinder, black bands are inserted at the top and bottom of the screen and the image appears like a letter boxed 16:9 movie.



SQUEEZE* : For playback on TVs with an aspect ratio of 16:9. Naturally expands the image to fit the screen without distortion. The  indicator appears. When using All Manuals Search And Download.

this mode, refer to your wide-screen TV's instruction manual. During playback/recording on 4:3 TVs/LCD monitor/viewfinder, the image is elongated vertically.



* Available only when the **VIDEO/MEMORY** Switch is set to "VIDEO".

WIND CUT

[OFF]: Disengages the function.

ON : Helps cut down on noise created by wind. The "  " indicator appears. The quality of the sound will change. This is normal.

SYSTEM

The  functions which are set when the Power Switch is set to  are also applied when the Power Switch is set to "PLAY".

[] = Factory-preset

BEEP

OFF: Turns off sounds when performing any operations. It also deactivates the shutter sound effect, however the shutter sound is recorded onto the tape during Snapshot for Video Recording ( pg. 31).

BEEP: The beep sounds when the power is turned on or off, and at the beginning and end of recording. It also activates the shutter sound effect. ( pg. 18, 31)

[MELODY]: Instead of a beep, a melody sounds when any operation is performed. It also activates the shutter sound effect. ( pg. 18, 31)

REMOTE

OFF: Disables the remote control operations.

[ON]: Enables the remote control operations.

DEMO MODE

OFF: Automatic demonstration will not take place.

[ON]: Demonstrates certain functions such as Program AE with special effects, etc., and can be used to confirm how these functions operate. Demonstration starts in the following cases:

- When the Menu Screen is closed after "DEMO MODE" is turned "ON".
- With "DEMO MODE" set to "ON", if there is no operation for about 3 minutes after the Power Switch is set to "A" or . Performing any operation during the demonstration stops the demonstration temporarily. If no operation is performed for more than 3 minutes after that, the demonstration will resume.

NOTES:

- If a cassette is in the camcorder, the demonstration cannot be turned on.
- "DEMO MODE" remains "ON" even if the camcorder power is turned off.
- If "DEMO MODE" remains "ON", some functions will not be available. After viewing demo, set to "OFF".

PRIORITY

[LCD]: The image is displayed on the LCD monitor when the viewfinder is pulled out while the LCD monitor is opened.



FINDER: The image is displayed in the viewfinder when the viewfinder is pulled out while the LCD monitor is opened.

CAM RESET

EXECUTE: Resets all settings to the factory-preset.

RETURN: Does not reset all settings to the factory-preset.

CAMERA DISPLAY

- The  (CAMERA DISPLAY) settings are effective even when the Power Switch is set to "A". However, the menu settings can be changed only when the Power Switch is set to .

- The  (CAMERA DISPLAY) settings are effective only for shooting except "BRIGHT".

[] = Factory-preset

BRIGHT

 pg. 9, "Brightness Adjustment Of The Display"

ON SCREEN

LCD: Keeps the camcorder's display (except the date, time and time code) from appearing on the connected TV screen.

[LCD/TV]: Makes the camcorder's display appear on screen when the camcorder is connected to a TV.

DATE/TIME

OFF: The date/time does not appear.

[AUTO]: Displays the date/time for approx. 5 seconds when the Power Switch is set from "OFF" to "A" or .

ON: The date/time is always displayed.

- The date indication can also be turned on/off by pressing the **DISPLAY** Button on the remote control. ( pg. 17, 34)

TIME CODE

[OFF]: Time code is not displayed.

ON: Time code is displayed on the camcorder and on the connected TV. Frame numbers are not displayed during recording. ( pg. 13)

CLOCK ADJ.



 pg. 8, "Date/Time Settings"

DSC

[] = Factory-preset

QUALITY

[FINE] / STANDARD

The Picture Quality mode can be selected to best match your needs. Two Picture Quality modes are available: FINE () and STANDARD () (in order of quality).

NOTE:

The number of storable images depends on the selected picture quality as well as the composition of the subjects in the images and the type of memory card being used. ( pg. 18)

IMAGE SIZE**640 x 480 / [1024 x 768]**



The Image Size mode can be selected to best match your needs. (☞ pg. 18)

NOTE:

The settings can be changed only when the **VIDEO/MEMORY** Switch is set to "MEMORY".

REC SELECT

[]: When Snapshot recording is performed with the **VIDEO/MEMORY** Switch set to "VIDEO", still images are recorded only onto the tape.

☛  : When Snapshot recording is performed with the **VIDEO/MEMORY** Switch set to "VIDEO", still images are recorded not only onto the tape but also in the memory card (640 x 480 pixels). In this mode, the "SNAP MODE" selection in CAMERA Menu is also applicable to memory card recording.

Playback Menus **VIDEO**

[] = Factory-preset

SOUND MODE and NARRATION

During tape playback, the camcorder detects the sound mode in which the recording was made, and plays the sound back. Select the type of sound to accompany your playback picture. According to the menu access explanation on page 25, select "SOUND MODE" or "NARRATION" from the Menu Screen and set it to the desired parameter.

SOUND MODE

[STEREO ]: Sound is output on both "L" and "R" channels in stereo.

SOUND L : Sound from the "L" channel is output.

SOUND R : Sound from the "R" channel is output.

NARRATION

[OFF]: Original sound is output on both "L" and "R" channels in stereo.

ON: Dubbed sound is output on both "L" and "R" channels in stereo.

MIX: Original and dubbed sounds are combined and output in stereo on both "L" and "R" channels.

NOTES:

- You can also use **AUDIO** button on the provided remote control (☞ pg. 15) to change the output sound (without having to access the Playback Menu).
- The "SOUND MODE" setting is available for both 12-bit and 16-bit sound. (In previous models' functions, "12-bit" is called "32 kHz" and "16-bit" is called "48 kHz".)
- The camcorder cannot detect the sound mode in which the recording was made during fast-forward or rewind. During playback the sound mode is displayed in the upper left corner.

REC MODE [SP] / LP

Allows you to set the video recording mode (SP or LP) depending on your preference. It is recommended you use "REC MODE" in VIDEO Menu when using this camcorder as a recorder during dubbing. (☞ pg. 34, 35)

NOTE:

"REC MODE" can be set when the Power Switch is set to "PLAY" or "M".

  **COPY**

[OFF]: When the **SNAPSHOT** button is pressed during tape playback, the playback image pauses and normal playback will resume after approximately 6 seconds. (The still image is not recorded.)

ON: Enables dubbing of images recorded on a tape to a memory card. (☞ pg. 19)

S/AV INPUT

[OFF]: Disables audio/video signal input from the AV and S-Video connectors. (☞ pg. 34)

ON: Enables audio/video signal input from the AV and S-Video connectors. (☞ pg. 34)

 **SYSTEM**

Each setting is linked with , which appears when the Power Switch is set to "M". (☞ pg. 25)

- The parameters are the same as in the description on page 27.

[] = Factory-preset

BEEP OFF / BEEP / [MELODY]**REMOTE** OFF / [ON]**DEMO MODE** OFF / [ON]**PRIORITY** [LCD] / FINDER**CAM RESET** EXECUTE / RETURN **VIDEO DISPLAY**

The  (VIDEO DISPLAY) settings are effective only for video playback except "BRIGHT".

- The parameters (except "OFF" in ON SCREEN settings) are the same as in the description on page 27.

[] = Factory-preset

BRIGHT

☞ pg. 9, "Brightness Adjustment Of The Display"

ON SCREEN OFF / [LCD] / LCD/TV

When set to "OFF", the camcorder's display disappears.

DATE/TIME [OFF] / AUTO / ON

When set to "AUTO", the date/time are displayed in the following cases:

- When playback starts. The camcorder displays the date/time when scenes are recorded.
- When the date is changed during playback.

TIME CODE [OFF] / ON

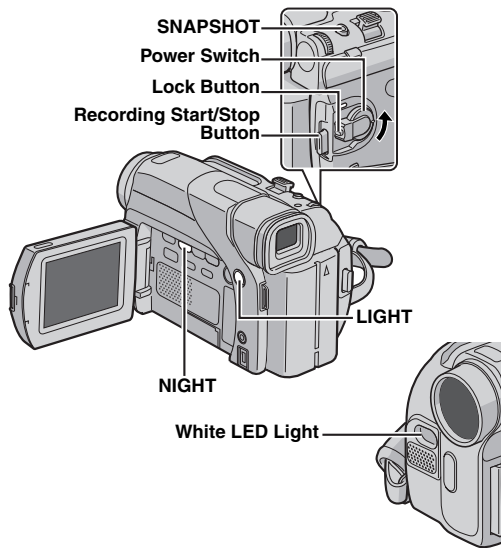

White LED Light

White LED Light can be used to brighten the subject in the dark place during video recording or D.S.C. shooting.

1 Press **LIGHT** repeatedly to change the setting.

OFF: Turns off the light.

ON: The light is on always. (☞ appears.)

AUTO: The light turns on automatically when dark.

(☞A appears.)

2 Press the Recording Start/Stop Button to start video recording or **SNAPSHOT** to shoot a still image.

NOTES:

- Be careful not to point the LED Light directly to eyes.
- If the light does not reach the subject, the Night-Alive function will be activated, and makes it possible to shoot the subject brighter.
- There is a difference in the brightness of the images shot between the centre area which is illuminated by the LED Light and the surrounding areas (which will be darker).
- Since subjects are shot at a reduced shutter speed when the White LED Light setting is "ON", they will appear slightly blurred.

Night Alive

Makes dark subjects or areas even brighter than they would be under good natural lighting. Although the recorded image is not grainy, it may look as if it is strobing due to the slow shutter speed.

1 Set the Power Switch to "M" while pressing down the Lock Button located on the switch.

2 Open the LCD monitor fully. (☞ pg. 12)

3 Press **NIGHT** so that the Night-Alive indicator "☞" appears.

- The shutter speed is automatically adjusted to provide up to 30 times sensitivity.
- "A" appears beside "☞" while the shutter speed is being automatically adjusted.

To deactivate Night-Alive

Press **NIGHT** again so that the Night-Alive indicator disappears.

NOTES:

- During Night-Alive, the following functions or settings cannot be activated and its indicator blinks or goes out:
 - Some modes of "Program AE With Special Effects" (☞ pg. 30).
 - "GAIN UP" in CAMERA Menu. (☞ pg. 26)
 - "DIS" in MANUAL Menu. (☞ pg. 26)
- During Night-Alive, it may be difficult to bring the camcorder into focus. To prevent this, use of a tripod is recommended.

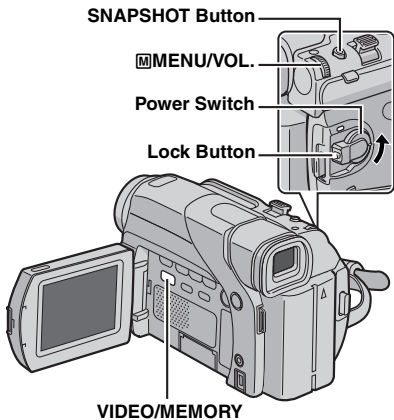

Wipe Or Fader Effects

IMPORTANT:

Some Wipe/Fader Effects cannot be used with certain modes of Program AE with special effects. (See the right column) If an unusable Wipe/Fader Effect is selected, its indicator blinks in blue or goes out.

These effects let you make pro-style scene transitions. Use them to spice up the transition from one scene to the next.

Wipe or Fader works when video recording is started or stopped.

1 Set the **VIDEO/MEMORY** Switch to "VIDEO".

2 Set the Power Switch to "M" while pressing down the Lock Button located on the switch.

3 Open the LCD monitor fully. (⌘ pg. 12)

4 Set "W" to the desired mode. (⌘ pg. 25)

- The WIPE/FADER menu disappears and the effect is reserved.

- The selected effect indicator appears.

5 Press the Recording Start/Stop Button to activate the Fade-in/out or Wipe-in/out.

To deactivate the selected effect

Select "OFF" in step **4**. The effect indicator disappears.

NOTE:

You can extend the length of a Wipe or Fader by pressing and holding the Recording Start/Stop Button.

WIPE/FADER

OFF: Disables the function. (Factory-preset)

W **FADER-WHITE:** Fade in or out with a white screen.

BK **FADER-BLACK:** Fade in or out with a black screen.

BW **FADER-B.W:** Fade in to a color screen from a black and white screen, or fade out from color to black and white.

W **WIPE-CORNER:** Wipe in on a black screen from the upper right to the lower left corner, or wipe out from lower left to upper right, leaving a black screen.

W **WIPE-WINDOW:** The scene starts in the center of a black screen and wipes in toward the corners, or comes in from the corners, gradually wiping out to the center.

L **WIPE-SLIDE:** Wipe in from right to left, or wipe out from left to right.

DL **WIPE-DOOR:** Wipe in as the two halves of a black screen open to the left and right, revealing the scene, or wipe out and the black screen reappears from left and right to cover the scene.

U **WIPE-SCROLL:** The scene wipes in from the bottom to the top of a black screen, or wipes out from top to bottom, leaving a black screen.

UD **WIPE-SHUTTER:** Wipe in from the center of a black screen toward the top and bottom, or wipe out from the top and bottom toward the center leaving a black screen.

Program AE With Special Effects

IMPORTANT:

Some modes of Program AE with special effects cannot be used with certain Wipe/Fader effects. (See the left column) If an unusable mode is selected, the indicator of Program AE with Special Effects blinks or goes out.

1 Set the Power Switch to "M" while pressing down the Lock Button located on the switch.

2 Open the LCD monitor fully. (⌘ pg. 12)

3 Set "W" to the desired mode. (⌘ pg. 25)

- The PROGRAM AE menu disappears and the selected effect is activated.

- The selected effect indicator appears.

To deactivate the selected effect

Select "OFF" in step **3**. The effect indicator disappears.

NOTES:

- Program AE with special effects can be changed during recording or during Record-Standby.

- Some modes of Program AE with special effects cannot be used during Night-Alive.

PROGRAM AE

OFF: Disables the function. (Factory-preset)

1/60 SHUTTER 1/60: The shutter speed is fixed at 1/60th of a second. Black bands that usually appear when shooting a TV screen become narrower.

1/100 SHUTTER 1/100: The shutter speed is fixed at 1/100th of a second. The flickering that occurs when shooting under a fluorescent light or mercury-vapor lamp is reduced.

SPORTS

(Variable Shutter Speed: 1/250 – 1/4000)

This setting allows fast-moving images to be captured one frame at a time, for vivid, stable slow-motion playback. The faster the shutter speed, the darker the picture becomes. Use the shutter function under good lighting conditions.

SNOW: Compensates for subjects that may otherwise appear too dark when shooting in extremely bright surroundings such as in the snow.

SPOTLIGHT: Compensates for subjects that may otherwise appear too bright when shooting under extremely strong direct lighting such as spotlights.

NOTE:

“SPOTLIGHT” has the same effect as -3 with the exposure control. (☞ pg. 32)

TWILIGHT: Makes evening scenes look more natural. White Balance (☞ pg. 33) is automatically set to “☉”, but can be changed to your desired setting. When Twilight is chosen, the camcorder automatically adjusts the focus from approx. 10 m (32 ft) to infinity. From less than 10 m, adjust the focus manually.



SEPIA: Recorded scenes have a brownish tint like old photos. Combine this with the Cinema mode for a classic look.

B/W MONOTONE: Like classic black and white films, your footage is shot in B/W. Used together with the Cinema mode, it enhances the “classic film” effect.

CLASSIC FILM*: Gives recorded scenes a strobe effect.



STROBE*: Your recording looks like a series of consecutive snapshots.

* Available only when the **VIDEO/MEMORY** Switch is set to “VIDEO”.

- When “WIDE MODE” is set to “SQUEEZE ” (☞ pg. 26), the “PHOTO” indication blinks in blue and Snapshot recording becomes impossible.
- If Program AE with special effects (☞ pg. 30) is engaged, certain modes of Program AE with special effects are disabled during Snapshot recording. In such a case, the icon blinks.
- If **SNAPSHOT** is pressed when “DIS” is set to “ON” (☞ pg. 26), the Stabilizer will be disabled.
- During playback as well, all snapshot modes are available when “  COPY” is set to “OFF” in VIDEO Menu. (☞ pg. 28) However, the shutter sound is not heard.
- During Snapshot recording, the image displayed in the viewfinder may be partially missing. However, there is no effect in the recorded image.
- When a cable is connected to the AV connector, the shutter sound is not heard from the speaker, however it is recorded onto the tape.

Motor Drive Mode

Keeping **SNAPSHOT** pressed in step 5 provides an effect similar to serial photography. (Interval between still images: approx. 1 second)

- The Motor Drive mode is disabled when “REC SELECT” is set to “ ”. (☞ pg. 28)

Auto Focus

The camcorder’s Full Range AF system offers continuous shooting ability from close-up (as close as approx. 5 cm (2”) to the subject) to infinity.

However, correct focus may not be obtainable in the situations listed below (in these cases perform “Manual Focus”):

- When two subjects overlap in the same scene.
 - When illumination is low.*
 - When the subject has no contrast (difference in brightness and darkness), such as a flat, one-color wall, or a clear, blue sky.*
 - When a dark object is barely visible in the LCD monitor or the viewfinder.*
 - When the scene contains minute patterns or identical patterns that are regularly repeated.
 - When the scene is affected by sunbeams or light reflecting off the surface of a body of water.
 - When shooting a scene with a high-contrast background.
- * The following low-contrast warnings appear blinking: ▲, ◀, ▶ and ▶

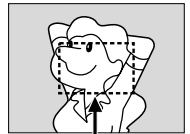

Focus detection zone



NOTES:

- If the lens is smeared or blurred, accurate focusing is not possible. Keep the lens clean. (☞ pg. 48) When condensation occurs, wipe with a soft cloth or wait for it to dry naturally.
- When shooting a subject close to the lens, zoom out first. (☞ pg. 12) If zoomed-in in the auto focus mode, the camcorder may automatically zoom out depending on the distance between the camcorder and the subject. This will not occur when “TELE MACRO” is set to “ON”. (☞ pg. 26)

Snapshot (For Video Recording)

This feature lets you record still images that look like photographs onto a tape.

- 1 Set the **VIDEO/MEMORY** Switch to “VIDEO”.
- 2 Set the Power Switch to “” while pressing down the Lock Button located on the switch.
- 3 Open the LCD monitor fully. (☞ pg. 12)
- 4 Set “SNAP MODE” to the desired mode. (☞ pg. 25, 26)
- 5 Press **SNAPSHOT**.

- There is the sound effect of a shutter closing.
- The “PHOTO” indication appears and a still image will be recorded for approx. 6 seconds, then the camcorder re-enters the Record-Standby mode.
- You can perform Snapshot also during recording. A still image will be recorded for approx. 6 seconds, then the normal recording resumes.
- Regardless of the Power Switch position (“” or “”), Snapshot recording takes place using the selected Snapshot mode.

NOTES:

- To remove the shutter sound, refer to “BEEP” on page 27.

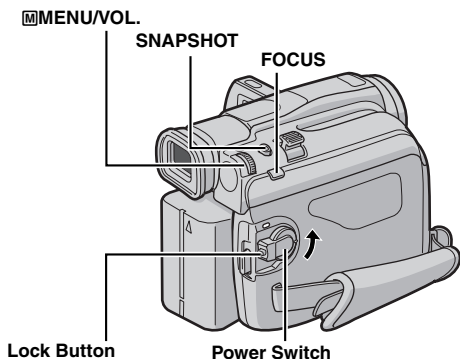

Manual Focus

NOTE:

If you are using the viewfinder, you should already have performed "Viewfinder Adjustment" (⇨ pg. 9).

1 Set the Power Switch to "M" while pressing down the Lock Button located on the switch.

2 Press **FOCUS**. The manual focus indicator appears.

3 To focus on a further subject, rotate the MENU/VOL. Wheel towards "+". The "▶" indicator appears and blinks.

To focus on a nearer subject, rotate the MENU/VOL. Wheel towards "-". The "◀" indicator appears and blinks.

To reset to Auto Focus

Press **FOCUS** twice or set the Power Switch to "A".

If **FOCUS** is pressed once, the camcorder will enter the focus adjustment mode again.

NOTES:

- Be sure to focus the lens in the maximum telephoto position when you use the Manual Focus mode. If you focus in on a subject in the wide-angle position, sharply focused images cannot be obtained when zoomed up because the depth-of-field is reduced at longer focal lengths.
- When the focus level cannot be adjusted any further or closer, "▲" or "●" will blink.

Exposure Control

Manual exposure control is recommended in the following situations:

- When shooting using reverse lighting or when the background is too bright.
- When shooting on a reflective natural background such as at the beach or when skiing.
- When the background is overly dark or the subject is bright.

1 Set the Power Switch to "M" while pressing down the Lock Button located on the switch.

2 Open the LCD monitor fully. (⇨ pg. 12)

3 Press the MENU/VOL. Wheel in. The Menu Screen appears.

4 Rotate the MENU/VOL. Wheel to select "E" (EXPOSURE), and press it.

5 Rotate the MENU/VOL. Wheel to select "MANUAL", and press it.

- The exposure control indicator appears.

6 To brighten the image, rotate the MENU/VOL. Wheel towards "+". To darken the image, rotate the MENU/VOL. Wheel towards "-". (maximum ±6)

- +3 exposure has the same effect as the backlight compensation. (⇨ pg. 33)
- -3 exposure has the same effect as when "E" is set to "SPOTLIGHT". (⇨ pg. 31)

7 Press the MENU/VOL. Wheel in. Exposure adjustment is complete.

To return to automatic exposure control

Select "AUTO" in step 5. Or, set the Power Switch to "A".

NOTES:

- You cannot use the manual exposure control at the same time when "E" is set to "SPOTLIGHT" or "SNOW" (⇨ pg. 30), or with the backlight compensation. (⇨ pg. 33)
- If the adjustment does not cause any visible change in brightness, set "GAIN UP" to "AUTO". (⇨ pg. 25, 26)

Iris Lock

Like the pupil of the human eye, the iris contracts in well-lit environments to keep too much light from entering, and dilates in dim environments to allow in more light.

Use this function in the following situations:

- When shooting a moving subject.
- When the distance to the subject changes (so its size in the LCD monitor or the viewfinder changes), such as when the subject is backing away.
- When shooting on a reflective natural background such as at the beach or when skiing.
- When shooting objects under a spotlight.
- When zooming.

When the subject is close, keep the iris locked. Even when the subject moves away from you, the image will not darken or brighten.

Before doing the following, perform steps 1 – 5 in "Exposure Control" (⇨ pg. 32).

6 Adjust zoom so that the subject fills the LCD monitor or the viewfinder, then press and hold the MENU/VOL. Wheel for over 2 seconds. The exposure control indicator and the "I" indication appear.

7 Press the MENU/VOL. Wheel in. The "I" indication changes to "L" and the iris is locked.

To return to automatic iris control

Rotate the MENU/VOL. Wheel to select "AUTO", then press it in step 5. Or, set the Power Switch to "A".

All menus disappear and the "L" disappears.

While focusing on a further subject



Manual focus indicator

While focusing on a nearer subject



Manual focus indicator





Iris Lock Indicator

To lock the exposure control and the iris

After step 5 of "Exposure Control", adjust the exposure by rotating the **MENU/VOL.** Wheel. Then lock the iris in steps 6 and 7 of "Iris Lock". For automatic locking, rotate the **MENU/VOL.** Wheel to select "AUTO", then press it in step 5. The exposure control and the iris become automatic.

Backlight Compensation

Backlight compensation brightens the subject quickly. Press **BACKLIGHT**. The  indicator is displayed and the subject is brightened. If pressed again,  disappears and the brightness returns to the previous level.

Using the BACKLIGHT

- Button may cause the light around the subject to become too bright and the subject to become white.
- Backlight compensations is also available when the Power Switch is set to "A".

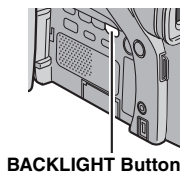

BACKLIGHT Button

White Balance Adjustment

The white balance that refers to the correctness of color reproduction under various lighting. If the white balance is correct, all other colors will be accurately reproduced. The white balance is usually adjusted automatically. However, more advanced camcorder operators control this function manually to achieve a more professional color/tint reproduction.

To change the setting

Set  to the desired mode. (⇨ pg. 25)

- The selected mode indicator except "AUTO" appears.

[**AUTO**]: White balance is adjusted automatically.

 **MWB**: Adjust the white balance manually when shooting under various types of lighting. (⇨ "Manual White Balance Adjustment")

 **FINE**: Outdoors on a sunny day.

 **CLOUD**: Outdoors on a cloudy day.

 **HALOGEN**: A video light or similar type of lighting is used.

[] = Factory-preset

To return to automatic white balance

Set  to "AUTO". (⇨ pg. 25)

Or, set the Power Switch to "A".

NOTE:

White balance cannot be used when  is set to "SEPIA" or "MONOTONE". (⇨ pg. 31)

Manual White Balance Adjustment

Adjust the white balance manually when shooting under various types of lighting.

1 Set the Power Switch to  while pressing down the Lock Button located on the switch.

2 Open the LCD monitor fully. (⇨ pg. 12)

3 Set  to "MWB". (⇨ pg. 25)

- The  indication blinks slowly.

4 Hold a sheet of plain white paper in front of the subject. Adjust zoom or position yourself so that the white paper fills the screen.

5 Press the **MENU/VOL.** Wheel in until  begins blinking rapidly.

- When the setting is completed,  resumes normal blinking.

6 Press the **MENU/VOL.** Wheel in twice. The Menu Screen closes and the Manual White Balance indicator  is displayed.

NOTES:

- In step 4, it may be difficult to focus on the white paper. In such a case, adjust focus manually. (⇨ pg. 32)
- A subject can be shot under various types of lighting conditions indoors (natural, fluorescent, candlelight, etc.). Because the color temperature is different depending on the light source, the subject tint will differ depending on the white balance settings. Use this function for a more natural result.
- Once you adjust white balance manually, the setting is retained even if the power is turned off or the battery removed.

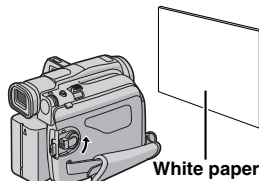

White paper

Dubbing To Or From A VCR

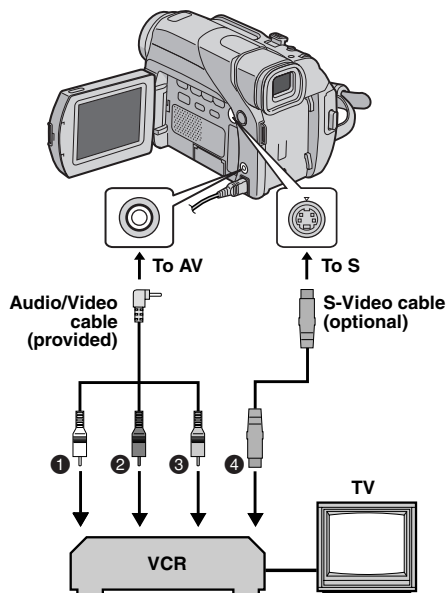

❶ White to AUDIO L IN or OUT

❷ Red to AUDIO R IN or OUT

❸ Yellow to VIDEO IN or OUT

❹ To S-VIDEO IN or OUT*

* Connect when your TV/VCR has an S-VIDEO IN/OUT connector. In this case, it is not necessary to connect the yellow video cable.

To use this camcorder as a player

1 Following the illustrations, connect the camcorder and the VCR. Also refer to page 17.

2 Set the camcorder's **VIDEO/MEMORY** Switch to "VIDEO".

3 Set the camcorder's Power Switch to "PLAY" while pressing down the Lock Button located on the switch.

4 Turn on the VCR's power.

5 Insert the source cassette in the camcorder.

6 Insert the recording cassette in the VCR.

7 Engage the VCR's AUX and Record-Pause modes.

• Refer to the instruction manual for the VCR.

8 Press **▶/||** on the camcorder to start playback of the source tape.

9 At the point you want to start dubbing, engage the VCR's Record mode.

10 To pause dubbing, engage the VCR's Record-Pause mode and press **▶/||** on the camcorder.

11 Repeat steps **8 – 10** for additional editing. Stop the VCR and camcorder.

NOTES:

• It is recommended to use the AC Adapter as the power supply instead of the battery pack. (☞ pg. 7)

• As the camcorder starts to play your footage, it will appear on your TV. This will confirm the connections and the AUX channel for dubbing purposes.

• Before you start dubbing, make sure that the indications do not appear on the connected TV. If they do, they are being recorded onto the new tape.

To choose whether or not the following displays appear on the connected TV

• Date/time

Set "DATE/TIME" to "AUTO", "ON" or "OFF".

(☞ pg. 25, 28) Or, press **DISPLAY** on the remote control to turn on/off the date indication.

• Time code

Set "TIME CODE" to "OFF" or "ON". (☞ pg. 25, 28)

• Indications other than date/time and time code

Set "ON SCREEN" to "OFF", "LCD" or "LCD/TV".

(☞ pg. 25, 28)

To use this camcorder as a recorder

1 Perform steps **1 to 3** in "To use this camcorder as a player".

2 Set "S/AV INPUT" to "ON". (☞ pg. 25, 28)

3 Set "REC MODE" to "SP" or "LP". (☞ pg. 25, 26)

4 Insert the recording cassette in this camcorder.

5 Press the Recording Start/Stop Button to engage the Record-Pause mode. The "A/V.IN" indication appears on the screen.

6 Press the Recording Start/Stop Button to start recording. The **⏻** indication rotates.

7 Press the Recording Start/Stop Button again to stop recording. The **⏻** indication stops rotating.

NOTES:

• After dubbing, set "S/AV INPUT" back to "OFF".

• Analog signals can be converted to digital signals with this procedure.

• It is also possible to dub from another camcorder.

Dubbing To Or From A Video Unit Equipped With A DV Connector (Digital Dubbing)

It is also possible to copy recorded scenes from the camcorder onto another video unit equipped with a DV connector. Since a digital signal is sent, there is little if any image or sound deterioration.

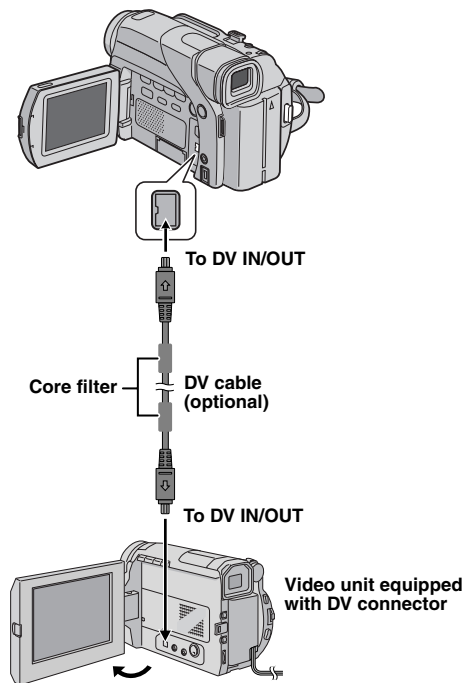



To use this camcorder as a player

- 1** Make sure all units are turned off.
- 2** Connect this camcorder to a video unit equipped with a DV input connector using a DV cable as shown in the illustration.
- 3** Set this camcorder's **VIDEO/MEMORY** Switch to "VIDEO".
- 4** Set this camcorder's Power Switch to "PLAY" while pressing down the Lock Button located on the switch.
- 5** Turn on the video unit's power.
- 6** Insert the source cassette in this camcorder.
- 7** Insert the recording cassette in the video unit.
- 8** Press **▶/II** on this camcorder to start playback of the source cassette.
- 9** At the point you want to start dubbing, engage the video unit's Record mode.
- 10** To pause dubbing, engage the video unit's Record-Pause mode and press **▶/II** on this camcorder.
- 11** Repeat steps **8 – 10** for additional editing. Stop the video unit and camcorder.

NOTES:

- It is recommended to use the **AC Adapter** as the power supply instead of the battery pack. (☞ pg. 7)
- If the remote control is used when both the player and recorder are JVC video units, both units will perform the same operation. To prevent this from happening, press the buttons on both units.
- If a blank portion or disturbed image is played back on the player during dubbing, the dubbing may stop so that an unusual image is not dubbed.
- Even though the DV cable is connected correctly, sometimes the image may not appear in step **9**. If this occurs, turn off the power and make connections again.
- If "Playback Zoom" (☞ pg. 16) or "Playback Special Effects" (☞ pg. 16) is attempted or **SNAPSHOT** is pressed during playback, only the original playback image recorded on the tape is output from the DV IN/OUT connector.
- When using a DV cable, be sure to use the optional **JVC VC-VDV204U DV cable**.

To use this camcorder as a recorder

- 1)** Perform steps **1** to **4** in "To use this camcorder as a player".
- 2)** Set "REC MODE" to "SP" or "LP". (☞ pg. 25, 26)
- 3)** Insert the recording cassette in this camcorder.
- 4)** Press the Recording Start/Stop Button to engage the Record-Pause mode.
 - The "**DV.IN**" indication appears on the screen.
- 5)** Press the Recording Start/Stop Button to start recording. The  indication rotates.
- 6)** Press the Recording Start/Stop Button again to stop recording. The  indication stops rotating.

NOTES:

- If no image is displayed on the LCD monitor, set "S/AV INPUT" to "OFF". (☞ pg. 25, 28)
- Digital Dubbing is performed in the sound mode recorded on the original tape, regardless of the current "SOUND MODE" setting. (☞ pg. 26)

Connection To A Personal Computer

[A] Using USB cable

OR

[B] Using DV cable

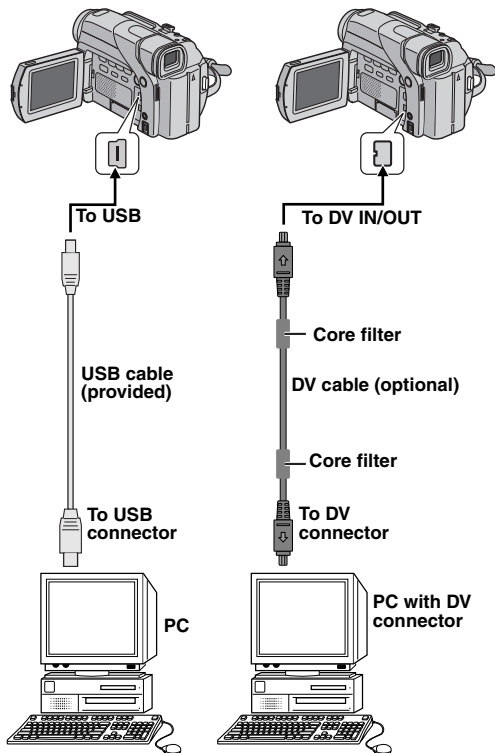

[A] Using USB cable

It is possible to do the following things:

- Transfer still images stored on a memory card to a PC.
- Transfer still/moving images recorded on a tape to a PC.
- Capture still/moving images in real-time.
- Use this camcorder as a WebCam.

[B] Using DV cable

It is also possible to transfer still/moving images to a PC with a DV connector by using the provided software, software equipped with the PC or commercially available software.

NOTES:

- Refer to "SOFTWARE INSTALLATION AND USB CONNECTION GUIDE" for the installation of the bundled software and drivers.
- The software operation manual is provided as PDF file on the CD-ROM.
- **It is recommended to use the AC Adapter as the power supply instead of the battery pack.** (ⓘ pg. 7)
- **Never connect the USB cable and the DV cable simultaneously to the camcorder. Connect only the cable you wish to use to the camcorder.**
- **When using a DV cable, be sure to use the optional JVC VC-VDV206U or VC-VDV204U DV cable depending on the type of DV connector (4 or 6 pins) on the PC.**
- If the PC connected to the camcorder via the USB cable is not powered, the camcorder does not enter the USB mode.
- The date/time information cannot be captured into the PC.
- Refer to the instruction manuals of the PC and Software.
- The still images can also be transferred to a PC with a DV connector-equipped capture board.
- The system may not work properly depending on the PC or capture board you are using.

"USB MODE" and/or "ACCESSING FILES" appears on the LCD monitor while the PC is accessing data in the camcorder or the camcorder is transferring a file to the PC.

NEVER disconnect the USB cable while "ACCESSING FILES" is displayed on the LCD monitor since this can result in product damage.

Audio Dubbing

The audio track can be customized only when recorded in the 12-bit and SP modes. (☞ pg. 26)

- Use the provided remote control.

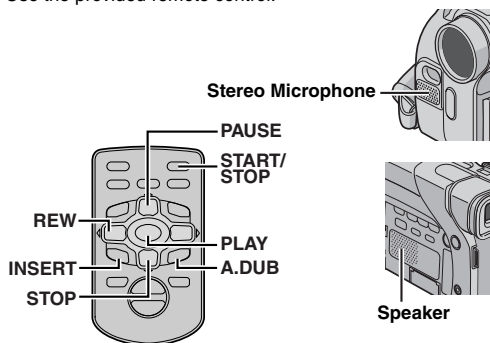

1 Play back the tape to locate the point where editing will start, then press **PAUSE (II)**.

2 While holding **A. DUB (⊖)** on the remote control, press **PAUSE (II)**. The “**II**” and “**MIC**” indicators appear.

3 Press **PLAY (▶)**, then begin “narrating”. Speak into the microphone.

- To pause dubbing, press **PAUSE (II)**.

4 To end Audio Dubbing, press **PAUSE (II)**, then **STOP (■)**.

To hear the dubbed sound during playback

Set “**NARRATION**” to “**ON**” or “**MIX**”. (☞ pg. 25, 28)

NOTES:

- Sound is not heard from the speaker during Audio Dubbing.
- When editing onto a tape that was recorded at 12-bit, the old and new soundtracks are recorded separately.
- If you dub onto a blank space on the tape, the sound may be disrupted. Make sure you only edit recorded areas.
- If feedback or howling occurs during TV playback, move the camcorder’s microphone away from the TV, or turn down the TV’s volume.
- If you change from 12-bit to 16-bit in mid-recording and then use the tape for Audio Dubbing, it is not effective from the point where 16-bit recording began.
- During Audio Dubbing, when the tape moves to scenes recorded in the LP mode, scenes recorded in 16-bit audio or a blank portion, Audio Dubbing stops.
- To perform Audio Dubbing while watching on the television, make connections. (☞ pg. 17)
- To perform Audio Dubbing with a video unit connected to the camcorder’s AV connector, first set “**S/AV INPUT**” to “**ON**” in **VIDEO Menu**. (☞ pg. 25, 28)
The “**AUX**” indication appears instead of “**MIC**”.

Insert Editing

You can record a new scene into a previously recorded tape, replacing a section of the original recording with minimal picture distortion at the in and outpoints. The original audio remains unchanged.

- Use the provided remote control.

NOTES:

- Before performing the following steps, make sure that “**TIME CODE**” is set to “**ON**”. (☞ pg. 25, 28)
- Insert Editing is not possible on a tape recorded in the LP mode or on a blank portion of a tape.
- To perform Insert Editing while watching in the television, make connections. (☞ pg. 17)

1 Play back the tape, locate the Edit-Out point and press **PAUSE (II)**. Confirm the time code at this point. (☞ pg. 13)

2 Press **REW (◀)** until the Edit-In point is located, then press **PAUSE (II)**.

3 Press and hold **INSERT (Ⓞ)** on the remote control, then press **PAUSE (II)**. The “**II**” indicator and the Time Code (min.:sec.) appear and the camcorder enters Insert-Pause mode.

4 Press **START/STOP** to begin editing.

- Confirm the insert at the time code you checked in step **1**.
- To pause editing, press **START/STOP**. Press it again to resume editing.

5 To end Insert Editing, press **START/STOP**, then **STOP (■)**.

NOTES:

- Program AE with special effects (☞ pg. 30) can be used to spice up the scenes being edited during Insert Editing.
- During Insert Editing, the date and time information changes.
- If you perform Insert Editing onto a blank space on the tape, the audio and video may be disrupted. Make sure you only edit recorded areas.
- During Insert Editing, when the tape moves to scenes recorded in the LP mode or a blank portion, Insert Editing stops. (☞ pg. 43)

Power (pg. 6)

- Perform charging where the temperature is between 10°C and 35°C (50°F and 95°F). 20°C to 25°C (68°F to 77°F) is the ideal temperature range for charging. If the environment is too cold, charging may be incomplete.
- Charging time is based on room temperature of 20°C (68°F).
- Charging times are for a fully discharged battery pack.
- Charging time varies according to the ambient temperature and the status of the battery pack.
- To avoid interference with reception, do not use the AC Adapter near a radio.
- Since the AC Adapter processes electricity internally, it becomes warm during use. Be sure to use it only in well-ventilated areas.
- The following operation stops charging:
 - Set the Power Switch to "PLAY", "A" or "M".
 - Disconnect the AC Adapter from the camcorder.
 - Unplug the AC Adapter from the AC outlet.
 - Detach the battery from the camcorder.
- Using the optional AA-V40U AC Power Adapter/Charger, you can charge the BN-V408U/V416U/V428U battery pack without the camcorder. However, it cannot be used as an AC Adapter.

Loading/Unloading A Cassette (pg. 10)

- It takes a few seconds for the cassette holder to open. Do not apply force.
- If you wait a few seconds and the cassette holder does not open, close the cassette holder cover and try again. If the cassette holder still does not open, turn the camcorder off then on again.
- If the tape does not load properly, open the cassette holder cover fully and remove the cassette. A few minutes later, insert it again.
- When the camcorder is suddenly moved from a cold place to a warm environment, wait a short time before opening the cassette holder cover.
- Closing the cassette holder cover before the cassette holder recedes may cause damage to the camcorder.
- Even when the camcorder is switched off, a cassette can be loaded or unloaded. After the cassette holder is closed with the camcorder switched off, however, it may not recede. It is recommended to turn the power on before loading or unloading.
- When resuming recording, once you open the cassette holder cover a blank portion will be recorded on the tape or a previously recorded scene will be erased (recorded over) regardless of whether the cassette holder came out or not. See "Recording From The Middle Of A Tape" (ⓘ pg. 13).

VIDEO RECORDING (pg. 11)

- When you use the LCD monitor outdoors in direct sunlight, the LCD monitor may be difficult to see. If this happens, use the viewfinder instead.
- The cassette holder cannot be opened unless a power supply is attached.
- There may be a delay after you open the cassette holder cover until the cassette holder opens. Do not use force.
- Once the cassette holder is closed, it recedes automatically. Wait until it recedes completely before closing the cassette holder cover.
- When the Recording Start/Stop button is pressed, it may take a few seconds before actual recording starts. The "⏻" indicator starts rotating when the camcorder actually starts recording.
- The time required to calculate and display the remaining tape length, and the accuracy of the calculation, may vary according to the type of tape used.
- "TAPE END" appears when the tape reaches its end, and the power goes off automatically if left in this condition for 5 minutes. "TAPE END" also appears when a cassette at its end is loaded.

VIDEO PLAYBACK (pg. 14)

- Clean the video heads using an optional dry cleaning cassette when:
 - No picture during playback.
 - Blocks of noise appear during playback.
 For details, see pg. 46.
- If Stop mode continues for 5 minutes when power is supplied from a battery, the camcorder shuts off automatically. To turn on again, set the Power Switch to "OFF", then to "PLAY".
- You can also view the playback picture on the LCD monitor with it flipped over and pushed against the camcorder body.
- LCD monitor/viewfinder indications:
 - When power is supplied from a battery: the "⏻" battery indicator is displayed. (see pg. 43)
 - When power is supplied from an AC outlet: the "⏻" battery indicator does not appear.
- When a cable is connected to the AV connector, the sound is not heard from the speaker.

D.S.C. RECORDING (pg. 18)

- Even if "DIS" is set to "ON" (see pg. 26), the Stabilizer will be disabled.
- If Program AE with special effects (see pg. 30) is engaged, certain modes of Program AE with special effects are disabled during Snapshot recording. In such a case, the icon blinks.
- If shooting is not performed for approx. 5 minutes when the Power Switch is set to "A" or "M" and power is supplied from the battery pack, the camcorder shuts off automatically to save power. To perform shooting again, push back and pull out the viewfinder again or close and re-open the LCD monitor.
- The Motor Drive mode (see pg. 31) is disabled when the VIDEO/MEMORY Switch is set to "MEMORY".
- When a cable is connected to the AV connector, the shutter sound is not heard from the speaker.
- Still images taken are compliant to DCF (Design rule for Camera File system). They do not have any compatibility with devices which are not compliant to DCF.

If the problem still exists after following the steps below, please consult your nearest JVC dealer.

The camcorder is a microcomputer-controlled device. External noise and interference (from a TV, a radio, etc.) might prevent it from functioning properly. In such cases, first disconnect its power supply unit (battery pack, AC Adapter, etc.) and wait a few minutes; and then re-connect it and proceed as usual from the beginning.

Power

No power is supplied.

- The power is not connected properly.
- Connect the AC Adapter securely. (☞ pg. 7)
- The battery is dead.
- Replace the dead battery with a fully charged one. (☞ pg. 6, 7)
- The LCD monitor is not open fully or the viewfinder is not pulled out when recording.
- Open the LCD monitor fully or pull out the viewfinder.

The POWER/CHARGE lamp blinks in the Record-Standby mode.

- If the Record-Standby mode continues for 5 minutes, the camcorder's power shuts off automatically. Then, the **POWER/CHARGE** lamp will blink to indicate for charging if the battery pack is attached to the camcorder and its power is supplied from the AC Adapter.
- Push back and pull out the viewfinder again or close and re-open the LCD monitor to return to the Record-Standby mode.

Video and D.S.C. Recording

Recording cannot be performed.

- The Power Switch is set to "PLAY" or "OFF".
- Set the Power Switch to "A" or "M". (☞ pg. 11, 18)
- For Video Recording —
- The tape's erase protection tab is set to "SAVE".
- Set the tape's erase protection tab to "REC". (☞ pg. 10)
- The **VIDEO/MEMORY** Switch is set to "MEMORY".
- Set the **VIDEO/MEMORY** Switch to "VIDEO".
- "TAPE END" appears.
- Replace with new cassette. (☞ pg. 10)
- The cassette holder cover is open.
- Close the cassette holder cover.
- For D.S.C. Recording —
- The **VIDEO/MEMORY** Switch is set to "VIDEO".
- Set the **VIDEO/MEMORY** Switch to "MEMORY".

When shooting a subject illuminated by bright light, vertical lines appear.

- This is a result of exceedingly high contrast, and is not a malfunction.

When the screen is under direct sunlight during shooting, the screen becomes red or black for an instant.

- This is not a malfunction.

During recording, the date/ time does not appear.

- "DATE/TIME" is set to "OFF".
- Set "DATE/TIME" to "ON". (☞ pg. 25, 27)

During recording, sound cannot be heard.

- This is normal.

The LCD monitor or viewfinder indications blink.

- Certain Wipe/Fader effects, certain modes of Program AE with special effects, "DIS" and other functions that cannot be used together are selected at the same time.
- Re-read the sections covering Wipe/Fader effects, Program AE with special effects and "DIS". (☞ pg. 25 – 31)

Digital Zoom does not work.

- 16X optical zoom is selected.
- Set "ZOOM" to "40X" or "700X". (☞ pg. 26)
- The **VIDEO/MEMORY** Switch is set to "MEMORY".
- Set the **VIDEO/MEMORY** Switch to "VIDEO".

Colored bright spots appear all over the LCD monitor.

- White spots or bright spots of light (red, green or blue) may appear on the LCD monitor. This may occur when the Night-Alive function is activated during recording and is not a malfunction.

Video and D.S.C. Playback

Play, Rewind and Fast-Forward functions do not work.

- The Power Switch is set to "A" or "M".
- Set the Power Switch to "PLAY". (☞ pg. 14)
- **VIDEO/MEMORY** Switch is set to "MEMORY".
- Set the **VIDEO/MEMORY** Switch to "VIDEO".

The tape is moving, but there is no picture.

- Your TV has AV input terminals, but is not set to its VIDEO mode.
- Set the TV to the mode or channel appropriate for video playback. (☞ pg. 17)
- The cassette holder cover is open.
- Close the cassette holder cover. (☞ pg. 10)

Blocks of noise appear during playback, or there is no playback picture and the screen becomes blue.

- Clean the video heads with an optional cleaning cassette. (☞ pg. 46)

A memory card cannot be played back.

- The Power Switch is set to "A" or "M".
- Set the Power Switch to "PLAY". (☞ pg. 20)
- The **VIDEO/MEMORY** Switch is set to "VIDEO".
- Set the **VIDEO/MEMORY** Switch to "MEMORY".

Advanced features

The focus does not adjust automatically.

- Focus is set to the Manual mode.
- Set Focus to the Auto mode. (⇨ pg. 31)
- The lens is dirty or covered with condensation.
- Clean the lens and check the focus again. (⇨ pg. 48)
- The recording was done in a dark place, or the contrast was low.

Snapshot mode cannot be used.

- The Squeeze mode (SQUEEZE) is selected.
- Disengage the Squeeze (SQUEEZE) mode. (⇨ pg. 25, 26)

The color of Snapshot looks strange.

- The light source or the subject does not include white. Or there are various different light sources behind the subject.
- Find a white subject and compose your shot so that it also appears in the frame. (⇨ pg. 18, 31)
- The Sepia (SEPIA) or Monotone (MONOTONE) mode is activated.
- Disengage the Sepia (SEPIA) and Monotone (MONOTONE). (⇨ pg. 25, 31)

The image taken using Snapshot is too dark.

- Shooting was performed under backlit conditions.
- Press **BACKLIGHT**. (⇨ pg. 33)

The image taken using Snapshot is too bright.

- The subject is too bright.
- Set "**SPOTLIGHT**" to "SPOTLIGHT". (⇨ pg. 31)

White Balance cannot be activated.

- The Sepia (SEPIA) or Monotone (MONOTONE) mode is activated.
- Disengage the Sepia (SEPIA) or Monotone (MONOTONE) mode before setting White Balance. (⇨ pg. 31)

Wipe/Fader effects do not work.

- The Power Switch is set to "**A**".
- Set the Power Switch to "**W**". (⇨ pg. 8)

The Black & White Fader does not work.

- The Sepia (SEPIA) or Monotone (MONOTONE) mode is activated.
- Disengage the Sepia (SEPIA) and Monotone (MONOTONE). (⇨ pg. 25, 31)

Program AE with special effects does not work.

- The Power Switch is set to "**A**".
- Set the Power Switch to "**W**". (⇨ pg. 8)

The image looks like the shutter speed is too slow.

- When shooting in the dark, the unit becomes highly sensitive to light when "GAIN UP" is set to "AUTO".
- If you want the lighting to look more natural, set "GAIN UP" to "AGC" or "OFF". (⇨ pg. 25, 26)

Other problems

The POWER/CHARGE lamp on the camcorder does not light.

- The temperature of the battery is extremely high/low.
- Charging is difficult in places subject to extremely high/low temperatures.
- To protect the battery, it is recommended to charge it in places with a temperature of 10°C to 35°C (50°F to 95°F). (⇨ pg. 45)

"SET DATE/TIME!" appears.

- The date/time is not set.
- Set the date/time. (⇨ pg. 8)
- The built-in clock battery has run out and the previously set date/time has been erased.
- Consult your nearest JVC dealer for replacement.

There is no picture.

- The camcorder is not getting power, or some other malfunction exists.
- Turn the camcorder's power off and on again. (⇨ pg. 8)

Some functions are not available using the MENU/VOL. Wheel.

- The Power Switch is set to "**A**".
- Set the Power Switch to "**W**". (⇨ pg. 8)

Files stored in the memory card cannot be deleted.

- Files stored in the memory card are protected.
- Remove protection from the files stored in the memory card and delete them. (⇨ pg. 22)

When the image is printed from the printer, a black bar appears at the bottom of the screen.

- This is not a malfunction.
- By recording with "DIS" activated (⇨ pg. 25, 26) this can be avoided.

When the camcorder is connected via the DV connector, the camcorder does not operate.

- The DV cable was plugged/unplugged with power turned on.
- Turn the camcorder's power off and on again, then operate it.

The rear of the LCD monitor is hot.

- The light used to illuminate the LCD monitor causes it to become hot.
- Close the LCD monitor to turn it off or set the Power Switch to "OFF", and let the unit cool down.

Images on the LCD monitor appear dark or whitish.

- In places subject to low temperature, images become dark due to the characteristics of the LCD monitor. When this happens, the displayed colors differ from those that are actually recorded. This is not a defect of the camcorder.
- Adjust the brightness and angle of the LCD monitor. (☞ pg. 9, 12)
- When the LCD monitor's fluorescent light reaches the end of its service life, images on the LCD monitor become dark.
- Consult your nearest JVC dealer.

Colored bright spots appear all over the LCD monitor or the viewfinder.

- The LCD monitor and the viewfinder are made with high-precision technology. However, black spots or bright spots of light (red, green or blue) may appear constantly on the LCD monitor or the viewfinder during recording or playback. These spots are not recorded on the tape. This is not due to any defect of the unit. (Effective dots: more than 99.99 %)

The indicators and the image color on the LCD monitor are not clear.

- This may occur when the surface or the edge of the LCD monitor is pressed.

The cassette will not load properly.

- The battery's charge is low.
- Install a fully charged battery. (☞ pg. 6, 7)

The memory card cannot be removed from the camcorder.

- Push in the memory card a few more times. (☞ pg. 10)

Picture does not appear on the LCD monitor.

- The viewfinder is pulled out and "PRIORITY" is set to "FINDER".
- Push the viewfinder back in or set "PRIORITY" to "LCD". (☞ pg. 12, 25, 27)
- The LCD monitor's brightness setting is too dark.
- Adjust the brightness of the LCD monitor. (☞ pg. 9)
- If the monitor is tilted upward 180 degrees, open the monitor fully. (☞ pg. 12)

Images on the LCD monitor are jittery.

- The speaker volume is too great.
- Turn the speaker volume down. (☞ pg. 14)

The LCD monitor, the viewfinder and the lens have become dirty (ex. fingerprints).

- Wipe them gently with soft cloth. Wiping strongly can cause damage. (☞ pg. 48) To clean the viewfinder, please consult your nearest JVC dealer.

Time code does not appear.

- "TIME CODE" is set to "OFF".
- Set "TIME CODE" to "ON". (☞ pg. 25, 27, 28)

An error indication (E01, E02 or E06) appears.

- A malfunction of some kind has occurred. In this case the camcorder's functions become unusable.
- ☞ pg. 44.

An error indication (E03 or E04) appears.

- A malfunction of some kind has occurred. In this case the camcorder's functions become unusable.
- ☞ pg. 44.

The remote control does not work.

- "REMOTE" is set to "OFF".
- Set "REMOTE" to "ON". (☞ pg. 25, 27)
- The remote control does not point at the remote sensor.
- Point at the remote sensor. (☞ pg. 15)
- The remote control batteries are exhausted.
- Replace the batteries with fresh ones. (☞ pg. 15)

Warning Indications



Displays the battery remaining power.

Remaining power level

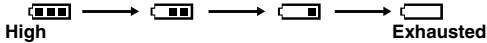

As the battery power comes close to nil, the battery indicator blinks.

When the battery power is exhausted, power turns off automatically.



Appears when no tape is loaded. (⇨ pg. 10)

CHECK TAPE'S ERASE PROTECTION TAB

Appears when the erase protection tab is set to "SAVE" while the Power Switch is set to "A" or "M" and the VIDEO/MEMORY Switch is set to "VIDEO". (⇨ pg. 8)

USE CLEANING CASSETTE

Appears if dirt is detected on the heads during recording. Use an optional cleaning cassette. (⇨ pg. 46)

CONDENSATION, OPERATION PAUSED

PLEASE WAIT

Appears if condensation occurs. (The two indications above swiches alternately every 3 seconds.) When this indication is displayed, wait more than 1 hour until condensation disappears.

TAPE!

Appears if a tape is not loaded when the Recording Start/ Stop Button or **SNAPSHOT** Button is pressed while the Power Switch is set to "A" or "M" and the VIDEO/MEMORY Switch is set to "VIDEO".

TAPE END

Appears when the tape ends during recording or playback. (⇨ pg. 38)

SET DATE/TIME!

- Appears when the date/time is not set. (⇨ pg. 8)
- Appears when the built-in clock (lithium) battery is discharged and the previously set date/time is erased. (⇨ pg. 8)

LENS CAP

Appears for 5 seconds after power is turned on if the lens cap is attached.

A. DUB ERROR!

Appears if Audio Dubbing is attempted on a blank portion of a tape. (⇨ pg. 37)

A. DUB ERROR!

<CANNOT DUB ON A LP RECORDED TAPE>
<CANNOT DUB ON A 16bit RECORDING>
<CHECK TAPE'S ERASE PROTECTION TAB>

- Appears if Audio Dubbing is attempted on a tape recorded in the LP mode. (⇨ pg. 37)
- Appears if Audio Dubbing is attempted on a tape recorded in 16-bit audio. (⇨ pg. 37)
- Appears if **A. DUB** (⊖) on the remote control is pressed when the erase protection tab is set to "SAVE". (⇨ pg. 37)

INSERT ERROR!

Appears if Insert Editing is attempted on a blank portion of a tape. (⇨ pg. 37)

INSERT ERROR!

<CANNOT EDIT ON A LP RECORDED TAPE>
<CHECK TAPE'S ERASE PROTECTION TAB>

- Appears if Insert Editing is attempted on a tape recorded in the LP mode. (⇨ pg. 37)
- Appears if **INSERT** (⊖) on the remote control is pressed when the erase protection tab is set to "SAVE". (⇨ pg. 37)

MEMORY IS FULL

Appears when the memory card's memory is full and shooting is not possible.

COPYING FAILED

- Appears if dubbing of copyguarded signals is attempted while this camcorder is being used as a recorder.
- Appears in the following cases when dubbing from a tape to a memory card (as digital stills):
 - when no memory card is loaded.
 - when the memory card's memory is full.
 - when the memory card is not formatted.
 - when a write-protected SD Memory Card is loaded. (⇨ pg. 19)

MEMORY CARD!

Appears if there is no memory card loaded when you attempt to record on a memory card or access data on a memory card.

PLEASE FORMAT

Appears when there is a problem with a memory card and its memory is corrupt, or it has not been initialized. Initialize the memory card. (⇨ pg. 24)

NO IMAGES STORED

Appears if there are no image files stored in the memory card when you attempt memory card playback.

CARD ERROR!

Appears when the camcorder does not recognize the loaded memory card. Remove the memory card once and insert it again. Repeat these procedures until no indication appears. If the indication still appears, the memory card is corrupted.

UNSUPPORTED FILE!

Appears when playing back a file that is not compatible with DCF or a file with a size that is not compatible with this camcorder.

CHECK CARD'S WRITE PROTECTION SWITCH

Appears when you attempt to shoot digital still images when the write protection tab on the SD Memory Card is set to the "LOCK" position.

E01, E02 or E06 UNIT IN SAFEGUARD MODE REMOVE AND REATTACH BATTERY

The error indications (E01, E02 or E06) show what type of malfunction has occurred. When an error indication appears, the camcorder turns off automatically. Remove the power supply (battery, etc.) and wait a few minutes for the indication to clear. When it does, you can resume using the camcorder. If the indication remains, consult your nearest JVC dealer.

E03 or E04 UNIT IN SAFEGUARD MODE EJECT AND REINSERT TAPE

The error indications (E03 or E04) show what type of malfunction has occurred. When an error indication appears, the camcorder turns off automatically. Eject the cassette once and re-insert it, then check if the indication clears. When it does, you can resume using the camcorder. If the indication remains, consult your nearest JVC dealer.

When using the AC Adapter in areas other than the USA

The provided AC Adapter features automatic voltage selection in the AC range from 110 V to 240 V.

USING HOUSEHOLD AC PLUG ADAPTER

In case of connecting the unit's power cord to an AC wall outlet other than American National Standard C73 series type use an AC plug adapter, called a "Siemens Plug", as shown.

For this AC plug adapter, consult your nearest JVC dealer.

Plug adapter

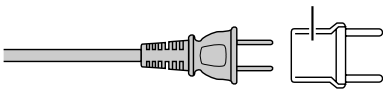

Battery Packs

The supplied battery pack is a lithium-ion battery. Before using the supplied battery pack or an optional battery pack, be sure to read the following cautions:

● To avoid hazards...

- ...do not burn.
- ...do not short-circuit the terminals. When transporting, make sure the provided battery cap is attached to the battery. If the battery cap is misplaced, carry the battery in a plastic bag.
- ...do not modify or disassemble.
- ...do not expose the battery to temperatures exceeding 60°C (140°F), as this may cause the battery to overheat, explode or catch fire.
- ...use only specified chargers.

Terminals

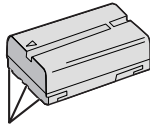

● To prevent damage and prolong service life...

- ...do not subject to unnecessary shock.
- ...charge in an environment where temperatures are within the tolerances shown in the chart below. This is a chemical reaction type battery — cooler temperatures impede chemical reaction, while warmer temperatures can prevent complete charging.
- ...store in a cool, dry place. Extended exposure to high temperatures will increase natural discharge and shorten service life.
- ...fully charge and then fully discharge the battery every 6 months when storing the battery pack over a long period time.
- ...remove from charger or powered unit when not in use, as some machines use current even when switched off.

NOTES:

- It is normal for the battery pack to be warm after charging, or after use.

Temperature Range Specifications

Charging: 10°C to 35°C (50°F to 95°F)

Operation: 0°C to 40°C (32°F to 104°F)

Storage: -20°C to 50°C (-4°F to 122°F)

- The lower the temperature, the longer recharging takes.

Cassettes

To properly use and store your cassettes, be sure to read the following cautions:

● During use...

- ...make sure the cassette bears the Mini DV mark.
- ...be aware that recording onto prerecorded tapes automatically erases the previously recorded video and audio signals.
- ...make sure the cassette is positioned properly when inserting.
- ...do not load and unload the cassette repeatedly without allowing the tape to run at all. This slackens the tape and can result in damage.
- ...do not open the front tape cover. This exposes the tape to fingerprints and dust.

● Store cassettes...

- ...away from heaters or other heat sources.
- ...out of direct sunlight.
- ...where they won't be subject to unnecessary shock or vibration.
- ...where they won't be exposed to strong magnetic fields (such as those generated by motors, transformers or magnets).
- ...vertically, in their original cases.

Memory Cards

To properly use and store your memory cards, be sure to read the following cautions:

● During use...

- ...make sure the memory card bears the SD or MultiMediaCard mark.
- ...make sure the memory card is positioned properly when inserting.

● While the memory card is being accessed (during recording, playback, deletion, initialization, etc.)...

- ...never unload the memory card and never turn off the camcorder.

● Store memory cards...

- ...away from heaters or other heat sources.
- ...out of direct sunlight.
- ...where they won't be subject to unnecessary shock or vibration.
- ...where they won't be exposed to strong magnetic fields (such as those generated by motors, transformers or magnets).

LCD Monitor

- **To prevent damage to the LCD monitor, DO NOT...**
 - ...push it strongly or apply any shocks.
 - ...place the camcorder with the LCD monitor on the bottom.
- **To prolong service life...**
 - ...avoid rubbing it with coarse cloth.
- **Be aware of the following phenomena for LCD monitor use. These are not malfunctions...**
 - ...While using the camcorder, the surface around the LCD monitor and/or the back of the LCD monitor may heat up.
 - ...If you leave power on for a long time, the surface around the LCD monitor becomes hot.

Main Unit

- **For safety, DO NOT...**
 - ...open the camcorder's chassis.
 - ...disassemble or modify the unit.
 - ...short-circuit the terminals of the battery pack. Keep it away from metallic objects when not in use.
 - ...allow inflammables, water or metallic objects to enter the unit.
 - ...remove the battery pack or disconnect the power supply while the power is on.
 - ...leave the battery pack attached when the camcorder is not in use.
- **Avoid using the unit...**
 - ...in places subject to excessive humidity or dust.
 - ...in places subject to soot or steam such as near a cooking stove.
 - ...in places subject to excessive shock or vibration.
 - ...near a television set.
 - ...near appliances generating strong magnetic or electric fields (speakers, broadcasting antennas, etc.).
 - ...in places subject to extremely high (over 40°C or 104°F) or extremely low (under 0°C or 32°F) temperatures.
- **DO NOT leave the unit...**
 - ...in places of over 50°C (122°F).
 - ...in places where humidity is extremely low (below 35%) or extremely high (above 80%).
 - ...in direct sunlight.
 - ...in a closed car in summer.
 - ...near a heater.
- **To protect the unit, DO NOT...**
 - ...allow it to become wet.
 - ...drop the unit or strike it against hard objects.
 - ...subject it to shock or excessive vibration during transportation.
 - ...keep the lens directed at extremely bright objects for long periods.
 - ...expose the lens and viewfinder's lens to direct sunlight.
 - ...carry it by holding the LCD monitor or the viewfinder.
 - ...swing it excessively when using the hand strap or the grip.
 - ...swing the soft camera case excessively when the camcorder is inside it.
- **Dirty heads can cause the following problems:**



- ...No picture during playback.
- ...Blocks of noise appear during playback.
- ...During recording, the Head Clog Warning indicator "⊗" appears.
- ...Recording cannot be performed properly.

In such cases, use an optional cleaning cassette. Insert it and play back. If the cassette is used more than once consecutively, damage to the video heads may result. After the camcorder plays back for about 20 seconds, it stops automatically. Also refer to the cleaning cassette's instructions.

If, after using the cleaning cassette, the problems still exist, consult your nearest JVC dealer.

Mechanical moving parts used to move the video heads and video tape tend to become dirty and worn out over time. In order to maintain a clear picture at all times, periodic check-ups are recommended after using the unit for about 1,000 hours. For periodic check-ups please consult your nearest JVC dealer.

How To Handle A CD-ROM

- Take care not to soil or scratch the mirror surface (opposite to the printed surface). Do not write anything or put a sticker on either the front or back surface. If the CD-ROM gets dirty, gently wipe it with a soft cloth outward from the center hole.
- Do not use conventional disc cleaners or cleaning spray.
- Do not bend the CD-ROM or touch its mirror surface.
- Do not store your CD-ROM in a dusty, hot or humid environment. Keep it away from direct sunlight.

About moisture condensation

- You have observed that pouring a cold liquid into a glass will cause drops of water to form on the glass' outer surface. This same phenomenon occurs on the head drum of a camcorder when it is moved from a cool place to a warm place, after heating a cold room, under extremely humid conditions or in a place directly subjected to the cool air from an air conditioner.
- Moisture on the head drum can cause severe damage to the video tape, and can lead to internal damage to the camcorder itself.

Serious malfunctioning

If malfunctioning occurs, stop using the unit immediately and consult your local JVC dealer.

The camcorder is a microcomputer-controlled device. External noise and interference (from a TV, a radio, etc.) might prevent it from functioning properly. In such cases, first disconnect its power supply unit (battery pack, AC Adapter, etc.) and wait a few minutes and then re-connect it and proceed as usual from the beginning.

Declaration of Conformity

Model Number : GR-D74U
 Trade Name : JVC
 Responsible party : JVC AMERICAS CORP.
 Address : 1700 Valley Road Wayne,
 N. J. 07470

Telephone Number : 973-317-5000

This device complies with Part 15 of FCC Rules. Operation is subject to the following two conditions: (1) This device may not cause harmful interference, and (2) this device must accept any interference received, including interference that may cause undesired operation.

Change or modifications not approved by the party responsible for compliance could void the user's authority to operate the equipment. This equipment has been tested and found to comply with the limits for a Class B digital device, pursuant to Part 15 of the FCC Rules. These limits are designed to provide reasonable protection against harmful interference in a residential installation. This equipment generates, uses, and can radiate radio frequency energy and, if not installed and used in accordance with the instructions, may cause harmful interference to radio communications. However, there is no guarantee that interference will not occur in a particular installation. If this equipment does cause harmful interference to radio or television reception, which can be determined by turning the equipment off and on, the user is encouraged to try to correct the interference by one or more of the following measures:

Reorient or relocate the receiving antenna.

Increase the separation between the equipment and receiver.

Connect the equipment into an outlet on a circuit different from that to which the receiver is connected.

Consult the dealer or an experienced radio/ TV technician for help.

This Class B digital apparatus complies with Canadian ICES-003.

Cet appareil numérique de la classe B est conforme à la norme NMB-003 du Canada.

After Use

- 1** Turn off the camcorder.
- 2** Slide and hold **OPEN/EJECT** in the direction of the arrow, then pull the cassette holder cover open until it locks. The cassette holder opens automatically. Remove the cassette.
- 3** Press "PUSH HERE" to close the cassette holder.
 - Once the cassette holder is closed, it recedes automatically. Wait until it recedes completely before closing the cassette holder cover.
- 4** Slide **BATT.RELEASE** ① and remove the battery pack ② ③.

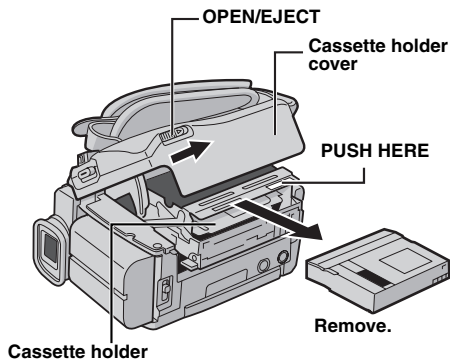

Cleaning The Camcorder

- 1** To clean the exterior, wipe gently with a soft cloth. Put the cloth in diluted mild soap and wring it well to wipe off heavy dirt. Then wipe again with a dry cloth.
- 2** Press the Monitor Opening Button and open the LCD monitor. Wipe gently with a soft cloth. Be careful not to damage the monitor. Close the LCD monitor.
- 3** To clean the lens, blow it with a blower brush, then wipe gently with lens cleaning paper.

NOTES:

- Avoid using strong cleaning agents such as benzine or alcohol.
- Cleaning should be done only after the battery pack has been removed or other power units have been disconnected.
- Mould may form if the lens is left dirty.
- When using a cleaner or chemically treated cloth refer to the cautions of each product.
- To clean the viewfinder, please consult your nearest JVC dealer.

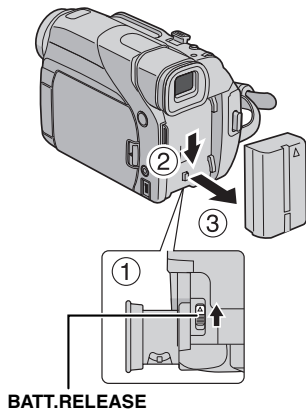

Camcorder

For General

Power supply

DC 11.0 V (Using AC Adapter)

DC 7.2 V (Using battery pack)

Power consumption

Approx. 3.3 W (LCD monitor off, viewfinder on)

Approx. 4.6 W (LCD monitor on, viewfinder off)

Approx. 8.6 W (Maximum)

Dimensions (W x H x D)

71 mm x 91 mm x 118 mm

(2-13/16" x 3-5/8" x 4-11/16") (with the LCD monitor closed and the viewfinder pushed back in)

Weight

Approx. 500 g (1.1 lbs)

(without cassette and battery)

Approx. 590 g (1.3 lbs)

(incl. cassette and battery)

Operating temperature

0°C to 40°C (32°F to 104°F)

Operating humidity

35% to 80%

Storage temperature

-20°C to 50°C (-4°F to 122°F)

Pickup

1/6" CCD

Lens

F 1.6, f = 2.7 mm to 43.2 mm, 16:1 power zoom lens

Filter diameter

ø30.5 mm

LCD monitor

2.37" diagonally measured, LCD panel/TFT active matrix system

Viewfinder

Electronic viewfinder with 0.24" color LCD

Speaker

Monaural

White LED Light

Effective distance: 1.5 m

For Digital Video Camera

Format

DV format (SD mode)

Signal format

NTSC standard

Recording/Playback format

Video: Digital component recording

Audio: PCM digital recording, 32 kHz 4-channel (12-bit), 48 kHz 2-channel (16-bit)

Cassette

Mini DV cassette

Tape speed

SP: 18.8 mm/s, LP: 12.5 mm/s

Maximum recording time (using 80 min. cassette)

SP: 80 min., LP: 120 min.

For Digital Still Camera

Storage media

SD Memory Card/MultiMediaCard

Compression system

Still image: JPEG (compatible)

File size

Still image:

2 modes (1024 x 768 pixels/640 x 480 pixels)

Picture quality

2 modes (FINE/STANDARD)

Approximate number of storable images

☞ pg. 18

For Connectors

S

S-Video input:

Y: 0.8 V to 1.2 V (p-p), 75 Ω, analog

C: 0.2 V to 0.4 V (p-p), 75 Ω, analog

S-Video output:

Y: 1.0 V (p-p), 75 Ω, analog

C: 0.29 V (p-p), 75 Ω, analog

AV

Video input: 0.8 V to 1.2 V (p-p), 75 Ω, analog

Video output: 1.0 V (p-p), 75 Ω, analog

Audio input: 300 mV (rms), 50 kΩ, analog, stereo

Audio output: 300 mV (rms), 1 kΩ, analog, stereo

DV

Input/output: 4-pin, IEEE 1394 compliant

USB

5-pin

AC Adapter

Power requirement

AC 110 V to 240 V~, 50 Hz/60 Hz

Output

DC 11 V $\frac{\square\square\square}{\square}$, 1 A

Specifications shown are for SP mode unless otherwise indicated. E & O.E. Design and specifications subject to change without notice.

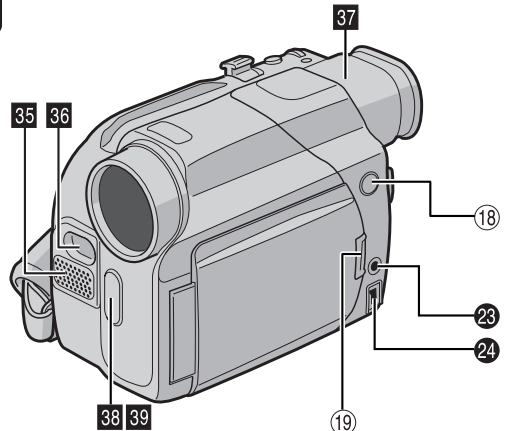
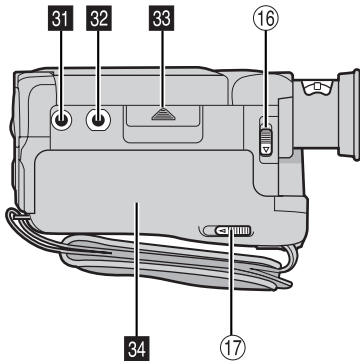
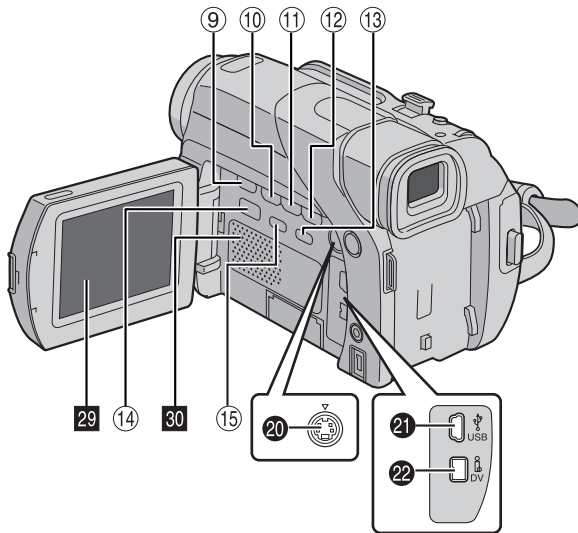
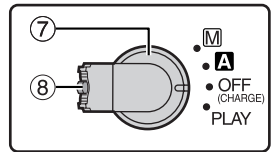
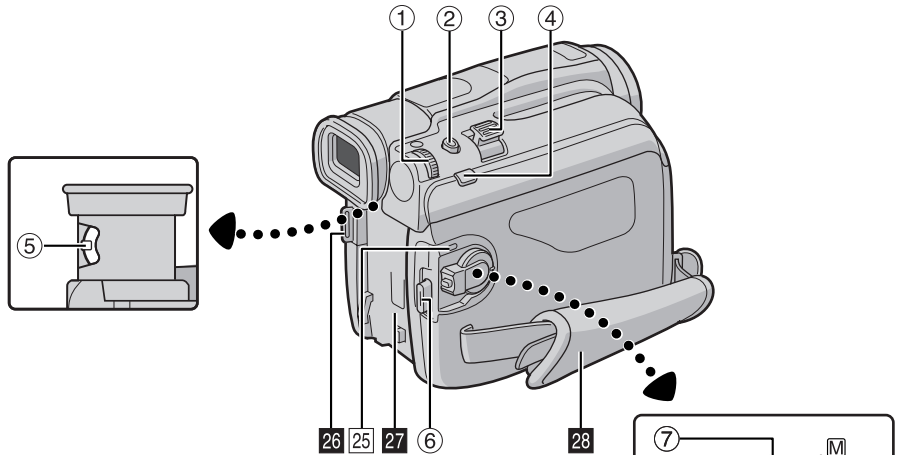

Controls

- ① Menu Wheel [MENU/VOL.] (☞ pg. 25)
Speaker Volume Control [MENU/VOL.] (☞ pg. 14)
- ② Snapshot Button [SNAPSHOT] (☞ pg. 18, 31)
- ③ Power Zoom Lever [T/W] (☞ pg. 12)
- ④ Manual Focus Button [FOCUS] (☞ pg. 32)
Blank Search Button [BLANK SRCH] (☞ pg. 14)
- ⑤ Diopter Adjustment Control (☞ pg. 9)
- ⑥ Recording Start/Stop Button (☞ pg. 11)
- ⑦ Power Switch [A, M, PLAY, OFF] (☞ pg. 8)
- ⑧ Lock Button (☞ pg. 8)
- ⑨ Stop Button [■] (☞ pg. 14)
- ⑩ Rewind Button [◀◀] (☞ pg. 14)
Night Button [NIGHT] (☞ pg. 29)
- ⑪ Play/Pause Button [▶/||] (☞ pg. 14)
- ⑫ Fast-Forward Button [▶▶] (☞ pg. 14)
Backlight Compensation Button [BACKLIGHT]
(☞ pg. 33)
- ⑬ Index Button [INDEX] (☞ pg. 20)
- ⑭ VIDEO/MEMORY Switch (☞ pg. 8)
- ⑮ Information Button [INFO] (☞ pg. 21)
- ⑯ Battery Release Switch [BATT.RELEASE] (☞ pg. 6)
- ⑰ Cassette Open/Eject Switch [OPEN/EJECT]
(☞ pg. 10)
- ⑱ White LED Light Switch [LIGHT] (☞ pg. 29)
- ⑲ Monitor Opening Button (☞ pg. 12)
For models without button, simply pull on bottom end
of LCD monitor to open.

Connectors

- ㉔ S-Video Input/Output Connector [S-VIDEO]
(☞ pg. 17, 34)
 - ㉕ USB (Universal Serial Bus) Connector (☞ pg. 36)
 - ㉖ Digital Video Connector [DV IN/OUT] (i.Link*)
(☞ pg. 35, 36)
 - ㉗ Audio/Video Input/Output Connector [AV]
(☞ pg. 17, 34)
 - ㉘ DC Input Connector [DC] (☞ pg. 6, 7)
- * i.Link refers to the IEEE1394-1995 industry specification and extensions thereof. The logo is used for products compliant with the i.Link standard.

Indicators

- ㉚ POWER/CHARGE Lamp (☞ pg. 8, 11)

Other Parts

- ㉛ Shoulder Strap Eyelet (☞ pg. 5)
- ㉜ Battery Pack Mount (☞ pg. 7)
- ㉝ Grip Strap (☞ pg. 7)
- ㉞ LCD Monitor (☞ pg. 12, 13)
- ㉟ Speaker (☞ pg. 14)
- ㊱ Stud Hole (☞ pg. 9)
- ㊲ Tripod Mounting Socket (☞ pg. 9)
- ㊳ Card Cover [MEMORY CARD] (☞ pg. 10)
- ㊴ Cassette Holder Cover (☞ pg. 10)
- ㊵ Stereo Microphone (☞ pg. 37)
- ㊶ White LED Light (☞ pg. 29)
- ㊷ Viewfinder (☞ pg. 9)
- ㊸ Remote Sensor (☞ pg. 15)
- ㊹ Camera Sensor
(Be careful not to cover this area, a sensor necessary
for shooting is built-in here.)

LCD Monitor/Viewfinder Indications

During Video Recording Only

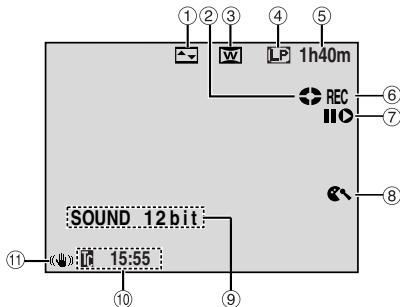

- ① Selected Wipe/Fader Effect Indicator (⇨ pg. 30)
- ② Tape Running Indicator (⇨ pg. 11)
(Rotates while tape is running.)
- ③ Selected Wide Mode Indicator (⇨ pg. 26)
- ④ Recording Speed Mode (SP/LP) (⇨ pg. 26)
- ⑤ Tape Remaining Time (⇨ pg. 12)
- ⑥ REC: (Appears during recording.) (⇨ pg. 11)
PAUSE: (Appears during Record-Standby mode.) (⇨ pg. 11)
- ⑦ Insert Editing/Insert Editing Pause Mode (⇨ pg. 37)
- ⑧ Wind Cut Indicator (⇨ pg. 27)
- ⑨ Sound Mode Indicator (⇨ pg. 26)
(Appears for approx. 5 seconds after turning on the camcorder.)
- ⑩ Time Code (⇨ pg. 27, 28)
- ⑪ Digital Image Stabilizer ("DIS") (⇨ pg. 26)

During D.S.C. Recording Only

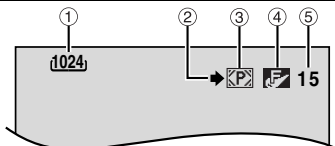

- ① Image Size: 1024 (1024 x 768) or 640 (640 x 480) (⇨ pg. 28)
- ② Shooting Icon (⇨ pg. 18)
(Appears and blinks during shooting.)
- ③ Card Icon (⇨ pg. 18)
[P]: Appears during shooting.
[M]: Blinks in white when a memory card is not loaded.
- ④ Picture Quality: [F] (FINE) and [S] (STANDARD) (in order of quality) (⇨ pg. 27)
- ⑤ Remaining Number Of Shot (⇨ pg. 18)
(Displays the approximate remaining number of shots that can be stored during D.S.C. recording. The number increases or decreases depending on the Picture Quality/Image Size, etc.)

During Both Video And D.S.C. Recording

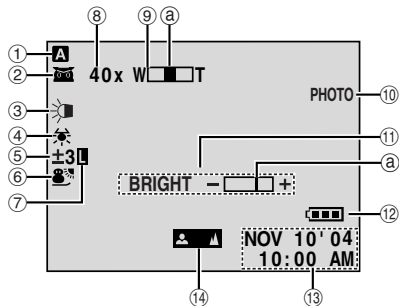

- ① Operation Mode (⇨ pg. 8)
- ② [Night-Alive]: Night-Alive Indicator (⇨ pg. 29)
(Appears when Night-Alive is engaged.)
[Gain Up]: Gain Up Mode (⇨ pg. 26)
(Appears when "GAIN UP" is set to "AUTO" and the shutter speed is automatically adjusted.)
- ③ White LED Light Indicator (⇨ pg. 29)
- ④ White Balance Indicator (⇨ pg. 33)
- ⑤ [Backlight Compensation]: Backlight Compensation Indicator (⇨ pg. 33)
±: Exposure Adjustment Indicator (⇨ pg. 32)
- ⑥ Selected Program AE With Special Effects Indicator (⇨ pg. 30)
- ⑦ Iris Lock Indicator (⇨ pg. 32)
- ⑧ Approximate Zoom Ratio (⇨ pg. 12)
(Appears during zooming.)
- ⑨ Zoom Indicator (⇨ pg. 12)
(Appears during zooming.)
(The level indicator ③ moves.)
- ⑩ PHOTO: (Appears when taking Snapshot.) (⇨ pg. 31)
- ⑪ BRIGHT: Brightness Control Indicator (LCD monitor/Viewfinder) (⇨ pg. 9)
(The level indicator ③ moves.)
- ⑫ Battery Indicator (⇨ pg. 43)
- ⑬ Date/Time (⇨ pg. 8)
- ⑭ Manual Focus Adjustment Indicator (⇨ pg. 32)

During Video Playback

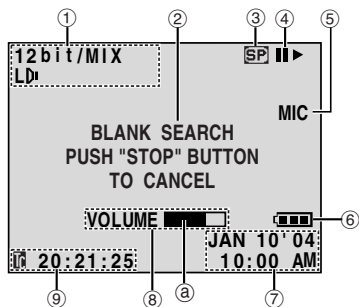

- ① Sound Mode Indicator (☞ pg. 28)
- ② Blank Search Indicator (☞ pg. 14)
- ③ Tape Speed (☞ pg. 26)
- ④ ▶ : Playback
 - ▶▶ : Fast-Forward/Shuttle Search
 - ◀◀ : Rewind/Shuttle Search
 - || : Pause
 - ||▶ : Forward Frame-By-Frame Playback/Slow-Motion
 - ◀|| : Reverse Frame-By-Frame Playback/Slow-Motion
 - : Audio Dubbing
 - ||● : Audio Dubbing Pause
(Appear while a tape is running.)
- ⑤ Sound Input For Audio Dubbing (☞ pg. 37)
- ⑥ Battery Indicator (☞ pg. 43)
- ⑦ Date/Time (☞ pg. 27, 28)
- ⑧ VOLUME +, - : Volume Level Indicator (Speaker)
(☞ pg. 14)
(The level indicator @ moves.)
BRIGHT : Brightness Control Indicator (LCD monitor/Viewfinder) (☞ pg. 9)
(The level indicator @ moves.)
- ⑨ Time Code (☞ pg. 27, 28)

During D.S.C. Playback

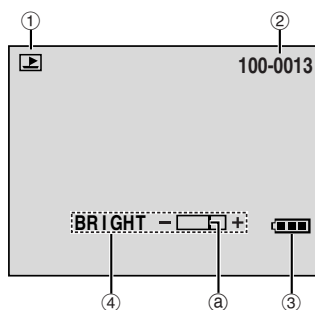

- ① Operation Mode Indicator (☞ pg. 21)
- ② Folder/File Number (☞ pg. 21)
- ③ Battery Indicator (☞ pg. 43)
- ④ Brightness Control Indicator (LCD monitor/Viewfinder)
(☞ pg. 9)
(The level indicator @ moves.)

A

AC Adapter	6, 7
Audio Dubbing	37
Auto Focus	31
Auto Playback Of Images	20
Auto Shut Off	11, 39

B

Backlight Compensation	33
Battery Pack	6, 7, 45
Beep (BEEP)	27
Blank search	14
Brightness Adjustment Of The Display (BRIGHT)	9

C

Changing The Menu Settings	25
Charging The Battery Pack	6
Cleaning The Camcorder	48
Clock adjustment (CLOCK ADJ.)	8
Connections	
Charging	6
Dubbing	34, 35
To A PC	36
To A TV Or VCR	17

D

Date/Time	
Display (DATE/TIME)	27, 28
Settings	8
DCF (Design rule for Camera File system)	20, 39
Deleting Files (DELETE)	22
Demonstration Mode (DEMO MODE)	27
Digital Image Stabilization (DIS)	26
DPOF Setting (Digital Print Order Format)	23
Dubbing	19, 34, 35
Dubbing from tape to memory card	19

E

Erase Protection	10
Exposure Control (EXPOSURE)	32

F

Fade-In/Out	30
Fast-Forward The Tape	14
Frame-By-Frame Playback	16

G

Gain Up (GAIN UP)	26
Grip Adjustment	7

I

Image Size (IMAGE SIZE)	28
Index Playback Of Files	20
Indications on the LCD Monitor/Viewfinder	52
Initializing A Memory Card (FORMAT)	24
Insert Editing	37
Iris	32
Iris Lock	32

J

Journalistic Shooting	13
-----------------------------	----

L

Loading A Cassette	10
Loading A Memory Card	10

M

Manual Focus	32
Memory Card	10, 45
Menu Screen	
CAMERA	26
CAMERA DISPLAY	27
D.S.C. Playback	21 – 24
DSC	27
MANUAL	26
SYSTEM	27, 28
VIDEO	28
VIDEO DISPLAY	28
Motor Drive Mode	31
MultiMediaCard	10, 45

N

Night-Alive	29
-------------------	----

P

Picture Quality (QUALITY)	27
Playback sound (SOUND MODE, NARRATION)	28
Playback Special Effects	16
Playback Zoom	16
Power Switch Position	8
Priority Setting (PRIORITY)	27
Program AE With Special Effects (PROGRAM AE)	
Classic Film (CLASSIC FILM)	31
Monotone (MONOTONE)	31
Sepia (SEPIA)	31
Shutter Speed (SHUTTER)	30
Snow (SNOW)	31
Sports (SPORTS)	31
Spotlight (SPOTLIGHT)	31
Strobe (STROBE)	31
Twilight (TWILIGHT)	31
Protecting Files (PROTECT)	22
Provided Accessories	5

R

Recording media selection (REC SELECT)	28
Recording Mode (REC MODE)	26, 28
Recording Time	
Tape	10
Record-Standby	11
Remaining Power Level	43
Remote control setting (REMOTE)	27
Resetting Menu Settings (CAM RESET)	27
Resetting The File Name	24
Rewind The Tape	14

S

SD Memory Card	10, 45
Self Recording	13
Shuttle Search	14
Slow-Motion Playback	16
Snapshot	18, 31
Snapshot Mode (SNAP MODE)	26
Sound Mode (SOUND MODE)	26, 28
Speaker Volume	14
Specifications	49
Still Playback	14
S-Video/AV input (S/AV INPUT)	28, 34, 35

T

Telephoto setting (TELE MACRO)	26
Time Code (TIME CODE)	13, 27
Tripod Mounting	9

U

Unloading A Cassette	10
Unloading A Memory Card	10

V

VIDEO/MEMORY Switch Position	8
Viewfinder Adjustment	9

W

White Balance (W.BALANCE)	33
White LED Light	29
Wide Mode (WIDE MODE)	
Cinema (CINEMA)	26
Squeeze (SQUEEZE)	26
Wipe In/Out	30

Z

Zooming (ZOOM)	12, 26
----------------------	--------



Free Manuals Download Website

<http://myh66.com>

<http://usermanuals.us>

<http://www.somanuals.com>

<http://www.4manuals.cc>

<http://www.manual-lib.com>

<http://www.404manual.com>

<http://www.luxmanual.com>

<http://aubethermostatmanual.com>

Golf course search by state

<http://golfingnear.com>

Email search by domain

<http://emailbydomain.com>

Auto manuals search

<http://auto.somanuals.com>

TV manuals search

<http://tv.somanuals.com>