

# JVC

## DIGITAL VIDEO CAMERA

# GR-DVL315

Please visit our Homepage on the World Wide Web and answer our Consumer Survey (in English only):

<http://www.jvc-victor.co.jp/english/index-e.html>

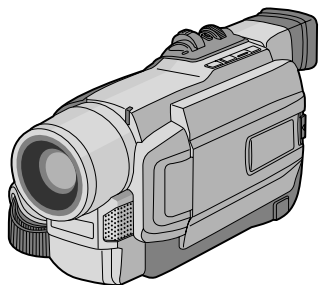

Mini DV NTSC

## INSTRUCTIONS

### For Customer Use:

Enter below the Model No. and Serial No. which is located on the bottom of cabinet. Retain this information for future reference.

Model No. \_\_\_\_\_

Serial No. \_\_\_\_\_

ENGLISH

## CONTENTS

**AUTOMATIC DEMONSTRATION** 5

**GETTING STARTED** 6 – 12

**BASIC RECORDING & PLAYBACK** 13 – 21

**BASIC RECORDING** ..... 14 – 17

**BASIC PLAYBACK** ..... 18 – 21

**ADVANCED FEATURES** 22 – 49

**FOR RECORDING** ..... 23 – 30

**USING THE MENU FOR DETAILED ADJUSTMENT** ..... 31 – 36

**DUBBING** ..... 37 – 38

**USING THE REMOTE CONTROL UNIT** ..... 39 – 47

**SYSTEM CONNECTIONS** ..... 48 – 49

**REFERENCES** 50 – 67

**DETAILS** ..... 51

**TROUBLESHOOTING** ..... 52 – 56

**USER MAINTENANCE** ..... 57

**INDEX** ..... 58 – 62

**CAUTIONS** ..... 63 – 65

**TERMS** ..... 66

**SPECIFICATIONS** ..... 67

LYT0710-001A

EN

**Dear Customer,**

Thank you for purchasing this digital video camera. Before use, please read the safety information and precautions contained in the following pages to ensure safe use of this product.

**Using This Instruction Manual**



- All major sections and subsections are listed in the Table Of Contents on the cover page.
- Notes appear after most subsections. Be sure to read these as well.
- Basic and advanced features/operation are separated for easier reference.

**It is recommended that you . . .**

- .... refer to the Index (☞ pgs. 58 – 62) and familiarize yourself with button locations, etc. before use.
- .... read thoroughly the Safety Precautions and Safety Instructions that follow. They contain extremely important information regarding the safe use of this product.

You are recommended to carefully read the cautions on pages 63 through 65 before use.

# SAFETY PRECAUTIONS

	<b>CAUTION</b> RISK OF ELECTRIC SHOCK DO NOT OPEN	
<p><b>CAUTION:</b> TO REDUCE THE RISK OF ELECTRIC SHOCK, DO NOT REMOVE COVER (OR BACK). NO USER-SERVICEABLE PARTS INSIDE. REFER SERVICING TO QUALIFIED SERVICE PERSONNEL.</p>		



The lightning flash with arrowhead symbol, within an equilateral triangle, is intended to alert the user to the presence of uninsulated "dangerous voltage" within the product's enclosure that may be of sufficient magnitude to constitute a risk of electric shock to persons.



The exclamation point within an equilateral triangle is intended to alert the user to the presence of important operating and maintenance (servicing) instructions in the literature accompanying the appliance.

**WARNING:**

**TO REDUCE THE RISK OF FIRE OR ELECTRIC SHOCK, DO NOT EXPOSE THIS APPARATUS TO RAIN OR MOISTURE.**

**NOTES:**

- *The rating plate (serial number plate) and safety caution are on the bottom and/or the back of the main unit.*
- *The rating information and safety caution of the AC Adapter are on its upper and lower sides.*

**CAUTIONS:**

- This camcorder is designed to be used with NTSC-type color television signals. It cannot be used for playback with a television of a different standard. However, live recording and LCD monitor/viewfinder playback are possible anywhere.
- Use the JVC BN-V408U/V416U/V428U battery packs and, to recharge them or to supply power to the camcorder from an AC outlet, use the provided multi-voltage AC Adapter. (An appropriate conversion adapter may be necessary to accommodate different designs of AC outlets in different countries.)

When the equipment is installed in a cabinet or on a shelf, make sure that it has sufficient space on all sides to allow for ventilation (10 cm (3-15/16") or more on both sides, on top and at the rear).

Do not block the ventilation holes.

(If the ventilation holes are blocked by a newspaper, or cloth etc. the heat may not be able to get out.)

No naked flame sources, such as lighted candles, should be placed on the apparatus.

When discarding batteries, environmental problems must be considered and the local rules or laws governing the disposal of these batteries must be followed strictly.

The apparatus shall not be exposed to dripping or splashing.

Do not use this equipment in a bathroom or places with water.

Also do not place any containers filled with water or liquids (such as cosmetics or medicines, flower vases, potted plants, cups etc.) on top of this unit.

(If water or liquid is allowed to enter this equipment, fire or electric shock may be caused.)

# IMPORTANT SAFETY INSTRUCTIONS

- |  |   |  |
|--|---|--|
| <ul style="list-style-type: none"> <li>(1) Read these instructions.</li> <li>(2) Keep these instructions.</li> <li>(3) Heed all warnings.</li> <li>(4) Follow all instructions.</li> <li>(5) Do not use this apparatus near water.</li> <li>(6) Clean only with dry cloth.</li> <li>(7) Do not block any ventilation openings. Install in accordance with the manufacturer's instructions.</li> <li>(8) Do not install near any heat sources such as radiators, heat registers, stoves, or other apparatus (including amplifiers) that produce heat.</li> <li>(9) Only use attachments/accessories specified by the manufacturer.</li> </ul> | <ul style="list-style-type: none"> <li>(10) Use only with the cart, stand, tripod, bracket, or table specified by the manufacturer, or sold with the apparatus. When a cart is used, use caution when moving the cart/apparatus combination to avoid injury from tip-over.</li> <li>(11) Unplug this apparatus during lightning storms or when unused for long periods of time.</li> <li>(12) Refer all servicing to qualified service personnel. Servicing is required when the apparatus has been damaged in any way, such as power-supply cord or plug is damaged, liquid has been spilled or objects have fallen into the apparatus, the apparatus has been exposed to rain or moisture, does not operate normally, or has been dropped.</li> </ul> |  |
|--|---|--|

## SAFETY PRECAUTIONS

Do not point the lens or the viewfinder directly into the sun. This can cause eye injuries, as well as lead to the malfunctioning of internal circuitry. There is also a risk of fire or electric shock.

### CAUTION!

The following notes concern possible physical damage to the camcorder and to the user.

When carrying, be sure to always securely attach and use the provided shoulder strap. Carrying or holding the camcorder by the viewfinder and/or the LCD monitor can result in dropping the unit, or in a malfunction.

Take care not to get your finger caught in the cassette holder cover. Do not let children operate the camcorder, as they are particularly susceptible to this type of injury.

Do not use a tripod on unsteady or unlevel surfaces. It could tip over, causing serious damage to the camcorder.

### CAUTION!

Connecting cables (Audio/Video, S-Video, etc.) to the camcorder and leaving the unit on top of the TV is not recommended, as tripping on the cables will cause the camcorder to fall, resulting in damage.

## PROVIDED ACCESSORIES

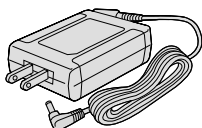

• AC Adapter  
AP-V10U



• Remote Control Unit  
RM-V715U

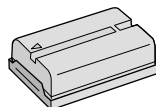

• Battery Pack  
BN-V408U



• AAA (R03) Battery x 2  
(for remote control unit)



• Lens Cap (☞ pg. 5  
for attachment)

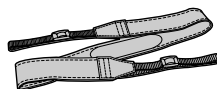

• Shoulder Strap



• Audio/Video Cable  
(ø3.5 mini-plug to RCA plug)

**NOTE:**

*In order to maintain optimum performance of the camcorder, provided cables may be equipped with one or more core filter.*

## AUTOMATIC DEMONSTRATION

Automatic Demonstration takes place when "DEMO MODE" is set to "ON" (factory-preset).

- Available when the Power Switch is set to "A" or "M" and no cassette is in the camcorder.
- Performing any operation during the demonstration stops the demonstration temporarily. If no operation is performed for more than 1 minute after that, the demonstration will resume.
- "DEMO MODE" remains "ON" even if the camcorder power is turned off.
- To cancel Automatic Demonstration:
  1. Set the Power Switch to "M" while pressing down the Lock Button located on the switch and press the MENU/BRIGHT wheel in. The Menu Screen appears.
  2. Rotate the MENU/BRIGHT wheel to select "SYSTEM" and press it. The SYSTEM Menu appears.
  3. Rotate the MENU/BRIGHT wheel to select "DEMO MODE" and press it. The Sub Menu appears.
  4. Rotate the MENU/BRIGHT wheel to select "OFF" and press it.
  5. Rotate the MENU/BRIGHT wheel to select "◀RETURN", and press it twice. The normal screen appears.

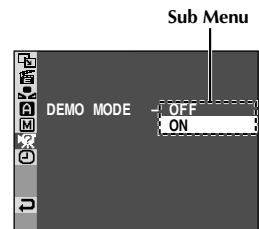
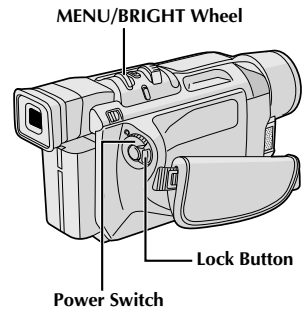

### NOTE:

If you do not detach the Lens Cap, you cannot see the actual changes of the Automatic Demonstration activated on the LCD monitor or viewfinder.

## How To Attach The Lens Cap

To protect the lens, attach the provided lens cap to the camcorder as shown in the illustration.

### NOTE:

To confirm the lens cap is on correctly make sure the cap is flush to the camera.

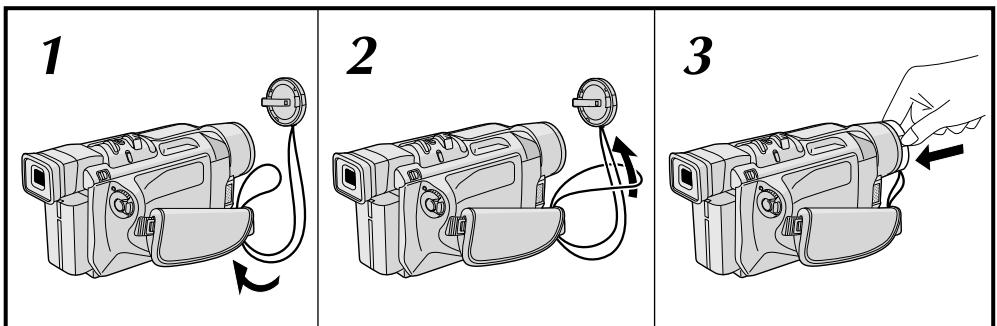

**GETTING STARTED****CONTENTS**

Power .....	7 – 8
Grip Adjustment .....	9
Viewfinder Adjustment .....	9
Shoulder Strap Attachment .....	9
Tripod Mounting .....	9
Date/Time Settings .....	10
Loading/Unloading A Cassette .....	11
Recording Mode Setting .....	12

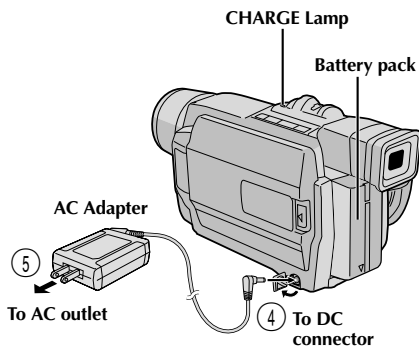
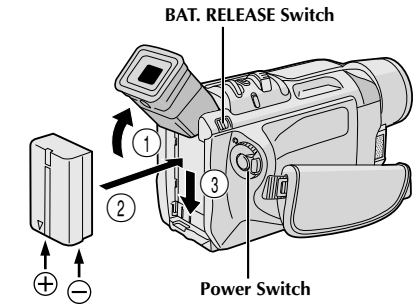

Battery pack	Charging time
BN-V408U	approx. 1 hr. 30 min.
BN-V416U (optional)	approx. 2 hrs.
BN-V428U (optional)	approx. 3 hrs. 20 min.

## Power

This camcorder's 2-way power supply system lets you choose the most appropriate source of power. Do not use provided power supply units with other equipment.

### CHARGING THE BATTERY PACK

- 1** Tilt the viewfinder upward ①. With the arrow on the battery pack pointing downward, push the battery pack slightly against the battery pack mount ②, then slide down the battery pack until it locks in place ③.
- 2** Set the Power Switch to "OFF". Connect the AC Adapter to the camcorder ④.
- 3** Plug the AC Adapter into an AC outlet ⑤. The CHARGE lamp on the camcorder blinks to indicate charging has started.
- 4** When the CHARGE lamp stops blinking but stays lit, charging is finished. Unplug the AC Adapter from the AC outlet. Disconnect the AC Adapter from the camcorder.

#### To Detach The Battery Pack . . .

.... slide **BAT. RELEASE** and pull out the battery pack.

#### NOTES:

- If the protective cap is attached to the battery pack, remove it first.
- During charging, the camcorder cannot be operated.
- Charging is not possible if the wrong type of battery is used.
- When charging the battery pack for the first time or after a long storage period, the CHARGE lamp may not light. In this case, remove the battery pack from the camcorder, then try charging again.
- If the battery operation time remains extremely short even after having been fully charged, the battery is worn out and needs to be replaced. Please purchase a new one.
- Using the optional AA-V40U AC Power Adapter/Charger, you can charge the BN-V408U/V416U/V428U battery pack without the camcorder. However, it cannot be used as an AC adapter.

CONTINUED ON NEXT PAGE

**ATTENTION:**

Before detaching the power source, make sure that the camcorder's power is turned off. Failure to do so can result in a camcorder malfunction.

**NOTES:**

- Recording time is reduced significantly under the following conditions:
  - Zoom or Record-Standby mode is engaged repeatedly.
  - The LCD monitor is used repeatedly.
  - The playback mode is engaged repeatedly.
- Before extended use, it is recommended that you prepare enough battery packs to cover 3 times the planned shooting time.

**INFORMATION:**

The extended-use battery pack kit is a set composed of a battery pack and AC Power Adapter/Charger:

VU-V840 KIT : BN-V840U battery pack & AA-V15U AC Power Adapter/Charger

VU-V856 KIT : BN-V856U battery pack & AA-V80U AC Power Adapter/Charger

Read the kit's instruction manual before using.

Neither BN-V840U nor BN-V856U can be charged by using the AC Adapter provided with this camcorder. Use only the AA-V15U AC Power Adapter/Charger for BN-V840U battery pack and only AA-V80U AC Power Adapter/Charger for BN-V856U battery pack. Also, by using the optional JVC VC-VBN856U DC Cord, it will be possible to connect the BN-V840U or BN-V856U battery packs to the camcorder and supply power directly to the camcorder.

**USING THE BATTERY PACK**

Perform step 1 of "CHARGING THE BATTERY PACK" (☞ pg. 7).

**Approximate recording time (unit: min.)**

Battery pack	LCD monitor on	Viewfinder on
BN-V408U	1 hr. (35 min.)	1 hr. 15 min. (40 min.)
BN-V416U (optional)	2 hrs. (1 hr. 10 min.)	2 hrs. 30 min. (1 hr. 20 min.)
BN-V428U (optional)	3 hrs. 30 min. (2 hrs.)	4 hrs. 20 min. (2 hrs. 20 min.)
BN-V840U (optional)	5 hrs. (2 hrs. 55 min.)	6 hrs. 15 min. (3 hrs. 20 min.)
BN-V856U (optional)	7 hrs. (4 hrs.)	8 hrs. 40 min. (4 hrs. 40 min.)

( ) : when the video light is on

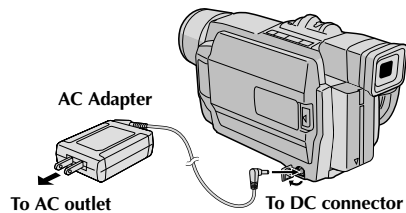
**USING AC POWER**

Use the AC Adapter (connect as shown in the illustration).

**NOTES:**

- The provided AC Adapter features automatic voltage selection in the AC range from 110 V to 240 V.
- For other notes, ☞ pg. 51.

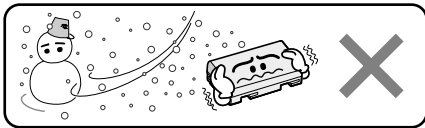

Lithium-ion is vulnerable in colder temperatures.

**About Batteries**

**DANGER!** Do not attempt to take the batteries apart, or expose them to flame or excessive heat, as it may cause a fire or explosion.

**WARNING!** Do not allow the battery or its terminals to come in contact with metals, as this can result in a short circuit and possibly start a fire.

**The Benefits Of Lithium-Ion Batteries**

Lithium-ion battery packs are small but have a large power capacity. However, when one is exposed to cold temperatures (below 10°C/50°F), its usage time becomes shorter and it may cease to function. If this happens, place the battery pack in your pocket or other warm, protected place for a short time, then re-attach it to the camcorder. As long as the battery pack itself is not cold, it should not affect performance.

(If you're using a heating pad, make sure the battery pack does not come in direct contact with it.)



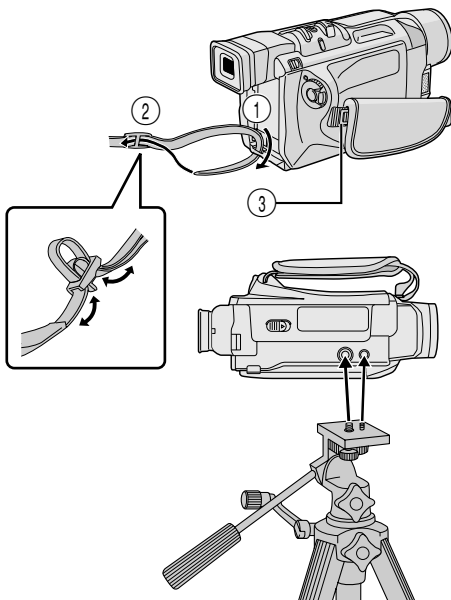
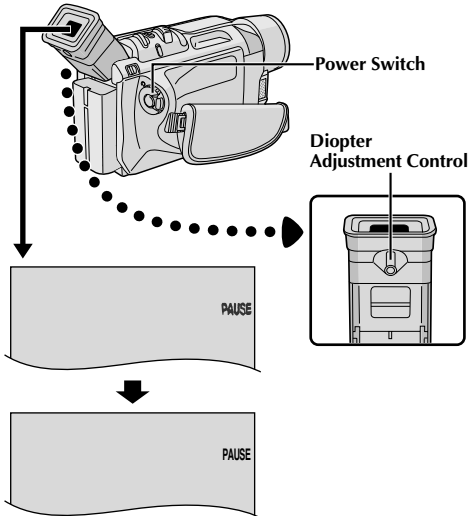
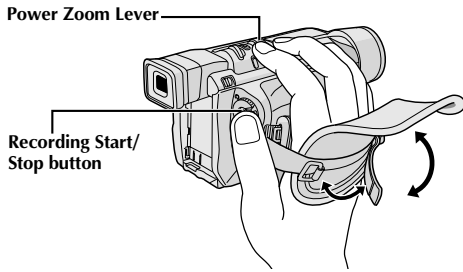

## Grip Adjustment

- 1 Separate the Velcro strip.
- 2 Pass your right hand through the loop and grasp the grip.
- 3 Adjust your thumb and fingers through the grip, to easily operate the Recording Start/Stop button and Power Switch and Power Zoom Lever. Be sure to fasten the Velcro strip to your preference.

## Viewfinder Adjustment

- 1 Set the Power Switch to "A" or "M" while pressing down the Lock Button located on the switch.
- 2 Turn the Diopter Adjustment Control until the indications in the viewfinder are clearly focused.

## Shoulder Strap Attachment

- 1 Make sure the battery pack is removed. Following the illustration, thread the strap through the eyelet (1), then fold it back and thread it through the buckle (2). Repeat the procedure to attach the other end of the strap to the other eyelet (3) located under the Grip Strap. Confirm the strap is not twisted.

## Tripod Mounting

### CAUTION:

When attaching the camera to a tripod, extend its legs to stabilize the camcorder. It is not advised to use small sized tripods. This may cause damage to the unit by falling over.

- 1 To attach the camera to a tripod, align the direction stud and screw to the mounting socket and stud hole on the camera. Then tighten the screw clockwise. Some tripods are not equipped with studs.

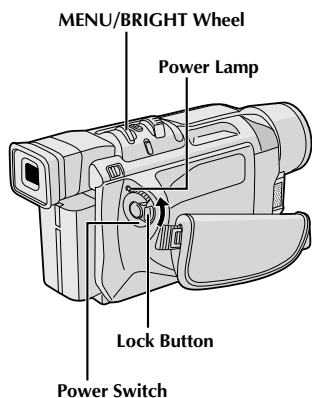

## Display

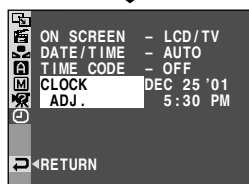
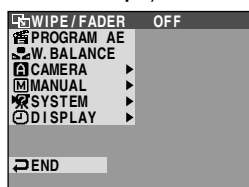

## DISPLAY Menu

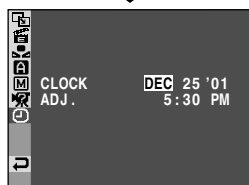

## Date/Time Settings

The date/time is recorded onto the tape at all times, but its display can be turned on or off during playback (☞ pg. 35, 36).

- 1** Set the Power Switch to "⏻" while pressing down the Lock Button located on the switch. The power lamp lights and the camcorder is turned on.
- 2** Press the **MENU/BRIGHT** wheel in to access the Menu Screen.
- 3** Rotate the **MENU/BRIGHT** wheel to select "📺 DISPLAY". Press it and the DISPLAY Menu appears.
- 4** Rotate the **MENU/BRIGHT** wheel to select "CLOCK ADJ.". Press it and "month" is highlighted. Rotate the **MENU/BRIGHT** wheel to input the month. Press it. Repeat to input the day, year, hour and minute. Rotate the **MENU/BRIGHT** wheel to select "◀RETURN", and press it twice. The Menu Screen closes.

## NOTE:

Even if you select "CLOCK ADJ.", if the parameter is not highlighted the camcorder's internal clock continues to operate. Once you move the highlight bar to the first date/time parameter (month), the clock stops. When you finish setting the minute and press the **MENU/BRIGHT** wheel in, the date and time begin operation from the date and time you just set.

## Loading/Unloading A Cassette

The camcorder needs to be powered up to load or eject a cassette.

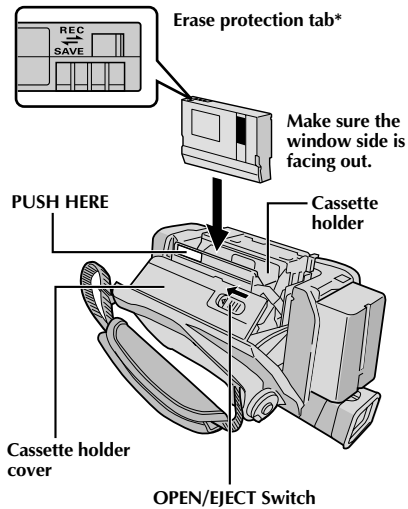

- 1** Slide and hold **OPEN/EJECT** in the direction of the arrow then pull the cassette holder cover open until it locks. The cassette holder opens automatically.
  - Do not touch internal components.
- 2** Insert or remove a tape and press "PUSH HERE" to close the cassette holder.
  - Once the cassette holder is closed, it recedes automatically. Wait until it recedes completely before closing the cassette holder cover.
  - When the battery's charge is low, you may not be able to close the cassette holder cover. Do not apply force. Replace the battery with a fully charged one before continuing.
- 3** Close the cassette holder cover firmly until it locks into place.

### \* To Protect Valuable Recordings . . .

...slide the erase protection tab on the back of the tape in the direction of "SAVE". This prevents the tape from being recorded over. To record on this tape, slide the tab back to "REC" before loading it.

Be sure to press only the section labeled "PUSH HERE" to close the cassette holder; touching other parts may cause your finger to get caught in the cassette holder, resulting in injury or product damage.

### Approximate recording time

Tape	Recording mode	
	SP	LP
30 min.	30 min.	45 min.
60 min.	60 min.	90 min.
80 min.	80 min.	120 min.

### NOTES:

- It takes a few seconds for the cassette holder to open. Do not apply force.
- If you wait a few seconds and the cassette holder does not open, close the cassette holder cover and try again. If the cassette holder still does not open, turn the camcorder off then on again.
- If the tape does not load properly, open the cassette holder cover fully and remove the cassette. A few minutes later, insert it again.
- When the camcorder is suddenly moved from a cold place to a warm environment, wait a short time before opening the cassette holder cover.
- Closing the cassette holder cover before the cassette holder comes out may cause damage to the camcorder.
- Even when the camcorder is switched off, a cassette can be loaded or unloaded. After the cassette holder is closed with the camcorder switched off, however, it may not recede. It is recommended to turn the power on before loading or unloading.
- When resuming recording, once you open the cassette holder cover a blank portion will be recorded on the tape or a previously recorded scene will be erased (recorded over) regardless of whether the cassette holder came out or not. See page 17 for information about recording from the middle of a tape.

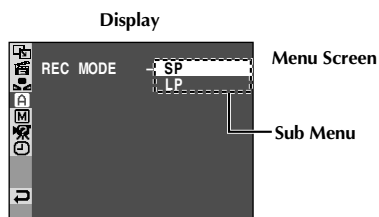
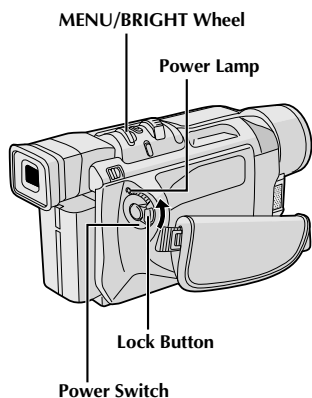

## Recording Mode Setting

Set the tape recording mode depending on your preference.

- 1** Set the Power Switch to "M" while pressing down the Lock Button located on the switch. The power lamp lights and the camcorder is turned on.
- 2** Press the **MENU/BRIGHT** wheel in. The Menu Screen appears.
- 3** Rotate the **MENU/BRIGHT** wheel to select "CAMERA" and press it. The CAMERA Menu appears.
- 4** Rotate the **MENU/BRIGHT** wheel to select "REC MODE" and press it. The Sub Menu appears. Select "SP" or "LP" by rotating the **MENU/BRIGHT** wheel and press it. Rotate the **MENU/BRIGHT** wheel to select "RETURN", and press it twice. The Menu Screen closes.
  - Audio Dubbing (pg. 47) impossible on a tape recorded in the LP mode.
  - "LP" (Long Play) is more economical, providing 1.5 times the recording time.

### NOTES:

- If the recording mode is switched during recording, the playback picture will be blurred at the switching point.
- It is recommended that tapes recorded in the LP mode on this camcorder be played back on this camcorder.
- During playback of a tape recorded on another camcorder, blocks of noise may appear or there may be momentary pauses in the sound.

# **BASIC RECORDING & PLAYBACK**

## **CONTENTS**

<b>BASIC RECORDING</b> .....	<i>14 – 17</i>
Basic Recording .....	<i>14</i>
Journalistic Shooting .....	<i>15</i>
Self-Recording .....	<i>15</i>
Operation Mode .....	<i>15</i>
Zooming .....	<i>16</i>
Video Light .....	<i>16</i>
Time Code .....	<i>17</i>
<b>BASIC PLAYBACK</b> .....	<i>18 – 21</i>
Normal Playback .....	<i>18</i>
Still Playback .....	<i>18</i>
Shuttle Search .....	<i>18</i>
Frame-By-Frame Playback .....	<i>18</i>
Blank Search .....	<i>19</i>
Connections .....	<i>20 – 21</i>

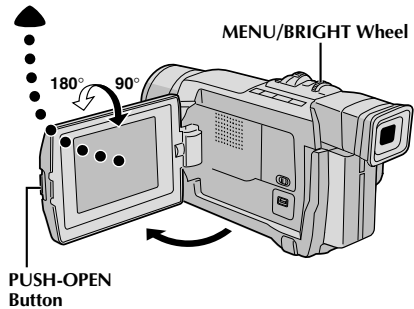
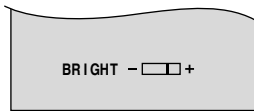
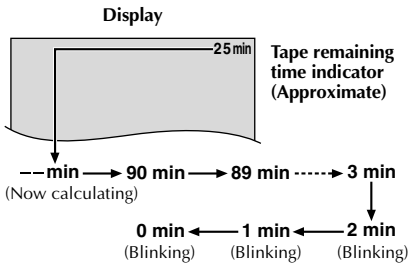
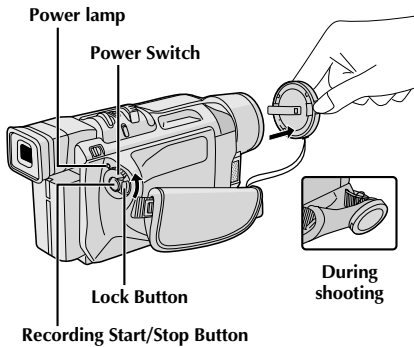

Tally lamp (lights while recording is in progress)

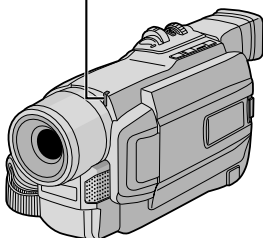

## Basic Recording

### NOTE:

You should already have performed the procedures listed below. If not, do so before continuing.

- Power (☞ pg. 7)
- Grip Adjustment (☞ pg. 9)
- Viewfinder Adjustment (☞ pg. 9)
- Load A Cassette (☞ pg. 11)
- Recording Mode Setting (☞ pg. 12)

**1** Press in the tabs on the lens cap to remove it.

**2** Set the Power Switch to “**A**” or “**M**” while pressing down the Lock Button located on the switch.

**Shooting while using the LCD monitor:** Make sure the LCD monitor is fully open. Tilt it upward/downward for best viewability.

**Shooting while using the viewfinder:** Close the LCD monitor.

- The power lamp lights and the camcorder enters the Record-Standby mode. “PAUSE” is displayed.

**3** Press the Recording Start/Stop Button. “**REC**” appears while recording is in progress.

### To Stop Recording . . .

.... press the Recording Start/Stop Button. The camcorder re-enters the Record-Standby mode.

### To Adjust The Brightness Of The Display

.... rotate the MENU/BRIGHT wheel until the bright level indicator on the display moves and the appropriate brightness is reached.

- It is also possible to adjust the brightness of the viewfinder by closing the LCD monitor and adjusting as described above.

### NOTES:

- If the Record-Standby mode continues for 5 minutes, the camcorder’s power shuts off automatically. To turn the camcorder on again, set the Power Switch to “OFF”, then back to “**A**” or “**M**”.
- The image will not appear simultaneously on the LCD monitor and the viewfinder. It will appear in the viewfinder when the LCD monitor is in the lock position, and it will appear on the LCD monitor when fully extended.
- When a blank portion is left between recorded scenes on the tape, the time code is interrupted and errors may occur when editing the tape. To avoid this, refer to “Recording from the middle of a tape” (☞ pg. 17).
- To turn the tally lamp or beep sounds off, ☞ pg. 31, 33.

**Self-Recording****JOURNALISTIC SHOOTING**

In some situations, different shooting angles may provide more dramatic results. Hold the camcorder in the desired position and tilt the LCD monitor in the most convenient direction. It can rotate 270° (90° downward, 180° upward).

**SELF-RECORDING**

You can shoot yourself while viewing your own image in the LCD monitor. Open the LCD monitor and tilt it upward 180° so that it faces forward, then point the lens toward yourself and start recording.

To turn on the camcorder, set the Power Switch to any operation mode except "OFF" while pressing down the Lock Button located on the switch.

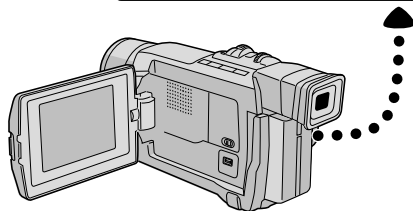
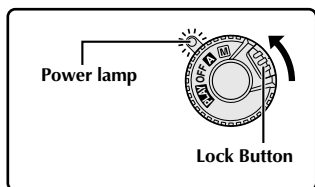
**Power Switch****Power Switch Position****M (Manual):**

Allows you to set various recording functions using the Menu. If you want more creative capabilities than Full Auto recording, try this mode.

**A (Full Auto):**

Allows you to record using NO special effects or manual adjustments. Suitable for standard recording.

**OFF:**

Allows you to switch off the camcorder.

**PLAY :**

- Allows you to play back a recording on the tape.
- Allows you to transfer a still image recorded on the tape to a computer.

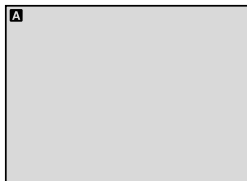

When the Power Switch is set to "A", "A" appears. When set to "M" or "PLAY", there is no indication.

## Zoom in (T: Telephoto)

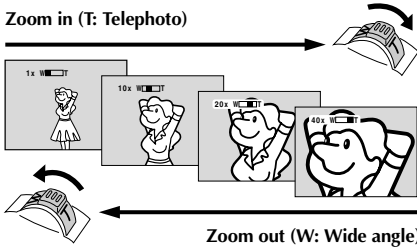

Zoom out (W: Wide angle)

## Zoom display

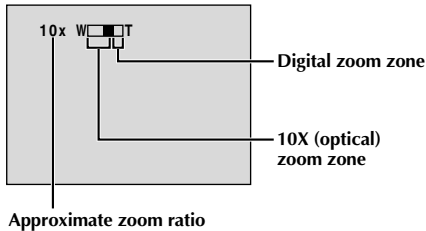

Approximate zoom ratio

## Power Zoom Lever

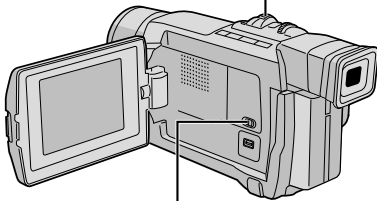

**LIGHT OFF/AUTO/ON Switch**  
(Open the LCD monitor to access this switch.)

## Zooming

To produce the zoom in/out effect, or an instantaneous change in image magnification.

## Zoom In

Slide the Power Zoom Lever towards "T".

## Zoom Out

Slide the Power Zoom Lever towards "W".

- The further you slide the Power Zoom Lever, the quicker the zoom action.
- Focusing may become unstable during Zooming. In this case, set the zoom while in Record-Standby, lock the focus by using the manual focus (☞ pg. 28), then zoom in or out in Record mode.
- Zooming is possible to a maximum of 400X, or it can be switched to 10X magnification using the optical zoom (☞ pg. 32).
- Zoom magnification of over 10X is done through Digital image processing, and is therefore called Digital Zoom.
- During Digital zoom, the quality of image may suffer.
- Digital zoom cannot be used when digital image processing, such as Picture Wipe/Dissolve (☞ pg. 26, 27) or Video Echo (☞ pg. 25), is activated.
- Macro shooting (as close as approx. 5 cm (2") to the subject) is possible when the Power Zoom Lever is set all the way to "W". Also see "TELE MACRO" in the Menu Screen on page 33.

## Video Light

To brighten the scene when natural lighting is too dim.

Set **LIGHT OFF/AUTO/ON** as required:

**OFF** : Turns off the light.

**AUTO** : Automatically turns on the light when the camcorder senses insufficient lighting on the subject.

**ON** : Always keeps the light on as long as the camcorder is turned on.

- The video light can only be used with the camcorder's power on.
- It is recommended to set the white balance (☞ pg. 30) to  when you use the video light.
- When not using the video light, turn it off to save battery power.
- Even if the battery indicator (☞) does not blink due to low battery charge, the camcorder may turn off automatically when you turn on the video light, or when you start recording with the video light turned on.
- When **LIGHT OFF/AUTO/ON** is set to "AUTO":
  - Depending on the lighting conditions, the video light may keep turning on and off. In this case, manually switch the light on or off using **LIGHT OFF/AUTO/ON**.
  - While the "SHUTTER" or "SPORTS" mode (☞ pg. 25) is engaged, the light is likely to stay on.
  - While the "TWILIGHT" mode (☞ pg. 25) is engaged, the light will not activate.
  - While the "Night-Alive" mode (☞ pg. 24) is engaged, the light will not activate.

## DANGER

- The video light can become extremely hot. Do not touch it either while in operation or soon after turning it off, otherwise serious injury may result.
- Do not place the camcorder into the carrying case immediately after using the video light, since it remains extremely hot for some time.
- When operating, keep a distance of about 30 cm (11-13/16") between the video light and people or objects.
- Do not use near flammable or explosive materials.
- It is recommended that you consult your nearest JVC dealer for replacing the video light.





## Time Code

During recording, a time code is recorded on the tape. This code is to confirm the location of the recorded scene on the tape during playback.

If recording starts from a blank portion, the time code begins counting from "00:00:00" (minute:second:frame). If recording starts from the end of a previously recorded scene, the time code continues from the last time code number.

To perform Random Assemble Editing (☞ pg. 42 – 46), time code is necessary. If during recording a blank portion is left partway through the tape, the time code is interrupted. When recording is resumed, the time code starts counting up again from "00:00:00". This means the camcorder may record the same time codes as those existing in a previously recorded scene. To prevent this, perform "Recording From The Middle Of A Tape" below in the following cases;

- When shooting again after playing back a recorded tape.
- When power shuts off during shooting.
- When a tape is removed and re-inserted during shooting.
- When shooting using a partially recorded tape.
- When shooting on a blank portion located partway through the tape.
- When shooting again after shooting a scene then opening/closing the cassette holder cover.

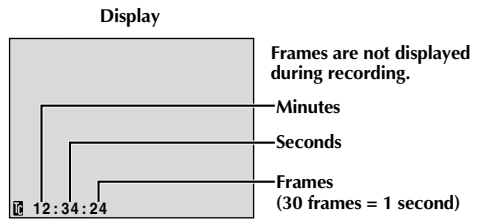

## Recording From The Middle Of A Tape

1. Play back a tape or use Blank Search (☞ pg. 19) to find the spot at which you want to start recording, then engage the Still Playback mode (☞ pg. 18).
2. Set the Power Switch to "A" or "M" while pressing down the Lock Button located on the switch, then start recording.

### NOTES:

- The time code cannot be reset.
- During fast-forwarding and rewinding, the time code indication does not move smoothly.
- The time code is displayed only when "TIME CODE" is set to "ON" (☞ pg. 34, 35).

## When a blank portion is recorded on a tape

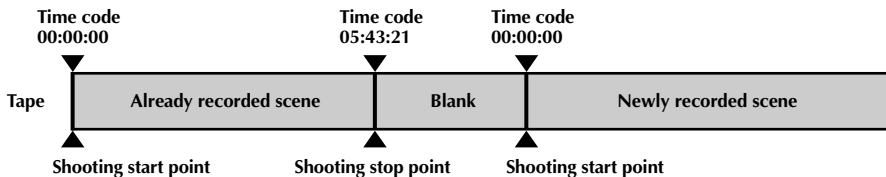

## Proper recording

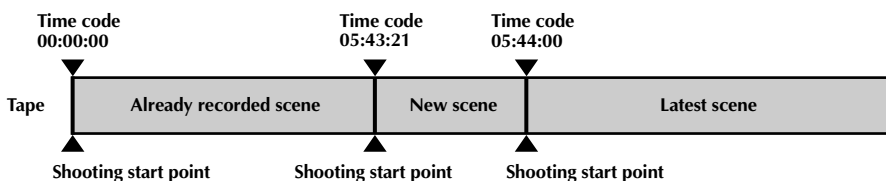

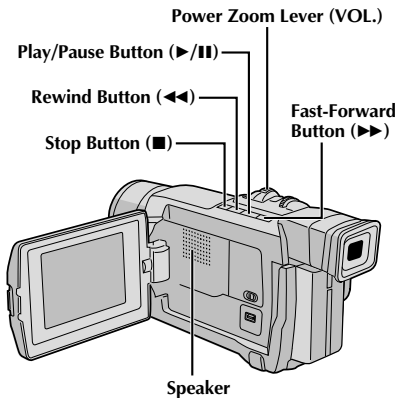
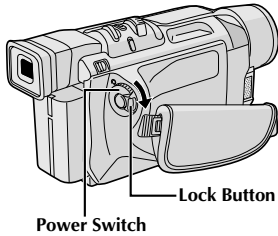

## Normal Playback

- 1** Load a tape (☞ pg. 11).
- 2** Set the Power Switch to “**PLAY**” while pressing down the Lock Button located on the switch. To start playback, press ▶/⏸.
  - To stop playback, press ■.
  - Press ◀◀ to rewind, or ▶▶ to fast-forward the tape during Stop mode.

### To Control The Speaker . . .

... slide the Power Zoom Lever (VOL.) towards “+” to turn up the volume, or towards “-” to turn down the volume.

### NOTES:

- If Stop mode continues for 5 minutes when power is supplied from a battery, the camcorder shuts off automatically. To turn on again, set the Power Switch to “OFF”, then to “PLAY”.
- The playback picture can be viewed in the LCD monitor, viewfinder or on a connected TV (☞ pg. 20).
- You can also view the playback picture on the LCD monitor with it flipped over and pushed against the camera body.
- LCD monitor/viewfinder indications:
  - When power is supplied from a battery: the “☐” battery pack remaining power indicator is displayed. When power is supplied from an AC outlet: “☐” does not appear.
  - During Stop mode, none of the indications are displayed.
- When a cable is connected to the AV connector, the sound is not heard from the speaker.

### Still Playback:

Pauses during playback.

- 1) Press ▶/⏸ during playback.
  - 2) To resume normal playback, press ▶/⏸ again.
- If still playback continues for more than about 3 minutes, the camcorder's Stop mode is automatically engaged. After 5 minutes in the Stop mode, the camcorder's power is automatically turned off.
  - When ▶/⏸ is pressed, the image may not pause immediately while the camcorder stabilizes the still image.

### Shuttle Search:

Allows high-speed search in either direction.

- 1) Press ▶▶ for forward or ◀◀ for reverse search during playback.
  - 2) To resume normal playback, press ▶/⏸.
- During playback, press and hold ◀◀ or ▶▶. The search continues as long as you hold the button. Once you release it, normal playback resumes.
  - A slight mosaic effect appears on screen during Shuttle Search. This is not a malfunction.

### Frame-By-Frame Playback:

Allows frame-by-frame search.

- 1) Engage Still Playback.
  - 2) Rotate the MENU/BRIGHT wheel towards “+” for forward Frame-By-Frame Playback, or towards “-” for reverse Frame-By-Frame Playback during Still Playback.
- To resume normal playback, press ▶/⏸.

### Playback Zoom

Available only with the remote control (provided) (☞ pg. 40, 41).

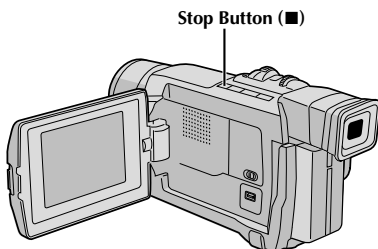
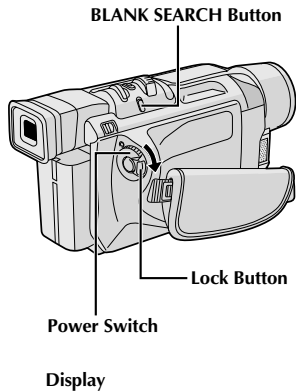

## Blank Search

Helps you find where you should start recording in the middle of a tape to avoid time code interruption (☞ pg. 17).

- 1** Load a tape (☞ pg. 11).
- 2** Set the Power Switch to "PLAY" while pressing down the Lock Button located on the switch.
- 3** Press **BLANK SEARCH**.
  - "BLANK SEARCH" appears blinking and the camcorder automatically starts reverse or forward shuttle search, then stops at the spot which is about 3 seconds of tape before the beginning of the detected blank portion.

**To cancel Blank Search midway . . .**  
.... press ■.

### NOTES:

- In step 3, if the current position is at a blank portion the camcorder searches in the reverse direction, and if the current position is at a recorded portion the camcorder searches in the forward direction.
- Blank Search does not work if "HEAD CLEANING REQUIRED. USE CLEANING CASSETTE" has appeared with the tape.
- If the beginning or end of the tape is reached during Blank Search, the camcorder stops automatically.
- A blank portion which is shorter than 5 seconds of tape may not be detected.
- The detected blank portion may be located between recorded scenes. Before you start recording, make sure there is no recorded scene after the blank portion.

## Connections

These are some basic types of connections. When making the connections, refer also to your VCR and TV instruction manuals.

### A. Connection to a TV or VCR equipped with an S-VIDEO IN and A/V input connectors

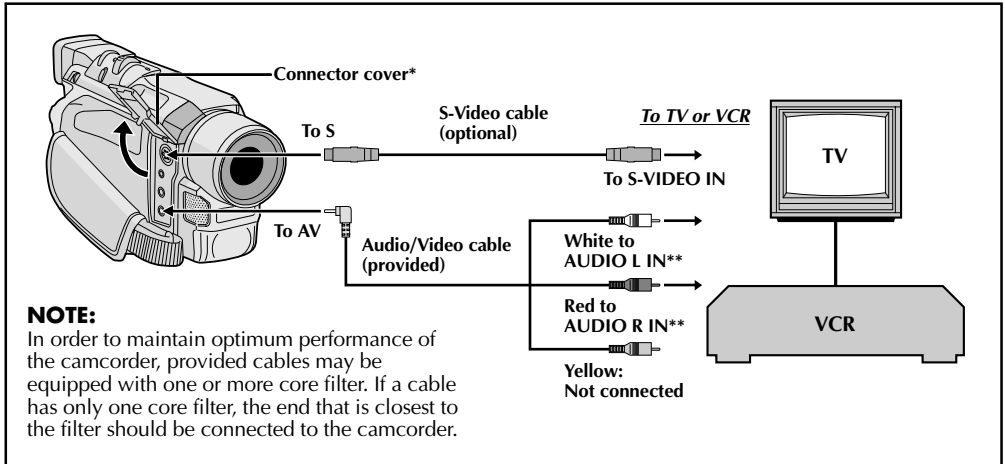

\* When connecting the cables, open this cover.

\*\* The Audio cable is not required for watching still images only.

### B. Connection to a TV or VCR equipped only with A/V input connectors

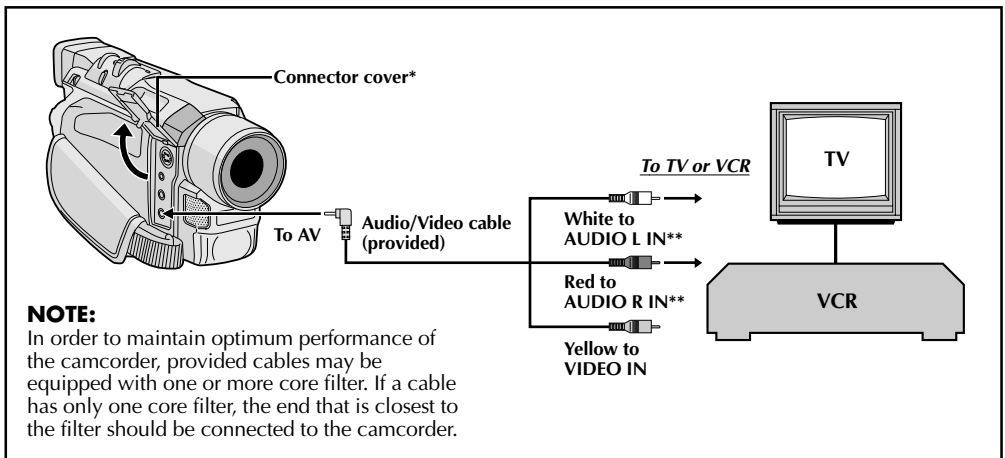

\* When connecting the cables, open this cover.

\*\* The Audio cable is not required for watching still images only.

- 1** Make sure all units are turned off.
- 2** Connect the camcorder to a TV or VCR as shown in the illustration (☞ pg. 20).  
**If using a VCR . . . go to step 3.**  
**If not . . . go to step 4.**
- 3** Connect the VCR output to the TV input, referring to your VCR's instruction manual.
- 4** Turn on the camcorder, the VCR and the TV.
- 5** Set the VCR to its AUX input mode, and set the TV to its VIDEO mode.

**To choose whether or not the following displays appear on the connected TV . . .**

- Date/Time  
.... set "DATE/TIME" to "AUTO", "ON" or "OFF" in the Menu Screen (☞ pg. 35).
- Time Code  
.... set "TIME CODE" to "ON" or "OFF" in the Menu Screen (☞ pg. 35).
- Playback Sound Mode, Tape Speed And Tape Running Displays for video playback  
.... set "ON SCREEN" to "LCD" or "LCD/TV" in the Menu Screen (☞ pg. 35).

**NOTES:**

- **It is recommended to use the AC Adapter as the power supply instead of the battery pack** (☞ pg. 8).
- **The S-Video cable is optional. Be sure to use the YTU94146A S-Video cable.**  
**Consult the JVC Service Center described on the sheet included in the package for details on its availability. Make sure to connect the end with a core filter to the camcorder. The core filter reduces interference.**
- **To monitor the picture and sound from the camcorder without inserting a tape, set the camcorder's Power Switch to "A" or "M", then set your TV to the appropriate input mode.**
- **Make sure you adjust the TV sound volume to its minimum level to avoid a sudden burst of sound when the camcorder is turned on.**
- **If you have a TV or speakers that are not specially shielded, do not place the speakers adjacent to the TV as interference will occur in the camcorder playback picture.**

**ADVANCED FEATURES****CONTENTS**

<b>FOR RECORDING</b> .....	23 – 30
Snapshot .....	23
Night-Alive .....	24
Program AE With Special Effects .....	24 – 25
Fade/Wipe Effects .....	26 – 27
Auto Focus/Manual Focus .....	28
Exposure Control .....	29
Iris Lock .....	29
White Balance Adjustment .....	30
Manual White Balance Operation .....	30
<b>USING THE MENU FOR DETAILED ADJUSTMENT</b> .....	31 – 36
For Recording Menu .....	31 – 34
For Playback Menu .....	35 – 36
<b>DUBBING</b> .....	37 – 38
Dubbing To A VCR .....	37
Dubbing To Or From A Video Unit With A DV Connector .....	38
<b>USING THE REMOTE CONTROL UNIT</b> .....	39 – 47
Installing The Batteries/Installing The Battery .....	39
Playback Zoom .....	41
Random Assemble Editing .....	42 – 45
For More Accurate Editing .....	46
Audio Dubbing .....	47
<b>SYSTEM CONNECTIONS</b> .....	48 – 49
Connection To A Personal Computer .....	48
Connection To A Video Unit With A DV Connector .....	49

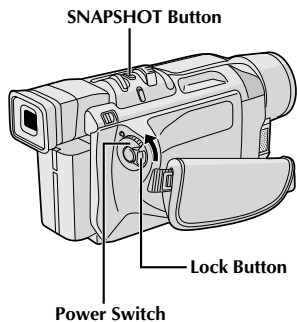

Display

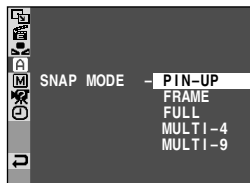

Menu Screen



**PIN-UP**  
Pin-Up mode\*



**FRAME**  
Snapshot mode with frame\*



**FULL**  
Snapshot mode with no frame\*

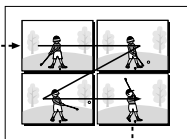

**MULTI-4**  
Multi-Analyzer 4

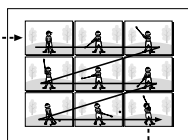

**MULTI-9**  
Multi-Analyzer 9

## Snapshot

This feature lets you record still images that look like photographs onto a tape.

### SNAPSHOT MODE SELECTION

- 1** Set the Power Switch to "M" while pressing down the Lock Button located on the switch.
- 2** Press the MENU/BRIGHT wheel in. The Menu Screen appears.
- 3** Rotate the MENU/BRIGHT wheel to select "A CAMERA". Press it and the CAMERA Menu appears.
- 4** Rotate the MENU/BRIGHT wheel to select "SNAP MODE", then press it.
- 5** Rotate the MENU/BRIGHT wheel to select the desired Snapshot mode, then press it.  
Rotate the MENU/BRIGHT wheel to select "RETURN" and press it twice. The Menu Screen closes.

### SNAPSHOT RECORDING

- 1** Press **SNAPSHOT**.  
*If you press during Record-Standby . . .*  
..... "PHOTO" appears and a still image will be recorded for approx. 6 seconds, then the camcorder re-enters the Record-Standby mode.  
*If you press during Recording . . .*  
..... "PHOTO" appears and a still image will be recorded for approx. 6 seconds, then the normal recording resumes.
- Regardless of the Power Switch position ("A" or "M"), Snapshot recording takes place using the selected Snapshot mode.

#### Motor Drive Mode

Keeping **SNAPSHOT** pressed provides an effect similar to serial photography. (Interval between still images: approx. 1 second)

#### NOTES:

- To remove the shutter sound, (☞) "BEEP" on pg. 31, 33.
- Even if "MULTI-4" or "MULTI-9" is engaged, Snapshot recording will be performed in the FULL mode during Digital Zoom or Night-Alive (☞ pg. 24).
- If Snapshot recording is not possible, "PHOTO" blinks when **SNAPSHOT** is pressed.
- If Program AE with special effects (☞ pg. 24) is engaged, certain modes of Program AE with special effects are disabled during Snapshot recording. In such a case, the icon blinks.
- If **SNAPSHOT** is pressed when "DIS" is set to "ON" (☞ pg. 32), the Stabilizer will be disabled.
- During Snapshot recording, the image displayed in the viewfinder may be partially missing. However, there is no effect in the recorded image.
- When a cable is connected to the AV connector, the shutter sound is not heard from the speaker, however it is recorded onto the tape.
- **PHOTO** will appear while the snapshot is being taken.
- During playback as well, all Snapshot modes are available. The shutter sound is not heard.

\* There is the sound effect of a shutter closing.

**NOTES:**

- During Night-Alive, the following functions or settings cannot be activated and its indicator blinks or goes out:
  - Some modes of "Program AE With Special Effects" (☞ pg. 24, 25), "Picture Wipe/Dissolve" (☞ pg. 26, 27).
  - "GAIN UP" in CAMERA MENU (☞ pg. 32).
  - "DIS" in MANUAL MENU (☞ pg. 32).
  - "Video light" when **LIGHT OFF/AUTO/ON** is set to "AUTO" (☞ pg. 16).
- During Night-Alive, it may be difficult to bring the camcorder into focus. To prevent this, use of a tripod is recommended.

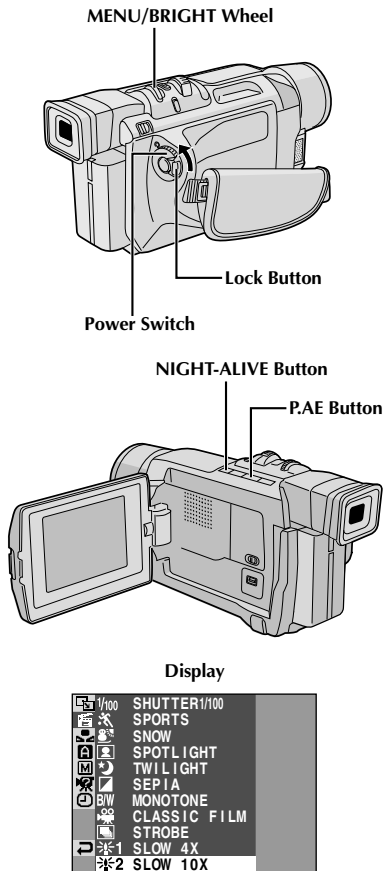
**Night-Alive**

Makes dark subjects or areas even brighter than they would be under good natural lighting. Although the recorded image is not grainy, it may look as if it is strobing due to the slow shutter speed.

- 1 Set the Power Switch to "M" while pressing down the Lock Button located on the switch.
- 2 Press **NIGHT-ALIVE** so that the Night-Alive indicator "A" appears.
  - The shutter speed is automatically adjusted to provide up to 30 times sensitivity.
  - "A" appears beside "A" while the shutter speed is being automatically adjusted.

**To Deactivate Night-Alive . . .**

.... press **NIGHT-ALIVE** again so that the Night-Alive indicator disappears.

**Program AE With Special Effects**

- 1 Set the Power Switch to "M" while pressing down the Lock Button located on the switch.
- 2 Press the **MENU/BRIGHT** wheel in. The Menu Screen appears.
- 3 Rotate the **MENU/BRIGHT** wheel to select "PROGRAM AE", then press it.
- 4 Rotate the **MENU/BRIGHT** wheel to select the desired mode (☞ pg. 25), then press it. Selection is complete. Press the **MENU/BRIGHT** wheel in again. The Menu Screen closes.
- 5 Press **P.AE** so that the selected effect indicator appears.

**To Deactivate The Selected Mode . . .**

.... press **P.AE** again so that the effect indicator disappears.

**NOTES:**

- Program AE with special effects can be changed during recording or during Record-Standby.
- Some modes of Program AE special effects cannot be used during Night-Alive.

**IMPORTANT:**

Some modes of Program AE with special effects cannot be used with certain Fade/Wipe Effects (☞ pg. 26, 27). If an unusable mode is selected, its indicator blinks or goes out.



**SHUTTER**

**1/60**—The shutter speed is fixed at 1/60th of a second. Black bands that usually appear when shooting a TV screen become narrower.

**1/100**—The shutter speed is fixed at 1/100th of a second. The flickering that occurs when shooting under a fluorescent light or mercury-vapor lamp is reduced.



 **SPORTS**  
(Variable Shutter  
Speed: 1/250 –  
1/4000)

This setting allows fast-moving images to be captured one frame at a time, for vivid, stable slow-motion playback. The faster the shutter speed, the darker the picture becomes. Use the shutter function under good lighting conditions.

 **SNOW**

Compensates for subjects that may otherwise appear too dark when shooting in extremely bright surroundings such as in the snow.

 **SPOTLIGHT**

Compensates for subjects that may otherwise appear too bright when shooting under extremely strong direct lighting such as spotlights.

**NOTE:**

“SPOTLIGHT” has the same effect as -3 with the exposure control (☞ pg. 29).

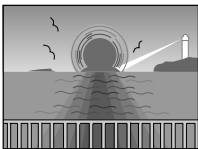

 **TWILIGHT**

Makes evening scenes look more natural.

White Balance (☞ pg. 30) is initially set to , but can be changed to your desired setting. When Twilight is chosen, the camcorder automatically adjusts the focus from approx. 10 m (32 ft) to infinity. From less than 10 m (32 ft), adjust the focus manually.

 **SEPIA**

Recorded scenes have a brownish tint like old photos. Combine this with the Cinema mode for a classic look.

**B/W MONOTONE**

Like black and white films, your footage is shot in B/W. Used together with the Cinema mode, it enhances the “classic film” effect.



 **CLASSIC FILM**

Gives recorded scenes a strobe effect.



 **STROBE**

Your recording looks like a series of consecutive snapshots.

**SLOW (Slow Shutter)**

Lights dark subjects or areas even brighter than they would be under good natural lighting. Use “SLOW” only in dark areas.

 **1 SLOW 4X**

Slow Shutter raises light sensitivity to allow shooting in dark environments.

 **2 SLOW 10X**

Slow Shutter raises light sensitivity further to allow shooting in even darker environments.

**NOTES:**

- When using “SLOW”, the image takes on a strobe-like effect.
- If the manual focus indicator blinks when “SLOW” is used, adjust focus manually and use a tripod.



 **VIDEO ECHO**

Adds a “ghost” to the subject, giving your recording a “fantasy” feeling. Zoom magnification of over 10X is not available.

## Fade/Wipe Effects

These effects let you make pro-style scene transitions. Use them to spice up the transition from one scene to the next. You can also vary transitions from scene to scene.

### IMPORTANT:

*Some Fade/Wipe Effects cannot be used with certain modes of Program AE with special effects (☞ pg. 24, 25). If an unusable Fade/Wipe Effect is selected, its indicator blinks or goes out.*

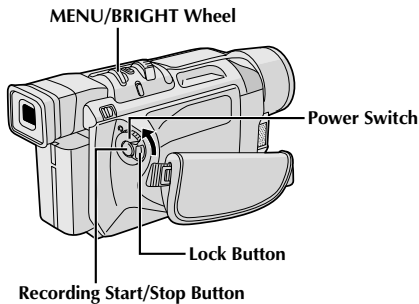

## FADE/WIPE SELECTION (☞, ☞, ☞, ☞, ☞, ☞ and ☞)

Fade or Wipe works when video recording is started or when you stop recording.

- 1** Set the Power Switch to “**M**” while pressing down the Lock Button located on the switch.
- 2** Press the **MENU/BRIGHT** wheel in. The Menu Screen appears.
- 3** Rotate the **MENU/BRIGHT** wheel to select “**☞** WIPE/FADER”, then press it.
- 4** Rotate the **MENU/BRIGHT** wheel to select the desired function, then press it. Selection is complete. Press the **MENU/BRIGHT** wheel in again.
  - The WIPE/FADER Menu disappears and the effect is reserved. The indicator representing the selected effect appears.
- 5** Press the Recording Start/Stop Button to activate the Fade-in/out or Wipe-in/out.

### To Deactivate The Selected Effect . . .

.... select “OFF” in step 4.

## PICTURE WIPE OR DISSOLVE SELECTION (☞P, ☞P, ☞P, ☞P, ☞P and ☞P)

















The Picture Wipe or Dissolve works when video recording is started.

- 1** Follow steps **1** through **4** above.
- 2** *If you select Picture Wipe/Dissolve during recording . . .*
  - .... press the Recording Start/Stop Button when one scene is finished. The point at which the scene ended is stored in memory.*If you select Picture Wipe/Dissolve during Record-Standby mode . . .*
  - .... press the Recording Start/Stop Button to start recording and press it again when one scene is finished. The point at which the scene ended is stored in memory.*If you select Picture Wipe/Dissolve during Record-Standby mode after performing a Picture Wipe/Dissolve . . .*
  - .... the point at which the scene ended is already stored in memory.
- 3** If you start recording a new scene within 5 minutes of the end of the previous recording (without having turned the camcorder’s power off), the previous scene wipes out, revealing the new scene.

### NOTES:

- You can extend the length of a Fade or Wipe by pressing and holding the Recording Start/Stop Button.
- If the power is turned off after a scene is finished recording, the stored point is erased, disabling the Picture Wipe/Dissolve combination. When this happens, the Picture Wipe/Dissolve indicator blinks. Also note that power shuts off automatically if 5 minutes elapse in the Record-Standby mode.
- The sound at the end of the last recorded scene is not stored.
- Picture Wipe/Dissolve cannot be used while Night-Alive is being activated (☞ pg. 24).

## Fader And Wipe Menu

Menu	Effect
 <b>FADER — WHITE</b>	Fade in or out with a white screen.
 <b>FADER — BLACK</b>	Fade in or out with a black screen.
 <b>FADER — B.W</b>	Fade in to a color screen from a black and white screen, or fade out from color to black and white.
 <b>MOSAIC</b>	Fade in or out with a full-screen mosaic effect.
 <b>WIPE — CORNER</b>	Wipe in on a black screen from the upper right to the lower left corner, or wipe out from lower left to upper right, leaving a black screen.
 <b>WIPE — WINDOW</b>	The scene starts in the center of a black screen and wipes in toward the corners, or comes in from the corners, gradually wiping out to the center.
 <b>WIPE — SLIDE</b>	Wipe in from right to left, or wipe out from left to right.
 <b>WIPE — DOOR</b>	Wipe in as the two halves of a black screen open to the left and right, revealing the scene, or wipe out and the black screen reappears from left and right to cover the scene.
 <b>WIPE — SCROLL</b>	The scene wipes in from the bottom to the top of a black screen, or wipes out from top to bottom, leaving a black screen.
 <b>WIPE — SHUTTER</b>	Wipe in from the center of a black screen toward the top and bottom, or wipe out from the top and bottom toward the center leaving a black screen.
 <b>P DISSOLVE</b>	The new scene gradually appears as the old one gradually disappears.
 <b>P WIPE — CORNER</b>	The new scene wipes in over the previous one from the upper right corner to the lower left corner.
 <b>P WIPE — WINDOW</b>	The next scene gradually wipes in from the center of the screen toward the corners, covering the previous scene.
 <b>P WIPE — SLIDE</b>	The next scene gradually wipes in over the previous one from right to left.
 <b>P WIPE — DOOR</b>	The previous scene wipes out from the center to the right and left, like a door being pushed open to reveal the next scene.
 <b>P WIPE — SCROLL</b>	The new scene wipes in over the last one from the bottom of the screen to the top.
 <b>P WIPE — SHUTTER</b>	The new scene wipes in over the previous one from the center toward the top and bottom of the screen.

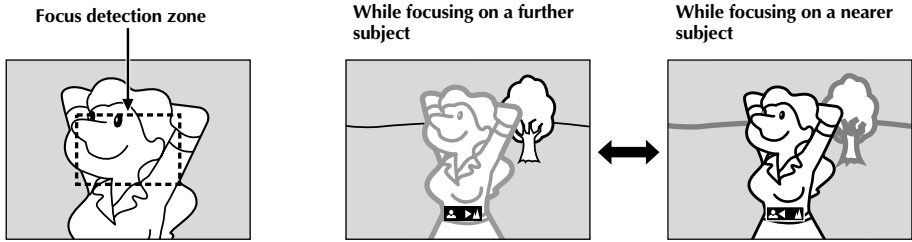

## FEATURE: Auto Focus

### PURPOSE:

The camcorder's Full Range AF system offers continuous shooting ability from close-up (as close as approx. 5 cm (2") to the subject) to infinity.

However, correct focus may not be obtainable in the situations listed below (in these cases use manual focusing):

- When two subjects overlap in the same scene.
- When illumination is low.\*
- When the subject has no contrast (difference in brightness and darkness), such as a flat, one-color wall, or a clear, blue sky.\*
- When a dark object is barely visible in the viewfinder.\*
- When the scene contains minute patterns or identical patterns that are regularly repeated.
- When the scene is affected by sunbeams or light reflecting off the surface of a body of water.
- When shooting a scene with a high-contrast background.

\* The following low-contrast warnings appear blinking: ▲, ◀, ▶ and 👤

### NOTES:

- If the lens is smeared or blurred, accurate focusing is not possible. Keep the lens clean, wiping with a piece of soft cloth if it gets dirty. When condensation occurs, wipe with a soft cloth or wait for it to dry naturally.
- When shooting a subject close to the lens, zoom out first (⏪ pg. 16). If zoomed-in in the auto focus mode, the camcorder may automatically zoom out depending on the distance between the camcorder and the subject. This will not occur when "TELE MACRO" (⏪ pg. 33) is activated.

## FEATURE: Manual Focus

### PURPOSE:

To obtain correct focus.

### OPERATION:

- 1) If you are using the viewfinder, you should already have made the necessary viewfinder adjustments (⏪ pg. 9).
- 2) Set the Power Switch to "M" while pressing down the Lock Button located on the switch, then press **FOCUS**. The manual focus indicator appears.
- 3) To focus on a farther subject, rotate the **MENU/BRIGHT** wheel towards "+". "▶" appears and blinks. To focus on a nearer subject, rotate the **MENU/BRIGHT** wheel towards "-". "◀" appears and blinks.
- 4) Press the **MENU/BRIGHT** wheel in. Focus adjustment is complete.

To reset to Auto Focus, press **FOCUS** twice or set the Power Switch to "A".

If **FOCUS** is pressed once, the camcorder will enter the focus adjustment mode again.

### NOTES:

- Be sure to focus the lens in the maximum telephoto position when you use the Manual Focus mode. If you focus in on a subject in the wide-angle position, sharply focused images cannot be obtained when zoomed up because the depth-of-field is reduced at longer focal lengths.
- When the focus level cannot be adjusted any further or closer, "▲" or "👤" will blink.

## Exposure Control

Manual exposure adjustment is recommended in the following situations:



- When shooting using reverse lighting or when the background is too bright.
- When shooting on a reflective natural background such as at the beach or when skiing.
- When the background is overly dark or the subject light.

- 1 Set the Power Switch to "M" while pressing down the Lock Button located on the switch.
- 2 Press **EXPOSURE**. The exposure control indicator appear.
- 3 Rotate the **MENU/BRIGHT** wheel towards "+" to brighten the image, or towards "-" to darken the image. (maximum  $\pm 6$ )
- 4 Press the **MENU/BRIGHT** wheel in. Exposure adjustment is complete.

### To Return To Automatic Exposure Control . . .

.... press **EXPOSURE** twice or set the Power Switch to "A". (If **EXPOSURE** is pressed once, the camcorder will enter the exposure adjustment mode again.)

### To Brighten The Subject Quickly . . .

.... press **BACKLIGHT**.  is displayed and the subject is brightened. If pressed again,  disappears and the brightness returns to the previous level.

- +3 exposure has the same effect as the **BACKLIGHT** Button.
- Using **BACKLIGHT** may cause the light around the subject to become too bright and the subject to become white.
- Backlight compensations is also available when the Power Switch is set to "A".

### NOTE:

*Backlight, spotlight (pg. 25) compensation and "SNOW" (pg. 25) have no effect when the manual Exposure Control mode is engaged.*

## Iris Lock

Use this function in the following situations:

- When shooting a moving subject.
- When the distance to the subject changes (so its size in the LCD monitor or the viewfinder changes), such as when the subject is backing away.
- When shooting on a reflective natural background such as at the beach or when skiing.
- When shooting objects under a spotlight.
- When zooming.

When the subject is close, keep the iris locked. Even when the subject moves away from you, the image will not darken or brighten.

**Before the following steps, perform steps 1 and 2 of "Exposure Control".**

- 3 Adjust zoom so that the subject fills the LCD monitor or the viewfinder, then press and hold the **MENU/BRIGHT** wheel for over 2 seconds. The exposure control indicator and "L" appear. Press the **MENU/BRIGHT** wheel in. "L" changes to "L" and the iris is locked.

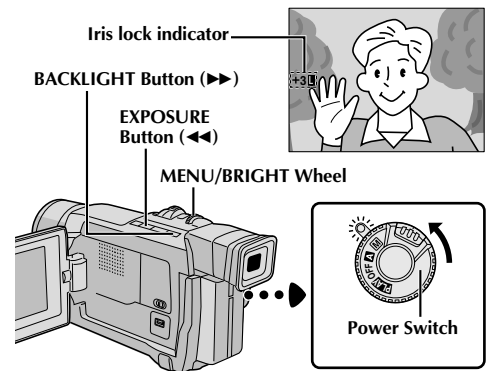

### To Return To Automatic Iris Control . . .

.... press **EXPOSURE** twice so that the exposure control indicator and "L" disappear. Or, set the Power Switch to "A".

### To Lock The Exposure Control And The Iris . . .

.... after step 2 of "Exposure Control", adjust the exposure rotating the **MENU/BRIGHT** wheel. Then lock the iris in step 3 of "Iris Lock". For automatic locking, press **EXPOSURE** twice in step 2. The iris becomes automatic after about 2 seconds.

### Iris

Like the pupil of the human eye, it contracts in well-lit environments to keep too much light from entering, and dilates in dim environments to allow in more light.

## White Balance Adjustment

A term that refers to the correctness of color reproduction under various lighting. If the white balance is correct, all other colors will be accurately reproduced.

The white balance is usually adjusted automatically. However, more advanced camcorder operators control this function manually to achieve a more professional color/tint reproduction.

- 1** Set the Power Switch to "M" while pressing down the Lock Button located on the switch.
- 2** Press the **MENU/BRIGHT** wheel in. The Menu Screen appears.
- 3** Rotate the **MENU/BRIGHT** wheel to select "W.BALANCE", then press it. The W.BALANCE Menu appears.
- 4** Rotate the **MENU/BRIGHT** wheel to select the desired mode.
 

"AUTO"	– White balance is adjusted automatically (factory preset).
"MWB"	– White balance is set manually.
"FINE"	– Outdoors on a sunny day.
"CLOUD"	– Outdoors on a cloudy day.
"HALOGEN"	– A video light or similar type of lighting is used.
- 5** Press the **MENU/BRIGHT** wheel in. Selection is complete. Press the **MENU/BRIGHT** wheel in again. The Menu Screen closes and the selected mode indicator except "AUTO" appears.

### To Return To Automatic White Balance . . .

.... select "AUTO" in step 4. Or, set the Power Switch to "A".

### NOTE:

White balance cannot be used when Sepia or Monotone (☞ pg. 25) is activated.

## Manual White Balance Operation

Perform Manual White Balance when shooting under various types of lighting.

- 1** Follow steps 1 through 4 of the white balance adjustment, and select "MWB".
- 2** Hold a sheet of plain white paper in front of the subject. Adjust zoom or position yourself so that the white paper fills the screen.
- 3** Press the **MENU/BRIGHT** wheel in until ☑ begins blinking rapidly. When the setting is completed, ☑ resumes normal blinking.
- 4** Press the **MENU/BRIGHT** wheel in twice. The Menu Screen closes and the Manual White Balance indicator ☑ is displayed.

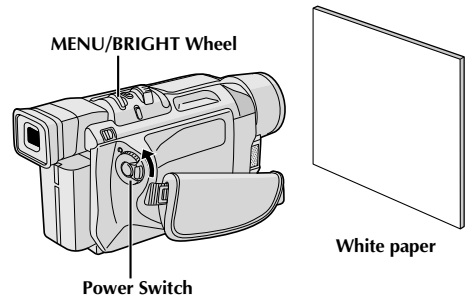

### To Change The Tint For Recording . . .

.... in step 2, substitute colored paper for white. The white balance is adjusted based on the color, changing the tint. Red paper = deeper green; blue paper = orange; yellow paper = deeper purple.

### NOTES:

- In step 2, it may be difficult to focus on the white paper. In such a case, adjust focus manually (☞ pg. 28).
- A subject can be shot under various types of lighting conditions indoors (natural, flourescent, candlelight, etc.). Because the color temperature is different depending on the light source, the subject tint will differ depending on the white balance settings. Use this function for a more natural result.
- Once you adjust white balance manually, the setting is retained even if the power is turned off or the battery removed.

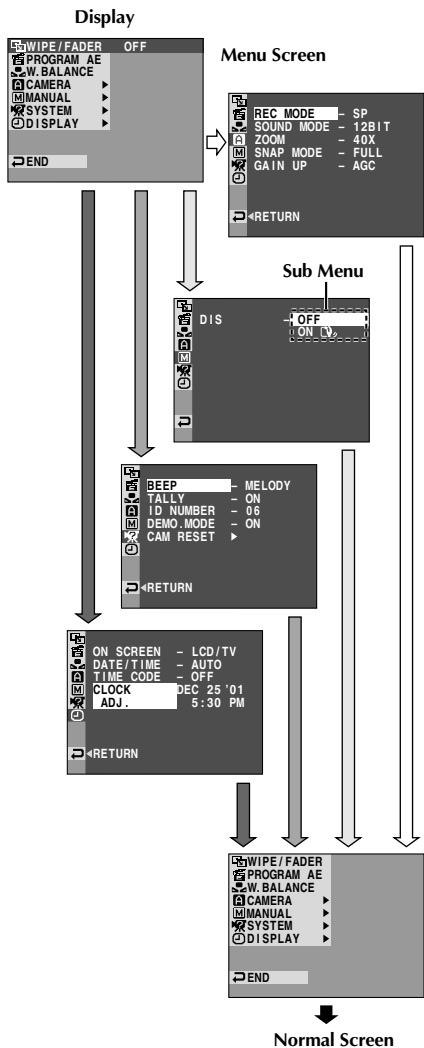
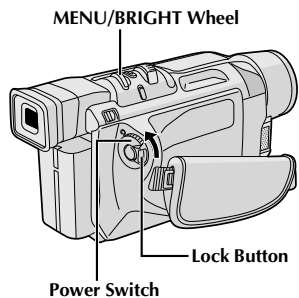







## For Recording Menu

This camcorder is equipped with an easy-to-use, on-screen menu system that simplifies many of the more detailed camcorder settings (pg. 32 – 34).

- 1 Set the Power Switch to “” while pressing down the Lock Button located on the switch.
- 2 Press the MENU/BRIGHT wheel in. The Menu Screen appears.
- 3 Rotate the MENU/BRIGHT wheel to select the desired function menu, and press it. The selected function menu appears.
- 4 Function menu setting depends on the function.
  - If you have selected “ WIPE/FADER”, “ PROGRAM AE” or “ W. BALANCE” ... see pg. 32.
  - If you have selected “ CAMERA”, “ MANUAL”, “ SYSTEM” or “ DISPLAY” ... see pg. 32.
- 5 Rotate the MENU/BRIGHT wheel to select the desired function and press it. The Sub Menu appears. Then, rotate the MENU/BRIGHT wheel to select the parameter, and press it. Selection is complete.
- 6 Rotate the MENU/BRIGHT wheel to select “ RETURN” and press it twice. The Menu Screen closes.
  - The icon represents “END”.

CONTINUED ON NEXT PAGE

## Menu Screen Explanations





 <b>WIPE/FADER</b>		Refer to “Fade/Wipe Effects” (☞ pg. 26, 27).	
 <b>PROGRAM AE</b>		Refer to “Program AE With Special Effects” (☞ pg. 24, 25).	
 <b>W.BALANCE</b>		Refer to “White Balance Adjustment” and “Manual White Balance Operation” (☞ pg. 30).	
<b>A</b> CAMERA	<b>REC MODE</b>	Allows you to set the recording mode (SP or LP) depending on your preference (☞ pg. 12).	
	<b>SOUND MODE</b>	<b>12 BIT</b>	Enables recording of stereo sound on four separate channels, and is recommended for use when performing audio dubbing. (Equivalent to the 32 kHz mode of previous models)
		<b>16 BIT</b>	Enables recording of stereo sound on two separate channels. (Equivalent to the 48 kHz mode of previous models)
	<b>ZOOM</b>	<b>10X</b>	When set to “10X” while using digital zoom, the zoom magnification will reset to 10X since digital zoom will be disengaged.
		<b>40X</b>	Allows you to use the Digital Zoom. By digitally processing and magnifying images, zooming is possible from 10X (the optical zoom limit), to a maximum of 40X digital magnification.
		<b>400X</b>	Allows you to use the Digital Zoom. By digitally processing and magnifying images, zooming is possible from 10X (the optical zoom limit), to a maximum of 400X digital magnification.
	<b>SNAP MODE</b>		Refer to “Snapshot” (☞ pg. 23).
	<b>GAIN UP</b>	<b>OFF</b>	Allows you to shoot dark scenes with no picture brightness adjustment.
		<b>AGC</b>	The overall appearance may be grainy, but the image is bright.
		<b>AUTO</b> 	The shutter speed is automatically adjusted (1/30 — 1/200 sec.). Shooting a subject in low or poor lighting at 1/30 sec. shutter speed provides a brighter image than in the AGC mode, but the subject’s movements are not smooth or natural. The overall appearance may be grainy. While the shutter speed is being automatically adjusted, “  A” is displayed.
<b>M</b> MANUAL	<b>DIS</b>	<b>OFF</b>	To compensate for unstable images caused by camera-shake, particularly at high magnification. <b>NOTES:</b> <ul style="list-style-type: none"> <li>• Accurate stabilization may not be possible if hand shake is excessive, or under the following conditions: <ul style="list-style-type: none"> <li>• When shooting subjects with vertical or horizontal stripes.</li> <li>• When shooting dark or dim subjects.</li> <li>• When shooting subjects with excessive backlighting.</li> <li>• When shooting scenes with movement in various directions.</li> <li>• When shooting scenes with low-contrast backgrounds.</li> </ul> </li> <li>• Switch off this mode when recording with the camcorder on a tripod.</li> <li>• The “,” indicator blinks or goes out if the Stabilizer cannot be used.</li> </ul>
		<b>ON</b> 	

 : Factory-preset

### NOTES:





- The “**A** CAMERA” settings are effective when the Power Switch is set to both “**A**” and “**M**”.
- The “**M** MANUAL” settings are effective only when the Power Switch is set to “**M**”.



MANUAL	TELE MACRO	OFF	Usually the distance to a subject where the lens is in focus depends on the zoom magnification. Unless there is a distance more than 1m (3.3 ft.) to the subject, the lens is out of focus at the maximum telephoto setting. When set to "ON", you can shoot a subject as large as possible at a distance of approx. 60 cm (2 ft.). • Depending on the zoom position, the lens may go out of focus.
		ON	
	WIDE MODE	OFF	Records with no change in the screen ratio. For playback on a TV with a normal screen ratio.
		CINEMA <input type="checkbox"/>	Inserts black bands at the top and bottom of the screen. During playback on wide-screen TVs, the black bands at the top and bottom of the screen are cut and the screen ratio becomes 16:9. <input type="checkbox"/> appears. When using this mode, refer to your wide-screen TV's instruction manual. During playback/recording on 4:3 TVs/LCD monitor/viewfinder, black bands are inserted at the top and bottom of the screen and the image appears like a letterboxed 16:9 movie.
		SQUEEZE <input checked="" type="checkbox"/>	For playback on TVs with an aspect ratio of 16:9. Naturally expands the image to fit the screen without distortion. <input checked="" type="checkbox"/> appears. When using this mode, refer to your wide-screen TV's instruction manual. During playback/recording on 4:3 TVs/LCD monitor/viewfinder, the image is elongated vertically.
	WIND CUT	OFF	Disengages the function which cuts down on noise created by wind.
ON 		Helps cut down on noise created by wind. " 	
SYSTEM	BEEP	OFF	Even though not heard while shooting, shutter sound is recorded on the tape.
		BEEP	The beep sounds when the power is turned on or off, and at the beginning and end of recording. Also to activate the shutter sound effect (  pg. 23).
		MELODY	Instead of a beep, a melody sounds when any operation is performed. It also activates the shutter sound effect (  pg. 23).
	TALLY	OFF	The tally lamp remains off at all times.
		ON	The tally lamp comes on to signal the start of recording.
ID NUMBER	This number is necessary when connecting the camcorder to a device such as a computer using the J terminal (JLIP). The numbers range from 01 to 99. Factory setting is 06.		

 : Factory-preset

#### NOTES:

- The " MANUAL" settings are effective only when the Power Switch is set to ".
- " SYSTEM" functions which are set when the Power Switch is set to " are also applied when the Power Switch is set to "PLAY" ( pg. 35).

## Menu Screen Explanations (cont.)

<b>SYSTEM</b>	<b>DEMO MODE</b>	<b>OFF</b>	Automatic demonstration will not take place.
		<b>ON</b>	Demonstrates certain functions such as Program AE with special effects, etc., and can be used to confirm how these functions operate. When "DEMO MODE" is set to "ON" and the Menu Screen is closed, demonstration starts. Performing any operation during the demonstration stops the demonstration temporarily. If no operation is performed for more than 1 minute after that, the demonstration will resume. <b>NOTES:</b> <ul style="list-style-type: none"> <li>● If a tape is in the camcorder, the demonstration cannot be turned on.</li> <li>● "DEMO MODE" remains "ON" even if the camcorder power is turned off.</li> <li>● If "DEMO MODE" remains "ON", some functions will not be available. After viewing demo, set to "OFF".</li> </ul>
	<b>CAM RESET</b>	<b>CANCEL</b>	Does not reset all settings to the factory-preset.
<b>EXECUTE</b>		Resets all settings to the factory-preset.	
<b>DISPLAY</b>	<b>ON SCREEN</b>	<b>LCD</b>	Keeps the camcorder's display (except the date, time and time code) from appearing on the connected TV screen.
		<b>LCD/TV</b>	Makes the camcorder's display appear on screen when the camcorder is connected to a TV.
	<b>DATE/TIME</b>	<b>OFF</b>	The date/time does not appear.
		<b>AUTO</b>	Displays the date/time for approx. 5 seconds in the following cases: <ul style="list-style-type: none"> <li>● When the Power Switch is set from "OFF" to "A" or "M".</li> <li>● When video playback starts. The camcorder displays the date/time when scenes are recorded.</li> <li>● When the date is changed during video playback.</li> </ul>
		<b>ON</b>	The date/time is always displayed.
	<b>TIME CODE</b>	<b>OFF</b>	Time code is not displayed.
		<b>ON</b>	Time code is displayed on the camcorder and on the connected TV. Frame numbers are not displayed during recording.
<b>CLOCK ADJ.</b>		Allows you to set the current date and time (☞ pg. 10).	

 : Factory-preset

### NOTES:

- "SYSTEM" and "DISPLAY" functions which are set when the Power Switch is set to "M" are also applied when the Power Switch is set to "PLAY" (☞ pg. 35). "CLOCK ADJ." only appears when the Power Switch is set to "M".
- The "DISPLAY" settings are effective even when the Power Switch is set to "A".

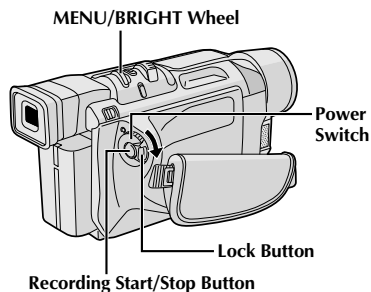

## Display

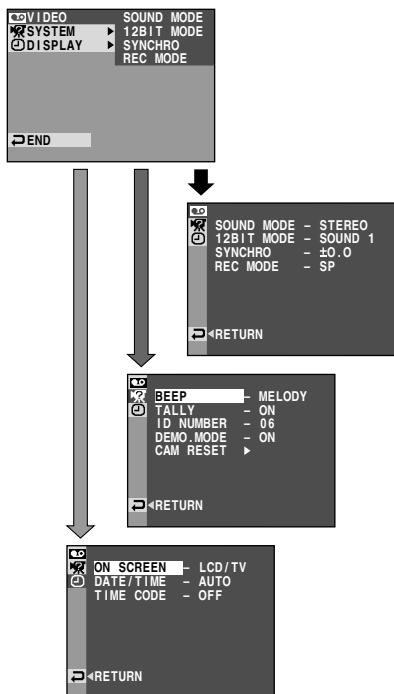

## For Playback Menu

The following procedure applies to all except *Synchro Comp* (☞ pg. 46).

- 1** Set the Power Switch to "PLAY" while pressing down the Lock Button located on the switch.
- 2** Press the MENU/BRIGHT wheel in. The Menu Screen appears.
- 3** Rotate the MENU/BRIGHT wheel to select the desired function menu, and press it. The selected function menu appears.
- 4** Rotate the MENU/BRIGHT wheel to select the desired function, and press it to display the Sub Menu.
- 5** Rotate the MENU/BRIGHT wheel to select the desired parameter and press it. Selection is complete.
- 6** Rotate the MENU/BRIGHT wheel to select "RETURN" and press it twice to close the Menu Screen.

## Menu Screen Explanations



VIDEO	SOUND MODE	☞ pg. 36.
	12BIT MODE	☞ pg. 36.
	SYNCHRO	☞ pg. 46.
	REC MODE	Allows you to set the recording mode (SP or LP) depending on your preference (☞ pg. 12). It is recommended you use "REC MODE" in the "VIDEO" Menu when using this camcorder as a recorder during digital dubbing (☞ pg. 38).
SYSTEM	Each setting is linked with "DISPLAY" or "SYSTEM", which appears when the Power Switch is set to "M" (☞ pg. 33, 34). The parameters are the same as in the description on pg. 33, 34.	
DISPLAY		

### NOTE:

"REC MODE" can be set when the Power Switch is set to "PLAY" or "M" (☞ pg. 12, 32).

## PLAYBACK SOUND

During playback, the camcorder detects the sound mode in which the recording was made, and plays the sound back. Select the type of sound to accompany your playback picture. According to the menu access explanation on pg. 35, select "SOUND MODE" or "12BIT MODE" from the Menu Screen and set it to the desired parameter.

SOUND MODE	STEREO	Sound is output on both "L" and "R" channels in stereo.
	SOUND L 	Sound from the "L" channel is output in stereo.
	SOUND R 	Sound from the "R" channel is output in stereo.
12BIT MODE	MIX	Original and dubbed sounds are combined and output in stereo on both "L" and "R" channels in stereo.
	SOUND 1	Original sound is output on both "L" and "R" channels in stereo.
	SOUND 2	Dubbed sound is output on both "L" and "R" channels in stereo.

 : Factory-preset

### NOTES:

- The "SOUND MODE" setting is available for both 12-bit and 16-bit sound. (In previous models' functions, "12-bit" is called "32 kHz" and "16-bit" is called "48 kHz".)
- The camcorder cannot detect the sound mode in which the recording was made during fast-forward or rewind. During playback the sound mode is displayed in the upper left corner.

## DISPLAY

**ON SCREEN setting:**  
For playback sound, tape speed and tape running.

12BIT/SOUND1      SP ▶

**DATE/TIME setting:**  
For date/time.

DEC 25 '01  
5:30 PM

**TIME CODE setting:**  
For time code.

 12:34:24

Minutes  
 Seconds  
 Frames\*

\*30 frames = 1 second

## Dubbing To A VCR

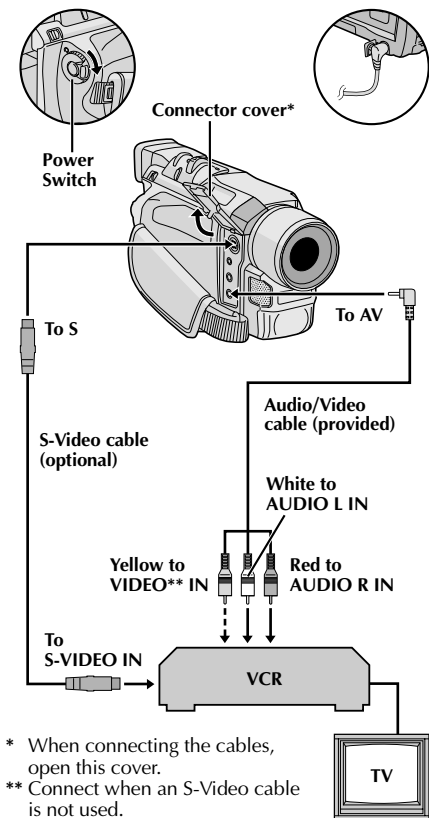

- 1** Following the illustration, connect the camcorder and the VCR. Also refer to pg. 20 and 21.
- 2** Set the camcorder's Power Switch to "PLAY" while pressing down the Lock Button located on the switch, turn on the VCR's power, and insert the appropriate cassettes in the camcorder and the VCR.
- 3** Engage the VCR's AUX and Record-Pause modes.
- 4** Engage the camcorder's Play mode to find a spot just before the edit-in point. Once it is reached, press ►/|| on the camcorder.
- 5** Press ►/|| on the camcorder and engage the VCR's Record mode.
- 6** Engage the VCR's Record-Pause mode and press ►/|| on the camcorder.
- 7** Repeat steps 4 through 6 for additional editing, then stop the VCR and camcorder when finished.

\* When connecting the cables, open this cover.

\*\* Connect when an S-Video cable is not used.

### NOTES:

- As the camcorder starts to play your footage it will appear on your TV. This will confirm the connections and the AUX channel for dubbing purposes.
- Before you start dubbing, make sure that the indications do not appear on the connected TV. If they do, they are being recorded onto the new tape.

### To choose whether or not the following displays appear on the connected TV . . .

- Date/Time  
.... set "DATE/TIME" to "AUTO", "ON" or "OFF" in the Menu Screen (☞ pg. 35).
- Time Code  
.... set "TIME CODE" to "ON" or "OFF" in the Menu Screen (☞ pg. 35).
- Playback Sound Mode, Tape Speed And Tape Running Displays  
.... set "ON SCREEN" to "LCD" or "LCD/TV" in the Menu Screen (☞ pg. 35).
- **In order to maintain optimum performance of the camcorder, provided cables may be equipped with one or more core filter. If a cable has only one core filter, the end that is closest to the filter should be connected to the camcorder.**
- **The S-Video cable is optional. Be sure to use the YTU94146A S-Video cable. Consult the JVC Service Center described on the sheet included in the package for details on its availability. Make sure to connect the end with a core filter to the camcorder. The core filter reduces interference.**
- You can use Playback Zoom (☞ pg. 41) in step 5.

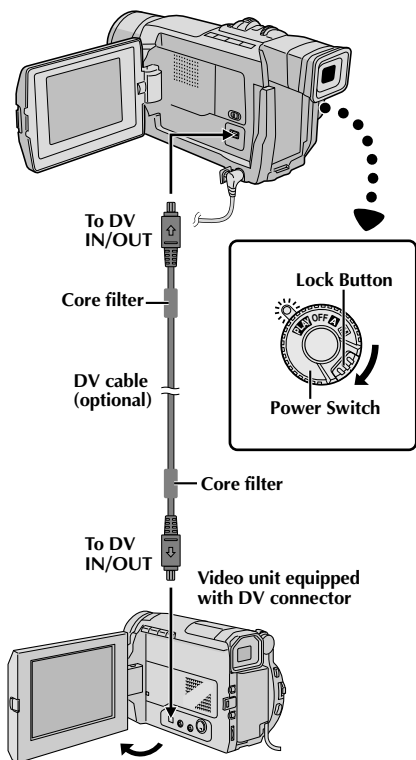

## Dubbing To Or From A Video Unit Equipped With A DV Connector (Digital Dubbing)

It is also possible to copy recorded scenes from the camcorder onto another video unit equipped with a DV connector. Since a digital signal is sent, there is little if any image or sound deterioration.

### [To use this camcorder as a player]

- 1** Make sure all units are turned off. Connect the camcorder to a video unit equipped with a DV input connector using a DV cable as shown in the illustration.
- 2** Set the camcorder's Power Switch to "PLAY" while pressing down the Lock Button located on the switch, turn on the video unit's power, and insert the appropriate cassettes in the camcorder and the video unit.
- 3** Press ► to play back the source tape.
- 4** While watching the playback on the monitor, engage the DV connector-equipped video unit's record mode from the spot on the source tape you want to begin recording.

### NOTES:

- It is recommended to use the AC Adapter as the power supply instead of the battery pack (☞ pg. 8).
- If the remote control is used when both the player and recorder are JVC video units, both units will perform the same operation. To prevent this from happening, press the buttons on both units.
- If a blank portion or disturbed image is played back on the player during dubbing, the dubbing may stop so that an unusual image is not dubbed.
- Even though the DV cable is connected correctly, sometimes the image may not appear in step 4. If this occurs, turn off the power and make connections again.
- If "Playback Zoom" (☞ pg. 41) or "Snapshot" is attempted during playback, only the original playback image recorded on the tape is output from the DV IN/OUT connector.
- When using a DV cable, be sure to use the optional JVC VC-VDV204U DV cable.

### To Use This Camcorder As A Recorder . . .

1. Set the Power Switch to "PLAY" while pressing down the Lock Button located on the switch.
2. Set "REC MODE" to "SP" or "LP" in the Menu Screen (☞ pg. 35).
3. Connect the DV cable as shown in the illustration and load a cassette to record on.
4. Press the Recording Start/Stop button to engage the Record-Pause mode. "DV.IN" appears on the screen.
5. Press the Recording Start/Stop button to start recording. ⏪ rotates.
6. Press the Recording Start/Stop button again to engage the Record-Pause mode. ⏩ stops rotating.

### NOTES:

- Digital Dubbing is performed in the sound mode recorded on the original tape, regardless of the current "SOUND MODE" setting (☞ pg. 32).
- During Digital Dubbing, no signals are output from the video or audio connectors.

The Full-Function Remote Control Unit can operate this camcorder from a distance as well as the basic operations (Playback, Stop, Pause, Fast-Forward and Rewind) of your VCR. It also makes additional playback functions possible.

If you want to perform Random Assemble Editing (☞ pgs. 42 – 46), use the optional RM-V700U remote control.

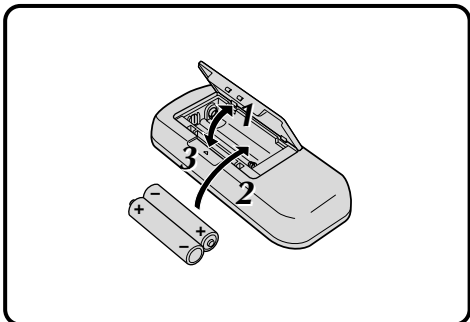

## Installing The Batteries (RM-V715U, provided)

The remote control uses two “AAA (R03)” size batteries. See “General Battery Precautions” (☞ pg. 63).

- 1** Open the battery compartment cover as illustrated.
- 2** Insert two “AAA (R03)” size batteries in the correct direction.
- 3** Replace the battery compartment cover.

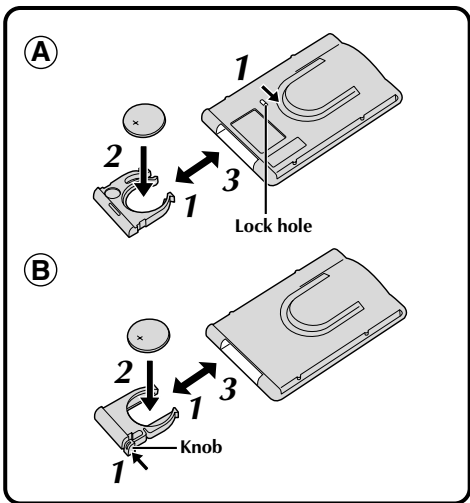

## Installing The Battery (RM-V700U, optional)

The remote control uses one lithium battery (CR2025).

- 1** There are 2 ways to pull the battery holder out of the RM-V700U.
  - Ⓐ : Pull out the battery holder while sliding the lock hole.
  - Ⓑ : Pinch the release tab and pull out the battery holder.
- 2** Insert the battery in the holder, and be sure to have the “+” mark visible.
- 3** Slide the holder back in until you hear a click.
  - Read the caution concerning lithium batteries in the RM-V700U instruction manual.

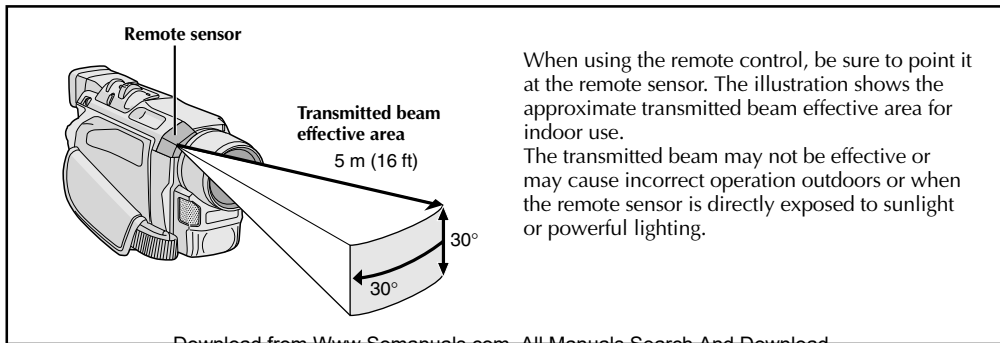

When using the remote control, be sure to point it at the remote sensor. The illustration shows the approximate transmitted beam effective area for indoor use.

The transmitted beam may not be effective or may cause incorrect operation outdoors or when the remote sensor is directly exposed to sunlight or powerful lighting.

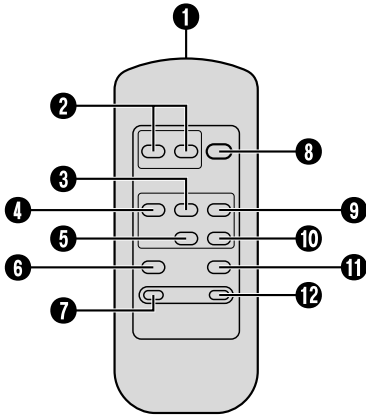

RM-V715U  
(Provided)

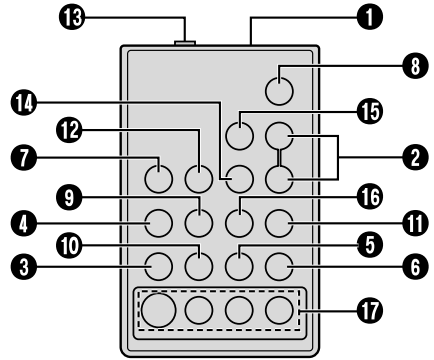

RM-V700U  
(optional)

Buttons	Functions	
	With the camcorder's Power Switch set to the camera position ("A" or "M").	With the camcorder's Power Switch set to "PLAY".
1 Infrared beam transmitting window	Transmits the beam signal.	
2 ZOOM (T/W) Buttons	Zoom in/out (☞ pg. 16)	Zoom in/out (☞ pg. 41)
3 PLAY Button	—	Playback start (☞ pg. 18)
4 REW Button	—	Rewind, Reverse Shuttle Search (☞ pg. 18)
5 STOP Button	—	Stops (☞ pg. 18)
6 INSERT Button*	—	—
7 REC TIME Button* ANIM. Button*	—	
8 START/STOP Button	Functions the same as the Recording Start/Stop Button on the camcorder.	
9 FF Button	—	Forward, Forward Shuttle Search (☞ pg. 18)
10 PAUSE Button	—	Pause (☞ pg. 45)
11 A.DUB Button	—	☞ pg. 47
12 INT. TIME Button* SELF TIMER Button*	—	
13 PAUSE IN Connector	—	☞ pg. 43
14 MBR SET Button	—	☞ pg. 42
15 VISS Button*	—	
16 VCR CTL Button	—	☞ pg. 42
17 R.A.EDIT Buttons	—	☞ pg. 42 – 46

\*This function is unavailable with this camcorder.

13 – 17: RM-V700U only



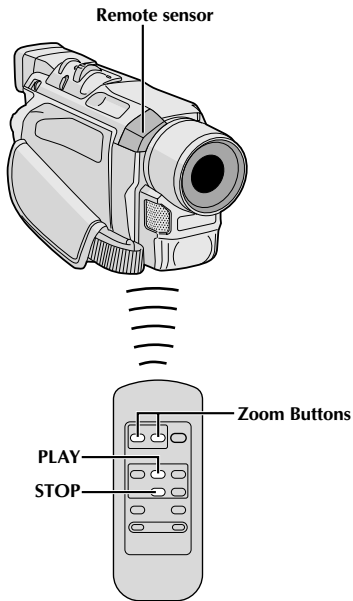

## FEATURE: Playback Zoom

### PURPOSE:

To magnify the recorded image up to 40X at any time during playback.

### OPERATION:

- 1) Press **PLAY** (▶) to find the scene of interest.
- 2) Press the Zoom Buttons (**T/W**) on the remote control. Make sure the remote control is pointed at the camcorder's remote sensor. Pressing **T** zooms in.
  - To end zoom, press and hold **W** until magnification returns to normal. Or, press **STOP** (■) and then press **PLAY** (▶).

### NOTES:

- Zoom can also be used during still playback.
- Due to digital image processing, the quality of the image may suffer.



Normal playback



Press T

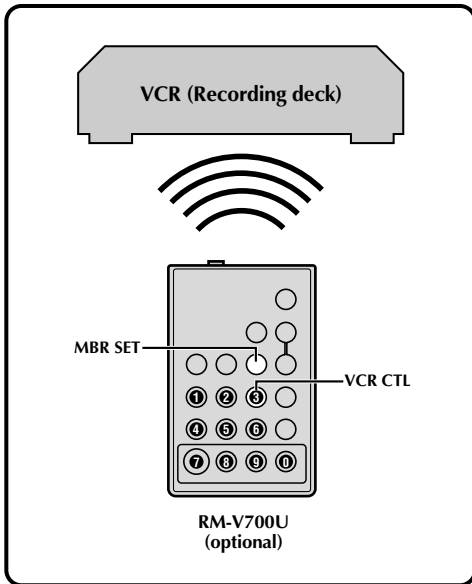

## VCR CODE LIST

VCR BRAND NAME	BUTTONS (A) (B)	VCR BRAND NAME	BUTTONS (A) (B)
GE	1 1	PHILIPS	3 3
	9 2		7 2
	9 0	PANASONIC	1 3
	9 4		1 7
HITACHI	6 6		1 1
	6 3		9 4
JVC A	9 1	RCA	1 8
	9 6		9 2
	B		9 4
C	9 3		6 6
MAGNAVOX	9 5	6 3	
	1 1	9 0	
	7 1	SANYO	3 6
	7 6		3 5
MITSUBISHI	6 7	SHARP	1 5
	6 8		1 0
NEC	3 7	SONY	6 5
	3 8		6 0
PHILIPS	1 9		3 9
	9 5		3 1
	1 1	TOSHIBA	6 9
	9 4		6 1
	9 1	ZENITH	1 6
	9 6		
1 2			

## Random Assemble Editing [R.A.Edit]

Create edited videos easily using your camcorder as the source player. You can select up to 8 "cuts" for automatic editing, in any order you like. R.A.Edit is more easily performed when the MBR (Multi-Brand Remote) is set to operate with your brand of VCR (see VCR CODE LIST), but can also be performed by operating the VCR manually.

Use the optional RM-V700U remote control.

Before operation, make sure the battery is installed in the remote control (☞ pg. 39).

## SET REMOTE/VCR CODE

**1** Turn off the power to the VCR and point the remote towards the VCR's infrared sensor. Then, referring to the VCR CODE LIST, press and hold **MBR SET**, and press button (A) and then (B). The code is automatically set once you release **MBR SET**, and the VCR's power comes on.

**2** Make sure the VCR's power is on. Then, while holding **VCR CTL**, press the button on the remote for the desired function. The functions the remote can control are PLAY, STOP, PAUSE, FF, REW and VCR REC STBY (you do not need to press **VCR CTL** for this one).

*You are now ready to try Random Assemble Editing.*

## IMPORTANT

Although the MBR is compatible with JVC VCRs and those of many other makers, it may not work with yours or may offer limited functions.

## NOTES:

- If the VCR's power does not come on in step 1, try another code from the VCR CODE LIST.
- Some brands of VCR do not come on automatically. In this case, turn the power on manually and try step 2.
- If the remote control is not able to control the VCR, use the controls on the VCR.
- When the remote control's batteries run out, the VCR brand you have set will be erased. In that case, replace the old battery with a new one to reset the VCR brand.

## MAKE CONNECTIONS

Also refer to pg. 20 and 21.

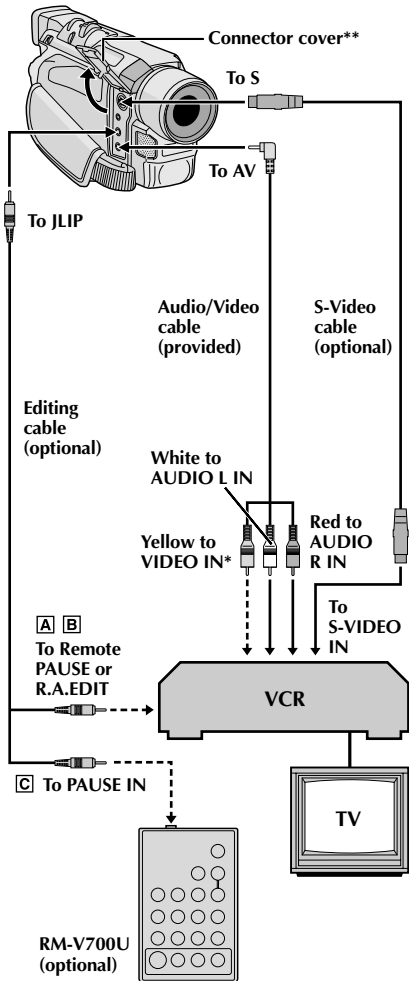

\* Connect when an S-Video cable is not used.  
 \*\* When connecting cables, open this cover.

1

**A** A JVC VCR equipped with a remote pause connector . . .

... connect the editing cable to the Remote PAUSE connector.

**B** A JVC VCR not equipped with a remote pause connector but equipped with an R.A. EDIT connector . . .

... connect the editing cable to the R.A.EDIT connector.

**C** A VCR other than above . . .

... connect the editing cable to the remote control's PAUSE IN connector.

2

Insert a recorded tape into the camcorder. Set the Power Switch to "PLAY" while pressing down the Lock Button located on the switch.

3

Turn the VCR power on, insert a recordable tape and engage the AUX mode (refer to the VCR's instructions).

CONTINUED ON NEXT PAGE

## NOTES:

• Before Random Assemble Editing, make sure the indications do not appear on the TV monitor. If they do, they will be recorded onto the new tape.

**To choose whether or not the following displays appear on the connected TV . . .**

- Date/Time  
 .... set "DATE/TIME" to "AUTO", "ON" or "OFF" in the Menu Screen (☞ pg. 35).
- Time Code  
 .... set "TIME CODE" to "ON" or "OFF" in the Menu Screen (☞ pg. 35).
- Playback Sound Mode, Tape Speed And Tape Running Displays  
 .... set "ON SCREEN" to "LCD" or "LCD/TV" in the Menu Screen (☞ pg. 35).
- In order to maintain optimum performance of the camcorder, provided cables may be equipped with one or more core filter. If a cable has only one core filter, the end that is closest to the filter should be connected to the camcorder.
- The S-Video cable and the Editing cable are optional. Be sure to use the following cables:
  - YTU94146A S-Video cable.
  - YTU94154A Editing cable.
 Consult the JVC Service Center described on the sheet included in the package for details on its availability. Make sure to connect the end with a core filter to the camcorder. The core filter reduces interference.
- When editing on a VCR equipped with a DV input connector, an optional DV cable can be connected instead of an S-Video cable and audio/video cable.



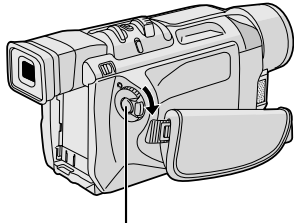

Recording Start/Stop Button

	IN	OUT	MODE
1	00:25	02:05	---
2	07:18	08:31	---
3	03:33	05:53	---
4	09:30	13:15	---
5	15:55	16:29	---
6	---	---	---
7	---	---	---
8	---	---	---
TIME CODE		16:30	
TOTAL		9:39	

Random Assemble Editing Menu

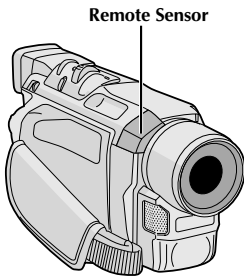

Remote Sensor

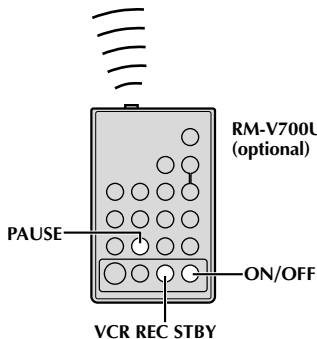

RM-V700U (optional)

PAUSE

ON/OFF

VCR REC STBY

## AUTOMATIC EDITING TO VCR

**8** Rewind the tape in the camcorder to the beginning of the scene you want to edit and press **PAUSE (II)**.

**9** Point the remote control towards the VCR's remote sensor and press **VCR REC STBY (●II)**, or manually engage the VCR's Record-Pause mode.

**10** Press the Recording Start/Stop Button on the camcorder. Editing proceeds as programmed, right through to the end of the last registered scene.

- Pressing **START/STOP** on the remote control does not start editing.
- When dubbing is complete, the camcorder enters the Pause mode, and the VCR enters its Record-Pause mode.
- If you do not register an Edit-Out point, the tape will be dubbed all the way to the end automatically.
- If you operate the camcorder during automatic editing, the VCR will enter its Record-Pause mode and automatic editing will stop.

**11** Engage the Stop modes for the camcorder and the VCR.  
To make the R.A.Edit counter display disappear, press **ON/OFF** on the remote control.

**NOTES:**

- Pressing **ON/OFF** on the remote control clears all settings registered during Random Assemble Editing.
- When the editing cable is connected to the remote control's Pause In connector during dubbing, make sure the remote control is pointed at the VCR's sensor, and the path between the two is unobstructed.
- Random Assemble Editing may not function properly when using a tape including several duplicated time codes (☞ pg. 17).

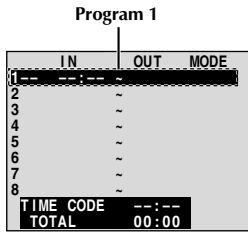

Random Assemble Editing Menu

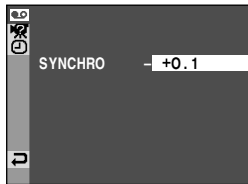

VIDEO Menu

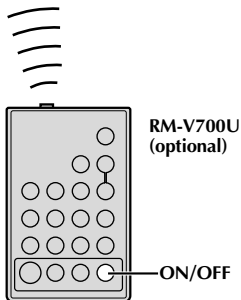
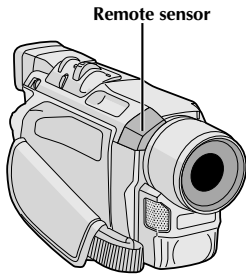

RM-V700U (optional)

ON/OFF

**NOTES:**

- Before performing actual Random Assemble Editing, do a few Random Assemble Editing trial runs to check whether the value you have input is appropriate or not, and make adjustments accordingly.
- Depending on the recorder, there may be situations where the timing difference cannot be fully corrected.

**For More Accurate Editing**

Some VCRs make the transition from Record-Pause to Record mode faster than others. Even if you begin editing for the camcorder and the VCR at exactly the same time, you may lose scenes you wanted, or find that you have recorded scenes you did not want. For a cleanly edited tape, confirm and adjust the timing of the camcorder against your VCR.

**DIAGNOSING VCR/CAMCORDER TIMING**

- 1 Play back the tape in the camcorder, then point the remote control at the camcorder's remote sensor and press **ON/OFF**. The Random Assemble Editing Menu appears.
- 2 Perform Random Assemble Editing on Program 1 only. In order to check VCR and camcorder timing, select the beginning of a scene transition as your Edit-In point.
- 3 Play back the dubbed scene.
  - If any images from the scene prior to the transition you chose for your Edit-In point were recorded, that means your VCR moves too quickly from Record-Pause to Record mode.
  - If the scene you tried to dub starts in progress, the VCR is slow to start recording.

**ADJUSTMENT OF VCR/CAMCORDER TIMING**

- 4 Point the remote control at the camcorder's remote sensor and press **ON/OFF** to make the Random Assemble Editing menu disappear, then press the **MENU/BRIGHT** wheel in. The Menu Screen appears.
- 5 Rotate the **MENU/BRIGHT** wheel to select "**VIDEO**" and push it. The VIDEO Menu appears. Then, rotate it to "SYNCHRO" and push it. The value for "SYNCHRO" is highlighted.
- 6 Based on the diagnostics performed, you can now advance the VCR's record timing by rotating the **MENU/BRIGHT** wheel towards "+". You can also delay the VCR's record timing by rotating the **MENU/BRIGHT** wheel towards "-". The adjustment range is from -1.3 to +1.3 seconds, in 0.1-second increments. Push the **MENU/BRIGHT** wheel to finish the setting.
- 7 Rotate the **MENU/BRIGHT** wheel to select "**RETURN**" and push it twice. Now perform Random Assemble Editing beginning with step 4 on page 44.

Display



Audio Dub Standby mode

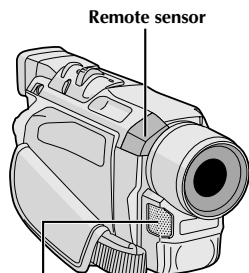
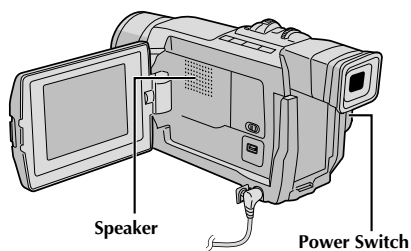

Stereo microphone

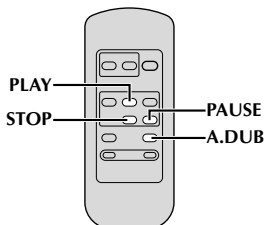

## Audio Dubbing

The audio track can be customized only when recorded in the 12-bit mode (☞ pg. 32).

### NOTES:

- Audio Dubbing is not possible on a tape recorded in 16-bit audio, on a tape recorded in the LP mode or on a blank portion of a tape.
- To perform Audio Dubbing while watching on the television, make connections (☞ pg. 20).

- 1 Play back the tape to locate the point where editing will start, then press **PAUSE (II)**.
- 2 While holding **A.DUB (⊖)** on the remote control, press **PAUSE (II)**. "II⊖" appears.
- 3 Press **PLAY (▶)**, then begin "narrating".  
Speak into the microphone.  
• To pause dubbing, press **PAUSE (II)**.
- 4 To end Audio Dubbing, press **PAUSE (II)**, then **STOP (■)**.

### To hear the dubbed sound during playback . . .

.... set "12BIT MODE" to "SOUND 2" or "MIX" in the Menu Screen (☞ pg. 35, 36).

### NOTES:

- Sound is not heard from the speaker during Audio Dubbing.
- When editing onto a tape that was recorded at 12-bit, the old and new soundtracks are recorded separately.
- If you dub onto a blank space on the tape, the sound may be disrupted. Make sure you only edit recorded areas.
- If feedback or howling occurs during TV playback, move the camcorder's microphone away from the TV, or turn down the TV's volume.
- If you change from 12-bit to 16-bit in mid-recording and then use the tape for Audio Dubbing, it is not effective from the point where 16-bit recording began.
- During Audio Dubbing, when the tape moves to scenes recorded in the LP mode, scenes recorded in 16-bit audio or a blank portion, Audio Dubbing stops (☞ pg. 62).

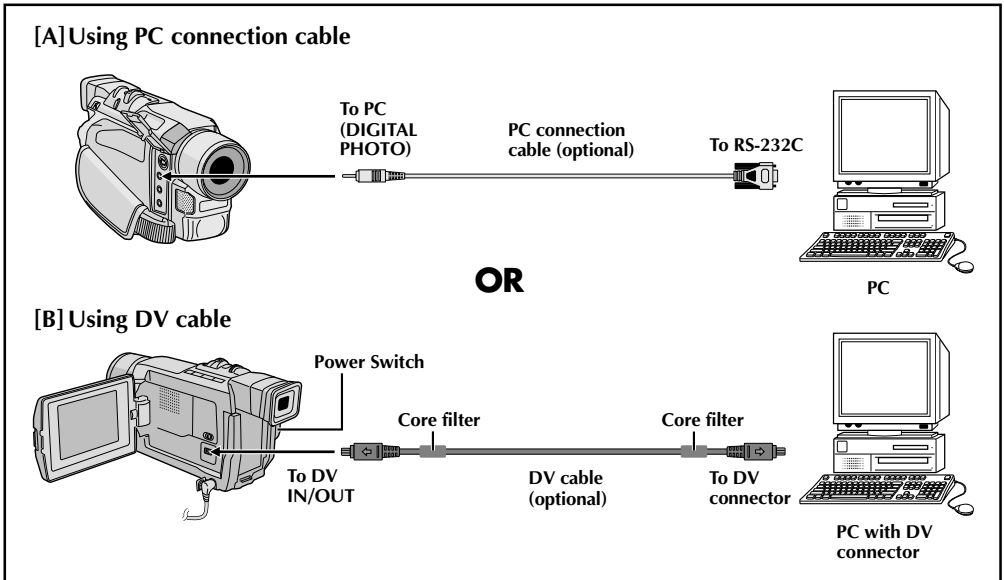

## Connection To A Personal Computer

### [A] Using PC connection cable

This camcorder can transfer still images to a PC by using the optional software HS-V16U.

### [B] Using DV cable

It is also possible to transfer still images to a PC with a DV connector by using software equipped with the PC or commercially available software.

- 1** Make sure the camcorder and PC are turned off.
- 2** Connect the camcorder to your PC using the appropriate cable as shown in the illustration.
- 3** Turn the camcorder's Power Switch to "PLAY" while pressing down the Lock Button located on the switch and turn on the PC.
  - Refer to the instruction manual of the software on how to transfer a still image to the PC.
- 4** When finished, turn off the PC first, then the camcorder.

### NOTES:

- In order to maintain optimum performance of the camcorder, provided cables may be equipped with one or more core filter. If a cable has only one core filter, the end that is closest to the filter should be connected to the camcorder.
- It is recommended to use the AC Adapter as the power supply instead of the battery pack (☞ pg. 8).
- Never connect the PC connection cable and the DV cable simultaneously to the camcorder. Connect only the cable you wish to use to the camcorder.
- The date/time information cannot be captured into the PC.
- Refer to the instruction manuals of the PC and Software.
- The still images can also be transferred to a PC with a DV connector-equipped capture board.
- When using a DV cable, be sure to use the optional JVC VC-VDV206U or VC-VDV204U DV cable depending on the type of DV connector (4 or 6 pins) on the PC, or use the DV cable provided with the capture board.
- The system may not work properly depending on the PC or capture board you are using.



## Connection To A Video Unit Equipped With A DV Connector

Connection to the GV-DT3 Digital Printer (optional) allows you to print out images or transfer them to a PC. It is also possible to copy recorded scenes from the camcorder onto another video unit equipped with a DV connector. This function is called Digital Dubbing (☞ pg. 38), which offers virtually no image or sound deterioration.

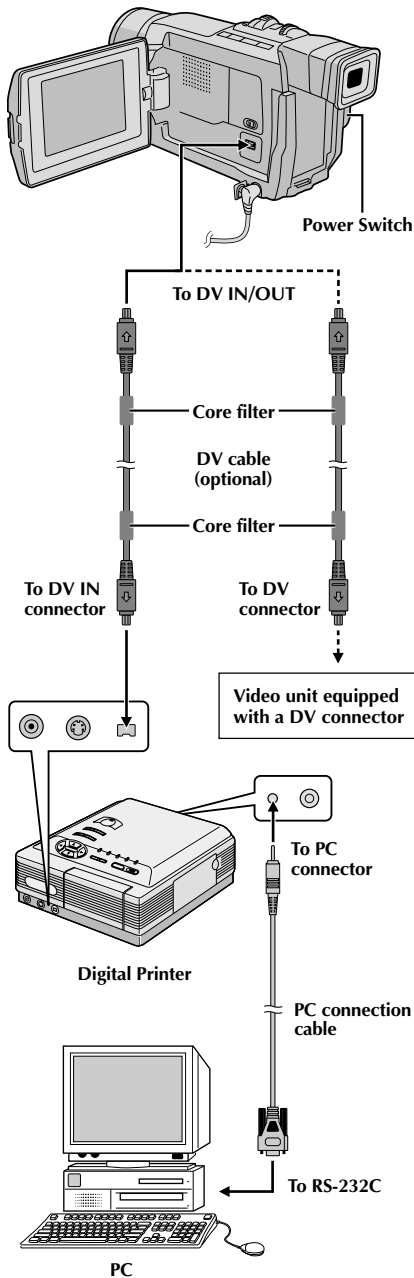

- 1** Make sure all units are turned off.
- 2** Make connections to the device you want to connect to using a DV cable, as shown in the illustration.
- 3** If necessary, connect the PC connection cable (provided with GV-DT3) to the printer's PC connector and the PC's RS-232C connector.
- 4** Turn the camcorder's Power Switch to "PLAY" while pressing down the Lock Button located on the switch and turn on the other units.

### NOTES:

- **It is recommended to use the AC Adapter as the power supply instead of the battery pack (☞ pg. 8).**
- **If Still Playback, Fast-Forward or Rewind is attempted with the camcorder connected to a video unit via the DV connector, the image will take on an effect similar to a colored mosaic pattern or it will become black.**
- **Also refer to the instruction manuals of the connected units.**
- **When using a DV cable, be sure to use the optional JVC VC-VDV204U DV cable.**

**REFERENCES****CONTENTS**

<b>DETAILS</b> .....	51
<b>TROUBLESHOOTING</b> .....	52 – 56
<b>USER MAINTENANCE</b> .....	57
<b>INDEX</b> .....	58 – 62
<b>Controls, Connectors And Indicators</b> .....	58 – 59
<b>Indications</b> .....	60 – 62
<b>CAUTIONS</b> .....	63 – 65
<b>TERMS</b> .....	66
<b>SPECIFICATIONS</b> .....	67

<b>ITEMS</b>	<b>NOTES</b>
<p>⇒ <b>Power</b> (☞ pg. 7)</p>	<ul style="list-style-type: none"> <li>○ Perform charging where the temperature is between 10°C and 35°C (50°F and 95°F). 20°C to 25°C (68°F to 77°F) is the ideal temperature range for charging. If the environment is too cold, charging may be incomplete.</li> <li>○ Charging times are for a fully discharged battery pack.</li> <li>○ Charging time varies according to the ambient temperature and the status of the battery pack.</li> <li>○ To avoid interference with reception, do not use the AC Adapter near a radio.</li> <li>○ Since the AC Adapter processes electricity internally, it becomes warm during use. Be sure to use it only in well-ventilated areas.</li> <li>○ The following operation stops charging:             <ul style="list-style-type: none"> <li>• Set the Power Switch to "<b>PLAY</b>", "<b>A</b>" or "<b>M</b>".</li> <li>• Disconnect the AC adapter from the camcorder.</li> <li>• Unplug the AC adapter from the AC outlet.</li> <li>• Detach the battery from the camcorder.</li> </ul> </li> </ul>
<p>⇒ <b>BASIC RECORDING</b> (☞ pg. 14, 15)</p>	<ul style="list-style-type: none"> <li>○ When you use the LCD monitor outdoors in direct sunlight, the LCD monitor may be difficult to see. If this happens, use the viewfinder instead.</li> <li>○ The cassette holder cannot be opened unless a power supply is attached.</li> <li>○ There may be a delay after you open the cassette holder cover until the cassette holder opens. Do not use force.</li> <li>○ Once the cassette holder is closed, it recedes automatically. Wait until it recedes completely before closing the cassette holder cover.</li> <li>○ When the Recording Start/Stop button is pressed, it may take a few seconds before actual recording starts. "⏪" starts rotating when the camcorder actually starts recording.</li> <li>○ The time required to calculate and display the remaining tape length, and the accuracy of the calculation, may vary according to the type of tape used.</li> <li>○ "TAPE END" appears when the tape reaches its end, and the power goes off automatically if left in this condition for 5 minutes. "TAPE END" also appears when a cassette at its end is loaded.</li> </ul>

If, after following the steps in the chart below, the problem still exists, please consult your nearest JVC dealer.

The camcorder is a microcomputer-controlled device. External noise and interference (from a TV, a radio, etc.) might prevent it from functioning properly. In such cases, first disconnect its power supply unit (battery pack, AC Adapter, etc.) and wait a few minutes; and then re-connect it and proceed as usual from the beginning.

SYMPTOM	POSSIBLE CAUSES	CORRECTIVE ACTION
1. No power is supplied.	1. • The power is not connected properly. • The battery is dead.	1. • Connect the AC Adapter securely (☞ pg. 8). • Replace the dead battery with a fully charged one (☞ pg. 7, 8).
2. "SET DATE/TIME!" appears.	2. • The date/time is not set. • The built-in clock battery has run out and the previously set date/time has been erased.	2. • Set the date/time (☞ pg. 10). • Consult your nearest JVC dealer for replacement.
3. Recording cannot be performed.	3. • The tape's erase protection tab is set to "SAVE". • The Power Switch is set to "PLAY" or "OFF". • "TAPE END" appears. • The cassette holder cover is open.	3. • Set the tape's erase protection tab to "REC" (☞ pg. 11). • Set the Power Switch to "A" or "M" (☞ pg. 15). • Replace with new cassette (☞ pg. 11). • Close the cassette holder cover.
4. There is no picture.	4. • The camcorder is not getting power, or some other malfunction exists.	4. • Turn the camcorder's power off and on again (☞ pg. 15).
5. The focus does not adjust automatically.	5. • Focus is set to the Manual mode. • The recording was done in a dark place, or the contrast was low. • The lens is dirty or covered with condensation.	5. • Set Focus to the Auto mode (☞ pg. 28). • Clean the lens and check the focus again (☞ pg. 57).
6. The cassette will not load properly.	6. • The cassette is in the wrong position. • The battery's charge is low.	6. • Set it in the right position (☞ pg. 11). • Install a fully charged battery (☞ pg. 7, 8).
7. Snapshot mode cannot be used.	7. • The Squeeze mode is selected.	7. • Disengage the Squeeze mode (☞ pg. 33).
8. The color of Snapshot looks strange.	8. • The light source or the subject does not include white. Or there are various different light sources behind the subject. • The Sepia or Monotone mode is activated.	8. • Find a white subject and compose your shot so that it also appears in the frame (☞ pg. 23). • Turn off Sepia and Monotone (☞ pg. 24, 25).

SYMPTOM	POSSIBLE CAUSES	CORRECTIVE ACTION
9. The image taken using Snapshot is too dark.	9. • Shooting was performed under backlit conditions.	9. • Press the <b>BACKLIGHT</b> Button (☞ pg. 29).
10. The image taken using Snapshot is too bright.	10. • The subject is too bright.	10. • Set "PROGRAM AE" to "SPOTLIGHT" in the Menu Screen (☞ pg. 24).
11. Digital Zoom does not work.	11. • 10X optical zoom is selected. • "PROGRAM AE" is set to "VIDEO ECHO" in the Menu Screen. • Picture Wipe or Dissolve are being used in a scene transition.	11. • Set "ZOOM" to "40X" or "400X" in the Menu Screen (☞ pg. 32). • Disengage the "VIDEO ECHO" mode (☞ pg. 16, 25). • Wait until the Picture Wipe or Dissolve effects are completed (☞ pg. 16, 26).
12. The Black & White Fader does not work.	12. • The Sepia or Monotone mode is activated.	12. • Turn off Sepia and Monotone (☞ pg. 24, 26).
13. The Dissolve function does not work.	13. • The Sepia, Monotone or Slow Shutter mode of Program AE with special effects is activated. • "WIDE MODE" is set to "SQUEEZE" in the Menu Screen. • The previously selected mode of Program AE with special effects was changed after the last selected scene for editing was registered.	13. • Turn off Sepia, Monotone or Slow Shutter before adding Dissolve to a scene transition (☞ pg. 24, 26). • Set "WIDE MODE" to "CINEMA" or "OFF" mode (☞ pg. 33). • Make sure you have selected the mode of Program AE with special effects you want before starting editing (☞ pg. 24, 26).
14. The Picture Wipe and Dissolve functions do not work.	14. • The last selected editing scene is ending. • At the end of the last selected scene for editing, the Power Switch was set to "OFF". • The power is off.	14. • Select Picture Wipe or Dissolve before beginning recording. The effects are then automatically activated (☞ pg. 26). • Do not turn off the camcorder's power after setting Edit-In and Edit-Out points, as they will all be erased (☞ pg. 26). • The camcorder automatically shuts off after 5 minutes have elapsed in the Record-Standby mode. Make sure you continue operations within 5 minutes after engaging Record-Standby mode (☞ pg. 26).

CONTINUED ON NEXT PAGE

SYMPTOM	POSSIBLE CAUSES	CORRECTIVE ACTION
15. The picture wipe function does not work.	15. • The Slow Shutter mode is activated. • "WIDE MODE" is not set to "OFF".	15. • Disengage the Slow Shutter mode or set "WIDE MODE" to "OFF" before preparing to use the Picture Wipe (☞ pg. 24, 26, 33).
16. Scene transition does not go as expected.	16. • When using "Picture Wipe/Dissolve" (☞ pg. 26), there is a delay of a fraction of a second between the previous record stop-point and the Dissolve start-point. This is normal, but this slight delay becomes especially noticeable when shooting fast-moving subject or during rapid panning.	16. _____
17. The Video Echo mode does not work.	17. • The Picture Wipe or Dissolve functions are in use. • "WIDE MODE" is set to "SQUEEZE" in the Menu Screen. • A Fade-In or Fade-Out is in progress.	17. • Set "WIDE MODE" to "CINEMA" or "OFF" mode (☞ pg. 33). • Do not try to use the Video Echo mode during a Fade-In or Fade-Out (☞ pg. 24, 26).
18. Even when Slow Shutter is not selected, the image looks like it is activated.	18. • When shooting in the dark, the unit becomes highly sensitive to light and the image takes on an effect similar to Slow Shutter.	18. • If you want the lighting to look more natural, set GAIN UP to "AGC" or "OFF" in the Menu Screen (☞ pg. 32).
19. There is no strobe when the Classic Film or Strobe mode is activated.	19. • The Picture Wipe or Dissolve function is in use.	19. • Do not try to use the Classic Film or Strobe mode during a scene transition (☞ pg. 24, 26).
20. White Balance cannot be activated.	20. • The Sepia or Monotone mode is activated.	20. • Turn off Sepia or Monotone before setting White Balance (☞ pg. 25, 30).
21. When shooting a subject illuminated by bright light, vertical lines appear.	21. • This is a result of exceedingly high contrast, and is not a malfunction.	21. _____
22. When the screen is under direct sunlight during shooting, the screen becomes red or black for an instant.	22. • This is not a malfunction.	22. _____
23. During recording, the date/time does not appear.	23. • "DATE/TIME" is set to "OFF" in the Menu Screen.	23. • Set "DATE/TIME" to "ON" in the Menu Screen (☞ pg. 34).
24. The indicators and messages do not appear.	24. • "TIME CODE" is set to "OFF" in the Menu Screen.	24. • Set "TIME CODE" to "ON" in the Menu Screen (☞ pg. 34, 35).

SYMPTOM	POSSIBLE CAUSES	CORRECTIVE ACTION
25. Images on the LCD monitor appear dark or whitish.	25. • In places subject to low temperature, images become dark due to the characteristics of the LCD monitor. When this happens, the displayed colors differ from those that are actually recorded. This is not a defect of the camcorder. • When the LCD monitor's fluorescent light reaches the end of its service life, images on the LCD monitor become dark. Consult your nearest JVC dealer.	25. • Adjust the brightness and angle of the LCD monitor (☞ pg. 14, 15).
26. The rear of the LCD monitor is hot.	26. • The light used to illuminate the LCD monitor causes it to become hot.	26. • Close the LCD monitor to turn it off or set the Power Switch to "OFF", and let the unit cool down.
27. The indicators and the image color on the LCD monitor are not clear.	27. • This may occur when the surface or the edge of the LCD monitor is pressed.	27. _____
28. The LCD monitor or viewfinder indications blink.	28. • Certain Fade/Wipe effects, certain modes of Program AE with special effects, "DIS" and other functions that cannot be used together are selected at the same time.	28. • Re-read the sections covering Fade/Wipe effects, Program AE with special effects and "DIS" (☞ pg. 24 – 27, 33).
29. Colored bright spots appear all over the LCD monitor or the viewfinder.	29. • The LCD monitor and the viewfinder are made with high-precision technology. However, black spots or bright spots of light (red, green or blue) may appear constantly on the LCD monitor or the viewfinder. These spots are not recorded on the tape. This is not due to any defect of the unit. (Effective dots: more than 99.99 %)	29. _____
30. During recording, sound cannot be heard.	30. • This is normal.	30. _____
31. Play, Rewind and Fast-Forward functions do not work.	31. • The Power Switch is set to "A" or "M".	31. • Set the Power Switch to "PLAY" (☞ pg. 18).

CONTINUED ON NEXT PAGE

SYMPTOM	POSSIBLE CAUSES	CORRECTIVE ACTION
32. The LCD monitor image is distorted.	32. • During playback of the unrecorded portion, High-speed Search and still playback, LCD monitor indications appear distorted. This is not a defect.	32.  _____
33. Images on the LCD monitor are jittery.	33. • The speaker volume is too great.	33. • Turn the speaker volume down (☞ pg. 18).
34. Blocks of noise appear during playback, or there is no playback picture and the screen becomes blue.	34.  _____	34. • Clean the video heads with an optional cleaning cassette (☞ pg. 64).
35. The LCD monitor, the viewfinder and the lens have become dirty (ex. fingerprints).	35.  _____	35. • Wipe them gently with soft cloth. Wiping strongly can cause damage (☞ pg. 57).
36. An unusual mark appears.	36.  _____	36. • Check the section of the manual that explains LCD monitor/viewfinder indications (☞ pg. 60 – 62).
37. An error indication (E01 — E06) appears.	37. • A malfunction of some kind has occurred. In this case the camcorder's functions become unusable.	37. • Remove the power supply (battery pack, etc.) and wait a few minutes for the indication to clear. When it does, you can resume using the camcorder. If the indication remains even though you repeat the above two or three times, please consult your nearest JVC dealer.
38. The charger indicator on the camcorder does not light.	38. • The temperature of the battery is extremely high/low. • Charging is difficult in places subject to extremely high/low temperatures.	38. • To protect the battery, it is recommended to charge it in places with a temperature of 10°C to 35°C (50°F to 95°F) (☞ pg. 63).
39. When the image is printed from the printer, a black bar appears at the bottom of the screen.	39. • This is not a malfunction.	39. • By recording with "DIS" activated (☞ pg. 32) this can be avoided.
40. When the camcorder is connected via the DV connector, the camcorder does not operate.	40. • The DV cable was plugged/unplugged with power turned on.	40. • Turn the camcorder's power off and on again, then operate it.



## After Use

- 1** Turn off the camcorder.
- 2** Slide and hold **OPEN/EJECT** in the direction of the arrow, then pull the cassette holder cover open until it locks. The cassette holder opens automatically. Remove the cassette.
- 3** Press "PUSH HERE" to close the cassette holder.
  - Once the cassette holder is closed, it recedes automatically. Wait until it recedes completely before closing the cassette holder cover.
- 4** Tilt the viewfinder upward ①. Slide **BAT. RELEASE** ② and remove the battery pack ③.

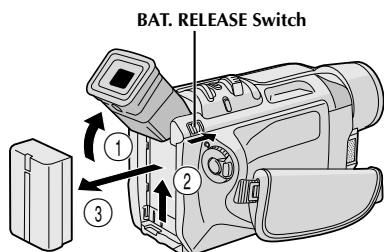
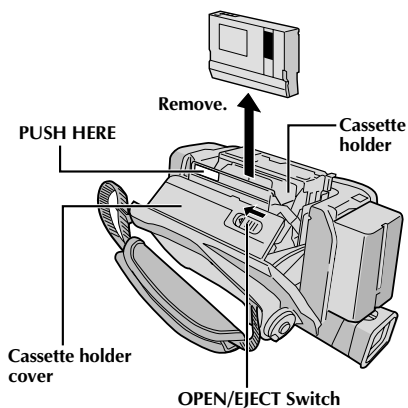

## Cleaning The Camcorder

- 1** To clean the exterior, wipe gently with a soft cloth. Put the cloth in diluted mild soap and wring it well to wipe off heavy dirt. Then wipe again with a dry cloth.
- 2** Press **PUSH-OPEN** and open the LCD monitor. Wipe gently with a soft cloth. Be careful not to damage the monitor. Close the LCD monitor.
- 3** To clean the lens, blow it with a blower brush, then wipe gently with lens cleaning paper.
- 4** To clean the viewfinder, raise it to the vertical position. Open the viewfinder cleaning hatch in the direction of the arrow ①.
- 5** Insert a lens blower or soft cloth into the gap at the bottom of the viewfinder and clean the interior of the viewfinder with it ②.
- 6** Close the hatch. Tilt the viewfinder back to the horizontal position.





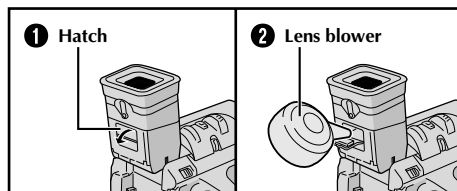
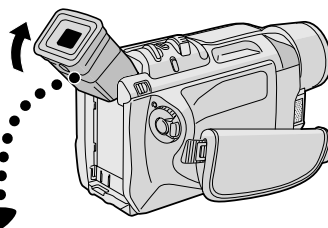

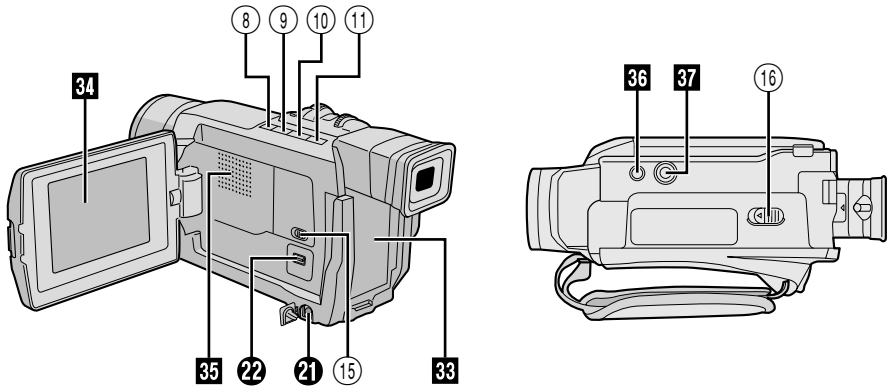
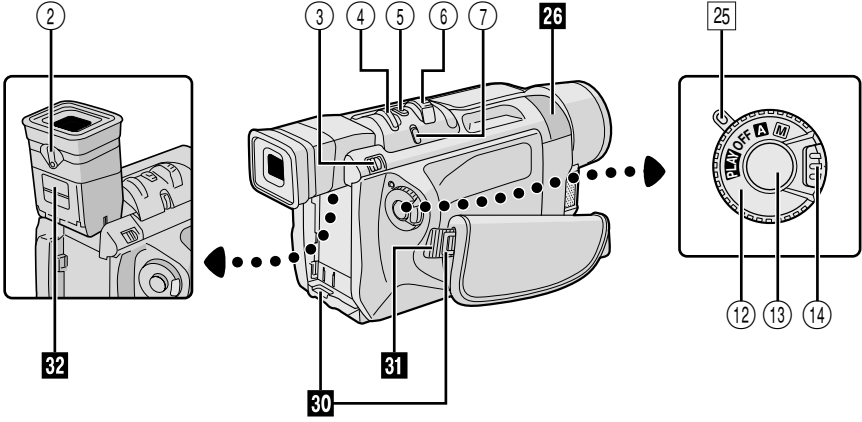
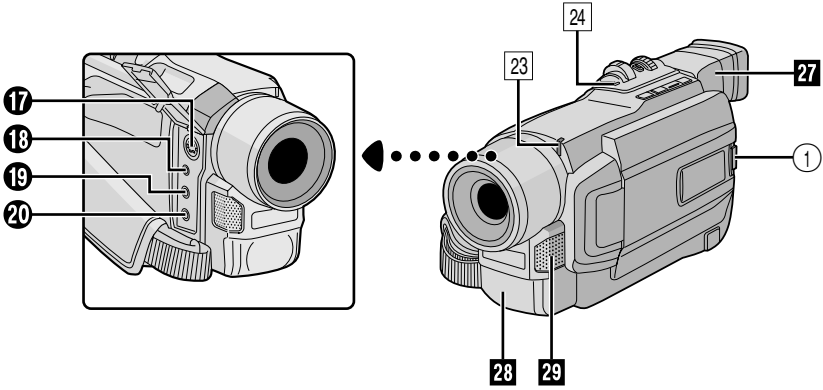















### NOTES:

- Avoid using strong cleaning agents such as benzine or alcohol.
- Cleaning should be done only after the battery pack has been removed or other power units have been disconnected.
- Mold may form if the lens is left dirty.
- When using a cleaner or chemically treated cloth refer to the cautions of each product.











## Controls

- ① Monitor Open Button [PUSH OPEN] ...  pg. 14
- ② Diopter Adjustment Control .....  pg. 9
- ③ Battery Release Switch [BAT. RELEASE] ...  pg. 7
- ④ • MENU Wheel [+ , - , PUSH] .....  pg. 31
  - LCD Monitor BRIGHT (Brightness) Control [+ , -] .....  pg. 14
- ⑤ Snapshot Button [SNAPSHOT] .....  pg. 23
- ⑥ • Power Zoom Lever [T/W] .....  pg. 16
  - Speaker Volume Control [VOL.] .....  pg. 18
- ⑦ • FOCUS Button .....  pg. 28
  - BLANK SEARCH Button .....  pg. 19
- ⑧ • Stop Button [■] .....  pg. 18
  - NIGHT-ALIVE Button .....  pg. 24
- ⑨ • Rewind Button [◀◀] .....  pg. 18
  - EXPOSURE Button .....  pg. 29
- ⑩ • Play/Pause Button [▶/||] .....  pg. 18
  - Programme AE Button [P.AE] .....  pg. 24
- ⑪ • Fast-Forward Button [▶▶] .....  pg. 18
  - BACKLIGHT Button .....  pg. 29
- ⑫ Power Switch [A , M , PLAY , OFF] .....  pg. 15
- ⑬ Recording Start/Stop Button .....  pg. 14
- ⑭ Lock Button .....  pg. 15
- ⑮ Video Light Switch [LIGHT OFF/AUTO/ON] .....  pg. 16
- ⑯ OPEN/EJECT Switch .....  pg. 11

## Connectors



The connectors ⑰ to ⑳ are located beneath a cover.

- ⑰ S-Video Output Connector [S] .....  pg. 20, 37, 43
- ⑱ PC (DIGITAL PHOTO) Connector .....  pg. 48
- ⑲ J Terminal [JLIP (Joint Level Interface Protocol)] .....  pg. 43
 

Connect to a JLIP-compatible camcorder or VCR to control it from the computer using the Software. Connect the editing cable when performing Random Assemble Editing .....  pg. 42 – 46
- ⑳ Audio/Video Output Connector [AV] .....  pg. 20, 37, 43
- ㉑ DC Input Connector .....  pg. 7, 8
- ㉒ Digital Video Connector [DV IN/OUT] (i.Link\*) .....  pg. 38, 48, 49
 











\* i.Link refers to the IEEE1394-1995 industry specification and extensions thereof. The  logo is used for products compliant with the i.Link standard.

## Indicators

- ㉓ Tally Lamp .....  pg. 14, 33
- ㉔ CHARGE Lamp .....  pg. 7
- ㉕ Power Lamp .....  pg. 14, 15

## Other Parts

- ㉖ • Remote Sensor .....  pg. 39
  - Camera Sensor
 

Be careful not to cover this area, a sensor necessary for shooting is built-in here.
- ㉗ Viewfinder .....  pg. 9
- ㉘ Video Light .....  pg. 16
- ㉙ Stereo Microphone .....  pg. 47
- ㉚ Shoulder Strap Eyelets .....  pg. 9
- ㉛ Grip Strap .....  pg. 9
- ㉜ Viewfinder Cleaning Hatch .....  pg. 57
- ㉝ Battery Pack Mount .....  pg. 7
- ㉞ LCD Monitor .....  pg. 14, 15
- ㉟ Speaker .....  pg. 18
- ㊱ Stud Hole .....  pg. 9
- ㊲ Tripod Mounting Socket .....  pg. 9

## LCD Monitor/Viewfinder Indications During Recording

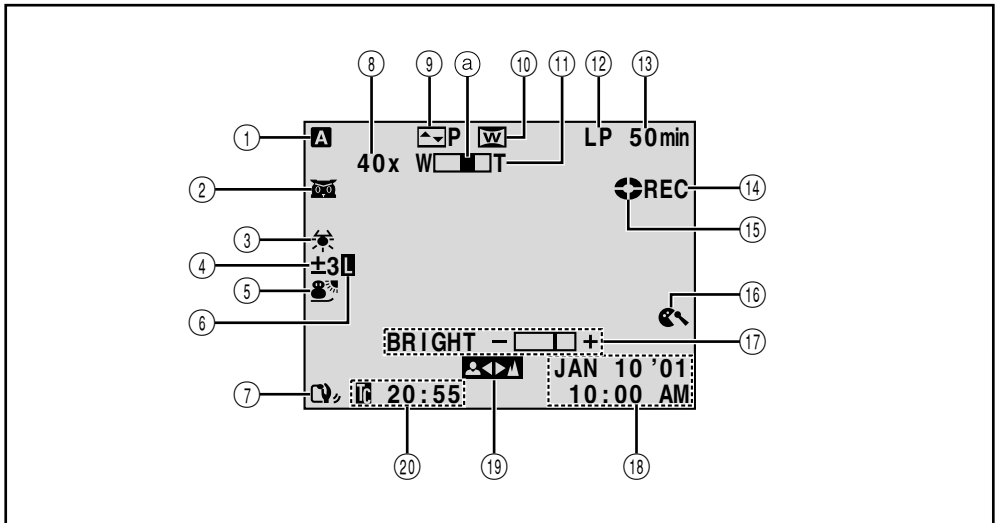





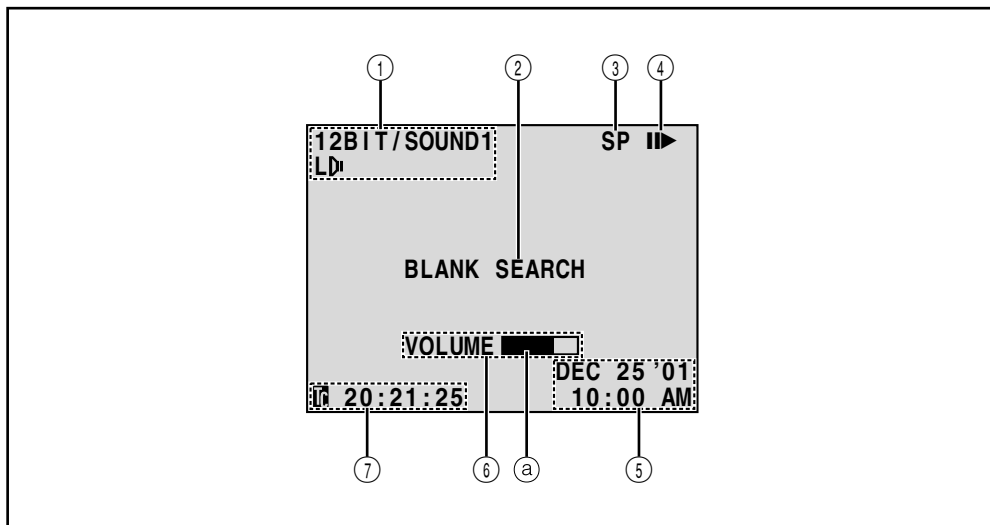

- ① Appears when the Power Switch is set to "A". (☞ pg. 15)
- ② • : Appears when Night-Alive is engaged. (☞ pg. 24)
- A: Appears when "GAIN UP" is set to "AUTO" and the shutter speed is being automatically adjusted. (☞ pg. 32)
- ③ Appears when the white balance is adjusted. (☞ pg. 30)
- ④ • "±": Appears when the exposure is adjusted. (☞ pg. 29)
- : Appears when backlight compensation is used. (☞ pg. 29)
- ⑤ Displays the selected Program AE with special effects. (☞ pg. 24)
- ⑥ Appears when the iris is locked. (☞ pg. 29)
- ⑦ Appears when Digital Image Stabilizer ("DIS") is engaged. (☞ pg. 32)
- ⑧ Approximate zoom ratio: Appears during zooming. (☞ pg. 16)
- ⑨ Displays the selected Fade/Wipe effect. (☞ pg. 26, 27)
- ⑩ Appears when in the Squeeze or Cinema mode. (☞ pg. 33)
- ⑪ Appears during zooming.
- ⓐ Zoom level indicator (☞ pg. 16)
- ⑫ Displays the recording mode (SP or LP). (☞ pg. 12)
- ⑬ Displays the tape remaining time. (☞ pg. 14)
- ⑭ • "REC" appears during recording.
- "PAUSE" appears during Record-Standby mode. (☞ pg. 14)
- "PHOTO" appears when taking a Snapshot. (☞ pg. 23)
- ⑮ Rotates while the tape is running. (☞ pg. 14)
- ⑯ Appears when the wind cut mode is engaged to cut down on noise created by wind. (☞ pg. 33)
- ⑰ • BRIGHT: Displays the brightness of the LCD monitor. (☞ pg. 14)
- SOUND: Displays the sound mode for approx. 5 seconds after turning on the camcorder. (☞ pg. 32)
- ⑱ Displays the date/time. (☞ pg. 10)
- ⑲ Appears when the focus is adjusted manually. (☞ pg. 28)
- ⑳ Displays the Time Code. (☞ pg. 17, 34)

## LCD Monitor/Viewfinder Indications During Playback

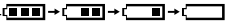

- ① Displays the sound mode. (☞ pg. 35, 36)
- ② Displays the Blank Search mode. (☞ pg. 19)
- ③ Displays the tape speed. (☞ pg. 12)
- ④ Appears while a tape is running.
- ▶ : Playback
  - ▶▶ : Fast-Forward/Shuttle search
  - ◀◀ : Rewind/Shuttle search
  - || : Pause
  - ||▶ : Forward slow-motion
  - ◀|| : Reverse slow-motion
  - : Audio Dubbing
  - ||● : Audio Dubbing Pause
- ⑤ Displays the date/time. (☞ pg. 35, 36)
- ⑥ BRIGHT : Displays the brightness of the LCD monitor. (☞ pg. 14)  
VOLUME : Displays the speaker volume. (☞ pg. 18)
- Ⓐ The level indicator moves.
- ⑦ Displays the time code. (☞ pg. 35, 36)

## Warning Indications

Indications	Function
	<p>Displays the battery remaining power.</p> <p>Remaining power level: high </p> <p>Remaining power level: exhausted </p> <p>As the battery power comes close to nil, the battery indicator  blinks. When the battery power is exhausted, power turns off automatically.</p>
	<p>Appears when no tape is loaded. <span style="float: right;">(ⓘ pg. 11)</span></p>
<p>CHECK TAPE'S ERASE PROTECTION TAB</p>	<p>Appears when the erase protection tab is set to "SAVE" while the Power Switch is set to "A" or "M". <span style="float: right;">(ⓘ pg. 11)</span></p>
<p> HEAD CLEANING REQUIRED USE CLEANING CASSETTE</p>	<p>Appears if dirt is detected on the heads during recording. Use an optional cleaning cassette. <span style="float: right;">(ⓘ pg. 64)</span></p>
<p> CONDENSATION OPERATION PAUSED PLEASE WAIT</p>	<p>Appears if condensation occurs. When this indication is displayed, wait more than 1 hour until condensation disappears.</p>
<p>TAPE!</p>	<p>Appears if a tape is not loaded when the Recording Start/Stop Button or SNAPSHOT Button is pressed while the Power Switch is set to "A" or "M".</p>
<p>TAPE END</p>	<p>Appears when the tape ends during recording or playback. <span style="float: right;">(ⓘ pg. 51)</span></p>
<p>DIFFERENT FORMATTED TAPE</p>	<p>Appears if a tape in another format is loaded.</p>
<p>SET DATE/TIME!</p>	<ul style="list-style-type: none"> <li>● Appears when the date/time is not set. <span style="float: right;">(ⓘ pg. 10)</span></li> <li>● Appears when the built-in clock battery runs out and the previously set date/time is erased. Consult your nearest JVC dealer for replacement.</li> </ul>
<p>LENS CAP</p>	<p>Appears for 5 seconds after power is turned on if the lens cap is attached.</p>
<p>A. DUB ERROR!</p>	<p>Appears if Audio Dubbing is attempted on a blank portion of a tape. <span style="float: right;">(ⓘ pg. 47)</span></p>
<p>A. DUB ERROR! &lt;CANNOT DUB ON A LP RECORDED TAPE&gt; &lt;CANNOT DUB ON A 16BIT RECORDING&gt; &lt;CHECK TAPE'S ERASE PROTECTION TAB&gt;</p>	<ul style="list-style-type: none"> <li>● Appears if Audio Dubbing is attempted on a tape recorded in the LP mode. <span style="float: right;">(ⓘ pg. 47)</span></li> <li>● Appears if Audio Dubbing is attempted on a tape recorded in 16-bit audio. <span style="float: right;">(ⓘ pg. 47)</span></li> <li>● Appears if A. DUB (⊖) on the remote control is pressed when the erase protection tab is set to "SAVE". <span style="float: right;">(ⓘ pg. 47)</span></li> </ul>
<p>E01 — E06 UNIT IN SAFEGUARD MODE REMOVE AND REATTACH BATTERY</p>	<p>The error indications (E01 — E06) show what type of malfunction has occurred. When an error indication appears, the camcorder turns off automatically. Remove the power supply (battery, etc.) and wait a few minutes for the indication to clear. When it does, you can resume using the camcorder. If the indication remains, consult your nearest JVC dealer.</p>

## When using the AC Adapter in areas other than the USA

- The provided AC Adapter features automatic voltage selection in the AC range from 110 V to 240 V.

## USING HOUSEHOLD AC PLUG ADAPTER

In case of connecting the unit's power cord to an AC wall outlet other than American National Standard C73 series type use an AC plug adapter, called a "Siemens Plug", as shown.

For this AC plug adapter, consult your nearest JVC dealer.

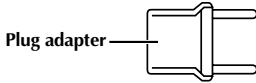

## Video Light

### DANGER

- The video light can become extremely hot. Do not touch it either while in operation or soon after turning it off, otherwise serious injury may result.
- Do not place the camcorder into the carrying case immediately after using the video light, since it remains extremely hot for some time.
- When operating, keep a distance of about 30 cm (11-13/16") between the video light and people or objects.
- Do not use near flammable or explosive materials.
- It is recommended that you consult your nearest JVC dealer for replacing the video light.



## General Battery Precautions

If the remote control is not functioning even if it is being operated correctly, the batteries are exhausted. Replace them with fresh ones.

**Use only the following batteries:** AAA (R03) size x 2  
Please make note of the following rules for battery use. When misused, the batteries can leak or explode.

1. When replacing batteries, refer to page 39.
2. **Do not** use any different size of batteries from those specified.
3. Be sure to install batteries in the correct direction.
4. **Do not** use rechargeable batteries.
5. **Do not** expose the batteries to excessive heat as they can leak or explode.
6. **Do not** dispose of the batteries in a fire.
7. Remove the batteries from the unit if it is to be stored for an extended period to avoid battery leakage which can cause malfunctions.

## Battery Packs

The supplied battery pack is a lithium-ion battery. Before using the supplied battery pack or an optional battery pack, be sure to read the following cautions:

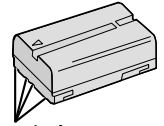

Terminals

1. **To avoid hazards . . .**
  - ... **do not** burn.
  - ... **do not** short-circuit the terminals. When transporting, make sure the provided battery cap is attached to the battery. If the battery cap is misplaced, carry the battery in a plastic bag.
  - ... **do not** modify or disassemble.
  - ... **do not** expose the battery to temperatures exceeding 60°C (140°F), as this may cause the battery to overheat, explode or catch fire.
  - ... use only specified chargers.
2. **To prevent damage and prolong service life . . .**
  - ... **do not** subject to unnecessary shock.
  - ... charge in an environment where temperatures are within the tolerances shown in the chart below. This is a chemical reaction type battery—cooler temperatures impede chemical reaction, while warmer temperatures can prevent complete charging.
  - ... store in a cool, dry place. Extended exposure to high temperatures will increase natural discharge and shorten service life.
  - ... fully charge and then fully discharge the battery every 6 months when storing the battery pack over a long period time.
  - ... remove from charger or powered unit when not in use, as some machines use current even when switched off.

### NOTES:

- It is normal for the battery pack to be warm after charging, or after use.
- Temperature Range Specifications**
- |                 |                              |
|-----------------|------------------------------|
| Charging .....  | 10°C to 35°C (50°F to 95°F)  |
| Operation ..... | 0°C to 40°C (32°F to 104°F)  |
| Storage .....   | -10°C to 30°C (14°F to 86°F) |
- Recharging time is based on room temperature of 20°C (68°F).
  - The lower the temperature, the longer recharging takes.

## Cassettes

To properly use and store your cassettes, be sure to read the following cautions:

1. **During use . . .**
  - ... make sure the cassette bears the Mini DV mark.
  - ... be aware that recording onto prerecorded tapes automatically erases the previously recorded video and audio signals.
  - ... make sure the cassette is positioned properly when inserting.
  - ... do not load and unload the cassette repeatedly without allowing the tape to run at all. This slackens the tape and can result in damage.
  - ... do not open the front tape cover. This exposes the tape to fingerprints and dust.

**2. Store cassettes . . .**

- ... away from heaters or other heat sources.
- ... out of direct sunlight.
- ... where they won't be subject to unnecessary shock or vibration.
- ... where they won't be exposed to strong magnetic fields (such as those generated by motors, transformers or magnets).
- ... vertically, in their original cases.

**LCD Monitor****1. To prevent damage to the LCD monitor, DO NOT . . .**

- ... push it strongly or apply any shocks.
- ... place the camcorder with the LCD monitor on the bottom.

**2. To prolong service life . . .**

- ... avoid rubbing it with coarse cloth.

**3. Be aware of the following phenomena for LCD monitor use.****These are not malfunctions:**

- While using the camcorder, the surface around the LCD monitor and/or the back of the LCD monitor may heat up.
- If you leave power on for a long time, the surface around the LCD monitor becomes hot.

**Main Unit****1. For safety, DO NOT . . .**

- ... open the camcorder's chassis.
- ... disassemble or modify the unit.
- ... short-circuit the terminals of the battery pack. Keep it away from metallic objects when not in use.
- ... allow inflammables, water or metallic objects to enter the unit.
- ... remove the battery pack or disconnect the power supply while the power is on.
- ... leave the battery pack attached when the camcorder is not in use.

**2. Avoid using the unit . . .**

- ... in places subject to excessive humidity or dust.
- ... in places subject to soot or steam such as near a cooking stove.
- ... in places subject to excessive shock or vibration.
- ... near a television set.
- ... near appliances generating strong magnetic or electric fields (speakers, broadcasting antennas, etc.).
- ... in places subject to extremely high (over 40°C or 104°F) or extremely low (under 0°C or 32°F) temperatures.

**3. DO NOT leave the unit . . .**

- ... in places of over 50°C (122°F).
- ... in places where humidity is extremely low (below 35%) or extremely high (above 80%).
- ... in direct sunlight.
- ... in a closed car in summer.
- ... near a heater.

**4. To protect the unit, DO NOT . . .**

- ... allow it to become wet.
- ... drop the unit or strike it against hard objects.
- ... subject it to shock or excessive vibration during transportation.
- ... keep the lens directed at extremely bright objects for long periods.
- ... expose the lens to direct sunlight.
- ... carry it by holding the LCD monitor or the viewfinder.
- ... swing it excessively when using the shoulder strap or the grip.

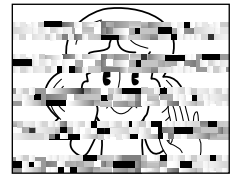
**5. Dirty heads can cause the following problems:**

- No picture during playback.
- Blocks of noise appear during playback.
- During recording, the Head Clog Warning indicator "⊗" appears.

In such cases, use an optional cleaning cassette. Insert it and play back. If the cassette is used more than once consecutively, damage to the video heads may result. After the camcorder plays back for about 20 seconds, it stops automatically. Also refer to the cleaning cassette's instructions. If, after using the cleaning cassette, the problems still exist, consult your nearest JVC dealer. Mechanical moving parts used to move the video heads and video tape tend to become dirty and worn out over time. In order to maintain a clear picture at all times, periodic check-ups are recommended after using the unit for about 1,000 hours. For periodic check-ups please consult your nearest JVC dealer.



**About moisture condensation . . .**

- You have observed that pouring a cold liquid into a glass will cause drops of water to form on the glass' outer surface. This same phenomenon occurs on the head drum of a camcorder when it is moved from a cool place to a warm place, after heating a cold room, under extremely humid conditions or in a place directly subjected to the cool air from an air conditioner.
- Moisture on the head drum can cause severe damage to the video tape, and can lead to internal damage to the camcorder itself.

**Declaration of Conformity**

**Model Number** : GR-DVL315U  
**Trade Name** : JVC  
**Responsible party** : JVC AMERICAS CORP.  
**Address** : 1700 Valley Road Wayne,  
 N. J. 07470  
**Telephone Number** : 973-315-5000

This device complies with Part 15 of FCC Rules. Operation is subject to the following two conditions:

- (1) This device may not cause harmful interference, and (2) this device must accept any interference received, including interference that may cause undesired operation.

**Serious malfunctioning**

If malfunctioning occurs, stop using the unit immediately and consult your local JVC dealer.

The camcorder is a microcomputer-controlled device. External noise and interference (from a TV, a radio, etc.) might prevent it from functioning properly. In such cases, first disconnect its power supply unit (battery pack, AC Adapter, etc.) and wait a few minutes and then re-connect it and proceed as usual from the beginning.





Change or modifications not approved by the party responsible for compliance could void the user's authority to operate the equipment. This equipment has been tested and found to comply with the limits for a Class B digital device, pursuant to Part 15 of the FCC Rules. These limits are designed to provide reasonable protection against harmful interference in a residential installation. This equipment generates, uses, and can radiate radio frequency energy and, if not installed and used in accordance with the instructions, may cause harmful interference to radio communications. However, there is no guarantee that interference will not occur in a particular installation. If this equipment does cause harmful interference to radio or television reception, which can be determined by turning the equipment off and on, the user is encouraged to try to correct the interference by one or more of the following measures:

- Reorient or relocate the receiving antenna.
- Increase the separation between the equipment and receiver.
- Connect the equipment into an outlet on a circuit different from that to which the receiver is connected.
- Consult the dealer or an experienced radio/TV technician for help.







This Class B digital apparatus complies with Canadian ICES-003.

Cet appareil numérique de la classe B est conforme à la norme NMB-003 du Canada.







**A**

- AC Adapter .....  pg. 7, 8
- Audio Dubbing .....  pg. 47
- Auto Date .....  pg. 34
- Auto Focus .....  pg. 28
- Auto Shut off .....  pg. 14, 18









**B**

- Backlight Compensation .....  pg. 29
- Battery Low .....  pg. 62
- Battery Pack .....  pg. 7, 8, 63
- Beep .....  pg. 33
- Blank Search .....  pg. 19
- Brighten The LCD Monitor .....  pg. 14



**C**

- Channels (Left/Right) .....  pg. 36
- Charge The Battery Pack .....  pg. 7
- Cinema .....  pg. 33
- Classic Film .....  pg. 25
- Clean The Camcorder .....  pg. 57
- Connections ...  pg. 7, 8, 20, 21, 37, 38, 43, 48, 49



**D**

- Darken The LCD Monitor .....  pg. 14
- Date/Time Display .....  pg. 34, 35, 36
- Date/Time Settings .....  pg. 10
- Demonstration Mode .....  pg. 5, 34
- Digital Zoom .....  pg. 16, 32
- DIS (Digital Image Stabilizer) .....  pg. 32
- Diopter Adjustment .....  pg. 9
- Dubbing .....  pg. 37, 38



**E**

- Erase Protection .....  pg. 11
- Exposure Control .....  pg. 29



**F**

- Fade-In/Out .....  pg. 26, 27
- Fast-Forward The Tape .....  pg. 18
- Frame-By-Frame Playback .....  pg. 18

**G**

- Gain Up .....  pg. 32
- Grip Adjustment .....  pg. 9



**I**

- Icons .....  pg. 32 – 34
- Iris .....  pg. 29
- Iris Lock .....  pg. 29





**J**



- Journalistic Shooting .....  pg. 15

**L**

- LCD monitor/Viewfinder Indications .  pg. 60 – 62
- Load A Tape .....  pg. 11

**M**







- Manual Focus .....  pg. 28
- Menu Screen, CAMERA .....  pg. 32
- Menu Screen, DISPLAY .....  pg. 34, 35
- Menu Screen, MANUAL .....  pg. 32, 33
- Menu Screen, SYSTEM .....  pg. 33, 34, 35

- Menu Screen, VIDEO .....  pg. 35
- Monotone .....  pg. 25
- Motor Drive Mode .....  pg. 23







**N**

- Night-Alive .....  pg. 24

















**P**

- Picture Wipe/Dissolve .....  pg. 26, 27
- Playback Zoom .....  pg. 41
- Power Switch Position .....  pg. 15
- Printer .....  pg. 49
- Program AE With Special Effects .....  pg. 24, 25
- Provided Accessories .....  pg. 4





**R**

- Random Assemble Editing .....  pg. 42 – 46
- Record-Standby .....  pg. 14
- Recording Mode .....  pg. 12
- Remote Control .....  pg. 39
- Reset .....  pg. 34
- Rewind The Tape .....  pg. 18

**S**

- Self-Recording .....  pg. 15
- Sepia .....  pg. 25
- Set Remote Control/VCR Code .....  pg. 42
- Shuttle Search .....  pg. 18
- Shutter Speed .....  pg. 25
- Slow Shutter .....  pg. 25
- Snapshot .....  pg. 23
- Snapshot Mode .....  pg. 23
- Snow .....  pg. 25
- Sound Mode .....  pg. 32, 35, 36
- Speaker Volume .....  pg. 18
- Specifications .....  pg. 67
- Sports .....  pg. 25
- Spotlight .....  pg. 25
- Squeeze .....  pg. 33
- Still Playback .....  pg. 18
- Strobe .....  pg. 25



**T**

- Tally .....  pg. 33
- Tele Macro .....  pg. 33
- Time Code .....  pg. 17, 34, 35, 36
- Tripod Mounting .....  pg. 9
- Twilight .....  pg. 25





**U**

- Unload A Tape .....  pg. 11

**V**

- Video Echo .....  pg. 25
- Video Light .....  pg. 16

**W**



- White Balance .....  pg. 30
- Wide Mode .....  pg. 33
- Wind Cut .....  pg. 33
- Wipe In/Out .....  pg. 26, 27

**Z**

- Zooming .....  pg. 16

## Camcorder

## For General

Power supply	: DC 11.0 V  (Using AC Adapter) DC 7.2 V  (Using battery pack)
Power consumption	
LCD monitor off, viewfinder on	: Approx. 4.3 W
LCD monitor on, viewfinder off	: Approx. 5.3 W
Video light	: Approx. 3.5 W
Dimensions (W x H x D)	: 83 mm x 97 mm x 188 mm (3-5/16" x 3-7/8" x 7-7/16") (with the LCD monitor closed and the viewfinder pushed down)
Weight	: Approx. 590 g (1.3 lbs)
Operating temperature	: 0°C to 40°C (32°F to 104°F)
Operating humidity	: 35% to 80%
Storage temperature	: -20°C to 50°C (-4°F to 122°F)
Pickup	: 1/4" CCD
Lens	: F 1.8, f = 3.6 mm to 36 mm, 10:1 power zoom lens
Filter diameter	: ø37 mm
LCD monitor	: 2.5" diagonally measured, LCD panel/TFT active matrix system
Viewfinder	: Electronic viewfinder with 0.44" color LCD
Speaker	: Monaural



## For Digital Video Camera

Format	: DV format (SD mode)
Signal format	: NTSC standard
Recording/Playback format	: Video: Digital component recording Audio: PCM digital recording, 32 kHz 4-channel (12-bit), 48 kHz 2-channel (16-bit)
Cassette	: Mini DV cassette
Tape speed	: SP: 18.8 mm/s LP: 12.5 mm/s
Maximum recording time (using 80 min. cassette)	: SP: 80 min. LP: 120 min.

## For Connectors

S-Video	: Y : 1 V (p-p), 75 Ω, analog C : 0.29 V (p-p), 75 Ω, analog
AV	
Video output	: 1 V (p-p), 75 Ω, analog
Audio output	: 300 mV (rms), 1 kΩ, analog, stereo
DV	
Output/input	: 4-pin, IEEE 1394 compliant
PC (DIGITAL PHOTO)	: ø2.5 mm, 3-pole
JLIP	: ø3.5 mm, 4-pole

## AC Adapter AP-V10U

Power requirement	
U.S.A. and Canada	: AC 120 V  , 60 Hz
Other countries	: AC 110 V to 240 V  , 50 Hz/60 Hz
Output	: DC 11 V  , 1 A
Dimensions (W x H x D)	: 59 mm x 31 mm x 84 mm (2-3/8" x 1-1/4" x 3-5/16")
Weight	: Approx. 130 g (0.29 lbs.)

Specifications shown are for SP mode unless otherwise indicated. E & O.E. Design and specifications subject to change without notice.



VICTOR COMPANY OF JAPAN, LIMITED



## Free Manuals Download Website

<http://myh66.com>

<http://usermanuals.us>

<http://www.somanuals.com>

<http://www.4manuals.cc>

<http://www.manual-lib.com>

<http://www.404manual.com>

<http://www.luxmanual.com>

<http://aubethermostatmanual.com>

Golf course search by state

<http://golfingnear.com>

Email search by domain

<http://emailbydomain.com>

Auto manuals search

<http://auto.somanuals.com>

TV manuals search

<http://tv.somanuals.com>