

JVC

ENGLISH

Basic Edition

DIGITAL MEDIA CAMERA

GZ-MC100

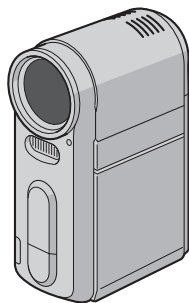

GETTING STARTED **6**

**BASIC OPERATIONS
(RECORDING & PLAYBACK)** **19**

MENU SETTINGS **26**

REFERENCES **32**

To deactivate the demonstration, set
"DEMO MODE" to "OFF". (pg. 26)

INSTRUCTIONS

This instruction manual describes the basic operations of the camera. For more information, read the advanced operation manual provided as HTML format in the CD-ROM. See page 32 for details.

Major Features of this Camera

Removable hard disk

In contrast to conventional digital video cameras that record to DV tapes, the removable hard disk is a new type of card media that enables extended hours of high-resolution, MPEG2 video recording. (☞ pg. 5)

Various Recording Media and Modes

Video and still images can be recorded to CompactFlash card (CF card) and SD memory card. The removable hard disk (provided) or Microdrive is a type of CF card compliant with CF+ Type II. You can select the most suitable recording medium and mode for picture quality, image size, recording time, and computer environment. (☞ pg. 42)

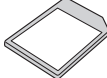
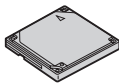

Voice Recording Features

The camera can be used as a voice recorder for audio recordings. (☞ pg. 24)

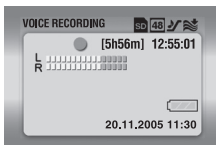

Enjoying Various Playback Features

Unlike tape operation, playback is simple and easy in this camera since no time is needed for rewinding or fast forward operations.

Playlist, playback effects, and other functions are also available for enjoying many different types of playback. (Refer to the advanced operation manual in CD-ROM. ☞ pg. 32)

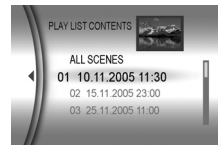

Editing Files on your PC

USB 2.0 enables the smooth transfer of video and still images to a computer. With the bundled Cyberlink software, you can easily edit video and create your own DVDs. (Refer to "SOFTWARE INSTALLATION AND USB CONNECTION GUIDE".)



Direct Printing

If your printer is compatible with PictBridge, still images can be printed easily by connecting the camera with USB cable directly to the printer. (Refer to the advanced operation manual in CD-ROM. ☞ pg. 32)

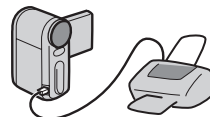

Dear Customer,

Thank you for purchasing this digital media camera. Before use, please read the safety information and precautions contained in the pages 3 – 4 to ensure safe use of this product.

SAFETY PRECAUTIONS

**IMPORTANT (for owners in the U.K.)
Connection to the mains supply in the United Kingdom.
DO NOT cut off the mains plug from this equipment.**

If the plug fitted is not suitable for the power points in your home or the cable is too short to reach a power point, then obtain an appropriate safety approved extension lead or consult your dealer.

BE SURE to replace the fuse only with an identical approved type, as originally fitted, and to replace the fuse cover.

If nonetheless the mains plug is cut off be sure to remove the fuse and dispose of the plug immediately, to avoid possible shock hazard by inadvertent connection to the mains supply. If this product is not supplied fitted with a mains plug then follow the instructions given below:

DO NOT make any connection to the Larger Terminal coded E or Green.

The wires in the mains lead are coloured in accordance with the following code:

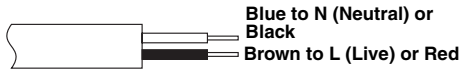

If these colours do not correspond with the terminal identifications of your plug, connect as follows:
Blue wire to terminal coded N (Neutral) or coloured black.
Brown wire to terminal coded L (Live) or coloured Red.
If in doubt — consult a competent electrician.

**WARNING: TO PREVENT FIRE OR SHOCK HAZARD,
DO NOT EXPOSE THIS UNIT TO RAIN OR MOISTURE.**

CAUTIONS:

- To prevent shock, do not open the cabinet. No user serviceable parts inside. Refer servicing to qualified personnel.
- When you are not using the AC adapter for a long period of time, it is recommended that you disconnect the power cord from AC outlet.

CAUTION:

To avoid electric shock or damage to the unit, first firmly insert the small end of the power cord into the AC Adapter until it is no longer wobbly, and then plug the larger end of the power cord into an AC outlet.

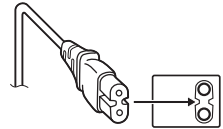
**CAUTIONS:**

- This camera is designed to be used with PAL-type color television signals. It cannot be used for playback with a television of a different standard. However, live recording and LCD monitor playback are possible anywhere.
- Use the JVC BN-VM200U battery pack and, to recharge it or to supply power to the camera from an AC outlet, use the provided multi-voltage AC adapter. (An appropriate conversion adapter may be necessary to accommodate different designs of AC outlets in different countries.)

NOTES:

- The rating plate (serial number plate) and safety caution are on the battery pack mount of the main unit.
- The rating information and safety caution of the AC adapter are on its upper and lower sides.

Do not point the lens directly into the sun. This can cause eye injuries, as well as lead to the malfunctioning of internal circuitry. There is also a risk of fire or electric shock.

CAUTION!

The following notes concern possible physical damage to the camera and to the user.

Carrying or holding the camera by the LCD monitor can result in dropping the unit, or in a malfunction.

Do not use a tripod on unsteady or unlevel surfaces. It could tip over, causing serious damage to the camera.

CAUTION!

Connecting cables (Audio/Video, S-Video, etc.) to the camera and leaving it on top of the TV is not recommended, as tripping on the cables will cause the camera to fall, resulting in damage.

When the equipment is installed in a cabinet or on a shelf, make sure that it has sufficient space on all sides to allow for ventilation (10 cm or more on both sides, on top and at the rear).

Do not block the ventilation holes.

(If the ventilation holes are blocked by a newspaper, or cloth etc. the heat may not be able to get out.)

No naked flame sources, such as lighted candles, should be placed on the apparatus.

When discarding batteries, environmental problems must be considered and the local rules or laws governing the disposal of these batteries must be followed strictly.

The apparatus shall not be exposed to dripping or splashing.

Do not use this equipment in a bathroom or places with water.

Also do not place any containers filled with water or liquids (such as cosmetics or medicines, flower vases, potted plants, cups etc.) on top of this unit.

(If water or liquid is allowed to enter this equipment, fire or electric shock may be caused.)

SOME DO'S AND DON'TS ON THE SAFE USE OF EQUIPMENT

This equipment has been designed and manufactured to meet international safety standards but, like any electrical equipment, care must be taken if you are to obtain the best results and safety is to be assured.

DO read the operating instructions before you attempt to use the equipment.

DO ensure that all electrical connections (including the mains plug, extension leads and interconnections between pieces of equipment) are properly made and in accordance with the manufacturer's instructions. Switch off and withdraw the mains plug when making or changing connections.

DO consult your dealer if you are ever in doubt about the installation, operation or safety of your equipment.

DO be careful with glass panels or doors on equipment.

DON'T continue to operate the equipment if you are in any doubt about it working normally, or if it is damaged in any way — switch off, withdraw the mains plug and consult your dealer.

DON'T remove any fixed cover as this may expose dangerous voltages.

DON'T leave equipment switched on when it is unattended unless it is specifically stated that it is designed for unattended operation or has a standby mode. Switch off using the switch on the equipment and make sure that your family knows how to do this. Special arrangements may need to be made for infirm or handicapped people.

DON'T use equipment such as personal stereos or radios so that you are distracted from the requirements of road safety. It is illegal to watch television whilst driving.

DON'T listen to headphones at high volume, as such use can permanently damage your hearing.

DON'T obstruct the ventilation of the equipment, for example with curtains or soft furnishings. Overheating will cause damage and shorten the life of the equipment.

DON'T use makeshift stands and NEVER fix legs with wood screws — to ensure complete safety always fit the manufacturer's approved stand or legs with the fixings provided according to the instructions.

DON'T allow electrical equipment to be exposed to rain or moisture.

ABOVE ALL

- NEVER let anyone especially children push anything into holes, slots or any other opening in the case — this could result in a fatal electrical shock;
- NEVER guess or take chances with electrical equipment of any kind — it is better to be safe than sorry!

Before Using this Camera

This camera is designed exclusively for CompactFlash Card (CF card) and SD Memory Card.

The removable hard disk (provided) or Microdrive is a type of CF card compliant with CF+ Type II.

This camera records video in MPEG2 format compliant with SD-VIDEO format.

Remember that this camera is not compatible with other digital video formats.

Remember that this camera is intended for private consumer use only.

Any commercial use without proper permission is prohibited. (Even if you record an event such as a show, performance or exhibition for personal enjoyment, it is strongly recommended that you obtain permission beforehand.)
All Manuals Search And Download.

Before recording important video, be sure to make a trial recording.

Play back your trial recording to make sure the video and audio have been recorded properly.

Also read "Cautions" on pages 37 to 39.

- Manufactured under license from Dolby Laboratories. "Dolby" and double-D symbol are trademarks of Dolby Laboratories.
- Microdrive® is a registered trademark of Hitachi Global Storage Technologies, Inc. in the United States and/or other countries.



MascotCapsule is registered trademark of HI CORPORATION in Japan.

Copyright © 2001 HI CORPORATION. All rights reserved.

- Other product and company names included in this instruction manual are trademarks and/or registered trademarks of their respective holders.

Removable Hard Disk

The removable hard disk is a precision electronic device. Be careful when handling it.

Cautions for external jolt or stress

- After removing the disk from the camera, store it by inserting into the supplied protective case.
- Do not press on the cover.
- Do not subject the disk to vibrations or sudden jolts. Be especially careful to avoid sudden jolts when shooting or during playback.
- Do not affix stickers or write on the label.
- Do not apply strong pressure to the outside of the disk. Also, do not put it in your pants pocket or other location where it can be pressed on.

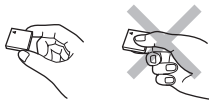

Cautions for temperature

- The camera's protection circuit may work for the proper recording or playback when the camera's internal temperature rises or during usage in a cold location. (☞ pg. 36)
- The camera and removable hard disk can heat up when used for an extended period. However, this is not a malfunction.

- The disk can heat up when used for an extended period. Therefore, do not remove it immediately from the camera.

Other cautions

- Condensation can cause the drive to break down. If water is splashed on the drive, make sure that it is completely dried before usage.
- Do not use, replace, or store the disk in locations that are exposed to strong static electricity or electrical noise.
- Do not turn off the camera power or remove the battery or AC adapter during shooting, playback, or when otherwise accessing the recording medium.
- Do not bring the recording medium near objects that have a strong magnetic field or that emit strong electromagnetic waves.
- Since data must be read and written by the drive correctly, the camera may be unable to shoot when the camera heats up, such as during continuous shooting, or when the camera is cooled down during usage in a cold location. To fix this problem, follow the messages displayed on the screen. (☞ pg. 36)
- To maintain high performance, perform check disks (error checks) using your computer on a regular basis. Use a USB cable to connect the camera and PC, and then perform the check disk on the removable hard disk using the same procedure as a regular local disk (C drive). Refer to the instruction manual of your PC for check disks.
- Clean up the disk regularly to maintain high performance. (☞ pg. 27)

Also read "Recording Medium" on page 38.

Be careful to completely delete data when discarding or giving away the removable hard disk.

When recording data is formatted or deleted on the camera, this only modifies the file management information, and the data is not completely erased. When discarding or giving away the removable hard disk, to prevent problems caused by the release of sensitive information, it is extremely important that the customer take responsibility to erase all recorded data. Some recommended methods of erasing data include using a commercial data removal program or using a hammer or strong magnet to physically or magnetically destroy the data on the hard disk so that it cannot be read. JVC shall not be responsible for any personal data that is released.

Index

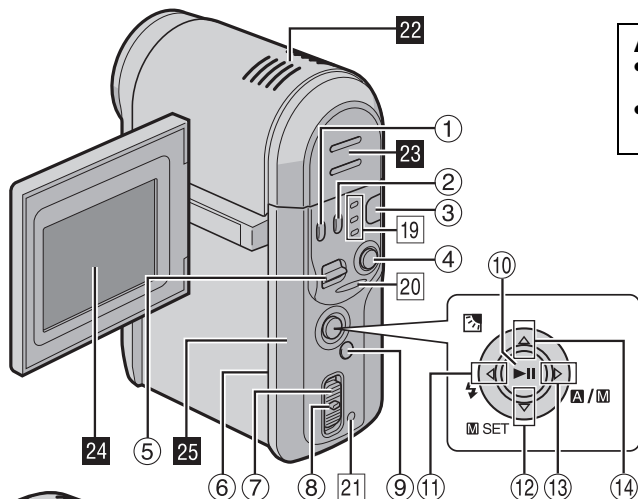





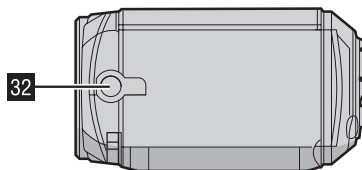
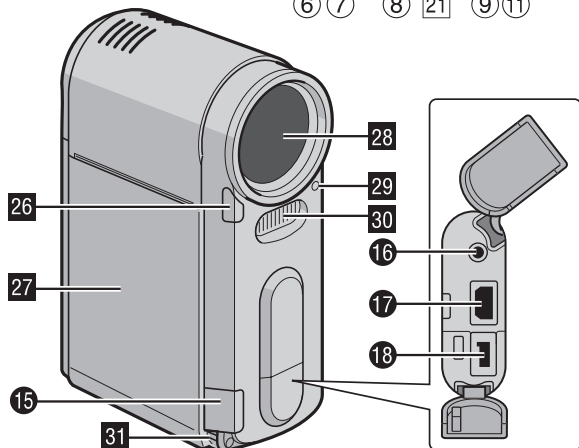











**ATTENTION:**

- Be careful not to cover **22**, **26**, **28**, **29** and **30** during shooting.
- Be careful not to cover **28** during playback.

The top, bottom, left or right sides of the **▶▶|◀◀△▽◁▷** button can be pressed to operate like a lever. The explanation "pressing **△**" in this instruction manual means moving the **▶▶|◀◀△▽◁▷** button in the **△** direction.



Controls



- ① Delete Button [⏏] (⇨ pg. 21, 23, 24)
- ② Information Button [INFO] (Used to display the file information. Refer to the advanced operation manual. ⇨ pg. 32)
- ③ Mode Button [MODE] (⇨ pg. 19)
- ④ Recording Start/Stop Button (⇨ pg. 20)
- ⑤ Zoom Lever [T/W] (⇨ pg. 20)
 - Speaker Volume Control (⇨ pg. 21)
- ⑥ Rear Panel Open Switch [OPEN] (⇨ pg. 16)
- ⑦ Power Switch [OFF, , ] (⇨ pg. 19)
- ⑧ Lock Button (⇨ pg. 19)
- ⑨ Menu Button [MENU] (⇨ pg. 26)
- ⑩ Play/Pause Button [▶||] (⇨ pg. 21)
- ⑪ Reverse Search Button [ ()] (⇨ pg. 21)
 - Left Button [] (⇨ pg. 26)
 - Flash Button [] (Used to change the flash mode. Refer to the advanced operation manual. ⇨ pg. 32)
- ⑫ Forward Skip Button [] (⇨ pg. 21)
 - Down Button [] (⇨ pg. 26)
 - Manual Set Button [ SET] (⇨ pg. 31)
- ⑬ Forward Search Button [ ()] (⇨ pg. 21)
 - Right Button [] (⇨ pg. 26)
 - Auto/Manual Mode Switch [ / ] (⇨ pg. 19)
- ⑭ Reverse Skip Button [ ()] (⇨ pg. 21)
 - Up Button [] (⇨ pg. 26)
 - Backlight Compensation Button []/Spot Exposure Control Button (Used to engage backlight compensation or spot exposure control. Refer to the advanced operation manual. ⇨ pg. 32)

Connectors

The connectors are located beneath the covers.

- ⑮ USB (Universal Serial Bus) Connector (Refer to the software installation and USB connection guide.)
- ⑯ Headphone connector [] (⇨ pg. 13)
- ⑰ S-Video/Audio/Video Output Connector [AV] (⇨ pg. 25)
- ⑱ DC Input Connector [DC] (⇨ pg. 14)

Indicators

- ⑲ Mode Lamp [ (video),  (still image),  (voice)] (⇨ pg. 19)
- ⑳ Access Lamp (Lights up or blinks when you access to any files. Do not turn off the power or remove the battery pack/AC adapter while accessing to files during recording or playback.)
- ㉑ Power/Charge Lamp (⇨ pg. 14, 19)

Other Parts

- ㉒ Stereo Microphone
- ㉓ Speaker (⇨ pg. 21)
- ㉔ LCD Monitor (⇨ pg. 18)
- ㉕ Rear Panel (Recording media cover) (⇨ pg. 16)
- ㉖ Camera Sensor
- ㉗ Battery Cover (⇨ pg. 14)
- ㉘ Lens
- ㉙ Flash Sensor
- ㉚ Flash
- ㉛ Hand Strap Eyelet (⇨ pg. 12)
- ㉜ Tripod Mounting Socket

Indications on LCD Monitor

During both Video and Still Image Recording

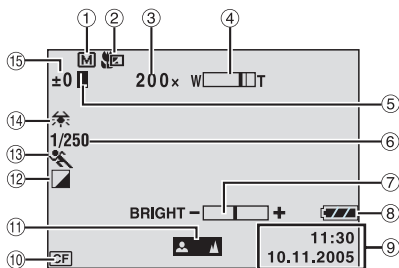

- ① Manual Mode Indicator (☞ pg. 19)
 - ② Tele Macro Mode Indicator (☞ pg. 28)
 - ③ Approximate Zoom Ratio (☞ pg. 20, 28)
 - ④ Zoom Indicator (☞ pg. 20, 28)
 - ⑤ Iris Lock Indicator (Appears when iris is locked. Refer to the advanced operation manual. ☞ pg. 32)
 - ⑥ Shutter Speed (☞ pg. 31)
 - ⑦ Brightness Control Indicator (☞ pg. 27)
 - ⑧ Battery Indicator
 - ⑨ Date/Time (☞ pg. 27)
 - ⑩ Selected Medium Indicator (☞ pg. 17, 27)
 - ⑪ Manual Focus Adjustment Indicator (☞ pg. 31)
 - ⑫ Effect Mode Indicator (☞ pg. 31)
 - ⑬ Program AE Mode Indicator (☞ pg. 31)
 - ⑭ White Balance Indicator (☞ pg. 31)
 - ⑮ ±: Exposure Adjustment Indicator (☞ pg. 31)
- ☞ : Backlight Compensation Indicator (Appears when backlight compensation is engaged. Refer to the advanced operation manual. ☞ pg. 32)
- ☞ : Spot Exposure Control Indicator (Appears when spot exposure control is engaged. Refer to the advanced operation manual. ☞ pg. 32)

During Video Recording only

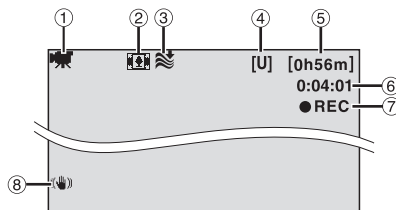

- ① Mode Indicator (☞ pg. 19)
- ② Wide Mode Indicator (☞ pg. 28)
- ③ Wind Cut Indicator (☞ pg. 28)
- ④ Picture Quality: [U] (ultra fine), [F] (fine), [N] (normal), [E] (economy) (☞ pg. 28)
- ⑤ Remaining Time (☞ pg. 20, 42)
- ⑥ Counter (☞ pg. 27)
- ⑦ ● REC: (Appears during recording.) (☞ pg. 20)
- II: (Appears during record-standby mode.) (☞ pg. 20)
- ⑧ Digital Image Stabiliser (DIS) (☞ pg. 28)

During Still Image Recording only

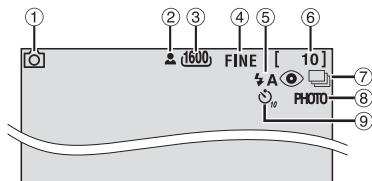

- ① Mode Indicator (☞ pg. 19)
- ② : Focus Icon (☞ pg. 22)
- ③ Image Size: 1600 (1600 x 1200), 1280 (1280 x 960), 1024 (1024 x 768), 640 (640 x 480) (☞ pg. 29)
- ④ Picture Quality: FINE (fine) and STANDARD (standard) (☞ pg. 29)
- ⑤ Flash Indicator (Appears when flash mode is engaged. Refer to the advanced operation manual. ☞ pg. 32)
- ⑥ Remaining Number Of Shots (☞ pg. 42)
- ⑦ Continuous Shooting Mode (☞ pg. 22)
- ⑧ Shooting Icon (☞ pg. 22)
(Appears during shooting.)
- ⑨ Self-Timer Recording Indicator (☞ pg. 29)

During Voice Recording

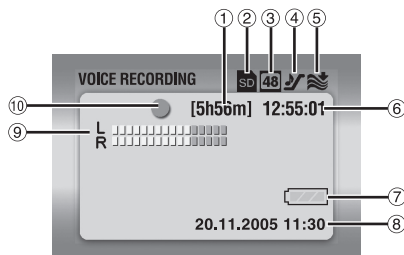

- ① Remaining Time (☞ pg. 43)
- ② Selected Medium Indicator (☞ pg. 17, 27)
- ③ Sound Quality: 48 (fine), 16 (standard), 8 (economy) (☞ pg. 30)
- ④ Recording Level: (high), (middle), (low) (☞ pg. 30)
- ⑤ Wind Cut Indicator (☞ pg. 28)
- ⑥ Counter
- ⑦ Battery Indicator
- ⑧ Date/Time (☞ pg. 27)
- ⑨ Microphone Input Level Indicator
- ⑩ Recording Mode
 - : Record
 - : Record-standby

During Video Playback

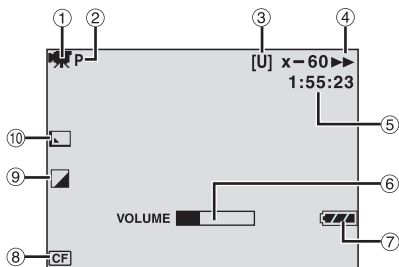

- ① Mode Indicator (☞ pg. 19)
- ② Play List Playback Indicator (Appears when play list is played back. Refer to the advanced operation manual. ☞ pg. 32)
- ③ Picture Quality: [U] (ultra fine), [F] (fine), [N] (normal), [E] (economy) (☞ pg. 28)
- ④ Playback Mode (☞ pg. 21)
 - ▶ : Playback
 - || : Pause
 - ▶▶ : Forward High-Speed Search
 - ◀◀ : Reverse High-Speed Search
 - ||| : Forward Slow-Motion
 - ◀|| : Reverse Slow-Motion
 (The number on the left shows speed.)
- ⑤ Counter (☞ pg. 27)
- ⑥ Volume Level Indicator
- ⑦ Battery Indicator
- ⑧ Selected Medium Indicator (☞ pg. 17, 27)
- ⑨ Effect Mode Indicator (☞ pg. 31)
- ⑩ Wipe/Fader Effect Indicator (☞ pg. 29)

During Still Image Playback

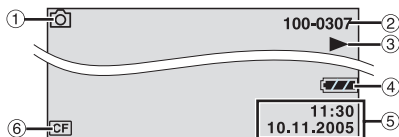

- ① Mode Indicator (☞ pg. 19)
- ② Folder/File Number
- ③ ▶ : Slide Show (☞ pg. 23)
- ④ Battery Indicator
- ⑤ Date/Time (☞ pg. 27)
- ⑥ Selected Medium Indicator (☞ pg. 17, 27)

During Voice Playback

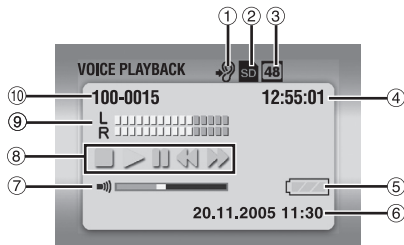

- ① Playback Speed: ♪ (normal), ♪♪ (fast), ♪♪♪ (slow) (☞ pg. 30)
- ② Selected Medium Indicator (☞ pg. 17, 27)
- ③ Sound Quality: 48 (fine), 16 (standard), 8 (economy) (☞ pg. 30)
- ④ Counter
- ⑤ Battery Indicator
- ⑥ Date/Time (☞ pg. 27)
- ⑦ Volume Level Indicator
- ⑧ Playback Mode (☞ pg. 24)
 - ▶ : Playback
 - ▶▶ : Forward High-Speed Search
 - ◀◀ : Reverse High-Speed Search
 - || : Pause
 - : Stop
- ⑨ Recording Level Indicator
- ⑩ Folder/File Number

Provided Accessories

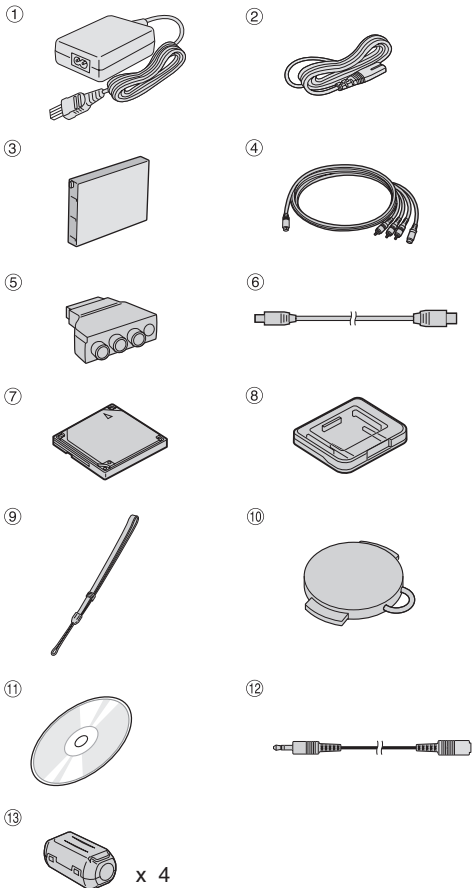

- ① AC Adapter AP-V14E
- ② Power Cord
- ③ Battery Pack BN-VM200U
- ④ S-Video/Audio/Video Cable
- ⑤ Cable Adapter
- ⑥ USB Cable
- ⑦ Removable Hard Disk (4 GB)
- ⑧ Protective Case for Removable Hard Disk
- ⑨ Hand Strap (See page 12 for attachment)
- ⑩ Lens Cap (See page 12 for attachment)
- ⑪ CD-ROM
- ⑫ Audio Extension Cable (for optional headphone, see page 13 for attachment)
- ⑬ Core Filter for cables (See page 13 for attachment)
Large: S-Video/Audio/Video Cable
Medium: USB cable
Small: audio extension cable and AC adapter's cord

NOTES:

- In order to maintain optimum performance of the camera, provided cables may be equipped with one or more core filter. If a cable has only one core filter, the end that is closest to the filter should be connected to the camera.
- Make sure to use the provided cables for connections. Do not use any other cables.

Attaching the Hand Strap

- 1 Thread the end of the strap through the eyelet.
- 2 Pass the other end through the loop.

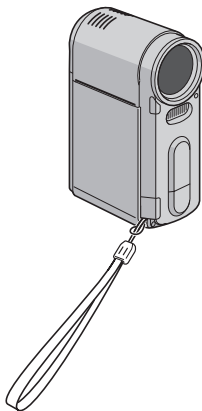

NOTE:

When carrying the camera, pass your arm through the strap to prevent dropping the camera. Tighten the strap at your wrist by sliding the buckle.

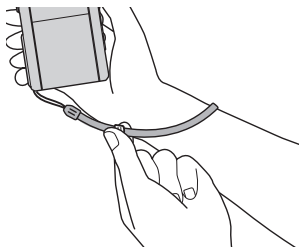

Attaching the Lens Cap

To protect the lens, attach the provided lens cap to the camera as shown in the illustration.

NOTE:

To confirm the lens cap is on correctly make sure the cap is flush to the camera.

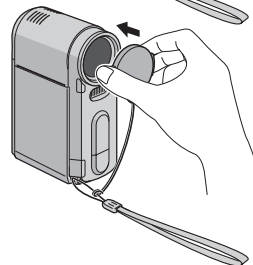
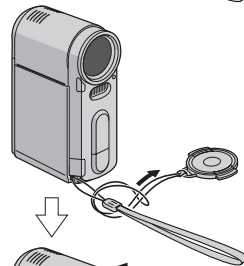
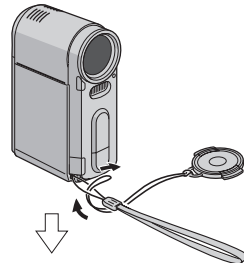

Attaching the Core Filter

Attach the core filters to the cables. The core filter reduces interference.

1 Release the stoppers on both ends of the core filter.



2 Run the cable through the core filter, leaving approx. 3 cm of cable between the cable plug and the core filter.

S-Video/Audio/Video cable

Wind the cable once around the outside of the core filter as shown in the illustration.

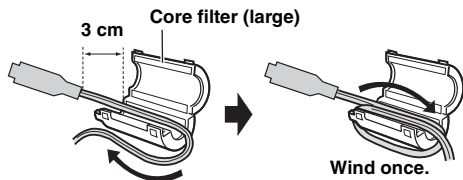

USB cable, audio extension cable and AC adapter's cord

Wind the cable twice around the outside of the core filter as shown in the illustration.

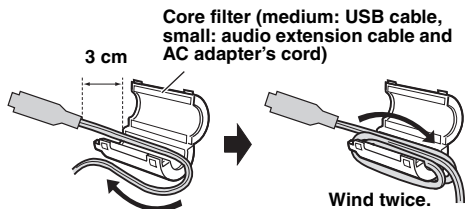

• Wind the cable so that it is not slack.

3 Close the core filter until it clicks shut.

S-Video/Audio/Video cable

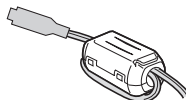

USB cable, audio extension cable and AC adapter's cord

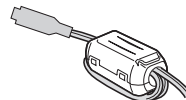

NOTES:

- Take care not to damage the cable.
- When connecting a cable, attach the end with the core filter to the camera.

How to Use the Audio Extension Cable

When using optional headphones, connect to the provided audio extension cable (with a core filter attached), then connect the audio extension cable to the camera. The core filter reduces interference.

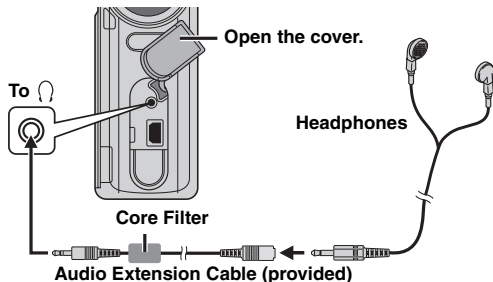

Power

This camera's 2-way power supply system lets you choose the most appropriate source of power. Do not use provided power supply units with other equipment.

Charging the Battery Pack

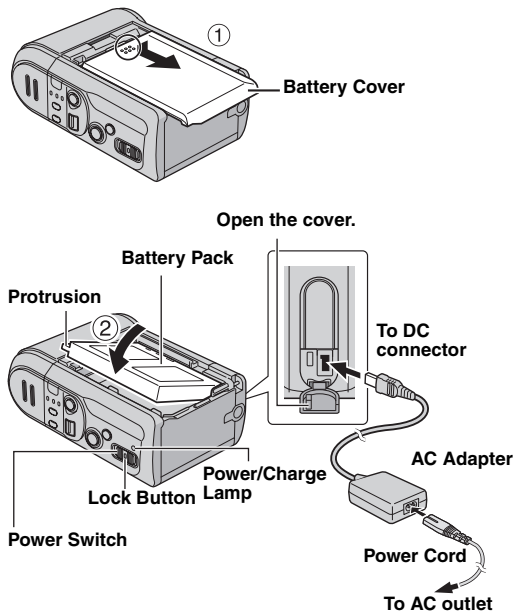

- 1 Set the power switch to **OFF** while pressing down the lock button located on the switch.
- 2 Slide and remove the battery cover ① by hooking on the ○ part with your finger.
- 3 Insert the battery pack firmly into the battery pack mount until it locks into space in the direction of the arrow ②.
- 4 Close the battery cover firmly until it locks.
- 5 Connect the AC adapter to the camera, then connect the power cord to the AC adapter.
- 6 Plug the power cord into an AC outlet. The power/charge lamp on the camera blinks to indicate charging has started.
- 7 When the power/charge lamp goes out, charging is finished. Unplug the power cord from the AC outlet. Disconnect the AC adapter from the camera.

To detach the battery pack

Open the battery cover, and remove the battery pack in the direction of the arrow ③ by holding the ○ part.

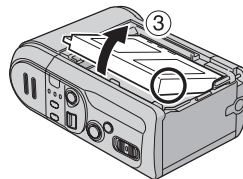

Battery pack	Charging time
BN-VM200U (provided)	Approx. 1 hr. 35 min.

NOTES:

- When the rear panel is opened while the power is on, the power is automatically turned off to protect the data in the recording medium. To turn on the power again, close the rear panel and use the power switch.
- It is recommended that only genuine JVC batteries are used in this camera. Using generic non-JVC batteries can cause damage to the internal charging circuitry.
- If the protective cap is attached to the battery pack, remove it first.
- When charging the battery pack for the first time or after a long storage period, the power/charge lamp may not light. In this case, remove the battery pack from the camera, then try charging again.
- If the battery operation time remains extremely short even after having been fully charged, the battery is worn out and needs to be replaced. Please purchase a new one.
- Since the AC adapter processes electricity internally, it becomes warm during use. Be sure to use it only in well-ventilated areas.

Using the Battery Pack

Perform steps **2 – 4** in “Charging the Battery Pack”.

Maximum continuous recording time

Battery pack	Recording time
BN-VM200U (provided)	1 hr. 5 min.

NOTES:

- Recording time is reduced significantly under the following conditions:
 - Zoom or record-standby mode is engaged repeatedly.
 - Playback mode is engaged repeatedly.
- Before extended use, it is recommended that you prepare enough battery packs to cover 3 times the planned recording time.

Using AC Power

Connect the AC adapter to the camera as shown in the illustration. (☞ pg. 14)

NOTE:

The provided AC adapter features automatic voltage selection in the AC range from 110 V to 240 V.

ATTENTION:

- Before detaching the power source, make sure that the camera's power is turned off. Failure to do so can result in a camera malfunction.
- If a malfunction occurs by electrostatic discharge, the power source should be terminated to reset the device.

About Batteries

DANGER! Do not attempt to take the batteries apart, or expose them to flame or excessive heat, as this may cause a fire or explosion.

WARNING! Do not allow the battery or its terminals to come in contact with metals, as this can result in a short circuit and possibly start a fire.

The Benefits Of Lithium-Ion Batteries

Lithium-ion battery packs are small but have a large power capacity. However, when one is exposed to cold temperatures (below 10°C), its usage time becomes shorter and it may cease to function. If this happens, place the battery pack in your pocket or other warm, protected place for a short time, then re-attach it to the camera.

Inserting/Removing a CF Card

You can use a CF card (CompactFlash card) as a recording medium in the CF slot. The removable hard disk (provided) or Microdrive is a type of CF cards. See page 42 for the guaranteed media to work with this camera.

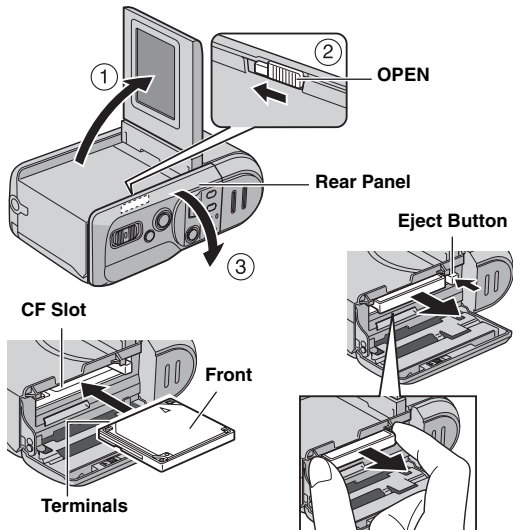

- 1** Make sure the camera's power is off.
- 2** Open the LCD monitor fully. (→ pg. 18)
- 3** Slide and hold **OPEN** in the direction of the arrow ②, then open the rear panel.
- 4** When the eject button is pulled out as shown in the illustration, push it once.
 - The button is pushed in.

5 To insert a CF card, firmly insert it as shown in the illustration.

To remove a CF card, push the eject button twice.

- The eject button comes out by pushing it once. By pushing the eject button once again ejects the CF card.

6 Close the rear panel firmly until it locks.

NOTES:

- Read the cautions on CF card. (→ pg. 38, "Recording Medium")
- Before using the provided removable hard disk or a new CF card, it is necessary to format it. (→ pg. 27)
- When the rear panel is opened while the power is on, the power is automatically turned off to protect the data in the recording medium. To turn on the power again, close the rear panel and use the power switch.

ATTENTION:

- Do not insert or remove the CF card while the camera is turned on, as this may cause the CF card to be corrupted or cause the camera to become unable to recognise whether or not the CF card is installed.
- Do not squeeze the external covers of the CF card.



Inserting/Removing an SD Card

You can use an SD card as a recording medium in the SD slot. See page 42 for the guaranteed media to work with this camera.

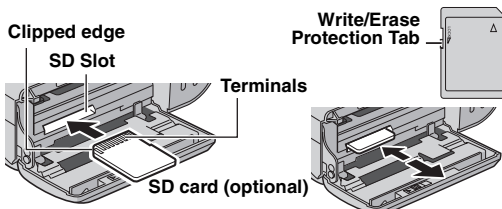

- 1** Perform steps **1 – 3** in "Inserting/Removing a CF Card".

2 To insert a SD card, firmly insert it with its clipped edge first.

To remove a SD card, push it once. After the SD card comes out of the camera, pull it out.

- Do not touch the terminal on the reverse side of the label.

3 Close the rear panel firmly until it locks.

To protect valuable files

Slide the write/erase protection tab on the side of the SD card in the direction of "LOCK". This prevents the SD card from being recorded over. To record on this SD card, slide the tab back to the position opposite to "LOCK" before inserting it.

NOTE:

Before using a new SD card, it is necessary to format the card. (→ pg. 26, 27)



ATTENTION:

Do not insert or remove the SD card while the camera is turned on, as this may cause the SD card to be corrupted or cause the camera to become unable to recognise whether or not the SD card is installed.

Selecting Recording Medium

Select the recording medium before starting recording or playback.

Example: When recording still images to an SD card

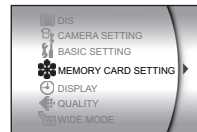

- 1** Open the LCD monitor fully. (→ pg. 18)
- 2** Set the power switch to  or  while pressing down the lock button located on the switch.
- 3** Press **MENU**. The menu screen appears.
- 4** Press Δ / ∇ to select [MEMORY CARD SETTING], and press **▶**/**■**.
- 5** Press Δ / ∇ to select [IMAGE MODE], and press **▶**/**■**.
- 6** Press Δ / ∇ to select [SD SLOT], and press **▶**/**■**.
- 7** Press **MENU** to return to the normal screen.



Date/Time Settings

The date/time is recorded on the picture at all times, but its display can be turned on or off during playback.

(☞ pg. 26, 27)

- 1 Open the LCD monitor fully.
- 2 Set the power switch to  or  while pressing down the lock button located on the switch.
- 3 Press **MENU**. The menu screen appears.
- 4 Press Δ / ∇ to select [DISPLAY], and press \blacktriangleright / \blacksquare . The sub menu appears.
- 5 Press Δ / ∇ to select [CLOCK ADJUST], and press \blacktriangleright / \blacksquare . The day is highlighted.
- 6 Press Δ / ∇ to input the day, and press \blacktriangleright / \blacksquare . Repeat to input the month, year, hour and minute.
- 7 Press **MENU** to return to the normal screen.

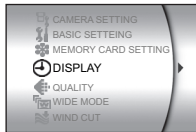

Built-in Clock's Rechargeable Lithium Battery

If the camera is not used for approx. 3 months, the clock's lithium battery will become discharged and the date/time stored in memory will be lost. When this occurs, first connect the camera to an AC outlet using the AC adapter for over 24 hours to charge the clock's rechargeable lithium battery. Then perform the date/time setting before using the camera.

Note that the camera can be used without setting the date/time.

LCD Monitor Adjustment

It is necessary to use the LCD monitor for the camera operation. Make sure to open the LCD monitor whenever you turn on the camera.

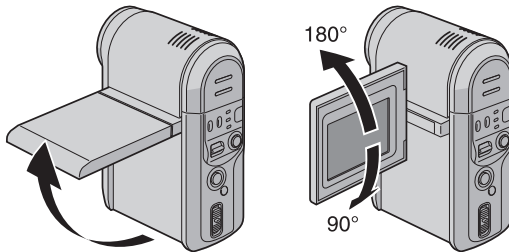



Pull on the bottom end of the LCD monitor to open it.

- The LCD monitor can be rotated 270° (90° downward, 180° upward).

NOTES:

- If the LCD monitor is rotated 180° upward, the LCD monitor faces to the front. It is useful when using self-timer for shooting.
- When the LCD monitor is turned approx. 80° to front, the monitor image appears inverted as it would when viewing a mirror. However, the actual recorded image does not appear inverted.

Operation Mode

To turn on the camera, set the power switch to  or  while pressing down the lock button located on the switch.

● The power/charge lamp turns on.

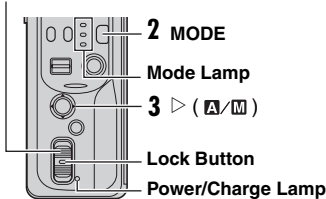

To turn off the camera, set the power switch to **OFF**.

1 Power Switch



Set the appropriate operation mode according to your preference using the power switch, **MODE** and \triangleright (**A/M**) buttons.

1 Power Switch Position

Set the power switch for recording () or playback () while pressing down the lock button.

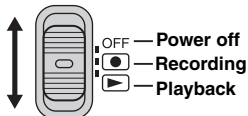



Power Switch

2 Recording/Playback Mode

Press **MODE** to select the recording/playback mode. The selected mode lamp lights up.

 : Video mode ([☞](#) pg. 20, 21)

 : Still image mode ([☞](#) pg. 22, 23)

 : Voice mode ([☞](#) pg. 24)

3 Auto/Manual Mode

Press \triangleright (**A/M**) to switch the auto/manual recording mode. When manual mode is selected, the indicator **M** appears on the LCD monitor.

Auto mode:

You can record using no special effects or manual adjustments.



A/M Manual mode:

Manual recording is possible by setting various functions.

Power-Linked Operation

When the power switch is set to , you can also turn on/off the camera by opening/closing the LCD monitor.

Video Recording

Power Switch

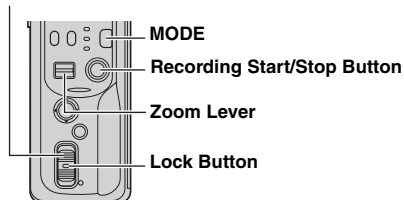

1 Set the power switch to while pressing down the lock button located on the switch.

2 Press **MODE** to select

- The camera is programmed to record videos on the medium in the CF slot by the factory preset. To switch the recording medium, see pages 26 and 27.
- To change the picture quality, see pages 26 and 28.

3 Press the recording start/stop button to start recording.

- Approximate remaining time for recording appears on the display.

4 To stop recording, press the recording start/stop button again.



NOTES:

- If the camera is left without any operation during recording or playback (video, still image or voice) for 5 minutes when using the battery pack, the camera is turned off automatically to conserve power. To turn the camera on again, set the power switch to **OFF**, then to or , or close the LCD monitor then open it again. When using AC adapter, the camera enters the sleep mode (the access lamp lights and the LCD monitor turns off). To cancel the sleep mode, perform any operation such as zooming.
- When the camera heats up, the [REC] indicator flashes. If the camera continues to heat up, shooting may be stopped to protect the recording medium. In this case, turn off the camera power, and then wait until the camera cools down. (⇨ pg. 36)
- When shooting continuously, shooting is automatically stopped when a file size of 4 GB is reached.

- If data cannot be recorded or saved properly, the video files are not saved to the [SD_VIDEO] folder for regular video. Instead, the files are saved to the [EXTMOV] folder used for saving files created on the PC. To play back these files, see "Playing back files created on the PC" (⇨ pg. 21).
- There may be differences in the brightness between the recorded video and still image, even if the same subject is shot.
- To turn the operation sounds off, see page 26.
- For approximate recording time, see page 42.

Zooming

Produces the zoom in/out effect, or an instantaneous change in image magnification.

Zoom In

Slide the zoom lever towards **T**.

Zoom Out

Slide the zoom lever towards **W**.

W: Wide angle

T: Telephoto

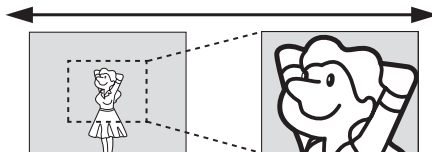

- The further you slide the zoom lever, the quicker the zoom action.
- Refer to the advanced operation manual for details. (⇨ pg. 32)

Deleting Files

If you press during recording mode, the file recorded most recently will be deleted.

- However, if the recording mode (video, still image or voice) is switched or the power is turned off and on again after recording, you cannot delete the file.

Video Playback

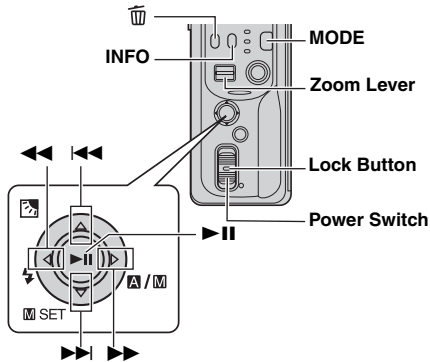

- 1** Set the power switch to while pressing down the lock button located on the switch.
- 2** Press **MODE** to select .

 - The index screen for videos appears. The image appears on the index screen shows the first part of the shooting.
 - To switch the medium to be played back, see pages 26 and 27.

- 3** Press $\Delta \nabla$ $\triangleleft \triangleright$ to select the video file you want to play back.
- 4** Press **▶||** to start playback.
- 5** To pause playback, press **▶||** again.

To return to the index display

Slide the zoom lever to **W** when playback is paused.

To adjust the speaker volume

During playback slide the zoom lever towards **T** to turn up the volume, or towards **W** to turn down the volume.

To turn on/off the on-screen display

Press **INFO** repeatedly.

To check the file information

Press **INFO** when playback is paused.

Playing back files created on the PC

Video files created on the PC are located in the [EXTMOV] folder. (Refer to “SOFTWARE INSTALLATION AND USB CONNECTION GUIDE”.)

Download from www.Somanuals.com. All Manuals Search And Download.

To play these video files, press the recording start/stop button while the index screen is displayed in step **2**, and then proceed to step **3** after [MPG] is displayed.

- The fast forward, rewind, slow, frame-by-frame playback, and playlist creation functions are not available for files in the [EXTMOV] folder.

NOTES:

- The playback picture can be viewed in the LCD monitor or on a connected TV. (☞ pg. 25)
- At the junctions between scenes, the image may stop momentarily or the sound may be interrupted. However, this is not a malfunction.
- To join scenes cleanly, load the video files into the PC and use the provided software to combine the files. When the combined file is used to record a DVD, it will have the same clean joints between scenes as a commercial DVD. Refer to “How To Create DVDs simply” for more about DVD creation.
- The date and time are not displayed during video playback. The recording start date and time can be checked in the file information by pressing **INFO** when playback is paused.
- When a cable is connected to the AV connector, the sound is not heard from the speaker or headphones.

Various Playback Operations

High-speed search

Press $\triangleleft \triangleright$ during playback.

- Each press of the button increases the search speed for each direction. (-60x to +60x)

Locating the start point of the file or skip the file

Press $\triangleleft \triangleright$ during playback or pause mode.

Frame-by-frame playback

Press $\triangleleft \triangleright$ during pause mode.

- Each press of the button advances/reverses the still picture frame by frame.

Slow motion playback

Press $\triangleleft \triangleright$ for 2 or more seconds during pause mode.

Deleting Video Files

Press , then press $\Delta \nabla$ to select [EXECUTE] and press **▶||**.



- You can select the desired file to be deleted by pressing $\triangleleft \triangleright$.
- To delete multiple files at once, see pages 26 and 29.

Still Image Recording

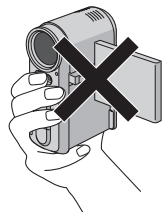
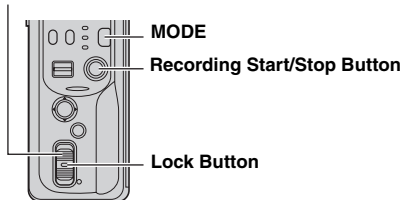
Power Switch



When shooting with the flash, be careful not to cover it.

- 1** Set the power switch to  while pressing down the lock button located on the switch.
- 2** Press **MODE** to select .
 - The camera is programmed to record still images on the medium in the CF slot by the factory preset. To switch the recording medium, see pages 26 and 27.
 - To change the image size and picture quality, see pages 26 and 29.
- 3** Press the recording start/stop button. The still image is recorded.
 - To check how the image looks before recording, press the recording start/stop button halfway and hold. The  indicator appears and stops blinking when the captured image is focused. To cancel the recording, release the recording start/stop button. To record it on the recording medium, press the recording start/stop button fully.

NOTES:

- There may be differences in the brightness between the recorded video and still image, even if the same subject is shot.
- To turn the shutter sound off, see page 26.
- For approximate number of storable images, see page 42.

Continuous Shooting

Keeping the recording start/stop button pressed in step **3** provides an effect similar to serial photography. (Interval between still images: approx. 0.3 seconds)

To use this function, set [CONTINUOUS SHOOTING] to [ON]. (☞ pg. 26, 29)

- Continuous shooting may not work well depending on the recording medium.

Deleting Files

If you press  during recording mode, the file recorded most recently will be deleted.

- However, if the recording mode (video, still image or voice) is switched or the power is turned off and on again after recording, you cannot delete the file.

Still Image Playback

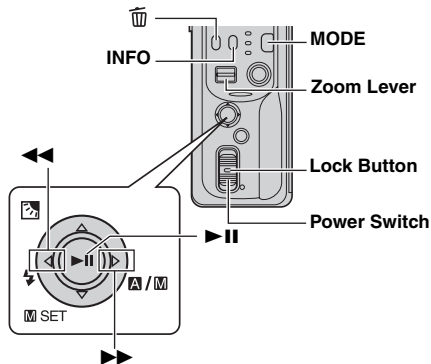

- 1 Set the power switch to while pressing down the lock button located on the switch.
- 2 Press **MODE** to select .
 - A still image is displayed.
 - To switch the medium to be played back, see pages 26 and 27.
- 3 Press to display the previous file. Press to display the next file.

To turn on/off the on-screen display / To check the file information

Press **INFO** repeatedly.

To select the file on the index display

Slide the zoom lever to **W** so that the index display appears. Then press to select the file and press .

NOTES:

- Images shot and stored on the recording media with another device may not be played back correctly.
- You can zoom in/out or rotate still images. For details, read the advanced operation manual. (⇨ pg. 32)

Slide Show

You can playback all the images stored in recording media automatically.

- 1 Perform steps 1 – 2 in the left column.
- 2 Press to start the slide show.
 - If you press during the slide show, files are displayed in descending order.
 - If you press during the slide show, files are displayed in ascending order.
 - To end the slide show, press again.

To display the next image

To display the previous image

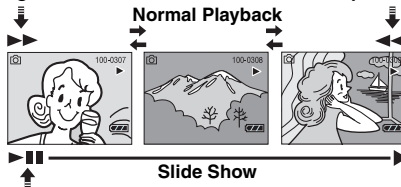

Deleting Still Image Files

Press , then press to select [EXECUTE] and press .

- You can select the desired file to be deleted by pressing .
- To delete multiple files at once, see pages 26 and 29.

Voice Recording

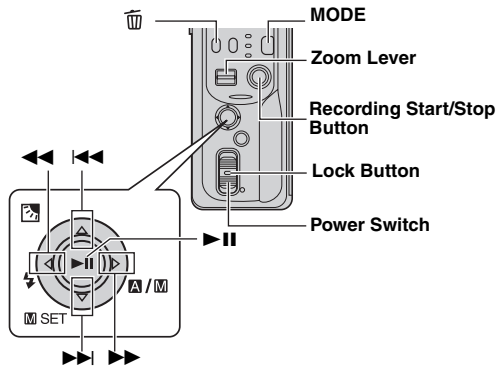

1 Set the power switch to while pressing down the lock button located on the switch.

2 Press **MODE** to select .

- The camera is programmed to record voice on the medium in the CF slot by the factory preset. To switch the recording medium, see pages 26 and 27.
- To change the sound quality and recording level, see pages 26 and 30.

3 Press the recording start/stop button to start recording.

4 To stop recording, press the recording start/stop button again. The camera re-enters the record-standby mode.

NOTE:

For approximate recording time, see page 43.

Deleting Files

If you press during recording mode, the file recorded most recently will be deleted.

- However, if the recording mode (video, still image or voice) is switched or the power is turned off and on again after recording, you cannot delete the file.

Voice Playback

1 Set the power switch to while pressing down the lock button located on the switch.

2 Press **MODE** to select .

- To change the playback speed, see pages 26 and 30.
- To switch the medium to be played back, see pages 26 and 27.

3 Press to start playback.

4 To pause playback, press again.

To adjust the speaker volume

During playback slide the zoom lever towards **T** to turn up the volume, or towards **W** to turn down the volume.

To check the file information

Press **INFO** when playback is paused.

To select the file on the index display

Slide the zoom lever to **W** when playback is paused so that the index display appears. Then press to select the file and press .

Playback Operations

High-Speed Search

Press or during playback.

Locating the start point of the file or skip the file

Press or during playback or pause mode.

Deleting Voice Files

Press , then press to select [EXECUTE] and press .

- You can select the desired file to be deleted by pressing .
- To delete multiple files at once, see pages 26 and 29.

Connecting to a TV or VCR

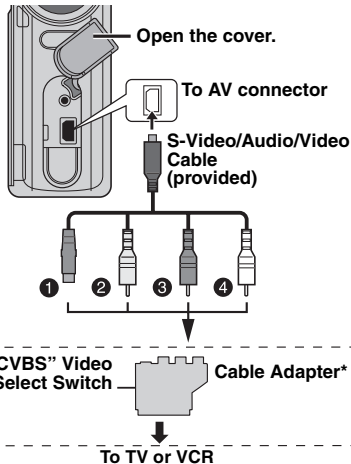

- 1 Black to S-VIDEO IN (Connect when your TV/VCR has S-VIDEO IN and A/V input connectors. In this case, it is not necessary to connect the yellow video cable.)
- 2 Yellow to VIDEO IN (Connect when your TV/VCR has only A/V input connectors.)
- 3 Red to AUDIO R IN**
- 4 White to AUDIO L IN**

* If your TV/VCR has a SCART connector, use the provided cable adapter.

** Not required for watching still images only.

NOTE:

Set the video out select switch of the cable adapter as required:

Y/C: When connecting to a TV or VCR which accepts Y/C signals and uses an S-Video cable.

CVBS: When connecting to a TV or VCR which does not accept Y/C signals and uses a video cable.

- 1 Make sure all units are turned off.
 - 2 Connect the camera to a TV or VCR as shown in the illustration.
- If using a VCR, go to step 3.**
If not, go to step 4.
- 3 Connect the VCR output to the TV input, referring to your VCR's instruction manual.
 - 4 Turn on the camera, the VCR and the TV.
 - 5 Set the VCR to its AUX input mode, and set the TV to its VIDEO mode.
 - 6 Start playback on the camera. (➔ pg. 21)

To choose whether or not the following displays appear on the connected TV

- Date/Time
Set [DATE/TIME] to [AUTO], [ON] or [OFF]. (➔ pg. 26, 27)
- Counter
Set [SCENE COUNTER] to [ON] or [OFF]. (➔ pg. 26, 27)
(Pressing INFO button also turns on/off the displays.)

NOTES:

- It is recommended to use the AC Adapter as the power supply instead of the battery pack. (➔ pg. 14)
- To monitor the picture and sound from the camera without inserting a recording medium, set the camera's power switch to , then set your TV to the appropriate input mode.
- Make sure you adjust the TV sound volume to its minimum level to avoid a sudden burst of sound when the camera is turned on.
- To connect the camera to a PC, refer to the software installation and USB connection guide.

Dubbing to a VCR

- 1 Perform step 1 to 6 above.
- 2 At the point you want to start dubbing, start recording on the VCR. (Refer to the VCR's instruction manual.)
- 3 To stop dubbing, stop recording on the VCR, then stop playback on the camera.

Changing the Menu Settings

You can change the menu settings to customize your camera. Access the desired menu screen by following the steps below, then change the various settings.

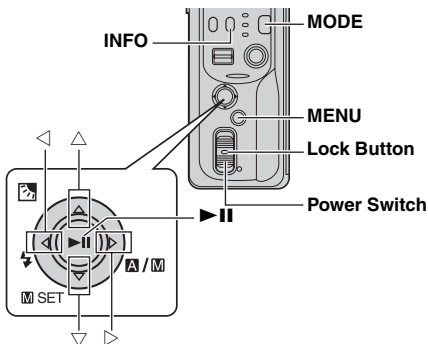

1 Select the operation mode.

For Recording Menus:

Set the power switch to while pressing down the lock button located on the switch.

For Playback Menus:

Set the power switch to while pressing down the lock button located on the switch.

2 Press **MODE** to select (video), (still image) or (voice).

3 Press **MENU**. The menu screen appears.

4 Select the desired sub menu and menu item with \triangle / ∇ and .

- To return to the normal screen, press **MENU**.
- To display the operation guide, press **INFO** when the menu screen is displayed. (The operation guide is not displayed depending on the type of the menu.)
- Even if the menu item is displayed, some item cannot be set depending on the selected mode (video/still image/voice, recording/playback). In this case, it cannot be advanced to sub menu or next menu.

NOTE:

Information on the following pages (⇨ pg. 26 – 31) are only excerpts of menu settings.
Refer to the advanced operation manual in the CD-ROM for the full descriptions. (⇨ pg. 32)

Common Menus for All Modes

[] = Factory-preset

BASIC SETTING

PRESET

EXECUTE: Resets all settings to the factory-preset.

[CANCEL]: Returns to menu screen without executing reset.

DEMO MODE

OFF: Disables the function.

[ON]: Activates demonstration mode and shows various features on the display.

OPERATION SOUND

OFF: Turns off operation sound.

BEEP: The beep sounds when the power is turned on or off, and at the beginning and end of recording.

[MELODY]: Instead of a beep, a melody sounds when any operation is performed.

❁ MEMORY CARD SETTING

VIDEO MODE

[CF SLOT] / SD SLOT

IMAGE MODE

[CF SLOT] / SD SLOT

VOICE MODE

[CF SLOT] / SD SLOT

Media selection can be set for each recording and playback mode: video (📹), still image (📷) or voice (🎤).

CF SLOT: The CF card is selected as a recording medium.

SD SLOT: SD card is selected as a recording medium.

FORMAT

[CF SLOT] / SD SLOT

You can format (initialise) a recording medium in the CF or SD slot.

- You have to format the provided removable hard disk or newly-purchased CF cards and SD cards with this camera before using them. This enables stable speeds and operation when accessing the recording medium.

CLEAN UP

[CF SLOT] / SD SLOT

Writing speed of recording media tends to become slow after long period of repeated use. To regain the speed, execute cleanup periodically.

COPY/MOVE

COPY / MOVE

You can copy or move still image files between recording media in CF and SD slots.

NO. RESET

VIDEO / IMAGE / VOICE

By resetting the file number (name), a new folder will be made. The new files you are going to make will be stored in the new folder.

⌚ DISPLAY

BRIGHT

When this item is selected, the brightness control indicator appears. Adjust the brightness of the display using ◀ ▶, then press ▶⏏.

DATE/TIME

OFF: The date/time does not appear.

[AUTO]: Displays the date/time for approx. 5 seconds when the power switch is set from **OFF** to **🔘**.

ON: The date/time is always displayed.

SCENE COUNTER

[OFF]: Disables the function.

ON: Displays the counter during video mode.

CLOCK ADJUST

📄 "Date/Time Settings" (📄 pg. 18)

Video Recording Menus

[] = Factory-preset

QUALITY

Select the desired picture quality.

Mode (In order of the quality)	Size (pixels)	Bit rate
[ULTRA FINE]	720 x 576	8.5 Mbps
FINE	720 x 576	5.5 Mbps
NORMAL	720 x 576	4.2 Mbps
ECONOMY	352 x 288	1.5 Mbps

WIDE MODE

[OFF]: Disables the function.

D.WIDE: The zoom range is extended beyond the maximum optical zoom wide angle range.

WIND CUT

[OFF]: Disables the function.

ON: Helps cut down on noise created by wind.

GAIN UP

OFF: The image in the dark will be recorded with no picture brightness adjustment.

[ON]: The image in the dark will be brightened. But the overall appearance may become grainy.

DIS

OFF: Disables the function.

[ON]: Compensates for unstable images caused by camera-shake, particularly at high magnification.

CAMERA SETTING

ZOOM

10X: Only optical zoom is available up to 10X.

[40X]: Digital zoom is available up to 40X.

200X: Digital zoom is available up to 200X.

TELE MACRO

[OFF]: Disables the function.

ON: You can shoot a subject as large as possible at a distance of approx. 60 cm.

Video Playback Menus

For the actual operations and details, refer to the advanced operation manual.

[] = Factory-preset

PLAY LIST

[PLAY LIST CONTENTS] / [EDIT] / [RENAME] / [DELETE]

You can create a play list and view your original video clips.

WIPE/FADER

[OFF] / [FADER-WHITE] / [FADER-BLACK] / [FADER-B.W.] / [WIPE-CORNER] / [WIPE-WINDOW] / [WIPE-SLIDE] / [WIPE-DOOR] / [WIPE-SCROLL] / [WIPE-SHUTTER]

You can view videos with various effects of scene transition.

EFFECT

[OFF] / [SEPIA] / [MONOTONE] / [CLASSIC FILM] / [STROBE]

You can view videos with special image effects.

PROTECT

[CURRENT] / [FILE SELECT] / [PROTECT ALL] / [CANCEL ALL]

You can protect files from accidental erasure.

DELETE

[CURRENT] / [FILE SELECT] / [DELETE ALL]

You can delete unnecessary files.

Still Image Recording Menus

[] = Factory-preset

QUALITY

[FINE] / [STANDARD]

Select the desired image quality.

IMAGE SIZE

[1600 x 1200] / [1280 x 960] / [1024 x 768] / [640 x 480]

Select the desired image size.

SELF-TIMER

[OFF] / [2SEC] / [10SEC]

By setting the self-timer, a still image is recorded 2 or 10 seconds after pressing recording start/stop button.

CONTINUOUS SHOOTING

[OFF] / [ON]

 "Continuous Shooting" ( pg. 22)

GAIN

[80] / [160]

Select the ISO sensitivity to the desired setting.

NOTE:

The menu items of TELE MACRO are the same as in the description on page 28.

Still Image Playback Menus

[] = Factory-preset

DPOF

☞ Advanced operation manual

DIRECT PRINT

☞ Advanced operation manual

EFFECT

[OFF] / SEPIA / MONOTONE

You can view still images with special image effects.

NOTE:

The menu items of PROTECT and DELETE are the same as in the description on page 29.

Voice Recording Menus

[] = Factory-preset

QUALITY

Select the desired sound quality.

Mode (In order of the quality)	Bit rate
[FINE]	1,536 kbps
STANDARD	512 kbps
ECONOMY	256 kbps

RECORDING LEVEL

[HIGH] / MIDDLE / LOW

Select the desired voice recording level.

NOTE:

The menu items of WIND CUT are the same as in the description on page 28.

Voice Playback Menus

[] = Factory-preset

PLAYBACK SPEED

[NORMAL] / FASTPLAY / SLOWPLAY

Select the desired voice playback speed.

NOTE:

The menu items of PROTECT and DELETE are the same as in the description on page 29.

Menus for Manual Recording (MSET Menu)

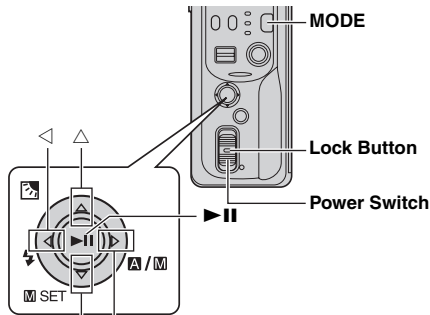

▽ (M SET) ▷ (A/M)

- 1** Set the power switch to while pressing down the lock button located on the switch.
 - 2** Press **MODE** to select or .
 - 3** Press and hold ▷ (A/M) so that is displayed.
 - 4** Press ▽ (M SET). The menu screen appears.
 - 5** Press ◀▷ to select the desired sub menu.
 - 6** Press ▶||. The sub menu appears.
 - 7** Press △▽ (or ◀▷) to select the desired menu item.
 - 8** Press ▶|| again. Selection is complete.
- To return to the normal screen, press ▽ (M SET).

[] = Factory-preset

EXP.

[AUTO*] or [±0**] / ±6* or ±2 (EV)**

Fine exposure adjustment is possible depending on the shooting condition.

* For video recording

** For still image recording

FOCUS

[AUTO] / ◀▶ (manual)

If correct focus may not be obtained depending on the shooting condition, use the manual focus mode.

WB

[AUTO] / MWB / FINE / CLOUD / HALOGEN

You can adjust the white balance setting manually or select an option.

SHUTTER

[AUTO] / 1/2 / 1/4 / 1/8 / 1/15 / 1/30 / 1/50 / 1/120 / 1/250 / 1/500 / 1/1000* / 1/2000* / 1/4000*

You can select the shutter speed depending on the subject and shooting condition.

* Not available for still image recording. If the flash is used, 1/500 is also not available.

P.AE

[OFF] / SPORTS / SNOW / SPOTLIGHT / TWILIGHT

Various programmed effects can be added to the scene.

EFFECT

[OFF] / SEPIA / MONOTONE / CLASSIC FILM / STROBE

Creative effects can be added to the image.

For Advanced Operations

Read the advanced operation manual provided as HTML format in the CD-ROM for more information. To access to the HTML files, follow the procedure below.

- 1 Load the provided CD-ROM onto your PC.
- 2 Right-click on the CD-ROM icon in the [My Computer] window, then click [Open].
- 3 Double-click the [Docs] folder, then double-click the [Manual] folder.

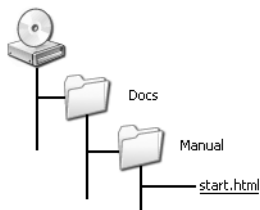

- 4 Double click "start.html".
- 5 Select the language by clicking the language button.
- 6 Now you can see menus on the left side and instructions.

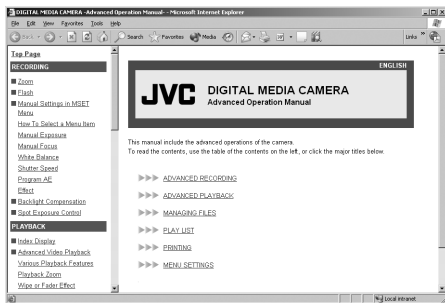

Cleaning the Camera

Before cleaning, turn off the camera and remove the battery pack and AC adapter.

To clean the exterior

Wipe gently with a soft cloth. Put the cloth in diluted mild soap and wring it well to wipe off heavy dirt. Then wipe again with a dry cloth.

To clean the LCD monitor

Wipe gently with a soft cloth. Be careful not to damage the monitor.

To clean the lens

Wipe gently with lens cleaning paper.

NOTES:

- Avoid using strong cleaning agents such as benzine or alcohol.
- Cleaning should be done only after the battery pack has been removed or other power units have been disconnected.
- Mould may form if the lens is left dirty.
- When using a cleaner or chemically treated cloth refer to the cautions of each product.

Troubleshooting

The camera is a microcomputer-controlled device. External noise and interference (from a TV, a radio, etc.) might prevent it from functioning properly.

- To solve the problem, follow the Instructions below at first.
- If the problem is not solved, reset the camera. (Refer to "To reset the camera" below.)
- If the problem still exists, please consult your nearest JVC dealer.

■ To reset the camera

- ① Press and hold **MENU** and **MODE** for approx. 5 seconds. The power is turned off once and turned on again automatically.
- ② If nothing happens, set the power switch to **OFF** and remove the power supply (battery pack or AC adapter) from the camera, then put it back again.

Power

No power is supplied.

- The power is not connected properly.
- Connect the AC Adapter securely. (☞ pg. 14)
- The battery pack is not attached firmly.
- Detach the battery pack once again and re-attach it firmly. (☞ pg. 14)
- The battery is dead.
- Replace the dead battery with a fully charged one. (☞ pg. 14)

Recording

Recording cannot be performed.

- [MEMORY CARD IS FULL] appears.
- Replace with new recording medium or delete unnecessary files. (☞ pg. 16, 29)
- Recording medium is not selected properly.
- Select the recording medium. (☞ pg. 17)
- The rear panel is open.
- Close the cover and set the power switch to **OFF**, then to .

When shooting a subject illuminated by bright light, vertical lines appear.

- This is not a malfunction.

When the screen is under direct sunlight during shooting, the screen becomes red or black for an instant.

- This is not a malfunction.

During recording, the date/time does not appear.

- [DATE/TIME] is set to [OFF].
- Set [DATE/TIME] to [ON]. (☞ pg. 18)

The LCD monitor indications blink.

- Certain modes of wipe/fader, program AE, effect, DIS and other functions that cannot be used together are selected at the same time.

Digital zoom does not work.

- [ZOOM] is set to [10X] (optical zoom).
- Set [ZOOM] to [40X] or [200X]. (☞ pg. 28)

Playback

Playback cannot be performed.

- Recording medium is not selected properly.
- Select the recording medium. (☞ pg. 17)
- The rear panel is open.
- Close the cover and set the power switch to **OFF**, then to .
- Playback starts, but there is no picture on TV.
- Set the TV's input mode or channel appropriate for video playback.

The same image is displayed for a long time during video playback, or motion is choppy.

There are periods of silence during voice playback.

- If the surface of the hard disk is damaged, it makes difficult to read data and these phenomena will appear. This camera will make all possible efforts to read data, but when such a state continues for some time, and further playback is impossible, it will stop automatically.

Advanced features

The focus does not adjust automatically.

- Focus is set to the manual mode.
- Set focus to the automatic mode. (☞ pg. 31)
- The lens is dirty or covered with condensation.
- Clean the lens and check the focus again. (☞ pg. 32)

The colour of the image looks strange.

- The light source or the subject does not include white. Or there are various different light sources behind the subject.
- Try manual white balance adjustment. (Refer to the advanced operation manual in CD-ROM. ⇨ pg. 32)

The recorded image is too dark.

- Shooting was performed under backlit conditions.
- Try backlight compensation. (Refer to the advanced operation manual in CD-ROM. ⇨ pg. 32)

The recorded image is too bright.

- The subject is too bright.
- Set [P. AE] to [SPOTLIGHT]. (⇨ pg. 31)

White balance setting cannot be activated.

- The sepia (SEPIA) or monotone (MONOTONE) mode is activated.
- Turn off the sepia (SEPIA) or monotone (MONOTONE) mode before setting white balance. (⇨ pg. 31)

The black & white fader does not work.

- The sepia (SEPIA) or monotone (MONOTONE) mode is activated.
- Turn off the sepia (SEPIA) or monotone (MONOTONE) mode. (⇨ pg. 31)

The image looks like the shutter speed is too slow.

- When shooting in the dark, the unit becomes highly sensitive to light when [GAIN UP] is set to [ON].
- If you want the lighting to look more natural, set [GAIN UP] to [OFF]. (⇨ pg. 28)

The continuous shooting speed of still images is slow.

- The continuous shooting speed will drop when repeatedly making continuous shots, when using certain recording medium, or under certain recording conditions.

Other problems

The power/charge lamp on the camera does not light during charging.

- Charging is difficult in places subject to extremely high/low temperatures.
- To protect the battery, it is recommended to charge it in places with a temperature of 10°C to 35°C. (⇨ pg. 37)
- The battery cover is open.
- Close the cover. (⇨ pg. 14)

The data process is too slow after the power is switched on or the mode is changed.

- There is a large number of still images (approx. 1,000 or more) stored in the recording medium.
- Copy the stored files to a PC, and delete them from the recording medium.

[SET DATE/TIME!] appears.

- The built-in clock's rechargeable lithium battery is discharged.
- The previously set date/time is erased.
- Connect the camera to an AC outlet using the AC Adapter for over 24 hours to charge the clock's lithium battery. Then set the date/time. (⇨ pg. 18)

Files cannot be deleted.

- Files are protected.
- Remove protection from the files and delete them. (⇨ pg. 29)

When the image is printed from the printer, a black bar appears at the bottom of the screen.

- This is not a malfunction.
- By recording with DIS activated, this can be avoided. (⇨ pg. 28)

Images on the LCD monitor appear dark or whitish.

- In places subject to low temperature, images become dark due to the characteristics of the LCD monitor. This is not a malfunction.
- Adjust the brightness and angle of the LCD monitor. (⇨ pg. 18, 27)
- When the LCD monitor's fluorescent light reaches the end of its service life, images on the LCD monitor become dark.
- Consult your nearest JVC dealer.

Coloured bright spots appear all over the LCD monitor.

- The LCD monitor is made with high precision technology. However, black spots or bright spots of light (red, green or blue) may appear constantly on the LCD monitor. These spots are not recorded on the picture. This is not due to any defect of the unit. (Effective dots: more than 99.99 %)

The SD card cannot be removed from the camera.

- Push in the SD card a few more times.

Picture does not appear on the LCD monitor.

- The LCD monitor's brightness setting is too dark.
- Adjust the brightness of the LCD monitor. (⇨ pg. 27)

Warning Indications

The following indications appear on the screen.

(Battery indicator)

Displays the battery remaining power.

Remaining power level

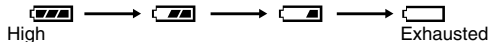

- As the battery power comes close to nil, the battery indicator blinks. When the battery power is exhausted, power turns off automatically.

SET DATE/TIME!

- Appears when the date/time is not set. (⇨ pg. 18)
- Appears when the built-in clock (lithium) battery is discharged and the previously set date/time is erased. (⇨ pg. 18)

LENS CAP

Appears for 5 seconds after power is turned on if the lens cap is attached or when it is dark.

PLEASE INSERT MEMORY CARD

Appears when no recording medium is inserted in the selected slot. (⇨ pg. 16)

THIS CARD IS NOT FORMATTED

Appears when an unformatted recording medium is inserted.

MEMORY CARD IS FULL

Appears when the recording medium is full and recording is not possible.

CHECK CARD'S WRITE PROTECTION SWITCH

Appears when you attempt recording when the write protection tab on the SD card is set to the "LOCK" position.

THIS CARD IS NOT FOR RECORDING VIDEO

Appears when a recording medium which is not capable of video recording is inserted. Use the guaranteed recording medium to work with this camera. (⇨ pg. 42)

UNSUPPORTED FILE!

Appears when playing back a file that is not compatible with this camera's file format.

NO VIDEO FILES STORED!

Appears if there are no video files when you attempt video playback.

NO IMAGE FILES STORED!

Appears if there are no still image files when you attempt still image playback.

NO VOICE FILES STORED!

Appears if there are no voice files when you attempt voice playback.

THIS CARD IS NOT FOR CONTINUOUS SHOOTING

Appears when the recording medium is not capable of continuous shooting. Use the guaranteed recording medium to work with this camera. (⇨ pg. 42)

CLOSE COVER

Appears when the recording medium cover is opened during file copy/move operation.

NO MEMORY CARD

Appears when recording media are not inserted to both of slots for file copy/move operation.

NO SUPPORTED FILES

Appears when there is no JPEG (still image) files to be copied or moved in recording media.

NUMBER OF FOLDERS OVERFLOW

Appears when the number of folders exceeds the limit for file copy/move operation.

MEMORY CARD ERROR!**REINSERT CARD OR CHANGE CARD**

Appears when the camera does not recognise the loaded recording medium. Remove the medium once and insert it again or replace with another medium.

FILE SYSTEM MAY HAVE PROBLEM**FORMAT IS RECOMMENDED AFTER COPYING****WANTED DATA**

The file system of the recording medium may have a problem. It is recommended to copy the data for backup, then format the medium.

VIDEO MANAGEMENT FILE IS BROKEN**TO RECORD/PLAYBACK VIDEO, RECOVERY IS REQUIRED**

The video management file is broken. Recovery is required to record or play back video files. Press \triangle ∇ to select [YES], then press **▶||** to recover the video management file. If the desired video file is not displayed on the video index screen in spite of the file recovery, the file is moved to the [EXTMOV] folder. Press the recording start/stop button in the index screen to display [MPG], and then select the desired file.

NO VIDEO MANAGEMENT FILE**VIDEO FILES HAVE BEEN MOVED TO MPEG FOLDER**

The data cannot be recorded properly, or the video management file is deleted or not found. The extension of the corresponding video file is changed from “.MOD” to “.MPG”. Video files have been moved to MPEG (EXTMOV) folder.

PLAY LIST'S MANAGEMENT INFORMATION IS BROKEN**REMAKE PLAY LIST AGAIN**

The management information of play list is broken. Create the play list again.

NO REGISTERED SCENES IN PLAY LIST**SOME OF SCENES MAY NOT BE PLAYED BACK**

The video files registered in the play list do not exist. Some of the scenes may not be played back.

REGISTERED SCENES IN PLAY LIST IS EMPTY**THIS PLAY LIST WILL BE DELETED**

There is no scenes registered in the play list. The play list will be deleted.

CAMERA TEMPERATURE IS GOING UP**TURN CAMERA OFF, PLEASE WAIT**

The temperature of the camera is too high. Turn off the power, then wait for a while.

CAMERA TEMPERATURE IS TOO LOW**KEEP CAMERA POWER ON, PLEASE WAIT**

The temperature of the camera is too low. Keep the power on and wait for a while.

RECORDING FAILURE

- Performance of recording medium is poor. Use the Cleanup function [CLEAN UP] in the menu.
- The writing speed of recording medium is slow, or the recording medium is corrupted. Use the recording medium to which the operation is guaranteed. See page 42 for the guaranteed media to work with this camera.
- The recording medium was subjected to vibrations or jolts. Be careful not to subject the recording medium to vibrations or jolts.

RECORDING MAY NOT BE CORRECT ON THE MEMORY CARD

The data may not be recorded on the recording medium correctly. Try recording again. Otherwise, clean up the recording medium.

MEMORY CARD CANNOT BE PLAYED BACK CORRECTLY

The recording medium cannot be played back correctly. Try playback again.

CANNOT USE IN VIDEO MODE

The operation is not available in the video mode.

Cautions

Battery Packs

The supplied battery pack is a lithium-ion battery. Before using the supplied battery pack or an optional battery pack, be sure to read the following cautions:

- **To avoid hazards**

... **do not** burn.

... **do not** short-circuit the terminals. When transporting, make sure the provided battery cap is attached to the battery. If the battery cap is misplaced, carry the battery in a plastic bag.

... **do not** modify or disassemble.

... **do not** expose the battery to temperatures exceeding 60°C, as this may cause the battery to overheat, explode or catch fire.

... use only specified chargers.

Terminals

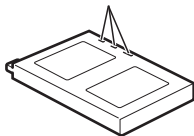

- **To prevent damage and prolong service life**

... do not subject to unnecessary shock.

... charge in an environment where temperatures are within the tolerances shown in the chart below. This is a chemical reaction type battery — cooler temperatures impede chemical reaction, while warmer temperatures can prevent complete charging.

... store in a cool, dry place. Extended exposure to high temperatures will increase natural discharge and shorten service life.

... fully charge and then fully discharge the battery every 6 months when storing the battery pack over a long period time.

... remove from charger or powered unit when not in use, as some machines use current even when switched off.

NOTES:

- It is recommended that only genuine JVC batteries are used in this camera. Using generic non-JVC batteries can cause damage to the internal charging circuitry.

- It is normal for the battery pack to be warm after charging, or after use.

Temperature range specifications

Charging: 10°C to 35°C

Operation: 0°C to 40°C

Storage: -20°C to 50°C

- The lower the temperature, the longer recharging takes.
- Charging times are for a fully discharged battery pack.

Recording Medium

- **Be sure to follow the guidelines below to prevent corruption or damage to your recorded data.**
 - Do not bend or drop the recording medium, or subject it to strong pressure, jolts or vibrations.
 - Do not splash the disk with water.
 - Do not use, replace, or store the disk in locations that are exposed to strong static electricity or electrical noise.
 - Do not turn off the camera power or remove the battery or AC adapter during shooting, playback, or when otherwise accessing the recording medium.
 - Do not bring the recording medium near objects that have a strong magnetic field or that emit strong electromagnetic waves.
 - Do not store the recording medium in locations with high temperature or high humidity.
 - Do not touch the metal parts.
- **Copy the recorded files to your PC. JVC shall not be responsible for any lost data. (It is recommended that you copy the data from your PC to DVD or other media for storage.)**
- **A malfunction may cause the recording medium to fail to operate properly. JVC shall not provide any compensation for any lost contents.**

LCD Monitor

- **To prevent damage to the LCD monitor, DO NOT**
 - ...push it strongly or apply any shocks.
 - ...place the camera with LCD monitor on the bottom.
- **To prolong service life**
 - ...avoid rubbing it with coarse cloth.
- **Be aware of the following phenomena for LCD monitor use. These are not malfunctions.**
 - ... While using the camera, the surface around the LCD monitor and/or the back of the LCD monitor may heat up.
 - ... If you leave power on for a long time, the surface around the LCD monitor becomes hot.

Main Unit

- **For safety, DO NOT**
 - ... open the camera's chassis.
 - ...disassemble or modify the unit.
 - ...short-circuit the terminals of the battery pack. Keep it away from metallic objects when not in use.
 - ...allow inflammables, water or metallic objects to enter the unit.
 - ...remove the battery pack or disconnect the power supply while the power is on.
 - ...leave the battery pack attached when the camera is not in use.
- **Avoid using the unit**
 - ...in places subject to excessive humidity or dust.
 - ...in places subject to soot or steam such as near a cooking stove.
 - ...in places subject to excessive shock or vibration.
 - ...near a television set.
 - ...near appliances generating strong magnetic or electric fields (speakers, broadcasting antennas, etc.).
 - ...in places subject to extremely high (over 40°C) or extremely low (under 0°C) temperatures.
- **DO NOT leave the unit**
 - ...in places of over 50°C.
 - ...in places where humidity is extremely low (below 35%) or extremely high (above 80%).
 - ...in direct sunlight.
 - ...in a closed car in summer.
 - ...near a heater.
- **To protect the unit, DO NOT**
 - ...allow it to become wet.
 - ...drop the unit or strike it against hard objects.
 - ...subject it to shock or excessive vibration during transportation.
 - ...keep the lens directed at extremely bright objects for long periods.
 - ...expose the lens to direct sunlight.
 - ...carry it by holding the LCD monitor.
 - ...swing it excessively when using the hand strap or the grip.
 - ...swing the soft camera case excessively when the camera is inside it.

How to Handle a CD-ROM

- Take care not to soil or scratch the mirror surface (opposite to the printed surface). Do not write anything or put a sticker on either the front or back surface. If the CD-ROM gets dirty, gently wipe it with a soft cloth outward from the centre hole.
- Do not use conventional disc cleaners or cleaning spray.
- Do not bend the CD-ROM or touch its mirror surface.
- Do not store your CD-ROM in a dusty, hot or humid environment. Keep it away from direct sunlight.

Serious malfunctioning

If malfunctioning occurs, stop using the unit immediately and consult your local JVC dealer. When requesting repairs for malfunctioning by your dealer or JVC service center, be sure to bring your camera together with the removable hard disk. If one of them is not included, the cause cannot be diagnosed, and the repair cannot be made properly.

The camera is a microcomputer-controlled device. External noise and interference (from a TV, a radio, etc.) might prevent it from functioning properly. In such cases, first disconnect its power supply unit (battery pack, AC adapter, etc.) and wait a few minutes and then re-connect it and proceed as usual from the beginning.

Specifications

Camera

For general

Power supply

DC 11 V (Using AC adapter)

DC 7.2 V (Using battery pack)

Power consumption

Approx. 4.9 W

Approx. 7.7 W (Maximum; when charging a battery)

Dimensions (W x H x D)

41 mm x 103 mm x 71 mm

Weight

Approx. 245 g

(without battery, removable hard disk, lens cap and hand strap)

Approx. 315 g

(incl. battery, removable hard disk, lens cap and hand strap)

Operating temperature

0°C to 40°C

Operating humidity

35% to 80%

Storage temperature

-20°C to 50°C

Pickup

1/3.6" CCD

Lens

F 1.8 to 2.2, f = 4.5 mm to 45 mm, 10:1 power zoom lens

Filter diameter

ø30.5 mm

LCD monitor

1.8" diagonally measured, LCD panel/TFT active matrix system

Speaker

Monaural

Flash

Within 2 m (recommended shooting distance)

For video/audio

Format

SD-VIDEO

Recording/Playback format

Video: MPEG-2-PS

Audio: Dolby Digital (2 ch)

Signal format

PAL standard

Recording mode (video)

ULTRA FINE: 720 x 576 pixels, 8.5 Mbps (CBR)

FINE: 720 x 576 pixels, 5.5 Mbps (CBR)

NORMAL: 720 x 576 pixels, 4.2 Mbps (VBR)

ECONOMY: 352 x 288 pixels, 1.5 Mbps (VBR)

Recording mode (audio)

ULTRA FINE: 48 kHz, 384 kbps

FINE: 48 kHz, 384 kbps

NORMAL: 48 kHz, 256 kbps

ECONOMY: 48 kHz, 128 kbps

For still image

Format

JPEG

Image size

4 modes (1600 x 1200 / 1280 x 960 / 1024 x 768 / 640 x 480)

Picture quality

2 modes (FINE/STANDARD)

For voice

Format

Linear PCM

Recording mode

FINE: 48 kHz, 1,536 kbps, 16 bit, stereo

STANDARD: 16 kHz, 512 kbps, 16 bit, stereo

ECONOMY: 8 kHz, 256 kbps, 16 bit, stereo

For connectors**AV**

S-Video output:

Y: 1.0 V (p-p), 75 Ω analogue

C: 0.29 V (p-p), 75 Ω analogue

Video output: 1.0 V (p-p), 75 Ω analogue

Audio output: 300 mV (rms), 1 k Ω analogue, stereo

Headphone output

\varnothing 2.5 mm, stereo

USB

Mini USB-B type, USB 1.1/2.0 compliant

AC Adapter**Power requirement**

AC 110 V to 240 V \sim , 50 Hz/60 Hz

Output

DC 11 V --- , 1 A

Design and specifications subject to change without notice.

Recording Time and Number of Images

The tables below show the approximate recording time and number of storable images.

- The number increases or decreases depending on the image size, picture quality and other conditions (pg. 28, 29, 30). The first column in the table indicates the conditions.
- The provided 4 GB removable hard disk is indicated with * mark.

Compatible recording media

The following recording media have been guaranteed to work with this camera. Others are not guaranteed to work, so buy such products with caution.

Removable hard disks: Microdrive® from Hitachi, JVC Microdrive® (CU-MD04)

CompactFlash cards: By LEXAR, SanDisk and Hagiwara Sys-Com

SD memory cards: By Panasonic, TOSHIBA and SanDisk

- If other media are used, they may fail to record data correctly, or they may lose data that has already been recorded.
- Microdrive® of 1 GB or less are not supported.
- MultiMediaCards are not supported.
- For video recording and continuous shooting of still images, use a removable hard disk, high-speed CompactFlash card (at least 40x speed) or SD memory card (at least 10 MB/s).

 : Approximate recording time (for video)

(The numbers indicate "minutes".)

- Removable hard disk

Quality	2 GB	4 GB*
ULTRA FINE	30	60
FINE	45	90
NORMAL	60	120
ECONOMY	150	300

- SD Card/CompactFlash Card

Quality	128 MB	256 MB	512 MB	1 GB
ULTRA FINE	2	4	8	16
FINE	3	6	12	24
NORMAL	4	7	15	31
ECONOMY	10	21	43	86

 : Approximate number of storable images (for still image)

- Removable hard disk

Image size/quality	2 GB	4 GB*
640 x 480/FINE	9999	9999
640 x 480/STANDARD	9999	9999
1024 x 768/FINE	6826	9999
1024 x 768/STANDARD	9999	9999
1280 x 960/FINE	4376	8752
1280 x 960/STANDARD	9999	9999
1600 x 1200/FINE	2797	5595
1600 x 1200/STANDARD	9142	9999

- SD Card

Image size/quality	32 MB	64 MB	256 MB	1 GB
640 x 480/FINE	205	425	2210	7756
640 x 480/STANDARD	375	755	5200	9999
1024 x 768/FINE	95	200	855	3412
1024 x 768/STANDARD	185	375	1715	9999
1280 x 960/FINE	60	125	550	2188
1280 x 960/STANDARD	120	250	1100	7110
1600 x 1200/FINE	34	65	285	1398
1600 x 1200/STANDARD	50	110	480	4570

- CompactFlash Card

Image size/quality	64 MB	128 MB	256 MB	1 GB
640 x 480/FINE	425	1115	2235	7756
640 x 480/STANDARD	755	2605	5215	9999
1024 x 768/FINE	200	430	865	3412
1024 x 768/STANDARD	375	865	1735	9999
1280 x 960/FINE	125	280	560	2188
1280 x 960/STANDARD	250	560	1120	7110
1600 x 1200/FINE	65	145	290	1398
1600 x 1200/STANDARD	110	245	490	4570

 : Approximate recording time (for voice)

(The numbers indicate “minutes”.)

- Removable hard disk

Quality	4 GB*
FINE	320
STANDARD	960
ECONOMY	1960

JVC

Free Manuals Download Website

<http://myh66.com>

<http://usermanuals.us>

<http://www.somanuals.com>

<http://www.4manuals.cc>

<http://www.manual-lib.com>

<http://www.404manual.com>

<http://www.luxmanual.com>

<http://aubethermostatmanual.com>

Golf course search by state

<http://golfingnear.com>

Email search by domain

<http://emailbydomain.com>

Auto manuals search

<http://auto.somanuals.com>

TV manuals search

<http://tv.somanuals.com>