



PLASMA DISPLAY MONITOR

GD-V501U

INSTRUCTIONS

For customer Use:

Enter below the Model No. and the Serial No. which is located on the rear panel of the cabinet. Retain this information for future reference.

Model No. _____

Serial No. _____

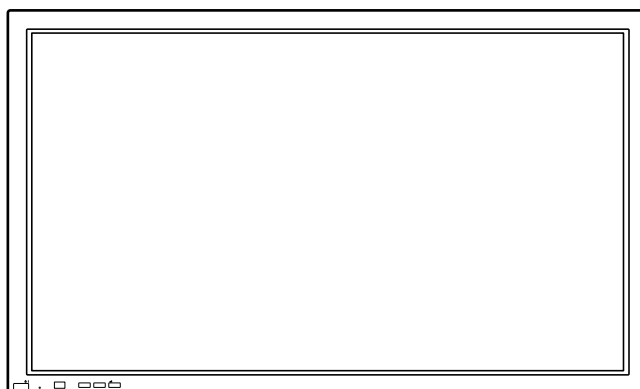



The lightning flash with arrow-head within a triangle is intended to tell the user that parts inside the product are a risk of electric shock to persons.



The exclamation point within a triangle is intended to tell the user that important operating and servicing instructions are in the papers with the appliance.

WARNING: To prevent damage which may result in fire or shock hazard, do not expose this appliance to rain or moisture. Do not place containers with water (flower vase, cups, cosmetics, etc.) above the set. (including on shelves above, etc.)

WARNING: 1) To prevent electric shock, do not remove cover. No user serviceable parts inside. Refer servicing to qualified service personnel.
2) Do not remove the grounding pin on the power plug. This apparatus is equipped with a three pin grounding-type power plug. This plug will only fit a grounding-type power outlet. This is a safety feature. If you are unable to insert the plug into the outlet, contact an electrician.
Do not defeat the purpose of the grounding plug.

Important Safety Instructions

- 1) Read these instructions.
All the safety and operating instructions should be read before the appliance is operated.
- 2) Keep these instructions.
The safety and operating instructions should be retained for future reference.
- 3) Heed all warnings.
All warnings on the appliance and in the operating instructions should be adhered to.
- 4) Follow all instructions.
All operating and use instructions should be followed.
- 5) Do not use this apparatus near water.
For example, near a bathtub, wash bowl, kitchen sink, or laundry tub, in a wet basement, or near a swimming pool, and the like.
- 6) Clean only with dry cloth.
Do not use liquid cleaners or aerosol cleaners. Use a dry cloth for cleaning.
- 7) Do not block any ventilation openings. Install in accordance with the manufacturer's instructions.
Slots and Openings in the cabinet are provided for ventilation and to ensure reliable operation of the product and to protect it from overheating. The openings should never be blocked by placing the product on a bed, sofa, rug, or other similar surface.
- 8) Do not install near any heat sources such as radiators, heat registers, stoves, or other apparatus (including amplifiers) that produce heat.
This product should not be placed in a built-in installation such as a bookcase or rack unless proper ventilation is provided or the manufacturer's instructions have been adhered to.
- 9) Do not defeat the safety purpose of the polarized or grounding-type plug. A polarized plug has two blades with one wider than the other. A grounding type plug has two blades and a third grounding prong. The wide blade or the third prong are provided for your safety. If the provided plug does not fit into your outlet, consult an electrician for replacement of the obsolete outlet.
- 10) Protect the power cord from being walked on or pinched particularly at plugs, convenience receptacles, and the point where they exit from the apparatus.
- 11) Only use attachments / accessories specified by the Manufacturer.
- 12) Use only with the cart, stand, tripod, bracket, or table specified by the manufacturer, or sold with the apparatus. When a cart is used, use caution when moving the cart / apparatus combination to avoid injury from tip-over.
Quick stops, excessive force, and uneven surfaces may cause the appliance and cart combination to overturn.
- 13) Unplug this apparatus during lightning storms or when unused for long periods of time.
This will prevent damage to the product due to lightning and power-line surges.
- 14) Refer all servicing to qualified service personnel. Servicing is required when the apparatus has been damaged in any way, such as power-supply cord or plug is damaged, liquid has been spilled or objects have fallen into the apparatus, the apparatus has been exposed to rain or moisture, does not operate normally, or has been dropped.
- 15) To prevent electric shock, ensure the grounding pin on the AC cord power plug is securely connected.



Dear JVC Customer

Welcome to the JVC family of customers. We hope that you will have many years of enjoyment from your new Plasma Display.

To obtain maximum benefit from your set, please read these Instructions before making any adjustments, and retain them for future reference.

Retain your purchase receipt also, and note down the model number and serial number of your set in the space provided on the rear cover of these instructions.

Table of Contents

Important Safety Instructions	3	Adjusting PICTURE POSITION/SIZE	24
FCC STATEMENT	5	SOUND Adjustment	26
Safety Precautions	6	MUTE	26
Accessories	8	SURROUND Controls	27
Accessories Supplied	8	PICTURE Adjustments	28
Optional Accessories	8	ADVANCED SETTINGS	29
Remote Control Batteries	9	SET UP TIMER	30
Basic Controls	10	PRESENT TIME OF DAY Set	30
Connections	11	TIMER Set	31
Speakers connection	12	SCREENSAVER (For preventing after-images)	32
AV Input Terminals connection	12	Setup of SCREENSAVER Time	33
AV Input connection	13	SIDE BAR ADJUST	33
VIDEO OUT	13	SET UP for Input Signals	34
COMPONENT/RGB Input connection	14	COMPONENT/RGB IN SELECT	34
PC Input Terminals connection	15	3D Y/C FILTER – For NTSC Video images	34
SERIAL Terminals connection	17	COLOR SYSTEM / ASPECT AUTO	35
Power ON/OFF and Input Signal Selection	18	3:2 PULLDOWN	35
AC cord connection	18	SYNC	36
Power ON/OFF	18	H-FREQ. (kHz)/V-FREQ. (Hz)	36
Select the Input Signal	19	Troubleshooting	37
Selecting the ON-Screen Menu Language	19	Specifications	38
On-Screen Menu Display from Remote Control	20		
ASPECT Controls	22		

FCC STATEMENT

FCC STATEMENT

This equipment has been tested and found to comply with the limits for a Class A digital device, pursuant to part 15 of the FCC Rules. These limits are designed to provide reasonable protection against harmful interference when the equipment is operated in a commercial environment.

This equipment generates, uses, and can radiate radio frequency energy and, if not installed and used in accordance with the instruction manual, may cause harmful interference to radio communications. Operation of this equipment in a residential area is likely to cause harmful interference in which case the user will be required to correct the interference at his own expense.

FCC CAUTION:

Pursuant to 47CFR, Part 15.21 of the FCC rules, any changes or modifications to this monitor not expressly approved by Matsushita Electric Corporation of America could cause harmful interference and would void the user's authority to operate this device.

Attach the ferrite core:

The ferrite cores provided as a supplied accessory must be used when connecting this Plasma Display to video equipment. (see page 15, 17)

FCC CAUTION:

To assure continued compliance and possible undesirable interference, the provided ferrite cores must be used when connecting this plasma display to video equipment; and maintain at least 40cm spacing to other peripheral devices. Refer to instructions on pages 15, and 17.

CANADIAN NOTICE:

This Class A digital apparatus complies with Canadian ICES-003.

Note:

Do not allow a still picture to be displayed for an extended period, as this can cause a permanent after-image to remain on the Plasma Display.

Examples of still pictures include logos, video games, computer images, teletext and images displayed in 4:3 mode.

Trademark Credits

- VGA is a trademark of International Business Machines Corporation.
- Macintosh is a registered trademark of Apple Computer, USA.
- S-VGA is a registered trademark of the Video Electronics Standard Association.

Even if no special notation has been made of company or product trademarks, these trademarks have been fully respected.

Safety Precautions

WARNING

Set up

Do not place the Plasma Display on sloped or unstable surfaces.

- The Plasma Display may fall off or tip over.

Do not place any objects on top of the Plasma Display.

- If water spills onto the Plasma Display or foreign objects get inside it, a short-circuit may occur which could result in fire or electric shock. If any foreign objects get inside the Plasma Display, please consult an Authorized Service Center.

Do not cover the ventilation holes.

- Doing so may cause the Plasma Display to overheat, which can cause fire or damage to the Plasma Display.

If using the pedestal (optional accessory), leave a space of 3 15/16" (10 cm) or more at the top, left and right, 2 3/8" (6 cm) or more at the bottom, and 2 3/4" (7 cm) or more at the rear. If using some other setting-up method, leave a space of 3 15/16" (10 cm) or more at the top, bottom, left and right, and 3/4" (1.9 cm) or more at the rear.

Avoid installing this product near electronic equipment that is easy to receive electromagnetic waves.

- It may cause interference in image, sound, etc. In particular, keep video equipment away from this product.

AC Power Supply Cord

The Plasma Display is designed to operate on 120 V AC, 50Hz/60Hz.

Securely insert the power cord plug as far as it will go.

- If the plug is not fully inserted, heat may be generated which could cause fire. If the plug is damaged or the wall socket plate is loose, they should not be used.

Do not handle the power cord plug with wet hands.

- Doing so may cause electric shocks.

Do not do anything that might damage the power cable. When disconnecting the power cable, hold the plug, not the cable.

- Do not make any modifications, place heavy objects on, place near hot objects, heat, bend, twist or forcefully pull the power cable. Doing so may cause damages to the power cable which can cause fire or electric shock. If damage to the cable is suspected, have it repaired at an Authorized Service Center.

If the Plasma Display is not in use for a long period of time, unplug the power cord from the wall outlet.

If problems occur during use

If a problem occurs (such as no picture or no sound), or if smoke or an abnormal odor is detected from the Plasma Display, unplug the power cord immediately.

- Continuous use of the Display under these conditions might cause fire or permanent damage to the unit. Have the Display evaluated at an Authorized Service Center. Services to the Display by any unauthorized personnel are strongly discouraged due to its high voltage dangerous nature.

If water or foreign objects get inside the Plasma Display, if the Plasma Display is dropped, or if the cabinet becomes damaged, disconnect the power cord plug immediately.

- A short may occur, which could cause fire. Contact an Authorized Service Center for any repairs that need to be made.

CAUTION

This Plasma Display is for use only with the following optional accessories. Use with any other type of optional accessories may cause instability which could result in the possibility of injury.

(All of the following accessories are manufactured by JVC)

- Speakers TS-C5000SPG
- Stand Unit TS-C50P1G
- Wall Mounting Unit TS-C50P6G
- Wall Mounting Unit (angled) TS-C50P2G
- Ceiling Suspension Unit TS-C50P3G

Always be sure to ask a qualified technician to carry out set-up.

When using the Plasma Display

Do not bring your hands, face or objects close to the ventilation holes of the Plasma Display.

- Top of Plasma Display is usually very hot due to the high temperature of exhaust air being released through the ventilation holes. Burns or personal injuries can happen if any body parts are brought too close. Placing any object near the top of the display could also result in heat damages to the object as well as to the Display if its ventilation holes are blocked.

Be sure to disconnect all cables before moving the Plasma Display.

- Moving the Display with its cables attached might damage the cables which, in turn, can cause fire or electric shock.

Disconnect the power plug from the wall outlet as a safety precaution before carrying out any cleaning.

- Electric shocks can result if this is not done.

Clean the power cable regularly to prevent it from becoming dusty.

- Built-up dust on the power cord plug can increase humidity which might damage the insulation and cause fire. Unplug the cord from the wall outlet and clean it with a dry cloth.

This Plasma Display radiates infrared rays, therefore it may affect other infrared communication equipment. Install your infrared sensor in a place away from direct or reflected light from your Plasma Display.

Cleaning and maintenance

The front of the display panel has been specially treated. Wipe the panel surface gently using only a cleaning cloth or a soft, lint-free cloth.

- If the surface is particularly dirty, soak a soft, lint-free cloth in a weak detergent solution and then wring the cloth to remove excess liquid. Use this cloth to wipe the surface of the display panel, then wipe it evenly with a dry cloth, of the same type, until the surface is dry.
- Do not scratch or hit the surface of the panel with fingernails or other hard objects. Furthermore, avoid contact with volatile substances such as insect sprays, solvents and thinner, otherwise the quality of the surface may be adversely affected.

If the cabinet becomes dirty, wipe it with a soft, dry cloth.

- If the cabinet is particularly dirty, soak the cloth in a weak detergent solution and then wring the cloth dry. Use this cloth to wipe the cabinet, and then wipe it dry with a dry cloth.
- Do not allow any detergent to come into direct contact with the surface of the Plasma Display. If water droplets get inside the unit, operating problems may result.
- Avoid contact with volatile substances such as insect sprays, solvents and thinner, otherwise the quality of the cabinet surface may be adversely affected or the coating may peel off. Furthermore, do not leave it for long periods in contact with articles made from rubber or PVC.

Note:

Do not allow a still picture to be displayed for an extended period, as this can cause a permanent after-image to remain on the Plasma Display.

Examples of still pictures include logos, video games, computer images, teletext and images displayed in 4:3 mode.

Accessories

Accessories Supplied

Check that you have the Accessories and items shown



Operating Instruction book

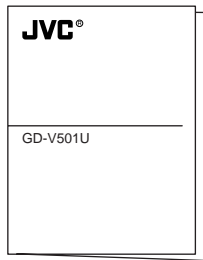

Remote Control Transmitter

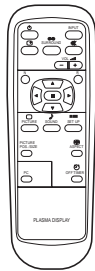

Batteries for the Remote Control Transmitter (AA(R6) Battery × 2)

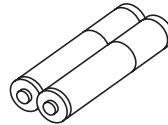

AC cord

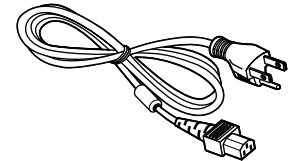

Ferrite core (small size) × 1

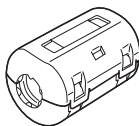

Ferrite core (large size) × 2

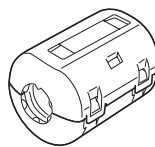

Fixing bands × 2

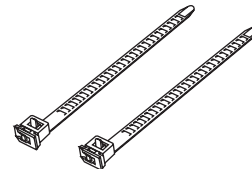

Optional Accessories

● Speakers
TS-C5000SPG

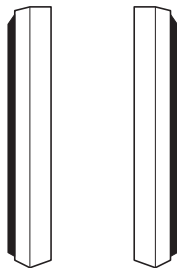

● Stand Unit
TS-C50P1G



● Wall Mounting Unit
TS-C50P6G

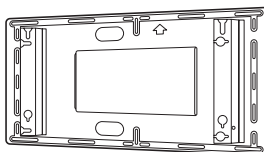

● Wall Mounting Unit (angled)
TS-C50P2G

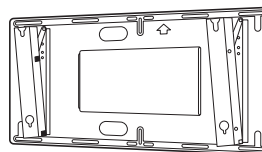

● Ceiling Suspension Unit
TS-C50P3G

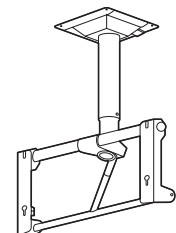

For assembling

Full instructions are supplied with each optional accessories for use with this Plasma Display Monitor.

Remote Control Batteries

Requires two AA batteries.

1. Turn the transmitter face down.
Press and slide off the battery cover.
2. Install the batteries as shown in the battery compartment.
(Polarity + or – must match the markings in the compartment.)
3. Replace the cover and slide in reverse until the lock snaps.

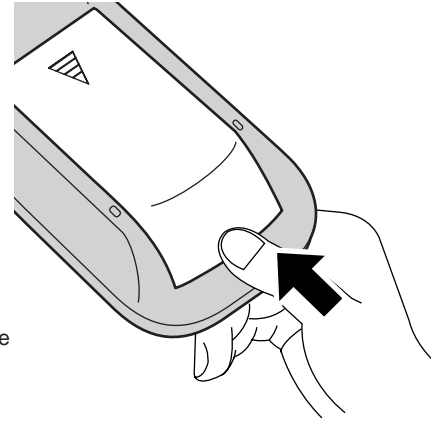
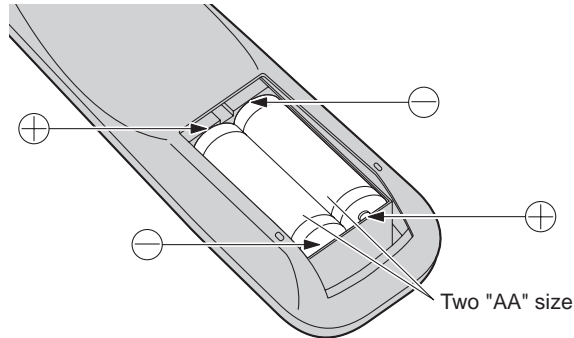
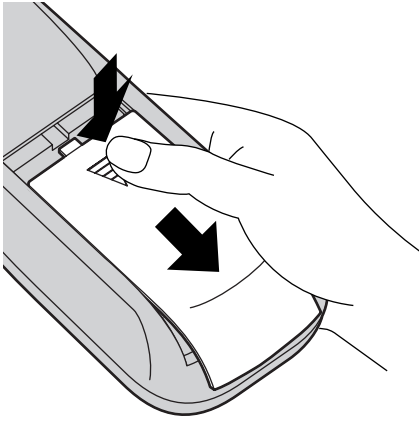

Helpful Hint:

For frequent remote control users, replace old batteries with Alkaline batteries for longer life.

⚠ Precaution on battery use

Incorrect installation can cause battery leakage and corrosion that will damage the remote control transmitter.

Observe the following precautions:

1. Batteries should always be replaced as a pair. Always use new batteries when replacing the old set.
2. Do not combine a used battery with a new one.
3. Do not mix battery types (example: "Zinc Carbon" with "Alkaline").
4. Do not attempt to charge, short-circuit, disassemble, heat or burn used batteries.
5. Battery replacement is necessary when the remote control acts sporadically or stops operating the Plasma Display set .

Basic Controls

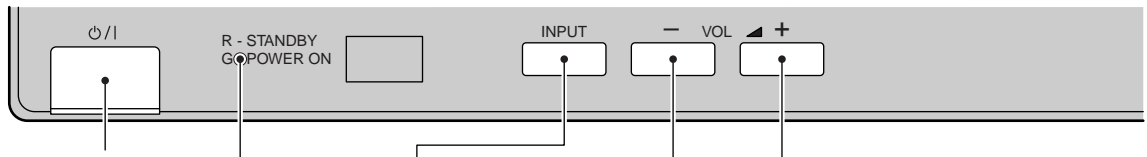

Main POWER ON/OFF Switch

Power Indicator

The Power Indicator will light.

- POWER-OFF Indicator not illuminated (The unit will still consume some power as long as the power cord is inserted into the wall outlet.)
- STAND-BY ϕRed
- POWER-ON.....Green

INPUT button

(VIDEO (S VIDEO), COMPONENT/RGB and PC Mode Selection)

Press the "INPUT" button to select VIDEO (S VIDEO), COMPONENT/RGB and PC input signal modes sequentially. (see page 19)

VOLUME Adjustment

Press the Volume Up "+" or Down "-" button to increase or decrease the sound volume level.

STAND-BY (ON/OFF) button

The Plasma Display must first be plugged into the wall outlet and turned on at the power switch. (see page 18) Press this button to turn the Plasma Display ON, from STAND-BY mode. Press it again to turn the Plasma Display OFF to STAND-BY mode.

STATUS button

Press the "STATUS" button to display the current system status.

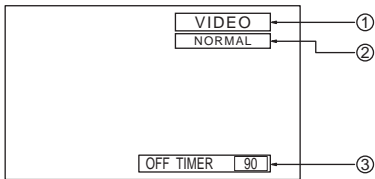

① VIDEO (S VIDEO), COMPONENT/RGB, PC mode

② ASPECT mode (see page 22)

③ OFF TIMER

The OFF TIMER indicator is displayed only when the off timer has been set.

N button

(see page 25, 26, 28, 29)

PICTURE button

(see page 28)

PICTURE POS./SIZE button

(see page 24)

PC button

Press the "PC" mode selection button to select the PC mode. This button is used to switch directly to PC mode.

SURROUND button

(see page 27)

INPUT button

(VIDEO (S VIDEO), COMPONENT/RGB and PC Mode Selection)

Press to select VIDEO (S VIDEO), COMPONENT/RGB and PC input signal modes sequentially. (see page 19)

Sound mute On/Off

(see page 26)

VOLUME Adjustment

Press the Volume Up "+" or Down "-" button to increase or decrease the sound volume level.

R button

(see page 21)

ACTION button

Press to make selections

POSITION buttons

SET UP button (see page 20)

SOUND button (see page 26)

ASPECT button

Press to adjust the aspect.

(see page 22)

OFF TIMER button

The Plasma Display can be preset to switch to stand-by after a fixed period. The setting changes to 30 minutes, 60 minutes, 90 minutes and 0 minutes (off timer cancelled) each time the button is pressed.

When three minutes remain, "Off timer 3" will flash.

The off timer is cancelled if a power interruption occurs.

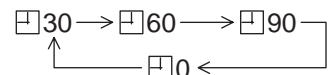

Connections

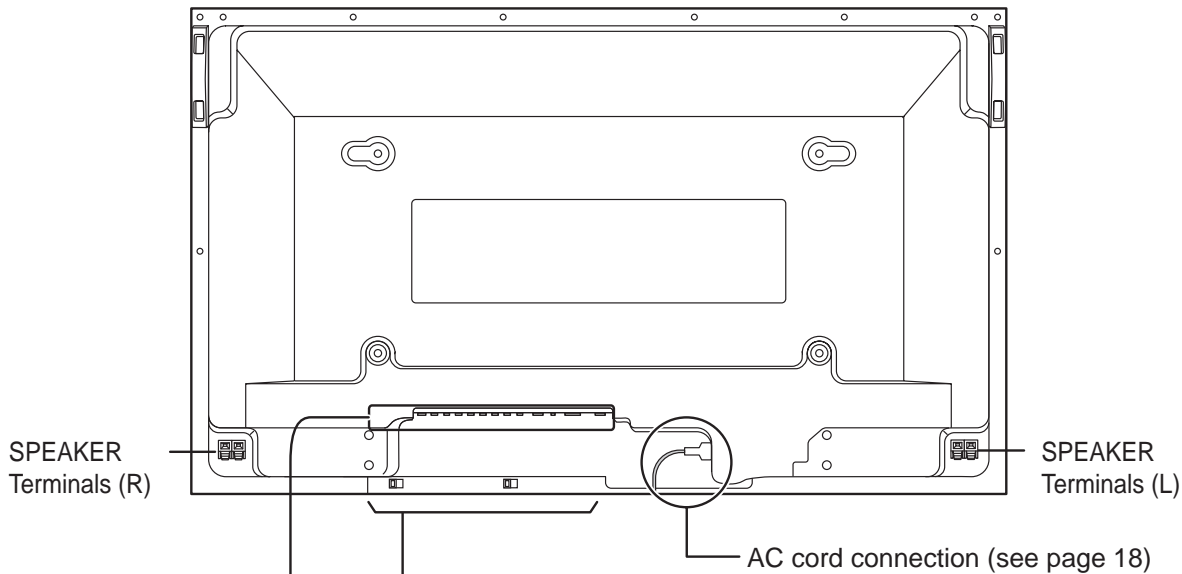

- Cable fixing bands

Secure any excess cables with bands, as required.

Pass the attached cable fixing band through the clip as shown in the figure.

1

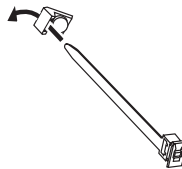

2

To secure cables connected to Terminals, wrap the cable fixing band around them then pass the pointed end through the locking block, as shown in the figure.

While ensuring there is sufficient slack in cables to minimize stress (especially in the power cord), firmly bind all cables with the supplied fixing band.

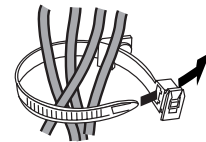

To tighten:

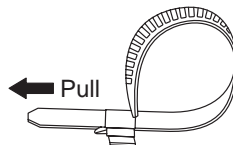

To loosen:

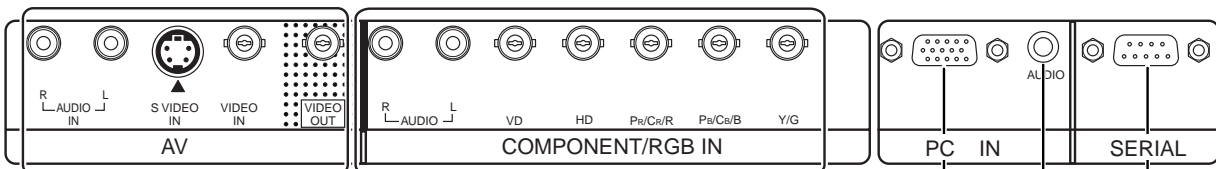
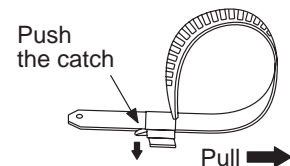

AV Terminals
(see page 12, 13)

COMPONENT/RGB IN and Audio
IN Terminals (see page 14)

From EXIT monitor Terminal
on Computer (see page 15)

From SERIAL Terminal on
Computer (see page 17)

Connections

Speakers connection

When connecting the speakers, be sure to use only the optional accessory speakers.
Refer to the speaker's Installation Manual for details on speaker installation.

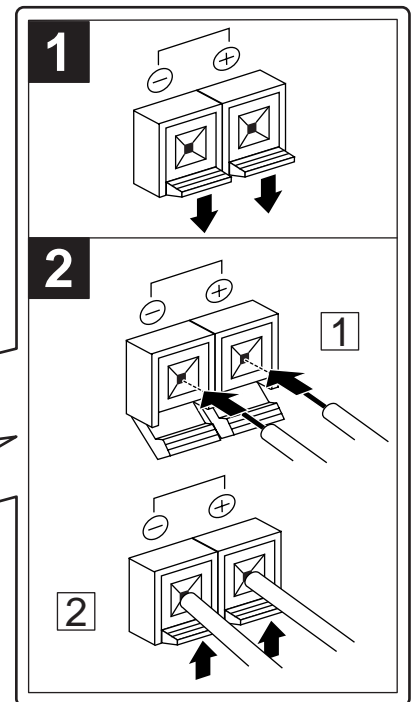
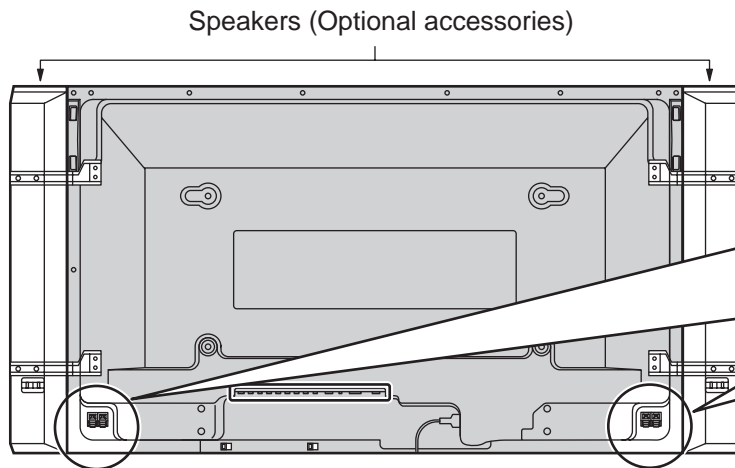

AV Input Terminals connection

Connect the signal source equipment (see page 14 to 17).

(Example) When connecting an S VIDEO VCR

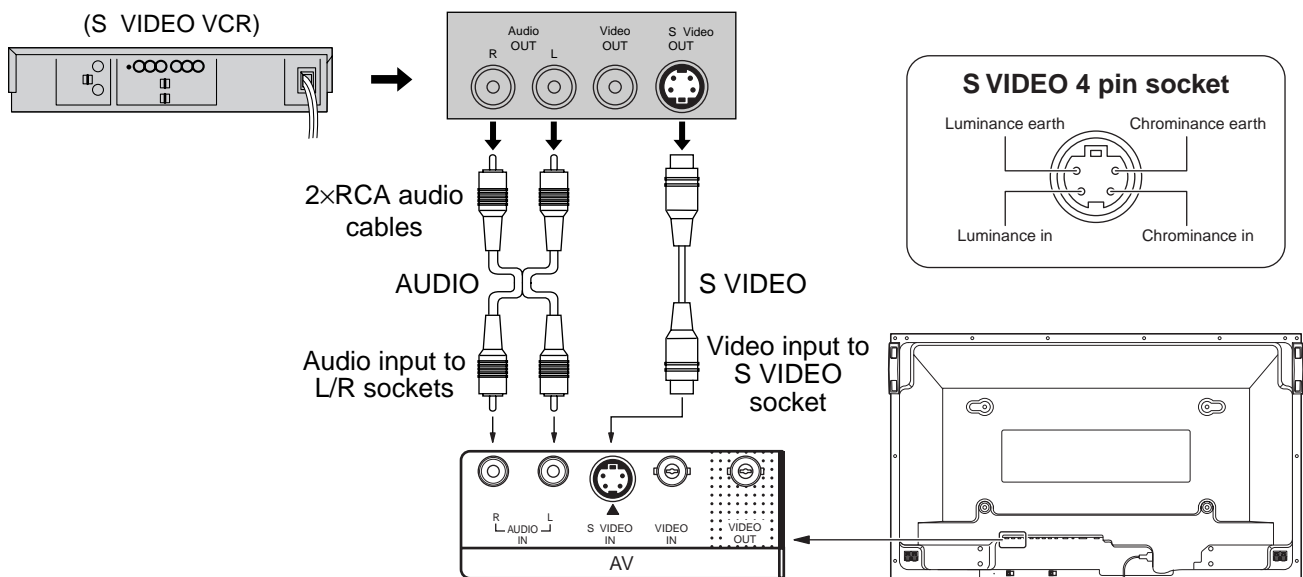

Note:
Additional equipment and cables shown are not supplied with this set.

AV Input connection

VIDEO signal connection

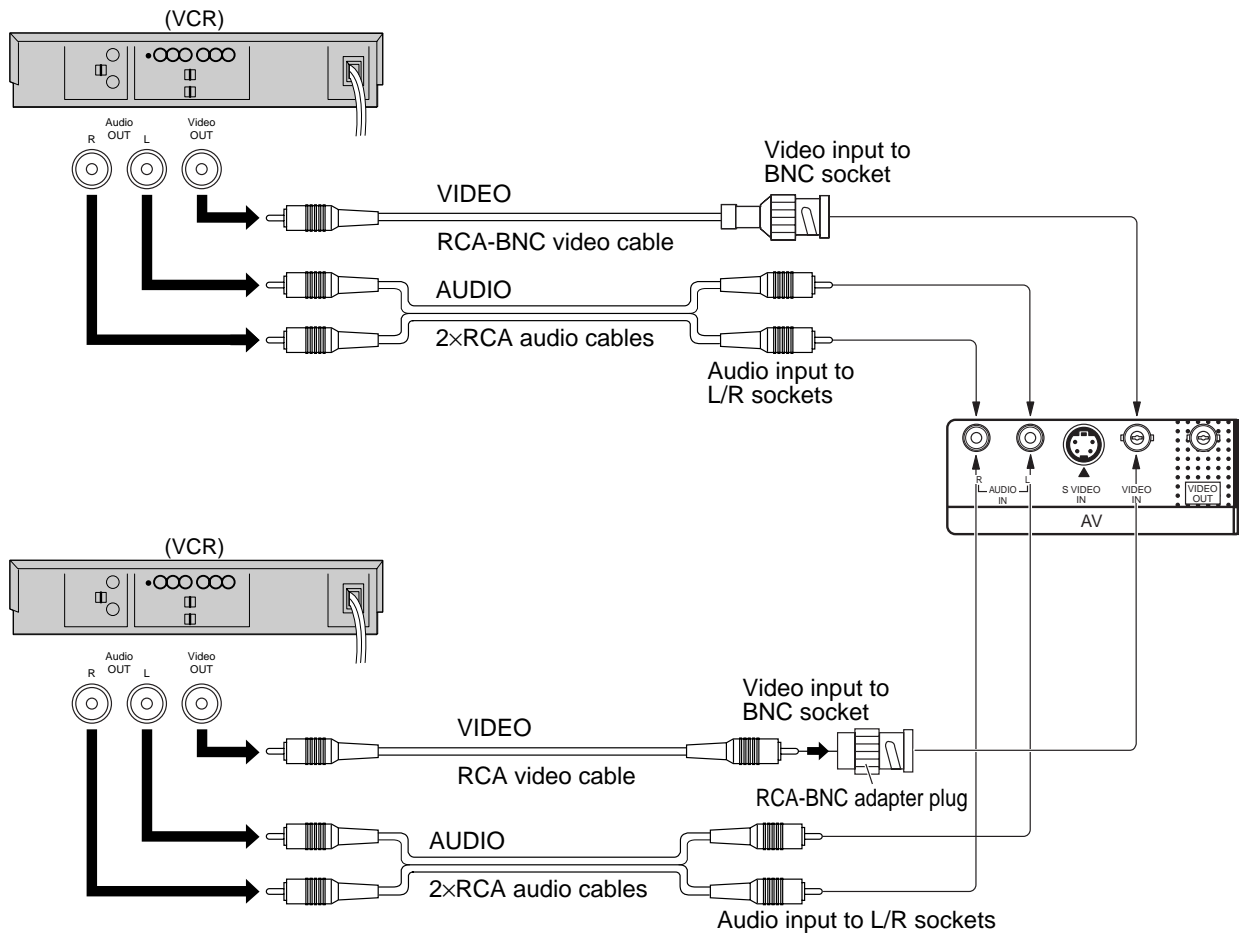

Notes:

- (1) The S Video input will override the composite video signal when S Video lead is connected.
- (2) Additional equipment and cables shown are not supplied with this set.

VIDEO OUT

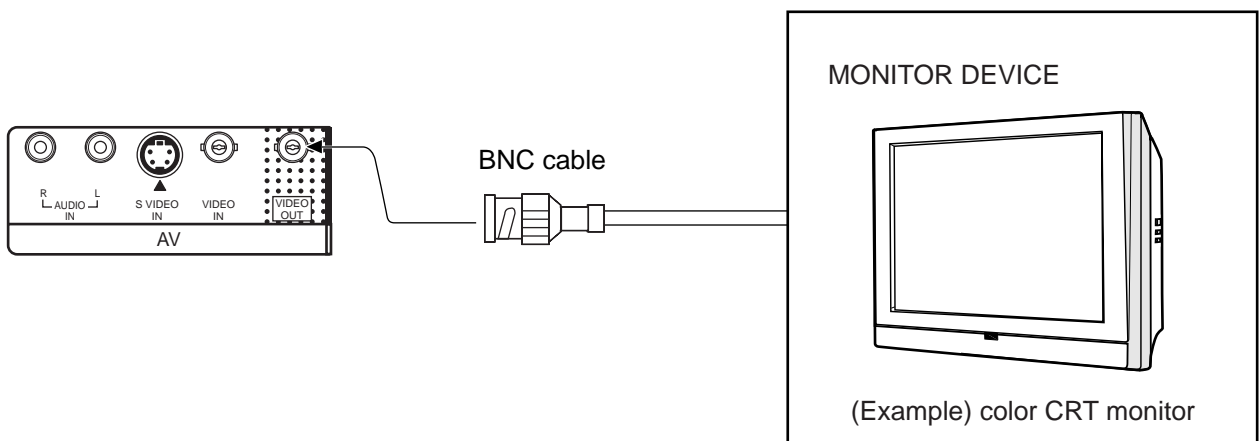

COMPONENT/RGB Input connection

Component signals (Y, P_B, P_R) connection

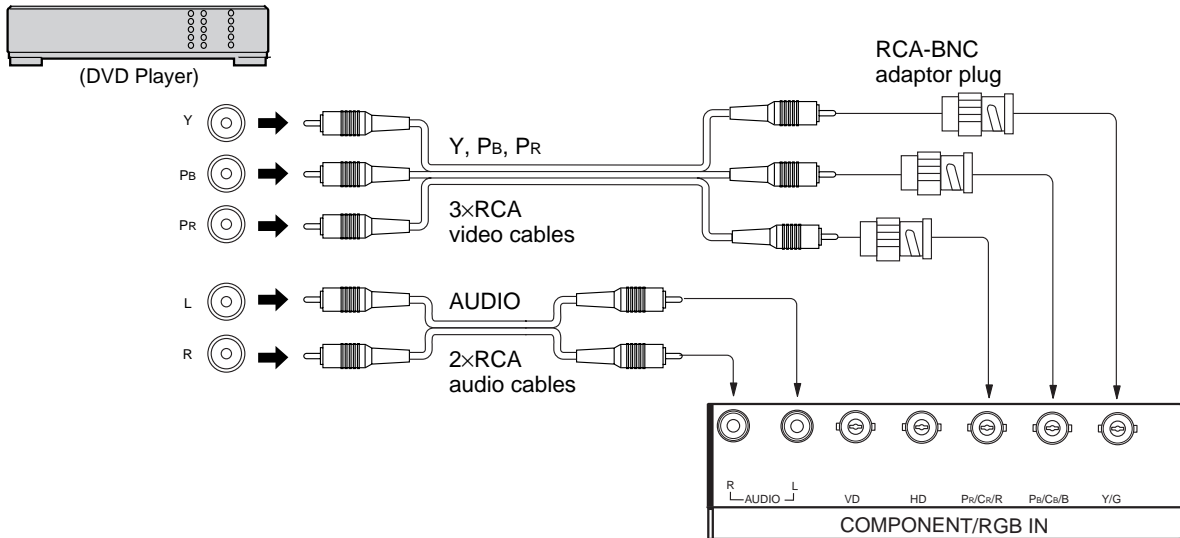

Notes:

- (1) Change the "COMPONENT/RGB-IN" setting in the "SET UP" menu to "COMPONENT". (see page 34)
- (2) Additional equipment, cables and adaptor plugs shown are not supplied with this set.

RGB signal (R, G, B, HD, VD) connection

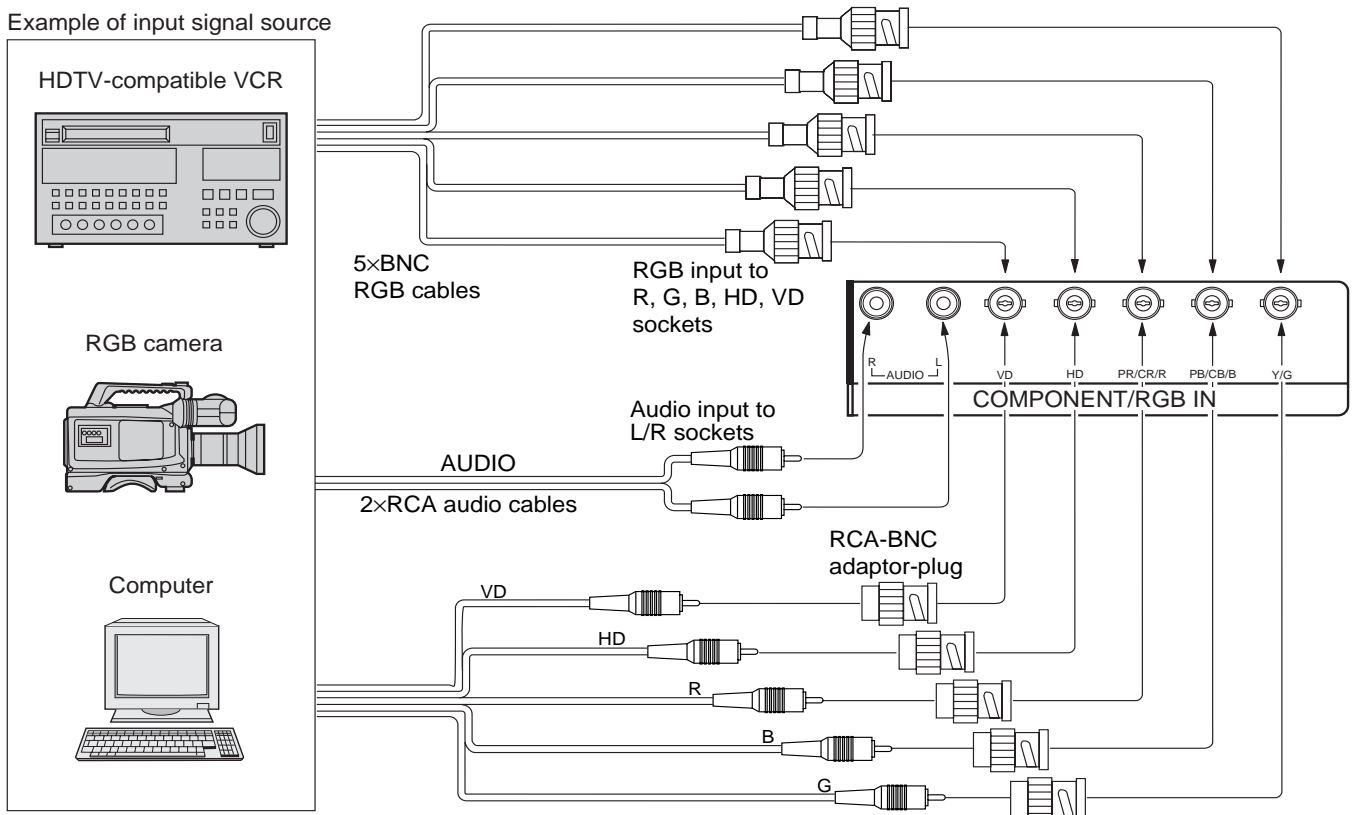

Notes:

- (1) Change the "COMPONENT/RGB-IN" setting in the "SET UP" menu to "RGB". (see page 34)
- (2) Additional equipment, cables and adaptor plugs shown are not supplied with this set.

PC Input Terminals connection

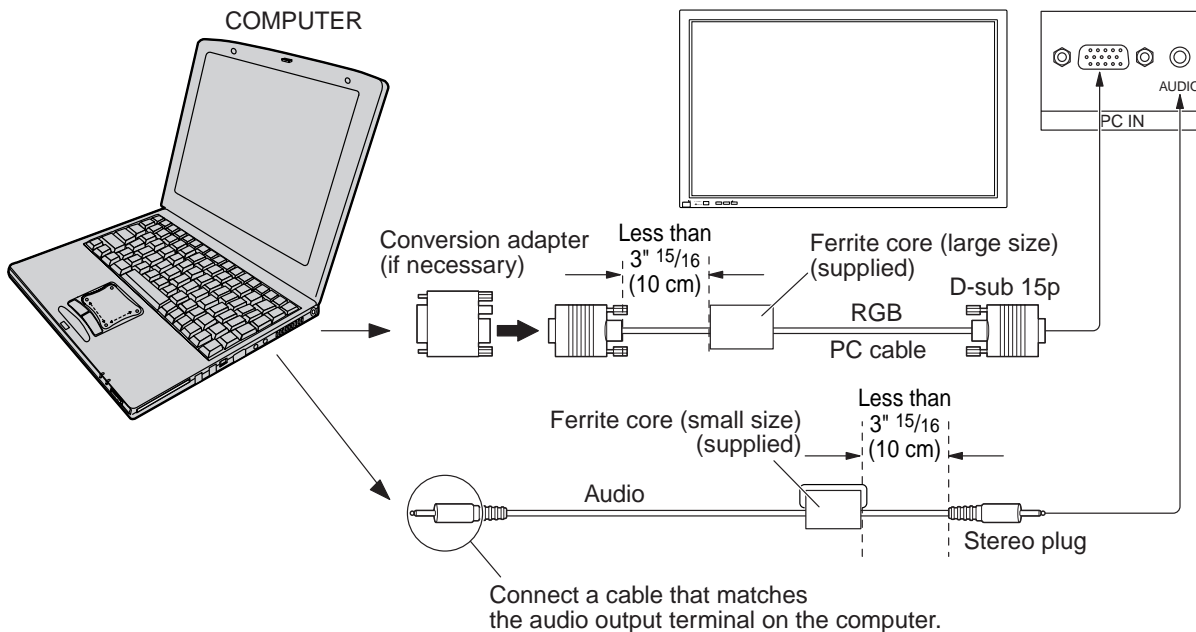

Installing the ferrite core (Small size)

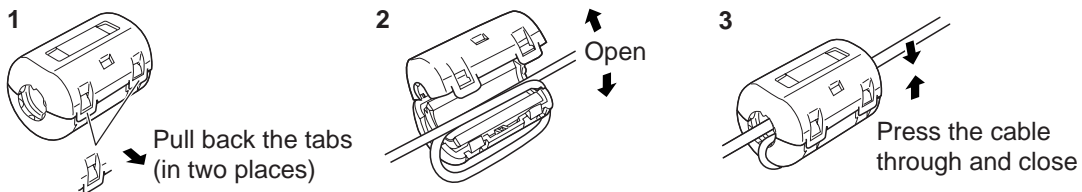

Installing the ferrite core (Large size)

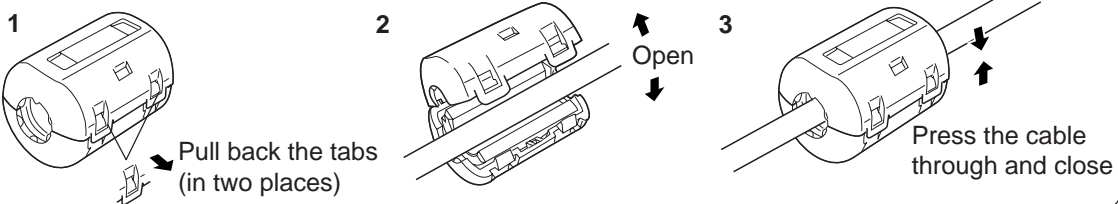

Notes:

- (1) Computer signals which can be input are those with a horizontal scanning frequency of 15.5 to 110 kHz and vertical scanning frequency of 48 to 120 Hz. (However, the image will not be displayed properly if the signals exceed 1,200 lines.)
- (2) The display resolution is a maximum of 1,024 × 768 dots when the aspect mode is set to "NORMAL", and 1,366 × 768 dots when the aspect mode is set to "FULL". If the display resolution exceeds these maximums, it may not be possible to show fine detail with sufficient clarity.
- (3) The PC input terminals are DDC1/2B-compatible. If the computer being connected is not DDC1/2B-compatible, you will need to make setting changes to the computer at the time of connection.
- (4) Some PC models cannot be connected to the set.
- (5) There is no need to use an adapter for computers with DOS/V compatible D-sub 15P terminal.
- (6) The computer shown in the illustration is for example purposes only.
- (7) Additional equipment and cables shown are not supplied with this set.
- (8) Do not set the horizontal and vertical scanning frequencies for PC signals which are above or below the specified frequency range.

Connections

Signal Names for D-sub 15P Connector

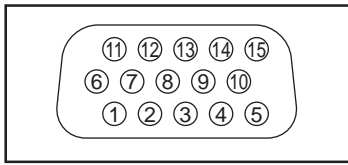

Pin layout for PC input terminal

Pin No.	Signal Name	Pin No.	Signal Name	Pin No.	Signal Name
①	R	⑥	GND (Ground)	⑪	GND (Ground)
②	G	⑦	GND (Ground)	⑫	SDA
③	B	⑧	GND (Ground)	⑬	HD/SYNC
④	GND (Ground)	⑨	NC (not connected)	⑭	VD
⑤	GND (Ground)	⑩	GND (Ground)	⑮	SCL

VIDEO/COMPONENT/RGB/PC input signals

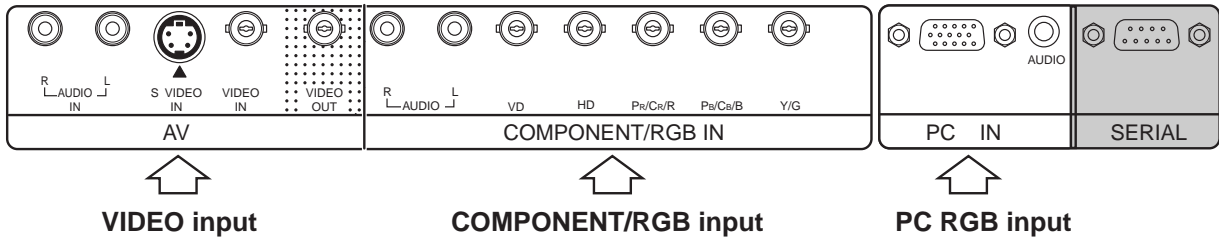

VIDEO input

	signal name	horizontal frequency(kHz)	vertical frequency(Hz)
1	NTSC	15.734	59.95
2	PAL	15.625	50
3	PAL60	15.734	59.95
4	SECAM	15.625	50
5	Modified NTSC	15.734	59.95

* Mark:
Input signal can be displayed.

COMPONENT/RGB/PC input

	signal name	horizontal frequency(kHz)	vertical frequency(Hz)	Component	RGB	PC
1	525 (480) /60i	15.734	59.94	*	*	*
2	625 (575) /50i	15.625	50	*	*	*
3	525 (480) /60p	31.468	59.94	*	*	
4	625 (575) /50p	31.25	50	*	*	*
5	750 (720) /60p	45	60	*	*	*
6	1,125 (1,080) /60i	33.75	60	*	*	*
7	1,125 (1,080) /50i	28.125	50	*	*	*
8	1,125 (1,080) /24p	27	24	*	*	*
9	1,125 (1,080) /24sF	27	48	*	*	*
10	640 × 400 @70	31.5	70		*	*
11	640 × 480 @60	31.5	59.94		*	*
12	Macintosh13" (640 × 480)	35	67		*	*
13	640 × 480 @75	37.5	75		*	*
14	852 × 480 @60	31.7	60		*	*
15	800 × 600 @60	37.9	60		*	*
16	800 × 600 @75	46.9	75		*	*
17	800 × 600 @85	53.7	85		*	*
18	Macintosh16" (832 × 624)	49.7	75		*	*
19	1,024 × 768 @60	48.4	60		*	*
20	1,024 × 768 @70	56.5	70		*	*
21	1,024 × 768 @75	60	75		*	*
22	1,024 × 768 @85	68.7	85		*	*
23	Macintosh21" (1,152 × 870)	68.7	75		*	*
24	1,280 × 1,024 @60	64	60		*	*
25	1,280 × 1,024 @75	80	75		*	*
26	1,280 × 1,024 @85	91.1	85		*	*
27	1,600 × 1,200 @60	75	60		*	*

SERIAL Terminals connection

The SERIAL terminal is used when the Plasma Display is controlled by a computer.

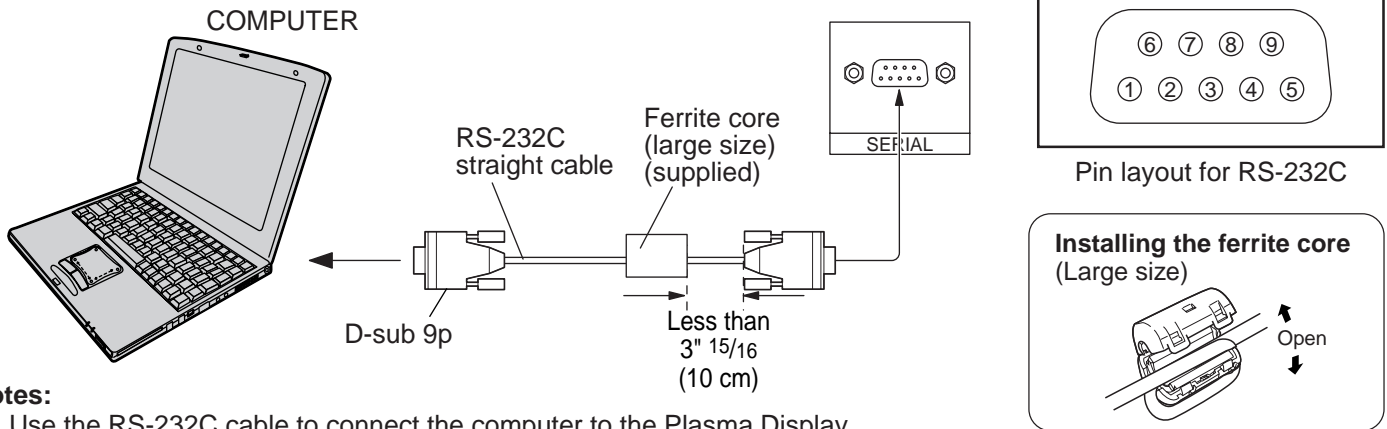

Notes:

- (1) Use the RS-232C cable to connect the computer to the Plasma Display.
- (2) The computer shown is for example purposes only.
- (3) Additional equipment and cables shown are not supplied with this set.

The SERIAL terminal conforms to the RS-232C interface specification, so that the Plasma Display can be controlled by a computer which is connected to this terminal.

The computer will require software which allows the sending and receiving of control data which satisfies the conditions given below. Use a computer application such as programming language software. Refer to the documentation for the computer application for details.

Communication parameters

Signal level	RS-232C compliant
Synchronization method	Asynchronous
Baud rate	9600 bps
Parity	None
Character length	8 bits
Stop bit	1 bit
Flow control	-

RS-232C Conversion cable	
D-sub 9-pin female	Details
②	R X D
③	T X D
⑤	GND
④ • ⑥	Non use
⑦	Shorted
⑧	
① • ⑨	NC

Basic format for control data

The transmission of control data from the computer starts with a STX signal, followed by the command, the parameters, and lastly an ETX signal in that order. If there are no parameters, then the parameter signal does not need to be sent.

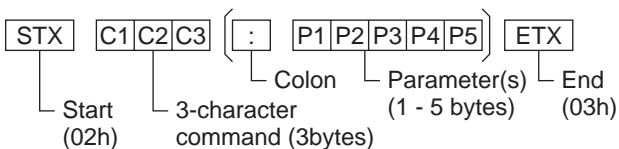

Notes:

- (1) If multiple commands are transmitted, be sure to wait for the response for the first command to come from this unit before sending the next command.
- (2) If an incorrect command is sent by mistake, this unit will send an "ER401" command back to the computer.

Command

Command	Parameter	Control details
PON	None	Power ON
POF	None	Power OFF
AVL	**	Volume 00 - 63
AMT	0	Audio MUTE OFF
	1	Audio MUTE ON
IIS	None	Input select (toggle)
	VID	VIDEO Mode
	YP1	COMPONENT / RGB mode (processed as a Y/Pb/Pr or RGB signals as set by this unit)
DAM	RG1	PC mode
	None	Screen mode select (toggle)
	NORM	NORMAL (4:3)
	ZOOM	ZOOM
	FULL	FULL
	JUST	JUST
	SELF	AUTO

With the power off, this display responds to PON command only.

Power ON/OFF and Input Signal Selection

AC cord connection

Connecting the AC cord plug to the Plasma Display.

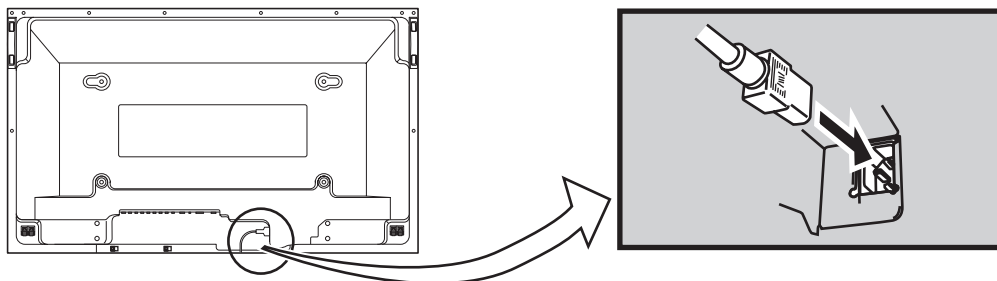

Power ON/OFF

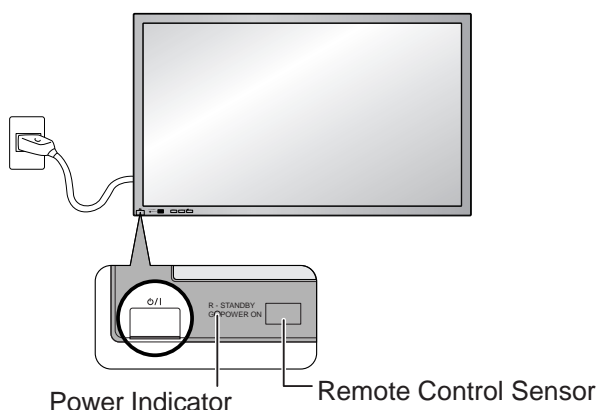

Connecting the plug to the Wall Outlet

Press the POWER switch on the Plasma Display to turn the set on : POWER-ON.

Power Indicator: Green

Example: The screen below is displayed for a while after the Plasma Display is turned on. (setting condition is an example.)

When the POWER is turned on for the first time, the LANGUAGE selection screen is displayed.

From the second time on, language selection can be done from the setup menu. (see page 19)

Select the desired language using the ▲ and ▼ keys and press the ACTION button.

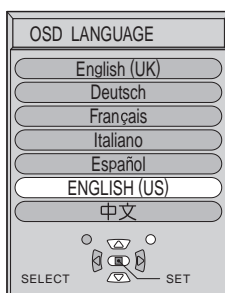

From the second time on, the screen shown below is displayed for a while (setting condition is an example).

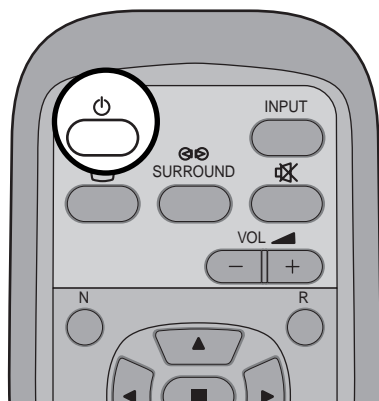
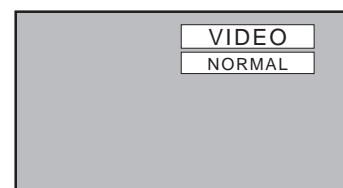

Press the  button on the remote control to turn the Plasma Display off.

Power Indicator: Red (STAND-BY)

Press the  button on the remote control to turn the Plasma Display on.

Power Indicator: Green

To turn the power for the Plasma Display off, press the  switch on the Plasma Display, when the Plasma Display is on or in standby mode.

Select the Input Signal

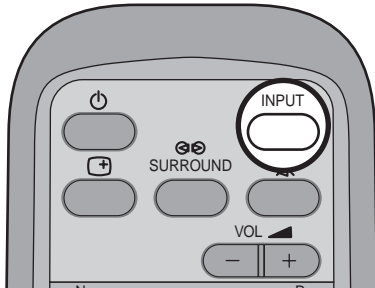
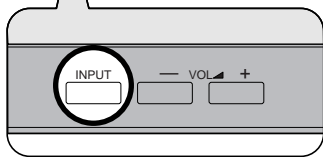

Press the INPUT button to select the input video signal desired from equipment such as a VCR which has been connected to the Plasma Display.

Input signals will change as follows:

For COMPONENT INPUT (see page 34)

→ VIDEO → COMPONENT → PC

For RGB INPUT (see page 34)

→ VIDEO → RGB → PC

Selecting the On-Screen Menu Language

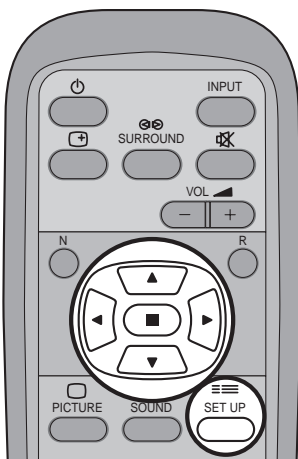

press to display the SET UP menu.

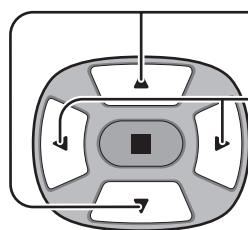

press to select OSD LANGUAGE.

press to select your preferred language.

Selectable languages

ENGLISH(UK)
Deutsch
Français
Italiano
Español
ENGLISH(US)
中文(Chinese)

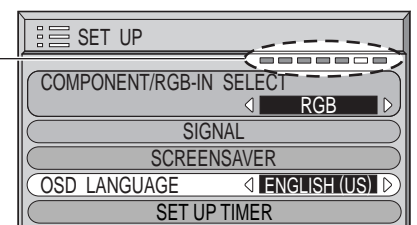

On-Screen Menu Display from Remote Control

To PICTURE adjust menu
(see page 28)

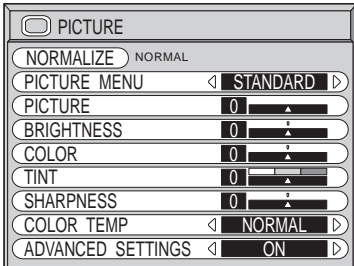

To ADVANCED SETTINGS
(see page 28, 29)

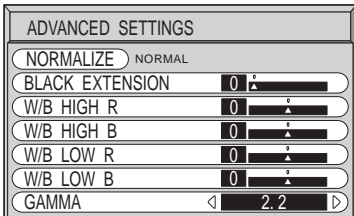

To SOUND adjust menu
(see page 26)

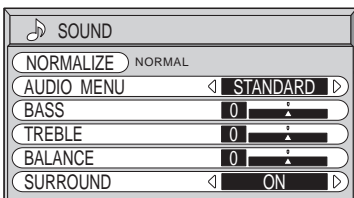

To PICTURE POS./SIZE adjust menu
(see page 24)
During "VIDEO (S VIDEO)" and
"COMPONENT" input signal modes.

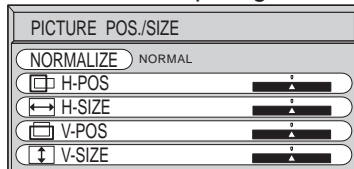

During "RGB" and "PC"
input signal modes.

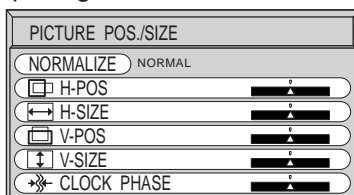

Press to select each item.

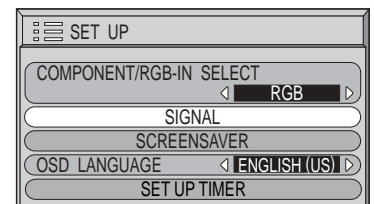
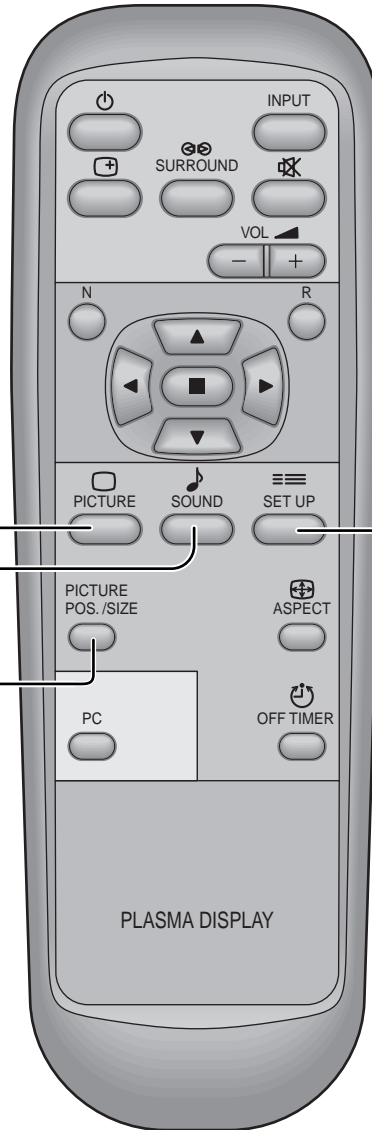
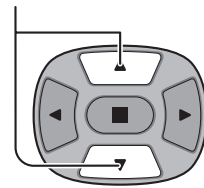

To setup SCREENSAVER
(See page 32)

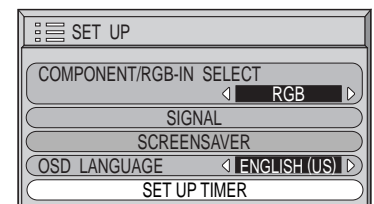
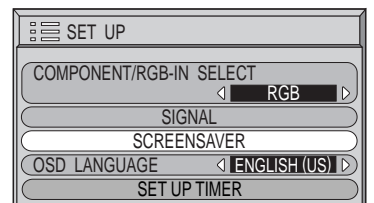

On-Screen Menu Display from Remote Control

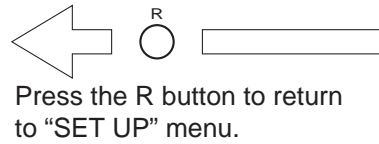
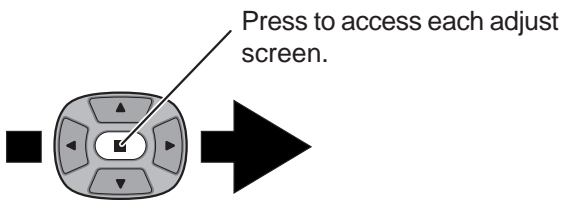

To SIGNAL screen for VIDEO (see page 34, 35)

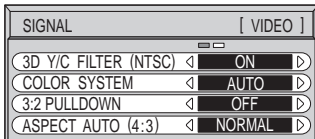

To SIGNAL screen for COMPONENT (see page 35)

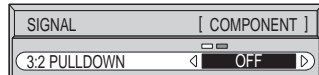

To SIGNAL screen for RGB (see page 36)

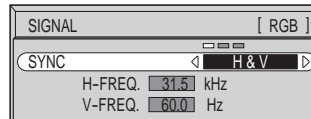

To SIGNAL screen for PC (see page 36)

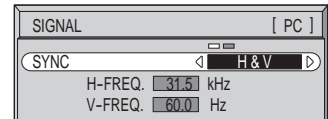

Note:

“SIGNAL” setup menu displays a different setting condition for each input signal. (see page 19)

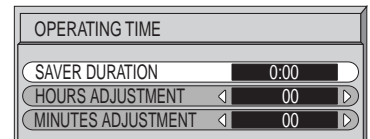
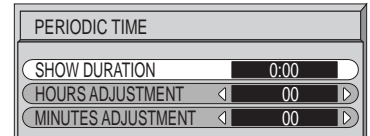
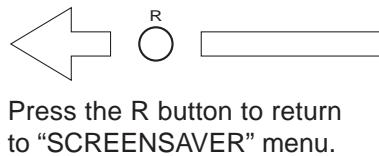
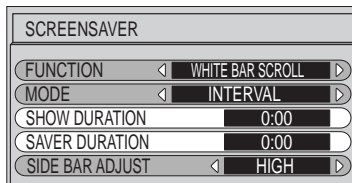
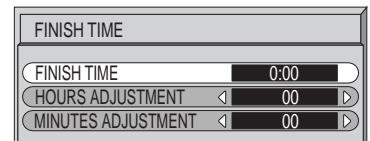
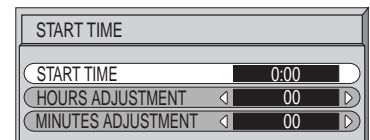
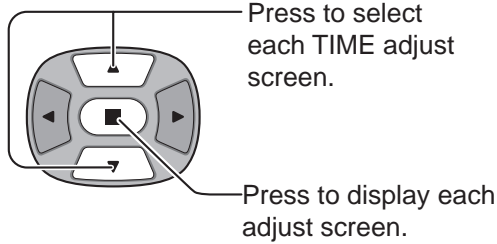
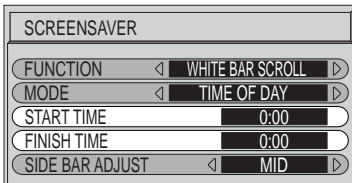

To SET UP TIMER selection screen.(see page 30)

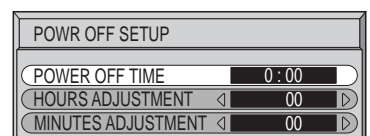
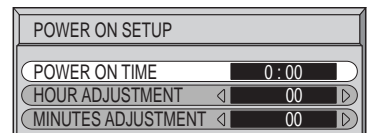
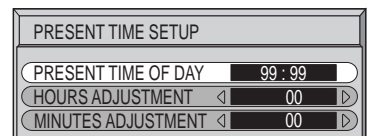
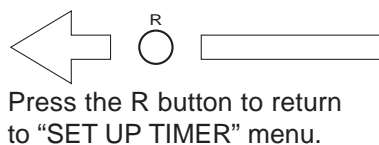
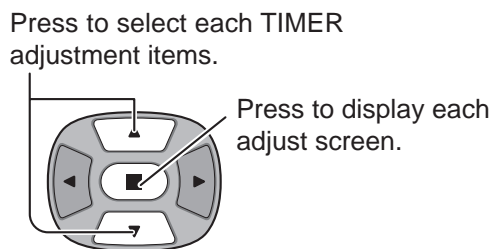
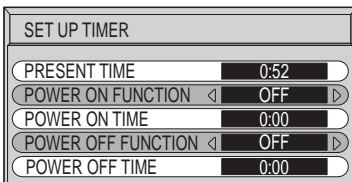

ASPECT Controls

The Plasma Display will allow you to enjoy viewing the picture at its maximum size, including wide screen cinema format picture.

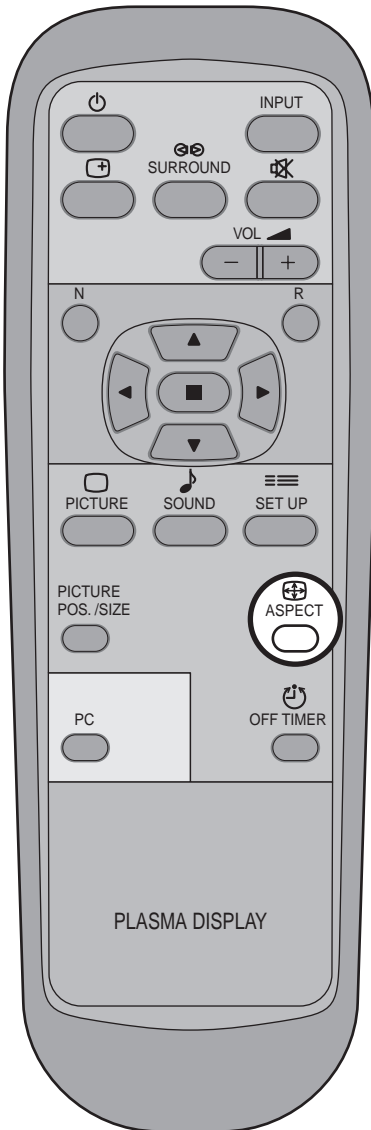

ASPECT button

The aspect mode changes each time the ASPECT button is pressed.

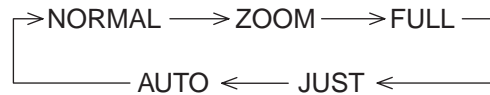

Notes:

- (1) During RGB and PC input signal modes, the mode switches between "NORMAL", "ZOOM" and "FULL" only.
- (2) For a 1,125i (1,080i), 750p (720p) signal input during "COMPONENT" input signal mode, the mode is set to "FULL" mode, and switching is not possible.
For a 525i (480i), 625i (575i), 525p (480p) and 625p (575p) signal input during "COMPONENT" input signal mode, "AUTO" cannot be selected.
- (3) The aspect mode is memorized separately for each input terminal (VIDEO (S VIDEO), COMPONENT, RGB and PC).

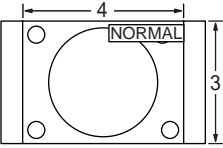
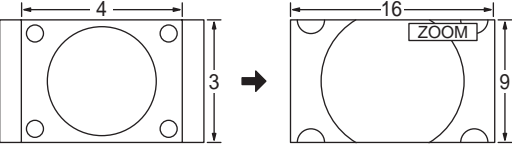
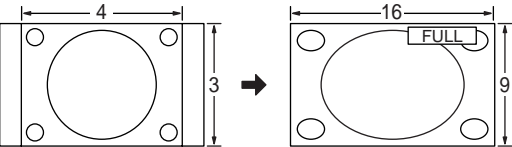
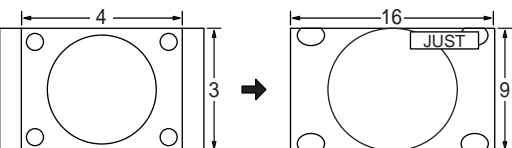
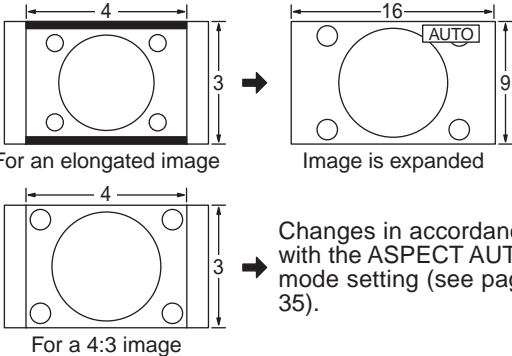
Mode	Picture	Explanation
NORMAL		<p>NORMAL will display a 4:3 picture at its standard 4:3 size.</p>
ZOOM		<p>ZOOM mode magnifies the central section of the picture.</p>
FULL		<p>FULL will display the picture at its maximum size but with slight elongation.</p>
JUST		<p>JUST mode will display a 4:3 picture at its maximum size but with aspect correction applied to the center of the screen so that elongation is only apparent at the left and right edges of the screen. The size of the picture will depend on the original signal.</p>
AUTO	 <p>Changes in accordance with the ASPECT AUTO mode setting (see page 35).</p>	<p>The display will automatically become enlarged (depending on the picture source), allowing you to view the picture at its maximum size.</p> <p>Note: AUTO mode is designed to automatically adjust the aspect ratio to handle a mix of 16:9 and 4:3 program material. Certain 4:3 program material, such as stock market data screens, may occasionally cause the image size to change unexpectedly. When viewing such programs, it is recommended that the ASPECT be set to NORMAL.</p>

Note:

Do not allow the picture to be displayed in 4:3 mode for an extended period, as this can cause a permanent after-image to remain on the Plasma Display Panel.

Adjusting PICTURE POSITION/SIZE

Adjusting screen

1  Press to display the PICTURE POS./SIZE menu.

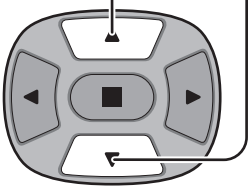
2  Press to select H-POS/H-SIZE/V-POS/V-SIZE/CLOCK PHASE.

During "VIDEO (S VIDEO)" and "COMPONENT" input signal modes.

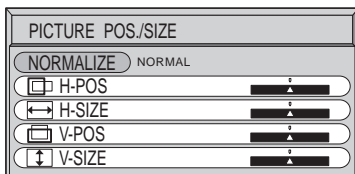

During "RGB" and "PC" input signal modes.

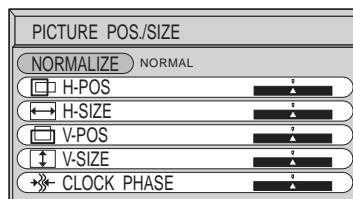

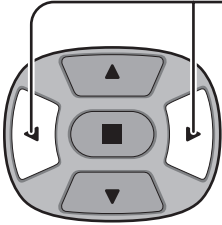
3  Press to adjust POS./SIZE.

 Press to exit from adjust mode.

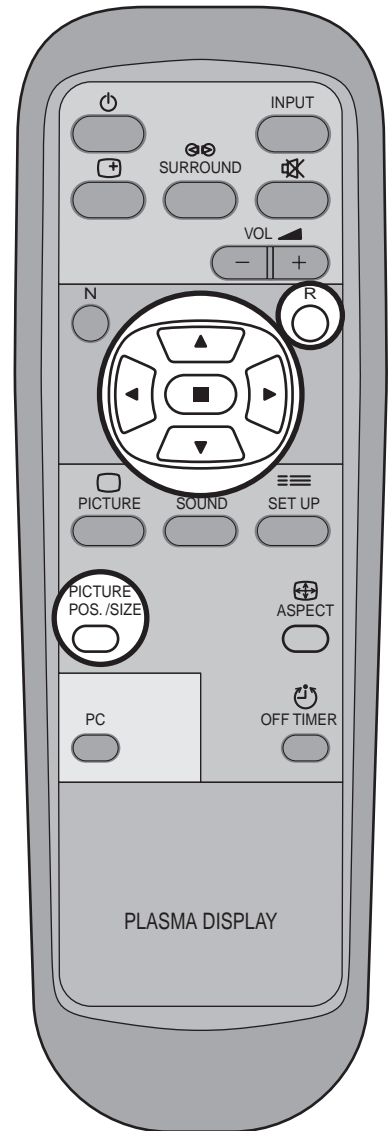

Notes:

- (1) Adjustment details are memorized separately for different input signal formats (Adjustments for component signals are memorized for 525i (480i), 625i (575i), 525p (480p), 1,125i (1,080i) and 625p (575p), 750p (720p) each, and RGB/PC signals are memorized for each frequency.)
- (2) If a "Cue" or "Rew" signal from a VCR or DVD player is received, the picture position will shift up or down. This picture position movement cannot be controlled by the PICTURE POS./SIZE function.

Adjusting PICTURE POS./SIZE

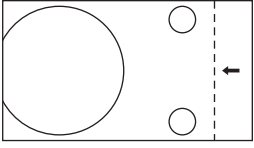
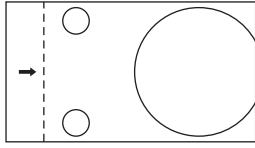
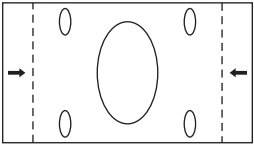
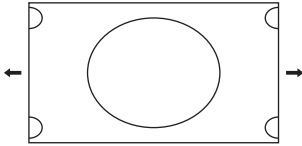
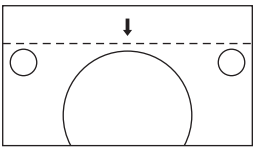
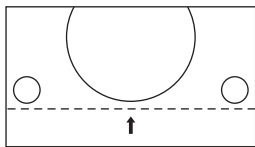
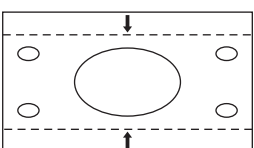
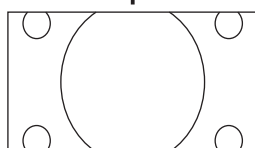
H-POS	<p>When the Position Left “◀” button is pressed</p> 	<p>When the Position Right “▶” button is pressed</p> 
H-SIZE	<p>When the Position Left “◀” button is pressed</p> 	<p>When the Position Right “▶” button is pressed</p> 
V-POS	<p>When the Position Left “◀” button is pressed</p> 	<p>When the Position Right “▶” button is pressed</p> 
V-SIZE	<p>When the Position Left “◀” button is pressed</p> 	<p>When the Position Right “▶” button is pressed</p> 
CLOCK PHASE (RGB/PC in Mode)	<p>Flickering and distortion can be eliminated by using the Position Left “◀” or Right “▶” button to carry out adjustment.</p>	

Helpful Hint (/ Normalization)

While the PICTURE POS./SIZE display is active, if either the N button on the remote control is pressed at any time or the  (ACTION button) is pressed during “NORMALIZE”, then all adjustment values are returned to the factory settings.

SOUND Adjustment

1  Press to display the Sound menu.

2 Select to adjust each item.

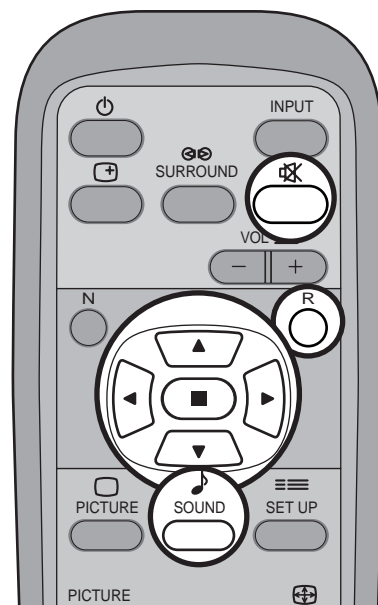
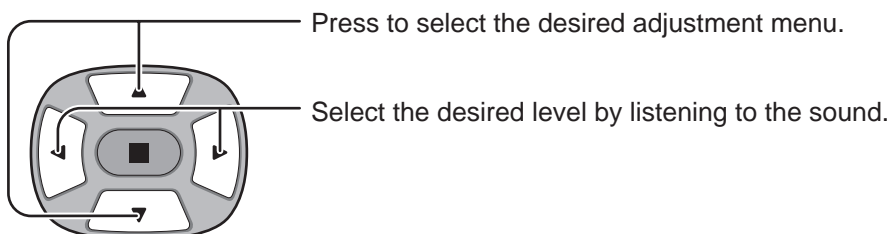

BASS
Adjusts low sounds

TREBLE
Adjusts high sounds

BALANCE
Adjusts left and right volumes

SURROUND (see next page)
Select ON or OFF

• To end adjustments

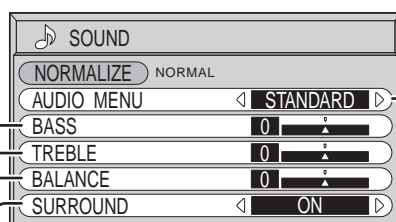

STANDARD Emits the original sound.



AUTO Automatically controls proper volume level.

Note:

Press the SURROUND button to directly turn the surround effect ON and OFF. (see next page)
BASS, TREBLE and SURROUND settings are memorized separately for each SOUND mode (STANDARD, AUTO).

Helpful Hint (/ Normalization)

While the "SOUND" menu is displayed, if either the N button on the remote control is pressed at any time or the  (ACTION button) is pressed during "NORMALIZE", then all adjustment values are returned to the factory settings.

MUTE

Useful when answering the phone or receiving visitors.

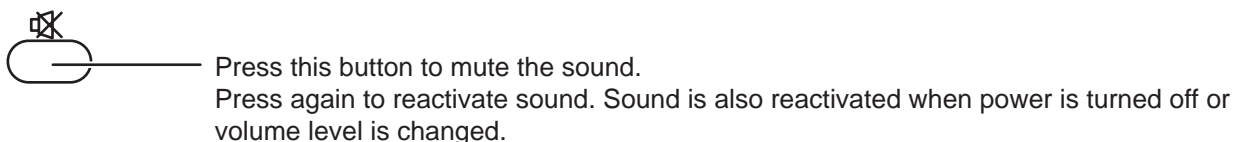

SURROUND Controls



SURROUND Button

The benefits of surround sound are enormous. You can be completely enveloped in sound; just as if you were at a concert hall or cinema.

The surround setting switches ON and OFF each time the SURROUND button is pressed.

ON \longleftrightarrow OFF

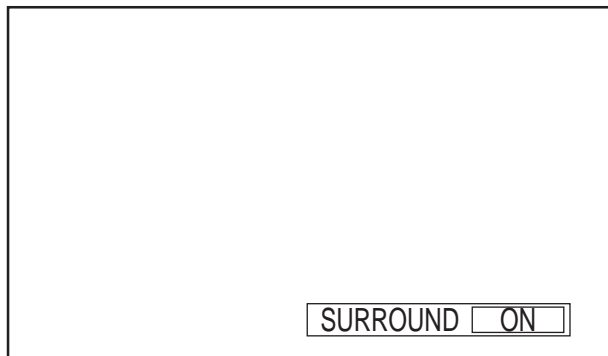

Note:

The surround settings are memorized separately for each SOUND mode (STANDARD, AUTO).

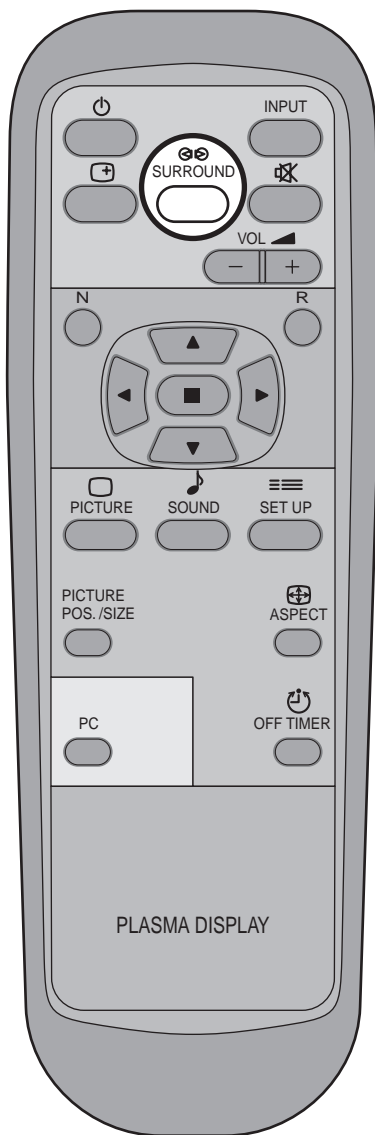

PICTURE Adjustments

1  Press to display the PICTURE menu.

2 Select to adjust each item.

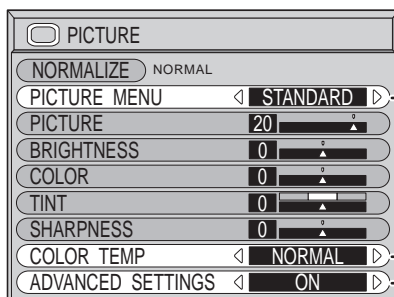
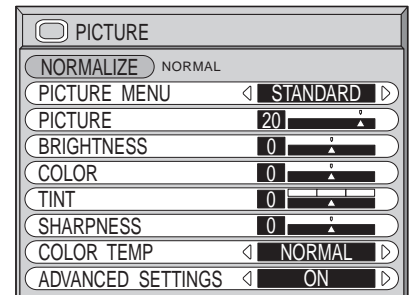
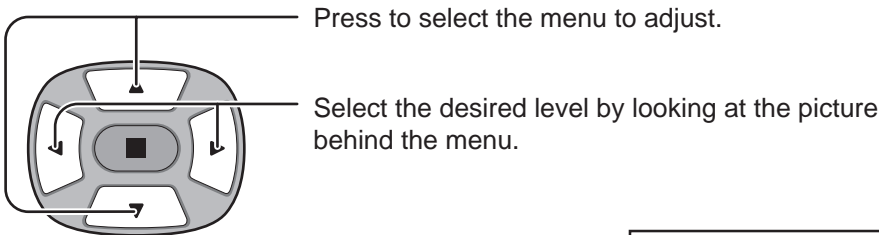

Press the left ◀ or right ▶ button to switch between modes.

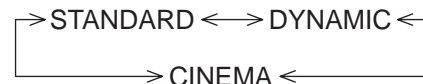

STANDARD

For viewing in standard (evening lighting) environments.

This menu selects the normal levels of BRIGHTNESS and PICTURE.

DYNAMIC

For viewing in brighter environments.

This menu selects higher than normal levels of BRIGHTNESS and PICTURE.

CINEMA

Ideal for movies.

Note:

If you would like to change the picture and color of the selected PICTURE menu to something else, adjust using the items in the PICTURE menu. (see page 29)

Press the left ◀ or right ▶ button to select "ON". Press the down ▼ button to enter ADVANCED SETTINGS mode. ADVANCED SETTINGS ON Enables fine picture adjustment at a professional level (see next page).

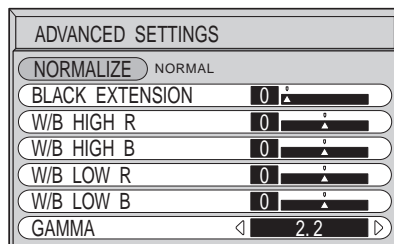

ADVANCED SETTINGS OFF
Displays images with settings of the PICTURE menu.

Press the left ◀ or right ▶ button to switch between modes.

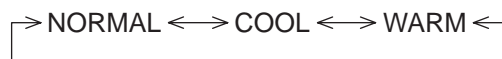

Helpful Hint (/ Normalization)

While the "PICTURE" menu is displayed, if either the N button on the remote control is pressed at any time or the  (ACTION button) is pressed during "NORMALIZE", then all adjustment values are returned to the factory settings.

PICTURE Adjustments

Item	Effect	Adjustments
PICTURE	Less More	Adjusts the proper picture contrast.
BRIGHTNESS	Darker Brighter	Adjusts for easier viewing of dark pictures such as night scenes and black hair.
COLOR	Less More	Adjusts color saturation.
TINT (NTSC only)	Reddish Greenish	Adjust for natural flesh tones.
SHARPNESS	Less More	Adjusts picture sharpness.

Notes:

- (1) "COLOR" and, "TINT" settings cannot be adjusted for "RGB" and "PC" input signal modes.
- (2) You can change the level of each function (PICTURE, BRIGHTNESS, COLOR, TINT, SHARPNESS) for each PICTURE menu.
- (3) The setting details for STANDARD, DYNAMIC and CINEMA respectively are memorized separately for each input mode (VIDEO (S VIDEO), COMPONENT, RGB and PC).
- (4) The "TINT" setting can be adjusted for NTSC signal only during "VIDEO (S VIDEO)" input signal.

Note:

In PICTURE, there is not a noticeable change even when contrast is increased with a bright picture or reduced with a dark picture.

ADVANCED SETTINGS

Item	Effect	Details
BLACK EXTENSION	Less More	Adjusts the dark shades of the image in gradation.
W/B HIGH R	Less More	Adjusts the white balance for light red areas.
W/B HIGH B	Less More	Adjusts the white balance for light blue areas.
W/B LOW R	Less More	Adjusts the white balance for dark red areas.
W/B LOW B	Less More	Adjusts the white balance for dark blue areas.
GAMMA	Down Up	2.0 ↔ 2.2 ↔ 2.5

Notes:

- (1) Carry out "W/B" adjustment as follows.
 - Adjust the white balance of the bright sections using the "W/B HIGH R" and "W/B HIGH B" settings.
 - Adjust the white balance of the dark sections using the "W/B LOW R" and "W/B LOW B" settings.
 - Repeat steps **A** and **B** to adjust.
 Steps **A** and **B** affect each other's settings, so repeat each step in turn to make the adjustment.
- (2) The adjustment values are memorized separately for each input mode (VIDEO(S VIDEO), COMPONENT, RGB and PC).
- (3) The adjustment range values should be used as an adjustment reference.

Helpful Hint (/ Normalization)

On the remote control unit, while the "ADVANCED SETTINGS" menu is displayed, if either the N button is pressed at any time or the (ACTION button) is pressed during "NORMALIZE", then all adjustment values are returned to the factory settings.

SET UP TIMER

The timer can switch the Plasma Display ON or OFF.

Before attempting Timer Set, confirm the PRESENT TIME OF DAY and adjust if necessary. Then set POWER ON TIME/POWER OFF TIME.

Display the SET UP TIMER screen

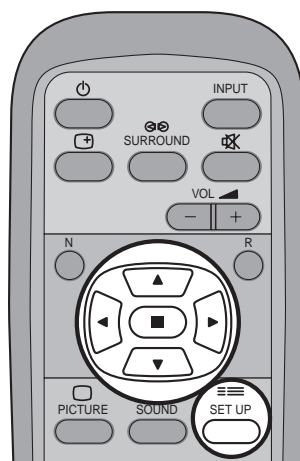

1  Press to display the SETUP menu screen.

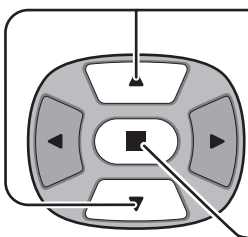
2  Press to select SET UP TIMER.
Press to display the SET UP TIMER screen.

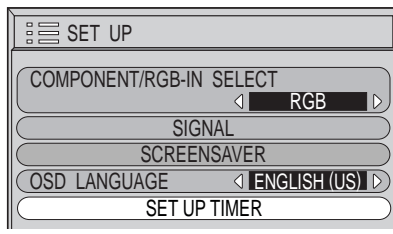
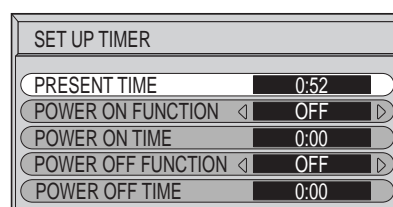

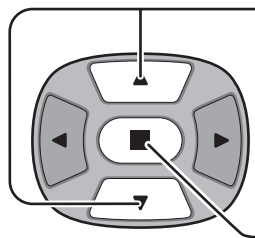

PRESENT TIME OF DAY Set

To set up PRESENT TIME, follow the procedure described below.

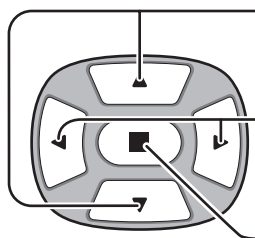
1  Press to select PRESENT TIME.
Press to display the PRESENT TIME SETUP screen.

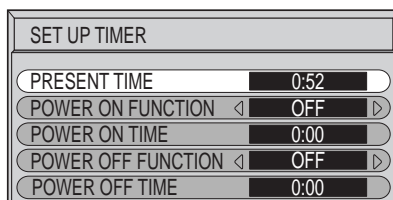
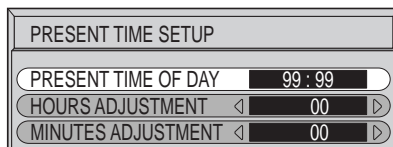
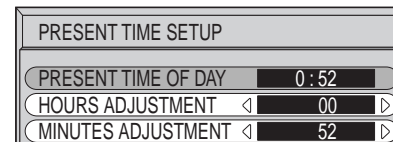
2  Press to select HOURS ADJUSTMENT/ MINUTES ADJUSTMENT.
Press to set up Hours or Minutes.
▶ button: Forward
◀ button: Back
Press to complete PRESENT TIME OF DAY setup.



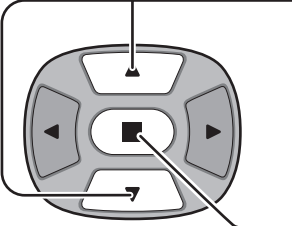

TIMER Set

- 1**

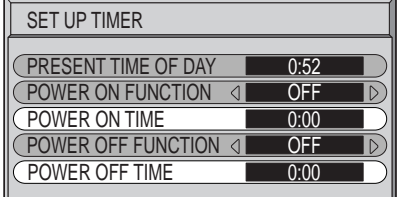

Press to select POWER ON TIME/POWER OFF TIME.



- 2**

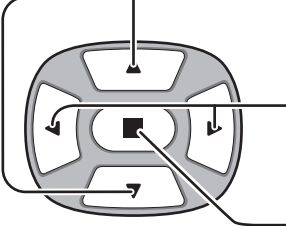

Press to select HOURS ADJUSTMENT/ MINUTES ADJUSTMENT.

Press to adjust each time.

Press to complete POWER ON TIME/ POWER OFF TIME.

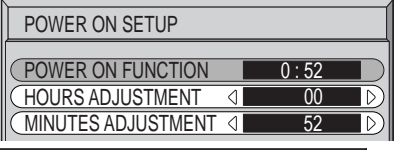
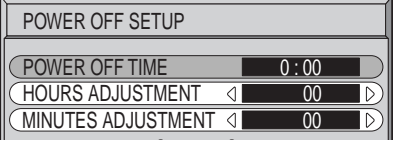

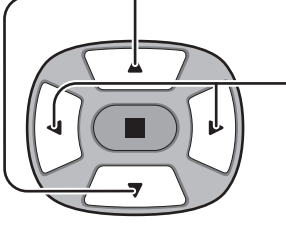

- 3**

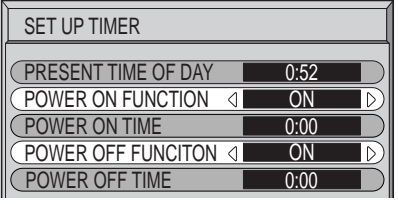

Press to select POWER ON FUNCTION/ POWER OFF FUNCTION.

Press to select ON.



- 4**



Press twice to exit from SETUP.

Note :
 Timer function will not work unless "PRESENT TIME OF DAY" is set.

SCREENSAVER (For preventing after-images)

Do not display a still picture, especially in 4:3 mode, for any length of time. If the display must remain on, a SCREENSAVER should be used.

1  Press to display the SETUP menu screen.

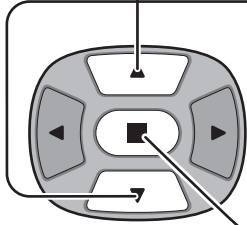
2  Press to select the SCREENSAVER.
Press to select the SCREENSAVER screen.

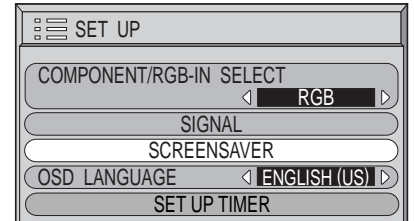

NEGATIVE / SCROLL selection

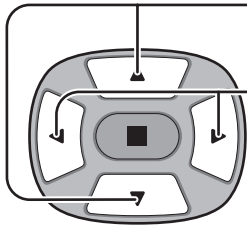
3  Press to select the FUNCTION.
Press to select the desired function.
WHITE BAR SCROLL ← → NEGATIVE

WHITE BAR SCROLL : A white bar will scroll from left to right.
NEGATIVE : A negative image will be displayed on the screen.

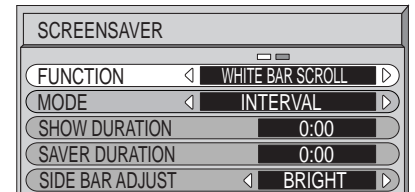

MODE selection

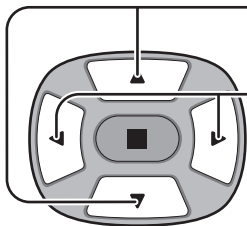
4  Press to select the MODE.
Press to select each mode items.

OFF
↑ ↓
INTERVAL : Operates when SHOW DURATION and SAVER DURATION are set up and those times arrive.
↑ ↓
TIME OF DAY : Operates when START TIME and FINISH TIME are set up and those times arrive.
↑ ↓
ON : Operates when the  (ACTION) is pressed.

To stop the SCREENSAVER under ON, press the  button.

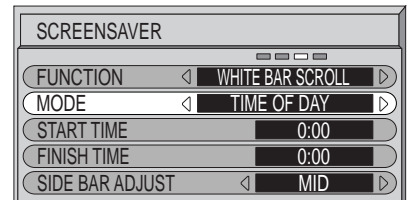

If the MODE is at ON, the menu screen will disappear and the SCREENSAVER will be activated.

After selecting TIME OF DAY or INTERVAL, the relevant SET UP TIME will become available for selection and the OPERATING TIME may be set. (Time cannot be set when "MODE" is "ON" or "OFF.")

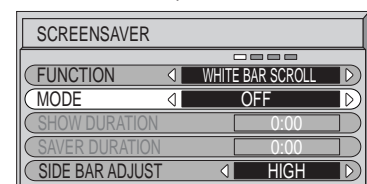
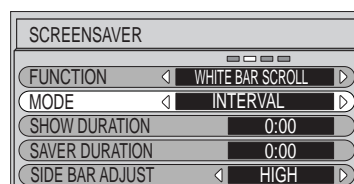
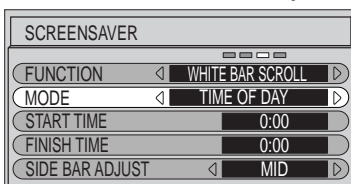

Setup of SCREENSAVER Time

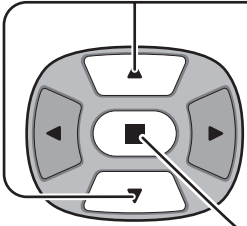
- 5**  Press to select START TIME/ FINISH TIME (When TIME OF DAY is selected). Press to select SHOW DURATION/ SAVER DURATION (When INTERVAL is selected).
Press to select each time adjustment screen.

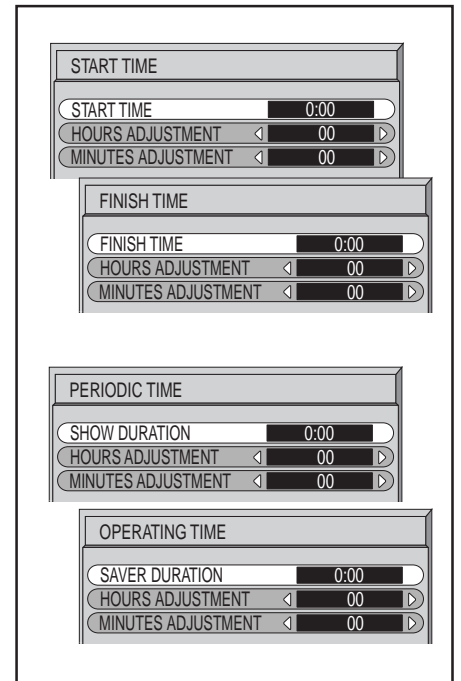
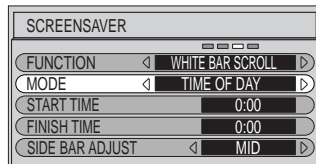
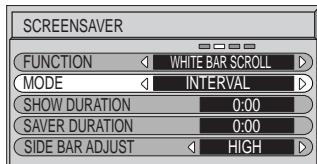

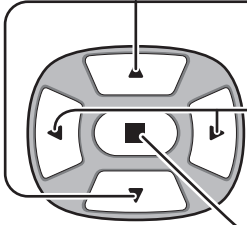
- 6**  Press to select HOURS ADJUSTMENT/ MINUTES ADJUSTMENT.
Press to set up HOURS or MINUTES.
▶ button: Forward
◀ button: Back
Press to store settings.

Note : Timer function will not work unless "PRESENT TIME OF DAY" is set.

SIDE BAR ADJUST

Do not display a picture in 4:3 mode for an extended period, as this can cause an after-image to remain on the side bars on either side of the display field.
To prevent the appearance of such an after-image, change the brightness of the side bars.

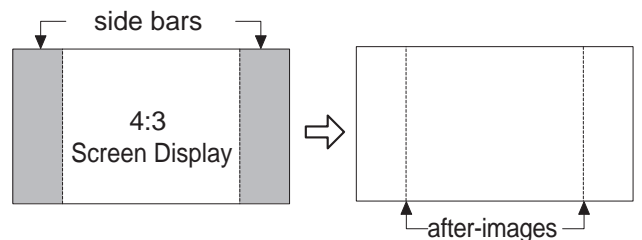

- 1** To display the SCREENSAVER screen.
(Refer to page 32, operation guide steps 1 and 2.)

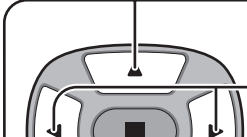
- 2**  Press to select the SIDE BAR ADJUST.
Press to select OFF, DARK, MID, BRIGHT.

> OFF <-> DARK <-> MID <-> BRIGHT <

- 3**  Press to exit from SCREENSAVER.

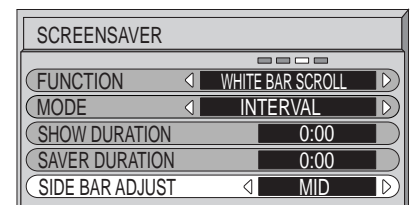

Notes:

- Setting the side bar to bright mode for an extended period may result in occurrence of after-images.
- The side bar may flash (alternate black/white) depending on the picture being shown on the screen. In such an occurrence, use the Cinema mode.

SET UP for Input Signals

COMPONENT/RGB IN SELECT

Select to match the signals from the source connected to the COMPONENT/RGB input terminals.

Y, P_B, P_R signals ⇔ "COMPONENT"

R, G, B, HD, VD signals ⇔ "RGB"

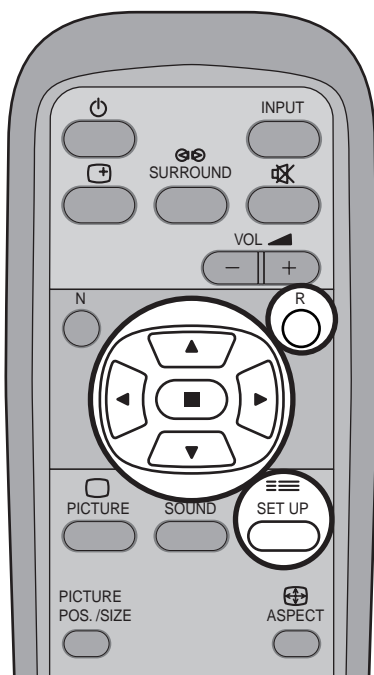

1  Press to display the SET UP menu screen.

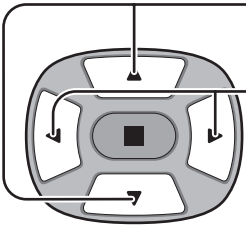
2  Press to select the "COMPONENT/RGB IN SELECT".
Press to select the desired mode.

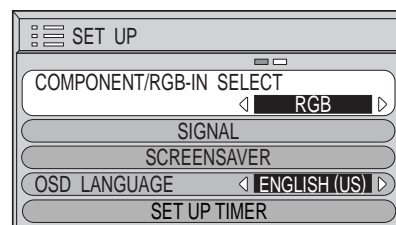

COMPONENT ↔ RGB

 Press to exit from adjust mode.

3D Y/C FILTER – For NTSC Video images

Select "SIGNAL" from the "SET UP" menu during VIDEO (S VIDEO) input signal mode.
("SIGNAL [VIDEO]" menu is displayed.)

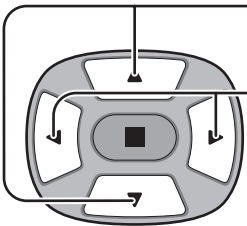
 Press to select the "3D Y/C FILTER (NTSC)"

 Press to set ON/OFF.

 Press to exit from adjust mode.

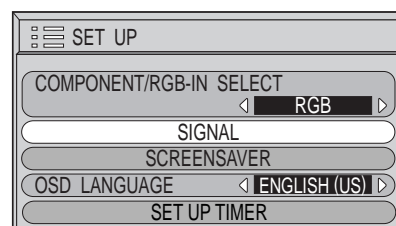

↓ Press  (ACTION) button

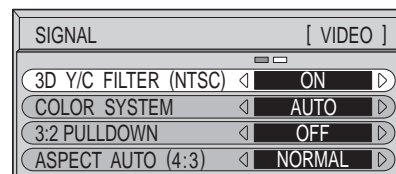

Note:

When ON, this setting only affects NTSC input signals.

COLOR SYSTEM / ASPECT AUTO

Select SIGNAL from the "SET UP" menu during VIDEO (S VIDEO) input signal mode. ("SIGNAL [VIDEO]" menu is displayed.)

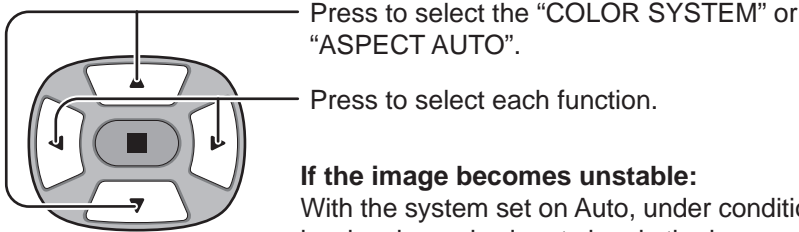

If the image becomes unstable:
With the system set on Auto, under conditions of low level or noisy input signals the image may in rare cases become unstable. Should this occur, set the system to match the format of the input signal.

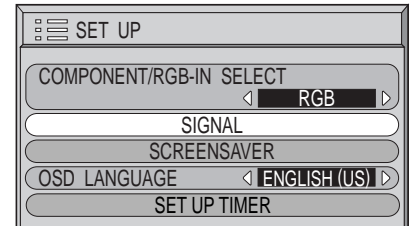

Press (ACTION) button

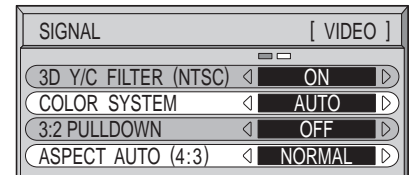

Mode	Function
COLOR SYSTEM	Set the COLOR SYSTEM to match that of the input signal. If set to "AUTO", the COLOR SYSTEM is automatically selected from "PAL", "SECAM" and "NTSC", but not from "M-NTSC". To view M-NTSC format pictures, you must manually set to "M-NTSC". <div style="text-align: center;"> > AUTO <-> PAL <-> SECAM <-> M.NTSC <-> NTSC < </div>
ASPECT AUTO (4:3)	Set to "NORMAL" to view 4:3 images in an unchanged format when "ASPECT AUTO" is selected. If you would like to view 4:3 images in Just format, set to "JUST".

3:2 PULLDOWN

When ON, the display attempts to reproduce a more natural interpretation of sources such as movie pictures, which are recorded at 24 frames per second.
If the picture is not stable, turn the setting to OFF.

Select "SIGNAL" from the "SET UP" menu during VIDEO (S VIDEO) or COMPONENT input signal mode. ("SIGNAL [VIDEO]" menu is displayed.)

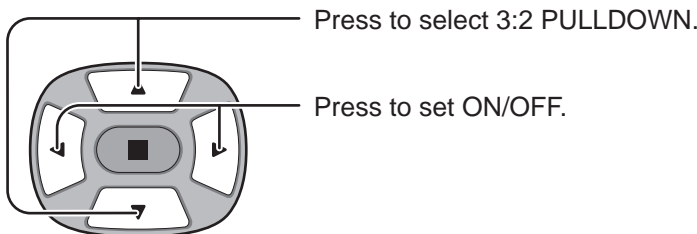

Note:
When ON, this setting only affects the following signal input.

- NTSC signal input during "VIDEO (S VIDEO)" input signal mode.
- 525i(480i) signal input during "COMPONENT" input signal mode.

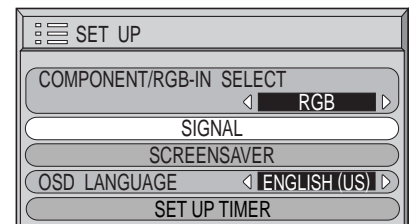
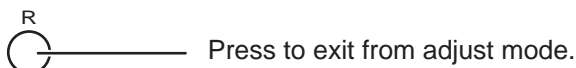

Press (ACTION) button

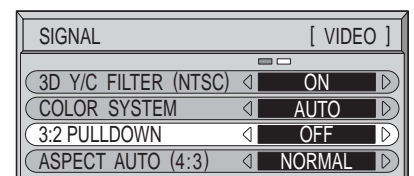

SET UP for Input Signals

SYNC

Select SIGNAL from the "SET UP" menu during RGB or PC input signal mode.

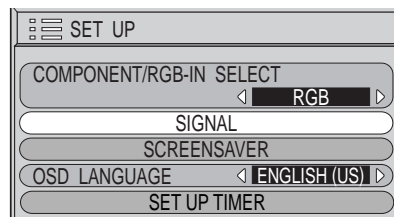
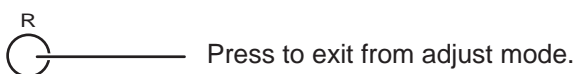
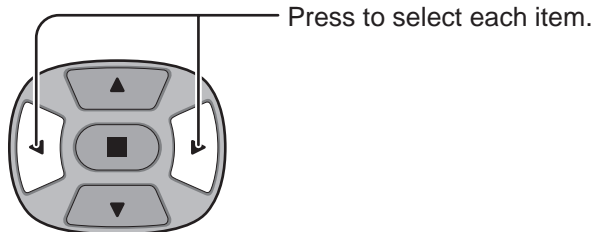

Press (ACTION) button

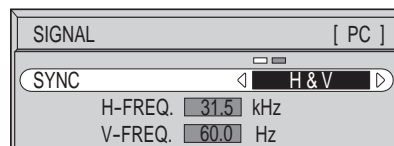
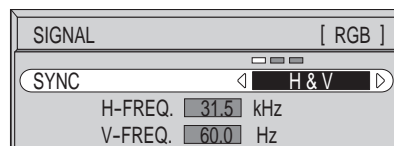

Setting RGB sync signal

Confirm that the input is set to RGB INPUT (this setting is valid only for RGB INPUT).

- H & V: The H and V sync signals are input from the HD/VD connector.
- ON G: Uses a synchronized signal on the Video G signal, which is input from the G connector.
- ON VIDEO: The composite video signal input from the VIDEO input terminal is used by dividing the sync signals.

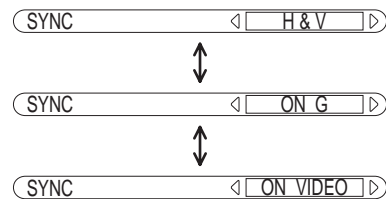

Setting PC sync signal

Confirm that the input is set to PC INPUT (this setting is valid only for PC INPUT).

- H & V: The H and V sync signals are input from the HD/VD connector.
- ON G: Uses a synchronized signal on the Video G signal, which is input from the G connector.

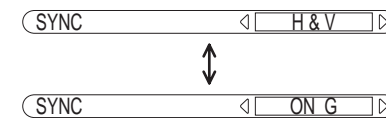

H-FREQ. (kHz)/V-FREQ. (Hz)

Displays the H (Horizontal)/V (Vertical) frequencies.

This display is valid only for RGB input and PC input.





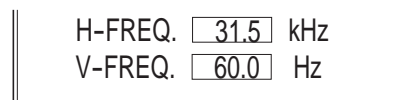

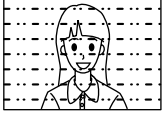

Display range:

- Horizontal 15.5 - 110 kHz
- Vertical 48 - 120 Hz

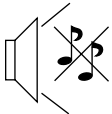

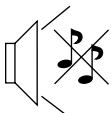
Troubleshooting

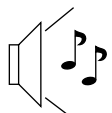
Before you call for service, determine the symptoms and make a few simple checks as shown below.

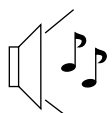
Symptoms		Checks
Picture	Sound	
 Interference	 Noisy Sound	Electrical Appliances Cars/Motorcycles Fluorescent light
 Normal Picture	 No Sound	Volume (Check whether the mute function has been activated on the remote control.)
 No Picture	 No Sound	Not plugged into AC outlet Not switched on PICTURE and BRIGHTNESS/Volume setting (Check by pressing the power switch or stand-by button on the remote control.)
 No Picture	 Normal Sound	If a signal with a non-applicable color system format, or frequency is input, only the input terminal indication is displayed.
 No Color	 Normal Sound	Color controls set at minimum level. (see page 28, 29) COLOR SYSTEM (see page 35)

Plasma Display panel

Symptoms	Check
Some parts of the screen do not light up.	The plasma display panel is manufactured using an extremely high level of precision technology, however, sometimes some parts of the screen may be missing picture elements or have luminous spots. This is not a malfunction.
 After-images appear	Do not allow a still picture to be displayed for an extended period, as this can cause a permanent after-image to remain on the Plasma Display. Examples of still pictures include logos, video games, computer images, teletext and images displayed in 4:3 mode. Note: The permanent after-image on the Plasma Display resulting from fixed image use is not an operating defect and as such is not covered by the Warranty. This product is not designed to display fixed images for extended periods of time.
Whirring sounds can be heard from the display unit.	The display unit is fitted with a cooling fan to dissipate heat generated during normal use. The whirring sound is caused by rotation of the fan and is not a malfunction.

Specifications

GD-V501U	
Power Source	120 V AC, 50Hz/60Hz
Power Consumption	
Maximum	5.5 A
Stand-by condition	2.4 W
Power off condition	0.9 W
Plasma Display panel	Drive method AC type 50-inch, 16:9 aspect ratio
Contrast Ratio	3000:1
Screen size	1,106 mm (W) × 622 mm (H) × 1,269 mm (diagonal) No. of pixels 1,049,088 (1,366 (W) × 768 (H)) [4,098 × 768 dots]
Operating condition	
Temperature	34 °F - 104 °F (0 °C - 40 °C)
Humidity	20 % - 80 %
Applicable signals	
Color System	NTSC, PAL, PAL60, SECAM, Modified NTSC
Scanning format	525i (480i), 625i (575i), 525p (480p), 625p (575p), 750p (720p), 1,125/60i, 50i, 24p, 24sF (1,080/60i, 50i, 24p, 24sF) SMPTE 274M
PC signals	XGA display VGA, SVGA, XGA SXGA, UXGA (compressed) Horizontal scanning frequency 15.5 - 110 kHz Vertical scanning frequency 48 - 120 Hz
Connection terminals	
AV	VIDEO IN/OUT (BNC) 1.0 Vp-p (75-ohm or high impedance) S VIDEO IN (MINI DIN 4PIN) Y: 1 Vp-p (75-ohm), C: 0.286 Vp-p (75-ohm) AUDIO IN (RCA PIN JACK × 2) 0.5 Vrms (high impedance)
COMPONENT/RGB	Y/G (BNC) 1.0 Vp-p/composite (75-ohm) 0.7 Vp-p/non-composite (75-ohm) P _B /B (BNC) 0.7 Vp-p (75-ohm) P _R /R (BNC) 0.7 Vp-p (75-ohm) HD (BNC) 1.0 - 5.0 Vp-p (high impedance) VD (BNC) 1.0 - 5.0 Vp-p (high impedance) AUDIO IN (RCA PIN JACK × 2) 0.5 Vrms (high impedance)
PC	(HIGH-DENSITY D-SUB 15PIN) R,G,B/0.7 Vp-p (75-ohm) HD, VD/1.0 - 5.0 Vp-p (high impedance) AUDIO IN (M3 JACK) 0.5 Vrms (high impedance)
SERIAL	EXTERNAL CONTROL TERMINAL (D-SUB 9PIN) RS-232C COMPATIBLE
SPEAKERS (6 Ω)	16W [8 W + 8 W] (10 % THD) For TS-C5000SPG only

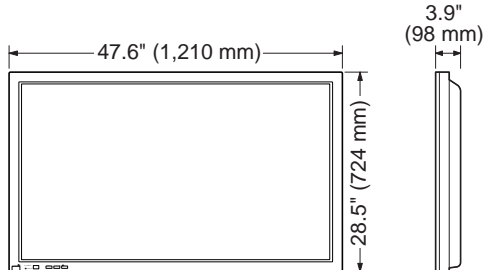
GD-V501U	
Accessories Supplied	
Remote Control Transmitter	EUR646526
Batteries	2 × AA Size
Fixing bands	× 2
Ferrite core	small size × 1 large size × 2
Optional Supplied	
Speakers	TS-C5000SPG
Stand Unit	TS-C50P1G
Wall Mounting Unit	TS-C50P6G
Wall Mounting Unit (angled)	TS-C50P2G
Ceiling Suspension Unit	TS-C50P3G
Dimensions (W × D × H)	<p>47.6" (1210mm) × 28.5" (724 mm) × 3.9" (98mm)</p> 
Mass (Weight)	<p>approx. 94.8 lbs (main unit only)</p> <p>approx. 104.9 lbs (with speakers)</p>

Note:

Design and specifications are subject to change without notice. Weight and dimensions shown are approximate.



VICTOR COMPANY OF JAPAN, LIMITED



Free Manuals Download Website

<http://myh66.com>

<http://usermanuals.us>

<http://www.somanuals.com>

<http://www.4manuals.cc>

<http://www.manual-lib.com>

<http://www.404manual.com>

<http://www.luxmanual.com>

<http://aubethermostatmanual.com>

Golf course search by state

<http://golfingnear.com>

Email search by domain

<http://emailbydomain.com>

Auto manuals search

<http://auto.somanuals.com>

TV manuals search

<http://tv.somanuals.com>