

# JVC

**LCD DISPLAY MONITOR**

---

**GM-H40L1G**

**INSTRUCTIONS**

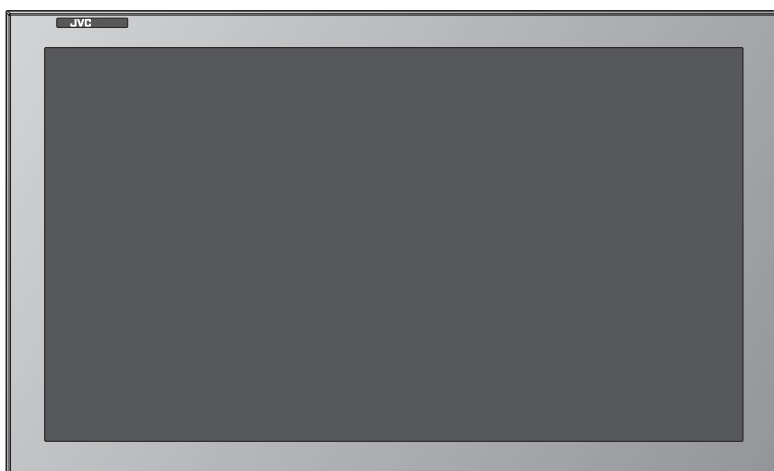

LCT1942-001A

# Safety Precautions

## FCC NOTICE

**CAUTION:** Changes or modifications not approved by JVC could void the user's authority to operate the equipment.

**NOTE:** This equipment has been tested and found to comply with the limits for a Class B digital device, pursuant to Part 15 of the FCC Rules. These limits are designed to provide reasonable protection against harmful interference in a residential installation. This equipment generates, uses and can radiate radio frequency energy and, if not installed and used in accordance with the instructions, may cause harmful interference to radio communications. However, there is no guarantee that interference will not occur in a particular installation. If this equipment does cause harmful interference to radio or television reception, which can be determined by turning the equipment off and on, the user is encouraged to try to correct the interference by one or more of the following measures:

- Reorient or relocate the receiving antenna.
- Increase the separation between the equipment and receiver.
- Connect the equipment into an outlet on a circuit different from that to which the receiver is connected.
- Consult the dealer or an experienced radio/TV technician for help.

## IMPORTANT INFORMATION

**WARNING:** TO REDUCE THE RISK OF FIRE AND ELECTRIC SHOCK, DO NOT EXPOSE THIS APPARATUS TO RAIN, MOISTURE, DRIPPING OR SPLASHING AND THAT NO OBJECTS FILLED WITH LIQUIDS, SUCH AS VASES, SHALL BE PLACED ON THE APPARATUS.

## IMPORTANT SAFEGUARDS

Electrical energy can perform many useful functions. This unit has been engineered and manufactured to assure your personal safety. But **IMPROPER USE CAN RESULT IN POTENTIAL ELECTRICAL SHOCK OR FIRE HAZARD.** In order not to defeat the safeguards incorporated into this product, observe the following basic rules for its installation, use, and service. Please read these "IMPORTANT SAFEGUARDS" carefully before use.

- All the safety and operating instructions should be read before the product is operated.
- The safety and operating instructions should be retained for future reference.
- All warnings on the product and in the operating instructions should be adhered to.
- All operating instructions should be followed.

## POWER CONNECTION

The power supply voltage rating of this product is AC 120 V. Do not use other power cords than the power cord attached to this product.

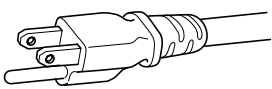

This plug will fit only into a grounded power outlet. If you are unable to insert the plug into the outlet, contact your electrician to install the proper outlet. Do not defeat the safety purpose of the grounded plug.

- This product should be operated only with the type of power source indicated on the label. If you are not sure of the type of power supply of your home, consult your product dealer or local power company.

**Unplug this product from the wall outlet and refer service to qualified service personnel under the following conditions:**

- a) When the power supply cord or plug is damaged.
- b) If liquid has been spilled, or objects have fallen on the product.
- c) If the product has been exposed to rain or water.
- d) If the product operated normally by following the operating instructions. Adjust only those controls that are covered by the Operation Manual, as an improper adjustment of controls may result in damage and will often require extensive work by a qualified technician to restore the product to normal operation.
- e) If the product has been dropped or damaged in any way.
- f) When the product exhibits a distinct change in performance—this indicates a need for service.

- Never push objects of any kind into this product through openings as they may touch dangerous voltage points or short out parts that could result in a fire or electric shock.
- Never spill liquid of any kind on the product.

- Do not use this product near water.
- Do not use immediately after moving from a low temperature to high temperature, as this causes condensation, which may result in a fire, electric shock, or other hazards.

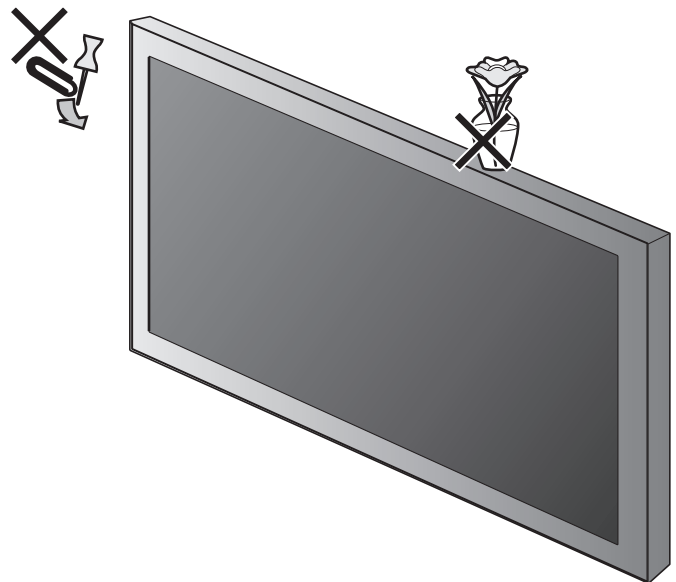

Do not attempt to service this product yourself, as opening or removing covers may expose you to dangerous voltages and other hazards. Refer all service to qualified service personnel.

- Slots and openings in the cabinet are provided for ventilation. These ensure reliable operation of the product and protect it from overheating. These openings must not be blocked or covered.
- The openings should never be blocked by placing the product on bed, sofa, rug, or similar surface. It should not be placed in a built-in installation such as a bookcase or rack unless proper ventilation is provided and the manufacturer's instructions have been adhered to.
- For proper ventilation, separate the product from other equipment, which may prevent ventilation and keep distance more than 10 cm (3 <sup>15</sup>/<sub>16</sub> inches).

- Do not place this product on an unstable cart, stand, or table. The product may fall, causing serious injury to a child or adult, and serious damage to the product. The product should be mounted according to the manufacturer's instructions, and should use a mount recommended by the manufacturer.
- When the product is used on a cart, care should be taken to avoid quick stops, excessive force, and uneven surfaces which may cause the product and cart to overturn, damaging equipment or causing possible injury to the operator.



# Safety Precautions (cont.)

- Power-supply cords should be routed so that they are not likely to be walked on or pinched by items placed upon or against them. Pay particular attention to cords at doors, plugs, receptacles, and the point where they exit from the product.
- For added protection of this product during a lightning storm, or when it is left unattended and unused for long periods of time, unplug it from the wall outlet and disconnect the cable system. This will prevent damage to the product due to lightning and power line surges.
- Do not overload wall outlets, extension cords, or convenience receptacles on other equipment as this can result in a risk of fire or electric shock.
- Use only the accessory cord designed for this product to prevent shock.

Do not place combustibles behind the cooling fan. For example, cloth, paper, matches, aerosol cans or gas lighters that present special hazards when over heated.

The product should be placed more than 30 cm (11 <sup>13</sup>/<sub>16</sub> inches) away from heat sources such as radiators, heat registers, stoves, and other products (including amplifiers) that produce heat.

- When connecting other products such as VCR's and personal computers, you should turn off the power of this product for protection against electric shock.
- Do not use attachments not recommended by the product manufacturer as they may be hazardous.

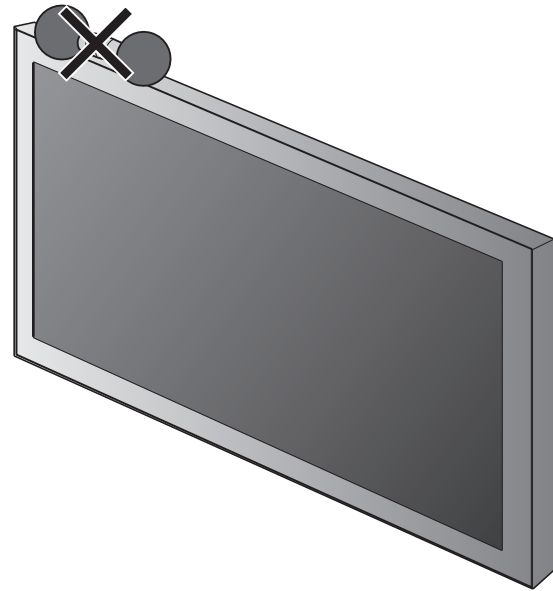

## Maintenance

- Unplug this product from the wall outlet before cleaning.
- Do not use liquid cleaners or aerosol cleaners. Use a damp cloth for cleaning.
- Use a vacuum cleaner to get rid of the dust around the intakes (all the openings) on the rear. If a vacuum is not available, use a cloth and wipe it off. Failure to do so will cause internal heat buildup and, therefore, cause damage to the product.

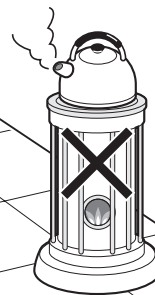

- **When replacement parts are required**, be sure the service technician has used replacement parts specified by the manufacturer or with same characteristics as the original part. Unauthorized substitutions may result in fire, electric shock, or other hazards.
- **Upon completion of any service or repairs to this product**, ask the service technician to perform safety checks to determine that the product is in proper operating condition.

# Table of Contents

<b>Safety Precautions</b> .....	<b>2</b>	<b>Menu Operations</b> .....	<b>17</b>
IMPORTANT SAFEGUARDS .....	2	<b>Menu Configuration—MAIN MENU</b> .....	<b>18</b>
<b>Parts Identification</b> .....	<b>6</b>	<b>Menu Configuration—SET-UP MENU</b> .....	<b>24</b>
Front panel.....	6	Setting the Power-on Lock.....	30
Rear panel.....	6	<b>How to Use External Control</b> .....	<b>31</b>
Remote control.....	8	<b>Troubleshooting</b> .....	<b>34</b>
<b>Installation</b> .....	<b>9</b>	Self-diagnostic indication.....	36
Connecting external speakers .....	10	<b>Specifications</b> .....	<b>37</b>
<b>Connections</b> .....	<b>11</b>		
Available signals.....	11		
<b>Daily Operations</b> .....	<b>14</b>		
Turning on the main power .....	14		
Turning on the monitor.....	14		
Selecting an input .....	14		
Adjusting the volume .....	14		
Changing the aspect ratio .....	15		
Displaying the current status .....	15		
Selecting the picture mode .....	16		
Selecting the audio mode .....	16		
Viewing Inputs A and B (analog RGB input) at the same time—Dual Display .....	16		

## Checking the accessories

The following accessories are included with the monitor. Check for them. If any item is missing, please contact the dealer where you have purchased the monitor.

- Remote control (RM-C2005)
- Power cord x 1
- D-sub 15 pin – BNC conversion cable x 1
- Batteries (AA/R6) x 2
- Ferrite cores x 2

### NOTE

- Be sure to attach the supplied ferrite cores to the speaker cords when using external speakers to reduce interference from the monitor on external equipment (see page 10).

# Parts Identification

## Front panel

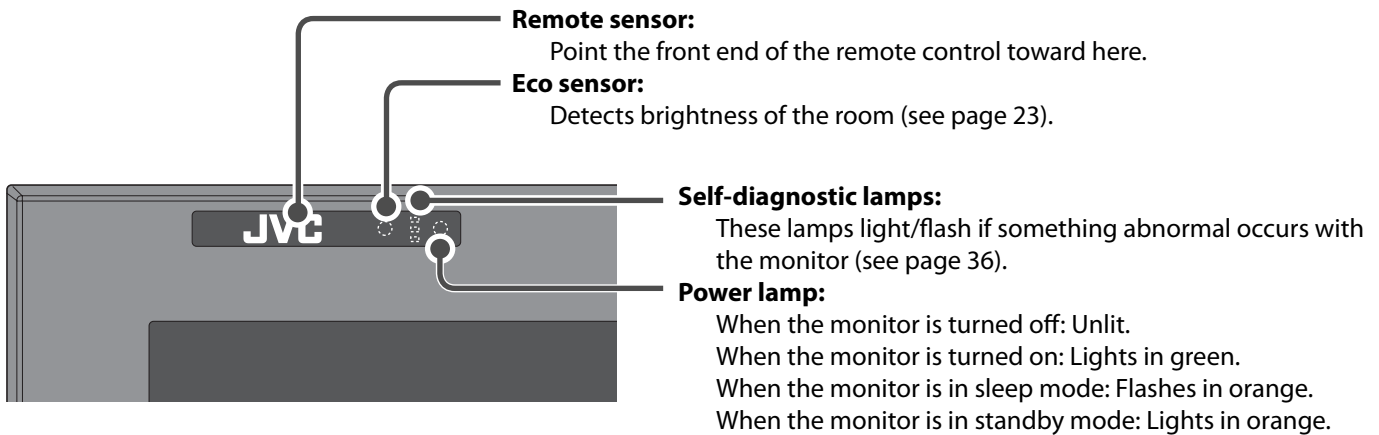

## Rear panel

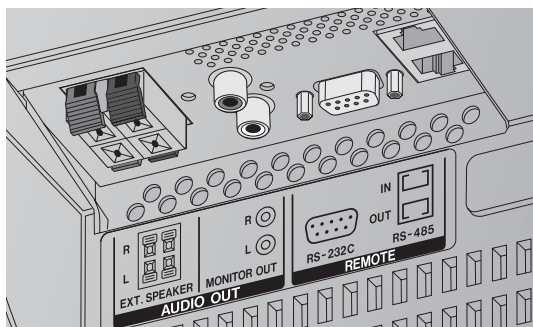
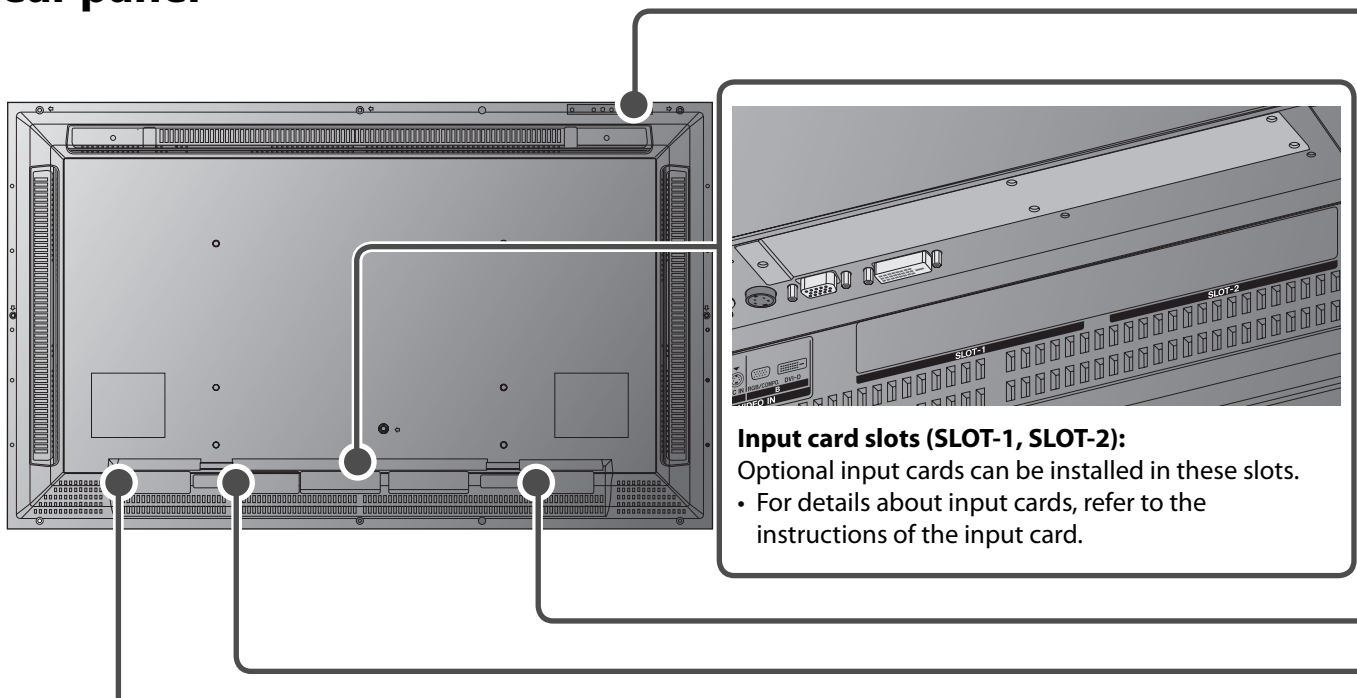

### REMOTE terminals

Connect external control equipment (see pages 12, 31 to 33).

**RS-232C terminal:** Connect to the RS-232C terminal of a personal computer. For the control method using this terminal, consult an authorized JVC dealer.

### RS-485 terminals:

**IN terminal:** Connect external control equipment.

**OUT terminal:** Connect another component to send out the control signal coming into the IN terminal (cascade connection).

### AUDIO OUT terminals

Connect external speakers or audio equipment.

**EXT. SPEAKER terminal:** Connect external speakers (commercially available) (see page 10).

• To use this terminal, set "SPEAKER SELECT" on the main menu to "EXT. (external)" (see page 21).

**MONITOR OUT terminals:** Connect to the audio input terminals of audio equipment such as an amplifier (see page 12).

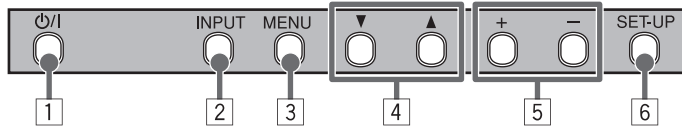

- 1 **⏻/⏻ (Power) button:** Turns the monitor on/off (see page 14).
- 2 **INPUT button:** Changes inputs (see page 14).
- 3 **MENU button:** Displays the main menu (see page 17).
- 4 **▲/▼ buttons:** Selects an item on the menu (see page 17).
- 5 **+/- buttons:** Adjusts the volume level (see page 14).
  - When the menu is displayed, adjusts the value (see page 17).
- 6 **SET-UP button:** Displays the set-up menu (see page 17).

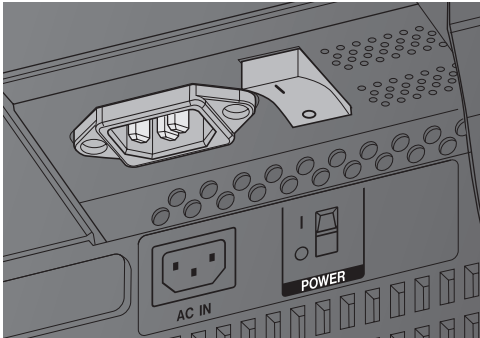

**AC IN terminal:**

Connect the supplied power cord (see page 13).

**POWER switch:**

- I:** Turns on the main power. (The power can be controlled by POWER ON/OFF buttons on the remote control or ⏻/⏻ button on the main unit.)
- O:** Turns off the main power.

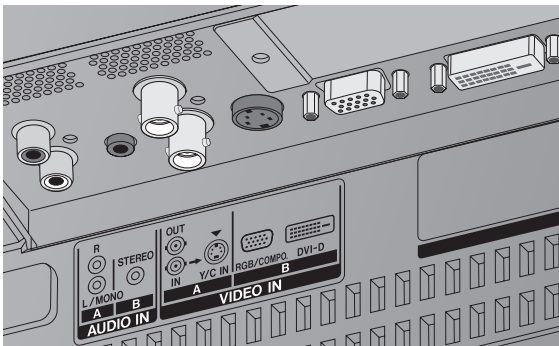

**AUDIO IN A/B terminals**

Connect audio output terminals of equipment such as a VCR (see page 13).

**AUDIO IN A terminal**

**R, L/MONO terminals (pin jack):**

Connect to the audio output terminals of the equipment connected to the VIDEO IN A terminal. (Connect only the L/MONO terminal for monaural sound.)

**AUDIO IN B terminal**

**STEREO terminal (stereo mini jack):**

Connect to the audio output terminals of the equipment connected to the VIDEO IN B terminal.

**VIDEO IN A/B terminals**

Connect video output terminals of equipment such as a VCR (see page 13).

**VIDEO IN A terminal**

**IN terminal (BNC):** Connect to the video output terminals of playback equipment such as a VCR.

**OUT terminal (BNC):** Connect to the video input terminal of another monitor, etc.

**Y/C IN terminal (Y/C):** Connect to the S-video output terminal of playback equipment such as a VCR.

• When both IN terminal and Y/C IN terminal are used, the input to the Y/C IN terminal has priority.

**VIDEO IN B terminal**

**RGB/COMPO. terminal (D-sub 15-pin)\*:** Connect to the video output terminal of a personal computer or playback equipment such as a VCR.

**DVI-D terminal (DVI-D)\*:** Connect to the digital output terminal of a personal computer.

\* When connecting to a personal computer, use a cable with ferrite cores and no longer than of 3 m (118 1/8") to avoid electromagnetic disturbance.

# Parts Identification (cont.)

## Remote control

**POWER OFF button**  
Turns off the monitor (see page 14).

**POWER ON button**  
Turns on the monitor (see page 14).

**SET-UP button**  
Displays the set-up menu (see page 17).

**ASPECT button**  
Changes the aspect ratio (see page 15).

**MENU/EXIT button**  
Displays the main menu (see page 17).

**DISPLAY button**  
Displays the information of the current input (see page 15).

**PICTURE MODE buttons**  
Changes the picture mode (see page 16).

**▲▼◀▶ buttons**  
Operates the menu (see page 17).

**OK button**  
Enters the password for the Power-on Lock (see page 30).

**DUAL DISPLAY buttons**  
Activates/deactivates the dual display mode (see page 16).

**INPUT SELECT buttons**  
Selects the input (see page 14).

**A (VIDEO) button**  
Selects the input to the VIDEO IN A terminal (Input A).

**B (RGB/COMPO./DVI) button**  
Selects the input to the VIDEO IN B terminal (Input B).

**C, D (SLOT-1) buttons**  
Selects the input to the optional input card inserted in the slot 1 (Input C/D).

**E, F (SLOT-2) buttons**  
Selects the input to the optional input card inserted in the slot 2 (Input E/F).

**AUDIO MODE buttons**  
**VOLUME +/- buttons**  
Adjusts the volume level (see page 14).

**STEREO, MONO buttons**  
Changes the audio mode (see page 16).

**MUTING button**  
Turns off the volume immediately (see page 14).

## Inserting the batteries

Use two AA/R6 dry cell batteries.

Insert the batteries from the ⊖ end, making sure the ⊕ and ⊖ polarities are correct.

- Follow the warnings printed on the batteries.
- Battery life is about six months to one year, depending on how much you use the remote control.
- The batteries we supply are only for setting up and testing your monitor, please replace them as soon as you need to.
- If the remote control does not work properly, replace the batteries.

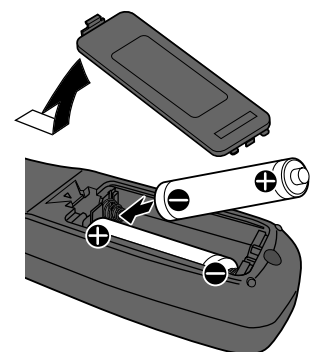



# Installation

## Precautions

- When installing the monitor, be sure to use a dedicated stand unit or wall mounting unit, depending on your particular case. Ask your dealer to install.
- When installing the monitor in a special way (for example, installing it diagonally), consult your dealer.
- Route the power cord and connection cables along the wall or floor corners to avoid walking on them.
- For good heat dissipation, try to leave the following distance of space (minimum) around the monitor (see diagram below).
- The ambient temperature of the installation place should be within the range of 0°C to 40°C (32°F – 104°F) (slightly variable depending on ambient conditions for installation).
- When installing the monitor near the ceiling or similar location, the remote control may not work correctly because of possible effects, such as reflections, from the surroundings. If this happens, move the monitor where it is free from these effects.
- Do not install the monitor in such a way that the monitor and other AV equipment affect each other adversely. (For example, if a disturbed image or noise due to electromagnetic interference occurs, or if the infrared remote control malfunctions, change the installation place.)

## When installing the monitor on a stand

Unit: mm (inch)

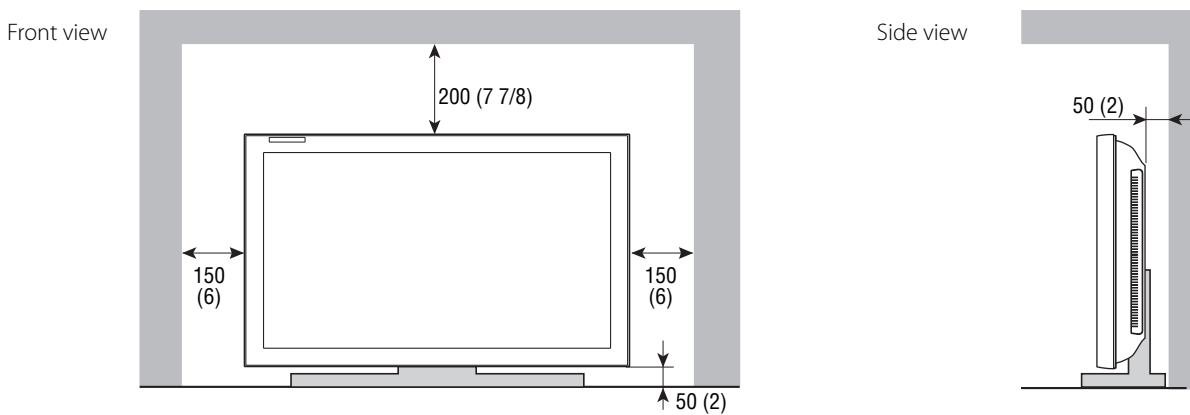

## When mounting the monitor on the wall

Unit: mm (inch)

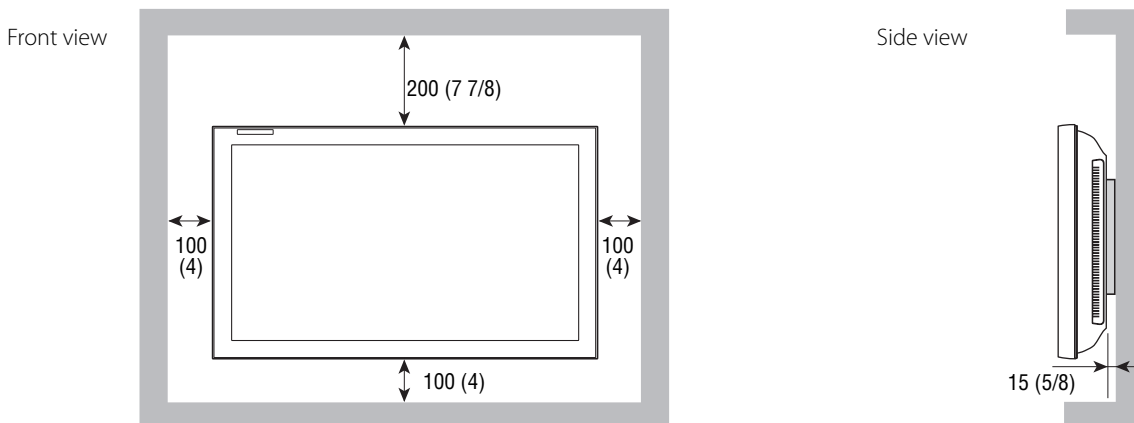

## When installing the monitor vertically

- Make sure to install the monitor in the direction illustrated on the right.
- Set the speed of the internal cooling fan to "HIGH" (see "FAN SPEED" on page 29).

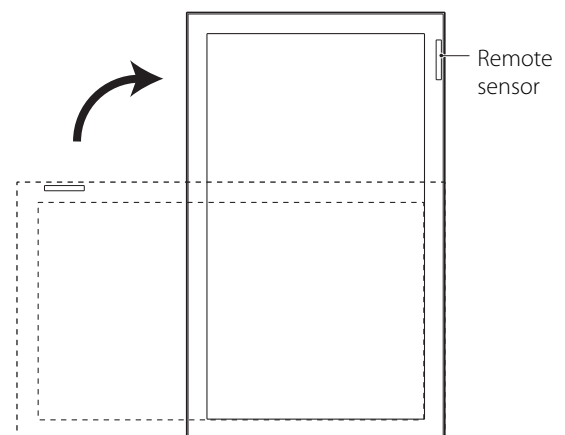

## Connecting external speakers

You can connect commercial speakers of the following specifications to the EXT. SPEAKER terminal:

- Impedance: Between 6  $\Omega$  and 8  $\Omega$
- Power handling capacity: More than 3 W

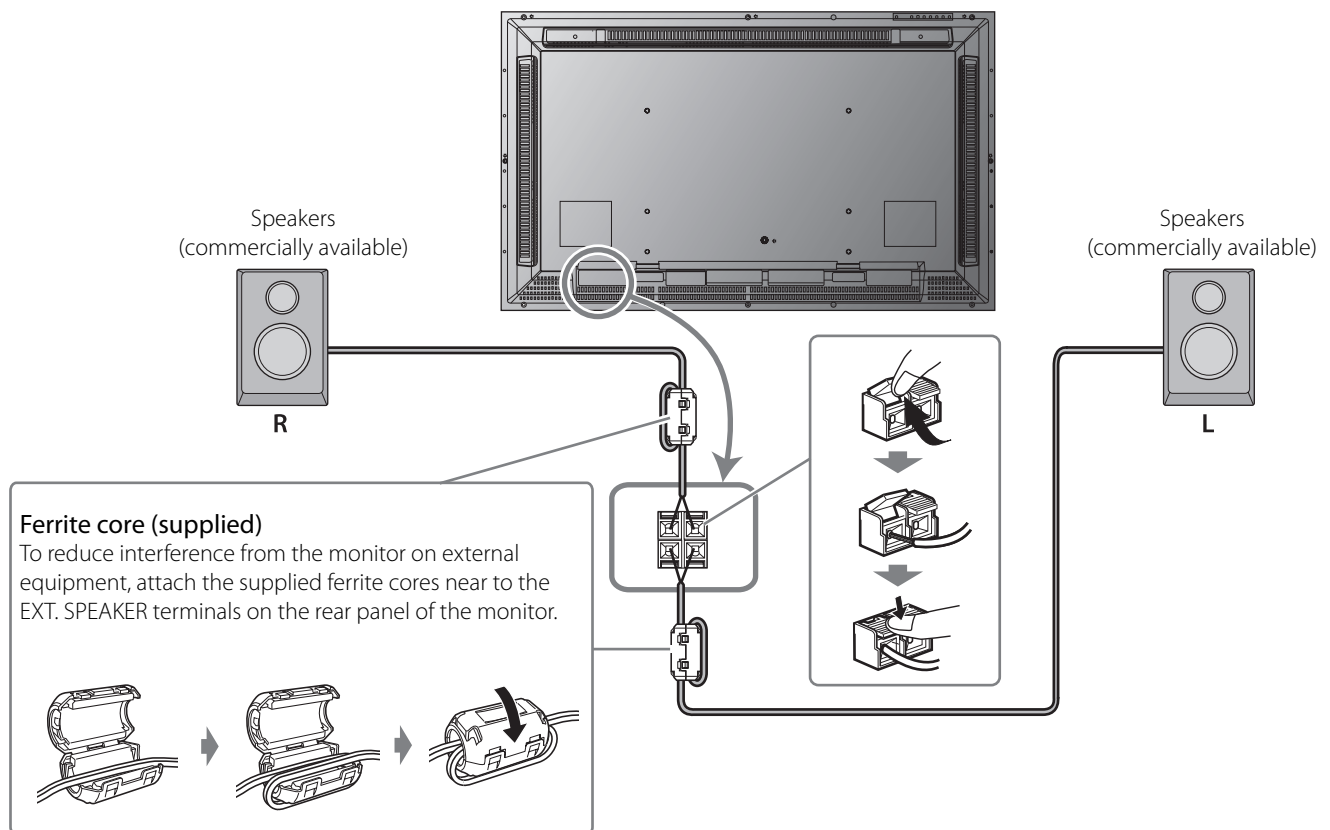

### CAUTION

- Do not short-circuit  $\oplus$  and  $\ominus$  speaker cords to each other. (Refer also to the instructions supplied with the speakers.)

### NOTE

- When using the external speakers, set "SPEAKER SELECT" on the main menu to "EXT. (external)" (see page 21).

## Available signals

The following signals can be input to this monitor.

### Video signals

Terminal		Available signals
<b>VIDEO IN A terminals</b>		NTSC, PAL, SECAM, PAL60, NTSC4.43, PAL-M, PAL-N, BW (50 Hz/60 Hz)
<b>VIDEO IN B (RGB/COMPO.) terminal</b>	Component signals	480/60i, 576/50i, 480/60p, 576/50p, 720/60p, 720/50p, 1080/60i (1035/60i)*, 1080/50i, 1080/24psF
	RGB signals	15 kHz/50 Hz, 15 kHz/60 Hz

\* Select an appropriate setting for High-Definition signal (see "1080/1035" on page 23).

### Computer signals (Preset)

#### VIDEO IN B (RGB/COMPO., DVI-D) terminals

No.	Signal name	Screen resolution		Horizontal frequency (kHz)	Vertical frequency (Hz)	Scan system	Input terminal	
		Horizontal	Vertical				RGB/COMPO.	DVI-D
1	PC98	640	400	24.8	56.4	Non-interlace	√	—
2	VGA400-70	640	400	31.5	70.1	Non-interlace	√	—
3	VGA480-60	640	480	31.5	59.9	Non-interlace	√	√
4	WVGA-60	852	480	31.5	59.9	Non-interlace	√	—
5	VGA480-72	640	480	37.9	72.8	Non-interlace	√	—
6	SVGA-60	800	600	37.9	60.3	Non-interlace	√	√
7	XGA-60	1024	768	48.4	60.0	Non-interlace	√	√
8	WXGA-60	1366	768	48.4	60.0	Non-interlace	√	√
9	XGA-70	1024	768	56.5	70.1	Non-interlace	√	—
10	XGA-75	1024	768	60.0	75.0	Non-interlace	√	—
11	XGA-85	1024	768	68.7	85.0	Non-interlace	√	—
12	XGA+-75	1152	864	67.5	75.0	Non-interlace	√	—
13	SXGA-60	1280	1024	64.0	60.0	Non-interlace	√	√
14	SXGA-75	1280	1024	80.0	75.0	Non-interlace	√	—
15	UXGA-60	1600	1200	75.0	60.0	Non-interlace	√	—
16	MAC13"	640	480	35.0	66.7	Non-interlace	√	—
17	MAC16"	832	624	49.7	74.6	Non-interlace	√	—
18	MAC19"	1024	768	60.2	74.9	Non-interlace	√	—
19	MAC21"	1152	870	68.7	75.1	Non-interlace	√	—

√ : Acceptable

— : Not acceptable

#### Note for VIDEO IN A (IN, Y/C IN) terminals

- When both IN terminal and Y/C IN terminal are used, the input to the Y/C IN terminal has priority.

#### Note for VIDEO IN B (RGB/COMPO., DVI-D) terminals

Select the correct input for Input B on the main menu (see "INPUT CONFIGURATION" on page 21).

- When RGB signals are input to the RGB/COMPO. terminal: Set "INPUT B" to "ANALOG RGB."
- When component signals are input to the RGB/COMPO. terminal: Set "INPUT B" to "COMPONENT."
- When using the DVI-D terminal: Set "INPUT B" to "DVI."

#### Note for component signals

- The monitor is compatible only with Y on sync signals. The monitor is not compatible with composite sync (Cs) and separated sync (HD/VD) signals.

#### Note for computer signals

- When a signal other than those listed above is input, part of the picture may not be displayed or an unnecessary picture may appear.
- Any signal other than those listed above may not be displayed normally although it's frequency is within the acceptable range.
- Depending on the connected equipment, the monitor may not be compatible with composite sync (Cs) or G on sync signals.
- When a preset mode signal is input, the signal format is displayed on the screen. For other signals, the horizontal frequency and vertical frequency are displayed.
- The DVI-D terminal can accept only No. 3, 6, 7, 8, and No. 13 signals.
- When the No. 3 and No. 7 signals are input, set "SAMPLING MODE" to "STD" on the set-up menu (see page 29).
- When the No. 4 and No. 8 signals are input, make the following settings:
  - Set "SAMPLING MODE" to "WIDE" on the set-up menu (see page 29).
  - Change the aspect ratio to "FULL" (see pages 15 and 19).
  - Set the video card of the personal computer to "852 x 480" (for No. 4 signal) / "1366 x 768" (for No. 8 signal).
- When No. 12 to No. 15 and No. 19 signals are input, thin lines may become obscured because their signal frequencies are higher than the screen resolution.
- The adjustment of the screen size and position is the setting common to the No. 10 and No. 18 signals. If you use both signals by switching them, the adjustment of either signal may not be proper.

# Connections (cont.)

## CAUTION

- Before making any connections, turn off all the equipment.
- DO NOT connect the power cord until all connections are completed.
- Use a cord whose plugs correctly match the terminals on this monitor and the equipment.
- Plugs should be firmly inserted; poor connections could cause noise.
- When unplugging a cord, be sure to grasp its plug and pull it out.
- Refer also to the user manual of each piece of equipment.

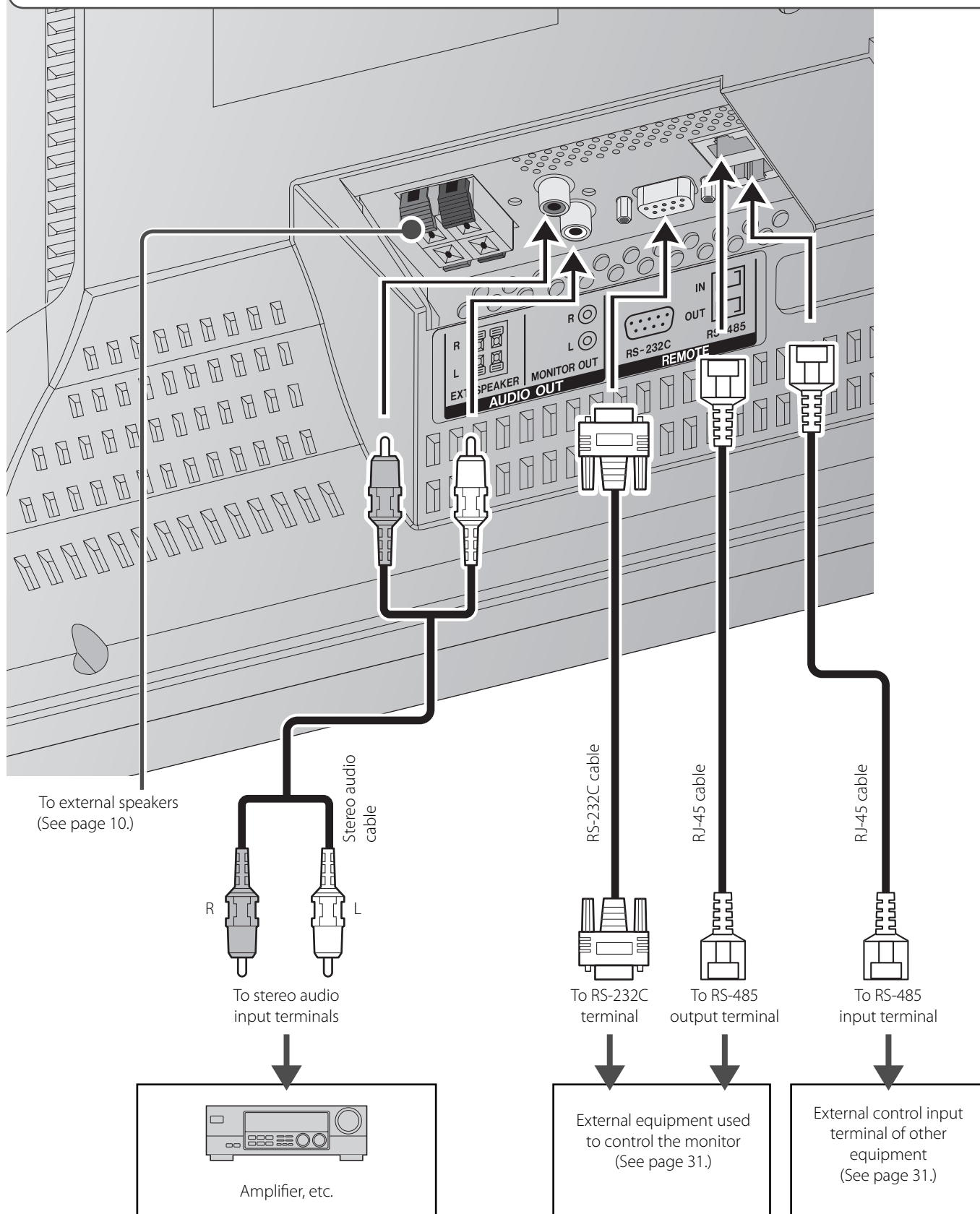

Connect the VIDEO IN A OUT terminal to the video input terminal of another monitor, etc.

**CAUTION**

- Since the IN terminal and OUT terminal are loop-through terminals, the devices connected to the OUT terminal should be correctly terminated. Otherwise, pictures become abnormally bright or the display screen gets affected abnormally.

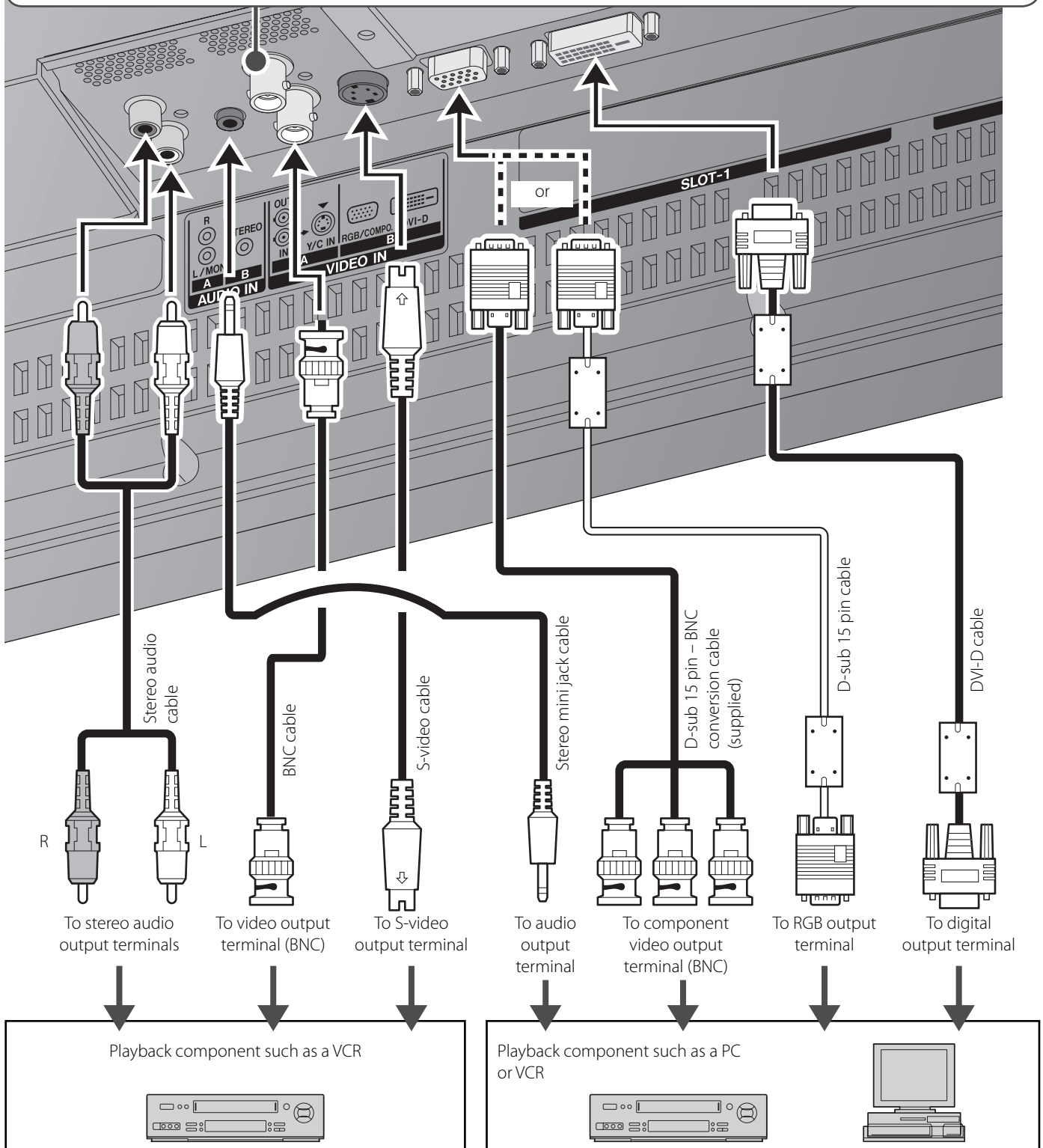

**When all the connections are completed**

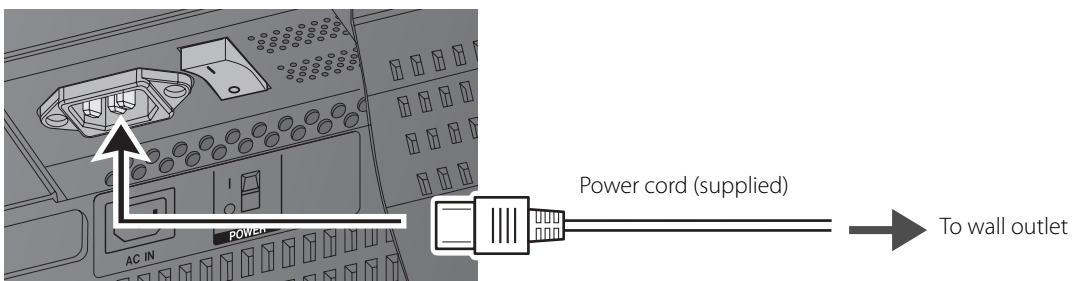

# Daily Operations

## Turning on the main power

- I : Main power on
- O : Main power off

On the rear panel

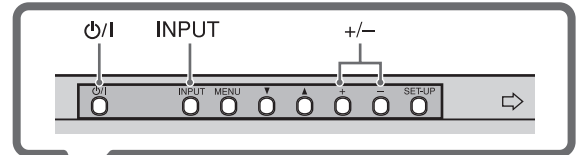
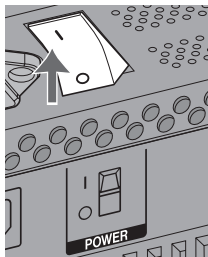

## Turning on the monitor

### From the remote control:



To turn off the monitor, press POWER OFF.

### On the main unit:

Each time you press the button, the power turns on and off.



## Selecting an input

### From the remote control:

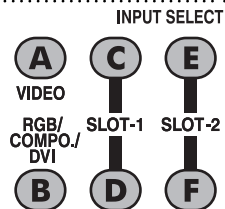

### On the main unit:

Each time you press the button, the input changes.



### NOTE

- When "QUICK CHANGE" is set to "INPUT A&B," you can change Inputs A and B quickly (see "INPUT CONFIGURATION" on page 21).

## Adjusting the volume

### From the remote control:



### On the main unit:



### To turn off the volume immediately:

Pressing the button again resumes the previous volume level.

- When using the buttons on the main unit, set "MUTING" to "ON" on the main menu (see "AUDIO SETTING" on page 21).

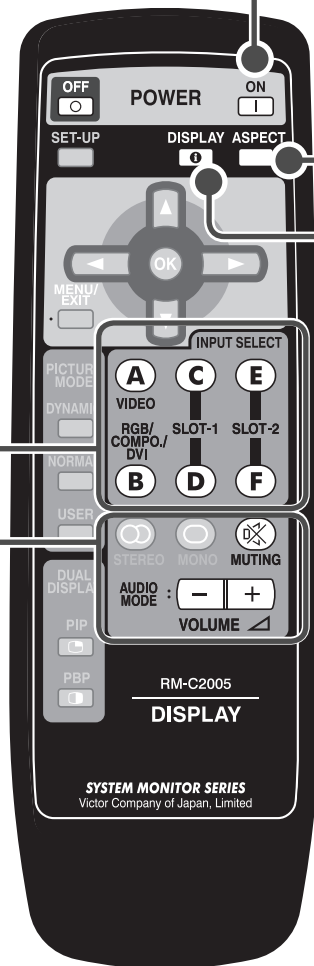

- When the Control Lock is set to "ON" (see page 27), you cannot use the buttons on the main unit.
- When the Power-on Lock is in set to "ON" (see page 30), you need to enter the password when turning on the monitor.

**ASPECT**

## Changing the aspect ratio

Each time you press the button, the aspect ratio changes as follows:

**REGULAR**

Displays at conventional 4:3 aspect ratio.

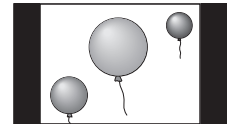
**FULL**

Enlarges the picture of 4:3 aspect ratio horizontally.

- For the picture of 16:9 aspect ratio, the aspect ratio is not changed.

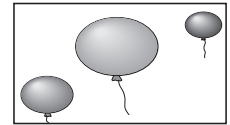
**ZOOM**

Enlarges the picture of 4:3 aspect ratio vertically and horizontally at the same ratio.

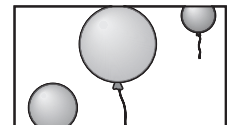
**PANORAMIC**

Enlarges the picture of 4:3 aspect ratio horizontally to the extent that the picture does not look abnormal.

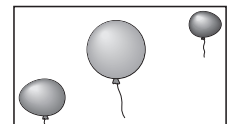
**<PC input ONLY>****REAL DOT**

Displays center portion of the original picture input from the computer (SXGA or UXGA signals) without changing the number of pixels. (Some of the picture will be cut off.)

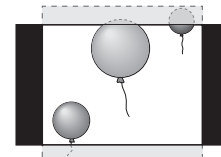

Ex. For SXGA signals

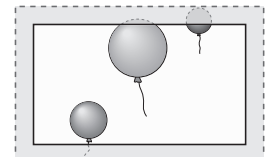

Ex. For UXGA signals

**NOTE**

- For some signals, the aspect ratio cannot be changed or some modes cannot be selected.
- When using the buttons on the main unit for changing the aspect ratio, use the main menu (see "SIZE SETTING" on page 19).

**DISPLAY**

## Displaying the current status

The information of the current input is displayed on the screen.

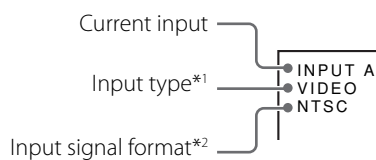

\*<sup>1</sup> When Input C, D, E, or F is selected with an optional input card inserted, the type of the card appears. When no card is inserted, "NO CARD" appears.

\*<sup>2</sup> When no signal is being input, "NO SYNC" appears. When a signal this monitor does not support is being input, "Out of range" appears.

**NOTE**

- When "STATUS DISPLAY" on the main menu is set to "ON" (see page 23), the status is also displayed in the following cases:
  - When you turn on the monitor,
  - When you change inputs, or
  - When you change signal types.

# Daily Operations (cont.)

## Selecting the picture mode

- DYNAMIC:** Suitable for displaying documents for presentation.
- NORMAL:** Displays the original picture.
- USER:** You can adjust picture quality as you like (see "PICTURE SETTING" on page 19).

### NOTE

- You can adjust the picture quality, such as brightness, for each picture mode. The setting you have made is stored (see "PICTURE SETTING" on page 19).

PICTURE MODE

DYNAMIC

NORMAL

USER

## Selecting the audio mode

To listen to stereo sounds



To listen to monaural sounds

- The stereo sounds are mixed to monaural sound.



## Viewing Inputs A and B (analog RGB input) at the same time—Dual Display

You can view Inputs A and B (analog RGB input) at the same time.

- This monitor supports 2 dual display modes.

PIP mode

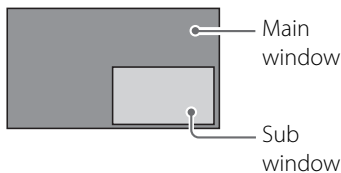

PBP mode

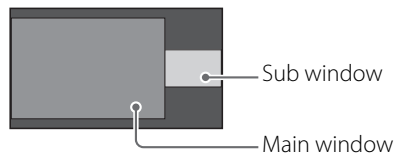

- Each time you press the button, the corresponding dual display mode turns on or off.
- When the dual display mode is activated, the current input is displayed on the main window, and the other is displayed on the sub window.

### NOTE

- The dual display mode is available only when analog RGB signals are being input to Input B. For details, see page 23.
- You cannot change the input when the dual display mode is in use. To change the inputs for the main and sub windows, deactivate the dual display mode, change the input, and then activate the dual display mode.
- Use the main menu to adjust position and/or size of the sub window (see "DUAL DISPLAY" on page 23).

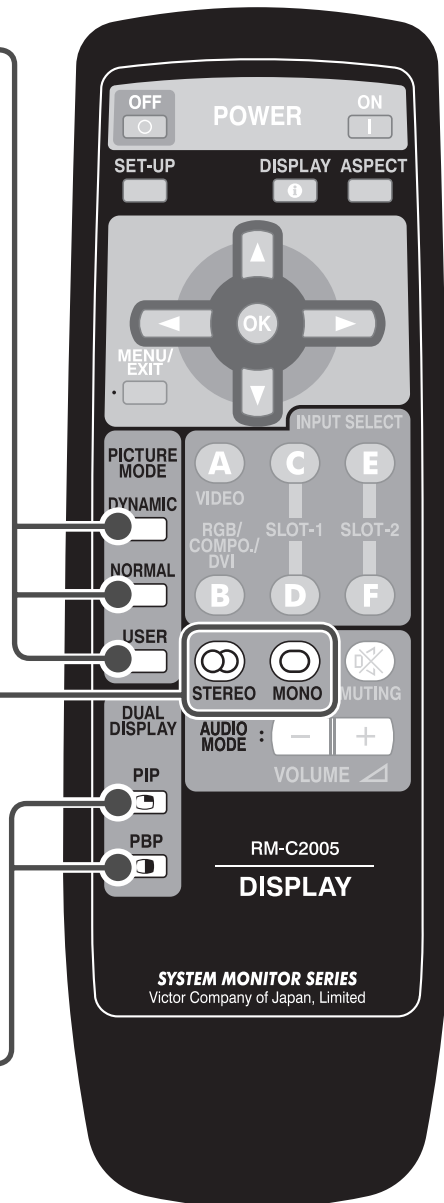

### NOTE

- When using the buttons on the main unit for operations described on this page, use the main menu (see pages 19, 21, or 23).



# Menu Operations

On the main menu and set-up menu, you can make various adjustments, such as picture quality, or initial settings of the monitor.

- For the configuration of the main menu and a detailed description of each item, see pages 18 to 23.
- For the configuration of the set-up menu and a detailed description of each item, see pages 24 to 30.

## From the remote control

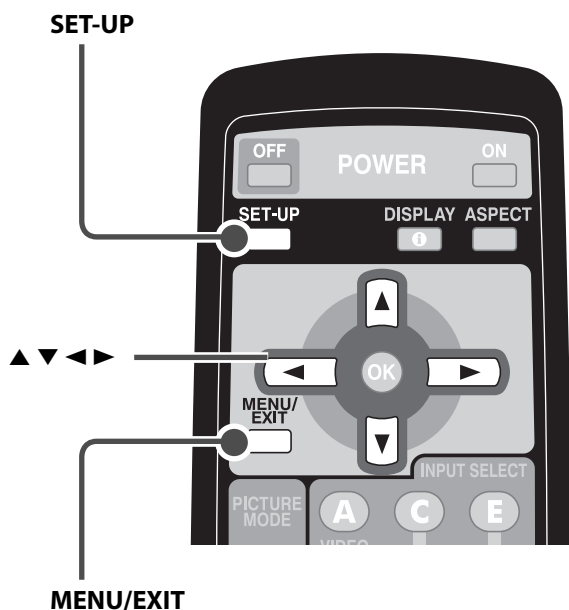

## On the main unit

### MENU

Works in the same way as MENU/EXIT on the remote control.

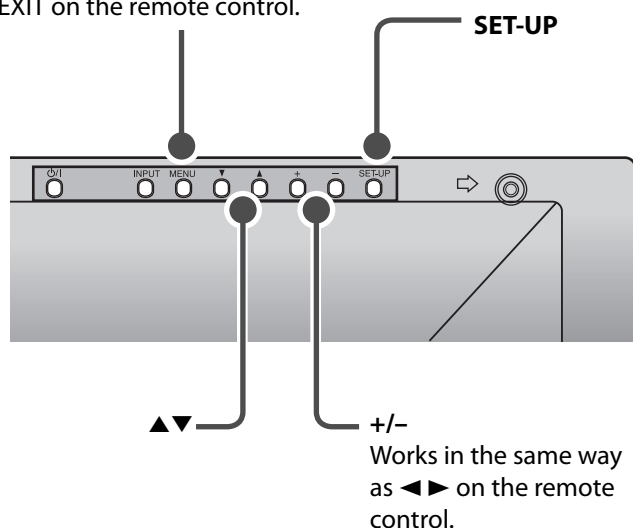

### 1 Display the menu.

**MENU/EXIT** To display the main menu

**SET-UP** To display the set-up menu

### 2 Press ▲ ▼ to select an item, then press ►.

Ex.: When the main menu is displayed

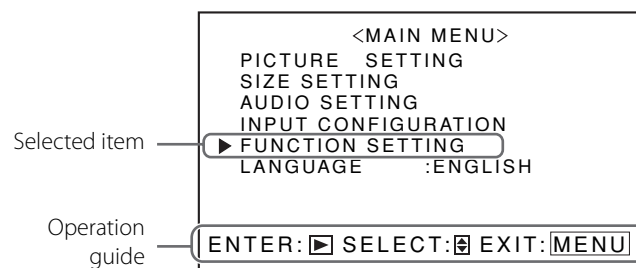

### 3 Press ▲ ▼ to select an item, then press ◀▶ to make adjustments.

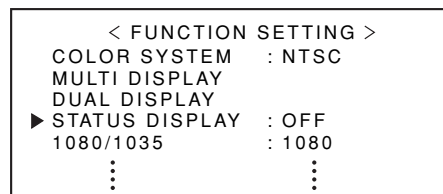

### 4 Press MENU/EXIT to return to the previous menu.

- Pressing the button again exits the menu operation.

#### NOTE

- For some items, adjustments will be made by pressing ◀▶ in step 2.

# Menu Configuration—MAIN MENU

On the main menu, you can make various adjustments and settings for picture, screen, and audio.

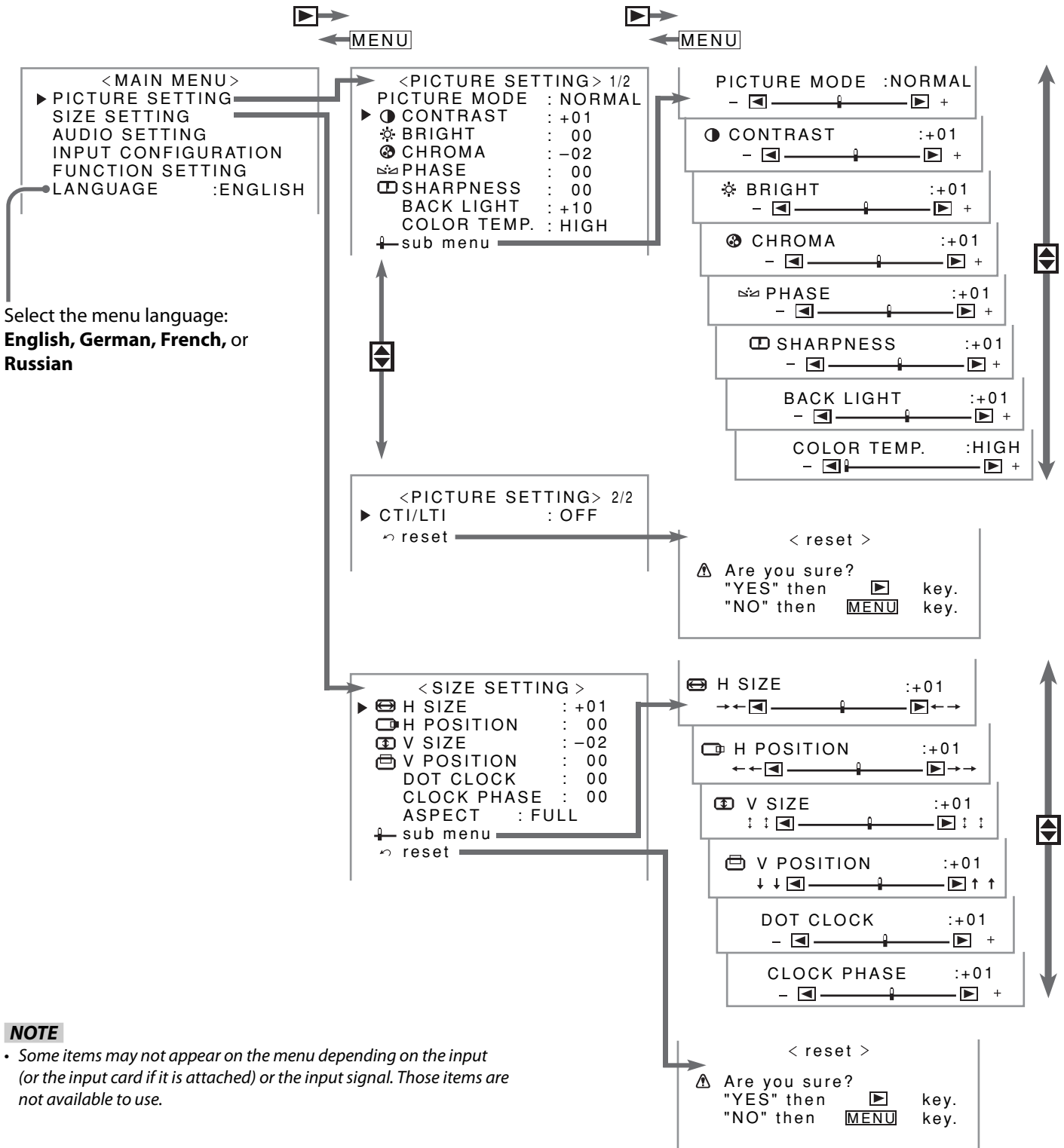

## Configuration of the main menu screen

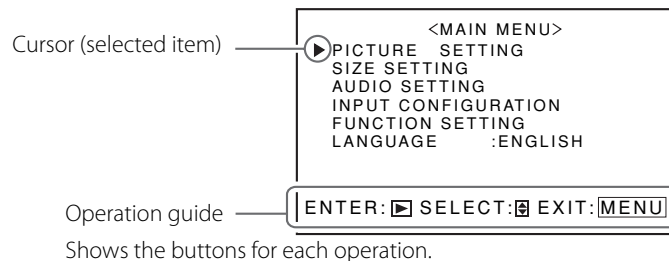

## PICTURE SETTING

Item	To do	Setting value
<b>PICTURE MODE</b>	Selects a picture mode you want (see "Selecting the picture mode" on page 16).	DYNAMIC, NORMAL, USER
<b>CONTRAST</b>	Adjusts contrast of the picture.	-20 ↔ 00 ↔ +20
<b>BRIGHT</b>	Adjusts the brightness of the picture.	-20 ↔ 00 ↔ +20
<b>CHROMA</b>	Adjusts the color density of the picture (except for RGB and BW (50 Hz/60 Hz) signals).	-20 ↔ 00 ↔ +20
<b>PHASE</b>	Adjusts the color phase.	-20 ↔ 00 ↔ +20
<b>SHARPNESS</b>	Adjusts the outlines of the picture.	-20 ↔ 00 ↔ +20
<b>BACK LIGHT</b>	Adjusts the brightness of the display.	-20 ↔ 00 ↔ +20
<b>COLOR TEMP.</b>	Selects the color temperature.	HIGH, MID, LOW, USER
<b>sub menu</b>	Displays the adjustment bar which enables you to adjust the items in "PICTURE SETTING" (except for "CTI/LTI") while viewing the actual picture.	
<b>CTI/LTI</b>	Adjusts the clearness of the picture.	OFF, 1, 2
<b>reset</b>	Restores the default setting for all the items in "PICTURE SETTING."	

### NOTE

- You can adjust the items in "PICTURE SETTING" for each picture mode. Select a picture mode you want to adjust first. (The setting values are stored.)
- "PHASE" does not appear on the menu for the following input signals:
  - RGB, PAL, SECAM, BW (50 Hz/60 Hz)
- You can make the detailed settings of the color temperature using the set-up menu (see "COLOR TEMP." on page 25).

## SIZE SETTING

Item	To do	Setting value
<b>H SIZE</b>	Adjusts the horizontal screen size.	Varies depending on other settings.
<b>H POSITION</b>	Adjusts the horizontal screen position.	
<b>V SIZE</b>	Adjusts the vertical screen size.	
<b>V POSITION</b>	Adjusts the vertical screen position.	
<b>DOT CLOCK</b>	Adjusts to eliminate stripes or flickering when analog signals are being input from a computer. Use with "CLOCK PHASE." Normally, no adjustment is needed.	-10 ↔ 00 ↔ +10
<b>CLOCK PHASE</b>	Adjusts to eliminate stripes or flickering when analog signals are being input from a computer. Use with "DOT CLOCK." Normally, no adjustment is needed.	-32 ↔ 00 ↔ +32
<b>ASPECT</b>	Selects the aspect ratio (see "Changing the aspect ratio" on page 15).	REGULAR, FULL, ZOOM, PANORAMIC, REAL DOT
<b>sub menu</b>	Displays the adjustment bar which enables you to adjust H SIZE/POSITION, V SIZE/POSITION, DOT CLOCK, and CLOCK PHASE while viewing the actual picture.	
<b>reset</b>	Restores the default setting for all the items in "SIZE SETTING."	

### NOTE

- During the size and position adjustments, the picture may be distorted but this is not a malfunction.
- Size and position adjustments are related so that if one is set to a higher setting value, the other's setting value will be reduced.

# Menu Configuration—MAIN MENU (cont.)

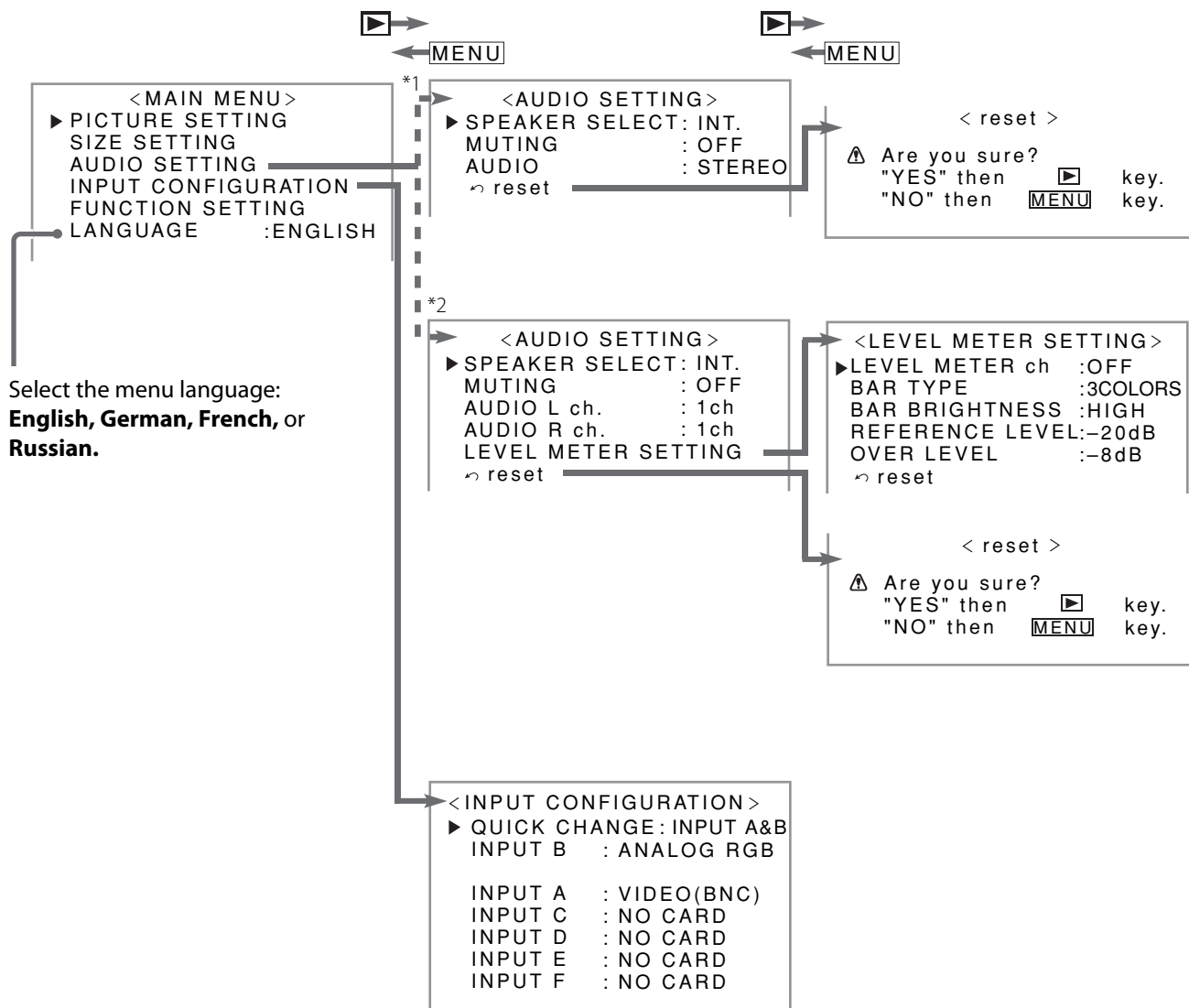

\*1 When no HD/SD SDI or SDI input card (option) is inserted.

\*2 When an HD/SD SDI or SDI input card (option) is inserted.

## Configuration of the main menu screen

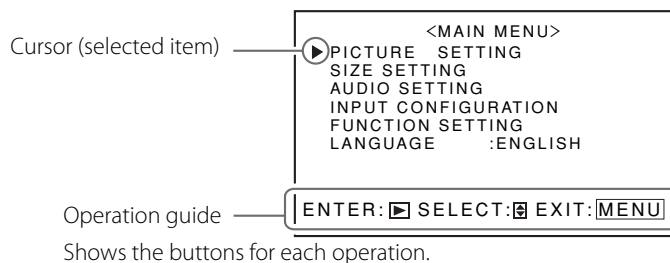

## AUDIO SETTING

Item	To do	Setting value
<b>SPEAKER SELECT</b>	Selects the speakers you want to use.	INT. (Internal speakers), EXT. (External speakers)
<b>MUTING</b>	Turns the volume on or off.	ON, OFF
<b>AUDIO</b>	Changes the audio mode.	STEREO, MONO
<b>AUDIO L ch.</b>	Selects the left audio channel when the EMBEDDED AUDIO signal is being input.	1ch ↔ 8ch
<b>AUDIO R ch.</b>	Selects the right audio channel when the EMBEDDED AUDIO signal is being input.	1ch ↔ 8ch
<b>LEVEL METER SETTING</b>	Adjusts the audio level meter display for the EMBEDDED AUDIO signal when the HD/SD SDI or SDI input card (option) is inserted (see "Example of the level meter display" below).	
LEVEL METER ch	Selects the audio channels used in the audio level meter display. (The numbers indicate the audio channel. The input level for the channels indicated on the left side of ":" is displayed on the left side of the screen, and the input level for the channels indicated on the right side of ":" is displayed on the right side of the screen.)	OFF, 1:2, 12:34, 31:24, 123:456, 1-8
BAR TYPE	Selects the color of the audio level meter display.	3COLORS (3 colors to indicate variations in input levels), W.100 (white), W.50 (half transparent)
BAR BRIGHTNESS	Selects the brightness of the audio level meter display.	HIGH, LOW
REFERENCE LEVEL	Sets the standard input level.	-20dB, -18dB
OVER LEVEL	Sets the input level's lower limit indicated in red for the "3COLORS" display.	-10dB, -8dB, -6dB, -4dB, -2dB
reset	Restores the default setting for "LEVEL METER SETTING."	
<b>reset</b>	Restores the default setting for all the items in "AUDIO SETTING."	

## INPUT CONFIGURATION

Item	To do	Setting value
<b>QUICK CHANGE</b>	Sets if you want to change Inputs A and B quickly.	OFF, INPUT A&B
<b>INPUT B</b>	Selects the terminal and signal type you want to use for Input B.	ANALOG RGB, DVI, COMPONENT
<b>INPUT A</b>	Displays the terminal being used for Input A ("VIDEO (BNC)" or "VIDEO (Y/C)").	—
<b>INPUT C/D/E/F</b>	Shows the status of the input card slots. When no input card is inserted, "NO CARD" appears.	—

### Example of the level meter display—Level indication and audio channels

Ex.: When "LEVEL METER ch" is set to "1-8" and "BAR TYPE" is set to "3COLORS."

#### NOTE

- When "BAR TYPE" is set to "W.100" or "W.50," the standard input level set in the "REFERENCE LEVEL" is displayed with the line indication. Input level set in "OVER LEVEL" is not displayed.
- The audio channel bar with no signal input is displayed in white for the "3COLORS" setting, and in gray for other settings.

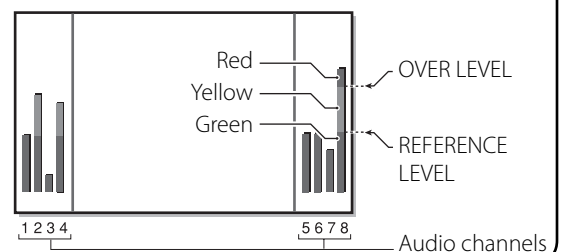

# Menu Configuration—MAIN MENU (cont.)

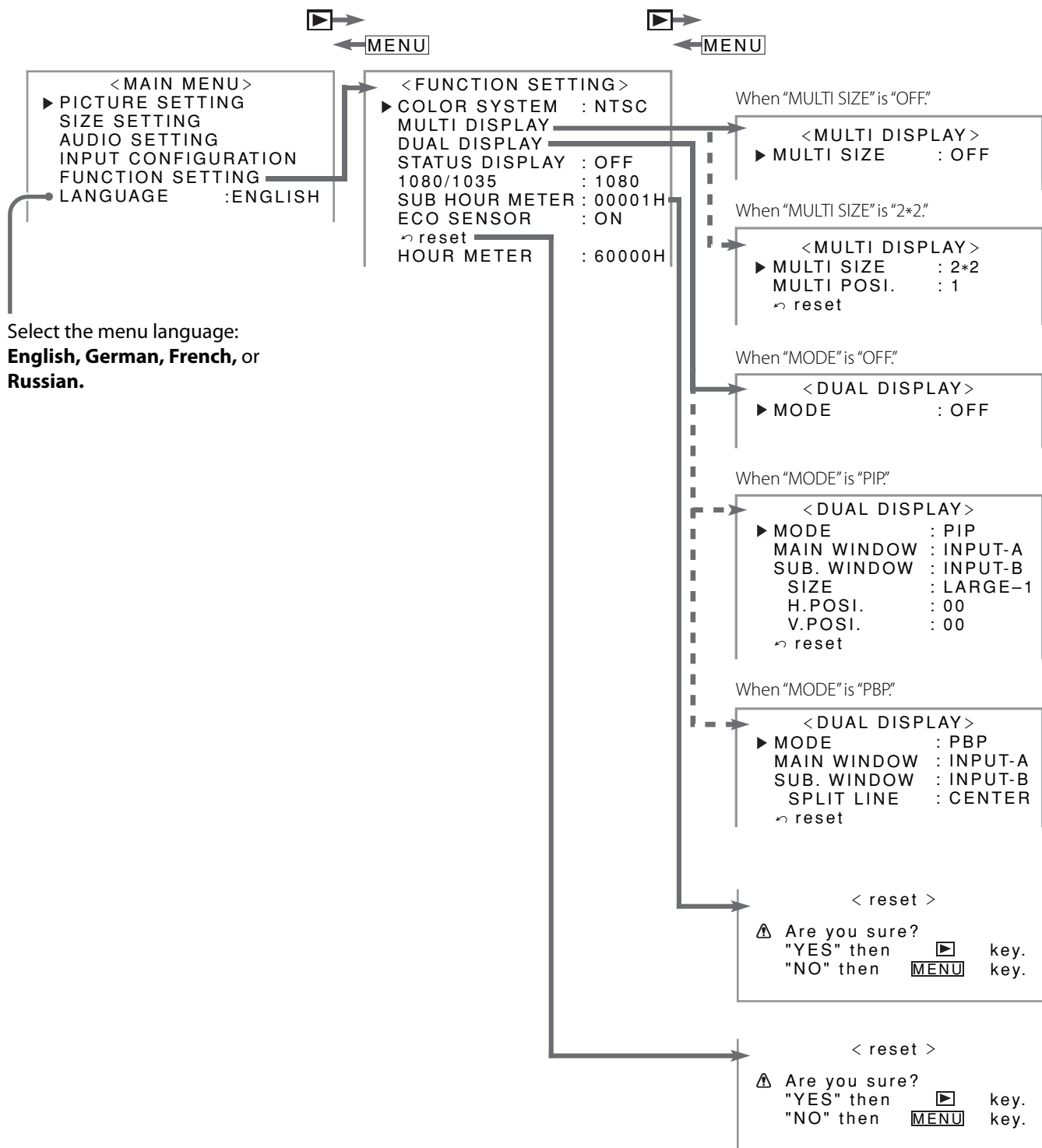

## Configuration of the main menu screen

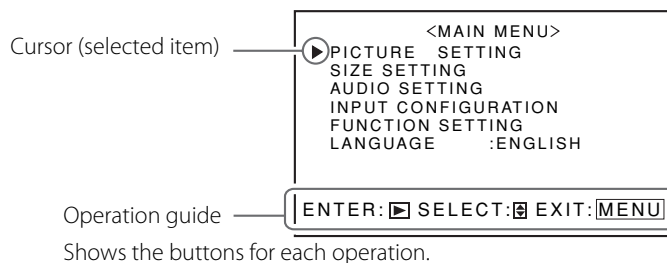

## FUNCTION SETTING

Item	To do	Setting value
<b>COLOR SYSTEM</b>	Selects the color system. When you cannot view pictures correctly with "AUTO," select an appropriate option according to the current input.	AUTO, NTSC, PAL, SECAM, N4.43, PAL M, PAL N, PAL60
<b>MULTI DISPLAY</b>	Sets the multiple monitor usage (see "Example of the multiple monitor setting" below).	
MULTI SIZE	Activates/deactivates the multiple monitor usage (2 monitors horizontally * 2 monitors vertically).	OFF, 2*2
MULTI POSI.	Sets the position of this monitor when "MULTI SIZE" is set to "2*2."	1 ↔ 4
reset	Restores the default setting for "MULTI DISPLAY."	
<b>DUAL DISPLAY</b>	Sets the dual display mode (see "Viewing Inputs A and B (analog RGB input) at the same time—Dual Display" on page 16).	
MODE	Selects the dual display mode.	OFF, PIP, PBP
MAIN WINDOW	Displays the input for the main window ("INPUT-A" or "INPUT-B").	—
SUB. WINDOW	Displays the input for the sub window ("INPUT-A" or "INPUT-B").	—
SIZE	Adjusts the size of the sub window (only for PIP mode).	SMALL-2, SMALL-1, LARGE-1, LARGE-2
H.POSI./V.POSI.	Adjusts the horizontal and vertical position of the sub window (only for PIP mode).	-20 ↔ 00 ↔ +20
SPLIT LINE	Adjusts the position of the border between the main window and sub window (only for PBP mode).	RIGHT-2, RIGHT-1, CENTER, LEFT-1, LEFT-2
reset	Restores the default setting for "DUAL DISPLAY."	
<b>STATUS DISPLAY</b>	Sets if you want the information of the current input to be displayed on the screen (see "Displaying the current status" on page 15).	OFF, ON
<b>1080/1035</b>	Selects a High-Definition signal type (1080/60i or 1035/60i) for the component signal to view the picture correctly.	1080, 1035
<b>SUB HOUR METER</b>	Displays the hours of current use (unit: hour). You can reset only this item.	
<b>ECO SENSOR</b>	Sets the eco sensor which enables you to adjust the brightness of the screen automatically according to the brightness of the room.	ON, OFF
reset	Restores the default setting for the items in "FUNCTION SETTING" except for "MULTI DISPLAY," "DUAL DISPLAY," and "HOUR METER."	
<b>HOUR METER</b>	Displays the total hours of use (unit: hour). This item is used for maintenance of the monitor. This item cannot be reset.	

### NOTE

- The dual display mode is available only when "MULTI SIZE" is set to "OFF."
- "MULTI DISPLAY" is not displayed on the menu when the dual display mode is in use.

### Available signals for the dual display mode

The dual display mode can be activated only when one of the following signals is being input to Input A and B.

- Input A: NTSC, PAL, SECAM, PAL-M, PAL-N, PAL60, NTSC4.43, BW (50 Hz/60 Hz)
- Input B (only analog RGB): VGA480-60, WVGA-60, XGA-60, WXGA-60

### Example of the multiple monitor setting

Ex.: When "MULTI SIZE" is set to "2\*2" and "MULTI POSI." is set to "2."

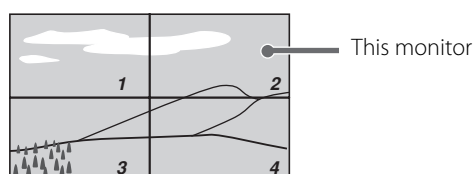

# Menu Configuration—SET-UP MENU

On the set-up menu, you can change various settings such as color temperature and timer.

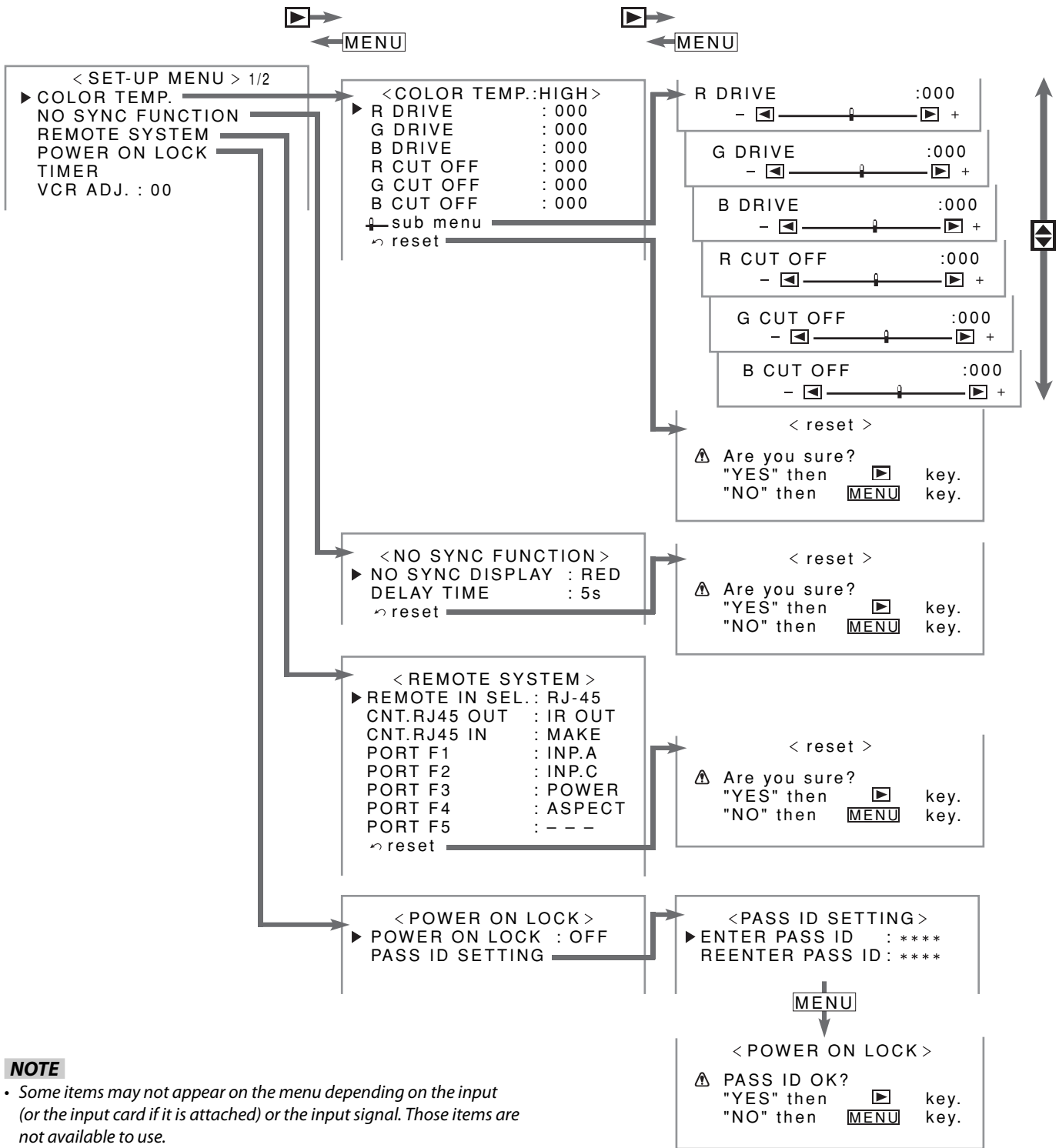

**NOTE**

- Some items may not appear on the menu depending on the input (or the input card if it is attached) or the input signal. Those items are not available to use.

## Configuration of the set-up menu screen

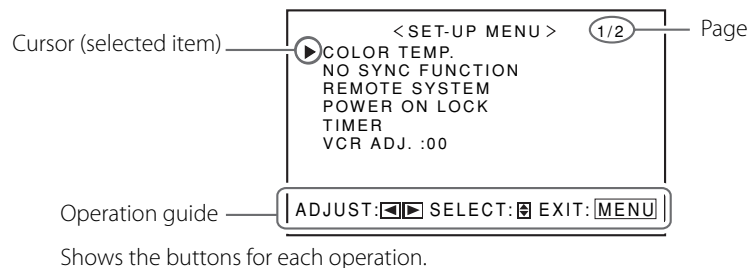



## COLOR TEMP.

Item	To do	Setting value
R DRIVE, G DRIVE, B DRIVE	Adjusts the drive level of each color (red, green, and blue).	MIN ←→ 000 ←→ MAX (in 512 grades)
R CUT OFF, G CUT OFF, B CUT OFF	Adjusts the cut-off point of each color (red, green, and blue).	MIN ←→ 000 ←→ MAX (in 512 grades)
sub menu	Displays the adjustment bar which enables you to adjust the drive level and cut-off point while viewing the actual picture.	
reset	Restores the default setting for all the items in "COLOR TEMP."	

### NOTE

- Adjust the color temperature after selecting color temperature (HIGH, MID., LOW, or USER) on the main menu (see "PICTURE SETTING" on page 19).

## NO SYNC FUNCTION

Item	To do	Setting value
NO SYNC DISPLAY	Selects the screen color (or sleep mode) when no signal is being input.	OFF, SLEEP (sleep mode), RED, GREEN, BLUE, GRAY
DELAY TIME	Sets the time to change the screen color (or sleep mode) set in "NO SYNC DISPLAY" above after signals stops being input.	5s, 1min., 30min.
reset	Restores the default setting for all the items in "NO SYNC FUNCTION."	

## REMOTE SYSTEM

Item	To do	Setting value
REMOTE IN SEL.	Selects the input terminal used for external control.	D-sub9, RJ-45
CNT. RJ45 OUT	Selects the external control method for RS-485 OUT terminal.	RS485, IR OUT
CNT. RJ45 IN	Selects the external control method for RS-485 IN terminal.	RS485, MAKE, TRIG., SET
PORT F1 – PORT F5	Assigns the control function to the RS-485 IN terminal's pins (1 to 5) when selecting "SET" in "CNT. RJ45 IN" above.	INP. A – INP. F, POWER, ASPECT, MUTING, PIP, PBP, – – – (no function)
reset	Restores the default setting for all the items in "REMOTE SYSTEM."	

### NOTE

- For details about external control, see pages 31 to 33.

## POWER ON LOCK

Item	To do	Setting value
POWER ON LOCK	Activates/deactivates the Power-on Lock. When this function is activated, the monitor cannot be turned on without entering the password set in "PASS ID SETTING" below.	ON, OFF
PASS ID SETTING	Sets the password for the Power-on Lock.	4 characters

### NOTE

- For details about the Power-on Lock, see page 30.

# Menu Configuration—SET-UP MENU (cont.)

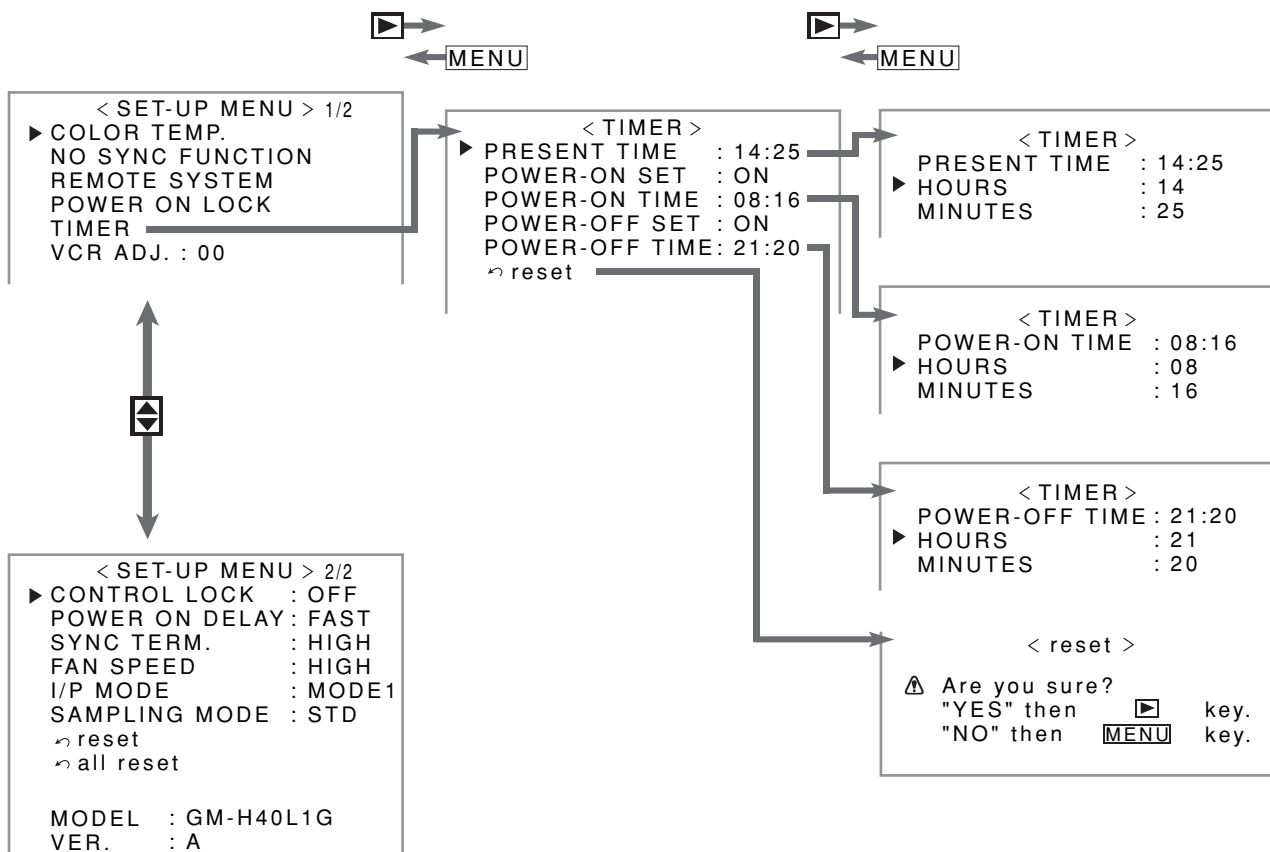

## Configuration of the set-up menu screen

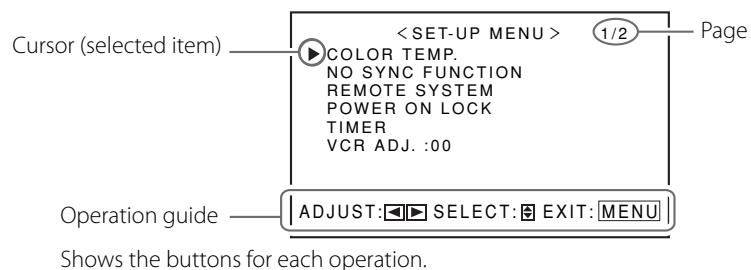

## TIMER

Item	To do	Setting value
<b>PRESENT TIME</b>	Sets the clock.	
HOURS	Sets the hour.	00 ↔ 23
MINUTES	Sets the minute.	00 ↔ 59
<b>POWER-ON SET</b>	Activates/deactivates the power-on timer.	ON, OFF
<b>POWER-ON TIME</b>	Sets the time to turn on the monitor.	
HOURS	Sets the hour.	00 ↔ 23
MINUTES	Sets the minute.	00 ↔ 59
<b>POWER-OFF SET</b>	Activates/deactivates the power-off timer.	ON, OFF
<b>POWER-OFF TIME</b>	Sets the time to turn off the monitor.	
HOURS	Sets the hour.	00 ↔ 23
MINUTES	Sets the minute.	00 ↔ 59
<b>reset</b>	Restores the default setting for all the items in "TIMER."	

## VCR ADJ.

Adjusts when the picture played back on a VCR is distorted. (Depending on the condition of the connected VCR or the playback tape, the picture quality may not be improved.)

**Setting value:** -05 ↔ 00 ↔ +05

## CONTROL LOCK

Activates/deactivates the Control Lock. When this function is activated, you cannot operate the monitor with the buttons on the main unit.

**Setting value:** ON, OFF

### NOTE

- You can use the remote control and external control while the control lock is set. To release the lock, use the remote control.

## POWER ON DELAY

Sets the time when the power supply to the monitor's circuits (excluding the micro computers) starts after the power button is pressed.

**Setting value:** OFF, FAST, SLOW

### NOTE

- If you are going to turn several monitors on at the same time, it is recommended to apply "SLOW" to some of the monitors to control rush current.

## SYNC TERM.

Sets the resistance of Horizontal sync/Composite sync signal and Vertical sync signal when the component/RGB input card (option) is inserted. Normally, select "HIGH" (1 k $\Omega$ ). If you see pictures flickering or blurring on the screen because of a long connecting cord, set this to "LOW" (75  $\Omega$ ).

**Setting value:** HIGH, LOW

### NOTE

- When a video input card (option) is inserted, "SYNC SELECT" appears. Set the sync signal to use—INT. (sync signal included in the video signal) or EXT. (external sync signal).

# Menu Configuration—SET-UP MENU (cont.)

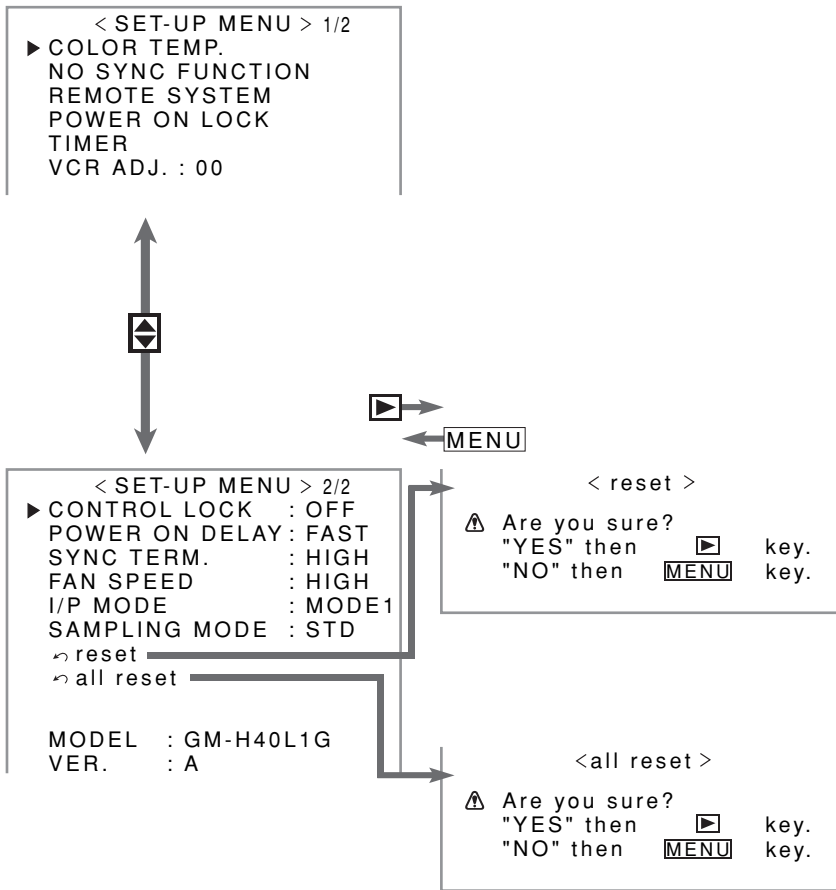

## Configuration of the set-up menu screen

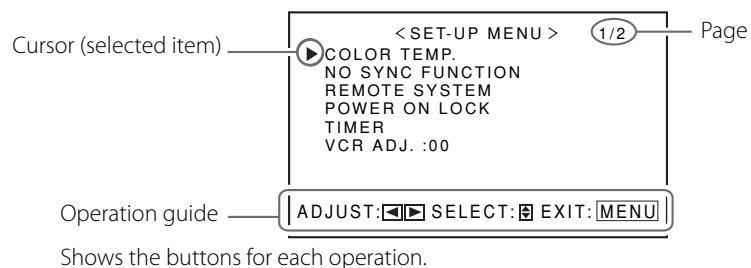

## **FAN SPEED**

Sets the speed of the internal cooling fan. When installing the monitor vertically, select "HIGH."

**Setting value:** HIGH, LOW

## **I/P MODE**

Select a mode with which you can view the least noise on the screen.

**Setting value:** MODE1, MODE2, MODE3

## **SAMPLING MODE**

Sets the sampling mode for the signals input from the computer to reduce noise and display thin vertical lines of the picture more clearly. Select "STD" for VGA480-60 or XGA-60, and "WIDE" for WVGA-60 or WXGA-60. (This item is not displayed for other signals.)

**Setting value:** STD, WIDE

## **reset**

Restores the default setting for all the items in the set-up menu.

## **all reset**

Restores the default setting for all the items in the main menu and set-up menu except the use time ("HOUR METER"). The power is turned off, then turned on again automatically.

## **MODEL, VER.**

Displays the model name and version of the monitor. This item is used for maintenance of the monitor.

## Setting the Power-on Lock

When the Power-on Lock is set to "ON," you need to enter the password when turning on the monitor. Without entering the correct password, you cannot perform any operation except for entering the password and turning off the monitor.

### ■ To set the password

Enter a password of 4 characters.

**Available characters:** 0 – 9, A – Z, a – z

#### Remote control ONLY

**1 Select "PASS ID SETTING" on the POWER ON LOCK sub menu of the set-up menu.**

**2 Enter a password.**

See "How to enter a password" below.

**3 Press OK.**

The cursor moves to the second line.

**4 Enter the password again for confirmation, then press OK.**

- If the password is different from the one entered in step 2, "PASS ID NG!" appears and the POWER ON LOCK sub menu is displayed. In this case, repeat from step 1.

### How to enter a password

To enter a password, follow the procedure below.

```
< PASS ID SETTING >
ENTER PASS ID :   0 * * *
REENTER PASS ID : * * * *
```

Ex.: Password setting screen

#### Remote control ONLY

**1 Press ▲▼ to select a character.**

- The digit currently selected flashes, and "\*" is displayed for other digits.

**2 Press ◀▶ to edit the next digit.**

**3 Press OK after entering all digits.**

**DO NOT forget the password!**

*If you forget the password, consult your dealer.*

### ■ To activate the Power-on Lock

**1 Select "POWER ON LOCK (: OFF)" on the POWER ON LOCK sub menu of the set-up menu.**

**2 Press ▶.**

The Power-on Lock is set to "ON."

- When turning on the monitor, the following message appears. Enter the password (see "How to enter a password" on the left).

```
< POWER ON LOCK >
PLEASE ENTER
PASS ID :   * * * *
```

### ■ To deactivate the Power-on Lock

**1 Select "POWER ON LOCK (: ON)" on the POWER ON LOCK sub menu of the set-up menu.**

**2 Press ▶.**

The following message appears.

```
< POWER ON LOCK >
PLEASE ENTER
PASS ID :   * * * *
```

**3 Enter the password.**

See "How to enter a password" on the left.

- If the password is wrong, "PASS ID NG!" appears. Enter the correct password.

# How to Use External Control

## ■ About the external control

This monitor has two external control terminals as follows:

- **RS-232C terminal:** For operation using this terminal, consult your dealer.
- **RS-485 terminals:** You can select the external control system in "REMOTE SYSTEM" on the set-up menu (see "CNT. RJ45 OUT" and "CNT. RJ45 IN" on page 25).
  - (1) **Serial communication:** Controls the monitor by a personal computer or a dedicated controller (see page 32).
  - (2) **IR OUT system:** Controls other equipment by using the remote control supplied with this monitor.
  - (3) **MAKE (make contact system):** Controls the function by short-circuiting the corresponding pin terminal to the GND pin terminal, or disconnecting (opening) it (see page 33).
  - (4) **TRIG. (trigger system):** Controls the function by inputting the pulse signal instantaneously to the corresponding pin terminal (see page 33).

Set the input/output terminals correctly according to the system you use (see "REMOTE SYSTEM" on page 25).

Control system	"REMOTE IN SEL." setting	"CNT. RJ45 OUT" setting	"CNT. RJ45 IN" setting
RS-232C	D-sub9	RS485	Any
Serial communication	RJ-45*	RS485	RS485
	D-sub9*	RS485	Any
IR OUT system	Any	IR OUT	Any
MAKE system	RJ-45	RS485	MAKE
TRIG. system	RJ-45	RS485	TRIG.

\* For the monitor connected to the external control equipment, set "REMOTE IN SEL." according to the actual connection. Set other monitors by following the setting of the serial communication with "REMOTE IN SEL." set to "RJ-45" in the table above.

### NOTE

- Control priority is as follows:  
MAKE or TRIG. (trigger) system > RS-485 system > Buttons on the remote control or the main unit
- While the Control Lock is in use, you can use external control.

### <Serial communication>

Several monitors can be controlled by connecting their RS-485 IN and OUT terminals. See also page 32.

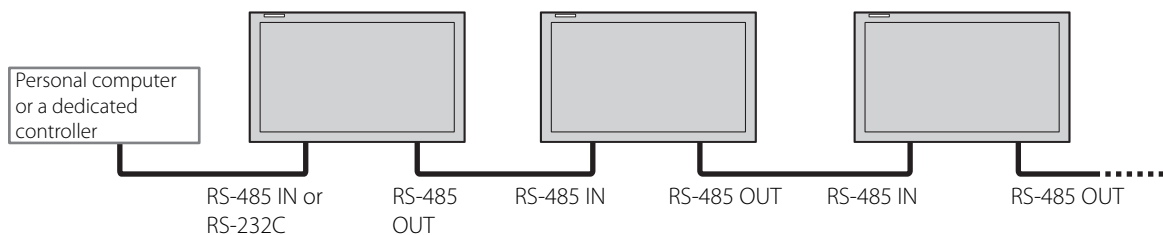

### <IR OUT system>

Control signals from the remote control are sent to external equipment via the RS-485 OUT terminal.

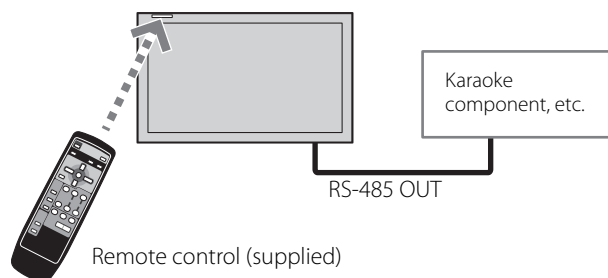

### <MAKE/TRIG. system>

You can control the monitor by a personal computer or a dedicated controller\*. See also page 33.

\* External control unit is not commercially available. Consult your dealer if you need a dedicated controller.

# How to Use External Control (cont.)

## ■ Using the serial communication

You can control the monitor from a personal computer or a dedicated controller via the RS-485 or RS-232C terminal. For details on operating the monitor from the personal computer or the dedicated controller, consult your dealer.

Input terminal	Cable	Specification	Communications specifications
<b>RS-485</b>	Prepare a straight cable with a RJ-45 connector.	See the table below.	Baud Rate: 4800/9600/19200 (factory pre-set; 4800) Data Bits: 8 bits Parity: No parity Stop Bits: 1 bit Communication Cord: ASCII Cord
<b>RS-232C</b>	Prepare a straight cable with a RS-232C connector.		

### <RS-485 terminal>

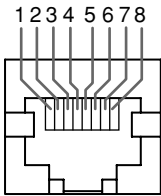

This is a female terminal.

Pin No.	IN terminal signal	OUT terminal signal
1	TXD +	TXD +
2	TXD -	TXD -
3	RXD +	RXD +
4	NC	NC
5	NC	IR. OUT
6	RXD -	RXD -
7	5 V power*	NC
8	GND	GND

\* The 5V power supply of the 7th terminal is for the controller exclusively for this monitor. Do not use it for other devices.

### <RS-232C terminal>

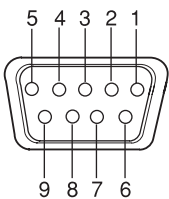

This is a female terminal.

Pin No.	Signal
1	—
2	RD (Receive Data)
3	TD (Transmit Data)
4	—
5	GND (Ground)
6	—
7	—
8	—
9	—



## ■ Using the MAKE/TRIG. system

The RS-485 IN terminal is configured as follows. You can assign the functions to each pin terminal by setting "REMOTE SYSTEM" (see "PORT F1 – PORT F5" on page 25).

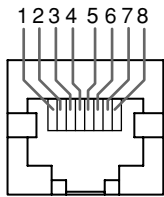

This is a female terminal.

Pin No.	Pin name
1	PORT F1
2	PORT F2
3	PORT F3
4	PORT F4
5	PORT F5
6	ENABLE
7	NC
8	GND

### To assign the functions to the pin terminals

For the operation procedure, see page 17.

1. Select "REMOTE SYSTEM" on the set-up menu.
2. Set "CNT. RJ45 IN" to "SET"
3. Select a pin name ("PORT F1" – "PORT F5") which you want to assign a function, and then select the function you want to assign.
  - For functions which can be assigned, see the table below.

### Functions controlled by MAKE/TRIG. system

Display	Functions to be controlled	Opening	Short-circuiting
INP. A	Changes the input to Input A.	Invalid	Valid
INP. B	Changes the input to Input B.	Invalid	Valid
INP. C	Changes the input to Input C.	Invalid	Valid
INP. D	Changes the input to Input D.	Invalid	Valid
INP. E	Changes the input to Input E.	Invalid	Valid
INP. F	Changes the input to Input F.	Invalid	Valid
POWER	Turns on/off the monitor.	Power on	Power off
ASPECT	Changes the aspect ratio.	REGULAR	FULL
MUTING	Turns off or resumes the volume.	Muting off	Muting on
PIP	Turns on/off the PIP mode (see page 16).	Invalid	Valid
PBP	Turns on/off the PBP mode (see page 16).	Invalid	Valid
---	No function	—	—

#### NOTE

- You cannot assign the same function to different pin terminals.
- The TRIG. (trigger) system switches each function by short-circuiting for approx. 1 second.

### Operation

1. Short-circuit the 6th pin terminal (External control) to the 8th pin terminal (GND) so that the monitor can be controlled by the external control.
2. Set "CNT. RJ45 IN" of "REMOTE SYSTEM" to "MAKE" or "TRIG." on the set-up menu.
3. When selecting "MAKE" (make contact) system:
  - Operate each function by short-circuiting the corresponding pin terminal to the 8th pin terminal (GND) or opening it.

#### When selecting "TRIG." (trigger) system:

Operate each function by Pulse control, that is short-circuiting the corresponding pin terminal to the 8th pin terminal (GND) for about 1 second.

#### NOTE

- When controlling INP. A/B/C/D/E/F, only one terminal must be short-circuited. (Other terminals must be opened.)
- When switching PIP and PBP modes, open the mode which has been shortcircuited before shortcircuiting the mode you want to make valid.
- When selecting the "TRIG." (trigger) system, you can operate only one function at a time. Operate the functions one by one.

# Troubleshooting

Solutions to common problems related to the monitor are described here. If none of the solutions presented here solves the problem, unplug the monitor and consult an authorized dealer or service center.

## Self-diagnostic lamp lights (flashes).

⇒ See page 36 for details.



## Power is not supplied.

- ⇒ Is the power cord connected (see page 13)?
- ⇒ Is the main power switch (POWER) turned on (see page 14)?

## No picture.

- ⇒ Is the correct input selected (see page 14)?
- ⇒ Are the devices connected correctly (see pages 12 and 13)?
- ⇒ Are signals being input from the connected devices?
- ⇒ Is brightness adjusted correctly (see page 19)?

## No sound.

- ⇒ Is the volume set at minimum (see page 14)?
- ⇒ Is the muting function activated (see page 14)?

## The remote control does not work.

- ⇒ Are the batteries installed correctly (see page 8)?
- ⇒ Are the batteries exhausted?
- ⇒ Is the front end of the remote control pointing toward the remote sensor?
- ⇒ Is there any object blocking the path between the remote control and the remote sensor?
- ⇒ Is the monitor too far away from you?

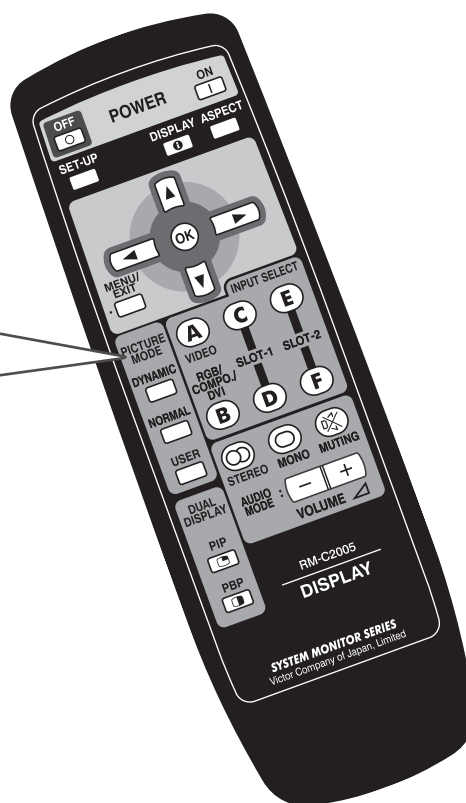

Symptom	Probable cause and corrective action	Page
<b>Power is suddenly turned on or off.</b>	The power-on/off timer is activated. Deactivate the timer.	27
<b>The picture becomes blurred.</b>	<ul style="list-style-type: none"> <li>For RGB input, adjust "DOT CLOCK" and "CLOCK PHASE" on the main menu.</li> <li>If the connection cable used for RGB terminal is long, set "SYNC TERM." to "LOW."</li> </ul>	19 • 27
<b>Color is abnormally bright or dark.</b>	<ul style="list-style-type: none"> <li>Adjust the picture quality on "PICTURE SETTING" of the main menu.</li> <li>If "TEMP. OVER" is displayed, follow the procedure described on page 36.</li> </ul>	19 • 36
<b>Color is poor or unstable.</b>	Select the correct color system.	23
<b>The picture is cut or shifted toward one side.</b>	<ul style="list-style-type: none"> <li>Input signals (scanning frequency, etc.) are not appropriate.</li> <li>Adjust the size and position properly.</li> </ul>	11 • 19
<b>Menu does not appear or disappears quickly.</b>	When "INPUT B" of "INPUT CONFIGURATION" is set to "COMPONENT" with a personal computer connected to the RGB/COMPO. terminal, the menu operation is not available. Select another input to operate the menu.	21
<b>Some items are not shown on the menu.</b>	Items not available for the current input signal are not displayed. Change the input or signal format. Some items are displayed only when the corresponding optional input card is inserted.	—
<b>"PLEASE ENTER PASS ID" appears when trying to turn on the monitor.</b>	The Power-on Lock is activated. Enter the password to turn on the monitor, and then deactivate the Power-on Lock.	25, 30
<b>Buttons on the main unit do not work.</b>	The Control Lock is activated. Deactivate it.	27

## Pixel defects

LCDs use collections of fine points ("pixels") to display images. While there is no problem with more than 99.99% of these pixels, please understand that a very small number of pixels may not light, or may light all the time.

## Self-diagnostic indication

When something abnormal occurs with the monitor, this function informs you of the condition of the monitor with the self-diagnostic lamps, allowing for smooth service work.

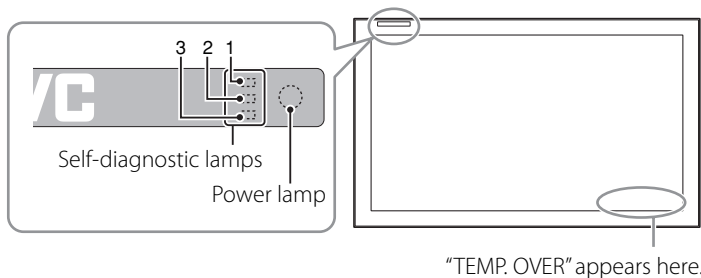

### If the monitor screen turns off and the self-diagnostic lamps light or flash

If the self-diagnostic lamps light or flash in red, check the following before consulting the dealer where you purchased the monitor.

- If the self-diagnostic lamp 1 (upper) flashes, lamp 2 (middle) lights, and lamp 3 (lower) flashes

This may be caused by the dusty intakes on the rear. If this happens, switch off the main power using the POWER switch (set to "O (off)"), unplug the AC power cord, then clean the intakes by referring to the instruction on page 4.

After cleaning, switch on the monitor's main power again. If the self-diagnostic lamps do not go off, consult your dealer immediately.

### If the monitor screen dims a little and "TEMP. OVER" appears (or flashes)

If "TEMP. OVER" appears or flashes at the right bottom of the screen, check the following before consulting the dealer where you purchased the monitor.

"TEMP. OVER" appears to warn you of internal heat buildup, which is usually caused by accumulated dust around the intakes or by improper installation. If the cause of the internal heat buildup is eliminated, this indication disappears and the screen returns to normal brightness.

- If "TEMP. OVER" flashes in yellow

This may be caused by the dusty intakes on the rear. If this happens, switch off the main power using the POWER switch (set to "O (off)"), unplug the AC power cord, then clean the intakes by referring to the instruction on page 4.

– After cleaning, switch on the monitor's main power again. If "TEMP. OVER" still flashes, this problem may be caused by improper installation or improper location of the monitor. In this case, consult your dealer immediately to solve this improper installation and to improve the circumstances around the monitor.

- If "TEMP. OVER" appears in red

"TEMP. OVER" will be shown for about two minutes, the monitor will shut off automatically, then the self-diagnostic lamps light in red. If this happens, switch off the main power using the POWER switch (set to "O (off)"), unplug the AC power cord, then consult your dealer immediately.

If the trouble still persists, follow the procedure below:

#### 1 Check which lamps are lit or flashing.

On the Self-diagnostic Report Sheet (below), check the box next to "Lights" or "Flashes" of the corresponding lamp or lamps.

- Only one lamp may light or flash, or all three lamps may do so.

#### 2 Switch off the POWER switch on the back of the monitor.

#### 3 Unplug the power cord.

#### 4 Call your dealer and tell them which lamps are lit or flashing. (Copy and fax the Self-diagnostic Report Sheet below.)

#### NOTE

- If you switch on the main power immediately after switching it off (or after recovering from a brief power interruption), the self-diagnostic lamps may light (or flash), and no image may appear on the screen. In this case, switch off the main power again, wait for about 10 seconds, then switch it on again. If no self-diagnostic lamps light or flash, you can operate and use the monitor as usual.

### Self-diagnostic Report Sheet

Store name where you purchased the monitor

To

Model name: LCD DISPLAY MONITOR GM-H40L1G

The self-diagnostic lamps light or flash as listed on the following table. Please give me immediate advice or service if necessary.

Self-diagnostic lamp			
No.	Lamp position	Conditions	
1	Upper	<input type="checkbox"/> Lights	<input type="checkbox"/> Flashes
2	Middle	<input type="checkbox"/> Lights	<input type="checkbox"/> Flashes
3	Lower	<input type="checkbox"/> Lights	<input type="checkbox"/> Flashes
TEMP. OVER		<input type="checkbox"/> Lights	<input type="checkbox"/> Flashes

Your Name	
Telephone No.:	
Address:	

# Specifications

## General

<b>Model name</b>	GM-H40L1G
<b>Frame color</b>	Metallic dark gray
<b>Screen size</b>	Type 40 wide format
<b>Aspect ratio</b>	16:9 (Wide format)
<b>LCD panel</b>	40" wide, active matrix TFT
<b>Effective screen size (W x H, Diagonally)</b>	885 mm x 498 mm (34 <sup>13</sup> / <sub>16</sub> " x 19 <sup>9</sup> / <sub>16</sub> " ), 1 015 mm (39 <sup>15</sup> / <sub>16</sub> " )
<b>Number of pixels displayed</b>	1 366 (H) x 768 (V)
<b>Number of colors displayed</b>	16.77 million (256 colors for each of RGB)
<b>Viewing angle (TYP.)</b>	170° (Horizontally), 170° (Vertically)
<b>Brightness (TYP.)</b>	400 cd/m <sup>2</sup>
<b>Contrast ratio (TYP.)</b>	800:1
<b>Response time</b>	less than 20 msec (Tr + Tf)
<b>Weight</b>	26.8 kg (59.0 lbs)
<b>External dimensions (W x H x D)</b>	986 mm x 595 mm x 123 mm (38 <sup>7</sup> / <sub>8</sub> " x 23 <sup>1</sup> / <sub>2</sub> " x 4 <sup>7</sup> / <sub>8</sub> " )
<b>Power requirements</b>	AC 120 V, 50 Hz/60 Hz
<b>Rated input current</b>	2.4 A
<b>Compatible signals</b>	See page 11.
<b>Audio power output</b>	Internal: 1.7 W + 1.7 W (at impedance 8 Ω) External: 6 Ω – 8 Ω, 2.2 W + 2.2 W (at impedance 6 Ω)
<b>Speaker</b>	Ellipse (40 mm (1 <sup>5</sup> / <sub>8</sub> " ) x 70 mm (2 <sup>7</sup> / <sub>8</sub> " )) x 2, impedance 8 Ω
<b>Operating conditions</b>	Temperature: 0°C – 40°C (32°F – 104°F) Relative humidity: 20% – 80% (non-condensation) (Slightly variable depending on ambient conditions for installation.)

## Input/output terminals

<b>VIDEO IN A</b>	Video input	BNC terminal x 1 Y/C terminal x 1	1 V (p-p), 75 Ω Y: 1 V (p-p), 75 Ω C (BURST): 0.286 V (p-p), 75 Ω (for NTSC) 0.3 V (p-p), 75 Ω (except for NTSC)
	Video output	BNC terminal x 1	1 V (p-p), 75 Ω
<b>VIDEO IN B</b>	RGB/COMPONENT input	D-sub 3-row 15-pin x 1 (RGB is compatible with DDC2B)	
	Video signal		G, Y: 1 V (p-p), 75 Ω (including sync) B, R, Pb/Cb, Pr/Cr: 0.7 V (p-p), 75 Ω
	Horizontal sync (HD)/Composite sync (Cs)		HD: 0.3 V (p-p) to 5 V (p-p), 1 kΩ (positive/negative polarity) Cs: 0.3 V (p-p) to 5 V (p-p), 1 kΩ (positive/negative polarity)
	Vertical sync (VD)		VD: 1 V (p-p) to 5 V (p-p), 1 kΩ (positive/negative polarity)
	DVI input	DVI-D terminal x 1 (Compatible with DDC2B)	
<b>AUDIO IN A</b>	Audio input	Pin jack terminal x 2 (L/R)	500 mV (rms), high impedance
<b>AUDIO IN B</b>	Audio input	Stereo mini jack terminal x 1	500 mV (rms), high impedance
<b>REMOTE</b>	RS-232C input	D-sub 9-pin terminal x 1 (For RS-232C control)	
	RS-485 input	RJ-45 pin terminal x 1 (For RS485, MAKE, and TRIGGER control)	
	RS-485 output	RJ-45 pin terminal x 1 (For RS485 and IR OUT control)	
<b>AUDIO OUT</b>	MONITOR OUT	Pin jack terminal x 2 (L/R)	Output impedance 600 Ω
	EXT. SPEAKER	Speaker output terminal (L/R)	Impedance 6 Ω to 8 Ω

# Specifications (cont.)

## Dimensions

Unit: mm (inch)

Top view

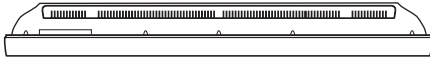

Front view

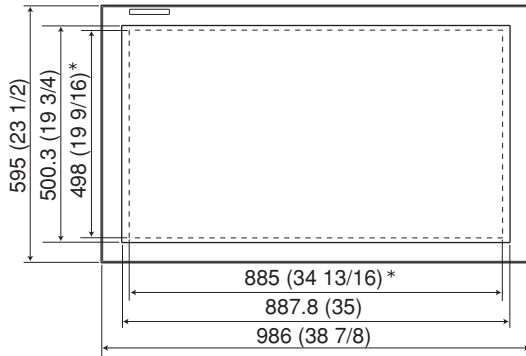

Side view

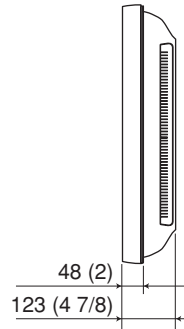

Rear view

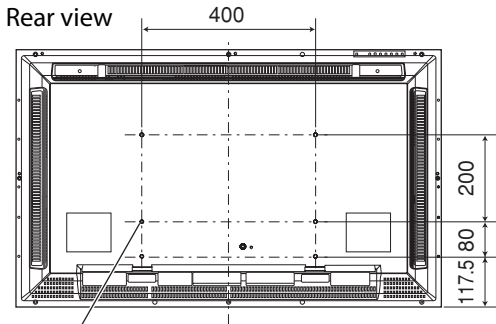

Screw hole for optional installation unit.  
Screw size: 6 – M6, depth: 20 mm

\* Effective screen size

## DVI-D input terminal

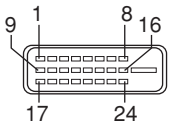

Pin No.	Signal name	Pin No.	Signal name	Pin No.	Signal name
1	T.M.D.S Data 2-	9	T.M.D.S Data 1-	17	T.M.D.S Data 0-
2	T.M.D.S Data 2+	10	T.M.D.S Data 1+	18	T.M.D.S Data 0+
3	T.M.D.S Data 2/4 shield	11	T.M.D.S Data 1/3 shield	19	T.M.D.S Data 0/5 shield
4	NC	12	NC	20	NC
5	NC	13	NC	21	NC
6	DDC Clock	14	+5 V Power	22	T.M.D.S Clock shield
7	DDC Data	15	GND	23	T.M.D.S Clock+
8	NC	16	Hot Plug Detect	24	T.M.D.S Clock-

## RGB/COMPONENT input terminal

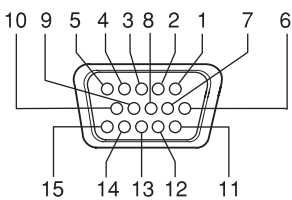

Pin No.	Signal name	Pin No.	Signal name
1	Red	9	+5V
2	Green	10	GND
3	Blue	11	GND
4	N/C	12	DDC Data
5	GND	13	HD/Cs
6	GND	14	VD
7	GND	15	DDC Clock
8	GND	External	GND

## Y/C IN terminal

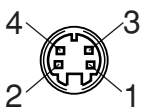

Pin No.	Signal name
1	GND (Y)
2	GND (C)
3	Y
4	C

**Options (not supplied)**

Stand Unit                    TS-CL03SG  
Wall Mounting Unit        TS-CV20WG

- Consult your dealer to see if other options are available.

**Notice on transportation**

This monitor is precision equipment and needs dedicated packing material for transportation. Never use any packing material supplied from sources other than JVC or JVC-authorized dealers.

- For easy understanding, pictures and illustrations are shown by being emphasized, omitted or composed, and may be more or less different from actual products.
- Design and specifications are subject to change without notice.
- IBM and IBM PC are registered trademarks of International Business Machines Corporation. Macintosh is registered trademarks of Apple Computer, Inc.  
All other product names mentioned herein are used for identification purposes only, and may be the trademarks or registered trademarks of their respective companies.





## Free Manuals Download Website

<http://myh66.com>

<http://usermanuals.us>

<http://www.somanuals.com>

<http://www.4manuals.cc>

<http://www.manual-lib.com>

<http://www.404manual.com>

<http://www.luxmanual.com>

<http://aubethermostatmanual.com>

Golf course search by state

<http://golfingnear.com>

Email search by domain

<http://emailbydomain.com>

Auto manuals search

<http://auto.somanuals.com>

TV manuals search

<http://tv.somanuals.com>