

JVC

HD-ILA TV

HD-70ZR7J

HD-56ZR7J

HD-ILA™
Powered by **D-ILA**

HD
ready

DynaPiX
Powered by **D.L.S.T.**

HDMI™
HIGH-DEFINITION MULTIMEDIA INTERFACE

T-V LINK

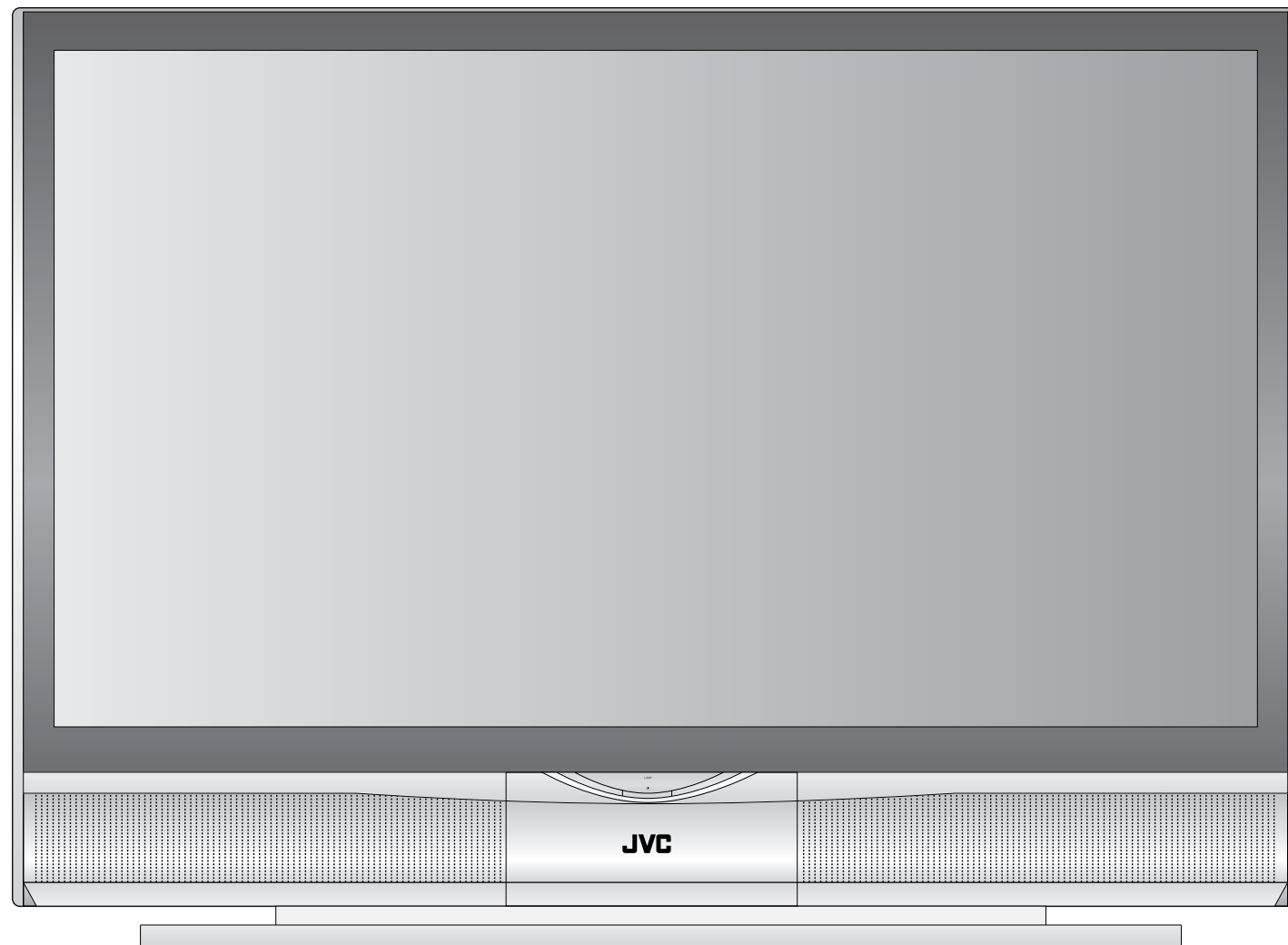
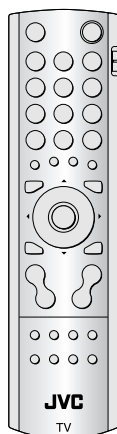

Information for Users on Disposal of Old Equipment



Attention:

This symbol is only valid in the European Union.

[European Union]

This symbol indicates that the electrical and electronic equipment should not be disposed as general household waste at its end-of-life. Instead, the product should be handed over to the applicable collection point for the recycling of electrical and electronic equipment for proper treatment, recovery and recycling in accordance with your national legislation.

By disposing of this product correctly, you will help to conserve natural resources and will help prevent potential negative effects on the environment and human health which could otherwise be caused by inappropriate waste handling of this product. For more information about collection point and recycling of this product, please contact your local municipal office, your household waste disposal service or the shop where you purchased the product.

Penalties may be applicable for incorrect disposal of this waste, in accordance with national legislation.

(Business users)

If you wish to dispose of this product, please visit our web page www.jvc-europe.com to obtain information about the take-back of the product.

[Other Countries outside the European Union]

If you wish to dispose of this product, please do so in accordance with applicable national legislation or other rules in your country for the treatment of old electrical and electronic equipment.

Expanding the world of beautiful images

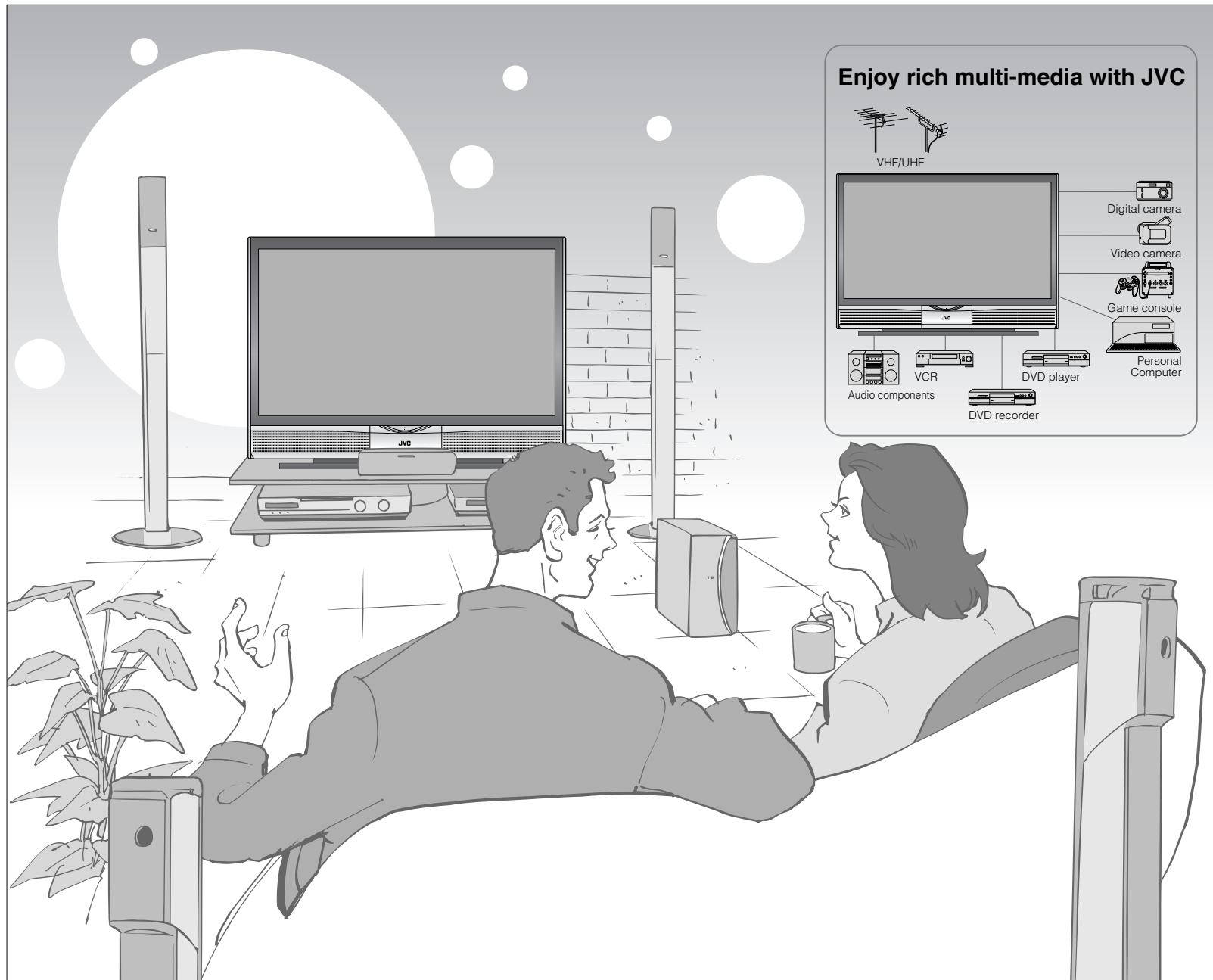

Contents

First things first!

- Warning 2
- Precautions 3
- Replacing the lamp 4

Getting started

- Names of all the parts 6
- Basic connections 7
- Initial settings 8
- Editing channels 9
 - Registering channels
- Connecting external devices 10

Let's try it out

- Enjoying your new TV! 11
 - TV / Teletext / Video / etc.
- Watching TV 12
- Viewing teletext 13
- Watching videos / DVDs 14

Try the advanced features

- Useful functions 15
 - Register your favourite channels
 - View and search in multi-picture mode
 - Sleep timer / Child lock

Just the way you like it

- Customising your TV 17
- Advanced picture adjustment 18
 - Reduce noise / Watch a more natural picture
 - Set the aspect ratio, etc.

When you have trouble

- Troubleshooting 19
- Technical information 20
- CH/CC List 21
- Specifications 21

IMPORTANT!

PREPARE

USE

SETTINGS

TROUBLE?

Warning

Please follow all the guidelines below

Never cut or damage the power cord!

- If the AC plug is not the right shape, or the power cord is not long enough, use an appropriate plug adapter or extension cable. (Consult your retailer.)

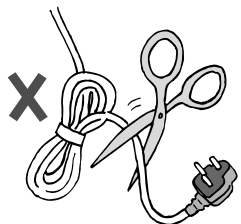

- If you have cut or damage the power cord.
 - ➔ "Technical information (P. 20)"
- To change the fuse in UK plugs
 - ➔ "Technical information (P. 20)"

Never insert objects into the cabinet openings!

- It may cause a fatal electric shock. Take care when children are near.



Never place anything on the TV!

- Placing liquids, open flames, cloths, paper, etc. on the TV may cause a fire.



Never expose to rain or moisture!

- To prevent fire or electric shock, never allow liquids to enter the unit.



Never try to repair the TV yourself!

- ➔ If the problem cannot be solved in "Troubleshooting" (P. 19), unplug the power cord and contact your retailer.

If the TV is damaged or behaving strangely, stop using it at once!

- ➔ Unplug the power cord and contact your retailer.

Do not allow the TV to fall!

- Do not rest your elbows on, or allow children to hang from the TV. There is a risk that the TV will fall and cause injuries.

Never listen to headphones at high volume!

- It may damage your hearing.

Follow this manual regarding setup!

- Connect only to a 220-240V, 50Hz AC outlet.

Unplug the power cord when going out!

- The power buttons on the remote control and the TV unit cannot completely turn off the TV. (Make appropriate arrangements for bedridden people.)
- Make sure that the cooling process (P. 3) has completed before unplugging the power cord.

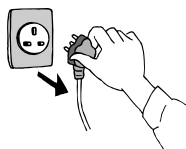

Make enough room for inserting and removing the power plug!

Place the TV as near as possible to the AC outlet

- The main power supply for this TV is controlled by inserting or removing the power plug.

Ensure ample room to avoid overheating

- ➔ "Installation requirements" (P. 7)

Never dismantle the rear panel!

- It may cause an electric shock.

Never block the ventilation holes!

- It may cause overheating or a fire.

Handle screen with care!

- Use a soft, dry cloth when cleaning.

Hold the TV so as not to scratch the screen!

- Do not touch the screen when carrying the TV.

Do not hold by the screen frame when moving the TV!

- This could cause the screen frame to detach, causing the TV to fall. Hold the TV as illustrated on the right.

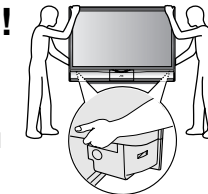

Follow the instructions on page I when disposing of the TV



■ For more details on installation, usage and safety ➔ Consult your retailer

Precautions

Please follow all the guidelines below

This TV uses a lamp to project the picture on the screen. Misoperations may shorten the lamp life or cause malfunction of the lamp. Before operating the TV, read all the instructions below.

This TV has a fan to cool the lamp

- When the lamp is hotter, the fan works harder to cool the lamp. In such a case, the noise of the fan becomes louder but it is not malfunction.

Do not place the TV too close to wallpaper

- The warm air from the air ducts may change the colour of the wallpaper.

Keep children or pets away from the air ducts

- Long exposure to the warm air from the ducts may cause a minor burn.

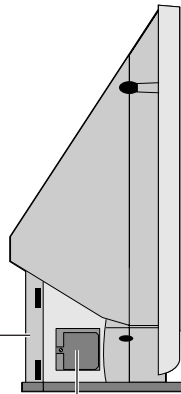

The lamp is a consumable item

- When the lamp has blown, replace the lamp; otherwise, the picture cannot be displayed. For details ➔ "Replacing the lamp" (P. 4, 5)

Follow the instructions on "Replacing the lamp" when replacing the lamp (P. 4)

- Handle the lamp carefully and correctly; otherwise, it may cause a burn or an electric shock. In addition, it may shorten lamp life or cause malfunction of the TV.

Never open the lamp cover except when replacing the lamp

■ Exposing the lamp is dangerous because...

- The lamp becomes extremely hot while in use, it may cause a burn.
- Touching metallic portion of the lamp may cause electric shock.
- Ultraviolet rays are emitted from the lamp.

Never replace the lamp immediately after use

- Since the lamp becomes extremely hot while in use, it may cause a burn.

Never touch the lamp glass

- Dirt or oil from the finger may cause the lamp to break.

When the power is turned on, the warming up commences

- Immediately after the TV is turned on, the picture is displayed only dimly. It takes about one minute for the lamp to warm up. Once the lamp has warmed up, you can enjoy the pictures at their normal brightness.
- During this warming-up period, the LAMP indicator blinks every 2 seconds.

While the LAMP indicator is blinking, the TV cannot be turned off

When the power is turned off, the cooling down is performed

- When the TV is turned off, the picture on the screen disappears gradually. Once the screen is dark, cooling down is performed for about 90 seconds.
- During this cooling-down period, the LAMP indicator blinks every 3 seconds.
- Do not unplug the TV while the lamp is cooling down. This may cause the internal circuits and the lamp to overheat and shorten the lamp life.

While the LAMP indicator is blinking, the TV cannot be turned on

Condensation on the lamp and screen

- When the heater is turned on or the TV is moved from a cold place to a warm place, droplets of water may form on the lamp and screen. This is called condensation. If the TV is used while this condensation is still present, the picture may seem distorted, and the inside of the screen may become dirty. In this case, wait until the condensation has gone before using the TV.

Do not turn the power on and off repeatedly in a short amount of time

- It subjects the TV and the lamp to stress and may lead to malfunctions and shorten the lamp life.

Do not keep the TV on for more than 24 hours consecutively

- The lamp life may be shortened.

Do not project a still picture for a long time

- Because of the ILA characteristics, still parts of the picture may remain on the screen. (The picture will disappear over time.)

■ For more details on installation, usage and safety ➔ Consult your retailer

Replacing the lamp

Before replacing the lamp, read all the instructions.

The TV uses a lamp to project the picture onto the screen. When the lamp has blown or when the picture becomes dark, replace the lamp. Before replacing the lamp, read all the instructions carefully.

■ If you feel unsure about replacing the lamp yourself → Consult your retailer

Preparation

Prepare the Replacement Lamp Kit

- For purchasing the Replacement Lamp Kit, consult your retailer.

⚠ Use only the specified Replacement Lamp Kit!

This lamp is for use with JVC model televisions. Using the lamp with a different television or other product could cause a malfunction and/or damage to the television or lamp.

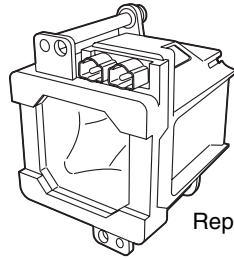

Replacement Lamp Kit:
TS-CL110E
• High-pressure 110 V mercury lamp

When the lamp is near to its end...

- The following message appears on the screen.

LAMP NEEDS TO BE REPLACED.
PLEASE REFER TO THE MANUAL FOR
REPLACEMENT INSTRUCTIONS.

AFTER REPLACING THE LAMP,
PLEASE RESET THE TIMER IN THE
TV MENU.

PRESS OK, IF YOU DO NOT WANT
TO SEE THIS MESSAGE AGAIN.

■ To make the message disappear



After the usage time of the lamp has reached to 6500 hours, this message appears every time you turn on the TV.

■ Possible causes of shortened lamp life

- Turning on/off the TV repeatedly in a short amount of time
- Keeping the TV turned on for more than 24 hours consecutively

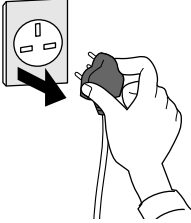
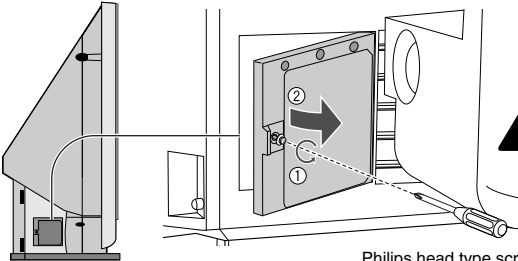
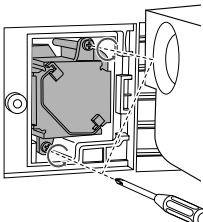
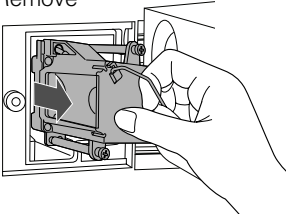
- 1 Turn the TV off**

▶ Wait until the LAMP indicator stops blinking
▶ **Unplug the TV**

- 2 Wait for at least 1 hour until the lamp has fully cooled**
- 3 Remove the lamp unit**
 - ⚠ **Never replace the lamp before it has fully cooled!**
The lamp becomes extremely hot while in use, which may cause a burn. After turning off the TV, wait for at least 1 hour.
 - ⚠ **Never attempt to replace the lamp with the TV plugged in!**
Attempting to replace the lamp with the TV plugged in could lead to a severe electrical shock.
 - 1 Remove the lamp cover**

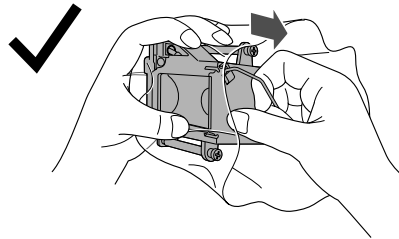
Philips head type screw driver (cross-head type)
⚠ **If you feel any warmth near the lamp, DO NOT TOUCH IT!**
 - 2 Remove the lamp unit**
Loosen

Remove

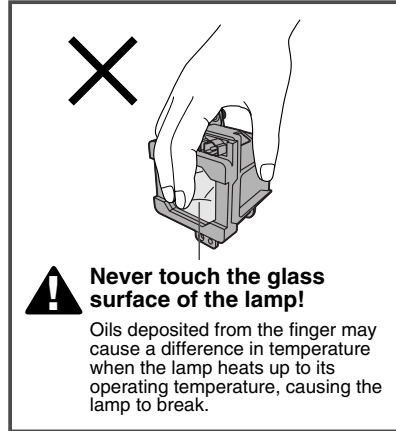
Do not drop the lamp!

4 Install the NEW lamp unit

1 Unpack



Do not drop the lamp!
Do not shock the glass surface of the lamp!
 It may shatter the lamp causing injuries.



Re-tighten

2 Insert

- Make sure the lamp sits securely and flat in the housing area.

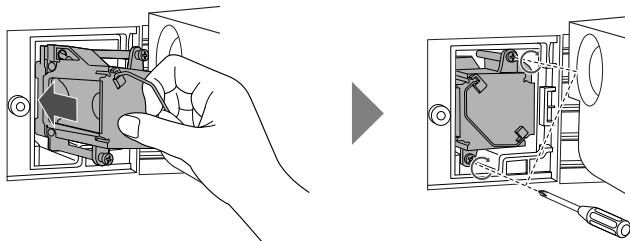

3 Reinstall the lamp cover

- Tighten the screw.

5 Plug in the TV

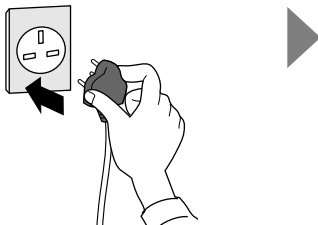

Turn the TV on

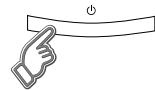

- If the lamp unit is not installed securely (e.g. flat in the lamp housing area), the TV won't turn on. In this case, reinstall the lamp unit.

6 Reset the lamp timer



1 Display the menu bar



2 Select "SET-UP"

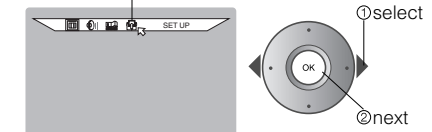

3 Select "LAMP TIMER RESET"

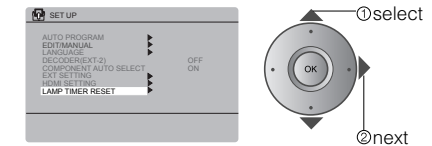

4 Finish

PRESS OK TO RESET THE LAMP TIMER

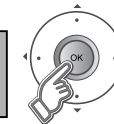

THE LAMP TIMER IS RESET SUCCESSFULLY

7 Finally, the lamp has been replaced!



Never dispose of the lamp with normal trash!

The lamp contains a small amount of mercury. For disposal or recycling information, please contact your local authorities or consult your retailer.

Dispose of it in the same way as disposing of fluorescent lamps.

■ If the power lamp and LAMP indicator blink rapidly after turning on the TV → "Lamp" (P. 20)

Names of all the parts

Front panel

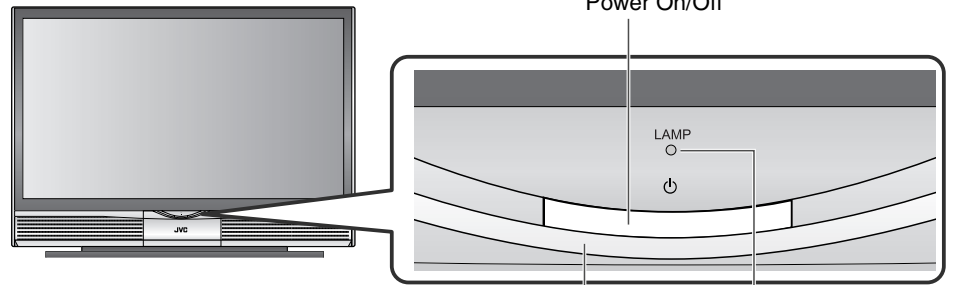

Power lamp

ON: Lit (Blue)
OFF: Unlit

- To change the brightness of the power lamp
→ "ILLUMINATION" (P. 17)

LAMP indicator

● When this indicator blinks
→ "About the LAMP indicator" (Below)

Left side panel

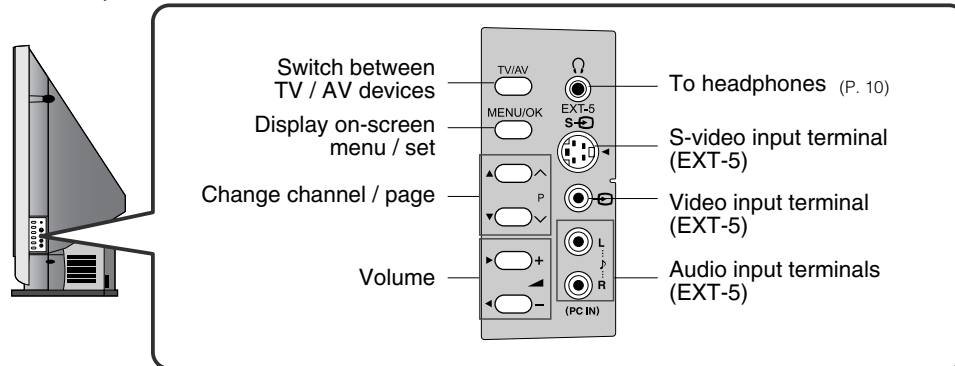

Switch between TV / AV devices

Display on-screen menu / set

Change channel / page

Volume

To headphones (P. 10)

S-video input terminal (EXT-5)

Video input terminal (EXT-5)

Audio input terminals (EXT-5)

- Connecting terminals on the back of the TV → "Connecting External devices" (P. 10)

About the LAMP indicator

The LAMP indicator blinks as follows.

- When turning on the TV, the LAMP indicator blinks for about 1 minute every 2 seconds.
 - The lamp is warming up. During this period, the TV cannot be turned off.
- After turning off the TV, the LAMP indicator blinks in orange for about 90 seconds every 3 seconds.
 - Cooling is performed. During the cooling period, the TV cannot be operated.
- If the LAMP indicator blinks rapidly
 - "Lamp" (P. 20)

Check accessories

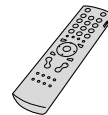

Remote control (RM-C1811H)



AA/R6 Batteries (For confirming the TV works)

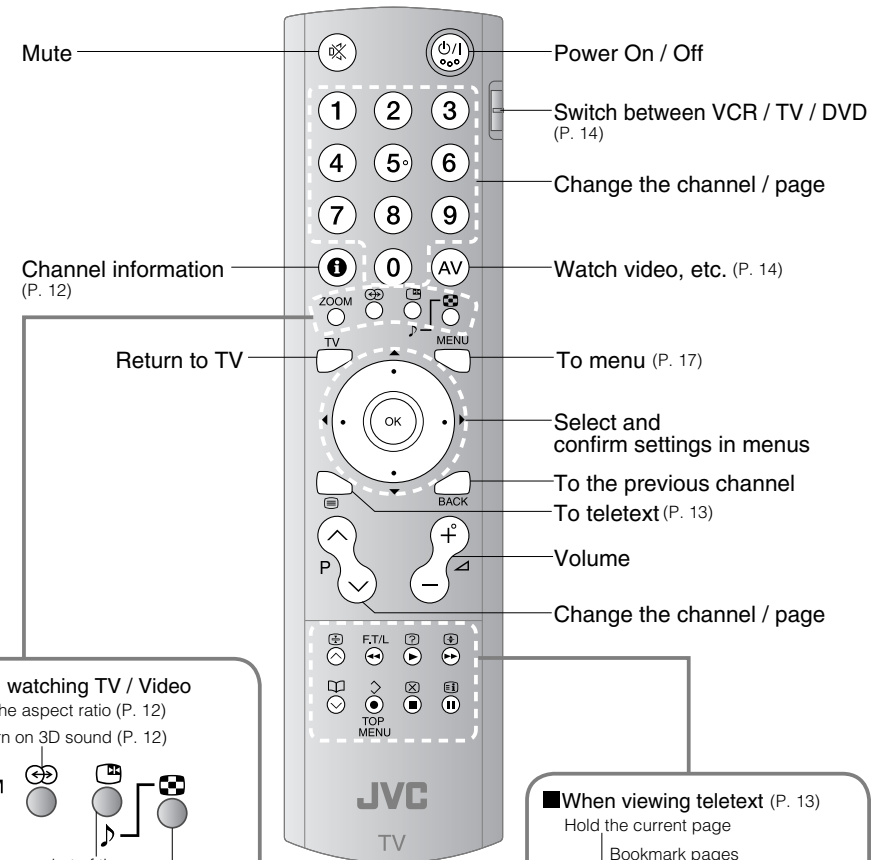

Mute

Power On / Off

Switch between VCR / TV / DVD (P. 14)

Change the channel / page

Channel information (P. 12)

Watch video, etc. (P. 14)

Return to TV

To menu (P. 17)

Select and confirm settings in menus

To the previous channel

To teletext (P. 13)

Volume

Change the channel / page

■ When watching TV / Video

Change the aspect ratio (P. 12)

Turn on 3D sound (P. 12)

Take a snapshot of the screen (P. 12)

View in multi-picture mode (P. 15)

■ When viewing teletext (P. 13)

■ Insert the batteries

Use two AA/R6 dry cell batteries. Insert the batteries from the ⊖ end, making sure the ⊕ and ⊖ polarities are correct.

■ When viewing teletext (P. 13)

Hold the current page

Bookmark pages

Reveal hidden pages

Enlarge the text

Switch briefly between teletext and TV

To index page

■ When watching TV (P. 12)

■ When operating a JVC VCR or DVD (P. 14)

Basic connections

Please read the user manuals of each device carefully before setup.
It is necessary to connect an aerial to watch TV.

■ **Connect with other devices** → “Connecting external devices” (P. 10)

Connect the aerial

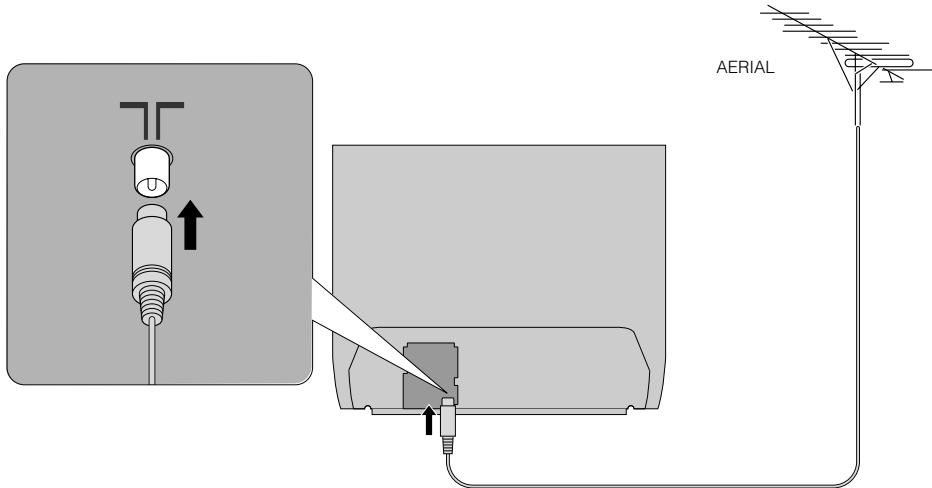

- After all the connections have been made, insert the plug into an AC outlet.

Care when setting

■ Power requirements

- Connect the power cord only to a 220-240V, 50Hz AC outlet.

■ Installation requirements

- To avoid overheating, ensure the unit has ample room.

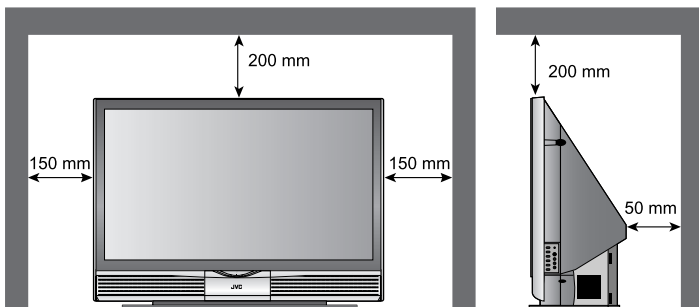

Do not place the TV too close to wallpaper

- The warm air from the air ducts may change the colour of the wallpaper.

Keep children or pets away from the air ducts

- Long exposure to the warm air from the ducts may cause a minor burn.

Connect a VCR / DVD recorder

- Connect T-V LINK compatible recording device to EXT-2.
- T-V LINK → “What is T-V LINK?” (P. 8)

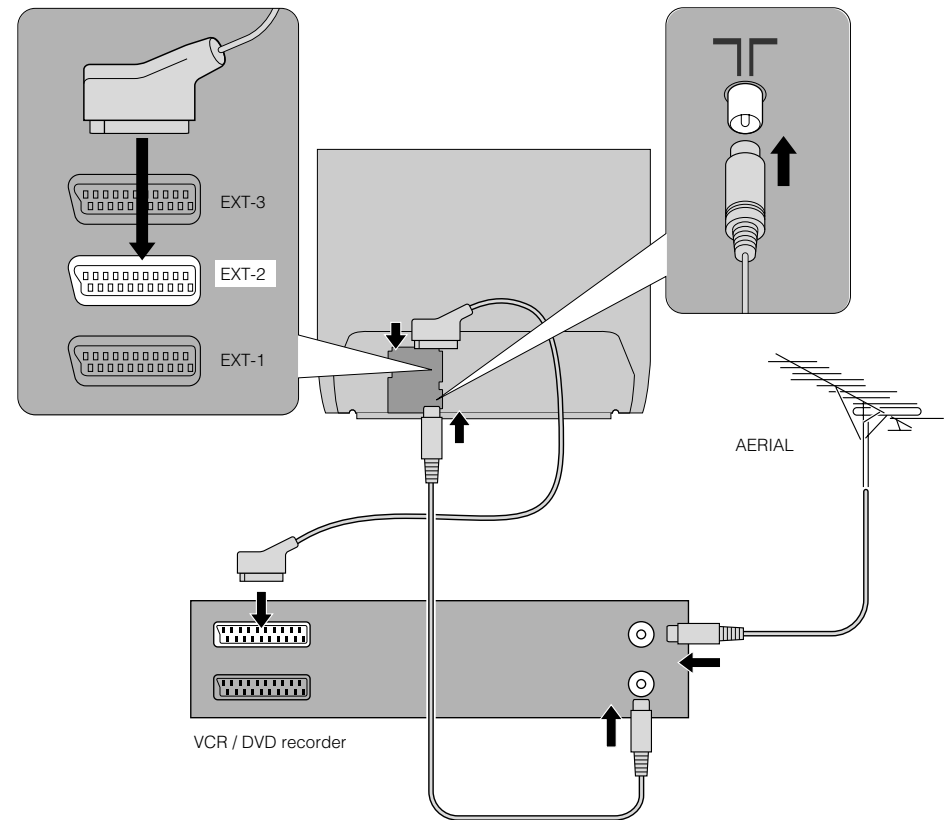

- After all the connections have been made, insert the plug into an AC outlet.

Initial settings

Set the menu language, installation location and automatically register the TV channels. These channels can be edited later in "Editing channels" (P. 9). (Channel data on the TV can be sent to a connected recording device that is compatible with T-V LINK.)

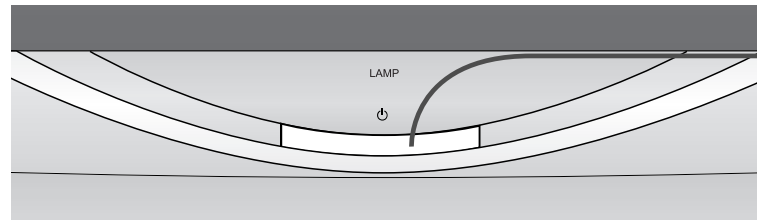

- To the previous screen → BACK
- Exit → TV
- If the "JVC" logo does not appear or if you wish to make changes later → "LANGUAGE" and "AUTO PROGRAM" (P. 17)

What is "T-V LINK"?

Connecting the TV to a T-V LINK compatible device allows :

- Channels on the TV to be instantly registered on the device.
- The "DIRECT REC" function to be used. → "Technical information" (P. 20)

■ T-V LINK variations

"T-V LINK" (JVC) "Q-LINK" (Panasonic) "Megalogic" (Grundig) "Data Logic" (Metz) "SMARTLINK" (Sony) "Easy Link" (Philips)

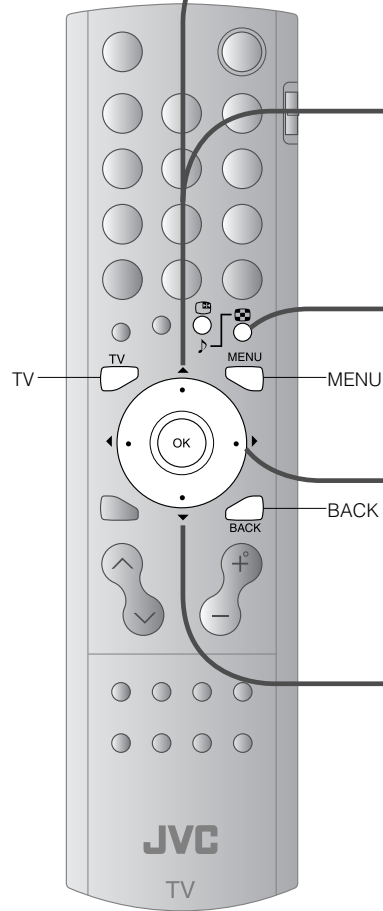

1 Begin

- Shown only when powering on for the first time.
- The power on the remote control can also be used.

2 Select a language

① select
② set

3 Select the country of installation

select

4 Automatically register channels

- If "ACI START" appears, select and start settings. (This will set up cable television channels.) → "What is ACI (Automatic Channel Installation)?" (P. 20)

5 Check what was registered

- Edit channels → 4 in "Editing channels" (P. 9)
- Confirm →

6 Finish

- When using T-V LINK →
- When not using T-V LINK →
- If "FEATURE NOT AVAILABLE" appears :
 - Is the T-V LINK compatible device connected to EXT-2?
 - Is the device turned on?

● When turning on the TV, it takes about 1 minute to project the picture to its full brightness.

● When turning off the TV, it takes about 5 seconds to make the screen dark. After that, cooling is performed for about 90 seconds.

→ "About LAMP indicator" (P. 6)

Editing channels

Edit the channels registered with "AUTO PROGRAM" in "Initial settings" (P. 8).

When coming from "Initial settings" (P. 8), skip to 4.

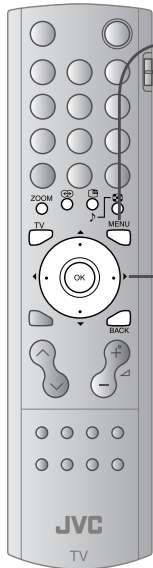

- 1 **Display the menu bar**
MENU
 - 2 **Select "SET UP"**
select
next
 - 3 **Select "EDIT / MANUAL"**
select
next
 - 4 **Select a row**
select
 - 5 **Edit**
 - 6 **Confirm settings**
 - 7 **Finish**
TV LINK
DOWNLOAD TV → RECORDING DEVICE
- If "FEATURE NOT AVAILABLE" appears :
→ Is the T-V LINK compatible device connected to EXT-2?
→ Is the device turned on?
● T-V LINK → (P. 8)
 - **When using T-V LINK**
 - **When not using T-V LINK**

■ To the previous screen



■ Exit



Move a channel's position

MOVE

① Begin ② Select a destination ③ Finish

Edit a channel name

ID

① Begin ② Enter a channel name

ZOOM

enter the first character

■ When selecting a preset name from the ID LIST

select
set

■ When manually naming a channel

enter
next column
set

Insert a channel

INSERT

① Begin ② Enter a CH number ③ Set

● CH/CC List → (P. 21)
● In Ireland, select CH/CC with ▲▼.

● Receives the broadcast signal.

Delete a channel

DELETE

① Delete

Register a new channel

MANUAL

① Begin ② Beginning channel search

From high frequencies From low frequencies

ZOOM

or

③ Set

● Auto-search begins, and the nearest frequency is imported.
→ Repeat the previous steps until the desired channel is displayed

■ Picture fine tuning →

Connecting external devices

VCR / DVD / other devices

You can connect many different devices to the rear panel of the TV.
Please read the user manuals of each device before setting up. (Connecting cables are not supplied with this TV.)

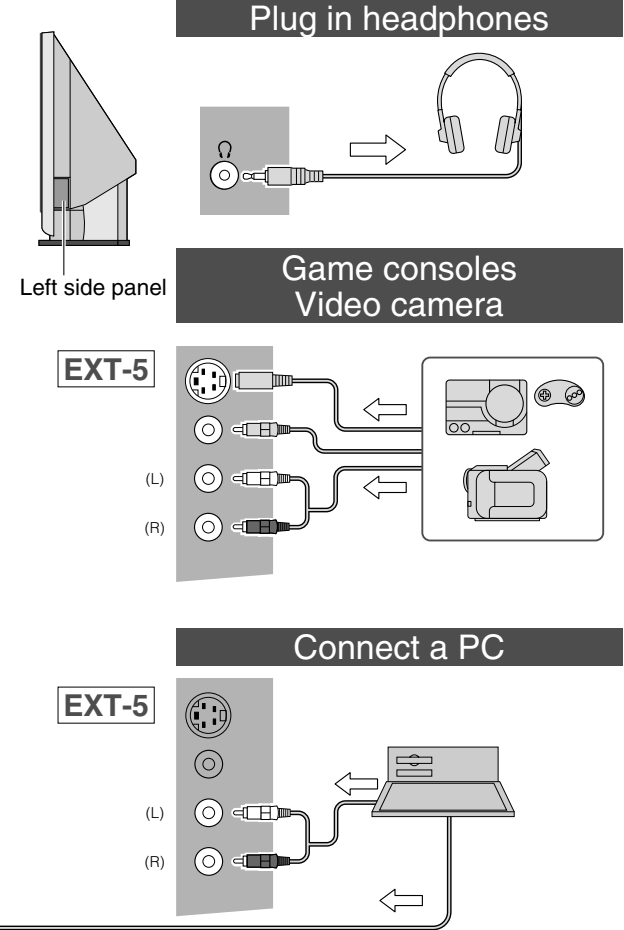
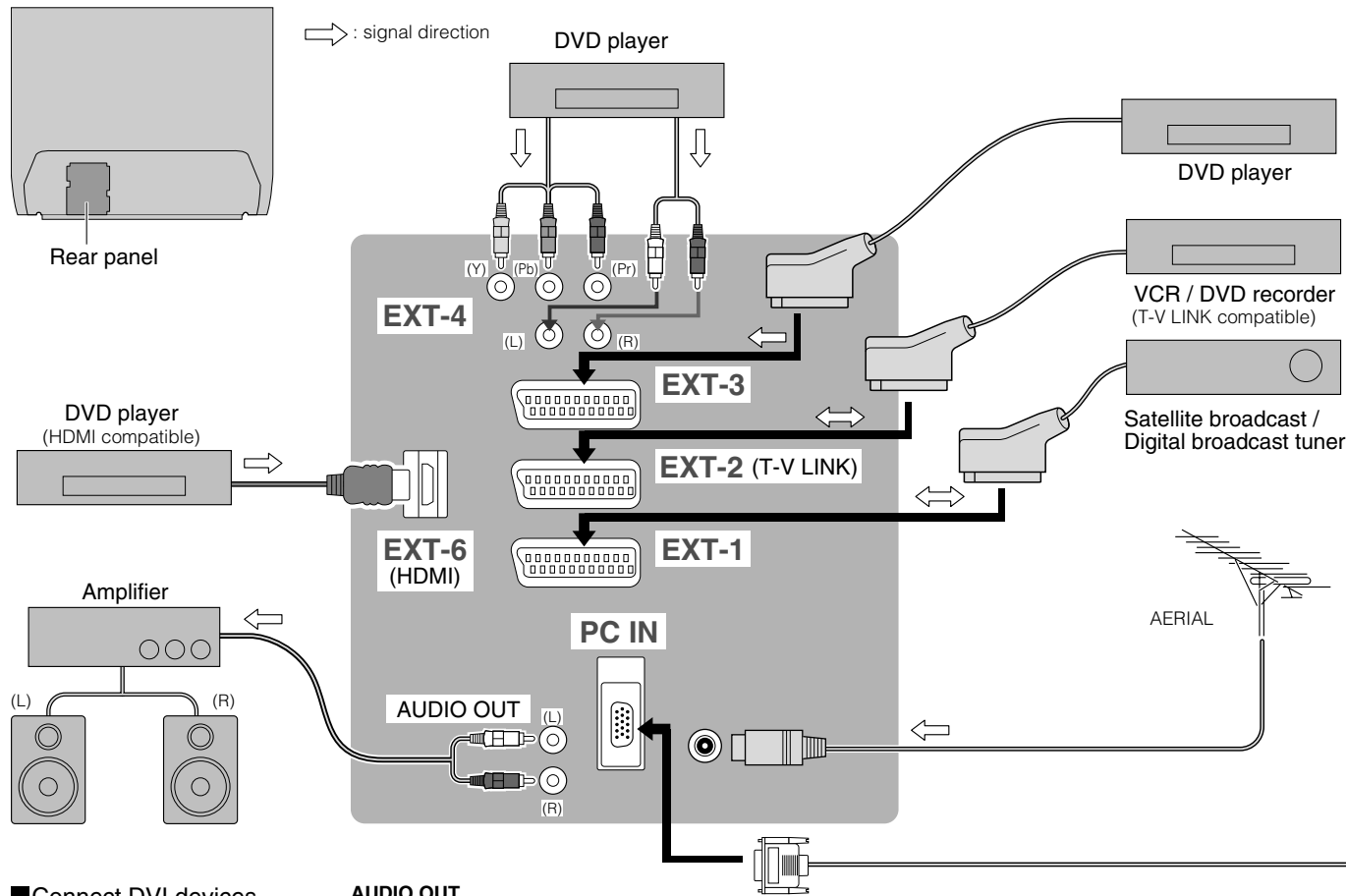

- Connect DVI devices → (P. 20)
- T-V LINK → (P. 8)

AUDIO OUT
Listening to the TV on external speakers

Output ↑
· Sound L / R

EXT-1 Watching videos

Output ↑	Input ↓
· Composite signal	· Composite signal / RGB / S-VIDEO
· Sound L / R	· Sound L / R

- Use S-VIDEO → "S-IN" (P. 14)

EXT-2 Dubbing videos Using T-V LINK

Output ↑	Input ↓
· Composite signal	· Composite signal / RGB / S-VIDEO
· Sound L / R	· Sound L / R
· T-V LINK	

- Use S-VIDEO → "S-IN" (P. 14)
- Select dubbing sources → "DUBBING" (P. 14)
- Connect a decoder → "DECODER (EXT-2)" (P. 17)

EXT-3 Watching videos

Output ↑	Input ↓
	· Composite signal
	· Sound L / R

EXT-4 Watching DVDs

Output ↑	Input ↓
	· Component signal (P. 21)
	· Sound L / R

- COMPONENT AUTO SELECT → (P. 17)

EXT-5 Watching videos

Output ↑	Input ↓
	· Composite signal / S-VIDEO
	· Sound L / R

- Use S-VIDEO → "S-IN" (P. 14)

EXT-6 Connecting HDMI devices

Output ↑	Input ↓
	· HDMI signal (P. 21)

- HDMI SETTING → (P. 17)

- Check for PC compatibility → "Technical information" (P. 20)

Enjoying your new TV!

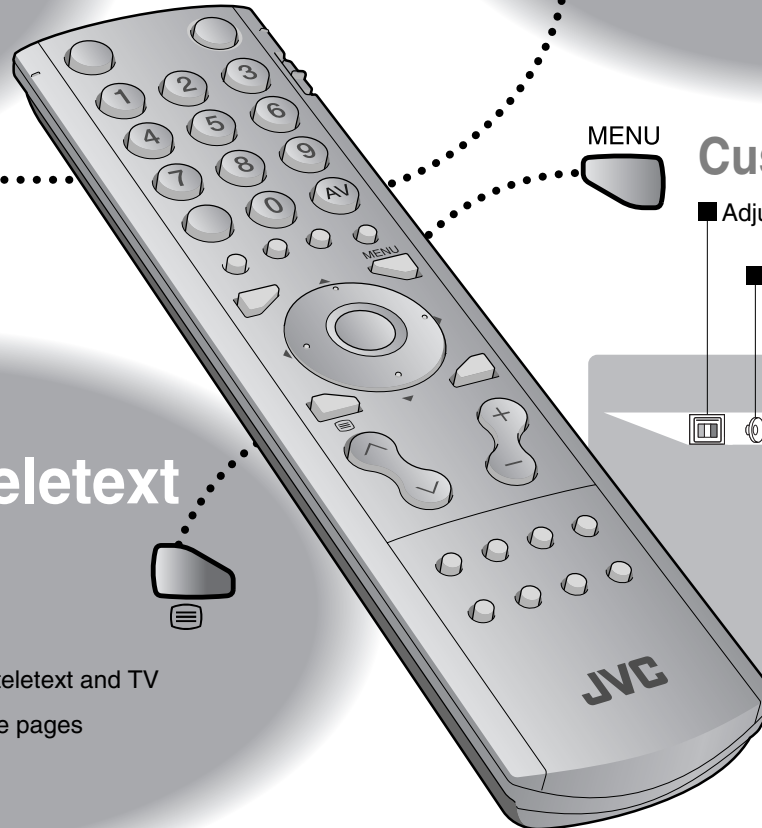
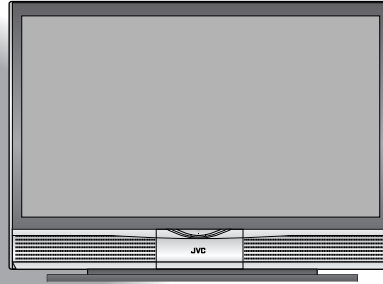
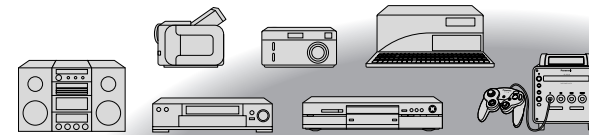
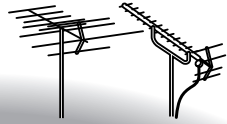

PAGE
12

Watching TV

- View channel information
- Change the aspect ratio
- Enjoy 3D sound
- Take a snapshot

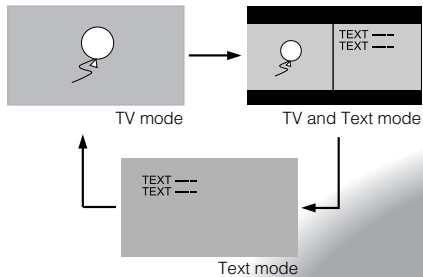
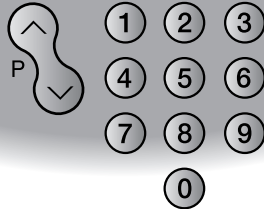

PAGE
13

Viewing teletext

- Enlarge the text
- To the index page
- Hold the current page
- Switch briefly between teletext and TV
- Bookmark your favourite pages

PAGE
14

Watching videos / DVDs

- Watch high quality video (S-VIDEO)
- Name connected devices
- Dub videos



PAGE
17

Customizing your TV

- Adjust the picture
- Adjust the sound

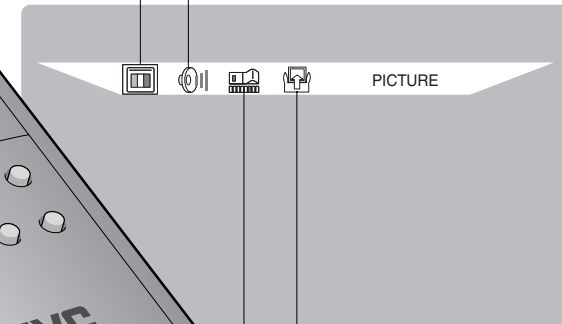

■ Basic settings
(channel settings, etc.)

■ Advanced settings
(sleep-timer / child lock, etc.)

IMPORTANT!

PREPARE

USE

SETTINGS

TROUBLE?

Watching TV

1 Power on

- The blue power lamp on the TV lights
- Press again to turn the screen off and put the TV into standby mode.

2 Select a channel

E.g.

1 : 0 → 1

15 : 1 → 5

■ Move up or down a channel

up

down

■ Switch between stereo / mono / bilingual broadcasting

→ "STEREO / I · II" (P. 17)

■ To the previous channel

BACK

■ Mute

■ Volume

Note

- To completely turn off the TV, unplug the AC plug after the LAMP indicator stops blinking.

- When turning on the TV, it takes about 1 minute to project the picture to its normal brightness.
- When turning off the TV, it takes about 5 seconds to make the screen dark. After that, cooling down is performed for about 90 seconds.
- ➔ "About the LAMP indicator" (P. 6)

Channel information and clock

INFORMATION

PR LIST

- Channels registered in "Initial settings" will appear here.

Channel information

Time (in case of having viewed teletext)

(No indication)

■ Select a page

■ Select and view a channel

Change the aspect ratio

ZOOM

16:9 ZOOM

Move the picture with ▲ or ▼ while this bar is displayed

- When set to AUTO, the aspect ratio will turn to the ratio obtained from the information the TV received. Without receiving aspect information, it will be set to "4:3 AUTO ASPECT" (P. 18)
- Not available for 1080i (1125i) / 720p (750p) signals.
- In PC mode, "REGULAR" and "FULL" can be selected.

Enjoy ambient sound

3D SOUND

3D SOUND HIGH

- HIGH : For stereo sound
- LOW : For stereo sound (when the sound distorts in HIGH mode)
- MONO : For mono sound (emulates a stereo-like sound)
- OFF : Turns off 3D SOUND

Take snapshots of the screen

FREEZE

Still picture

Current programme

■ Cancel

- ➔ Press again, or change the channel
- Not available when the SUB-PICTURE is displayed, or when in PC mode.
- You cannot save or export the snapshot.

Basic operations using the side buttons

1 Power on

2 Change the channel

■ Volume

Viewing teletext

This TV can display TV broadcasts and teletext on the same channel in two windows.

1 When watching TV

2 Enter a teletext page

1 2 3
4 5 6
7 8 9
0

■ Move up or down a page

up
down

■ View sub-pages

to sub-page

Bookmark your favourite page

1 Display your favourites list (RED) (GREEN) (YELLOW) (BLUE) F.T/L

2 Select a coloured button to save your page to

3 Enter the number of the page to save

4 Save

LIST MODE

■ Recall your favourite page → Press the coloured button as in step 2

Hold the current page
HOLD
■ Release → Press again

Reveal hidden pages
REVEAL

Enlarge the text
SIZE

To the index page
INDEX

Switch briefly from teletext to TV
CANCEL

Hold the current page

Display hidden information (answers to quizzes, etc)

Double the size of the displayed text

Returns to page "100" or a previously designated page

Leave the current page open, while you switch to watch TV

Useful when running a page search.

IMPORTANT!

PREPARE

USE

SETTINGS

TROUBLE?

Watching videos / DVDs

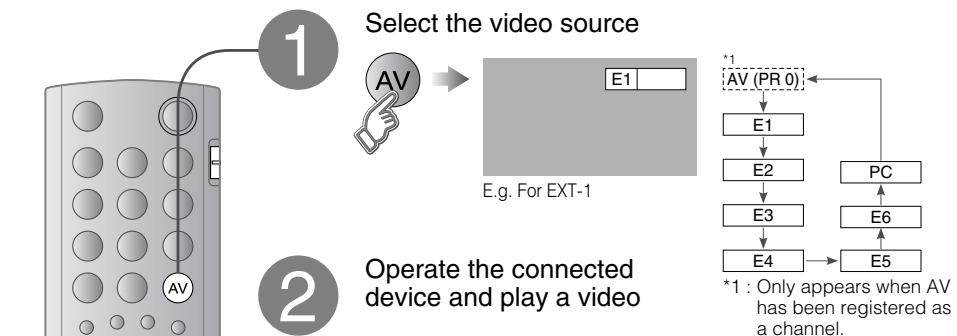

Operate JVC VCRs and other devices

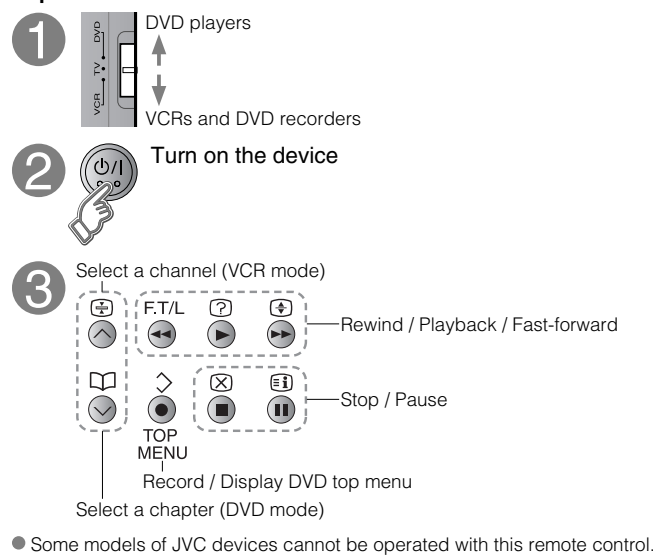

Advanced functions

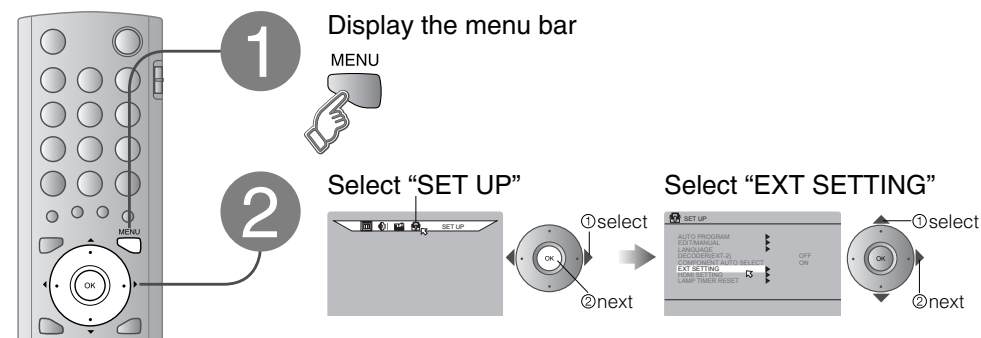

Switch to S-VIDEO input

S-IN

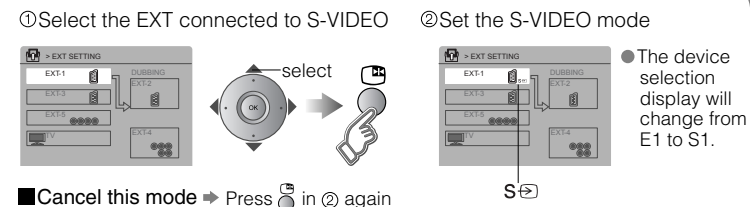

Edit names of connected devices

ID LIST

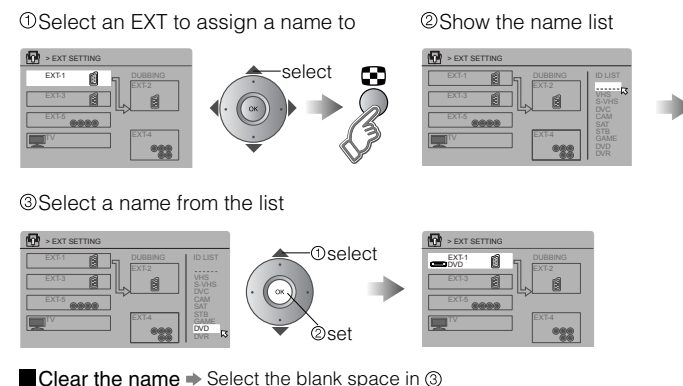

Set up dubbing on EXT-2

DUBBING

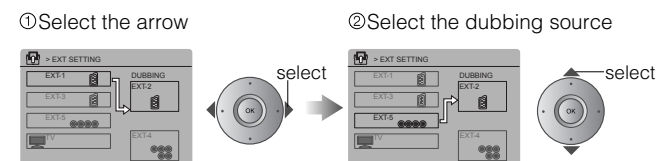

Useful functions

Register a channel to a button

FAVOURITE CHANNEL

Press the number to register it on

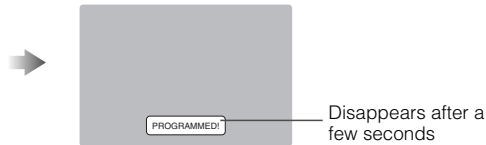

Recall the favourite channel

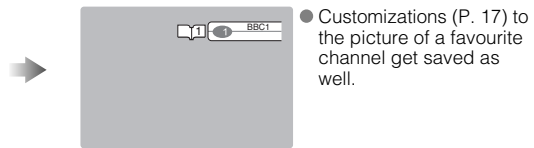

Check your favourite channels

➔ Press **i** and confirm that the channels you have registered have a beside them

Delete a favourite channel

➔ "MENU" ➔ ➔ "FEATURES" ➔ "FAVOURITE SETTING"

① Select the channel you want to delete

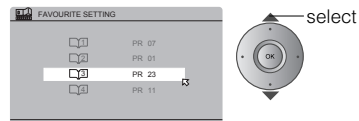

② Delete

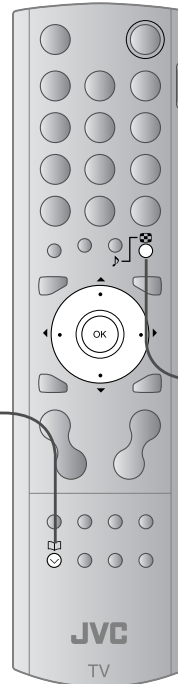
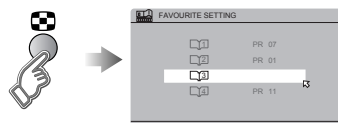

Watch in multi-picture mode

MULTI-PICTURE

Select the number of screens



Selecting "1" returns to normal viewing mode
● Not available in PC mode.

Watch in dual-picture mode

E.g. You can watch TV and video at the same time.

(For wide aspect ratio signals)



● Switch between the sound sources
➔

● Change the channel
➔ (Main)
➔ (Sub)

Select a channel in 12-screen mode

All registered channels are displayed as still images.

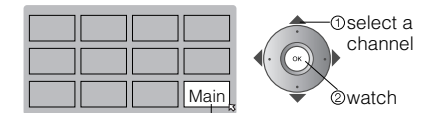

Only the selected frame has a moving picture.

● Move up or down a page ➔
● Not available for EXT-6 input.

Useful functions (continued)



1 Display the menu bar



2 Select "FEATURES"

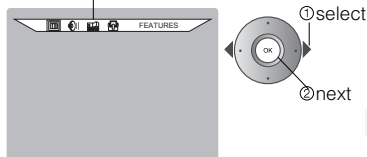

Set a time for the TV to turn itself off

SLEEP TIMER

3

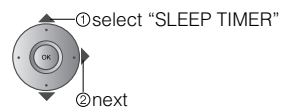
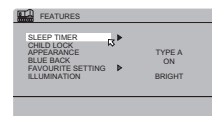

4

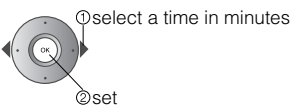
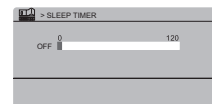

■ Cancel → Set the time to "0" in step 4

■ Remaining time → You can confirm the remaining time at step 4, after repeating this process.

Stop children from watching specific channels

CHILD LOCK

3

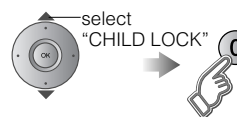
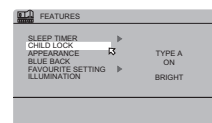

4

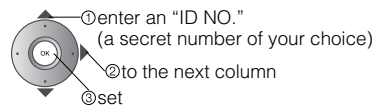
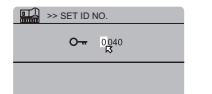

5

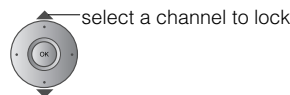
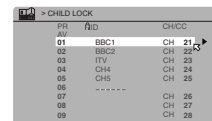

6

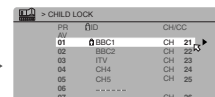
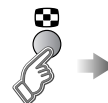

■ Lock more channels
→ Repeat steps 5 and 6

7

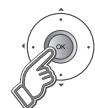

■ Release a channel → Press again in step 6

■ View a locked channel → Use the numerical buttons to enter the channel number. When appears, press and enter your "ID NO.". (If you forget your "ID NO.", check it in step 4.)

Customizing your TV

1 Display the menu bar
MENU

2 Select a menu
①select
②next

3 Select an item
select

4 Adjust / Configure
①adjust / select
②set

■ To the previous screen
BACK

■ Exit
MENU

● The menu disappears after one minute of inactivity.

■ When adjusting with the sliding-bar
Move

■ When selecting from presets
The item will change.

● Some items have a sub-menu.

PICTURE SOUND FEATURES SET UP PICTURE

Selected menu's title

PICTURE

PICTURE MODE CONTRAST BRIGHT SHARP COLOUR HUE COLOUR TEMP. FEATURES

Items

PICTURE

PICTURE MODE CONTRAST BRIGHT SHARP COLOUR HUE COLOUR TEMP. FEATURES

Sub-menu Adjustments / Configurations

Menu	Item	Adjustments / Configurations
PICTURE	PICTURE MODE	Picture mode (BRIGHT / STANDARD / SOFT)
	CONTRAST	Contrast (Lower ↔ Higher)
	BRIGHT	Brightness (Darker ↔ Brighter)
	SHARP	Sharpness (Softer ↔ Sharper)
	COLOUR	Colour (Lighter ↔ Deeper)
	HUE	Tint for NTSC (Reddish ↔ Greenish)
	COLOUR TEMP.	Colour temperature (WARM / NORMAL / COOL)
SOUND	FEATURES	Finer picture adjustments (P. 18)
	STEREO / I · II	Mode / Language (⊙ : STEREO / ○ : MONO / I : SUB1 / II : SUB2)
	BASS	Low tones (Weaker ↔ Stronger)
	TREBLE	High tones (Weaker ↔ Stronger)
	BALANCE	Speaker balance (Left Stronger ↔ Right Stronger)
	3D SOUND	Ambience level (HIGH / LOW / MONO / OFF)
	BBE *1	Sound enhancement technology (ON / OFF)
FEATURES	SLEEP TIMER	Timer for turning off the TV (P. 16)
	CHILD LOCK	Stops children from watching specific channels (P. 16)
	APPEARANCE	Format for displaying the channel number (TYPE A / TYPE B / TYPE C / TYPE D)
	BLUE BACK	Displays a blue screen and mutes the sound when the signal is weak or absent (ON / OFF)
	FAVOURITE SETTING	Clear favourite channel settings (P. 15)
	ILLUMINATION	Changes brightness of the power lamp (P. 6) (BRIGHT / SOFT)
	SET UP	AUTO PROGRAM
EDIT / MANUAL		Change registered channels or add new ones (P. 9)
LANGUAGE		Select a language for on-screen menus (P. 8, ②)
DECODER(EXT-2)		For when connected to VCR with T-V LINK (ON / OFF)
COMPONENT AUTO SELECT		Changes the TV input to EXT-4 when a component signal is input to EXT-4 (ON / OFF) (Not available when viewing PC)
EXT SETTING		For use with video players and other devices (P. 14)
HDMI SETTING		SIZE (AUTO / 1 / 2) AUDIO (AUTO / ANALOGUE / DIGITAL)
LAMP TIMER RESET	Resets the lamp timer (P. 5)	

*1 BBE license ➔ (P. 20)

IMPORTANT!

PREPARE

USE

SETTINGS

TROUBLE?

Advanced picture adjustment

By default, the TV automatically adjusts itself for the best picture.









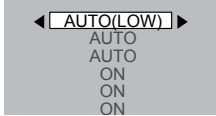
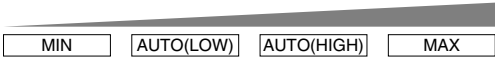
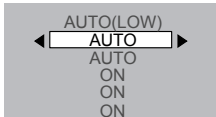

- 1** Display the menu bar
MENU
- 2** Select "PICTURE"
select
- 3** Select "FEATURES"
select
- 4** Select an item
select
E.g. DIGITAL VNR
- 5** Change settings
select
E.g. DIGITAL VNR
- 6** Finish
select

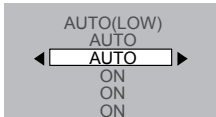
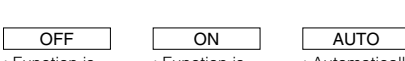
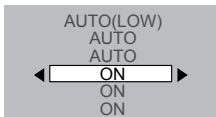
■ To the previous screen
 BACK

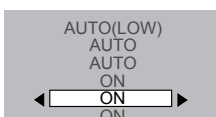
■ Exit
 MENU

● The menu disappears after one minute of inactivity.

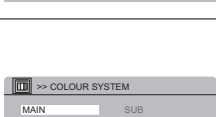
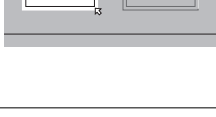
DIGITAL VNR	To reduce noise	  <p>level</p> <p>: When the picture loses sharpness</p> <p>: When noise appears</p>
Super DigiPure	For natural-looking outlines	  <p>level</p> <p>: Function is turned off</p> <p>: When noise appears</p> <p>: When the picture loses sharpness</p>
MOVIE THEATRE	For smooth cinema film	  <p>: Function is turned off</p> <p>: Function is always on</p> <p>: Automatically adjusts</p>
COLOUR MANAGEMENT	For natural-looking pictures	  <p>: Function is turned off</p> <p>: Maintains a natural colour balance</p>
PICTURE MANAGEMENT	Fix bright / dark pictures	  <p>: Function is turned off</p> <p>: Makes it easier to view bright / dark pictures</p>
SMART PICTURE	Adjust brightness of white portions	  <p>: Function is turned off</p> <p>: Function is always on</p> <p>● Fixed to "OFF" when "PICTURE MODE" is "BRIGHT" (P. 17)</p>
COLOUR SYSTEM	When there is no colour	 <p>① Select the screen to change settings on</p> <p>MAIN SUB</p> <p>: Main picture : Sub-picture in MULTI-PICTURE mode (P. 15)</p> <p>② Select the colour system</p> <p>PAL NTSC 3.58 NTSC 4.43 AUTO</p> <p>: Western Europe : USA 3.58 MHz : USA 4.43 MHz : When watching videos, etc.</p>
4:3 AUTO ASPECT	Set a default aspect ratio	 <p>Select a default aspect ratio for AUTO in "ZOOM" (P. 12)</p> <p>PANORAMIC REGULAR 14:9 ZOOM</p> <p>16 : 9 4 : 3 14 : 9</p>

Troubleshooting

Severe noise or snow



- Is the TV connected correctly to the aerial?
 - Change the direction of the aerial.
 - Is the aerial or its cable damaged?
- ➔ Consult your retailer

Patterns, stripes or noise



- Is the aerial receiving interference from high-voltage power lines or wireless transmitters?
- ➔ Consult your retailer
- Are connected devices too close to the TV?
- ➔ Insert the minimum distance between the aerial and the cause of interference until no interference occurs

Ghosting

(Doubling of images)

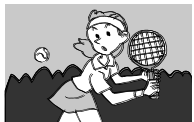

- Are you receiving interference from signals reflected off mountains or buildings?
- ➔ Adjust the direction of your aerial, or change to a good-quality directional aerial

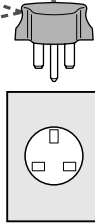
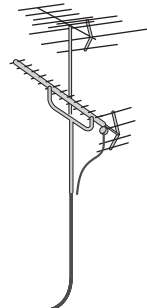
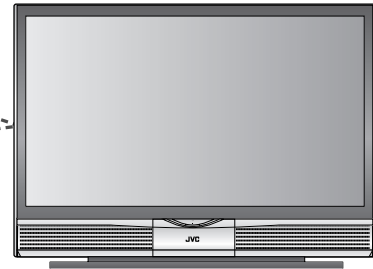

I can't turn it on!

- Is the power cord connected to the AC outlet correctly?

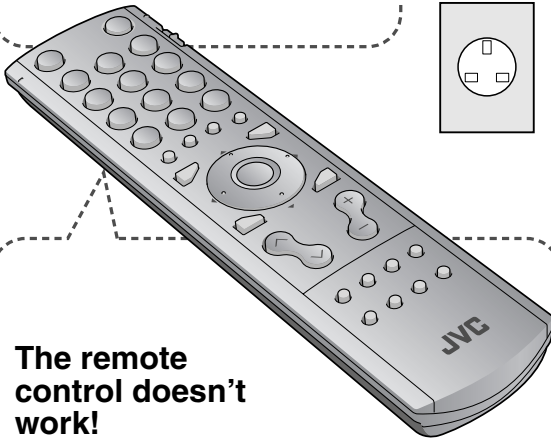

The remote control doesn't work!

- Are the batteries flat?
- Are you more than 7 metres away from the TV?
- Is the "VCR/TV/DVD SWITCH" set to "TV"?
- When viewing teletext, the TV menu bar does not appear.
- Depending on the stability of the signal, there may be a time lag when changing channels.

	Problem	Actions	page
Basics	Remote control stops working	<ul style="list-style-type: none"> ● Unplug the TV, and wait about 1 hour until the lamp completely cooled. Then plug the TV in again. (Turning on the TV soon may shorten the lamp life.) 	—
	Aspect ratio changes unintentionally	<ul style="list-style-type: none"> ● Press ZOOM to return to your settings. 	12
Screen	Black or white dots appear on the screen	<ul style="list-style-type: none"> ● Although the HD-ILA element is manufactured with high-precision technology, please understand that some pixels may be lost or permanently displayed. 	—
	Poor picture quality	<ul style="list-style-type: none"> ● Unnatural colour >>> Adjust COLOUR and BRIGHT. Check your COLOUR SYSTEM. ● Noise >>> Set to the following functions. PICTURE MODE : STANDARD DIGITAL VNR : AUTO (HIGH) Super DigiPure : MIN ● Dull picture >>> Set to the following functions. PICTURE MODE : BRIGHT DIGITAL VNR : MIN Super DigiPure : MAX 	17 18 17 18 18
Picture	Strange picture when using an external device	<ul style="list-style-type: none"> ● If you connected S-Video output device, check the "S-IN" setting. ● If the top of the image is distorted, check the video signal quality itself. ● If movement appears unnatural when receiving a signal from a DVD player, etc. with 625p (progressive-scanning), change the output setting of the external device to 625i (interlace-scanning). 	14 — —
	Poor sound	<ul style="list-style-type: none"> ● Adjust the BASS and TREBLE. ● If receiving a poor signal in "STEREO / I · II", switch to MONO. 	17 17
Sound	Wrong screen size	<ul style="list-style-type: none"> ● Switch SIZE in HDMI SETTING to "1" or "2". 	17
	No picture, no sound	<ul style="list-style-type: none"> ● Use the cable with HDMI logo. HDMI 	—
HDMI	No sound	<ul style="list-style-type: none"> ● Switch AUDIO in HDMI SETTING to ANALOGUE or DIGITAL. ● Check if the device is compliant with HDMI. 	17 —
	Green and distorted screen	<ul style="list-style-type: none"> ● Wait a little for the signal to stabilize when switching the signal format for an HDMI device. 	—

IMPORTANT!

PREPARE

USE

SETTINGS

TROUBLE?

Troubleshooting (continued)

	Problem	Actions	page
Functions	Some functions do not work	<ul style="list-style-type: none"> It is not a malfunction. Some functions (dark background) in the menu do not work depending on the situation. 	—
	Some inputs cannot be selected in the sub-picture	<ul style="list-style-type: none"> EXT-4, EXT-6 inputs and PC mode cannot be selected in the sub-picture. 	—
Display	"FEATURE NOT AVAILABLE" appears	<ul style="list-style-type: none"> Is the T-V LINK compatible device connected to EXT-2? Is the SCART CABLE "Fully Wired"? Is the T-V LINK compatible device turned on? After confirming all the conditions above, press "OK" button again.	21 21 —
	"ACI ERROR" appears	<ul style="list-style-type: none"> Press ◀ to start ACI again. If you still receive the "ACI ERROR" after numerous tries, press ▶ to cancel ACI. 	—
Lamp	The LAMP indicator blinks rapidly	<ul style="list-style-type: none"> Keep the TV off for a while and then turn the power on again. If the TV goes into warning mode, unplug the TV after the cooling has completed and consult your retailer. (It may be a malfunction of the internal electrical circuits.) 	—
	The power lamp and LAMP indicator blink alternately	<ul style="list-style-type: none"> Keep the TV off for a while and then turn the power on again. If the TV goes into warning mode, unplug the TV after the cooling has completed and consult your retailer. (The inside temperature rises abnormally or the fan may be blocked.) 	—
	The power lamp and LAMP indicator blink rapidly simultaneously	<ul style="list-style-type: none"> If this condition occurs soon after replacing the lamp, reinstall the new lamp unit. (The lamp unit may not be inserted into the lamp housing correctly.) Repeat the lamp installation steps, taking care to observe all warnings. <ul style="list-style-type: none"> Make sure the lamp sits flat inside the housing area. Make sure the lamp cover is reinstalled. If this condition occurs except for replacing the lamp, keep the TV off for a while and then turn the power on again. If the TV goes into warning mode, unplug the TV after the cooling has completed and consult your retailer. (It may be a lamp malfunction.) 	6 —

Technical information

What is T-V LINK?

T-V LINK allows the TV to share information easily with a connected T-V LINK compatible device. By using T-V LINK :

- You can send the channel information programmed on the TV to the T-V LINK compatible device, so that both the TV and the external device have the same channel settings. When connecting a new external device, channel information is loaded into it, allowing channel setup to be completed very quickly. For more details, refer to the external device's manual.
- You can easily record the TV programme you are viewing on a T-V LINK compatible device by using the "DIRECT REC" feature. For more details, refer to the external device's manual.

What is ACI (Automatic Channel Installation)?

Some cable companies transmit a signal called ACI which contains information that allows TV channels to be registered automatically on your TV. When an ACI signal is received, "ACI START / ACI SKIP" appears in the "AUTO PROGRAM" screen.

PC Signals that can be displayed

Macintosh computers are not supported. (Macintosh is a registered trademark of Apple Computer, Inc.)

Resolution	640 x 480 (VGA)	1024 x 768 (XGA)
Vertical frequency (Hz)	60.0	60.0
Horizontal frequency (kHz)	31.5	48.4

- If the signal doesn't appear, check that the vertical frequency on the PC is set to 60 Hz.

Connect DVI devices

Connect a DVI device to EXT-6 (HDMI) using DVI-HDMI conversion cable. Connect analogue sound output of the DVI device to L and R terminals in EXT-4.

- Set AUDIO in HDMI SETTING to Analogue or AUTO ➔ (P. 17)

If you accidentally cut the power cord

- Never connect to the larger terminal marked with an "E", the safety earth symbol "⊥" or coloured green or green-and-yellow.
- The wires in the mains lead on this product are coloured with the following code:
 - Blue: Neutral wire (connect to the black terminal, or one marked "N")
 - Brown: Live wire (connect to the red terminal, or one marked "L")

Change the fuse in the plug

Open the plug as illustrated on the right.

- When replacing the fuse, always use a correctly rated and approved type and re-fit the fuse cover when finished. If in doubt, contact your retailer.

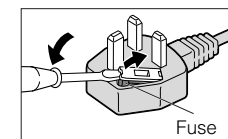

Licence

Manufactured under license from BBE Sound, Inc. Licensed by BBE Sound, Inc. under USP4638258, 5510752 and 5736897. BBE and BBE symbol are registered trademarks of BBE Sound, Inc.

CH/CC List

To use the INSERT function (P.9), find the CH/CC number corresponding to the TV's channel number from this table. If you want to know a particular TV channel's channel menu, look in TV listings magazines or contact the broadcaster.

- When the COUNTRY setting is "UNITED KINGDOM", the CC number channels and channels from CH02 to CH12 cannot be received.

CH	Channel	CH	Channel	CC	Channel	CC	Channel
CH 02	E2, IR A1	CH 40	E40	CC 01	S1	CC 31	S31
CH 03	E3, IR B	CH 41	E41	CC 02	S2	CC 32	S32
CH 04	E4, IR C	CH 42	E42	CC 03	S3	CC 33	S33
CH 05	E5, IR D	CH 43	E43	CC 04	S4	CC 34	S34
CH 06	E6, IR E	CH 44	E44	CC 05	S5	CC 35	S35
CH 07	E7, IR F	CH 45	E45	CC 06	S6	CC 36	S36
CH 08	E8, IR G	CH 46	E46	CC 07	S7	CC 37	S37
CH 09	E9	CH 47	E47	CC 08	S8	CC 38	S38
CH 10	E10, IR H	CH 48	E48	CC 09	S9	CC 39	S39
CH 11	E11, IR J	CH 49	E49	CC 10	S10	CC 40	S40
CH 12	E12	CH 50	E50	CC 11	S11	CC 41	S41
CH 21	E21	CH 51	E51	CC 12	S12	CC 75	X
CH 22	E22	CH 52	E52	CC 13	S13	CC 76	Y
CH 23	E23	CH 53	E53	CC 14	S14	CC 77	Z
CH 24	E24	CH 54	E54	CC 15	S15	CC 78	Z+1
CH 25	E25	CH 55	E55	CC 16	S16	CC 79	Z+2
CH 26	E26	CH 56	E56	CC 17	S17		
CH 27	E27	CH 57	E57	CC 18	S18		
CH 28	E28	CH 58	E58	CC 19	S19		
CH 29	E29	CH 59	E59	CC 20	S20		
CH 30	E30	CH 60	E60	CC 21	S21		
CH 31	E31	CH 61	E61	CC 22	S22		
CH 32	E32	CH 62	E62	CC 23	S23		
CH 33	E33	CH 63	E63	CC 24	S24		
CH 34	E34	CH 64	E64	CC 25	S25		
CH 35	E35	CH 65	E65	CC 26	S26		
CH 36	E36	CH 66	E66	CC 27	S27		
CH 37	E37	CH 67	E67	CC 28	S28		
CH 38	E38	CH 68	E68	CC 29	S29		
CH 39	E39	CH 69	E69	CC 30	S30		

COUNTRY setting

Depending on the country selected during "AUTO PROGRAM", the receivable broadcast system differs.

	UNITED KINGDOM	FRANCE	Other countries
Broadcast system	CCIR I only	CCIR I, B, G, D, K, L	CCIR I, B, G, D, K
Colour system	PAL only	PAL, SECAM	PAL, SECAM
Sound multi-plex system	NICAM (I) only	NICAM, A2	NICAM, A2

To change "COUNTRY" setting:

- 1) Change the "COUNTRY" in "AUTO PROGRAM".
- 2) Press the "BACK" button to return to the menu and set the channel using "MANUAL".

- If the sound is poor, change to the correct broadcast system using ► button.

Specifications

Main unit

Model	HD-70ZR7J	HD-56ZR7J
Broadcasting systems	CCIR I (See "COUNTRY setting" on this page)	
Colour systems	PAL (See "COUNTRY setting" on this page) The EXT terminals also support the NTSC 3.58/4.43 MHz system.	
Channels and frequencies	E21-E69 (UNITED KINGDOM) IR A-J, E2-E12, E21-E69 (IRELAND)	
Sound-multiplex systems	NICAM (I) (See "COUNTRY setting" on this page)	
Teletext systems	FLOF (Fastext), TOP, WST (standard system)	
Power requirements	AC 220 V - 240 V, 50 Hz	
Audio output (Rated power output)	10 W + 10 W	
Speakers	10 cm round x 2	
Power consumption [standby]	179 W [2.6 W]	
Screen size (visible area size measured diagonally)	178 cm	142 cm
Dimensions (W x H x D: mm)	1626 x 1167 x 519	
Weights	69 kg	42 kg
Accessories	(See "Check accessories", P. 6)	

Terminals / Connectors

	Terminal name	Terminal type	Signal type (IN)	Signal type (OUT)	Notes
Input / Output terminals	EXT-1	Euroconnector x 1 (SCART connector)	Composite video, S-video, Analog RGB AUDIO L / R	TV out	
	EXT-2	Euroconnector x 1 (SCART connector)	Composite video, S-video, Analog RGB AUDIO L / R	Dubbing out	T-V LINK compatible
Input terminals	EXT-3	Euroconnector x 1 (SCART connector)	Composite video AUDIO L / R		
	EXT-4	RCA connectors x 5	Analogue component (576i (625i) / 480i (525i), Progressive : 576p (625p) / 480p (525p), HD : 1080i (1125i), 720p (750p)) AUDIO L / R		
	EXT-5	RCA connectors x 3, S-VIDEO connector x 1	Composite video, S-video AUDIO L / R		
	EXT-6	HDMI connector x 1	HDMI (576i (625i) / 480i (525i) / 576p (625p) / 480p (525p), 1080i (1125i), 720p (750p))		
	PC IN	D-SUB (15 pins) x 1	Analogue PC signal (P. 21)		
Output terminals	AUDIO OUT	RCA connectors x 2		Audio L / R	
	Headphone	Stereo mini-jack x 1 (3.5 mm in diameter)		Headphone output	

- We may change the design and specifications without notice.

JVC

For users in the UK :

If you have any problems setting up your new TV, please call the **JVC** Helpline on **0870 330 5000**.

For users in the Republic of Ireland :

If you have any problems setting up your new TV, please call the **JVC** Helpline on **1890-582500**.

Free Manuals Download Website

<http://myh66.com>

<http://usermanuals.us>

<http://www.somanuals.com>

<http://www.4manuals.cc>

<http://www.manual-lib.com>

<http://www.404manual.com>

<http://www.luxmanual.com>

<http://aubethermostatmanual.com>

Golf course search by state

<http://golfingnear.com>

Email search by domain

<http://emailbydomain.com>

Auto manuals search

<http://auto.somanuals.com>

TV manuals search

<http://tv.somanuals.com>