

JVC®

LCD Flat Television Users Guide

For Models:
LT-37X898
LT-42X898
LT-47X898



Illustration of LT-42X898 and RM-C1400

Important Note:

In the spaces below, enter the model and serial number of your television (located at the rear of the television cabinet). Staple your sales receipt or invoice to the inside cover of this guide. Keep this user's guide in a convenient place for future reference. Keep the carton and original packaging for future use.

Model Number: _____

Serial Number: _____

LCT2329-001A-A
0807TNH-II-IM

Important Safety Precautions



CAUTION
RISK OF ELECTRIC SHOCK
DO NOT OPEN



CAUTION: To reduce the risk of electric shock. Do not remove cover (or back). No user serviceable parts inside. Refer servicing to qualified service personnel.

The lightning flash with arrowhead symbol, within an equilateral triangle is intended to alert the user to the presence of uninsulated "dangerous voltage" within the product's enclosure that may be of sufficient magnitude to constitute a risk of electric shock to persons.

The exclamation point within an equilateral triangle is intended to alert the user to the presence of important operating and maintenance (servicing) instructions in the literature accompanying the appliance.

WARNING: TO PREVENT FIRE OR SHOCK HAZARDS, DO NOT EXPOSE THIS APPARATUS TO RAIN OR MOISTURE.

CAUTION: TO INSURE PERSONAL SAFETY, OBSERVE THE FOLLOWING RULES REGARDING THE USE OF THIS UNIT.

1. Operate only from the power source specified on the unit.
2. Avoid damaging the AC plug and power cord.
3. Avoid Improper installation and never position the unit where good ventilation is unattainable.
4. Do not allow objects or liquid into the cabinet openings.
5. In the event of trouble, unplug the unit and call a service technician. Do not attempt to repair it yourself or remove the rear cover.

Changes or modifications not approved by JVC could void the warranty.

- * When you don't use this TV set for a long period of time, be sure to disconnect both the power plug from the AC outlet and antenna for your safety.
- * To prevent electric shock do not use this polarized plug with an extension cord, receptacle or other outlet unless the blades can be fully inserted to prevent blade exposure.



- As an "ENERGY STAR®" partner, JVC has determined that this product or product model meets the "ENERGY STAR®" guidelines for energy efficiency.

IMPORTANT RECYCLING INFORMATION

This product has a fluorescent lamp that contains mercury. Disposal of these materials may be regulated in your community due to environmental considerations. For disposal or recycling information, please contact your local authorities or for USA, the Electronic Industries Alliance: <http://www.eiae.org>

IMPORTANT SAFETY INSTRUCTIONS

- 1) Read these instructions.
- 2) Keep these instructions.
- 3) Heed all warnings.
- 4) Follow all instructions.
- 5) Do not use this apparatus near water.
- 6) Clean only with dry cloth.
- 7) Do not block any ventilation openings. Install in accordance with the manufacturer's instructions.
- 8) Do not install near any heat sources such as radiators, heat registers, stoves, or other apparatus (including amplifiers) that produce heat.
- 9) Do not defeat the safety purpose of the polarized or grounding-type plug. A polarized plug has two blades with one wider than the other. A grounding type plug has two blades and a third grounding prong. The wide blade or the third prong are provided for your safety. If the provided plug does not fit into your outlet, consult an electrician for replacement of the obsolete outlet.
- 10) Protect the power cord from being walked on or pinched particularly at plugs, convenience receptacles, and the point where they exit from the apparatus.
- 11) Only use attachments/accessories specified by the manufacturer.
- 12) Use only with a cart, stand, tripod, bracket, or table specified by the manufacturer, or sold with the apparatus. When a cart is used, use caution when moving the cart/apparatus combination to avoid injury from tip-over.



- 13) Unplug this apparatus during lightning storms or when unused for long periods of time.
- 14) Refer all servicing to qualified service personnel. Servicing is required when the apparatus has been damaged in any way, such as power-supply cord or plug is damaged, liquid has been spilled or objects have fallen into the apparatus, the apparatus has been exposed to rain or moisture, does not operate normally, or has been dropped.

- 15) Apparatus shall not be exposed to dripping or splashing and no objects filled with liquids, such as vases, shall be placed on the apparatus.
- 16) Avoid improper installation and never position the unit where good ventilation is impossible. When installing this TV, distance recommendations must be maintained between the set and the wall, as well as inside a tightly enclosed area or piece of furniture. Keep to the minimum distance guidelines shown for safe operation.

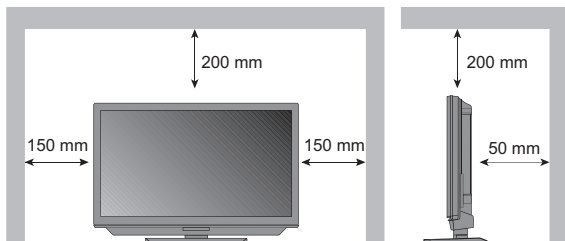

17) Cautions for installation

- Do not tilt the TV towards the left or right, or towards the back.
 - Install the TV in a corner on the floor so as to keep cords out of the way.
 - The TV will generate a slight amount of heat during operation. Ensure that sufficient space is available around the TV to allow satisfactory cooling.
- 18) Make enough room for inserting and removing the power plug. Place the TV as close to the outlet as possible. The main power supply for this TV is controlled by inserting or removing the power plug.
 - 19) Batteries shall not be exposed to excessive heat such as sunshine, fire or the like.
 - 20) When this TV is connected to the wall outlet, it is always on standby even when all the LED lamps are not lit. To shut down the TV, unplug the TV from the wall outlet.

FCC Notice:

Caution: Changes or modifications not expressly approved by party responsible for compliance could void the user's authority to operate the equipment.

Note: This equipment has been tested and found to comply with the limits for a Class B digital device, pursuant to Part 15 of the FCC Rules. These limits are designed to provide reasonable protection against harmful interference in a residential installation. This equipment generates, uses and can radiate radio frequency energy and, if not installed and used in accordance with the instructions, may cause harmful interference to radio communications. However, there is no guarantee that interference will not occur in a particular installation. If this equipment does cause harmful interference to radio or television reception, which can be determined by turning the equipment off and on, the user is encouraged to try to correct the interference by one or more of the following measures:

- Reorient or relocate the receiving antenna.
- Increase the separation between the equipment and receiver.
- Connect the equipment into an outlet on a circuit different from that to which the receiver is connected.
- Consult the dealer or an experienced radio/TV technician for help.

Warnings

We have an important note for customers who subscribe to basic cable services (do not have a separate cable box) and plan to use their JVC TV remote control to select channels.

Once you run the Auto Tuner Setup (which detects and programs all the channels your TV is receiving through the RF input), every channel number available from your cable company will appear in your television's Channel Summary and they will all be marked as available for scanning. Even though every channel is detected and appears as available, you will only be able to view those that you specifically subscribe to from your cable company. This will likely mean there are blank channels between those channels you wish to scan or "surf".

We apologize for any inconvenience this may cause but it is important to note that this is not a malfunction of your television. If you want to sequentially scan those channels you subscribe to without blank ones in between, you can contact your cable company for their cable box and remote.

Avoiding Ghost Images

Displaying fixed images for extended periods of time can leave a subtle but temporary ghost image on your screen. To avoid this, mix your viewing pattern.

Examples include, but are not limited to the following:

- Stock-market report bars
- Shopping channel logos and pricing displays
- Video game patterns or scoreboards
- Bright station logos
- Internet web sites or other computer-style images
- DVD discs, video tapes, laser discs
- Broadcast, cable, satellite channels or digital television tuners/converters

For example...

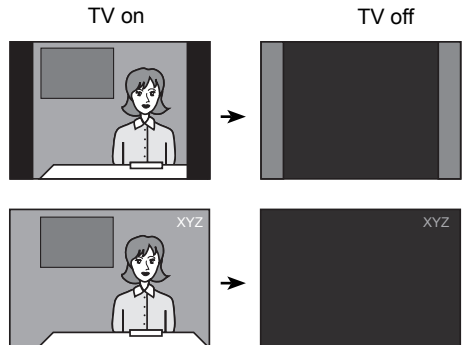

Warnings

Caring for the Cabinet

Normally, light dusting with a soft, non-scratching duster will keep your TV clean.

If you wish to wipe down the television, first unplug it. Then wipe gently with a soft cloth, slightly moistened with water. You can add a few drops of mild liquid detergent to the water to help remove spots of oily dirt.

- DO NOT allow liquid to enter the TV through the ventilation slots.
- DO NOT use strong or abrasive cleaners on the TV.
- DO NOT spray liquids or cleaners directly on the TV's surface.
- DO NOT rub or scrub the TV harshly. Wipe the set gently with a soft cloth.

Caring for the Screen

The screen is treated with an electrostatic-proof coating. When it gets dirty, wipe it gently with a soft cloth. If the screen is very dirty, wipe it down with a cloth dipped in a diluted kitchen cleaner and thoroughly wrung-out. Then wipe immediately after with a clean, dry cloth.

Do not apply alcohol, organic solvents (like acetone), acidic or alkaline cleansers to the screen. These will remove the coating layer and cause discolorations.

Do not push or hit the screen. This could cause scratches on the screen surface and image distortions.

Tidying the cables

A cable holder which keeps your connection cables tidy is attached to the back of the stand.

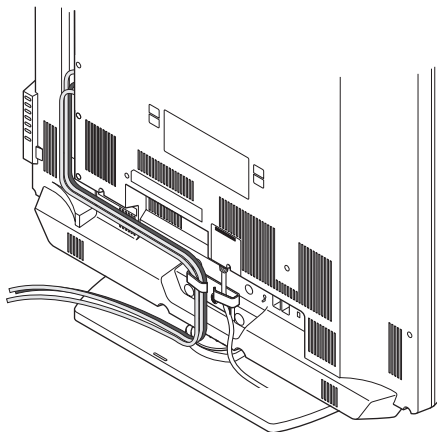

Warnings

Disconnecting the stand

If you disconnect the stand, attach the bottom cover and the screw (supplied) into the hole.

- 1) Place the TV face down on a soft cloth on a table.
- 2) Remove the four screws from the back of the TV.

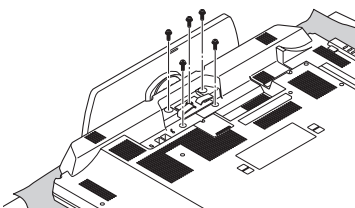

- 3) Pull out the stand from the TV.

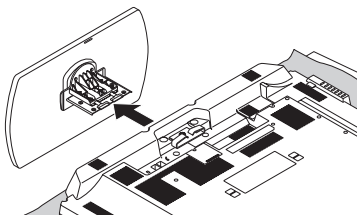

- 4) Cover the hole with a bottom cover and tighten the screw.

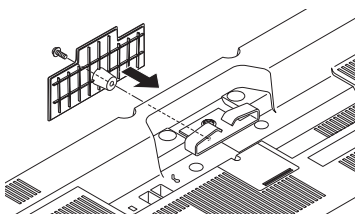

Note:

- To re-install the stand, reverse the procedure from 4) to 1).

Table of Contents

Important Safety Precautions . . .	2	Sound Adjust	55
Warnings	5	Sound Settings	55
Quick Setup	9	Turn On Volume	55
Unpacking your TV	9	Volume Limit	55
TV Models	10	Reset	55
TV Remote Control	11	Clock/Timers	56
Getting Started	12	Set Clock	56
The Remote Control	12	On/Off Timer	57
Connecting Your Devices	13	Button Functions	58
Interactive Plug In Menu	24	Power	58
Onscreen Menus	27	Number Buttons	58
Using the Guide	27	Tune	58
Onscreen Menu System	28	Sub Channel	58
Initial Setup	30	Channel +/-	58
HDMI Size	30	Volume +/-	59
Video-1 Audio	30	Muting	59
Noise Muting	31	D/A (Digital/Analog)	59
Front Panel Lock	31	Input	59
Video Input Label	32	Return+/TV	60
Position Adjustment	33	Light	60
Power Indicator	33	Menu	60
Illumination	34	OK	60
Language	34	Back	60
Closed Caption	34	Favorite	61
Auto Shut Off	37	Aspect	62
XDS ID	37	Guide	63
Auto Tuner Setup	37	Sound	64
Channel Summary	38	ML/MTS	64
V-Chip	40	Video Status	65
Set Lock Code	46	C.C.	65
Auto Demo	47	Sleep Timer	66
Digital Setup	47	Display	66
V5 Input	49	Twin	67
Picture Adjust	50	Swap	67
Picture Settings	50	Select	68
Color Temperature	50	Freeze	68
Color Management	51	Mode	68
Dynamic Gamma	51	External device control buttons	68
Smart Picture	51	Remote Programming	69
Natural Cinema	52	OSD Information	75
Digital VNR	52	Weak Signal	75
MPEG NR	53	No Program	75
Smart Sensor	53	Invalid Signal	75
Sensor Effect	53	Troubleshooting	76
Theater Pro II	53	Specifications	78
Reset	54	Warranty	79
		Authorized Service Center	80
		Notes	81

Unpacking your TV

Thank you for your purchase of a JVC LCD Flat Television. Before you begin setting up your new television, please check to make sure you have all of the following items. In addition to this guide, your television box should include:

Television x 1

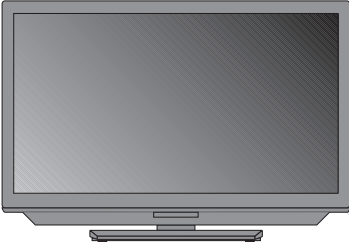

Remote Control x 1



AA Batteries x 2



Note: Your television and/or remote control may differ from the examples illustrated here.

Cover x 1



Screw x 1



We recommend that before you start using your new television, you read this entire User's Guide so you can learn about your new television's many great features. If you're anxious to start using your television right away, a quick setup guide follows on the next few pages.

Quick Setup

TV Models

Before you connect your television to another device, please refer to the proper diagrams for your specific TV and remote. These will help assist you in understanding how to connect your television to another device, as well as use the remote to set up your television.

Rear Panel Diagram

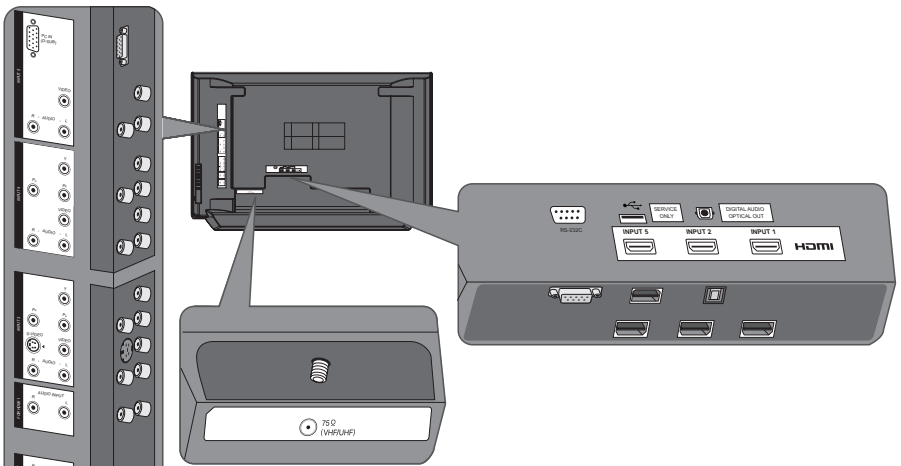

Notes:

- The terminal labeled "SERVICE ONLY", is exclusively used to update the software version.
- For governing the usage of the RS-232C terminal, consult your dealer.

Side Panel Diagram

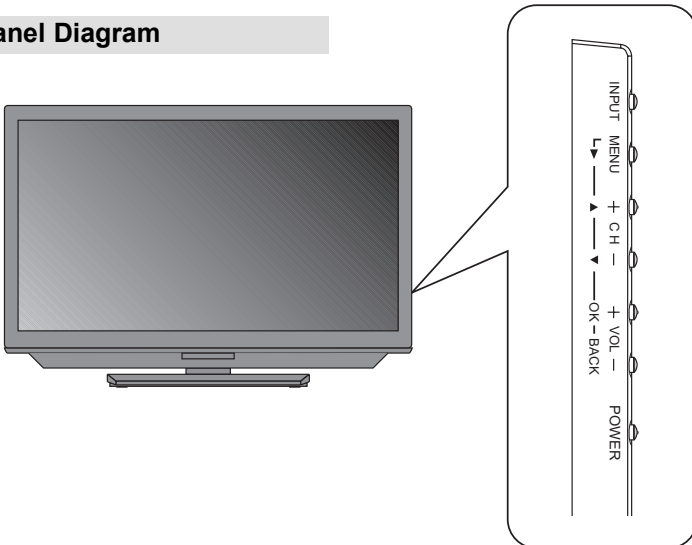

TV Remote Control



RM-C1400

Notes:

- For information on remote control buttons, see pages 58 - 68.
- SUB CHANNEL and GUIDE buttons are for digital channels. If your TV is connected to an ATSC antenna or Digital Cable, you can use these buttons.
- This remote control is capable of operating many external device brands. See page 69 - 74 for how to program the remote control.

Quick Setup

Getting Started

These quick setup pages will provide you, in three easy steps, with the basic information you need to begin using your new television right away. If you have questions, or for more detailed information on any of these steps, please consult other sections of this manual.

Step 1 – The Remote Control

Before you can operate your remote control, you first need to install the batteries (included).

Raise the latch on the remote's back cover to remove. Insert two batteries, carefully noting the "+" and "-" markings. Place the "-" end in the unit first. Snap the cover back into place.

When you change the batteries, try to complete the task within three minutes. If you take longer than three minutes, the remote control codes (ex. VCR, DVD) may have to be reset. See pages 69 - 74.

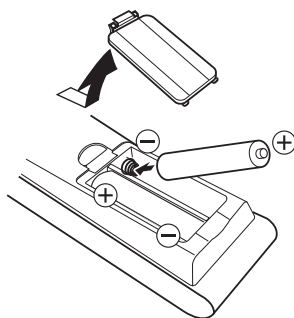

Basic Operation

Turn the television on and off by pressing the **POWER** button at the top right corner of the remote. If this is the first time you are turning on the TV, the interactive plug in menu appears.



- At first, to watch your TV, select the TV mode by pressing the **MODE** button on the remote control before you turn the TV power on.
- See page 58 to 68 for details regarding the remote control buttons.

Using Menu Buttons

To use the menu functions, press the **MENU** button. Next, select a menu using the four arrow keys. The four arrow keys are used only for menu selections.

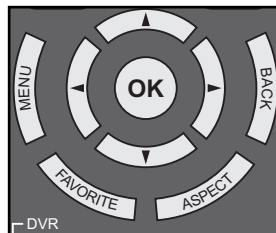

Step 2 - Connecting your devices

To make these connections, you will use plugs like the ones illustrated below.

Coaxial Cables



Used to connect an external antenna or cable TV system to your TV.

S-Video Cable



Used to make video connections with S-Video VCRs, Camcorders and DVD players.

Component Cables Composite Cables Audio Cables



Used to connect audio/video devices like VCRs, DVD players, stereo amplifiers, game consoles, etc.

Notes:

- The following connection diagrams are examples.
- After you are finished connecting your devices, plug the power cord into the nearest power outlet and turn on the TV.
- If you follow these diagrams and the television does not work properly, contact your local cable operator.
- To connect a DVD player, see VCR Connection.
- If you have a satellite television system, refer to the satellite TV manual.

No VCR Connection

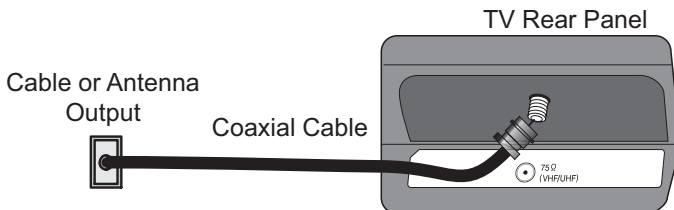

Quick Setup

VCR • DVD Connection

Notes:

- Green, blue and red are the most common colors for DVD cables. Some models may vary colors. Please consult the user's manual for your DVD player for more information.
- Be careful not to confuse the red DVD cable with the red audio cable. It is best to complete one set of connections (DVD or audio output) before starting the other to avoid accidentally switching the cables.
- You may also connect the DVD player to Input 1.

Diagram #1

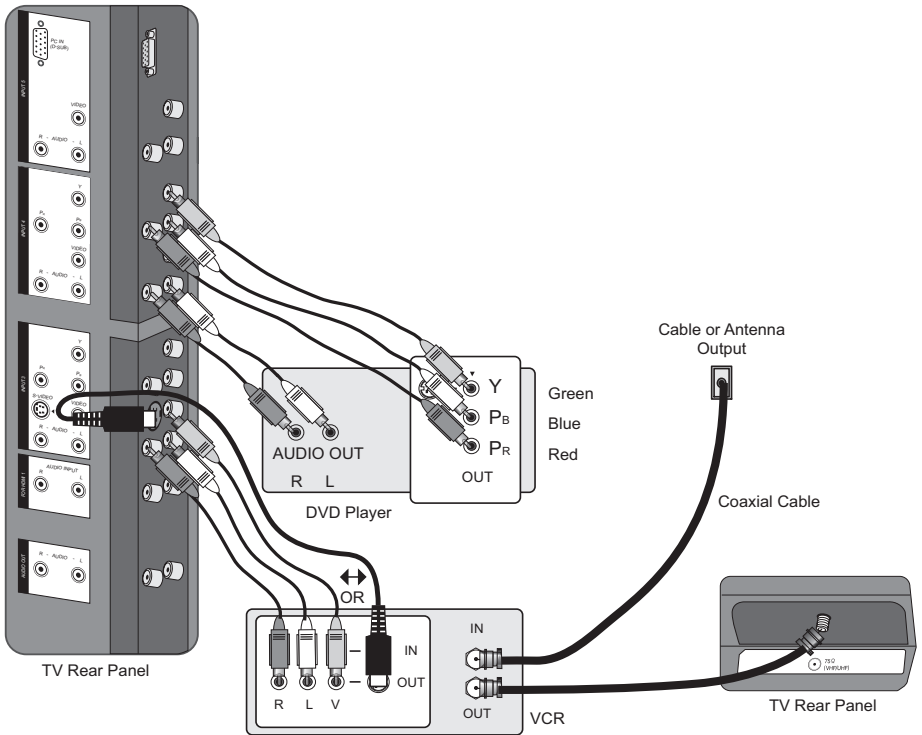

Note:

- If this connection setup does not work for you, try the connection setup on page 15.

Diagram #2

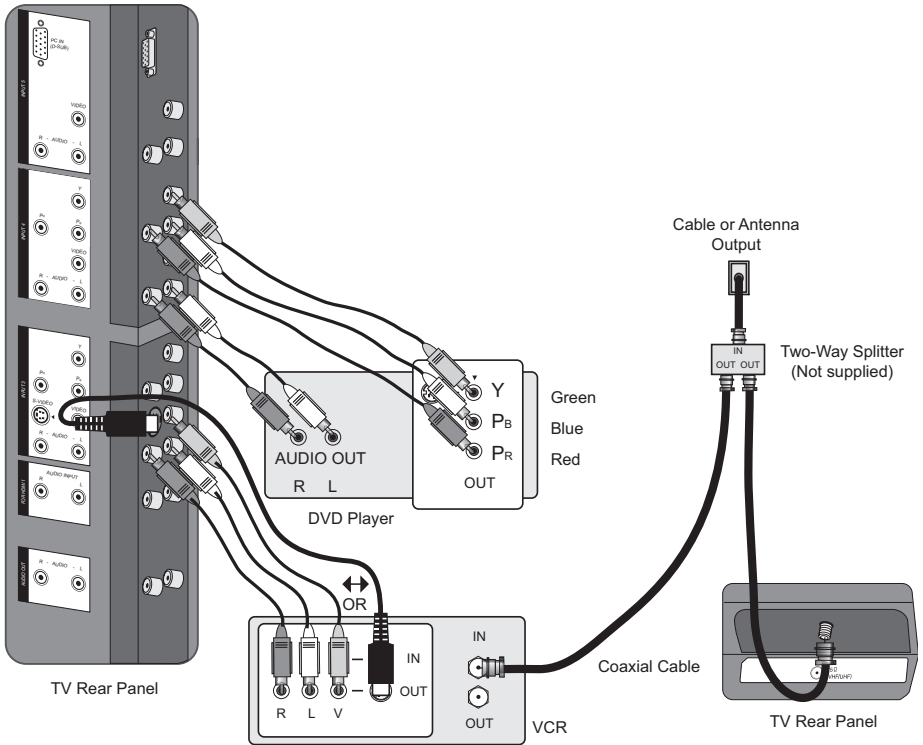

Quick Setup

Connecting to a Camcorder

You can connect a camcorder to your television by using the input jacks located on the back of the TV.

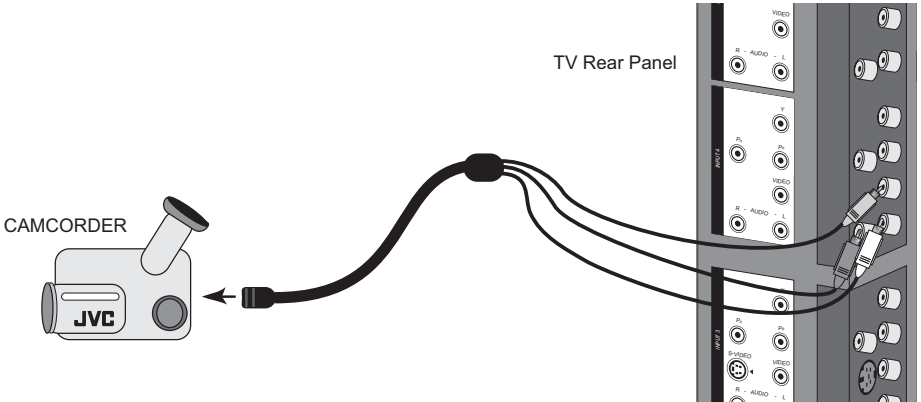

- 1) Connect a yellow composite cable from the camcorder VIDEO OUT to the VIDEO IN on the back of the TV.
- 2) Connect a white cable from the camcorder LEFT AUDIO OUT to the LEFT AUDIO IN on the back of the TV.
- 3) Connect a red cable from the camcorder RIGHT AUDIO OUT to the RIGHT AUDIO IN on the back of the TV.

Connecting to an External Amplifier

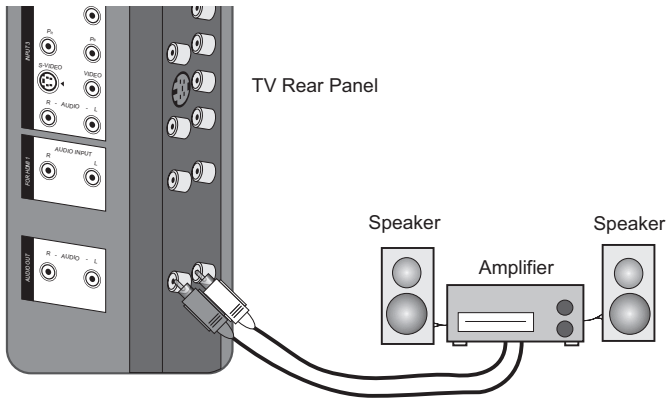

- 1) Connect a white cable from the LEFT AUDIO OUTPUT on the back of the TV to the LEFT AUDIO INPUT on the amplifier.
- 2) Connect a red cable from the RIGHT AUDIO OUTPUT on the back of the TV to the RIGHT AUDIO INPUT on the amplifier.

Notes:

- Refer to your amplifier's manual for more information.
- You can use AUDIO OUTPUT for your home theater system.
- If you have a device connected to INPUT-1, INPUT-2 or INPUT-5 (set "V5 INPUT" in the INITIAL SETUP menu to "HDMI"). You will not be able to hear any audio from the AUDIO OUT on the back of the TV.

Quick Setup

Connecting to a Digital TV Receiver

By connecting a Digital TV Receiver, high definition pictures can be displayed on your TV in their digital form.

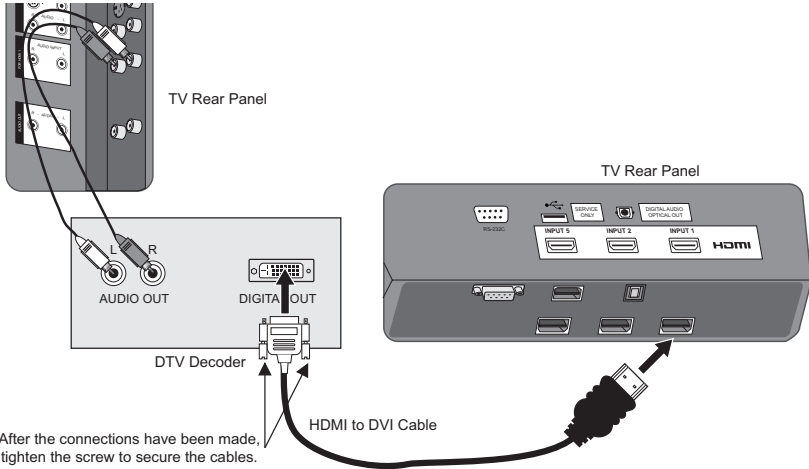

- 1) Connect the HDMI to DVI Cable from the DIGITAL OUT on the back of your DTV decoder to the HDMI INPUT-1 on the back of the TV.
 - 2) Connect a red cable from the DTV decoder RIGHT AUDIO OUT to the RIGHT AUDIO INPUT HDMI AUDIO IN "R" on the back of the TV.
 - 3) Connect a white cable from the DTV decoder LEFT AUDIO OUT to the LEFT AUDIO INPUT HDMI AUDIO IN "L" on the back of the TV.
- Personal computer compatibility cannot be guaranteed.
 - Use an HDMI to DVI cable (commercially available) in order to digitally connect the television with a DTV decoder.

Notes:

- If 480p signals (640x480 or 720x480) are displayed on the screen, the horizontal balance may be slightly shifted. Access the "HDMI SIZE" in the INITIAL SETUP menu to adjust it. (Refer to page 30.)
- When you do the above connection, set "VIDEO-1 AUDIO" in the INITIAL SETUP menu to "ANALOG". See "VIDEO-1 AUDIO", page 30.
- The Analog Audio input can only be used with the HDMI INPUT-1.
- When setting the "VIDEO-1 AUDIO - ANALOG/DIGITAL" menu setting on the TV, please note that this setting only effects the HDMI INPUT-1 jack and that if you use a DVI to HDMI adapter this connection must be made to the HDMI INPUT-1 along with analog audio cables.

Connecting to an HDMI Compatible Device

By connecting an HDMI compatible device, high definition pictures can be displayed on your TV in their digital form. Some HDMI devices can include DVD players, D-VHS or other HDMI compatible device.

HDMI (High Definition Multimedia Interface) is the first industry supported, uncompressed, all digital audio/video interface. HDMI provides an interface between any audio/video source, such as a set-top box, DVD player, A/V receiver or an audio and/or video monitor, such as a digital television (DTV).

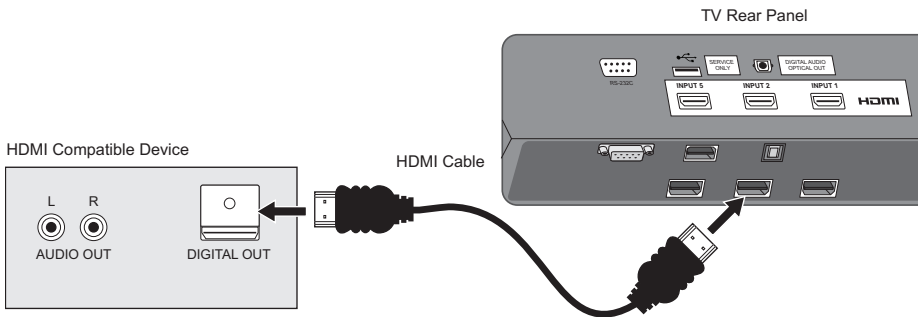

- 1) Connect the HDMI Cable from the DIGITAL OUT on the back of your DTV or HDMI device to the HDMI INPUT-1 on the back of the TV.

Notes:

- When you do the above connection, set "VIDEO-1 AUDIO" in the INITIAL SETUP menu to "DIGITAL". See "VIDEO-1 AUDIO", page 30.
- Some decoders may not respond depending on the equipment that is connected to the HDMI.
- If the HDMI output device signal is changed (for example, 480i/60Hz is changed to 480p/60Hz), the screen may turn green and there may be some distortion for a short time until the signal becomes stable.
- This TV can accept 480i, 480p, 720p, 1080i and 1080p signals via HDMI.
- This JVC television can accept a variety of HD signals, including 720/60p, 1080/60i and 1080/60p. It does not accept a 1080/24p signal. Please note that in some cases, a Blu-ray or HD-DVD may only offer the choice of 1080/60i or 1080/24p. In this case, it is necessary to choose the 1080/60i output. Please refer to your Blu-ray/HD-DVD manual for complete details on choosing the correct output.

Quick Setup

Connecting to an amplifier using your optical output

You can connect an amplifier that has an optical digital input terminal by using an optical digital cable from the optical output. The signal that is output can be PCM or DOLBY DIGITAL.

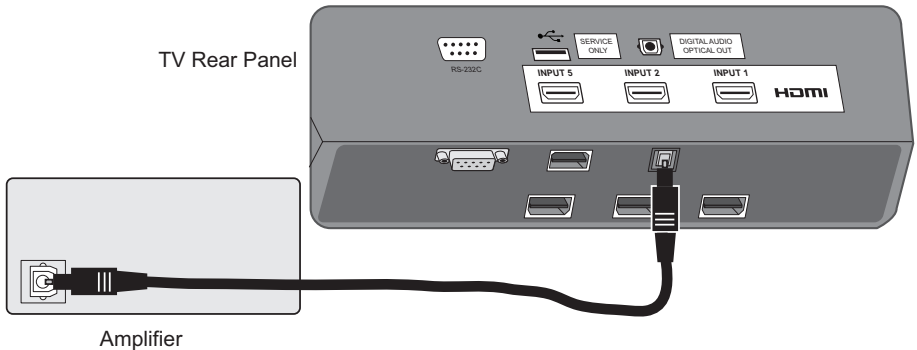

- 1) Connect the optical cable from underneath the television to the back of the amplifier.

Notes:

- This terminal can only output digital audio.
- In order to use the optical output connection, select PCM or DOLBY DIGITAL on Digital Sound in the DIGITAL SETUP Menu. See page 48.
- Refer to your owners manual on using your amplifier.
- You cannot output sound from your Optical Output connection if the audio source is from your HDMI device.

Connecting to an AV Receiver using your television's V3 Smart Input

By connecting your AV Receiver to your television's V3 Smart Input, you can watch picture sources from many different devices, without having to change or use the other input connections on your TV. This allows you to free up the other input connections so you can connect more devices to your television.

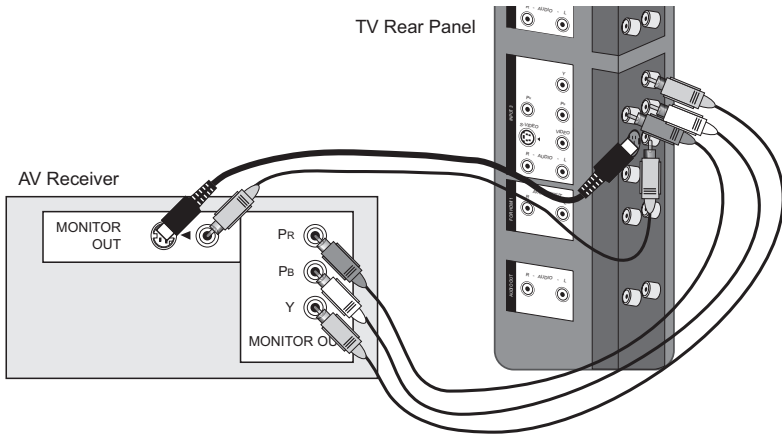

- 1) Connect an S-Video Cable from the AV Receiver's MONITOR OUT to the S-Video INPUT-3 on the back of the TV.
- 2) Connect a Yellow Composite Cable from the AV Receiver's MONITOR OUT to the VIDEO INPUT-3 on the back of the TV.
- 3) Connect a Green Component Cable from the AV Receiver's Y MONITOR OUT to the Y VIDEO INPUT-3 on the back of the TV.
- 4) Connect a Blue Component Cable from the AV Receiver's Pb MONITOR OUT to the Pb VIDEO INPUT-3 on the back of the TV.
- 5) Connect a Red Component Cable from the AV Receiver's Pr MONITOR OUT to the Pr VIDEO INPUT-3 on the back of the TV.

Notes:

- Please refer to your AV Receiver instruction manual for more information on connecting your speakers and other devices like a DVD player.
- Use your AV Receiver's remote to switch to the different devices you have connected.
- Some AV Receivers may not respond when the V3 Smart Input function is turned on.
- If you have video connections for each input device connected to your AV Receiver, you should not connect them using both S-Video and Composite connection at the same time when you are using V3 Input as the V3 Smart Input. In this case we recommend using the S-Video connection.

Table of signals for each type of computer

Resolution	Vertical Frequency (Hz)	Horizontal Frequency (kHz)
640 x 480 (VGA)	60.0	31.5
1024 x 768 (XGA)	60.0	48.4

- Only the above formats are supported.
- Even with the above formats at 60 Hz, some problems may be experienced depending on the quality of the synchronous signal. (Depending on the quality, some pictures may not be displayed correctly).
- Apple Macintosh* computers are not supported.

When a picture is not displayed

With some computers, some problems can be solved by changing the settings. Check the computer's refresh rate and set it to 60Hz. Computers that cannot set the refresh rate to 60 Hz, cannot be used with this TV. Refer to the computer's instruction manual.

*Apple Macintosh is a registered trademark of Apple Inc.

Note:

- If you are inputting a PC signal that is invalid, "Invalid Signal" will appear on the TV screen. It appears when the input is PC and it is a single screen.

Quick Setup

Step 3 – The Interactive Plug In Menu

When you turn your television on for the first time the interactive plug in menu will appear. The plug in menu helps you to get your TV ready to use by letting you set your preferences for:

- The language in which you want the onscreen menus to appear.
- Setting the TV's clock to the correct time so your timer functions will work properly. You can choose "AUTO" or "MANUAL" for setting the clock.
- The auto tuner setup of which channels you wish to receive.

We recommend you complete the interactive plug in items before you start using your television.

Notes:

- The interactive plug in menu setting does not appear if your TV has been turned on before. In this case use the onscreen menus to perform these settings. See pages 34, 56, 37.
- If you press the Menu button while setting up the interactive plug in menu, it will skip over it.

Language

After the "JVC INTERACTIVE PLUG IN MENU" has been displayed, the TV automatically switches to the LANGUAGE settings. You can choose to view your onscreen menus in three languages: ENGLISH, FRANÇAIS (French) or ESPAÑOL (Spanish).

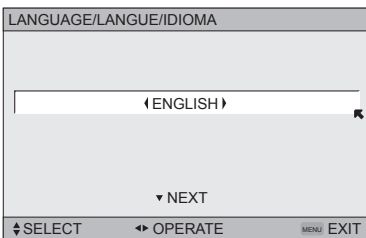

To choose a language:
ENGLISH, FRANÇAIS or ESPAÑOL



To NEXT (To set clock)

(Continued...)

Auto Clock Set

Before you use any of your TV's timer functions, you must first set the clock. You may precisely set your clock using the XDS time signal broadcast by most public analog broadcasting stations. If you do not have this in your area, you will have to set the clock manually. See manual clock set below. To set the clock using the XDS signal:

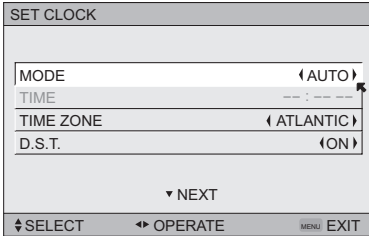

- ◀▶ To choose AUTO
- ▼ To TIME ZONE
- ◀▶ To select your time zone: (Atlantic, Eastern, Central, Mountain, Pacific, Alaska or Hawaii)
- ▼ To move to D.S.T. (Daylight Savings Time)
- ◀▶ To turn D.S.T. ON or OFF
- ▼ To NEXT (To Auto Tuner Setup)

Notes:

- D.S.T. can be used when it is set to ON in the SET CLOCK menu.
- Only when the MODE is set to AUTO, the Daylight Saving Time feature automatically adjusts your TV's clock for Daylight Saving.
- The real time and D.S.T. may not be set correctly depending on the broadcasting signal and receiving conditions. In this case, set your clock manually and turn D.S.T. to OFF.
- You will have to reset the clock after a power interruption. You must set the clock before operating any timer functions.

Manual Clock Set

To set your clock manually (without using the XDS signal), choose MANUAL. If you choose AUTO, see auto clock set above.

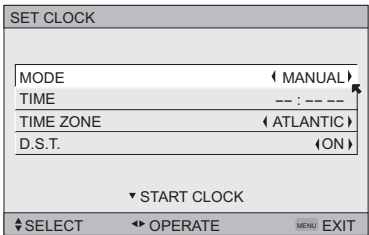

- ◀▶ To choose MANUAL
- ▼ To TIME
- ◀▶ To set the hour
- ▼ To minute
- ◀▶ To set the minute
- ▼ To TIME ZONE
- ◀▶ To select your time zone: (Atlantic, Eastern, Central, Mountain, Pacific, Alaska or Hawaii)
- ▼ To move to D.S.T. (Daylight Savings Time)
- ◀▶ To turn D.S.T. ON or OFF
- ▼ To START CLOCK

Note:

- You will have to reset the clock after a power interruption. You must set the clock before operating any timer functions.

(Continued...)

Quick Setup

Auto Tuner Setup

In auto tuner setup, the TV automatically scans through all available channels, memorizing the active ones and skipping over blank ones or channels with weak signals. This means when you scan (using the CHANNEL +/- buttons) you will receive only clear, active channels.

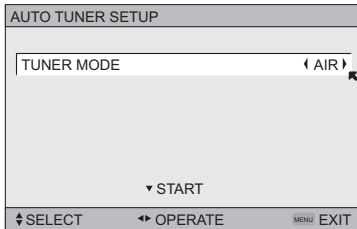

To choose CABLE or AIR (or SKIP when you skip Auto Tuner Setup)



To START

After Analog Auto Tuner Setup is finished, Digital Auto Tuner Setup starts.

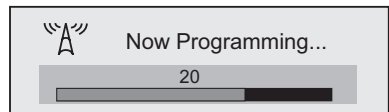

When the setup is finished, "THANK YOU ! SETUP IS NOW COMPLETE" is displayed. Your quick setup is now complete. You can now begin watching your television, or you can continue on in this guide for more information on programming your remote control, or using the JVC onscreen menu system to customize your television viewing experience.

Notes:



- If you want to cancel the Auto Tuner Setup, press the MENU button.
- Noise Muting will not work during Auto Tuner Setup.
- If you choose SKIP, it finished without doing the Auto Tuner Setup.

Cable Box and Satellite Users: After your auto tuner setup is complete, you may, (depending on the type of hookup), have only 1 channel, usually 3 or 4 in the auto tuner memory. This is normal.

Onscreen Menus

Using the Guide

Certain symbols are used throughout this guide to help you learn about the features of your new television. The ones you will see most frequently are:

- ▲▼ Up and Down arrows mean:
 - Move vertically in a main menu screen
 - Move through a submenu screen
 - Move to the next letter, number, or other choice in a submenu
- ◀▶ Left and right arrows mean:
 - Select a highlighted menu item
 - Select an item in a submenu
 - Select numbers in certain menu options
-  The “press button” icon means you should press the button named on your remote control. (Button names appear in SMALL CAPITAL LETTERS.)
-  The “helping arrow” icon points to the highlighted or selected item in a menu.

To bring up the onscreen menu, press the MENU button on the remote control. The item that appears in green is the one currently selected. If you use the Menu button on the TV's side panel instead of the remote, an additional menu screen showing VIDEO STATUS and ASPECT will appear between INITIAL SETUP and PICTURE ADJUST. The “INTERACTIVE PLUG IN MENU” will appear the first time the TV is plugged in.

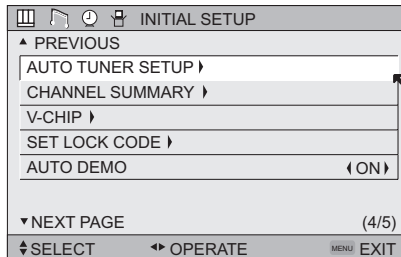

Note:

- Menus shown in this book are illustrations, not exact replications of the television's onscreen displays.

Onscreen Menus

The Onscreen Menu System

Your television comes with JVC's onscreen menu system. The onscreen menus let you make adjustments to your television's operation simply and quickly. Examples of the onscreen menus are shown on the next page. Detailed explanations on using each menu follow later in this guide. For information about the interactive plug in Menu, see pages 24 - 26.

The Onscreen Menu System

To open the onscreen menu system, press the MENU button on the remote control. You navigate within the onscreen menus by using the four directional arrow buttons on the remote control.

The selected feature and option on a menu screen are highlighted in a different color.

Selected Feature (Green)



Selected Option (Blue)

To move to a different feature use the ▲ ▼ arrows to move up or down the list. When you press the up arrow at the top of the list or the down arrow at the bottom, the next menu screen will appear. Use the arrows ◀ ▶ to select an option from the highlighted feature. Pressing MENU on the remote control will close the onscreen menu system and return you to normal television viewing.

Each menu and its features will be discussed in the following pages of this guide.

Notes:

- If you do not press any buttons for about a minute, the onscreen menu will automatically shut off.
- Button names in this guide are shown in SMALL CAPITAL LETTERS.
- Menus may appear in different sizes onscreen depending on the aspect ratio selected.
- Some menu items may not appear in menu screens when certain aspect ratios or inputs are selected.

Onscreen Menus



Press the Menu button

To **CLOCK/TIMERS**

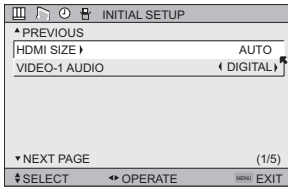

INITIAL SETUP 01

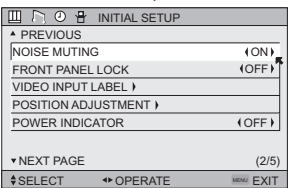

INITIAL SETUP 02

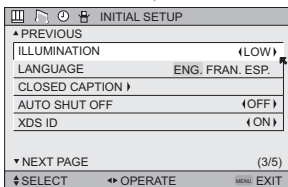

INITIAL SETUP 03

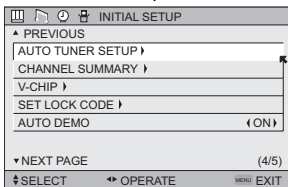

INITIAL SETUP 04

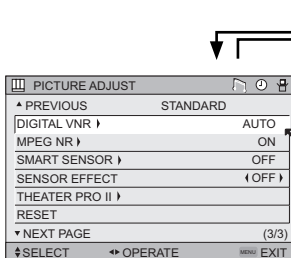

PICTURE ADJUST 03

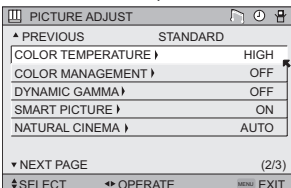

PICTURE ADJUST 02

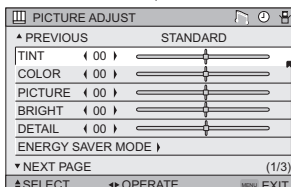

PICTURE ADJUST 01

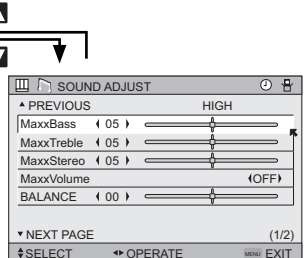

SOUND ADJUST 01

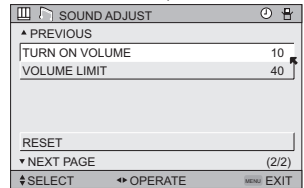

SOUND ADJUST 02

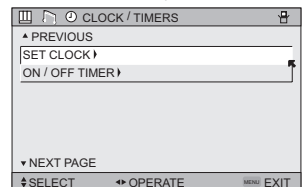

CLOCK/TIMERS



To **INITIAL SETUP 01**

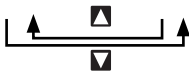

Notes:

- The HDMI SIZE menu can only be displayed when a 480p picture signal is input to the HDMI terminal and the picture is being displayed on the screen.
- SMART PICTURE menu cannot be selected when the Video Status mode is DYNAMIC.
- DETAIL menu cannot be selected when the Video Status mode is THEATER.
- When the Menu button on the TV side panel is pressed, the FRONT PANEL CONTROL menu between INITIAL SETUP 05 and PICTURE ADJUST 01 will appear.

Initial Setup Menus

HDMI Size

The HDMI SIZE option can only be selected in the INITIAL SETUP menu when an HDMI 480p picture signal is being input to the HDMI terminal. This option adjusts the position when an HDMI or DVI 480p picture signal is being displayed on the screen. There are two types of HDMI 480p picture signals: 640x480 and 720x480. If the displayed picture is slightly shifted, the position can be adjusted by selecting AUTO, SIZE1 or SIZE2.



Press the MENU button



To HDMI SIZE



To enter



To select AUTO, SIZE1 or SIZE2



Press the MENU button to finish

HDMI SIZE
AUTO
SIZE1
SIZE2

Notes:

- The HDMI SIZE menu can only be selected when a HDMI or DVI 480p picture signal is input to the HDMI terminal and the picture is being displayed on the screen.
- You can select AUTO only when the signal is 480p for HDMI. When you select AUTO, the television will select "SIZE1" or "SIZE2" automatically.

Video-1 Audio

This feature is used if you have a DVI or HDMI compatible component connected to your TV.



Press the MENU button



To VIDEO-1 AUDIO



To select ANALOG, DIGITAL or AUTO



Press the Menu button when finished

INITIAL SETUP	
▲ PREVIOUS	
HDMI SIZE	AUTO
VIDEO-1 AUDIO	◀ DIGITAL ▶
▼ NEXT PAGE	(1/5)
⬆ SELECT	▶ OPERATE MENU EXIT

Notes:

- If your DVI or HDMI component is capable of digital audio and video, choose DIGITAL. If your DVI or HDMI component is capable of analog audio and digital video, choose ANALOG.
- Refer to your DVI or HDMI component's instruction manual for more information.
- When you select AUTO, the television will select "ANALOG" or "DIGITAL" automatically, depending on the audio input from the HDMI.

Initial Setup Menus

Noise Muting

This feature inserts a blank gray screen over channels which are not broadcasting or are too weak to be received clearly.



Press the MENU button



To NOISE MUTING
To turn ON or OFF



Press the MENU button when finished

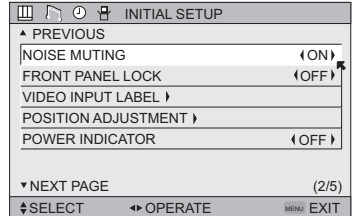

Notes:

- Noise muting will not work during auto tuner setup or when you operate channel summary.
- Noise muting will not work when the digital TV is displayed.

Front Panel Lock

This allows you to lock the keys on the side of the TV, so that a child may not accidentally change your viewing preferences.



Press the MENU button



To FRONT PANEL LOCK
To turn ON or OFF



Press the MENU button when finished

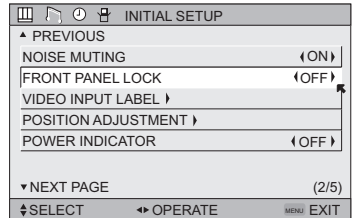

You can turn off this feature in the following ways:

- Use the remote control.
- Press the MENU button on the side of the TV for more than 3 seconds. In this case, the OSD for FRONT PANEL LOCK will appear.
- Unplug the power cord, and plug it back in. Do this if your batteries die or you lose your remote control.

Note:

- To turn ON/OFF the TV, press the POWER button for more than 3 seconds. This feature will remain ON.

Initial Setup Menus

Video Input Label

This function is used to label video input connections for the onscreen displays.



Press the MENU button



To VIDEO INPUT LABEL



To enter



To select the desired video input



To select the desired preset input label (see chart below)



Press the OK button to save



Press the MENU button when finished

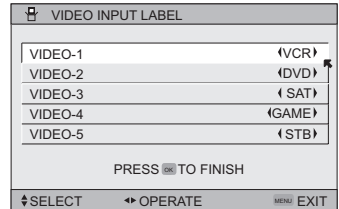

Preset Labels	Select when...
VCR	You have a VCR connected to the video input
DVD	You have a DVD connected to the video input
PVR	You have a Personal Video recorder connected to the video input
DVHS	You have a Digital VCR connected to the video input
STB	You have a Set-top Box connected to the video input
SAT	You have a Satellite Receiver connected to the video input
AMP	You have an Amplifier connected to the video input
GAME	You have a Video Game connected to the video input
CAM	You have a Video Camera connected to the video input
DISC	You have a Video Disc player connected to the video input

Initial Setup Menus

Position Adjustment

Position adjustment allows you to adjust the position of the picture on the screen vertically when the aspect is set to panorama or cinema.



Press the MENU button



To POSITION ADJUSTMENT



To enter



To adjust the position



Press the MENU button to finish

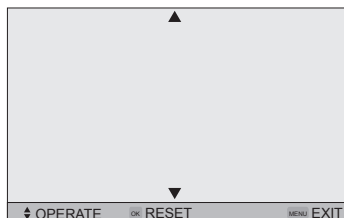

Notes:

- To reset the adjustment to the center, press the Ok button.
- When the arrow disappears, while you are adjusting the position, the position is at its maximum limit.
- If you select REGULAR, SLIM, FULL or FULL NATIVE size with aspect or Multi Screen, position adjustment option is not selected.
- When you change the screen size, perform the position adjustment again.
- Position adjustment allows you to adjust the screen position vertically and horizontally when the aspect is set Panorama Zoom or Cinema Zoom for 1080i and 720p signals, or when PC mode is set.
- It is also possible to use Position Adjustment when you are in PC Mode
- When you are receiving a 1080p signal, Position Adjustment cannot be selected.

Power Indicator

Power indicator allows you to adjust the brightness of the power indicator.



Press the MENU button



To POWER INDICATOR



To turn LOW, HIGH or OFF



Press the MENU button to finish

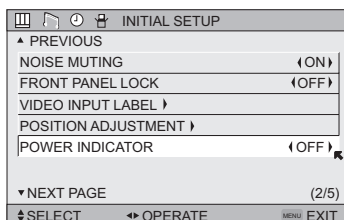





Notes :

- When OFF is selected :
The LED disappears if you have a TV signal.
The LED is lit as "LOW" when there is no TV signal.
- When the On Timer turns ON, the LED is lit as "LOW" when you turn the power off.
- If you set a timer on the TV, the power indicator will light even if the TV is on stand by.

Initial Setup Menus

Illumination



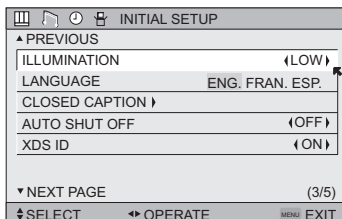

The illumination feature allows you to adjust the brightness of the light on the front of the television. When you turn the power on the television, the front panel light remains on when illumination is set to LOW or HIGH.

-  Press the Menu button
-  To ILLUMINATION
-  To choose HIGH, LOW or OFF
-  Press the MENU button when finished



Language

The language function is described on page 24 as the interactive plug in menu. If you need to choose the language again, follow the steps below.



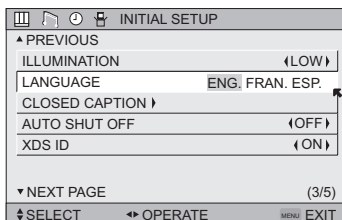





-  Press the Menu button
-  To LANGUAGE
-  To choose a language: ENG. (English), FRAN. (French) or ESP. (Spanish)
-  Press the MENU button when finished



Closed Caption

Many broadcasts now include an onscreen display of dialog called closed captions. Some broadcasts may also include displays of additional information in text form. Your television can access and display this information using the closed caption feature. To activate the closed caption feature, follow the steps below. There are three methods. When you are watching analog channels, you can perform Analog Setting of closed caption. When you are watching digital channels, you can perform Digital Auto Setting or Digital Manual Setting.

Analog Setting

-  Press the MENU button
-  To CLOSED CAPTION
-  To enter
-  To MODE
-  To select CAPTION or TEXT in MODE
-  To CAPTION or TEXT
-  To select a caption (CC1 to CC4) or text channel (T1 to T4)
-  Press the Ok button to save
-  Press the MENU button when finished

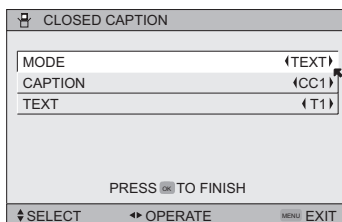

Initial Setup Menus

Digital Auto Setting



Press the MENU button



To CLOSED CAPTION



To enter



To Type



To select Auto, Advanced or Basic

Auto: Shows closed caption a priority for digital channels over analog channels. It is set automatically.

Advanced: Shows only the digital closed caption.

Basic: Shows only the analog closed caption.



To Service



To select 1, 2, 3, 4, 5 or 6



To Appearance



To enter



To select Auto ("Manual, see page 36)



To Set



Press the Ok button to save

The font/type and color are set automatically.



To Set



Press the Ok button to save



Press the MENU button when finished

Note:

- If you want to cancel the settings, select cancel.

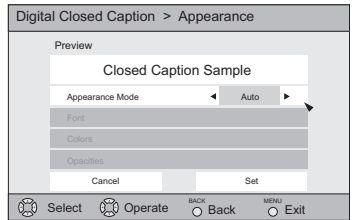
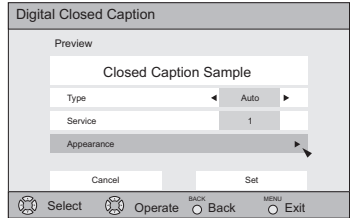

Initial Setup Menus

Digital Manual Setting



Press the MENU button



To CLOSED CAPTION



To enter



To Appearance



To select Manual for Appearance Mode



To Font



To enter



To select Font Size or Font Style



To select the setting you like

Font Size: Auto, Standard, Large or Small

Font Style: Auto, Serif Mono, Serif, SanSerif Mono, SanSerif, Casual, Cursive or Small Capital



To Set

Press the Ok button to save



To Colors



To enter



To select Text, Edge or Background



To select the setting you like

Auto, White, Black, Red, Green, Blue, Yellow, Magenta or Cyan



To Set

Press the Ok button to save



To Opacities



To enter



To select Text/Edge or Background



To select Auto, Transparent, Translucent, Solid or Flashing



To Set

Press the Ok button to save



To Set

Press the Ok button to save



To Set

Press the Ok button to save



Press the MENU button when finished

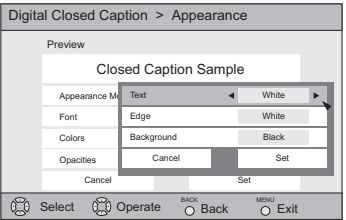
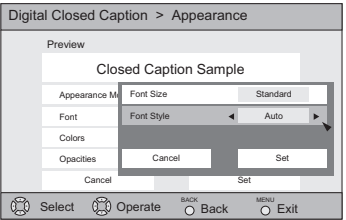
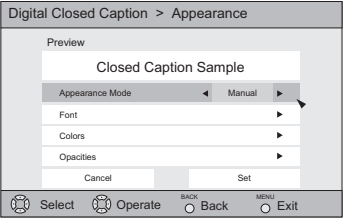

All fonts used for digital closed caption and digital menus are licensed from Monotype Imaging Inc.

Notes:

- Closed caption subtitles are usually found on closed caption channel CC1. Some programs may include additional text information which is usually found on text channel T1. The other channels are available for future use.
- Closed captioning may not work correctly if the signal being received is weak or if you are playing a video tape.
- Most broadcasts containing closed captioning will display a notice at the start of the program.
- To select the mode, press the C.C. button. See page 65.
- When ZOOM aspects like PANORAMA or CINEMA are selected, Digital Closed Captions may be cut off or distorted.

Initial Setup Menus

Auto Shut Off

This function automatically shuts off your TV when there is no signal from the channel or no operation while the TV is on for 10 minutes.



Press the MENU button



To AUTO SHUT OFF



To turn ON or OFF



Press the MENU button when finished

- If the channel that you have on does not receive a signal for more than one minute, the blinking text "NOT RECEIVING A SIGNAL AUTO SHUT OFF IN 9 MIN." appears on the screen, and starts the countdown. If no signal is being received within 10 minutes, the TV shuts itself off.

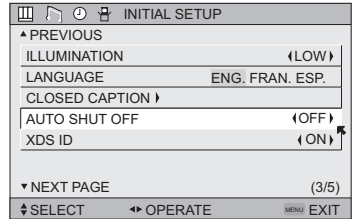

XDS ID

XDS ID Display provides a channel's call letters, the network's name, and even a program name. The XDS ID information is provided by the broadcaster.



Press the MENU button



To XDS ID



To turn ON or OFF



Press the MENU button when finished

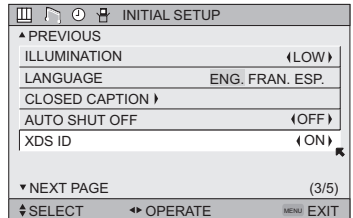

Auto Tuner Setup

The auto tuner setup function is described on page 26 as the interactive plug in menu. If you need to run the auto tuner setup again, follow the steps below.



Press the MENU button



To AUTO TUNER SETUP



To operate



To choose CABLE or AIR



To START



To start the setup

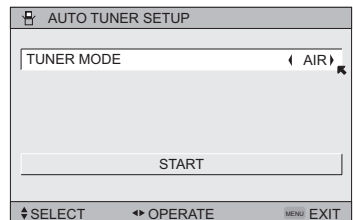

The auto tuner is finished when the message **PROGRAMMING OVER!** appears onscreen.



Press the Menu button when finished

Initial Setup Menus

Channel Summary

Channel summary allows you to customize the line-up of channels received by your TV. Regarding analog channels, you can add or delete channels from the line-up or prevent any unauthorized viewers from watching any or all 181 channels. Regarding digital channels, the only channels that will appear are the ones that are broadcasting.



Press the MENU button



To CHANNEL SUMMARY



To operate

The Channel summary screen will now be displayed with the channels set to scan marked with an "√". Regarding analog channels, you can delete channels from the scan by removing the "√". If any channels were missed during auto tuner setup and you wish to add them, you may be placing an "√" next to the channel number.

- Digital channels cannot be added to the channel summary if the auto tuner setup did not find them.



To the SCAN column



Press the Ok button to include or delete from scan



Press the MENU button when finished

Analog Channels

CHANNEL SUMMARY							
CHNO.	SCAN	ID	LOCK	CHNO.	SCAN	ID	LOCK
01				06	✓	HBO	
02	✓	MTV		07	✓	L	
03				08			
04	✓	A&E		09	✓		
05	✓	E!		10			

SELECT OPERATE EXIT

Digital Channels

Channel Summary Digital				
CH No.	Scan	Station Name	LOCK	
D01		FOX		
D02	✓	ABC		
D02		CNN		
D10-1	✓	NBC	✓	
D10-2		BOX		
D12345	✓	NHK		

Select Operate Back Exit

Note:

- The number of a digital channel may change, depending on the time of some broadcastings. If this channel existed and now has disappeared, the lock channel or scanned channel mark by the channel summary for that channel will be cancelled.

Initial Setup Menus

How to set the channel label. *(This is only for analog broadcasting.)*



Press the MENU button



To CHANNEL SUMMARY



To operate



To the ID column



Press the Ok button to enter



To select the character you want



To move to the next space

...continue to follow these directions for all four spaces



Press the Ok button to finish

Your characters are now set



Press the MENU button when finished

If you want to reset the characters you set:



Press the MENU button



To CHANNEL SUMMARY



To operate



To the ID column



Press the Ok button to enter



To select RESET



Press the Ok button to finish

Your characters are now reset

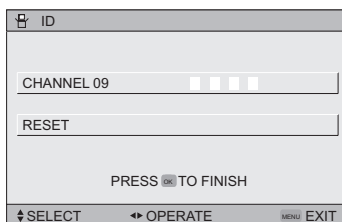

Notes:

- You can use characters for: Alphabet, numbers, marks and spaces.
- It is possible to set the maximum of 40 channel labels.
- If you try to set more than the 40 maximum, the message "MEMORY OVERFLOW" will appear.

You can block access to a channel by activating the channel lock.



Press the MENU button



To CHANNEL SUMMARY



To operate



To the Lock Column ()



Press the ZERO button to lock or unlock that channel



Press the MENU button when finished

Initial Setup Menus

Channel Guard Message

When a viewer attempts to watch a guarded channel, the following message appears:

To watch a channel that you have locked, enter the Lock Code using the 10 key pad.
If the wrong code is entered, the message "INVALID LOCK CODE!" will flash on the screen.

The channel cannot be accessed until the correct code is entered.

THIS CHANNEL IS LOCKED BY
CHANNEL GUARD.
PLEASE ENTER LOCK CODE BY
10 KEY PAD TO UNLOCK IT.

NO. - - - -

Notes:

- Once a channel has been unlocked, it will remain unlocked until the television is turned off.
- See also "Set Lock Code", page 46.

V-Chip

Your TV is equipped with V-Chip technology which enables you to block channels or content that you feel to be inappropriate for children, based on US and Canada rating guidelines. V-Chip has no effect on video signals from DVD discs or Camcorder connection.

Note: Some programs, and movies are broadcast without a ratings signal. Even if you set up V-CHIP ratings limits, these programs will not be blocked. See page 41 for information on how to block unrated programs.

Note (for Canadian viewers): The V-Chip function is based on specifications designed for the United States and therefore may not work properly in Canada.

You can customize the V-Chip settings of your television to match your personal tastes. The V-Chip menu below is the starting point for your V-Chip settings

You can use US V-Chip settings (for programming broadcast from the United States), Canadian V-Chip settings (for programming broadcast from Canada), and movie ratings. You may use any or all of the settings (US V-Chip, Canada V-Chip, Movie ratings). Descriptions for setting each of the three V-Chip formats appear in the next six pages along with descriptions of the rating categories.

To access the rating categories:



Press the MENU button



To V-CHIP



To operate (Lock icon  will appear)



Press ZERO to access the V-Chip menu



To turn V-Chip ON or OFF (V-Chip must be turned ON for rating settings to operate)



To move to SET US TV RATINGS, SET MOVIE RATINGS, or SET CANADIAN RATINGS (see following pages for descriptions of each item)

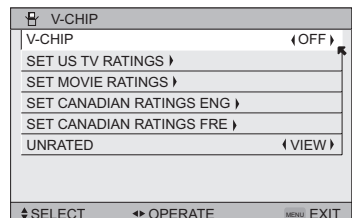

Initial Setup Menus

Unrated Programs

Unrated programming refers to any programming which does not contain a rating signal. Programming on television stations which do not broadcast rating signals will be placed in the "Unrated Programming" category.

Examples of Unrated programs:

- Emergency Bulletins
- News
- Public Service Announcements
- Sports
- Some Commercials
- Locally Originated Programming
- Political Programs
- Religious Programs
- Weather

Note:

- TV programs or movies that do not have rating signals will be blocked if the unrated category is set to BLOCK.

Directions to Block Unrated Programs

You can block programs that are not rated.



Press the MENU button



To V-CHIP



To operate (The lock icon  appears)



Press ZERO to access V-Chip setup options



To UNRATED



To VIEW or BLOCK



Press MENU when done

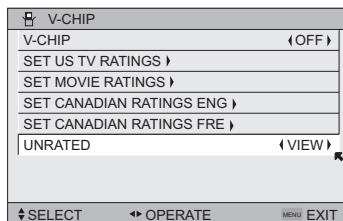

Initial Setup Menus

US V-Chip Ratings

U.S. PARENTAL RATING SYSTEMS

Programs with the following ratings are appropriate for children.

TV Y is Appropriate for All Children

Programs are created for very young viewers and should be suitable for all ages, including children ages 2 - 6.

TV Y7 is for Older Children

Most parents would find such programs suitable for children 7 and above. These programs may contain some mild fantasy violence or comedic violence, which children should be able to discern from reality.

Programs with the following ratings are designed for the entire audience.

TV G stands for General Audience

Most parents would find these programs suitable for all age groups. They contain little or no violence, no strong language, and little or no sexual dialog or situations.

TV PG Parental Guidance Suggested

Programs may contain some, but not much, strong language, limited violence, and some suggestive sexual dialog or situations. It is recommended that parents watch these programs first, or with their children.

TV 14 Parents Strongly Cautioned

Programs contain some material that may be unsuitable for children under the age of 14 including possible intense violence, sexual situations, strong coarse language, or intensely suggestive dialog. Parents are cautioned against unattended viewing by children under 14.

TV MA Mature Audiences Only

These programs are specifically for adults and may be unsuitable for anyone under 17 years of age. TV MA programs may have extensive V, S, L, or D.

Viewing Guidelines

In addition to the ratings categories explained above, information on specific kinds of content are also supplied with the V-Chip rating. These types of content may also be blocked. The content types are:

- **V/FV** is for VIOLENCE/FANTASY VIOLENCE
- **S** stands for SEXUAL CONTENT
- **L** stands for strong LANGUAGE
- **D** stands for suggestive DIALOG

Initial Setup Menus

Setting US V-Chip Ratings



Press the MENU button



To V-CHIP



To operate (lock icon  appears)



Press ZERO to access the V-Chip menu



To turn V-Chip ON or OFF





To move to SET US TV RATINGS

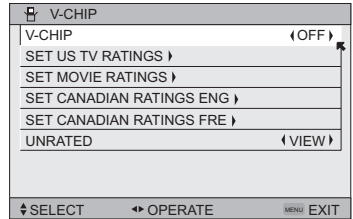

To operate



Directions to set US V-Chip Ratings

Line up the cursor in the column (TV PG, TV G, etc.) with the content row (V/FV, S, etc.) and press the  or  to move the cursor to the correct location. Press Ok to turn the locking feature on or off. An item is locked if the  icon appears instead of a “—”.

For example: To block viewing of all TV 14 shows, move the cursor to the top row of that column and add a lock icon. Once you've put a lock on the top row, everything in that column is automatically locked.



To the TV 14 Column



Press the Ok button to lock



Press the MENU button when finished

Note:

- If you want to change the setup, move the cursor to the top column and change the lock icon to “—” by pressing OK again. You may then select individual categories to block.

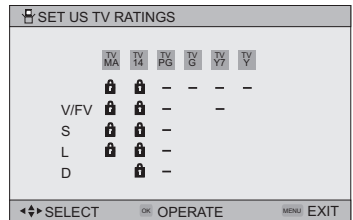

Initial Setup Menus

Movies Ratings

NR – Not Rated

This is a film which has no rating. In many cases these films were imported from countries which do not use the MPAA ratings system. Other NR films may be from amateur producers who didn't intend to have their film widely released.

NR (Not Rated) Programming may contain all types of programming including children's programming, foreign programs, or adult material.

G – General Audience

In the opinion of the review board, these films contain nothing in the way of sexual content, violence, or language that would be unsuitable for audiences of any age.

PG – Parental Guidance

Parental Guidance means the movie may contain some contents such as mild violence, some brief nudity, and strong language. The contents are not deemed intense.

PG-13 – Parents Strongly Cautioned

Parents with children under 13 are cautioned that the content of movies with this rating may include more explicit sexual, language, and violence content than movies rated PG.

R – Restricted

These films contain material that is explicit in nature and is not recommended for unsupervised children under the age of 17.

NC-17 – No One Under 17

These movies contain content which most parents would feel is too adult for their children to view. Content can consist of strong language, nudity, violence, and suggestive or explicit subject matter.

X – No One under 18

Inappropriate material for anyone under 18.

Directions to set Movie (MPAA) Ratings



Press the MENU button



To V-CHIP



To operate (Lock icon  appears)



Press ZERO to access V-Chip setup options



To SET MOVIE RATINGS



To enter movies menu

For example: To block viewing of programming rated NC-17 shows, move the cursor to the NC-17 column and add a lock icon. Once you've put a lock on the NC-17 column, X column is automatically locked.



To the NC-17 Column



Press the Ok button to lock



Press the MENU button to finish

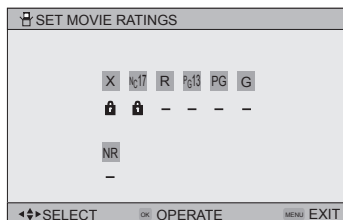

- If you want to change the setup, move the cursor to the column and change the lock icon to “—” by pressing Ok again.

Initial Setup Menus

Canadian V-Chip Ratings

E – Exempt

Exempt programming includes: news, sports, documentaries and other information programming, talk shows, music videos, and variety programming.

C – Programming Intended for Children

Violence Guidelines: There will be no realistic scenes of violence. Depictions of aggressive behavior will be infrequent and limited to portrayals that are clearly imaginary, comedic or unrealistic in nature.

C8+ – Programming Intended for Children 8 and Over

Violence Guidelines: Any realistic depictions of violence will be infrequent, discreet, of low intensity and will show the consequences of the acts. There will be no offensive language, nudity or sexual content.

G – General Audience

Programming will contain little violence and will be sensitive to themes which could affect younger children.

PG – Parental Guidance

Programming intended for a general audience, but which may not be suitable for younger children. Parents may consider some content not appropriate for children aged 8-13.

14+ – 14 Years and Older

Parents are strongly cautioned to exercise discretion in permitting viewing by pre-teens and early teens. Programming may contain mature themes and scenes of intense violence.

18+ – Adult

Material intended for mature audiences only.

Directions to set Canadian V-Chip Ratings



Press the MENU button



To V-CHIP



To operate (lock icon  appears)



Press ZERO to access V-Chip setup options



To SET CANADIAN RATINGS ENG (for English)



To enter ratings menu

For example: To block viewing of programming rated 14+ shows, move the cursor to the 14+ column and add a lock icon. Once you've put a lock on the 14+ column, 18+ column is automatically locked.



To the 14+ Column



Press the Ok button to lock



Press the MENU button to finish

Notes:

- If you want to change the setup, move the cursor to the column and change the lock icon to “—” by pressing Ok again.
- For instructions on “SET CANADIAN RATINGS FRE (in French)”, please see page 45 in the French user's guide.

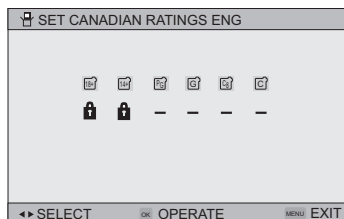

Initial Setup Menus

Set Lock Code

Channel guard and V-Chip settings are protected by a four-digit lock code. Your TV comes preset with a lock code of "0000". You may change the code to any four-digit number you wish. To change the lock code, follow the steps below.



Press the MENU button



To SET LOCK CODE



To operate (lock icon  appears)



Press ZERO to access the lock code

The first digit will be highlighted



To select the number



To move to the next digit

Continue to follow these directions for all four numbers



Press the OK button to finish (your lock code is now set)



Press the Menu button when finished

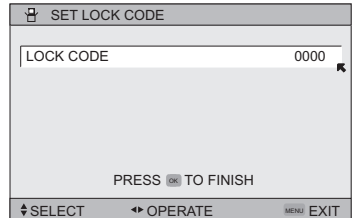

When a viewer attempts to watch a blocked channel, this message appears:

THIS PROGRAMMING EXCEEDS
YOUR RATING LIMITS.
PLEASE ENTER LOCK CODE BY
10 KEY PAD TO UNLOCK IT.
NO. ----

The channel will remain blocked until the correct lock code is entered (see above for information on setting your lock code).

Notes:

- After a power interruption you must reset the lock code.
- Write your lock code number down and keep it hidden from potential viewers.
- If you forget the lock code, a new code may be set using the steps listed above.

Initial Setup Menus

Auto Demo

Auto Demo allows you to start the High Speed response Demonstration automatically or not.



Press the MENU button



To AUTO DEMO



To turn ON or OFF



Press the MENU button when finished

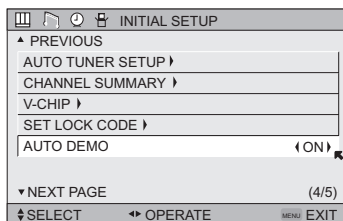

Note:

- This demo is set to ON by default until you turn it OFF in the main menu system.

Digital Setup

Use this function when you are receiving a digital broadcast.



Press the MENU button



To DIGITAL SETUP



To enter

The onscreen will appear

Notes:

- Software Update will only appear when the USB memory is inserted into the USB connector.
- If you are watching an analog channel, you can still access the digital setup menu at anytime, while you are doing this, the background screen will turn blank. In this case, the tuner will switch to digital, since you are accessing the digital setup menu.

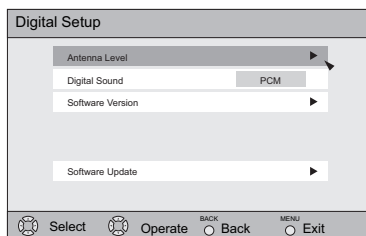

Antenna Level

Confirms the present antenna level.



Press the MENU button



To DIGITAL SETUP



To enter



To Antenna Level



To enter

The onscreen will appear

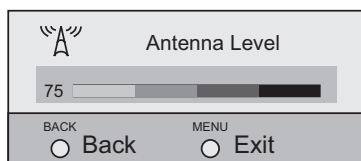

Initial Setup Menus

Digital Sound

You can select the optical digital sound output, either PCM or DOLBY DIGITAL when your TV is connected to an amplifier that has DOLBY DIGITAL decoder. If you select DOLBY DIGITAL, you can enjoy listening in 5.1ch sound when watching digital broadcasts.



Press the MENU button



To DIGITAL SETUP



To enter



To Digital Sound



To select PCM or DOLBY DIGITAL



Press the MENU button when finished

Notes:

- If your amplifier does not have DOLBY DIGITAL decoder, select PCM. If you don't select PCM, it cannot output the sound from the speakers.
- For connecting an amplifier using the optical output, see page 20.



Manufactured under license from Dolby Laboratories. "Dolby", and the double-D symbol are trademarks of Dolby Laboratories.

Software Version

You can confirm the Software Version.



Press the MENU button



To DIGITAL SETUP



To enter



To Software Version



To enter



Press the Ok button when you are finished confirming your software version



Press the MENU button when finished

Initial Setup Menus

Software Update

At first, connect the USB memory into the USB connector. This function will appear only when the USB memory is inserted into the USB connector.



Press the MENU button



To DIGITAL SETUP



To enter



To Software Update



To enter



Checks if it needs an update or not



Press the MENU button when finished

V5 INPUT

The Video-5 input allows you to choose the signal type you wish to receive that you have connected to Video-5 Input.



Press the MENU button



To V5 INPUT



To enter



To select HDMI, PC or Composite



Press the Ok button to decide

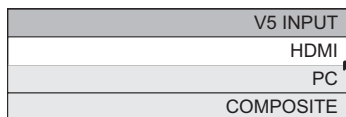

Picture Adjust Menus

Picture Settings

These settings allow you to change and adjust the way the picture appears on your television.

TINT

Tint allows you to adjust the levels of red and green in your TV picture.

COLOR

The color function lets you make all the colors in the TV picture appear either more vivid or subtle.

PICTURE

Picture allows you to adjust the levels of black and white on the TV screen, giving you a darker or brighter picture overall.

BRIGHT

You can adjust the overall brightness of the TV picture with the Bright control.

DETAIL

The Detail feature adjusts the level of fine detail displayed in the picture.

ENERGY SAVER MODE

The energy saver mode adjusts the level of brightness on the TV screen.

Adjust the Picture Settings



Press the MENU button



To TINT, COLOR, PICTURE, BRIGHT, DETAIL or ENERGY SAVER MODE



To enter

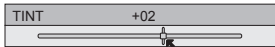

To adjust the setting



To back to the picture main menu



To move to the next setting



Press the MENU button when finished

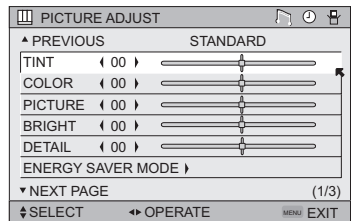

Notes:

- DETAIL menu cannot be selected when the Video Status mode is THEATER.
- There are six video status settings: Dynamic, Standard, Theater, Game, Memory-1 and Memory-2. Each video status setting has a separate memory for HD (1080i/1080p/720p) and SD (480p/480i) video signal. Each video status can be chosen along with your favorite picture settings (Tint, Color, Picture, Bright, Detail, etc.) See page 65 for details.

Color Temperature

You can decide how strong or dull the colors appear on the TV screen.



Press the MENU button



To COLOR TEMPERATURE



To enter



To set LOW or HIGH



Press the MENU button when finished

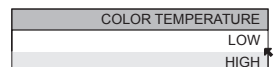

Picture Adjust Menus

Color Management

This TV supports the COLOR MANAGEMENT function to ensure dull colors are compensated to produce natural hues.



Press the MENU button



To COLOR MANAGEMENT



To enter



To turn ON or OFF



Press the MENU button when finished

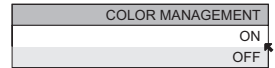

Dynamic Gamma

JVC's Dynamic Gamma Circuitry (DGC) makes it easier to see dark areas when a picture has many dark areas, and makes it easier to see the bright areas when a picture has many bright areas. DGC is turned on, DGC analyzes and adjusts the total level of picture brightness balance, especially in dark areas where the level of grayscale is often lost, turning completely to black DGC automatically enhances the detail in these dark areas providing a more dynamic image with finer detail, so the optimum picture settings are automatically set for each picture. Normally use with DGC on.



Press the MENU button



To DYNAMIC GAMMA



To enter



To turn ON or OFF



Press the MENU button when finished

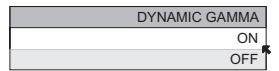

Smart Picture

Smart Picture detects the APL (Average Picture Level) and adjusts the level of brightness on the TV screen suitable for what you are watching.



Press the MENU button



To SMART PICTURE



To enter



To turn ON or OFF



Press the MENU button when finished

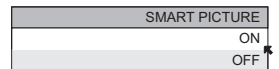

Note:

- When you have "DYNAMIC" selected in the "VIDEO STATUS", Smart Picture is not selected.

Picture Adjust Menus

Natural Cinema

Natural cinema corrects the problem of blurred edges which may occur when viewing a program originally shot on film (such as motion pictures) or animation. If you notice blurring at the edges of these programs, choose NATURAL CINEMA and set it to AUTO. Natural Cinema helps correct conversion errors that occur when film, which is shot at 24 frames-per-second, is broadcast at the television rate of 30 frames-per-second.



Press the MENU button



To NATURAL CINEMA



To enter



To select the mode AUTO, ON or OFF



Press the MENU button when finished

NATURAL CINEMA
AUTO
ON
OFF

Notes:

- When you are receiving a 1080p signal, Natural Cinema cannot be selected.
- The natural cinema mode is automatically set to "AUTO" in the following cases:
 - Turning on or off
 - Changing the channel or input mode
- If you are in PC mode, Natural Cinema cannot be used.
- Natural Cinema is only applied for SD 480i and HD 1080i signals.

Digital VNR

This function can be selected to change the effect of Digital VNR (Video Noise Reduction).



Press the MENU button



To DIGITAL VNR



To enter



To select the effect you like.

AUTO: adjusts the effect of VNR automatically.

MIN: adjusts the effect of VNR to minimum.

MAX: adjusts the effect of VNR to maximum.

OFF: turns the effect of VNR off.



Press the MENU button when finished

DIGITAL VNR
AUTO
MIN
MAX
OFF

Notes:

- If it is in PC, Digital VNR will not be displayed.
- When you are receiving a 1080p signal, Digital VNR cannot be selected.

Picture Adjust Menus

MPEG NR

This function effects the block noise removal and mosquito NR (Noise Reduction) simultaneously.



Press the MENU button



To MPEG NR



To enter



To turn ON or OFF



Press the MENU button when finished

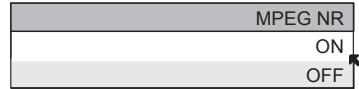

Notes:

- When you are receiving digital channels, block noise removal will have no effect.
- When you are receiving a 1080p signal, MPEG NR cannot be selected.

Smart Sensor

This function automatically adjusts the brightness on your TV according to the amount of light in the room.



Press the MENU button



To SMART SENSOR



To enter



To turn ON or OFF



Press the MENU button when finished

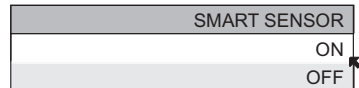

Sensor Effect

With Sensor Effect ON, a "leaf" icon will appear on your TV screen when Smart Sensor brightness adjustment occurs. The leaf icon will appear a maximum of 6 leaves. With each appearance indicates the level of ambient light is getting darker.



Press the MENU button



To SENSOR EFFECT



To turn ON or OFF



Press the MENU button when finished



Note:

- The leaves of Sensor Effect cannot be displayed when Closed Caption is ON.

Picture Adjust Menus

Theater Pro II

It is possible to use Theater Pro II menu only when the Video Status mode is set to THEATER. It adjusts the detailed picture settings.

Theater Pro II Menu	Settings
DSD Detail	Shows the edge of the picture clearly
H.SHARP	Emphasizes the edge of the picture horizontally
V.SHARP	Emphasizes the edge of the picture vertically
DSD NOISE CONTROL	Reduces picture noise
COLOR TEMPERATURE (RED, BLUE, GREEN)	Adjusts the screen (red, blue or green) color
COLOR BALANCE	Adjust the blue color naturally
*COLOR MNGMT. (RED, YELLOW, GREEN, CYAN) AXIS	Select a corrected color
*COLOR MNGMT. (RED, YELLOW, GREEN, CYAN) TINT	Adjusts the tints of (red, yellow, green or cyan)
*COLOR MNGMT. (RED, YELLOW, GREEN, CYAN) COLOR	Adjusts the color of (red, yellow, green or cyan)
*COLOR:BRIGHT AREA	Adjusts the picture color of the bright areas
*COLOR:DARK AREA	Adjusts the picture color of the dark areas

* These Theater Pro II menus cannot be selected when Color Management is OFF. See page 51.



Press the MENU button



To THEATER PRO II



To enter



Select a Theater Pro II menu



To adjust the settings



Press the MENU button when finished

Reset

Reset resets all picture adjustments except for Natural Cinema at once to the default settings.



Press the MENU button



To RESET



Press the Ok button

The onscreen menu disappears for a moment, and then the settings are reset to the default setting for all the picture adjustments except for NATURAL CINEMA.



Press the MENU button when finished

PICTURE ADJUST	
▲ PREVIOUS	STANDARD
DIGITAL VNR ▶	AUTO
MPEG NR ▶	ON
SMART SENSOR ▶	OFF
SENSOR EFFECT	◀ OFF ▶
THEATER PRO II ▶	
RESET	
▼ NEXT PAGE	(3/3)
⬇ SELECT	⬆ OPERATE MENU EXIT

Sound Adjust Menus

Sound Settings

These settings allow you to change and adjust the sound on your television. Four sound settings (MaxxBass, MaxxTreble, MaxxStereo and MaxxVolume) are referred as "MaxxAudio". See page 64.

MaxxBass – Compensates for low frequencies and widens the frequency band.

MaxxTreble – Compensates for high frequencies and widens the frequency band.

MaxxStereo – Expands the stereo sound naturally.

MaxxVolume – Maintains a uniform sound volume even if the sound becomes too loud all of the sudden (during commercial breaks, etc.).

BALANCE – Adjust the level of sound between the TV's left and right speakers with the balance setting.

Adjust the Sound Settings



Press the MENU button



To MaxxBass, MaxxTreble, MaxxStereo, MaxxVolume or BALANCE



To adjust the setting



To move to the next setting



Press the MENU button when finished

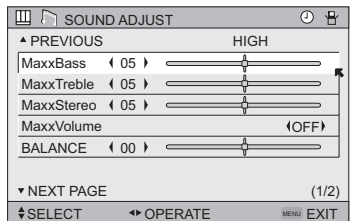

Note:

- You can reset all sound adjustments you set at once as the default setting when you select reset.

Turn On Volume

Turn On Volume allows you to set the volume level when you turn the TV on.



Press the MENU button



To TURN ON VOLUME



To set

→CURRENT ← 00 ← 01 ← 02 ← 03 ← - - - - - → 48 ← 49 ← 50 ←



Press the MENU button to finish

Volume Limit

Volume Limit allows you to set the maximum volume level.



Press the MENU button



To VOLUME LIMIT



To set the maximum volume level

00 ← 01 ← 02 ← 03 ← - - - - - → 48 ← 49 ← 50



Press the MENU button to finish

Reset

Reset resets all Sound Adjustments at once to the default settings. TURN ON VOLUME resets to CURRENT and VOLUME LIMIT resets to 50. See page 54 on how to use reset.

Clock/Timers Menus

Set Clock

The set clock function is described on page 25 as the interactive plug in menu. You can choose to set the clock automatically or manually. If you need to set the clock again, follow the steps below.



Press the MENU button



To SET CLOCK



To enter

When you set the clock automatically, choose **AUTO** by pressing the ◀ or ▶ arrows.



To TIME ZONE



To select your time zone:

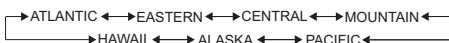

To D.S.T. (daylight savings time)



To turn D.S.T. ON or OFF



Press OK to finish



Press the MENU button when finished

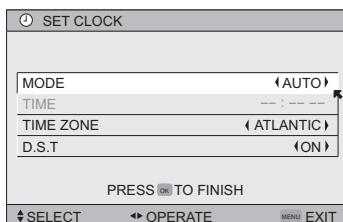

When you set the clock manually, choose **MANUAL** by pressing the ◀ or ▶ arrows.



To move to the hours



To set the hours



To move to minutes



To set the minutes



To TIME ZONE



To select your time zone:

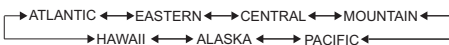

To D.S.T. (daylight savings time)



To turn D.S.T. ON or OFF



Press OK to start clock

THANK YOU !!



Press the MENU button when finished

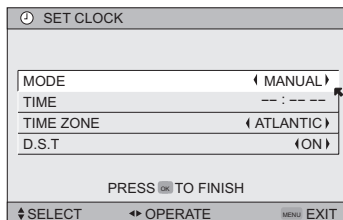

Notes:

- D.S.T. can be used when it is set to ON in the SET CLOCK menu.
- Only when the MODE is set to AUTO, the Daylight Saving Time feature automatically adjusts your TV's clock for Daylight Saving.
- The real time and D.S.T. may not be set correctly depending on the broadcasting signal and receiving conditions. In this case, set your clock manually and turn D.S.T. to OFF.
- You will have to reset the clock after a power interruption. You must set the clock before operating any timer functions.

Clock/Timers Menus

On/Off Timer

The on/off timer lets you program your television to turn itself on or off. You can use it as an alarm to wake up, to help you remember important programs, or as a decoy when you're not home.



Press the MENU button



To ON/OFF TIMER



To enter (begins with ON TIME)



To set the hour (AM/PM) you want the TV to turn on



To move to minutes



To set the minutes



To accept ON TIME and move to OFF TIME (the time the TV will turn off). Set the OFF TIME the same way as ON TIME



To accept OFF TIME and move to CHANNEL



To select channel



To ON VOLUME



To set the volume level



To move to MODE



To select ONCE or EVERYDAY



To ON/OFF TIMER



Choose YES to accept the timer setting, choose NO if you don't wish to accept



Press the OK button to finish



Press the MENU button to exit the menu

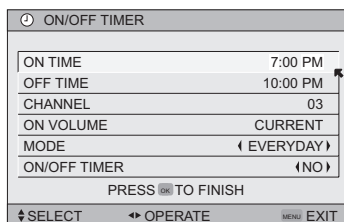

Notes:

- The on/off timer cannot be set to locked or guarded channels in the channel summary menu.
- In order for the on/off timer to work, the clock must be set.
- After a power interruption, the timer settings must be reset.
- If your clock is not set, "PLEASE SET CLOCK FIRST !!" will appear on the screen. See Set Clock (choose MANUAL) on page 56 to set the clock.

Button Functions

Power

Turns the TV on or off.



Press the POWER button

Number Buttons - 10Key Pad

Use the number buttons on the remote control to move directly to a specific channel. For example, to move to channel 12:



1 (One)



2 (Two)

Tune

Lets you decide the input channel and select it. After you press the number buttons on the remote, press the TUNE button. For example, to move to channel 12:



1 (One)



2 (Two)



Press the TUNE button

Sub Channel

The main channel sometimes has minor channels (Sub Channels). By using the SUB CH button, you can select a sub channel easily.

At first, select TV or STB mode to use the Sub channel function. See page 68.

To watch sub channels

For example, to move to sub channel 123-45:



Press 1, 2 and 3 in order



Press the SUB CH button



Press 4 and 5 in order



Press the TUNE button

Note:

- If there are more than 2 major channels, select the digital channel by using the ▲▼ buttons and then press the OK button.

Channel +/-

Use these buttons to move up or down all the available channels your TV is able to receive. To move rapidly through the channels using JVC's **Hyperscan** feature, press and hold CH+ or CH-.

Button Functions

Volume +/-

Use these buttons to raise or lower the TV's volume level. The maximum is the level you set in Volume Limit. See page 55.

Muting

The **MUTING** button instantly turns the volume down completely when you press it. Press **MUTING** and the volume level will instantly go to zero. To restore the volume to its previous level, press **MUTING** again.

D/A (Digital/Analog)

The **D/A** button changes the analog and digital channel. Digital channels have a "D" in front of the channel number.



Press the **D/A** button

By every press of the **D/A** button, you can switch between analog and digital channels.

To watch digital channels

For example, to move to channel **D23**:



Press **2** (Two)



Press **3** (Three)



Press the **TUNE** button

Input

Selects the signal input source for the television: **VIDEO-1, 2, 3, 4** or **5** for video devices like VCRs, DVD players or camcorders.



Press the **V1, V2, V3, V4** or **V5** button

Notes:

- When you return to TV mode, press the **RETURN +/-TV** button or direct 10 key pad or **CHANNEL +/-** button.
- You can also access by pressing the **INPUT** button on the side of the TV instead of the remote control.
- **VIDEO-5 (V5)** can be used for **HDMI, PC** and **Composite Input**. You can select the input in **V5 INPUT** in **INITIAL SETUP** menu.

Button Functions

Return +/TV

The RETURN+/TV button has three functions:

Return - Returns to the channel viewed just before the channel currently onscreen.

Return+ - Lets you program a specific channel to return to while scanning through the channels using the CH+ and CH- buttons.

TV - Returns to the TV mode.

Press the RETURN+/TV and hold for three seconds

A rectangular box with a thin border containing the text "RETURN CHANNEL PROGRAMMED!".

The channel currently active has been programmed as your return+ channel. Now scan through the channels using the CHANNEL+/- buttons.

Press the RETURN+/TV

You will return to your programmed channel.

- To cancel your return+ channel, press and hold the RETURN+/TV button for three seconds. The message "RETURN CHANNEL CANCELLED!" will appear.
- Return+ works only with the Channel+/- buttons. Pressing any number key will cancel return+.

Light

All remote control buttons are illuminated, except for the Light button. Press the LIGHT button to turn the illumination on for 5 seconds.

Menu

The MENU button allows you to access JVC's onscreen menu system. Press MENU to activate the onscreen menu system. When a menu is displayed, press the MENU button to exit.

- See individual topics like "Sound Adjust" for specific information on using menus.

OK

This button confirms your selection when you are in one of the onscreen menus.

Back

This button allows you to go back in the menu to change a selection or correct a mistake.

Button Functions

Favorite

The Favorite button allows you to select your favorite channels easily. First, you must register the channels that you like. See how to register below.



Press the FAVORITE button
The favorite channel list will appear.



To select the channel you want to watch



Press the Ok button
It will change to the channel you have selected.

FAVORITE	
▲ PREVIOUS	
101	CBS
102	FOX
D103	PBS2
<	>
D107	HBO
8	ABC
▼ NEXT	

Register the favorite channel



Press the channel number you want to register
The channel program will change.



Press the FAVORITE button for three seconds
The channel will be registered in the favorite channel list.

Notes:

- Both analog and digital channels can be registered. The digital channels have a "D" in front of the channel number.
- The maximum number of channels you can register is 24.
- If you have registered the maximum number of channels, and try to register more channels, the oldest channel you registered will be deleted.
- Sub channels cannot be registered.
- The newest channel you registered will appear at the top of the list.

Delete the favorite channel



Press the FAVORITE button
The favorite channel list will appear.



To select the channel you want to delete



To enter



Press the FAVORITE button
The channel was deleted.

Note:

- Before pressing the FAVORITE button when you are finished, press the ◀▶ button again, and you can return to the deleted channel.

Button Functions

Aspect

This feature will help you adjust the picture you are watching to give you the best possible picture quality.

Aspect Ratios

PANORAMA - With this ratio a normal 4:3 aspect picture is stretched to fit the dimensions of the 16:9 aspect screen.

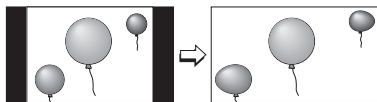

CINEMA - This ratio "zooms in" on the center part of a 4:3 aspect picture, blowing it up to fill the 16:9 screen.



FULL - This is the ratio to use when watching 16:9 High-Definition broadcasts.

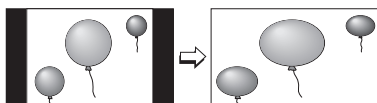

PANORAMA ZOOM - This ratio stretches the High-Definition 16:9 aspect image to eliminate the black side bars.

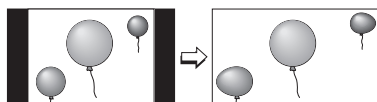

CINEMA ZOOM - This ratio stretches the High-Definition 16:9 aspect image to eliminate the black surrounding bars.



FULL NATIVE - This ratio displays 100% of the ratio. Normally, all aspects except for Full Native display about 95%.

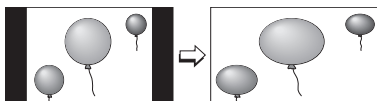

REGULAR - The regular ratio is used when you want to watch a 4:3 broadcast or recorded program without modifying the original picture to fit the dimensions of your 16:9 screen. The 4:3 picture will fill the screen from top to bottom, while black bars will appear to fill up the remaining space along the picture's sides. The 4:3 picture will be centered within the boundaries of the 16:9 screen.

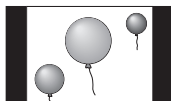

SLIM - This aspect mode shrinks the screen of 16:9 to 4:3. There are some programming that is already stretched by mistake at broadcasting companies, so this mode corrects it. Black side bars will appear.

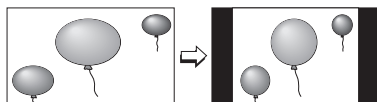

Aspect Ratios in PC Mode

REGULAR - This is the original aspect mode.

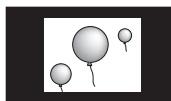

FULL - This aspect mode stretches the image to fit the dimensions of the 16:9 aspect screen.

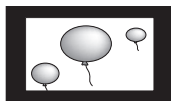

Button Functions

Aspect Ratios (Continued)



Press the ASPECT button

- By pressing the ASPECT button, you can change the size.

When you change the aspect ratios, it is different from their broadcast or recorded program.

SD (480i, 480p)
NTSC

ASPECT
PANORAMA
CINEMA
FULL
REGULAR

HD (720p)
ATSC (480i, 480p, 720p)

ASPECT
PANORAMA ZOOM
CINEMA ZOOM
FULL
SLIM

HD (1080i)
ATSC (1080i)

ASPECT
PANORAMA ZOOM
CINEMA ZOOM
FULL
FULL NATIVE
SLIM

PC (XGA, VGA)

ASPECT
FULL
REGULAR

Notes:

- You can also choose the size by pressing the ▲▼ buttons.
- When you change the aspect ratio or signal, reset the picture position to center.
- You can also access the FRONT PANEL CONTROL screen by using the MENU button on the side of the TV instead of the remote control. It appears between INITIAL SETUP and PICTURE ADJUST screen, and it has VIDEO STATUS and ASPECT menus. Choose ASPECT by pressing Menu ▼ on the side panel and choose a mode by using the CHANNEL +/- buttons.
- SLIM can only be displayed when the signal is ATSC (480i, 480p, 720p, 1080i) or HD (720p, 1080i).
- If the television receives a 16:9 signal from your HDMI device, the aspect mode will turn to FULL automatically. If the television receives a 4:3 signal from your HDMI device when you are in FULL aspect mode, it will return to REGULAR aspect mode. If you change the aspect mode after the television changed it to FULL automatically, the television will change to the aspect mode you choose. It also turns to FULL automatically when the TV receives an HD (1080i or 720p) signal.
- When you are receiving an HDMI 1080p signal in FULL NATIVE mode, you are unable to change the aspect mode.

Guide

You can view the program information from the GUIDE.

Notes:

- The GUIDE function will work when you are receiving digital program only.
- The GUIDE will not show the correct time and date if you have not performed the set clock function on your television. See page 56.
- When the program information is not being broadcasted, it will not show the correct information.

Button Functions

Sound

By pressing the SOUND button, you can change the sound mode of the MaxxAudio function. The sound mode has four settings (HIGH, MID, LOW and OFF).



Press the SOUND button



To MaxxAudio



To choose HIGH, MID, LOW or OFF



Press the MENU when finished

SOUND EFFECT	
MaxxAudio	◀ MID ▶
◀ OPERATE	MENU EXIT



MaxxAudio is a registered trademark of Waves Audio Ltd. in the USA, Japan and other countries.

Note:

- To set MaxxAudio (MaxxBass, MaxxTreble, MaxxStereo and MaxxVolume) individually for each sound mode, see page 55.

ML/MTS

MTS technology allows several audio signals to be broadcast in analog at once, giving you a choice in what you wish to hear with a TV program. In addition to mono or stereo sound, an MTS broadcast may also include a second audio program (SAP).

At first, select TV mode to use the multi-language/MTS function.



Press the ML/MTS button

By every press of the ML/MTS button, you change the mode

	MTS
ON AIR	STEREO
ON AIR	SAP
	MONO

Notes:

- When you are receiving a digital broadcast, if there are other languages, you can change the language by pressing the ML/MTS button.
- Keep the TV in stereo mode to get the best sound quality. The sound will work in stereo mode even if a certain broadcast is in mono sound only.
- Choose the mono setting to reduce excessive noise on a certain channel or broadcast.
- Selecting SAP will allow you to hear an alternative soundtrack, if one is available.
- MTS unavailable if your television's Input source is in VIDEO-1, 2, 3, 4 or 5 mode, as described on page 59.
- ML/MTS will not work when you are using the HDMI.
- You can also change the mode by pressing the ▲▼ buttons.

Button Functions

Video Status

The VIDEO STATUS button gives you a choice of TV picture display settings, including a display of your own preferences. Every input (TV, V1 - V5) can use the Video Status Mode.

STANDARD - Resets the picture display to the factory settings.

DYNAMIC - Gives a vivid picture with better contrast when viewing in a brightly lit room.

THEATER - Gives a rich, film-like look to video when viewing in a dimly lit room.

GAME - Used for when you are playing video games connected to your TV.

VIDEO STATUS
STANDARD
DYNAMIC
THEATER
GAME
MEMORY-1
MEMORY-2

MEMORY-1, MEMORY-2 - Default setting is the same as STANDARD mode.



Press the VIDEO STATUS button

By every press of the VIDEO STATUS button, you change the mode.

Notes:

- You can also change the mode by pressing the ▲▼ buttons.
- Each mode is memorized for each input connected to the TV.
- You can also access the FRONT PANEL CONTROL screen by using the MENU button on the side of the TV instead of the remote control. It appears between INITIAL SETUP and PICTURE ADJUST screen, and it has VIDEO STATUS and ASPECT menus. Choose VIDEO STATUS by pressing MENU ▼ on the side panel and choose a mode by using the CHANNEL +/- buttons.
- There are six video status settings: DYNAMIC, STANDARD, THEATER, GAME, MEMORY-1 and MEMORY-2. Each video status setting has a separate memory for HD (1080i/1080p/720p) and SD (480p/480i) video signal. Each video status can be chosen along with your favorite picture settings (Tint, Color, Picture, Bright, Detail, etc.)
 - When an HD signal is displayed: Your HD settings are recalled for the video status you are using.
 - When an SD signal is displayed: Your SD settings are recalled for the video status you are using.
 - The input you are using (Input-1, Input-2, etc.) does not affect the setting that is recalled, just the signal type.
 - This function considers PC input as an HD signal and TWIN screens as an SD signal.

C.C. (Closed Caption)

Use the C.C. (Closed Caption) button to select the mode of closed caption.

At first, select TV, STB or VCR mode to use the closed caption function. See page 68.



Press the C.C. button

CLOSED CAPTION
OFF
SMART CAPTION
ON

Notes:

- SMART CAPTION will appear when you press the MUTE button only on channels where the broadcast contains closed captioning.
- When you select ON, it will be the mode selected in the Closed Caption Menu.
- See page 34 when you set the caption/text mode.
- You can also change the mode by pressing the ▲▼ buttons.
- If you are in PC mode, C.C. cannot be used.

Button Functions

Sleep Timer

The Sleep Timer can turn the TV off for you after you fall asleep. Program it to work for a total time of up to 180 minutes.

At first, select TV mode to use the sleep timer function.



Press the SLEEP button



Sleep Timer Message

60 seconds before the automatic shutoff, this message will appear:

GOOD NIGHT !
PUSH SLEEP TIMER BUTTON
TO EXTEND

You then have 60 seconds to press the SLEEP button to delay the shut off.

Display

The display screen shows the current status of timers, inputs and XDS ID.

At first, select TV or STB mode to use the display function. See page 68.



Press the DISPLAY button

The screen to the right shows the following information:

- The current channel or AV input (Channel 05)
- The current time (12:20 pm)
- Sleep timer status/minutes remaining (The Sleep Timer is off)
- On/off timer status (Set to turn on everyday at 7:00 PM, off at 10:00 PM)
- Each Press of the DISPLAY button changes the display mode:

05 KLVX PBS	
JAZZ FESTIVAL	
NOW	12:20 PM
SLEEP TIMER	OFF
ON/OFF TIMER	EVERYDAY
ON TIME	7:00 PM
OFF TIME	10:00 PM



Display - Full screen shown above

Time - Shows the current time only

Channel - Shows the current channel

Off - Turns display off

Notes:

- You may also turn off the display at any step by pressing MENU.
- If the clock, sleep timer or on/off timer are not set, the display screen will show: "CLOCK NOT SET", "SLEEP TIMER OFF", and "ON/OFF TIMER OFF" respectively.

Button Functions

Twin

Activate the split-screen option by pressing **TWIN** on the remote control. The channel (or input) you were watching before pressing **TWIN** will appear on the left, the new channel will appear on the right. The sound will continue to come from the main screen channel (or input). To turn split-screen off and return to normal television viewing, press **TWIN** again or press the **BACK** button.

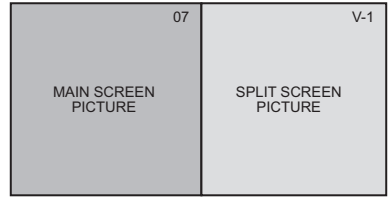

At first, select TV mode to use the **TWIN** function.

Notes:

- Main Screen and Split Screen will not display the same channel or input at the same time.
- You can enter the **TWIN** mode when the screen is in **NORMAL** mode.
- Split screen picture will not display digital channels and **HDMI**.
- Split-screen functions will not work with locked channels or channels blocked by **V-Chip** ratings limits. A gray screen will display instead.
- Split screen picture will not display the picture from the component terminal and the **HDMI** terminal.
- The aspect of Main Screen Picture becomes 16:9 when you input the picture of 480p, 720p and 1080i from the component terminal and **HDMI** terminal.
- After you press the **SELECT** button, and select split screen picture when you press the **OK** button, select normal screen. If you don't operate, the Main Screen Picture will be automatically selected about 8 seconds later.
- When you are in **TWIN** or **FREEZE** mode, you cannot change the aspect ratio.
- When you press the **Menu** button in **Twin** mode, it appears only as **Picture Adjust** menu.
- When you are in **PC** mode or **1080p** mode, **TWIN**, **SWAP**, **SELECT** and **FREEZE** cannot be used.

Swap

You can exchange the channel (or input) displayed in the split screen window for the main screen image by pressing the **SWAP** button.

At first, select TV mode to use the **SWAP** function.

Notes:

- It will only work in **TWIN** mode.
- If the signal that you are watching is coming from the **HDMI** input, you cannot enter the **SWAP** mode.

Button Function

Select

With SELECT, you can select the picture (channel) while viewing TWIN screen. When you press SELECT button, the channel number on the top will be highlighted. Each press of SELECT will shift the channel.

At first, select TV mode to use the Select function.

Freeze

Pressing the FREEZE button causes the screen to change to the split-screen display with the still picture displayed on the right. In order to return to the normal display, press the FREEZE button once again.

At first, select TV mode to use the Freeze function.

Mode

Your remote control can be used to operate some basic functions of your external devices. To use your device, select the proper mode.

MODE	Device
TV	TV
STB	STB/DVR (Cable Satellite)
VCR	VCR/DVR
DVD	DVD Player (DVD Recorder)
AUDIO	Amplifier/Home Theater in Box



Press the MODE button

By every press of the Mode button, you can select the mode.



- The mode LED indicator on the remote control lights for 3 seconds each time the remote control is operated.

External device control buttons

You can use this remote control to operate the basic functions of your external devices. See page 69 on how to program the remote control to operate your other devices.

Note:

- The remote is preset to control JVC-brand devices.

Remote Programming

Remote programming

You can program your remote control to operate your external devices, using the instructions and codes on pages 70 - 74. The following external devices can be operated using your remote control.

Device	Mode	Applied for these functions	Page
Cable Set Top Box Cable/PVR Combination Satellite Set Top Box DBS/PVR Combination	STB	Power on/off, Channel up/down, Volume up/down, Number 0 - 9, Tune, Return+/TV, Muting, Favorite Channel, Menu on/off, Arrow buttons, OK/Enter, Back, DVR (JVC Only)*, Guide (EPG), Sub Channel, Closed Caption, Display (Recall), Rewind (◀), Playback (▶), Forward (➡), Record (●), Stop (■), Pause (⏸).	70
VCR, DBS/PVR Combination PVR, DVD/PVR Combination	VCR	Power on/off, Channel up/down, Menu on/off, Arrow buttons, OK/Enter, Back, Guide (EPG), TV/VCR, Closed Caption, Eject (▲), Rewind (◀), Playback (▶), Forward (➡), Record (●), Stop (■), Pause (⏸).	71, 72
DVD Player, DVD Recorder Home Theater in Box	DVD	Power on/off, Channel up/down, Menu on/off, Arrow buttons, OK/Enter, Back, Guide (EPG), TV/DVD (TV/VCR button), Sub Title (Sub T.), Open/Close (▲), Rewind (◀), Playback (▶), Forward (➡), Record (●), Stop (■), Still (⏹).	73
Amplifier, Home Theater in Box, Receiver	AUDIO	Power on/off, Volume up/down, Muting, DVD operation buttons: Menu on/off, Arrow buttons, OK/Enter, Back, Sub Title (Sub T.), Open/Close (▲), Rewind (◀), Playback (▶), Forward (➡), Stop (■), Still (⏹).	74

* DVR button only applies to JVC DVR (Dish Satellite STB).

Notes:

- To record to your VCR or DVD, hold the record (●) button on the remote control and press play (▶).
- If the code you programmed doesn't work, try the next one. If no codes work, refer to "Search Code Function" on page 69. If your remote does not work after using the "Search Code Function", use the remote that came with your device. Your TV remote cannot be guaranteed to work with all models, brands or operations.
- When the television remote control does not operate, for a model that allows you to switch the remote control code on the device side, you can try switching the setting to default or something else on the device side.

How to set the codes

- 1) Find your device and device's brand from the code list. See page 70 - 74.
- 2) Select the mode of your device by pressing the MODE button. Then confirm the mode LED on the remote control.
- 3) Press and hold the TUNE button, then enter the first four digit code number listed using the number buttons. When the code is set, the mode LED goes out for a second, then it lights.
- 4) After confirming the proper mode LED, release the TUNE button, and confirm the operation of your device.
- 5) If your device does not respond, try and enter the next code.

Search Code Function

- 1) Select a mode of your device by pressing the MODE button.
- 2) Press the POWER and RETURN+/TV buttons. Hold for at least 3 seconds and release. Then confirm the mode LED blinks.
- 3) Press any button* on the remote, and see if the selected device responds. *Use the applied buttons except for ◀ ▶ cursors, Return+/TV and Rec (●) on the above chart.
- 4) If there was a response, press RETURN+/TV. The codes are now set. Then confirm the mode LED goes out.
- 5) If there was no response, try to select the previous code or the next code by using ◀ or ▶ . If you repeat a total of 65 times for the STB (90 times for the VCR, 120 times for the DVD and 132 times for the AUDIO) without a response, use the remote control that came with your equipment. Press RETURN+/TV to exit. Then confirm the mode LED goes out.

Remote Programming

Programming Codes

STB mode

Cable Set Top Box		Satellite Set Top Box		Satellite Set Top Box	
ABC	0003, 0008	AlphaStar	0772	Samsung	1377, 1276, 1108, 1109, 1442, 1609
Americast	0899	Chaparral	0216	SKY	0856
Bell South	0899	Coolsat	1806	Sony	0639, 1639, 1640
Digeo	1187	Crossdigital	1109	Star Choice	0869
Director	0476	DirecTV	1377, 0392, 0566, 0639, 1639, 1142, 0247, 0749, 1749, 0724, 0819, 1856, 1076, 1108, 0099, 1109, 1414, 1442, 1609, 1392, 1640	Tivo	1142, 1442
General Instrument	0476, 0810, 0276, 0003			Toshiba	0749, 1749, 0790, 1285
GoldStar	0144			UltimateTV	1392, 1640
Hamlin	0009, 0273			Ultrasat	1806
Jerrold	0476, 0810, 0276, 0003			Uniden	0724, 0722
Memorex	0000	Dish Network System	1505, 1005, 0775, 1170, 1775	US Digital	1535
Motorola	1376, 0476, 0810, 0276, 1187	Dishpro	1505, 1005, 0775, 1775	USDTV	1535
Pace	1877, 0237, 0008	EchoStar	1505, 1005, 0775, 1170, 1775	Voom	0869
Panasonic	0000, 0008, 0107	Expressvu	0775, 1775	Zenith	0856, 1856
Paragon	0000	GE	0566	DBS/PVR Combination	
Philips	1305, 0317, 0025	General Instrument	0869	DirecTV	1377, 0392, 0639, 1142, 1076, 0099, 1392, 1442, 1640
Pioneer	1877, 0877, 0144, 0533	GOI	0775, 1775	Dish Network System	1505, 0775
Pulsar	0000	Hisense	1535	Dishpro	1505, 0775
Quasar	0000	Hitachi	0819	EchoStar	1505, 0775, 1170
Regal	0279, 0273	HTS	0775, 1775	Expressvu	0775
Runco	0000	Hughes Network Systems	1142, 0749, 1749, 1442	Hughes Network Systems	1142, 1442
Samsung	0000, 0144	Humax	1790	JVC	1170
Scientific Atlanta	1877, 0877, 0477, 0008	iLo	1535	Motorola	0869
Sony	1006	JVC	0775, 1170, 1775	Philips	1142, 0099, 1442
Starcom	0003	LG	1414	Proscan	0392
Supercable	0276	Magnavox	0724, 0722	RCA	1392
Tox	0003	Memorex	0724	Samsung	1442
Toshiba	0000	Mitsubishi	0749	Sony	0639, 1640
Zenith	0000, 0525, 0899	Motorola	0869	Star Choice	0869
Cable/PVR Combination		Next Level	0869		
Americast	0899	Panasonic	0247, 0701		
Digeo	1187	Pansat	1807		
General Instrument	0810	Paysat	0724		
Jerrold	0810	Philips	1142, 0749, 1749, 0724, 1076, 0722, 0099, 1442		
Motorola	1376, 0810, 1187	Proscan	0392, 0566		
Pace	1877, 0237	Proton	1535		
Pioneer	1877, 0877	RadioShack	0869		
Scientific Atlanta	1877, 0877	RCA	0566, 0855, 0143, 1392		
Sony	1006				
Supercable	0276				
Zenith	0899				

Remote Programming

VCR mode

VCR		VCR		VCR	
ABS	1972	Fisher	0047, 0104, 0046	Marta	0037
Admiral	0048, 0209	Fuji	0035, 0033	Matsushita	0035, 0162, 0227, 1162
Adventura	0000	Funai	0000, 0593, 1593		
Aiko	0278	Garrard	0000	Media Center PC	1972
Aiwa	0037, 0000, 0307, 0479	Gateway	1972	MEI	0035
Akai	0041, 0061, 0106	GE	0060, 0035, 0240, 0202, 0760, 0761, 0807, 1035, 1060	Memorex	0035, 0162, 0037, 0048, 0039, 0047, 0240, 0000, 0104, 0209, 0046, 0307, 0479, 1037, 1048, 1162, 1237, 1262
Alienware	1972				
America Action	0278	Go Video	0432, 0526		
American High	0035	GoldStar	0037, 0209, 0038, 0225, 1237		
Asha	0240				
Audiovox	0037, 0278	Gradiente	0000	MGA	0240, 0043, 0061
Beaumarck	0240	Harley Davidson	0000	MGN Technology	0240
Bell & Howell	0104	Harman/Kardon	0081, 0038	Microsoft	1972
Broksonic	0184, 0121, 0209, 0002, 0479, 1479	Harwood	0072	Mind	1972
		Headquarter	0046	Minolta	0042, 0105
Calix	0037	Hewlett Packard	1972	Mitsubishi	0081, 0067, 0043, 0041, 0061, 0173, 0807
Canon	0035	Hi-Q	0047		
Capehart	0020	Hitachi	0037, 0240, 0000, 0042, 0041, 0105, 1037	Motorola	0035, 0048
Carver	0081			MTC	0240, 0000
CCE	0072, 0278			Multitech	0000, 0072
Citizen	0037, 0278, 1278	Howard Computers	1972	NEC	0035, 0037, 0048, 0104, 0067, 0041, 0038, 0008
Colt	0072	HP	1972		
Craig	0037, 0047, 0240, 0072, 0271	Hughes Network Systems	0042, 0739		
		Humax	0739		
Curtis Mathes	0060, 0035, 0162, 0041, 0760, 1035	Hush	1972	Nikko	0037
		iBUYPOWER	1972	Niveus Media	1972
Cyberbex	0240	Jensen	0041	Noblex	0240
CyberPower	1972	JVC	0045, 0067, 0041, 0008, 0366, 1707, 1945, 1774, 1775, 1776, 1777	Northgate	1972
Daewoo	0045, 0104, 0278, 0020, 0046, 0561, 1278	KEC	0037, 0278	Olympus	0035
Daytron	0020	Kenwood	0067, 0041, 0038	Optimus	1062, 0162, 0037, 0048, 0104, 0432, 0593, 1048, 1162, 1262
Dell	1972	KLH	0072	Orion	0184, 0121, 0209, 0002, 0208, 0479, 1479
Denon	0042	Kodak	0035, 0037		
DirecTV	0739	LG	0037, 0045, 0042, 0209, 0038, 1037	Panasonic	1062, 0035, 0162, 0225, 0227, 0616, 1035, 1162, 1262
Durabrand	0039, 0038	Linksys	1972		
Dynatech	0000	Lloyd's	0000, 0208		
Electrohome	0037	Logik	0240, 0072	Penney	0035, 0037, 0240, 0042, 0038, 1035, 1237
Electroponic	0037	LXI	0037		
Emerex	0032	Magnasonic	0593, 1278	Pentax	0042, 0105
Emerson	0035, 0037, 0184, 0240, 0045, 0000, 0121, 0043, 0209, 0002, 0278, 1593, 1479, 1278, 0593, 0561, 0479, 0208, 0061	Magnavox	0035, 0039, 0081, 0000, 0149, 0563, 0593, 1593, 1781	Philco	0035, 0000, 0038
		Magnin	0240		
		Marantz	0035, 0081		

Remote Programming

VCR mode

VCR		VCR		PVR	
Philips	0035, 0081, 0000, 0563, 0593, 0618, 0739, 1081, 1181, 1266	Symphonic	0000, 0593, 1593	Howard Computers	1972
		Systemax	1972	HP	1972
		Tagar Systems	1972	Hughes Network Systems	0739
		Tatung	0081, 0045, 0000, 0067, 0041, 0008, 0366	Humax	0739
Pilot	0037		Hush	1972	
Pioneer	0081, 0042, 0067		IBUYPOWER	1972	
Polk Audio	0081	Teac	0000, 0041	JVC	1945
Portland	0020	Technics	0035, 0162	Linksys	1972
Presidian	1593	Teknika	0035, 0037, 0000	Media Center PC	1972
Proffrionic	0240	Thomas	0000	Microsoft	1972
Proscan	0060, 0202, 0760, 0761, 1060	Tivo	0618, 0636, 0739, 1996	Mind	1972
				Niveus Media	1972
Protec	0072	TMK	0240, 0208	Northgate	1972
Pulsar	0039	Toshiba	0081, 0045, 0042, 0067, 0043, 0041, 0008, 0057, 0366, 0845, 1008, 1145, 1972, 1996	Panasonic	0616, 1777
Quarter	0046		Philips	0618, 0739	
Quartz	0046		RCA	0880	
Quasar	0035, 0162, 1035, 1162			ReplayTV	0614, 0616
RadioShack	0000, 1037	Totevision	0037, 0240	Samsung	0739
Radix	0037	Touch	1972	Sonic Blue	0614, 0616
Randex	0037	Unitech	0240	Sony	0636, 1972
RCA	0060, 0035, 0240, 0000, 0042, 0149, 0105, 0106, 0202, 0760, 0761, 0807, 0880, 1035, 1060	Vector	0045	Stack 9	1972
		Vector Research	0038	Systemax	1972
		Video Concepts	0045, 0061	Tagar Systems	1972
		Videomagic	0037	Tivo	0618, 0636, 0739
Realistic	0035, 0037, 0048, 0047, 0000, 0104, 0046	Videosonic	0240	Toshiba	1008, 1972, 1996
		Viewsonic	1972	Touch	1972
		Villain	0000	Viewsonic	1972
		Voodoo	1972	Voodoo	1972
ReplayTV	0614, 0616	Wards	0060, 0035, 0048, 0047, 0081, 0240, 0000, 0042, 0072, 0149, 0760	ZT Group	1972
Ricavision	1972				
Runco	0039	White Westinghouse	0209, 0072		
Samsung	0240, 0045, 0432, 0739, 0760, 1014	XR-1000	0035, 0000, 0072		
		Yamaha	0041, 0038		
Sansui	0000, 0067, 0209, 0041, 0271, 0479, 1479	Zenith	0039, 0033, 0000, 0209, 0034, 0479, 1139, 1479		
Sanyo	0047, 0240, 0104, 0046	ZT Group	1972		
Scott	0184, 0045, 0121, 0043				
Sears	0035, 0037, 0047, 0000, 0042, 0104, 0046, 0057, 0105, 1237	DBS/PVR Combination			
		Echostar	1945		
		Hughes Network Systems	0739		
		JVC	1945		
Sharp	0048, 0209, 0807, 0848, 1048	Philips	0739		
		Samsung	0739		
Shintom	0104, 0072				
Shogun	0240				
Singer	0045, 0072				
Sonic Blue	0614, 0616	ABS	1972		
Sony	0035, 0032, 0033, 0000, 0034, 0636, 0639, 0640, 1032, 1232, 1972	Alienware	1972		
		CyberPower	1972		
		Dell	1972		
		DirecTV	0739		
Stack 9	1972	Dish Network System	1945		
STS	0042	Echostar	1945		
Sylvania	0035, 0081, 0000, 0043, 0593, 1593, 1781	Gateway	1972		
		Hewlett Packard	1972		

DVD/PVR Combination

Emerson 0000

Remote Programming

DVD mode

DVD		DVD		DVD Recorder	
Accurian	1416	Magnavox	0503, 0539, 0646,	Accurian	1416
Advent	1016		0675, 0821, 1268	Apex Digital	1056
Aiwa	0641	Marantz	0539	Aspire Digital	1168
Akai	0695, 0770, 0899	Memorex	0695, 0831, 1270	CyberHome	1129
Alco	0790	Microsoft	0522, 1708	Denon	0490
Allegro	0869	Mintek	0839, 0717	Funai	0675, 1334
Apex Digital	0672, 0717, 0755, 0830, 1056, 1061	Mitsubishi	1521, 0521	Gateway	1158
		NAD	0741	Go Video	0741, 1158, 1304, 1730
Argo	1023	NEC	0785		
Aspire Digital	1168	Nesa	0717	iLo	1348
Audiovox	0790	NexxTech	1402	JVC	1164
Blaupunkt	0717	Norcent	1003, 1107	LG	0741
Blue Parade	0571	Onkyo	0503, 0627	LiteOn	1158, 1416, 1440
Broksonic	0695	Oritron	0651	Magnavox	0646, 0675
Cinea	0831	Panasonic	0490, 0703, 1362, 1462, 1490, 1762	Panasonic	0490
Cine Vision	0876, 0833, 0869			Philips	0646, 1158
Citizen	1277	Philips	0503, 0539, 0646,	Pioneer	0631
Coby	0778, 1107		0675, 0854, 1158,	RCA	0522
Craig	0831		1260, 1267, 1354	Samsung	0490, 1470
Curtis Mathes	1087	Pioneer	0525, 0571, 0631	Sensory Science	1158
CyberHome	0816, 0874, 1023, 1024, 1117, 1129	Polaroid	1061	Sharp	0630, 0675
		Polk Audio	0539	Sony	1033, 1431
Daewoo	0784, 0705, 0770, 0833, 0869, 1169, 1172	Portland	0770	Sylvania	0675
		Presidian	0675	Zenith	0741
		Prima	1016		
Denon	0490, 0634	Proscan	0522	Home Theater in Box	
Disney	0675, 1270	Pro Vision	0778	Aiwa	0641
Durabrand	1127	Qwestar	0651	Audiovox	0790
DVD2000	0521	RCA	0522, 0571, 0717, 0790, 0822, 1022, 1132	JVC	1770, 1771, 1772, 1773
Emerson	0591, 0675, 0821, 1268			KLH	0790
Enterprise	0591	Rio	0869	Koss	0651
ESA	0821, 1268	Rotel	0623	Oritron	0651
Fisher	0670	Sampo	0752	Polk Audio	0539
Funai	0675, 1268, 1334	Samsung	0490, 0573, 0744, 0820, 0899, 1044, 1075, 1470	RCA	0790
Gateway	1158			Rio	0869
GE	0522, 0815, 0717	Sansui	0695	Sonic Blue	0869
Go Video	0744, 0715, 0741, 0783, 0833, 0869, 1044, 1075, 1099, 1158, 1304, 1730	Sanyo	0670, 0695, 0873	Teac	0790
		Sensory Science	1158	Venturer	0790
		Sharp	0630, 0675, 0752, 1256		
GoldStar	0741				
Greenhill	0717	Sharper Image	1117		
Harman/Kardon	0582, 0702	Sherwood	0770		
Hitachi	0573, 0664, 1247	Shinsonic	0533, 0839		
Hiteker	0672	Sonic Blue	0869, 1099		
Humax	1500, 1588	Sony	0533, 1533, 0864, 1033, 1431, 1536		
iLo	1348				
Initial	0717	Superscan	0821		
Insignia	1268	Sylvania	0675, 0821, 1268		
Integra	0627	Symphonic	0675, 0821		
JBL	0702	Teac	0717, 0790		
Jensen	1016	Technics	0490, 0703		
JVC	0558, 0623, 0867, 1164, 1602, 1770, 1771, 1772, 1773	Theta Digital	0571		
		Tivo	1503		
Kawasaki	0790	Toshiba	0503, 0695, 1045, 1154, 1503, 1515, 1588		
Kenwood	0490, 0534				
KLH	0717, 0790, 1149	Urban Concepts	0503		
Koss	0651	US Logic	0839		
Lasonic	0798	Venturer	0790		
Lenoxx	1127	Xbox	0522, 1708		
LG	0591, 0741, 0869	Yamaha	0490, 0539, 0545		
LiteOn	1058, 1158, 1416, 1440	Zenith	0503, 0591, 0741, 0869		

Remote Programming

Audio mode

Amplifier		Receiver		Home Theater in Box	
Amstrad	0078	Koss	1366, 1497	Aiwa	1388, 1641
Bose	0674	Lasonic	1798	Amphion Media Works	1563, 1615
Curtis Mathes	0300	Lennox	1437	AMW	1563, 1615
Durabrand	1561	LG	1293, 1869	Anam	1609
GE	0078	Liquid Video	1497	Apex Digital	1257, 1430
Harman/Kardon	0892	Magnavox	1189, 1269, 0531,	Audiovox	1390
JVC	0331		1514	Bose	1229, 1933
Left Coast	0892	Marantz	1189, 1269, 0891,	Cambridge Soundworks	1370
Lennox	1561		1289	Classic	1352
Linn	0269, 0282, 0829	Mitsubishi	1393	Coby	1389
Marantz	0892, 0269	NexxTech	1751	Criterion	1420
NEC	0264	Norcent	1389, 1751	Daewoo	1250
Optimus	0300, 0823	Nova	1389	Denon	2832
Philips	0892, 0269	Orkyo	0135, 0842, 1298,	Durabrand	1561
Pioneer	0013, 0300, 0823		1320, 1531	Gateway	1517
Polk Audio	0892, 0269	Optimus	1023, 0531, 1074	Go Video	1532
RCA	0300, 0823	Oritron	1366, 1497	Initial	1426
Shure	0264	Panasonic	1308, 1518, 0367,	Insignia	1751
Sony	0689, 0815, 1126		1288, 1316, 1548,	Integra	1298
Soundesign	0078		1633, 1763, 1764	JBL	1306
Victor	0331	Philips	1189, 1269, 0891,	JVC	1374, 1495, 1676,
Wards	0078, 0013		1266, 1289, 1673		1871
Yamaha	0354, 0133	Pioneer	1023, 0014, 0150,	KLH	1390, 1412
			0531, 0630, 1123,	Koss	1366, 1497
			1384, 1823	Lasonic	1798
			1508	Lennox	1561
		Polaroid	1289, 1414	LG	1293, 1869
ADC	0531	Polk Audio	1289, 1414	LG	1293, 1869
Aiwa	1405, 0121, 1243,	Proscan	1254	Liquid Video	1497
	1388, 1641	RCA	1023, 1609, 1254,	Magnavox	1514
Akai	1512		0531, 1074, 1123,	NexxTech	1751
Alco	1390		1390, 1511	Norcent	1389, 1751
Amphion Media Works	1563, 1615	Regent	1437	Nova	1389
AMW	1563, 1615	Rio	1869	Onkyo	1298, 1531
Anam	1609, 1074	Saba	0531, 1519	Oritron	1366, 1497
Apex Digital	1257, 1430	Samsung	1295, 1500	Panasonic	1288, 1316, 1548,
Audiotronic	1189	Sansui	1764		1633, 1763, 1764
Audiovox	1390	Sanyo	1251, 1469	Philips	1266, 1673
Bose	1229, 0639, 1841,	Sharp	0771, 1286	Pioneer	1384
	1933	Sharper Image	1556	Polaroid	1508
Brix	1602	Sherwood	1517, 1653	Polk Audio	1289
Cambridge Soundworks	1370	Shinasonic	1426	RCA	1609, 1390, 1511
Capetronic	0531	Sirius	1602	Regent	1437
Carver	1189	Sonic Blue	1532, 1869	Rio	1869
Classic	1352	Sony	1058, 1441, 1258,	Saba	1519
Coby	1389		1759, 1622, 0474,	Samsung	1295, 1500
Criterion	1420		1406, 1558, 1658,	Sanyo	1469
Daewoo	1250		1758, 1858, 1958	Sharper Image	1556
Delphi	1414	Stereophonics	1023	Sherwood	1517
Denon	1360, 0771, 1142,	Sunfire	1313	Shinasonic	1426
	1660, 2832	Teac	0463, 1074, 1390,	Sonic Blue	1532, 1869
Garrard	0463		1528	Sony	0689, 1622, 1558,
Gateway	1517	Technics	1308, 1518, 1384		1658, 1758, 1858,
Go Video	1532	Thorens	1189		1958
Harman/Kardon	0110, 0891, 1304,	Toshiba	1788	Teac	1390, 1528
	1306	Venturer	1390	Toshiba	1788
Initial	1426	Wards	0014	Venturer	1390
Insignia	1751	XM	1406, 1414	Yamaha	1331, 1375
Integra	0135, 1298, 1320	Yamaha	0176, 1176, 1276,	Zenith	1293
JBL	0110, 1306		1331, 1375, 1476		
JVC	0531, 1374, 1495,	Zenith	0857, 1293		
	1560, 1676, 1871,				
	1894				
Kenwood	1313, 1570, 1569				
KLH	1390, 1412				

OSD Information

Weak Signal

This OSD appears when the digital channel that you have selected is too weak to receive or no signal is being detected for that channel.

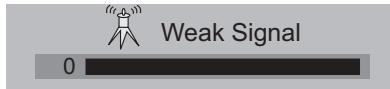

No Program

It appears when that channel is not receiving a signal and you have the Noise Muting function OFF and you have a single screen. It moves automatically every two seconds to prevent the screen from burn-in.

Notes:

- Even if "NO PROGRAM" appears on the screen, your timer functions and auto shut off functions that you set, are still active.
- If you are watching an analog channel, NO PROGRAM does not appear.

Invalid Signal

If you are inputting a PC signal that is invalid, "Invalid Signal" will appear on the TV screen. It appears when the input is PC and it is a single screen.

Troubleshooting

Refer to the table below to check the condition. If you think that there is a problem, contact the JVC Service Center where you purchased the television.

PROBLEMS	CHECK
There is no power	<ul style="list-style-type: none"> • See if the power cord became unplugged. • Check for a blown fuse or circuit breaker or a power outage.
There is no picture or sound	<ul style="list-style-type: none"> • The antenna could be disconnected. • The input mode could be set improperly. See page 59. • The tuner (Auto Tuner Setup) could be set improperly. See page 37. • The TV station may be having difficulties. Check to see if other stations are working. • Use the HDMI cable with HDMI logo HDMI. See page 19. • If you have a device connected to INPUT-1, INPUT-2 or INPUT-5 (set "V5 INPUT" in the INITIAL SETUP menu to "HDMI"). You will not be able to hear any audio from the AUDIO OUT on the back of the TV. • You cannot output audio using the OPTICAL OUTPUT when you have digital sound from an HDMI device connected to the INPUT-1, INPUT-2 or INPUT-5 (set "V5 INPUT" in the INITIAL SETUP menu to "HDMI") connection on the back of the TV. (See page 18). • This TV can accept 480i (Composite / S / HDMI / Component), 480p, 720p and 1080i signals. Please check your settings.
Remote control is not operating properly or at all	<ul style="list-style-type: none"> • Check to see that the batteries are still working and properly installed. • Make sure the remote has a clear sight path to the TV. • You may be too far from the TV. You must be within 23 feet (7 meters).
You cannot select a certain channel	<ul style="list-style-type: none"> • Make sure the channels have been programmed. See "Channel Summary", page 38. • Check to see if the channel is locked. See "Channel Summary - Lock" page 39.
The power turns off by itself	<ul style="list-style-type: none"> • Make sure the set did not become unplugged. • Perhaps the On/Off Timer is set. See page 57. • Check to see if the Sleep Timer was set. See page 66.
It does not operate correctly	<ul style="list-style-type: none"> • This television is operated by a microprocessor. It is possible that external noise or interference is causing the problem. If the television does not function correctly, remove the electrical plug from the wall outlet and wait a while before inserting it into the wall outlet again and operating the television.
The clock is wrong	<ul style="list-style-type: none"> • The power was interrupted and the clock was not reset. See page 56.
The color quality is poor	<ul style="list-style-type: none"> • Tint and Color may be improperly adjusted. See page 50. • The Video Status mode may be turned to the wrong setting. See page 65.
There are lines across the picture	<ul style="list-style-type: none"> • There could be interference from another electrical appliance, such as a computer, another TV or VCR. Move any such appliances further away from the TV.
The picture is spotted	<ul style="list-style-type: none"> • There could be interference from a high-wattage appliance, like a hairdryer or vacuum, operating nearby. Move the antenna away from the appliance or change to a coaxial cable connection which is less prone to interference.
There are double pictures (ghosts)	<ul style="list-style-type: none"> • A building or passing airplane can reflect the original signal and produce a second, slightly delayed one. Adjust your antenna position.
Picture is snowy (image noise)	<ul style="list-style-type: none"> • Your antenna may be damaged, disconnected or turned. Check the antenna connection. If the antenna is damaged, replace it.

Troubleshooting

PROBLEMS	CHECK
Screen is 80% black	• The Closed Caption Text mode is on. Turn it off in the Closed Caption Menu, page 34.
Stereo or bilingual programs can't be heard	• Make sure the MTS settings are correct. See page 64.
Static electricity	• It is normal to feel static electricity if you brush or touch the screen.
You hear occasional crackling sounds	• It is normal for the TV to make crackling sounds when first turned on or off. Unless the sound or picture become abnormal, this is fine.
It does not operate correctly	• Press the CHANNEL- and VOLUME- buttons on the side panel of the TV simultaneously for a few seconds. The Digital Tuner will be reset. If this does not reset it correctly, unplug the power cord and plug it back in.
The picture is slightly cut off when you use 1080p format only	• Change the picture format setting on your external device to 1080i or other resolution.
The screen disappears except for the menu screen	• This occurs when you select a digital menu when your input source is from the HDMI connection. Press the menu button.
My HDMI device doesn't work or doesn't work properly	• This JVC television can accept a variety of HD signals, including 720/60p, 1080/60i and 1080/60p. It does not accept a 1080/24p signal. Please note that in some cases, a Blu-ray or HD-DVD may only offer the choice of 1080/60i or 1080/24p. In this case, it is necessary to choose the 1080/60i output. Please refer to your Blu-ray/HD-DVD manual for complete details on choosing the correct output.

The following are not malfunctions.

- The television may make a creaking sound if the temperature of the room or the temperature of the inside of the television changes. If there is no problem with the screen or sound, then there is no need to worry.
- Although the picture may be temporarily disturbed and noise may be seen on the screen if the power is turned on immediately after it has been turned off, this is not a malfunction.

Specifications

Model	LT-37X898	LT-42X898	LT-47X898
Type	LCD Flat Television		
Reception Format	NTSC, BTSC System (Multi-Channel Sound) ATSC Terrestrial, Digital Cable		
Reception Range	VHF 2 to 13, UHF 14 to 69 at ATSC, CATV 135 Sub, Mid, Super, Hyper and Ultra bands at Digital Cable		
	VHF 2 to 13, UHF 14 to 69 CATV 125 Sub, Mid, Super, Hyper and Ultra bands (191 channel frequency synthesizer system) at Analog <ul style="list-style-type: none"> Reception of channel A-5 ("95" of the TV set's on-screen cable channel numbers) is not recommended for your TV set. 		
Power Source	AC 120V, 60 Hz		
Power Consumption	240W	280W	355W
Screen Size	37 inch / 94 cm measured diagonally, 16:9 ratio	42 inch / 106.7 cm measured diagonally, 16:9 ratio	47 inch / 119.4 cm measured diagonally, 16:9 ratio
Audio Output	10W + 10W		
Speakers	4.5 x 16cm Twin Oblique Cone x 2		
Antenna Terminal (VHF/UHF, ATSC/DIGITAL CABLE IN)	75 ohms (VHF/UHF)(F-type connector)		
Input 3, 4, 5 Terminal	480i S (Input 3) Y: 1 Vp-p positive, 75 ohms (negative sync provided) C: 0.286 Vp-p (burst signal), 75 ohms Video: 1 Vp-p, 75 ohms Audio: 500 mVrms (-4dBs) high impedance		
Input 3, 4 Terminal (Component Terminal)	1080i / 720p / 480p / 480i Y: 1 Vp-p positive, 75 ohms (negative sync provided) Pa/Pc: 0.7 Vp-p 75 ohms		
Input 1, 2, 5 Terminal (HDMI Input Terminal)	Video: 1080p / 1080i / 720p / 480p / 480i Audio: 2ch PCM, 32 / 44.1 / 48 KHz 16 / 20 / 24 bit <ul style="list-style-type: none"> Personal computer compatibility cannot be guaranteed. 		
Input 5 (PC Input Jacks)	Analog RGB D-SUB (15 pin) x 1, RS-232C (9 pin) x 1 <ul style="list-style-type: none"> PC signal is available. Refer to page 23 for details on the signals which can be input. 		
Audio Output Jacks (FIX)	FIX : 500mVrms (-4dBs), Low Impedance		
Optical Output Digital Audio	Digital Out (optical) x 1		
Dimensions (inch/cm) W X H X D	35 1/2 x 25 3/4 x 9 1/8 (with stand) 90.1 x 65.1 x 23 (with stand)	39 3/4 x 27 7/8 x 11 3/4 (with stand) 100.7 x 70.8 x 29.6 (with stand)	44 1/4 x 30 1/2 x 11 3/4 (with stand) 112.1 x 77.4 x 29.6 (with stand)
	35 1/2 x 23 3/4 x 5 1/2 (without stand) 90.1 x 60.1 x 13.9 (without stand)	39 3/4 x 26 x 5 1/8 (without stand) 100.7 x 66 x 13 (without stand)	44 1/4 x 28 5/8 x 5 1/8 (without stand) 112.1 x 72.7 x 13 (without stand)
Weight (lbs / kg)	52.8 / 24 (with stand)	61.6 / 28 (with stand)	77 / 35 (with stand)
	48.4 / 22 (without stand)	52.8 / 24 (without stand)	68.2 / 31 (without stand)
Accessories	Refer to "unpacking your TV", page 9		

Specifications subject to change without notice.

- The open source software is embedded in this product. For more information, please go to: http://software.jvc.com/opensource/lnx/DP/05_AtscQam/download.html



LIMITED WARRANTY

COLOR TV 1-1

For Canadian model televisions, see separate sheets for Canadian Warranty information.

JVC COMPANY OF AMERICA (JVC) warrants this product and all parts thereof, except as set forth below ONLY TO THE ORIGINAL RETAIL PURCHASER to be FREE FROM DEFECTIVE MATERIALS AND WORKMANSHIP from the date of original purchase for the period shown below. ("The Warranty Period")
FOR DIRECT-VIEW COLOR TELEVISION, PICTURE TUBE is covered for Two(2)years.

Parts	1 YEAR	Labor	1 YEAR
-------	---------------	-------	---------------

THIS LIMITED WARRANTY IS VALID ONLY IN THE FIFTY (50) UNITED STATES, THE DISTRICT OF COLUMBIA AND IN THE COMMONWEALTH OF PUERTO RICO.

WHAT WE WILL DO:

If this product is found to be defective within the warranty period, JVC will repair or replace defective parts with new or rebuilt equivalents at no charge to the original owner. Such repair and replacement services shall be rendered by JVC during normal business hours at JVC authorized service centers. Parts used for replacement are warranted only for the remainder of the Warranty Period. All products may be brought to a JVC authorized service center on a carry-in basis. Color televisions with a screen size of 27" or greater qualify for in-home service. In such cases, a technician will come to your home and either repair the TV there or remove and return it if it cannot be repaired in your home.

WHAT YOU MUST DO FOR WARRANTY SERVICE:

Please do not return your product to the retailer
Instead, return your product to the JVC authorized service center nearest you. If shipping the product to the service center, please be sure to package it carefully, preferably in the original packaging, and include a brief description of the problem(s). Please call 1-800-252-5722 to locate the nearest JVC authorized service center. Service locations can also be obtained from our website <http://www.jvc.com>. If your product qualifies for in-home service, the service representative will require clear access to the product.

If you have any questions concerning your JVC Product, please contact our Customer Care Center at 800-252-5722

WHAT IS NOT COVERED:

This limited warranty provided by JVC does not cover:

1. Products which have been subject to abuse, accident, alteration, modification, tampering, negligence, misuse, faulty installation, lack of reasonable care, or if repaired or serviced by anyone other than a service facility authorized by JVC to render such service, or if affixed to any attachment not provided with the products, or if the model or serial number has been altered, tampered with, defaced or removed;
2. Initial installation, installation and removal from cabinets or mounting systems.
3. Operational adjustments covered in the Owner's Manual, normal maintenance, video and audio head cleaning;
4. Damage that occurs in shipment, due to act of God, and cosmetic damage;
5. Signal reception problems and failures due to line power surge;
6. Video Pick-up Tubes/CCD Image Sensors are covered for 90 days from the date of purchase;
7. Accessories;
8. Batteries (except that Rechargeable Batteries are covered for 90 days from the date of purchase);
9. Products used for commercial purposes, including, but not limited to rental.

There are no express warranties except as listed above.

THE DURATION OF ANY IMPLIED WARRANTIES, INCLUDING THE IMPLIED WARRANTY OF MERCHANTABILITY, IS LIMITED TO THE DURATION OF THE EXPRESS WARRANTY HEREIN.

JVC SHALL NOT BE LIABLE FOR ANY LOSS OF USE OF THE PRODUCT, INCONVENIENCE, OR ANY OTHER DAMAGES, WHETHER DIRECT, INCIDENTAL OR CONSEQUENTIAL (INCLUDING, WITHOUT LIMITATION, DAMAGE TO TAPES, RECORDS OR DISCS) RESULTING FROM THE USE OF THIS PRODUCT, OR ARISING OUT OF ANY BREACH OF THIS WARRANTY. ALL EXPRESS AND IMPLIED WARRANTIES, INCLUDING THE WARRANTIES OF MERCHANTABILITY AND FITNESS FOR PARTICULAR PURPOSE, ARE LIMITED TO THE WARRANTY PERIOD SET FORTH ABOVE.

Some states do not allow the exclusion of incidental or consequential damages or limitations on how long an implied warranty lasts, so these limitations or exclusions may not apply to you. This warranty gives you specific legal rights and you may also have other rights which vary from state to state.

JVC COMPANY OF AMERICA
DIVISION OF JVC AMERICAS CORP.

1700 Valley Road
Wayne, NJ 07470

<http://www.jvc.com>

REFURBISHED PRODUCTS CARRY A SEPARATE WARRANTY, THIS WARRANTY DOES NOT APPLY. FOR DETAIL OF REFURBISHED PRODUCT WARRANTY, PLEASE REFER TO THE REFURBISHED PRODUCT WARRANTY INFORMATION PACKAGED WITH EACH REFURBISHED PRODUCT.

For customer use:

Enter below the Model No. and Serial No. which is located either on the rear, bottom or side of the cabinet. Retain this information for future reference.

Model No. : _____

Serial No. : _____

Purchase date : _____

Name of dealer : _____

TO OUR VALUED CUSTOMER ———

THANK YOU FOR PURCHASING THIS JVC PRODUCT.
WE WANT TO HELP YOU ACHIEVE A PERFECT EXPERIENCE.

**NEED HELP ON HOW TO HOOK UP?
NEED ASSISTANCE ON HOW TO OPERATE?
NEED TO LOCATE A JVC SERVICE CENTER?
LIKE TO PURCHASE ACCESSORIES?**

JVC[®] IS HERE TO HELP!
TOLL FREE: 1(800)252-5722
<http://www.jvc.com>

Remember to retain your Bill of Sale for Warranty Service.

————— **Do not attempt to service the product yourself** —————

Caution

To prevent electrical shock, do not open the cabinet.
There are no user serviceable parts inside.
Please refer to qualified service personnel for repairs.

Notes

Notes

Notes

JVC COMPANY OF AMERICA
Division of JVC Americas Corp.
1700 Valley Road
Wayne, New Jersey, 07470



JVC CANADA, INC.
21 Finchdene Square
Scarborough, Ontario
Canada, M1X 1A7

Free Manuals Download Website

<http://myh66.com>

<http://usermanuals.us>

<http://www.somanuals.com>

<http://www.4manuals.cc>

<http://www.manual-lib.com>

<http://www.404manual.com>

<http://www.luxmanual.com>

<http://aubethermostatmanual.com>

Golf course search by state

<http://golfingnear.com>

Email search by domain

<http://emailbydomain.com>

Auto manuals search

<http://auto.somanuals.com>

TV manuals search

<http://tv.somanuals.com>