



COLOR VIDEO MONITOR

BM-H1900SU BM-H1310SU

INSTRUCTIONS

For Customer Use:

Enter below the Model No. and Serial No. which is located on the rear of the cabinet. Retain this information for future reference.

Model No. _____

Serial No. _____

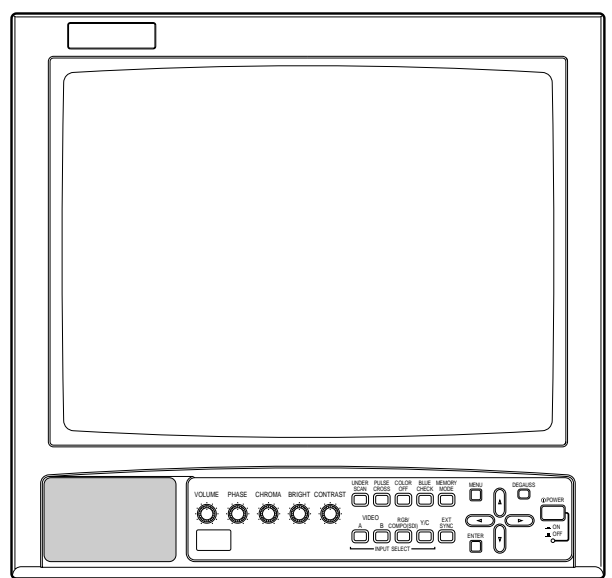

SAFETY PRECAUTIONS

WARNING:

TO PREVENT FIRE OR SHOCK HAZARDS, DO NOT EXPOSE THIS APPLIANCE TO RAIN OR MOISTURE.

INFORMATION

CAUTION: Changes or modification not approved by JVC could void the user's authority to operate the equipment.

NOTE: This equipment has been tested and found to comply with the limits for a Class A digital device, pursuant to Part 15 of the FCC Rules. These limits are designed to provide reasonable protection against harmful interference when the equipment is operated in a commercial environment. This equipment generates, uses, and can radiate radio frequency energy and, if not installed and used in accordance with the instruction manual, may cause harmful interference to radio communications. Operation of this equipment in a residential area is likely to cause harmful interference in which case the user will be required to correct the interference at his own expense.

■ PRECAUTIONS

- Prevent inflammables, water and metallic objects from entering the unit.
- Do not remodel or disassemble the unit. As the unit incorporates circuitry generating high voltage, physical danger and malfunctioning of the unit itself may result.
- Remove the AC power cord from the AC outlet when you are not using the unit for a long period.

■ HANDLING

- Do not apply shocks or vibrations. Malfunctioning of the unit is likely to result.
- Do not block the ventilation slots.
- Do not use it in externally hot places. Exposed to the direct sunlight for a long period of time or placed near a heater, the cabinet could become deformed, or the performance of the internal components may deteriorate.
- Do not place the unit near appliances generating strong electric or magnetic fields. Noisy or unstable pictures are likely to result.
- Keep the monitor clean by wiping the cabinet and CRT screen with a piece of soft cloth. Do not apply thinner or benzine. These chemicals can damage the surface finish and cause printed letters to be erased. Clean excessive soiling with a diluted neutral cleanser, then wipe away the cleanser with a dry cloth.

SCREEN BURN

- It is not recommended to keep a certain still image displayed on screen for a long time as well as displaying extremely bright images on screen. This may cause a burning (sticking) phenomenon on the screen of cathode-ray tube. This problem does not occur as far as displaying normal video playback motion images.

Thank you for purchasing this JVC color video monitor. Before using it, read and follow all instructions carefully to take fullest advantage of the monitor's performance.

CONTENTS

SAFETY PRECAUTIONS	2	MEMORY MODE	12
FEATURES	3	Recall/release of memory mode	12
CONTROLS AND FEATURES (FRONT)	4	Setting programming of the picture being monitored	12
TERMINALS AND FEATURES (REAR)	5	Revision of memory mode	12
CONNECTION EXAMPLE	6	SET-UP FOR MONITOR INSTALLATION	14
External/internal synchronization	6	To call up SET-UP MENU and select a function ---	14
RGB/COMPO(SDI) terminal setting	6	SIZE/CENTERING (size/positioning adjustments of RGB signal pictures) --	14
BASIC OPERATION	7	WHITE BALANCE ADJUST (white balance adjustments) --	15
To demagnetize the picture tube	7	REMOTE SELECT (TALLY/REMOTE-terminal settings) ----	15
PICTURE ADJUSTMENTS	8	STATUS DISPLAY (setting the status display to on/off) --	16
CONTRAST (picture contrast)	8	CONTROL LOCK (deactivation of front-control functions) --	16
BRIGHT (picture brightness)	8	PICTURE SETTING INITIALIZATION	17
CHROMA (picture color density)	8	To initialize MENU settings only	17
PHASE (picture hue)	8	To initialize both MENU/SET-UP MENU settings--	17
Relation between picture adjustments and input video signals --	8	REMOTE CONTROLS	18
VIDEO SIGNAL CONTROLS	9	On-screen menu remote operation	18
UNDER SCAN	9	Picture adjustments	18
PULSE CROSS	9	Sound adjustments	18
COLOR OFF	9	EACH REMOTE CONTROL OF PLURAL MONITORS --	19
BLUE CHECK	9	To program an ID number	19
ON-SCREEN MENU CONTROLS	10	To call up an ID number	19
Calling up the menu display, selecting an item	10	To assign a monitor	19
ASPECT RATIO (picture aspect ratio switching) --	10	BEFORE CALLING FOR SERVICE	20
FILTER SELECT (built-in filter selection)	10	MENU DISPLAY CHART	21
PEAKING FREQ./PEAKING LEVEL (picture quality improvement)	11	SPECIFICATIONS	22
AFC (switching of time constant for the AFC)	11		
COLOR TEMP. (color temperature switching)	11		
NTSC SETUP (NTSC set-up level)	11		
COMPO. LEVEL (chrominance level setting)	11		

FEATURES

- For multiple applications with various video systems; equipped with external source component terminals that can be bridge-connected.
- Compatible with NTSC-3.58/4.43 MHz or PAL color systems.
- The BM-H1900SU has a medium-high-definition picture tube that reproduces pictures with a horizontal resolution of 750 TV lines or more .
The BM-H1310SU has a high-definition picture tube that reproduces pictures with a horizontal resolution of 750 TV lines or more .
- Auto white-balance stabilizer (I/K feedback circuit) maintains stable color reproduction over long-term use.
- A range of flexible functions includes picture aspect ratio switching (between 4:3 and 16:9), memory mode and control lock.
- Optional exclusive wireless remote control unit enables individual operation and adjustment of up to 99-unit monitors.

CONTROLS AND FEATURES (FRONT)

[BM-H1900SU]

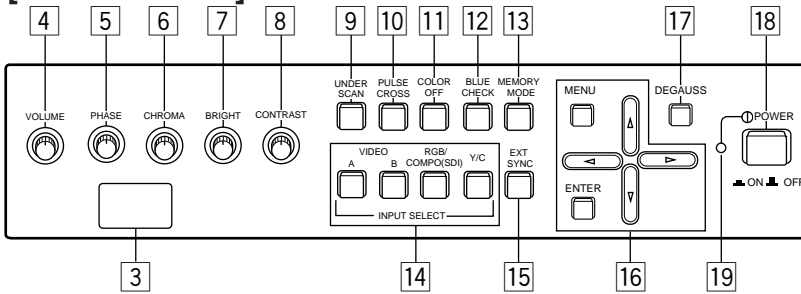

(Front)

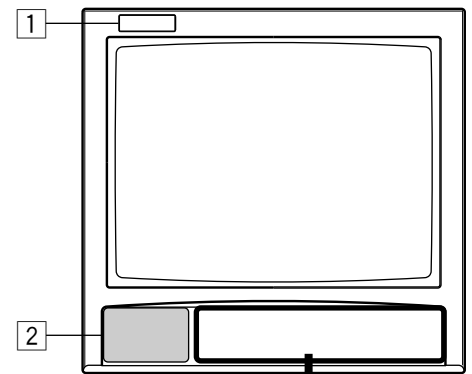

[BM-H1310SU]

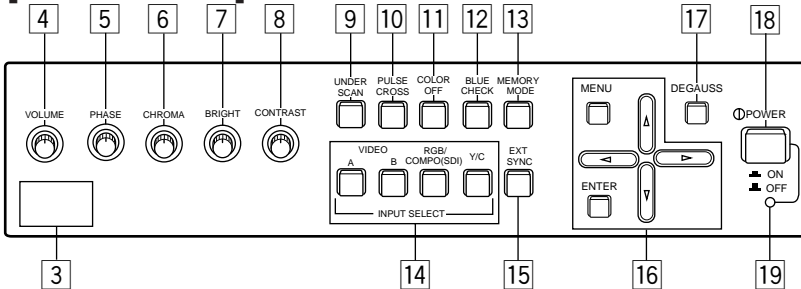

1 Tally lamp

Glow to indicate when a tally signal is input to the TALLY/REMOTE terminal on the rear panel. (For terminal connection, see page 15.)

2 Speaker

3 Remote control sensor

Senses infrared signals emitted from the optional wireless remote control.

4 VOLUME control

Turn to adjust speaker volume.

5 PHASE control

Turn to adjust picture hue, using natural skin color as a reference.

6 CHROMA control

Turn to adjust picture color density according to your requirements.

7 BRIGHT control

Turn to adjust picture brightness according to your requirements.

8 CONTRAST control

Turn to adjust the picture contrast according to your requirements.

9 UNDER SCAN switch

Push to display the whole picture on screen by reducing display area dimensions.

10 PULSE CROSS switch

Push to check the retrace period (sync signal) by delaying input signal phase.

11 COLOR OFF switch

Push to eliminate color signals and display a black-and-white picture.

12 BLUE CHECK switch

Push to eliminate red and green color signals and display a monochrome blue picture.

13 MEMORY MODE switch

Push to adjust the picture by recalling the adjustment data that you stored in memory.

14 INPUT SELECT switches

Push to select a rear terminal video signal input.

15 EXT SYNC switch

Push to synchronize the monitor with an external sync signal. This function is effective regardless of signal input.

16 MENU controls

Use to operate on-screen menu functions.

17 DEGAUSS switch

Push to demagnetize the picture tube.

18 POWER switch

Press to turn the power on or off.

19 POWER indicator

Glow to indicate that power is on.

TERMINALS AND FEATURES (REAR)

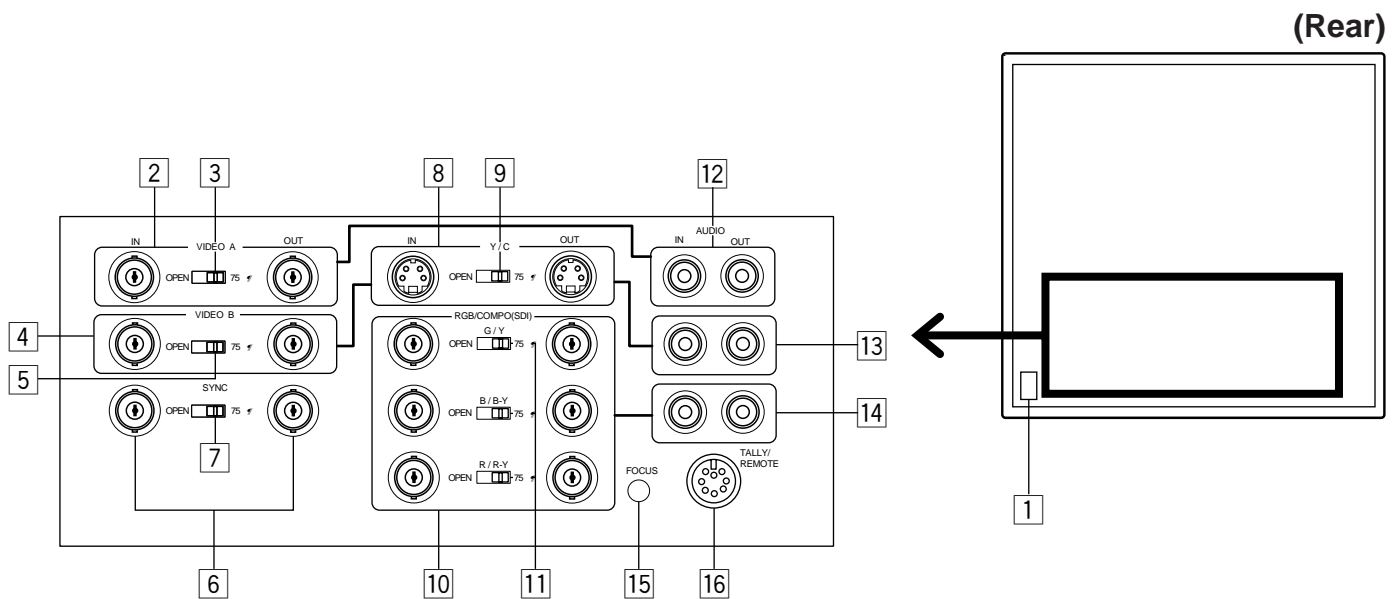

1 Power socket

Connect to an AC outlet (120 V AC, 50 Hz / 60 Hz) using the provided power cord.

2 VIDEO A terminals

Composite video signal input terminal and bridge-connected output terminal.

3 VIDEO A termination switch

Set to OPEN for bridged connection; set to 75 Ω for input signal only.

4 VIDEO B terminals

Composite video signal input terminal and bridge-connected output terminal.

5 VIDEO B termination switch

Functions as for [3].

6 SYNC terminals

External sync signal input terminal and bridge-connected output terminal. Input an external composite sync signal to these terminals when inputting a video signal without a sync signal, or when synchronizing the monitor with an external sync signal.

7 SYNC termination switch

Functions as for [3].

8 Y/C terminals

Input terminal of Y/C signals and bridge-connected output terminal.

9 Y/C termination switch

Functions as for [3].

10 RGB/COMPO(SDI) terminals

Input terminal of analog RGB signals or Y/B-Y/R-Y signals and bridge-connected output terminal. For analog RGB signals, also accepts a G signal including a sync signal.

11 RGB/COMPO(SDI) termination switch

Functions as for [3].

12 AUDIO A terminals

Audio signal input terminal and bridge-connected output terminal. Linked with the VIDEO A terminals so that AUDIO A terminals and VIDEO A terminals are selected simultaneously.

13 AUDIO B terminals

Audio signal input terminal and bridge-connected output terminal. Linked with the VIDEO B or Y/C terminals so that AUDIO B terminals and VIDEO B or Y/C terminals are selected simultaneously.

14 AUDIO RGB/COMPO(SDI) terminals

Audio signal input terminal and bridge-connected output terminal. Linked with the RGB/COMPO(SDI) terminals so that AUDIO RGB/COMPO(SDI) terminals and RGB/COMPO(SDI) terminals are selected simultaneously.

15 FOCUS control

Adjustment hole exclusively for use by service personnel. Make sure to consult qualified service personnel for adjustment.

16 TALLY/REMOTE terminal

External input terminal of a tally signal to make the tally lamp glow, or of a remote-control signal to switch input or picture control.

CONNECTION EXAMPLE



- Be sure to turn off each component's power before connection.
- The connection shown below is only an example. Terminals and their functions differ in accordance with a component to be connected. Also read and follow the instructions for the component.

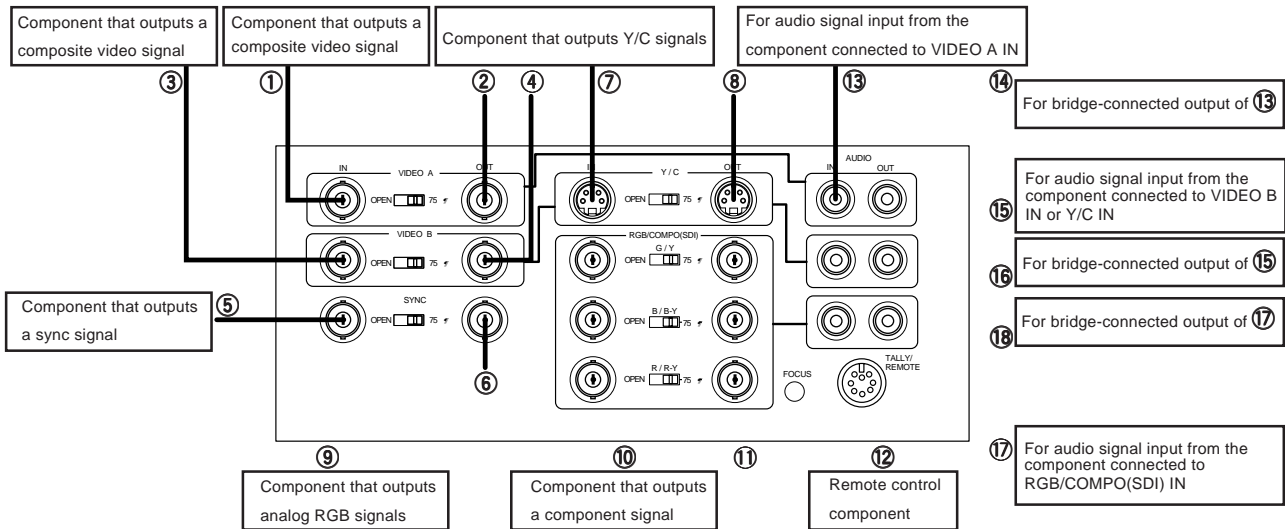

	Signal(s)	Terminal	Function
①	Composite video	VIDEO A IN	Input of a composite video signal
②	Composite video	VIDEO A OUT	Bridge-connected output of ①
③	Composite video	VIDEO B IN	Input of a composite video signal
④	Composite video	VIDEO B OUT	Bridge-connected output of ③
⑤	Composite sync	SYNC IN	Input of an external sync signal
⑥	Composite sync	SYNC OUT	Bridge-connected output of ⑤
⑦	Y/C	Y/C IN	Input of Y/C signals
⑧	Y/C	Y/C OUT	Bridge-connected output of ⑦
⑨	Analogue RGB	RGB/COMPO(SDI) IN	Input of analogue RGB signals
⑩	Component	RGB/COMPO(SDI) IN	Input of a component signal
⑪	Analogue RGB or component	RGB/COMPO(SDI) OUT	Bridge-connected output of ⑨ or ⑩
⑫	Tally/remote control	TALLY/REMOTE	Input of a tally signal or remote control signal

External/internal synchronization

Push the front panel EXT SYNC switch to ON, and the monitor operates to synchronize with an external sync signal input to the rear panel SYNC IN terminal.

Push the switch again to OFF, and the monitor operates to synchronize with a sync signal included in a video signal (if it includes a sync signal) input via a video input terminal.

RGB/COMPO(SDI) terminal setting

Set RGB or COMPO. on screen to match the type of video signal input to the rear panel RGB/COMPO(SDI) IN terminals.

To input analog RGB signals, set to RGB.

To input Y, B-Y or R-Y signal, set to COMPO.

Operation:

1. Press the front panel MENU button to call up the MENU display on screen.
2. Press the ▲ or ▼ button to select RGB/COMPO(SDI).
3. Press the ◀ or ▶ button to set RGB or COMPO..
4. Press the MENU button to complete.

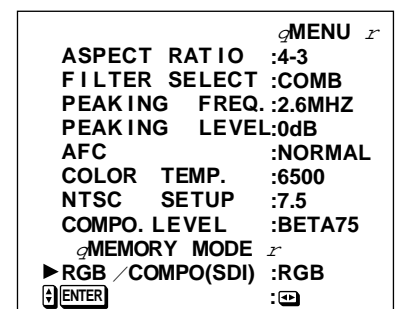

BASIC OPERATION

1. To turn the power on:

Push the **POWER** switch.

The POWER indicator glows green. The mode and color system of an input signal are automatically discerned and displayed on screen for about 3 seconds. To turn off power, push the POWER switch again, and the POWER indicator goes off.

2. To select the input:

Push an **INPUT SELECT** switch.

Push VIDEO A, VIDEO B, RGB/COMPO(SDI) or Y/C. The mode and color system of a selected input signal are automatically discerned and displayed on screen for about 3 seconds.

3. To adjust the audio level:

Turn the VOLUME control to the right to increase the level, or to the left to decrease the level.

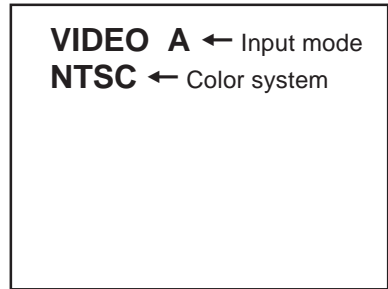

●Relation between input mode indication and signal input/terminal

Input mode indication	Signal input/terminal
VIDEO A	Composite video signal input to VIDEO A IN
VIDEO B	Composite video signal input to VIDEO B IN
Y/C	Y/C signal input to Y/C IN
RGB	Analogue RGB signal input to RGB/COMPO(SDI) IN
COMPO(SDI)	Component signal input to RGB/COMPO(SDI) IN

●Color system indication

indication	Colour system	Colour sub-carrier frequency	Vertical scanning frequency
NTSC	NTSC	3.58 MHz	60 Hz
PAL	PAL	4.43 MHz	50 Hz
N4.43	NTSC	4.43 MHz	60 Hz
B/W	(Indicates when a black-and-white signal is input)		
NO SYNC	(Indicates when no signal is input)		

To demagnetize the picture tube

After positioning near the monitor a speaker (non-magnet-shielded) or other equipment that generates a strong magnetic field, or after relocating the monitor, color patches could appear in the picture due to magnetization of the picture tube. If this occurs, push the **DEGAUSS** switch to demagnetize the picture tube.

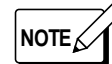

- This function is not effective if activated a second time after a very short time has elapsed. When degaussing must be repeated, proceed after at least 10 minutes have passed since first degaussing.
- The optional wireless remote control features a DEGAUSS key.

PICTURE ADJUSTMENTS

Turn a separate front panel control to adjust picture contrast, picture brightness, picture color density, and picture hue respectively:

CONTRAST (picture contrast) _____

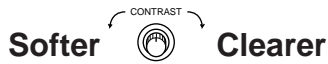

BRIGHT (picture brightness) _____

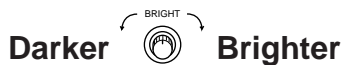

CHROMA (picture color density) _____

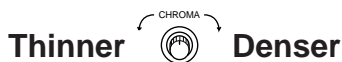

PHASE (picture hue) _____



- To adjust the CHROMA and PHASE controls more precisely, input the color bar signal and operate the BLUE CHECK function as follows:

After inputting the color bar signal, push the front panel BLUE CHECK switch to display a monochrome blue picture without red/green signal components. Turn the CHROMA and PHASE controls so that all (four, in the example below) blue bars have the same density and brightness.

Blue	Black	Blue	Black	Blue	Black	Blue

Relation between picture adjustments and input video signals —

Each picture adjustment is effective for the following video signal input:

Control \ Signal	Composite video, Y/C				RGB	COMPONENT
	NTSC	PAL	NTSC 4.43	B/W		
PHASE	Yes	No	Yes	No	No	No
CHROMA	Yes	Yes	Yes	No	No	Yes
BRIGHT	Yes	Yes	Yes	Yes	Yes	Yes
CONTRAST	Yes	Yes	Yes	Yes	Yes	Yes

VIDEO SIGNAL CONTROLS

Push each switch to ON or OFF for video signal control.

UNDER SCAN

Push the UNDER SCAN switch to reduce the dimensions of display area so the whole picture is displayed on screen. Use to check the picture frame.



PULSE CROSS

Push the PULSE CROSS switch to simultaneously display two blank areas crossed horizontally and vertically on screen ("Pulse Cross" display) by delaying the phase of the input signal. Use to check the vertical retrace line period, equalizing pulse period, vertical sync period, horizontal sync pulse, or burst signal.

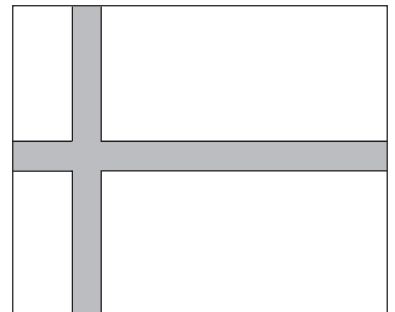

- This function is not effective for analog RGB signal input.

COLOR OFF

Push the COLOR OFF switch to display a black-and-white picture by inputting a luminance signal only. Use to check the noise contained in a luminance signal or white balance.



- This function is not effective for analog RGB signal input.

BLUE CHECK

Push the BLUE CHECK switch to display a monochrome blue picture by eliminating red and green signal components. Use to check or adjust the CHROMA and/or PHASE controls.

ON-SCREEN MENU CONTROLS

By calling up the menu display on screen, various functions can be selected and set as needed.



Calling up the menu display, selecting an item

1. Press the MENU button to call up the menu display on screen (see 1 below). (Press again to make the display disappear.)
2. Press the ▲ or ▼ button to select an item to be set. “▶” is indicated for the selected item.
3. Press the ◀ or ▶ button to change the setting.
4. After selecting another item by pressing the ▲ or ▼ button, repeat step 3. These settings are all kept in memory after power is turned off.
5. Press the MENU button to complete. The menu display disappears.

- When the menu display 1 (shown at left below) is on screen, press the ENTER button. The display changes to 2 (shown below center). In this state, you can also select the item or change the setting.
- When the display 2 is on screen, each time the ▼ button is pressed while the ENTER button pressed, the indication moves up or down on screen (the display 3). Press the MENU button with display 2 or 3 on screen, and the display is restored to 1.
- If no operation occurs for about 5 minutes after calling up the menu display on screen, the display disappears automatically.

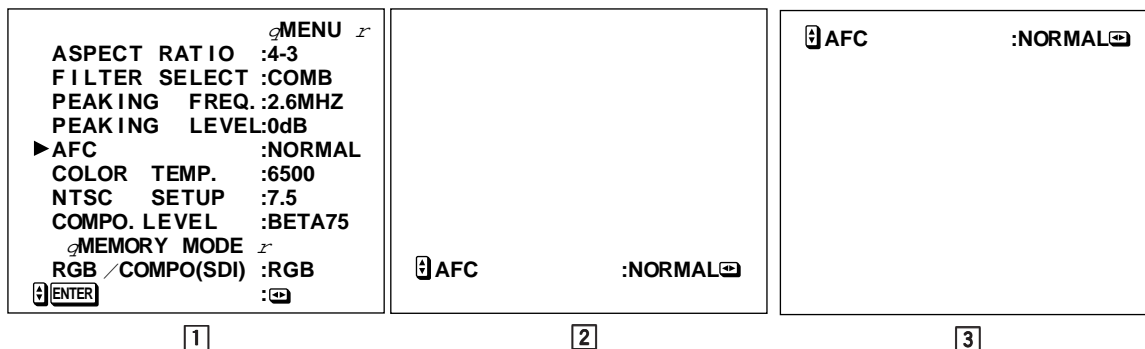

ASPECT RATIO (picture aspect ratio switching)

The aspect ratio of the picture can be switched between 4:3 and 16:9. When switching to “16-9” on screen, the height of the picture is slightly reduced (see right).

Setting	Function
4-3	Standard picture aspect ratio (4:3)
16-9	Displays the picture in 16:9 aspect ratio

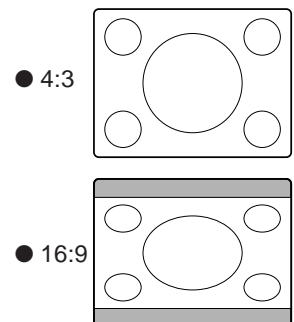

FILTER SELECT (built-in filter selection)

When a composite video signal of the NTSC system (excluding NTSC 4.43) is input to the monitor, either or both of two filters in the monitor can be activated.

Setting	Function
COMB (comb filter)	Reduces colour noise in NTSC video signals for clearer pictures.
BOTH (both filters)	Both comb and trap filters function at the same time.
NOTCH (Trap filter)	Eliminates dot interference that would show up in the vertical boundary between two different colours.



- The function can be operated and the indication appears only when a composite video signal of the NTSC system (excluding NTSC 4.43) is input to the monitor.

ON-SCREEN MENU CONTROLS (continued)

PEAKING FREQ./PEAKING LEVEL (picture quality improvement) —

Corrects the luminance signal to improve picture quality by changing peak frequency and/or peak level depending on the video signal input to the monitor. Use **PEAKING FREQ.** to set correction frequency. Use **PEAKING LEVEL** to set correction level.

Setting (frequency)	Function
2.6 MHz	For composite video signal or Y/C signal.
5.0 MHz	For component video signal.

Setting (level)	Function
0 dB to +9 dBs	Set a higher level for correction to a higher degree.



- When analog RGB signals are input to the monitor, the indications do not appear and the functions cannot be operated.

AFC (switching of time constant for the AFC) —

Use to set the time constant for the AFC (auto fine-frequency control) to correct skew distortion of video signals input via a videotape recorder or other video equipment.

Setting	Function
NORMAL	Normal-speed correction.
FAST	Faster correction.
SLOW	Slower correction.



- By changing the default setting of white balance adjustment under the SET-UP MENU display (see page 15 for adjustment), the * indication is added to the right of the setting to indicate that the factory-preset setting was changed.

COLOR TEMP. (color temperature switching) —

Use to set the color temperature of white balance.

Setting	Function
9300	To 9300K.
6500	To 6500K.

ASPECT RATIO	:4-3	MENU *
FILTER SELECT	:COMB	
PEAKING FREQ.	:2.6MHZ	
PEAKING LEVEL	:0dB	
AFC	:NORMAL	
▶ COLOR TEMP.	:6500	
NTSC SETUP	:7.5	
COMPO. LEVEL	:BETA75	
MEMORY MODE	*	
RGB / COMPO(SDI)	:RGB	
ENTER		EXIT

NTSC SETUP (NTSC set-up level) —

Use to set up the luminance signal level to match the configuration of the video signal input to the monitor.

Setting	Function
0	For video signal with 0% luminance signal.
7.5	For video signal with 7.5% luminance signal.



- The item and setting are indicated on screen and the function can be operated only when a video signal of the NTSC system is input to the monitor.

COMPO. LEVEL (chrominance level setting) —

Use to set the chrominance level of a component video signal.

Setting	Function
SMPTE	For component video signal input via an MII videotape recorder.
BETA00	For component video signal input (set-up level:0%) via a BETACAM videotape recorder.
BETA75	For component video signal input (set-up level:7.5%) via a BETACAM videotape recorder.



- The item and setting are indicated on screen and the function can be operated only when a component video signal is input to the monitor.

MEMORY MODE

A set of picture settings can be programmed in memory for quick recall when necessary.

Recall/release of memory mode

Press the MEMORY MODE switch to recall a set of picture settings programmed in memory.

Pressing the switch locks the functions of the front-panel PHASE, CHROMA, BRIGHT, CONTRAST controls, and remote-control picture adjustments not to be operated.

Press again to release memory mode.



- If you attempt to operate a locked function, "MEMORY MODE ON!!" appears on screen for approx. 2 seconds to indicate the function cannot be operated.

Setting programming of the picture being monitored

The settings of the picture being monitored can be programmed in memory.

Settings programmable in memory mode:

- Settings of the CONTRAST, BRIGHT, CHROMA and PHASE controls on the front panel
- On-screen menu function settings (except RGB/COMPO(SDI))
- Remote-control picture adjustment settings

1. Check the MEMORY MODE switch is off.
2. Press the MENU button.
3. Press the ▲ or ▼ button to select MEMORY MODE.
Then press the ENTER button.
4. ● Press the ENTER button to program.
● Press the ◀ or ▶ button to cancel.



- Programmed picture settings are kept in memory after the power is turned off.

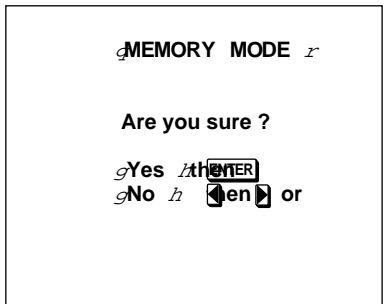

Revision of memory mode

Programmed picture settings can be revised if necessary.

1. Press the MEMORY MODE switch to activate memory mode.
2. Press the MENU button to call up display 1 on screen.



- No matter what video signal is input, all items appear on screen. However, depending on the type of input video signal, some functions might not operate even if their settings are made.

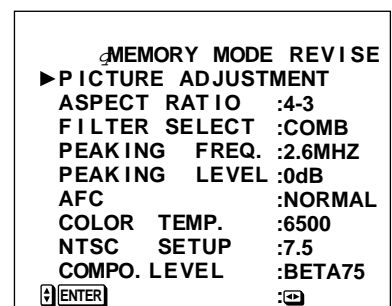

1

MEMORY MODE (continued)

3. Press the ▲ or ▼ button to select a function to be revised.

Press the ENTER button after selecting PICTURE ADJUSTMENT to call up display [2].

After making all settings on screen, press the MENU button to make display [1] appear.

4. Press the ◀ or ▶ button to change the set level.

Adjustable CONTRAST, BRIGHT, CHROMA or PHASE range depends on each set level previously stored in memory. MAX appears to indicate maximum level that cannot be increased. MIN appears to indicate minimum level that cannot be decreased.

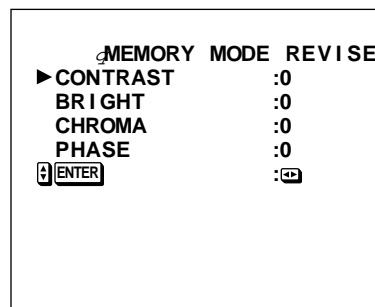

[2]

Variable setting range

Function	Variable setting range	Default set level	
PICTURE ADJUSTMENT	CONTRAST	-20 to +20	0
	BRIGHT	-20 to +20	0
	CHROMA	-20 to +20	0
	PHASE	-20 to +20	0
ASPECT RATIO	4:3 16:9	4:3	
FILTER SELECT	COMB BOTH NOTCH	COMB	
PEAKING FREQ.	2.6MHz 5.0MHz	2.6MHz	
PEAKING LEVEL	0dB + 1dB . . . + 9dB	0dB	
AFC	NORMAL FAST SLOW	NORMAL	
COLOR TEMP	9300 6500	6500	
NTSC SET UP	0 7.5	7.5	
COMPO. LEVEL	SMPTE BETA00 BETA75	BETA75	



- If the ENTER button is pressed after a function other than PICTURE ADJUSTMENT is selected, the on-screen display changes into a single-line one. To select another function after making a change in function, press the MENU button to restore display [1].

5. With display [1] on screen, press the MENU button to make display [3] appear.

- Press the ENTER button to program.
- Press the ◀ or ▶ button to cancel.

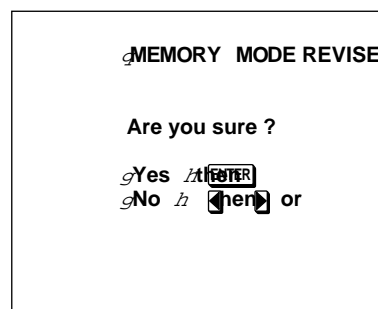

[3]

SET-UP FOR MONITOR INSTALLATION

When installing the monitor, make set-up adjustments required for the picture settings to match conditions where the monitor is to be used.

To call up SET-UP MENU and select a function: —

1. To make **1** (SET-UP MENU) appear, with the ENTER button pressed, press the MENU button.
2. Press the ▲ or ▼ button to select an adjustment item.
(To set STATUS DISPLAY or CONTROL LOCK, steps **3** and **4** are not necessary.)
3. Press the ENTER button to call up the adjustment menu **2** of a selected item (e.g. WHITE BALANCE).
4. Press the ▲ or ▼ button to select a function to be adjusted.
5. Press the ◀ or ▶ button to change the setting.
6. With the display **1** on screen, press the ▲ or ▼ button to select another function and repeat step **5**.
7. Press the MENU button to complete. SET-UP MENU disappears.
To make **1** (SET-UP MENU) disappear:
Press the MENU button.
To make **2** (e.g. WHITE BALANCE) disappear:
Press the MENU button twice.

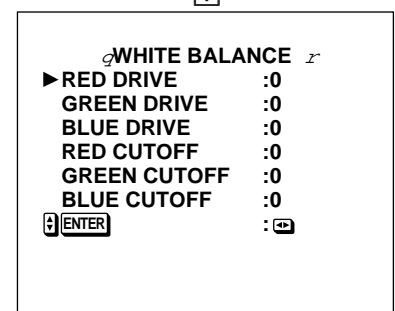
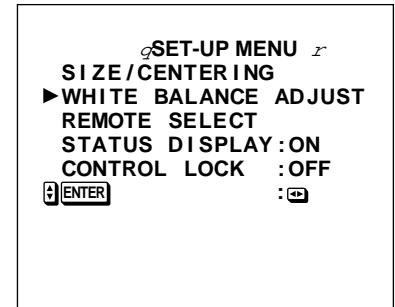

- Each time the MENU button is pressed, the previous menu is restored.

SIZE/CENTERING (size/positioning adjustments of RGB signal pictures) —

For analog RGB video signal pictures, horizontal size, vertical size, horizontal positioning and vertical positioning can be finely adjusted.

Adjustment	Function
H.POSITION (-10,-9...0...+9, +10)	+ moves the picture to right. - moves the picture to left.
V.POSITION (-10,-9...0...+9, +10)	+ moves the picture down. - moves the picture up.
H.SIZE (-10,-9...0...+9, +10)	+ makes the picture wider. - makes the picture narrower.
V.SIZE (-10,-9...0...+9, +10)	+ makes the picture higher. - makes the picture lower.



- SIZE/CENTERING appears and the function is operable only when monitoring the picture of analog RGB video signals.

SET-UP FOR MONITOR INSTALLATION (continued)

WHITE BALANCE ADJUST (white balance adjustments) —

Before making these adjustments, select the color temperature 9300K or 6500K on MENU.

Adjustment (level)	Function
RED DRIVE (-10,-9...0...+9, +10)	Adjusts the drive level of a red signal component.
GREEN DRIVE (-10,-9...0...+9, +10)	Adjusts the drive level of a green signal component.
BLUE DRIVE (-10,-9...0...+9, +10)	Adjusts the drive level of a blue signal component.
RED CUTOFF (-10,-9...0...+9, +10)	Sets the cut-off voltage of a red signal component.
GREEN CUTOFF (-10,-9...0...+9, +10)	Sets the cut-off voltage of a green signal component.
BLUE CUTOFF (-10,-9...0...+9, +10)	Sets the cut-off voltage of a blue signal component.



- By making white balance adjustments on SET-UP MENU, * appears to the right of the COLOR TEMP. setting on MENU (see page 11).

REMOTE SELECT (TALLY/REMOTE-terminal settings) —

Via the TALLY/REMOTE terminal, the tally lamp can be turned on/off, or a function (selected from display **3** shown on the right) can be operated using an external control.

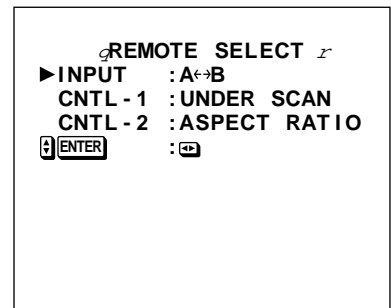

INPUT setting indications and selected inputs

*: indicates when deactivating the remote control via the TALLY/REMOTE terminal

Setting Indication	NOT USE	A↔B	A↔Y/C	A↔RGB	A↔COMPO	B↔Y/C	B↔RGB	B↔COMPO	Y/C↔RGB	Y/C↔COMPO	RGB↔COMPO
Short-circuit	*	A	A	A	A	B	B	B	Y/C	Y/C	RGB
Open-circuit	*	B	Y/C	RGB	COMPO.	Y/C	RGB	COMPO.	RGB	COMPO.	COMPO.

3

CNTL-1/CNTL-2 setting indications and set positions

*: indicates when deactivating the remote control via the TALLY/REMOTE terminal

Setting Indication	NOT USE	UNDER SCAN	PULSE CROSS	COLOR OFF	BLUE CHECK	EXTERNAL SYNC	ASPECT RATIO	COLOR TEMP.	AUDIO MUTE
Short-circuit	*	ON	ON	ON	ON	External	16-9	6500	ON
Open-circuit	*	OFF	OFF	OFF	OFF	Internal	4-3	9300	OFF

● TALLY/REMOTE terminal functions

All controls via TALLY/REMOTE terminal are made by short-circuiting or open-circuiting any pin from Pin 1 to 4 and either Pin 7 or 8 (GND each) of this terminal.

When using this terminal, be sure to short-circuit Pin 5 and either Pin 7 or 8.

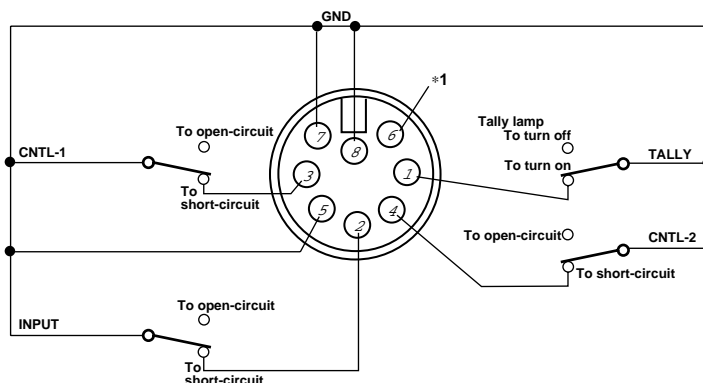

- When the TALLY/REMOTE terminal is used, the following functions become deactivated (except when they are set to "NOT USE"):
 - Front INPUT SELECT and EXT SYNC switches
 - Front UNDER SCAN, PULSE CROSS, COLOR OFF and BLUE CHECK switches
 - On-screen MENU's ASPECT RATIO and COLOR TEMP. functions
 - Remote MUTE key
- If a function is applied to both CNTL-1 and CNTL-2, CNTL-1 has priority.

*1: Pin 6 is DC power output pin. It outputs DC 5 V when the monitor's power is on. (Do not short-circuit pin 6 directly to ground.)

SET-UP FOR MONITOR INSTALLATION (continued)

STATUS DISPLAY (setting the status display to on/off) —

When the power is turned on or the input mode is switched, the status display (color system and input mode) appears on screen. The display can be set to on or off.

Setting	Function
ON	Status display appears.
OFF	Status display does not appear.

CONTROL LOCK (deactivation of front-control functions) —

Set CONTROL LOCK to ON on screen to deactivate the front-control functions (front VOLUME control and remote volume control are operable).

Setting	Function
ON	Deactivates the front controls (except front/remote volume controls).
OFF	Releases deactivated functions.



- If you attempt to operate a locked function, "CONTROL LOCK ON!!!" appears on screen for approx. 2 seconds to indicate the function cannot be operated.
- Once CONTROL LOCK is deactivated, the current settings of the front-control knobs and buttons are activated.
- If the power is turned off with CONTROL LOCK activated, the function is kept in memory.

PICTURE SETTING INITIALIZATION

The MENU and/or SET-UP MENU settings, including changes added later by the user, can be reset (initialized) to their initial (default) settings.

To initialize MENU settings only

MENU settings (except MEMORY MODE and RGB/COMPO(SDI)) can be exclusively reset:

1. With the ▼ button pressed, press the MENU button to display **1** on screen.
2. ● Press the ENTER button to reset.
 - Press the ◀ or ▶ button to cancel.

● MENU and PICTURE ADJUST settings (except MEMORY MODE and RGB/COMPO(SDI)) can also be simultaneously reset via the optional wireless remote control unit:

1. Press the MENU key to display MENU on screen.
2. Press the RESET key to execute.



- For initial (default) MENU settings, see page 21.

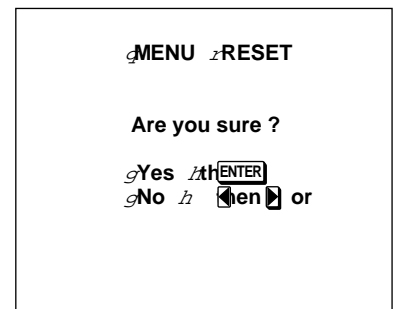

1

To initialize both MENU/SET-UP MENU settings

MENU and SET-UP MENU settings other than MEMORY MODE and RGB/COMPO(SDI) can be reset at the same time. In this case, PICTURE ADJUST settings via remote control are also reset, and the monitor's ID number is also reset to 00.

1. Press the POWER switch to turn the power off.
2. With the ▼ and MENU buttons pressed, press the POWER switch to turn the power on. Keep pressing the ▼ and MENU buttons until **2** appears on screen.
3. Press the ▲ or ▼ button to select SET-UP MENU RESET. Then press the ENTER button to display **3** on screen.
4. ● Press the ENTER button again to execute.
 - Press the ◀ or ▶ button to cancel.

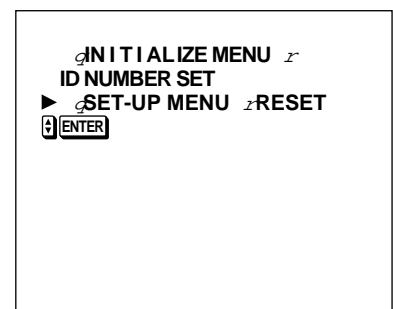

2

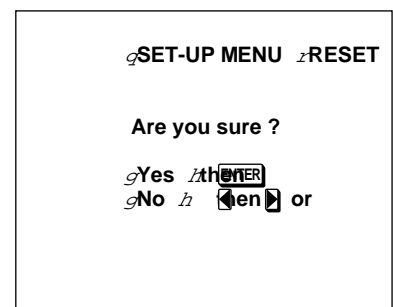

3

REMOTE CONTROLS

The optional wireless remote control unit (RM-C550W) operates the following:

- On-screen menu functions (MENU, SET-UP MENU, etc.)
- Picture adjustments (CONTRAST, BRIGHT, CHROMA, PHASE)
- Sound adjustments (VOLUME, MUTE)

On-screen menu remote operation

Remote keys and front controls with the same designation share the common functions. For detailed operation, see instructions about each menu function in this manual.

Picture adjustments

Each adjustable range depends on the setting of the front CONTRAST/BRIGHT/CHROMA or PHASE control. If an adjustment is made via remote control with the front control set approximately to the maximum or minimum, the level may indicate a certain change on screen but may not actually increase or decrease.

1. Press the PICTURE key to display PICTURE ADJUST.
2. Press the ▲ or ▼ key to select an item.
3. Press the ◀ or ▶ key to change the level:
 - ◀ : Moves the cursor to left (to decrease the level).
 - ▶ : Moves the cursor to right (to increase the level).
4. Press the ▲ or ▼ key to another item and repeat step 3.
5. Press the PICTURE key to complete.

- To standardize all settings on PICTURE ADJUST:
After step 1, press the RESET key.

Sound adjustments

A variable range depends on the setting of the front VOLUME control. If audio level is remote-controlled with front VOLUME control set approximately to the maximum or minimum, the level may indicate a certain change on screen but may not actually increase or decrease.

- Press the VOLUME – or + key to decrease or increase the level (within ±20).
- Press the MUTE key to mute the sound. MUTE appears on screen for approx. 3 seconds. Press again to release.



- When monitoring the picture of analog RGB signals, component signal or black-and-white signal, CHROMA and PHASE do not appear and cannot be adjusted.
- When a video signal of the PAL system is input to the monitor, PHASE does not appear and cannot be adjusted.

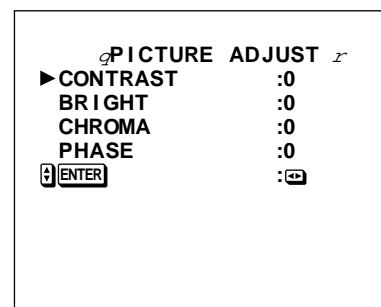

- Each time the PICTURE key is pressed, the previous display is restored.

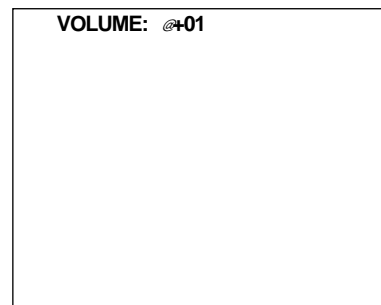

- If the power is turned off with sound-muting activated, the function is kept in memory.
- To release sound-muting, turn the front VOLUME control or press the remote VOLUME – or + key.

EACH REMOTE CONTROL OF PLURAL MONITORS

To operate or adjust plural units of monitors, by programming and assigning an ID number (00 to 99) for each monitor, a specified monitor can be remote-controlled.

To program an ID number (use front controls):

1. Press the POWER switch to turn the power off.
2. With the ▼ and MENU buttons pressed, press the POWER switch to turn the power on. Keep pressing the ▼ and MENU buttons until **1** appears.
3. Press the ▲ or ▼ button to select ID NUMBER SET. Then press the ENTER button to display **2**.
4. Select an ID number.
Press the ► button to increase.
Press the ◀ button to decrease.
5. Press the ENTER button to program.

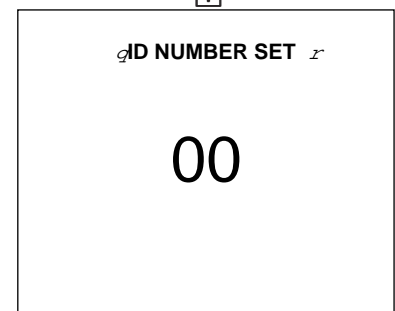
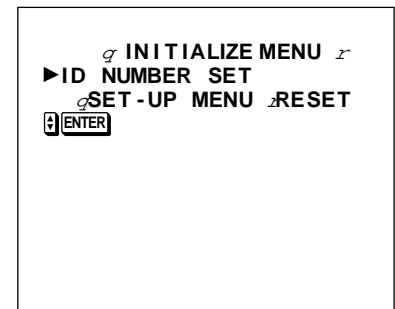

To call up an ID number (use remote unit):

1. Press the DISPLAY key to indicate a programmed ID number at top right of the screen.
 - Red-indicated ID number:
indicates the monitor can be remote-controlled.
 - Green-indicated ID number:
indicates the monitor cannot be remote-controlled.
2. Press the DISPLAY key to make the number disappear.

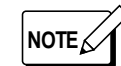

- ID number 00 is always indicated in red.

To assign a monitor (use remote control):

1. Press the DISPLAY key to display the monitor's programmed ID number.
2. Press the numeric keys to enter the monitor's ID number.
The entered ID number appears and blinks on screen center.
3. Press the ID SET key to complete.
The programmed ID number in the top right of the screen turns red to indicate the monitor was assigned. Other monitors' ID numbers are indicated in green.
4. After adjusting the monitor, repeat steps 2 to 4 to adjust each monitor if necessary.
5. Press the DISPLAY key to clear on-screen ID numbers.

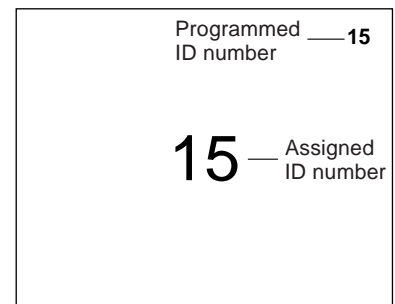

BEFORE CALLING FOR SERVICE

Before concluding a problem has occurred, check the following points. If the problem persists after carrying out the checks, disconnect the power cord from the AC outlet and consult the dealer from whom you purchased the monitor.

Problems	Points to be checked	Measures
Inoperable adjustment controls or buttons.	Is MEMORY MODE switched on?	Switch off.
	Is CONTROL LOCK activated?	Deactivate it.
Abnormal picture adjustments with all controls at centre.	Are PICTURE ADJUST menu settings changed via remote control?	Reset to standard settings.
Inoperable picture synchronisation.	Is EXT SYNC switched on?	Switch to off.
Inoperable remote-controlled picture adjustments.	Are the front controls set approximately to the maximum or minimum?	If so, the settings may not extend any more via remote control (although setting levels indicated on screen may show a slight change).
Assigned remote control ID number operates another monitor.	Is ID number 00 programmed for other monitors?	Programme an ID number other than 00.
	Do other monitors indicate a red ID number?	Assign the ID number again.
Inoperable remote control.	Is the ID number programmed for other monitors assigned?	Assign the monitor's programmed ID number.
No sound via audio signal input.	Does the audio input terminal match the video input terminal?	Each audio input terminal is linked with a video input terminal.
No INITIALIZE MENU display.	Are you pressing the ▼ and MENU buttons until it appears?	Keep pressing these buttons until it appears.
Inoperable CNTL-2 external control via TALLY/REMOTE terminal.	Is a function applied common to CNTL-1 and CNTL-2?	Set other functions to CNTL-2.

MENU DISPLAY CHART

The initial (default) adjustments/settings are shown in the menus below.

When the monitor was shipped from the factory, the NTSC SETUP had been set to 7.5 and the COMPO. LEVEL to BETA 75.

For PICTURE ADJUST MENU via remote control, see page 18.

MENU

Menu functions

```

MENU x
ASPECT RATIO :4-3
FILTER SELECT :COMB
PEAKING FREQ.:2.6MHZ
PEAKING LEVEL:0dB
AFC :NORMAL
COLOR TEMP. :6500
NTSC SETUP :7.5
COMPO. LEVEL :BETA75
MEMORY MODE x
▶RGB /COMPO(SDI) :RGB
[ENTER] :
    
```

Memory-Mode programming

```

MEMORY MODE x

Are you sure ?
Yes [ENTER]
No [F1] or [F2]
    
```

ENTER

MEMORY MODE + MENU

Memory-Mode revision menu

```

MEMORY MODE REVISE
▶PICTURE ADJUSTMENT
ASPECT RATIO :4-3
FILTER SELECT :COMB
PEAKING FREQ.:2.6MHZ
PEAKING LEVEL:0dB
AFC :NORMAL
COLOR TEMP. :6500
NTSC SETUP :7.5
COMPO. LEVEL :BETA75
[ENTER] :
    
```

Memory-Mode picture adjustments

```

MEMORY MODE REVISE
▶CONTRAST :0
BRIGHT :0
CHROMA :0
PHASE :0
[ENTER] :
    
```

Memory-Mode revision

```

MEMORY MODE REVISE

Are you sure ?
Yes [ENTER]
No [F1] or [F2]
    
```

ENTER

ENTER + MENU

Set-up for monitor installation

```

SET-UP MENU x
▶SIZE/CENTERING
WHITE BALANCE ADJUST
REMOTE SELECT
STATUS DISPLAY:ON
CONTROL LOCK :OFF
[ENTER] :
    
```

RGB-signal picture size/positioning adjustments

```

SIZE/CENTERING x
▶H. POSITION :0
V. POSITION :0
H. SIZE :0
V. SIZE :0
[ENTER] :
    
```

White-balance adjustments

```

WHITE BALANCE x
▶RED DRIVE :0
GREEN DRIVE :0
BLUE DRIVE :0
RED CUTOFF :0
GREEN CUTOFF :0
BLUE CUTOFF :0
[ENTER] :
    
```

ENTER

ENTER

¥ + MENU

Menu-function resetting

```

MENU xRESET

Are you sure ?
Yes [ENTER]
No [F1] or [F2]
    
```

Remote-terminal settings

```

REMOTE SELECT x
▶INPUT :NOT USE
CNTL - 1 :NOT USE
CNTL - 2 :NOT USE
[ENTER] :
    
```

ENTER

¥ + MENU + POWER

"Initialize" menu

```

INITIALIZE MENU x
▶ID NUMBER SET
SET-UP MENU xRESET
[ENTER] :
    
```

ID-number programming

```

ID NUMBER SET x

00
    
```

Menu-function standardization

```

SET-UP MENU xRESET

Are you sure ?
Yes [ENTER]
No [F1] or [F2]
    
```

ENTER

ENTER

SPECIFICATIONS

Type	: Color video monitor	: Y, R-Y, B-Y component
Color systems	: NTSC 3.58 MHz, NTSC 4.43 MHz, PAL	RGB / COMPO (SDI)
Picture tube	: [BM-H1900SU] 19" (47.5 cm) diagonally measured, 90° deflection, in-line gun, medium- high-definition cathode-ray tube, tri- dot type (dot pitch of 0.4 mm), SMPTE-C phosphor	(1 line: common with analog RGB) Y: 1.0 V (p-p), 75 Ω, negative sync R-Y, B-Y: 0.7 V (p-p), 75 Ω
	[BM-H1310SU] 13" (33 cm) diagonally measured, 90° deflection, in-line gun, high-definition tinted cathode ray tube, trio-dot type (dot pitch of 0.28 mm)	External sync inputs : SYNC (1 line), BNC x 2 (with 1 bridge-connected output) 0.2 V (p-p) – 4.0 V (p-p) composite sync, 75 Ω, negative sync Termination switch provided
Screen size (W x H)	: [BM-H1900SU] 15-11/16" x 11-3/4" (399 mm x 298 mm)	Audio inputs : AUDIO A, B, RGB / COMPO (SDI) (3 lines), RCA x 2 each (with 1 bridge-connected output) 500 mV (rms), high impedance
	[BM-H1310SU] 11-1/16" x 8-5/16" (280 mm x 210 mm)	Tally/remote terminal : TALLY / REMOTE, DIN (8-pin) x 1
Scanning frequency	: H: 15.734 kHz (NTSC 3.58 MHz / 4.43 MHz) 15.625 kHz (PAL) V: 59.94 Hz (NTSC 3.58 MHz / 4.43 MHz) 50 Hz (PAL)	Audio power output : 1.6 W Built-in speaker : 3-9/16" x 2" (9 cm x 5 cm) oval x 1 Operation temperature: 0 °C – 40 °C (20 % – 80 % RH) Power requirements : 120 V AC, 50 Hz / 60 Hz Power consumption : 0.9 A Dimensions (WxHxD) : [BM-H1900SU] 17-3/4" x 17" x 20-1/8" (449 mm x 431 mm x 511 mm) [BM-H1310SU] 13-5/8" x 13-1/8" x 16-1/4" (346 mm x 332 mm x 410 mm)
Horizontal resolution	: 750 TV lines or more	Weight : [BM-H1900SU] 66 lbs (30 kg) [BM-H1310SU] 35.6 lbs (16.2 kg)
Color temperature	: 6500 K; x = 0.313, y = 0.329 9300 K; x = 0.283, y = 0.297 (selectable)	Provided accessory : Power cord x 1
Video inputs	: Composite video INPUT A, B (2 lines), BNC x 2 each (with 1 bridge-connected output) Termination switches provided 1.0 V (p-p), 75 Ω, negative sync	
	: Y/C Y/C (1 line), Mini-DIN (4-pin) x 2 (with 1 bridge-connected output) Termination switch provided Y: 1.0 V (p-p), 75 Ω, negative sync C (NTSC 3.58 MHz / 4.43 MHz): 0.286 V (p-p), 75 Ω C (PAL): 0.3 V (p-p), 75 Ω	
	: Analog RGB RGB / COMPO (SDI) (1 line: common with Y, R-Y, B-Y, component), BNC x 6 (with 3 bridge-connected outputs) Termination switches provided R,B: 0.7 V (p-p), 75 Ω G: 0.7 V (p-p), 75 Ω G on sync: 1.0 V (p-p), 75 Ω, negative sync	
		Optional accessories : Wireless remote control unit (RM-C550W)

DIMENSIONS

BM-H1310SU

* The faceplate dimensions shown are larger than the visible portion of screen (Screen size).

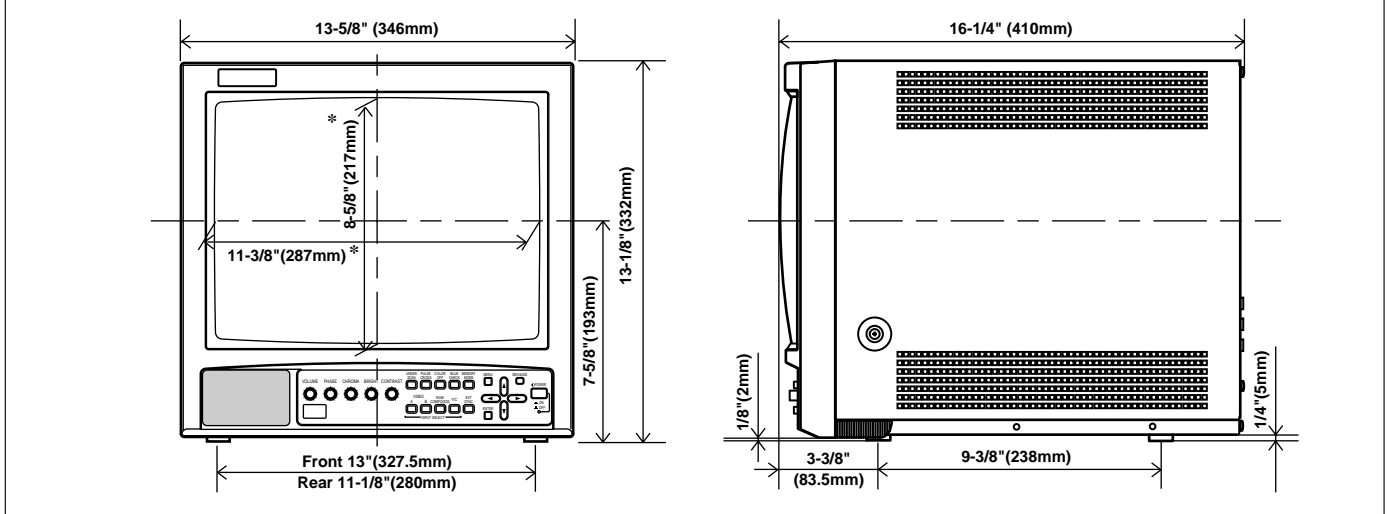

BM-H1900SU

* The faceplate dimensions shown are larger than the visible portion of screen (Screen size).

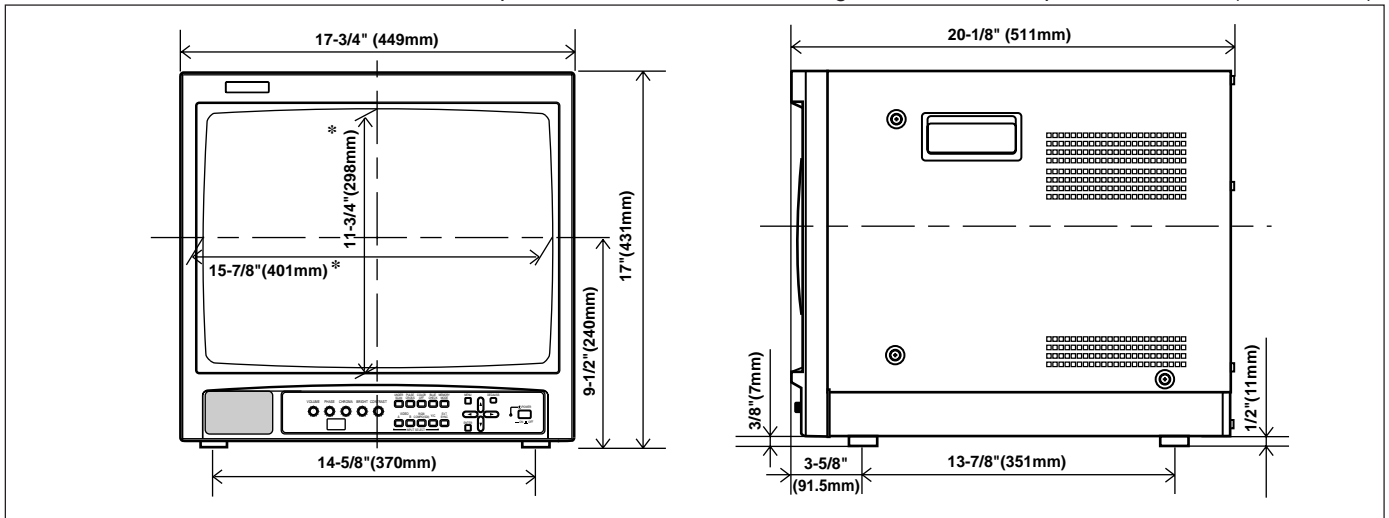

E. & O.E. Design and specifications subject to change without notice.

JVC[®]

JVC PROFESSIONAL PRODUCTS COMPANY
DIVISION OF US JVC CORP.
1700 Vallery Road Wayne, NJ07470
JVC CANADA INC.

21 Finchdene Square, Scarborough Ontario M1X 1A7

Free Manuals Download Website

<http://myh66.com>

<http://usermanuals.us>

<http://www.somanuals.com>

<http://www.4manuals.cc>

<http://www.manual-lib.com>

<http://www.404manual.com>

<http://www.luxmanual.com>

<http://aubethermostatmanual.com>

Golf course search by state

<http://golfingnear.com>

Email search by domain

<http://emailbydomain.com>

Auto manuals search

<http://auto.somanuals.com>

TV manuals search

<http://tv.somanuals.com>