

FOR SERVICING (Only in U.S.A.)

TO OUR VALUED CUSTOMER

THANK YOU FOR PURCHASING THIS JVC PRODUCT.
WE WANT TO HELP YOU ACHIEVE A PERFECT EXPERIENCE.

**NEED HELP ON HOW TO HOOK UP?
NEED ASSISTANCE ON HOW TO OPERATE?
NEED TO LOCATE A JVC SERVICE CENTER?
LIKE TO PURCHASE ACCESSORIES?**

JVC® IS HERE TO HELP!
TOLL FREE: 1(800)582-5825
<http://pro.jvc.com/>

Remember to retain your Bill of Sale for Warranty Service.

Do not attempt to service the product yourself

Caution

To prevent electrical shock, do not open the cabinet.
There are no user serviceable parts inside.
Please refer to qualified service personnel for repairs.

JVC

© 2007 Victor Company of Japan, Limited

Printed in Japan
0107TTH-SW-VP

DLA-RS1
DLA-RS1
D-ILA HOME THEATER PROJECTOR
PROJECTEUR CINÉMA MAISON D-ILA
SISTEMA DE CINE EN CASA D-ILA

ENGLISH FRANÇAIS ESPAÑOL

JVC

INSTRUCTIONS MANUEL D'INSTRUCTIONS MANUAL DE INSTRUCCIONES

D-ILA HOME THEATER PROJECTOR PROJECTEUR CINÉMA MAISON D-ILA SISTEMA DE CINE EN CASA D-ILA DLA-RS1

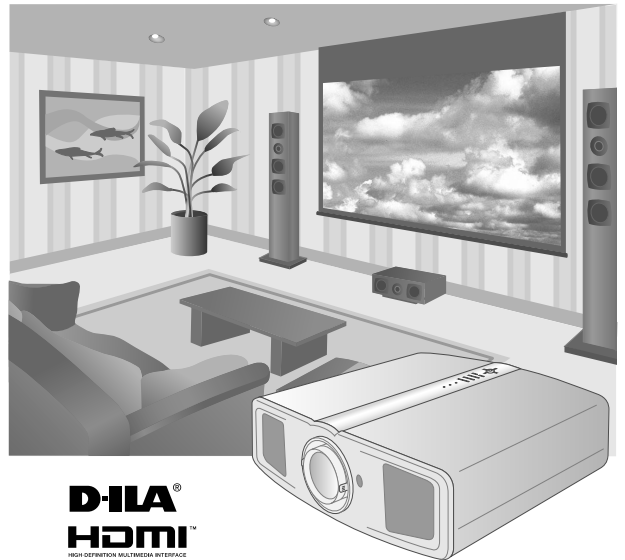

D-ILA®
HDMI™
HIGH DEFINITION MULTIMEDIA INTERFACE

For Customer use :
Enter below the serial No. which is located on the bottom side of the cabinet. Retain this information for future reference.

Model No. DLA-RS1
Serial No. _____

Pour utilisation par le client :
Entrer ci-dessous le N° de série qui est situé sous le boîtier. Garder cette information comme référence pour le futur.

N° de modèle DLA-RS1
N° de série _____

Instrucción para el cliente :
Introduzca a continuación el nº de serie que aparece en la parte inferior lateral de la caja. Conserve esta información como referencia para uso ulterior.

Modelo N° DLA-RS1
N° de serie _____

LCT2253-001A

Getting Started

Preparation

Basic Operation

Settings

Troubleshooting

Others

Safety Precautions

IMPORTANT INFORMATION

This product has a High Intensity Discharge (HID) lamp that contains mercury.

Disposal of these materials may be regulated in your community due to environmental considerations. For disposal or recycling information please contact your local authorities or for USA, the Electronic Industries Alliance: <http://www.eiae.org>.

WARNING:

TO PREVENT FIRE OR SHOCK HAZARDS, DO NOT EXPOSE THIS APPLIANCE TO RAIN OR MOISTURE.

WARNING:

THIS APPARATUS MUST BE EARTHED.

CAUTION:

To reduce the risk of electric shock, do not remove cover. Refer servicing to qualified service personnel.

This projector is equipped with a 3-blade grounding type plug to satisfy FCC rule. If you are unable to insert the plug into the outlet, contact your electrician.

FCC INFORMATION (U.S.A. only)

CAUTION:

Changes or modification not approved by JVC could void the user's authority to operate the equipment.

NOTE:

This equipment has been tested and found to comply with the limits for Class B digital devices, pursuant to Part 15 of the FCC Rules. These limits are designed to provide reasonable protection against harmful interference in a residential installation. This equipment generates, uses, and can radiate radio frequency energy and, if not installed and used in accordance with the instructions, may cause harmful interference to radio communications. However, there is no guarantee that interference will not occur in a particular installation. If this equipment does cause harmful interference to radio or television reception, which can be determined by turning the equipment off and on, the user is encouraged to try to correct the interference by one or more of the following measures:

- Reorient or relocate the receiving antenna.
- Increase the separation between the equipment and receiver.
- Connect the equipment into an outlet on a circuit different from that to which the receiver is connected.
- Consult the dealer or an experienced radio/TV technician for help.

About the installation place

Do not install the projector in a place that cannot support its weight securely.

If the installation place is not sturdy enough, the projector could fall or overturn, possibly causing personal injury.

IMPORTANT SAFEGUARDS

Electrical energy can perform many useful functions. This unit has been engineered and manufactured to assure your personal safety. But IMPROPER USE CAN RESULT IN POTENTIAL ELECTRICAL SHOCK OR FIRE HAZARD. In order not to defeat the safeguards incorporated into this product, observe the following basic rules for its installation, use and service. Please read these Important Safeguards carefully before use.

- All the safety and operating instructions should be read before the product is operated.
- The safety and operating instructions should be retained for future reference.
- All warnings on the product and in the operating instructions should be adhered to.
- All operating instructions should be followed.
- Place the projector near a wall outlet where the plug can be easily unplugged.
- Unplug this product from the wall outlet before cleaning. Do not use liquid cleaners or aerosol cleaners. Use a damp cloth for cleaning.
- Do not use attachments not recommended by the product manufacturer as they may be hazardous.
- Do not use this product near water. Do not use immediately after moving from a low temperature to high temperature, as this causes condensation, which may result in fire, electric shock, or other hazards.
- Do not place this product on an unstable cart, stand, or table. The product may fall, causing serious injury to a child or adult, and serious damage to the product. The product should be mounted according to the manufacturer's instructions, and should use a mount recommended by the manufacturer.
- When the product is used on a cart, care should be taken to avoid quick stops, excessive force, and uneven surfaces which may cause the product and cart to overturn, damaging equipment or causing possible injury to the operator.
- Slots and openings in the cabinet are provided for ventilation. These ensure reliable operation of the product and protect it from overheating. These openings must not be blocked or covered. (The openings should never be blocked by placing the product on bed, sofa, rug, or similar surface. It should not be placed in a built-in installation such as a bookcase or rack unless proper ventilation is provided and the manufacturer's instructions have been adhered to.)

PORTABLE CART WARNING
(symbol provided by RETACI)



- To allow better heat dissipation, keep a clearance between this unit and its surrounding as shown below. When this unit is enclosed in a space of dimensions as shown below, use an air-conditioner so that the internal and external temperatures are the same.

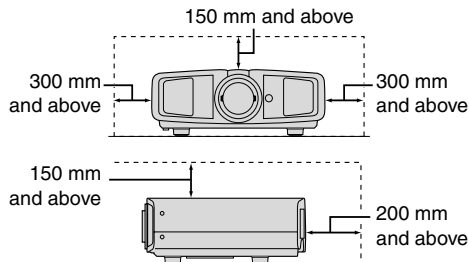

- This product should be operated only with the type of power source indicated on the label. If you are not sure of the type of power supply to your home, consult your product dealer or local power company.
- This product is equipped with a three-wire plug. This plug will fit only into a grounded power outlet. If you are unable to insert the plug into the outlet, contact your electrician to install the proper outlet. Do not defeat the safety purpose of the grounded plug.
- Power-supply cords should be routed so that they are not likely to be walked on or pinched by items placed upon or against them. Pay particular attention to cords at doors, plugs, receptacles, and the point where they exit from the product.
- For added protection of this product during a lightning storm, or when it is left unattended and unused for long periods of time, unplug it from the wall outlet and disconnect the cable system. This will prevent damage to the product due to lightning and power line surges.
- Do not overload wall outlets, extension cords, or convenience receptacles on other equipment as this can result in a risk of fire or electric shock.
- Never push objects of any kind into this product through openings as they may touch dangerous voltage points or short out parts that could result in a fire or electric shock. Never spill liquid of any kind on the product.
- Do not attempt to service this product yourself as opening or removing covers may expose you to dangerous voltages and other hazards. Refer all service to qualified service personnel.
- Unplug this product from the wall outlet and refer service to qualified service personnel under the following conditions:
 - a) When the power supply cord or plug is damaged.
 - b) If liquid has been spilled, or objects have fallen on the product.
 - c) If the product has been exposed to rain or water.
 - d) If the product does not operate normally by following the operating instructions. Adjust only those controls that are covered by the Operation Manual, as an improper adjustment of controls may result in damage and will often require extensive work by a qualified technician to restore the product to normal operation.
 - e) If the product has been dropped or damaged in any way.
 - f) When the product exhibits a distinct change in performance - this indicates a need for service.
- When replacement parts are required, be sure the service technician has used replacement parts specified by the manufacturer or with same characteristics as the original part. Unauthorized substitutions may result in fire, electric shock, or other hazards.

- Upon completion of any service or repairs to this product, ask the service technician to perform safety checks to determine that the product is in proper operating condition.
- The product should be placed more than one foot away from heat sources such as radiators, heat registers, stoves, and other products (including amplifiers) that produce heat.
- When connecting other products such as VCR's, and DVD players, you should turn off the power of this product for protection against electric shock.
- Do not place combustibles behind the cooling fan. For example, cloth, paper, matches, aerosol cans or gas lighters that present special hazards when over heated.
- Do not look into the projection lens while the illumination lamp is turned on. Exposure of your eyes to the strong light can result in impaired eyesight.
- Do not look into the inside of this unit through vents (ventilation holes), etc. Do not look at the illumination lamp directly by opening the cabinet while the illumination lamp is turned on. The illumination lamp also contains ultraviolet rays and the light is so powerful that your eyesight can be impaired.
- Do not drop, hit, or damage the light-source lamp (lamp unit) in any way. It may cause the light-source lamp to break and lead to injuries. Do not use a damaged light source lamp. If the light-source lamp is broken, ask your dealer to repair it. Fragments from a broken light-source lamp may cause injuries.
- The light-source lamp used in this projector is a high pressure mercury lamp. Be careful when disposing of the lightsource lamp. If anything is unclear, please consult your dealer.
- Do not ceiling-mount the projector to a place which tends to vibrate; otherwise, the attaching fixture of the projector could be broken by the vibration, possibly causing it to fall or overturn, which could lead to personal injury.
- Use only the accessory cord designed for this product to prevent shock.

***DO NOT allow any unqualified person to install the unit.**

Be sure to ask your dealer to install the unit (e.g. attaching it to the ceiling) since special technical knowledge and skills are required for installation. If installation is performed by an unqualified person, it may cause personal injury or electrical shock.

Safety Precautions (Continued)

POWER CONNECTION

Use only the following power cord.

Power cord

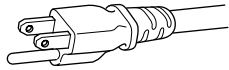

WARNING:

Do not cut off the main plug from this equipment. If the plug fitted is not suitable for the power points in your home or the cable is too short to reach a power point, then obtain an appropriate safety approved extension lead or adapter or consult your dealer. If nonetheless the mains plug is cut off, dispose of the plug immediately, to avoid a possible shock hazard by inadvertent connection to the main supply. If a new main plug has to be fitted, then follow the instruction given below.

WARNING:

THIS APPARATUS MUST BE EARTHED.

IMPORTANT:

The wires in the mains lead on this product are colored in accordance with the following cord:

Green-and-yellow : Earth
Blue : Neutral
Brown : Live

As these colors may not correspond with the colored making identifying the terminals in your plug, proceed as follows:

The wire which is colored green-and-yellow must be connected to the terminal which is marked ⊕ with the letter E or the safety earth or colored green or green-and-yellow.

The wire which is colored blue must be connected to the terminal which is marked with the letter N or colored black.

The wire which is colored brown must be connected to the terminal which is marked with the letter L or colored red.

Getting Started

Preparation

Basic Operation

Settings

Troubleshooting

Others

5

Main Features

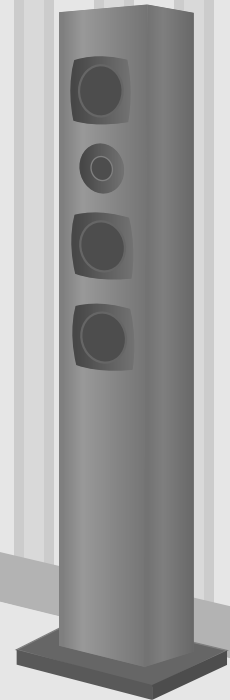
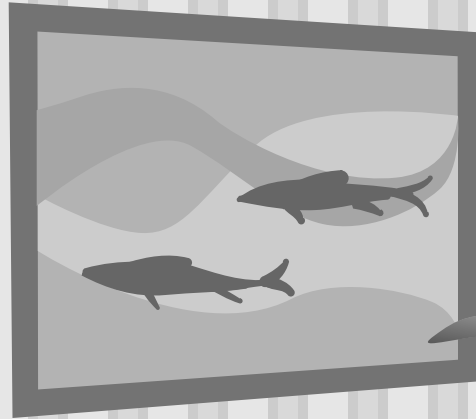

Supports Multiple Digital Devices

- Comes with a dual HDMI terminal that allows digital transmission of high definition signals. ( P14)

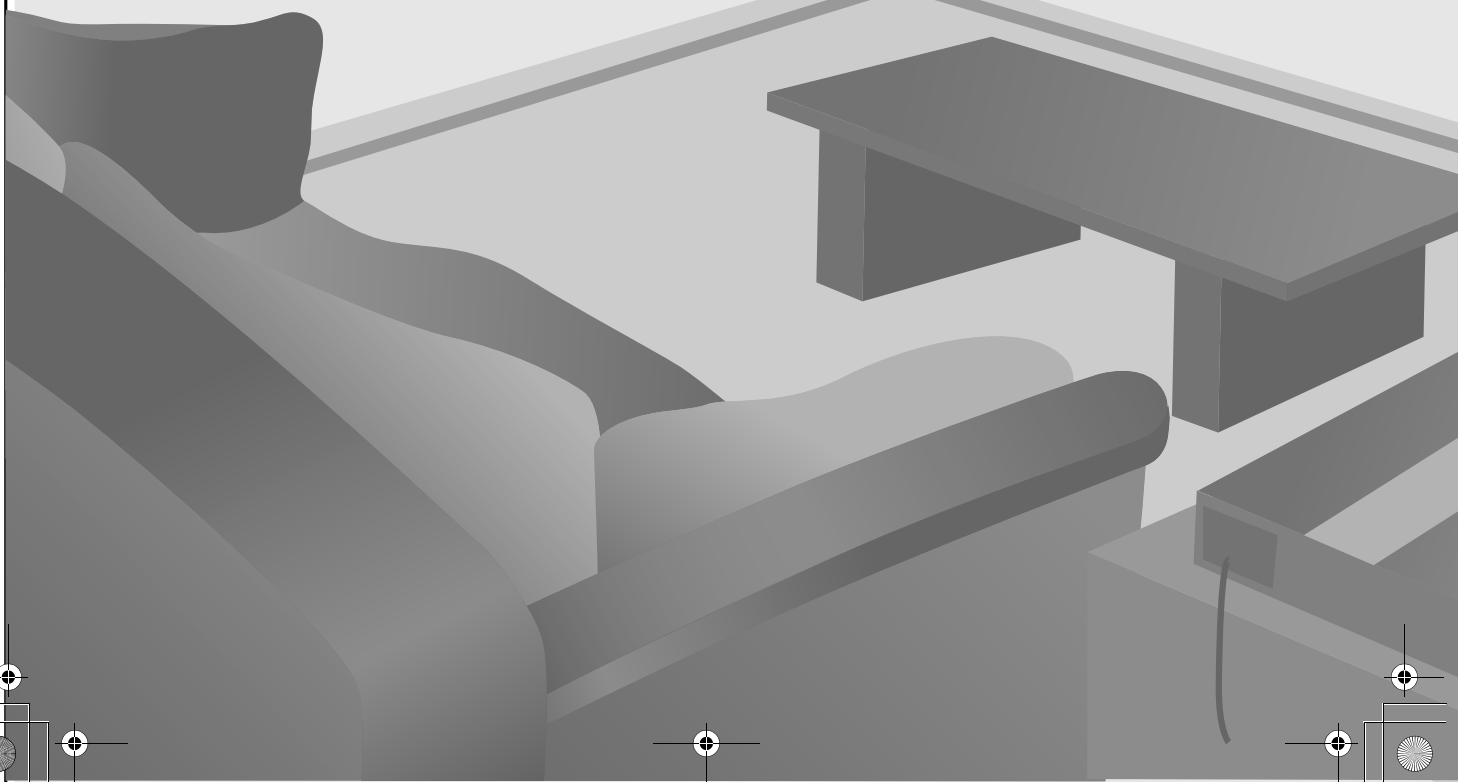

Beautiful Images on Big Screen

- Enjoy smooth and high resolution video images with no visible grid, brought about by full high definition resolution of 1920×1080 pixels. (📖 P20)

Perfect for Any Location

- Comes with an 80 % vertical and 34 % horizontal lens shift function. (📖 P18)

Contents

Getting Started	
Safety Precautions.....	2
Main Features	6
Contents.....	8
How to Read this Manual/ Accessories/Optional Accessories	9
About this Manual.....	9
Check the Accessories.....	9
Optional Accessories	9
Controls and Features	10
How to Use the Remote Control.....	13
Loading Batteries.....	13
Effective Range of Remote Control Unit.....	13
 Preparation	
Selecting Connecting Devices.....	14
Connecting.....	15
Connecting via Video Cable.....	15
Connecting via S-video Cable	15
Connecting via HDMI Cable Or HDMI-DVI Conversion Cable.....	16
Connecting via Component Video Cable.....	16
Connecting via SCART-RCA Cable.....	17
Connecting via RGB Video Cable	17
Installing the Projector and Screen.....	18
Screen Size and Projection Distance.....	19
 Basic Operation	
Projecting Image.....	20
Convenient Features during Projection	22
Setting the Screen Size.....	22
Masking the Surrounding Area of an Image	22
 Settings	
Setting Menu	24
Procedures for Menu Operation	24
Setting Menu.....	25
Customizing Projected Images.....	32
Changing the Default Image Profile Values	32
Registering User-defined Image Profiles.....	33
 Troubleshooting	
Troubleshooting.....	34
What to Do When These Messages Are Displayed	36
About Warning Indicators.....	37
Actions to Be Taken for Warning Mode	37
Replacing the Lamp	38
Procedure for Lamp Replacement	38
Resetting Lamp Time.....	40
Cleaning and Replacing the Filter.....	41
 Others	
RS-232C Interface	42
RS-232C Specifications	42
Command Format	42
RS-232C Communication Examples.....	45
Copyright and Caution.....	46
About Trademarks and Copyright	46
Caution	46
Mounting this Unit.....	47
Specifications	48
Dimensions.....	49

How to Read this Manual/ Accessories/Optional Accessories

About this Manual



Buttons to be used are colored in a darker shade.

This manual mainly describes the operating method using the remote control.

- Buttons on the remote control are described as [Button Name].
- Selection items on the menu are described as "Selection Item".

Conventions in this manual



Describes the limitations of the functions or usage.



Indicates good-to-know information.



Describes operational precautions.



P9 Indicates related pages.

Check the Accessories

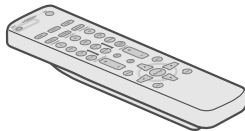

Remote Control



AAA size Batteries
(for operation confirmation)

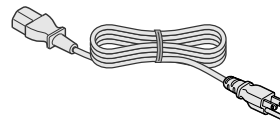

Power Cord

- Instruction manual, warranty card and other printed material are also included.

Optional Accessories

Please check with your authorized dealer for details.

- Replacement Lamp: BHL5009-S (Lamp Unit)
- Replacement Filter: LC32058-002A (Inner Filter)

Controls and Features

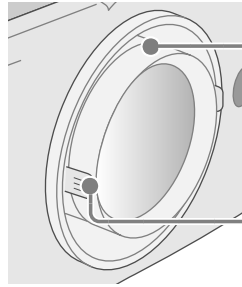

To adjust the focus
(P21)

To adjust the size of the image
(P21)

- This unit comes with buffer material that cushions the lens. Remove the buffer material before use.
- Do not throw away the buffer material, retain for future use. (P46)

■ Front Side/Left Side

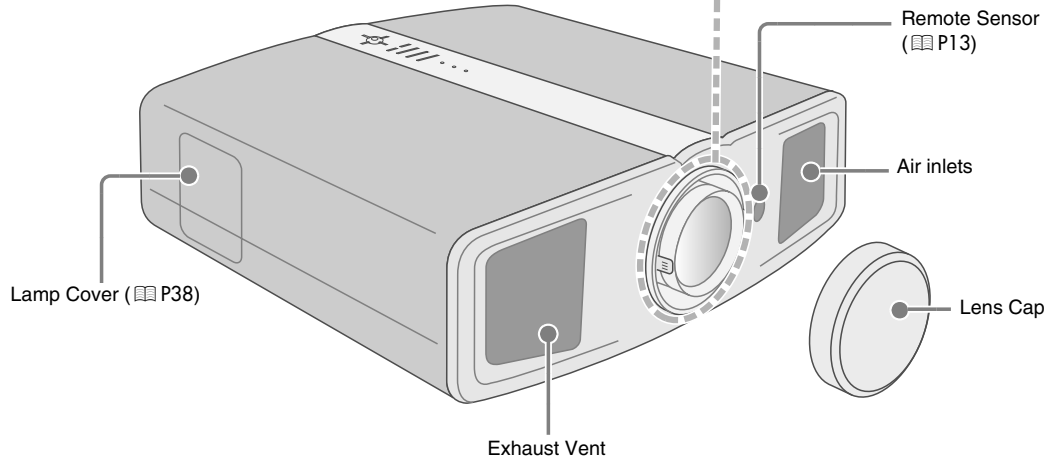

■ Rear Side/Top Surface

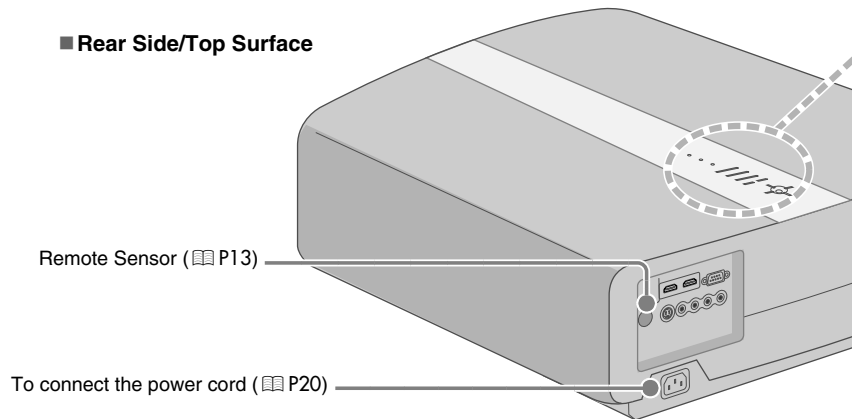

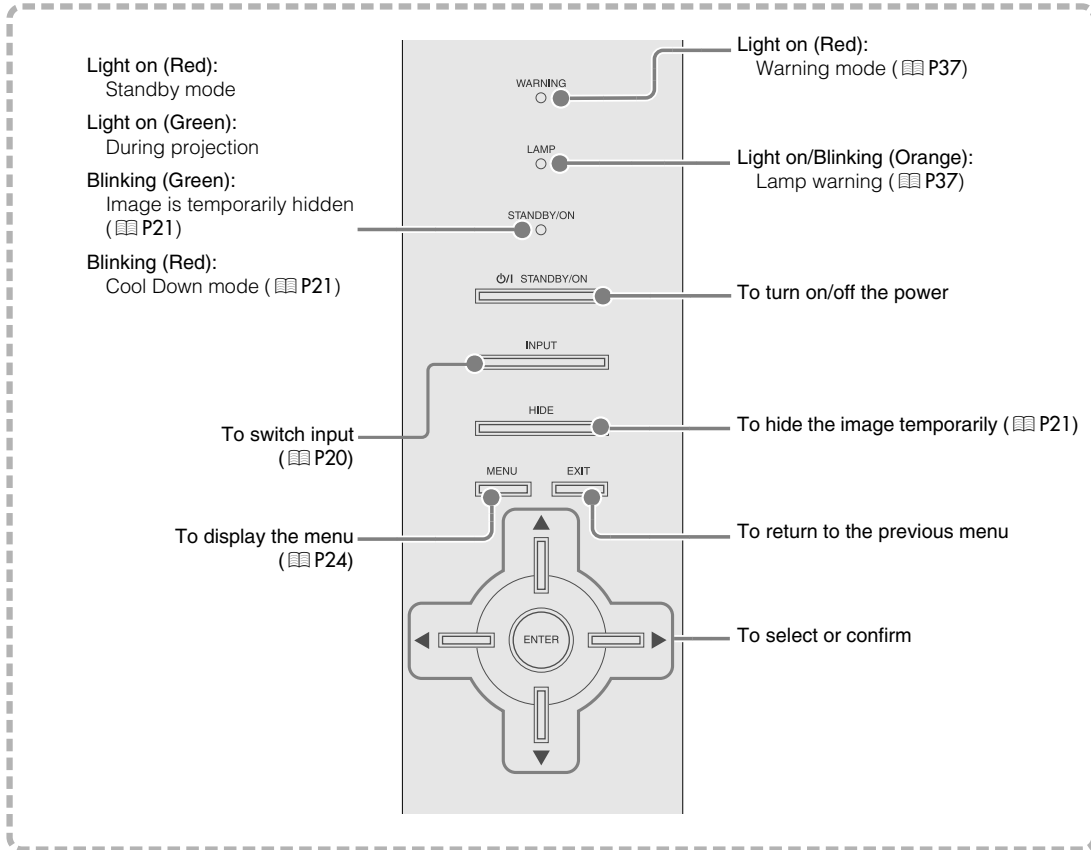

Feet:

Bottom Surface

The height (0 - 5 mm) can be adjusted by turning the foot.

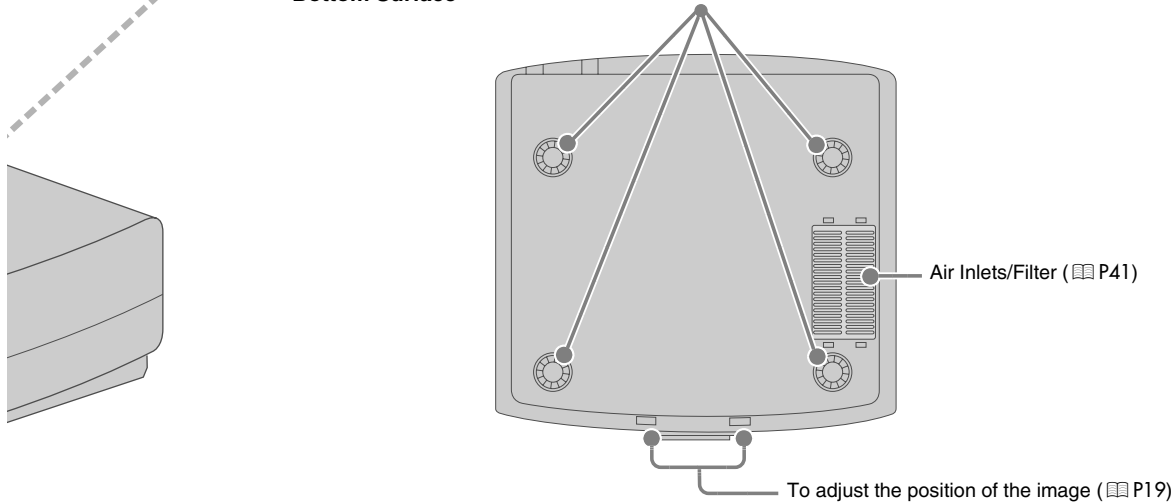

Controls and Features (Continued)

■ Remote Control

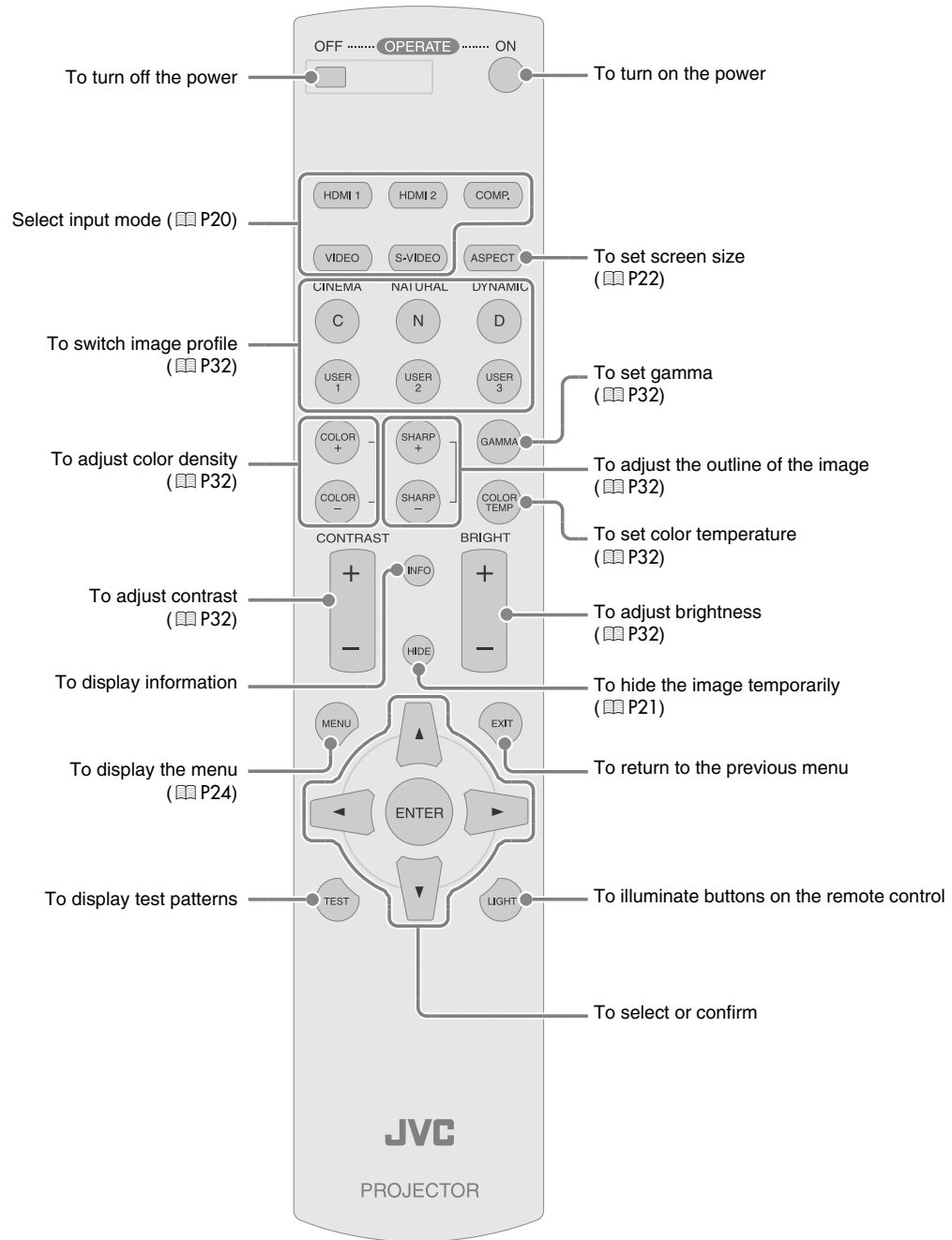

How to Use the Remote Control

Loading Batteries

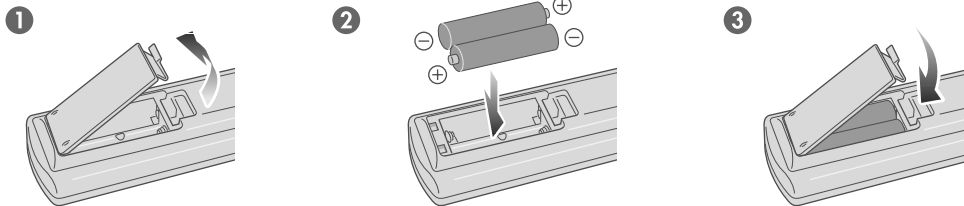

- If the remote control has to be brought closer to the projector to operate, it means that the batteries are wearing out. When this happens, replace the batteries. Insert the batteries according to the \oplus / \ominus marks.
- Be sure to insert the \ominus end first.
- If an error occurs when using the remote control, remove the batteries and wait for 5 minutes. Load the batteries again and operate the remote control.

Effective Range of Remote Control Unit

■ When directing the remote control toward this unit

- When aiming the remote control towards the remote sensor on this unit, ensure that the distance to the sensor in front or at the rear of this unit is within 7 m.
- If the remote control fails to work properly, move closer to this unit.

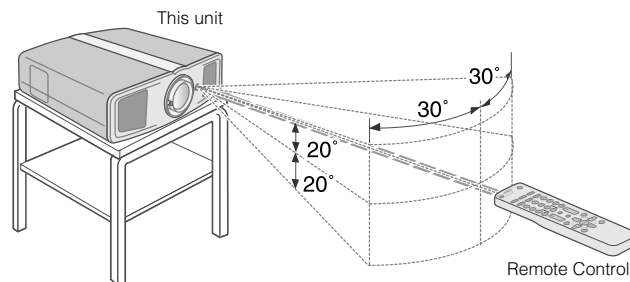

■ When reflecting off a screen

- Ensure that total of distance A between this unit and screen and distance B between remote control and screen is within 7 m.
- As the efficiency of signals reflected from the remote control unit differ with the type of screen used, operable distance may decrease.

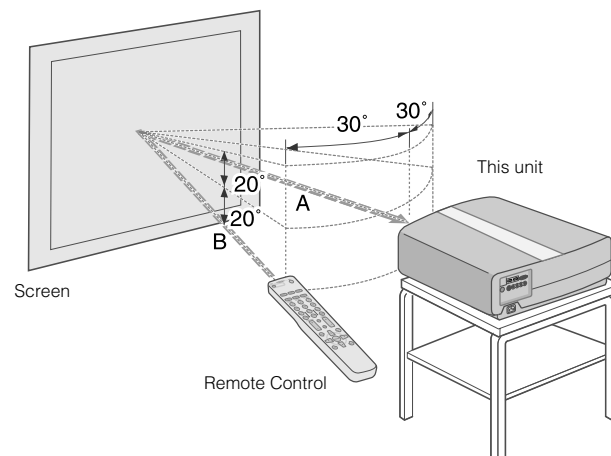

Selecting Connecting Devices

- Do not turn on the power until connection is complete.
- The connection procedures differ according to the device used. For details, refer to the instruction manual of the device to be connected.
- For audio output, connect the device to an amplifier.
- The images may not be displayed depending on the devices and cables to be connected.
- It may not be possible to connect to this unit depending on the dimension of the connector cover of the cables to be connected.

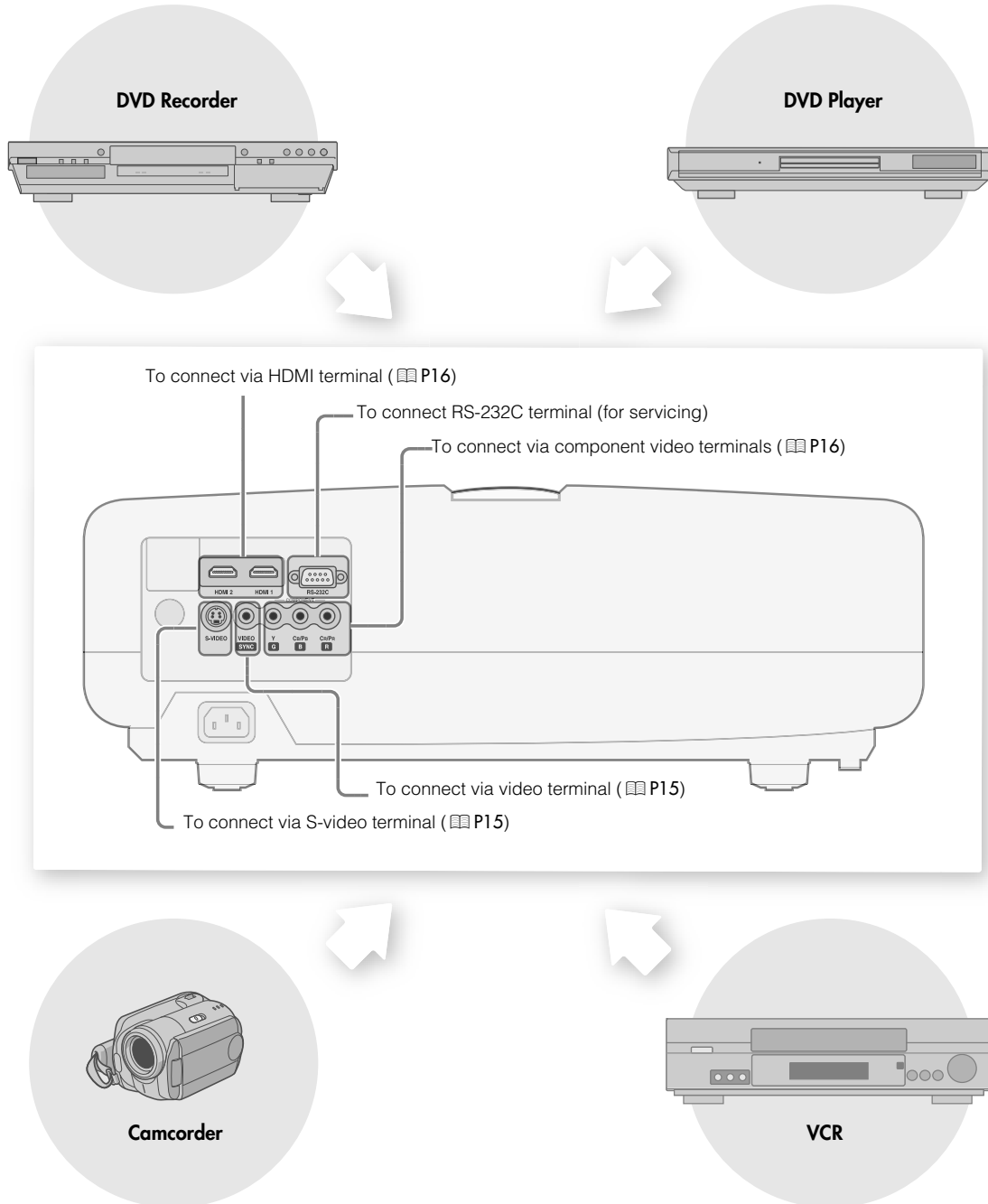

Connecting

Connecting via Video Cable

This unit

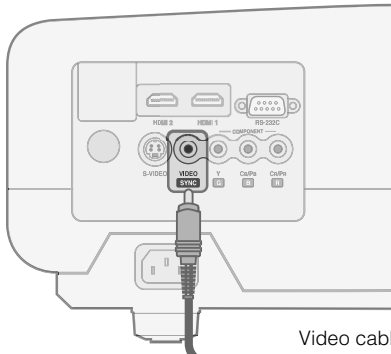

Video cable (sold separately)

To video input terminal

VCR and camcorder

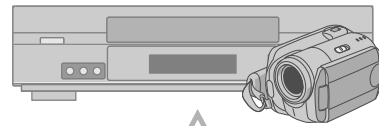

Video output

Connecting via S-video Cable

This unit

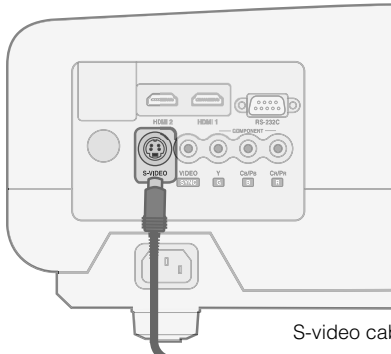

S-video cable (sold separately)

To S-video input terminal

VCR and camcorder

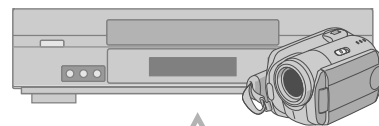

S-video output

Connecting (Continued)

Connecting via HDMI Cable Or HDMI-DVI Conversion Cable

This unit

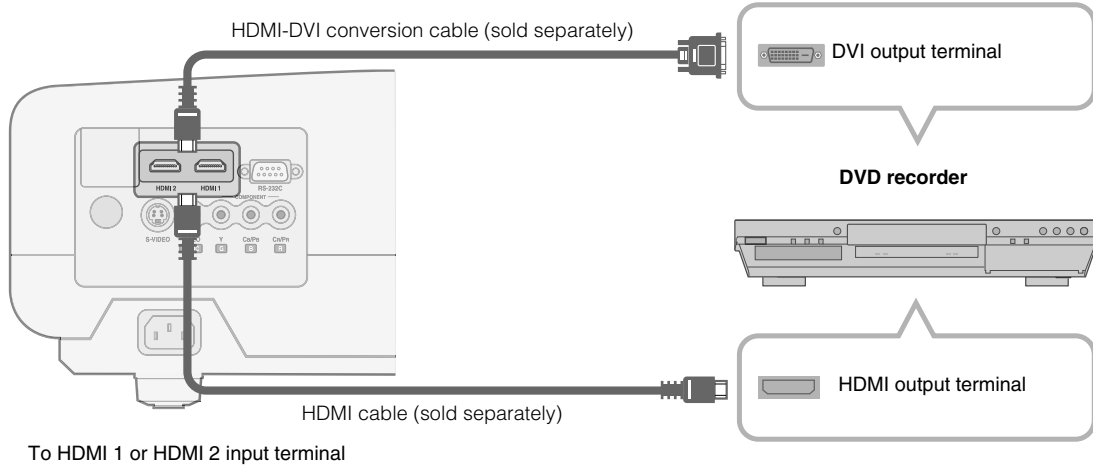

To HDMI 1 or HDMI 2 input terminal

Connecting via Component Video Cable

This unit

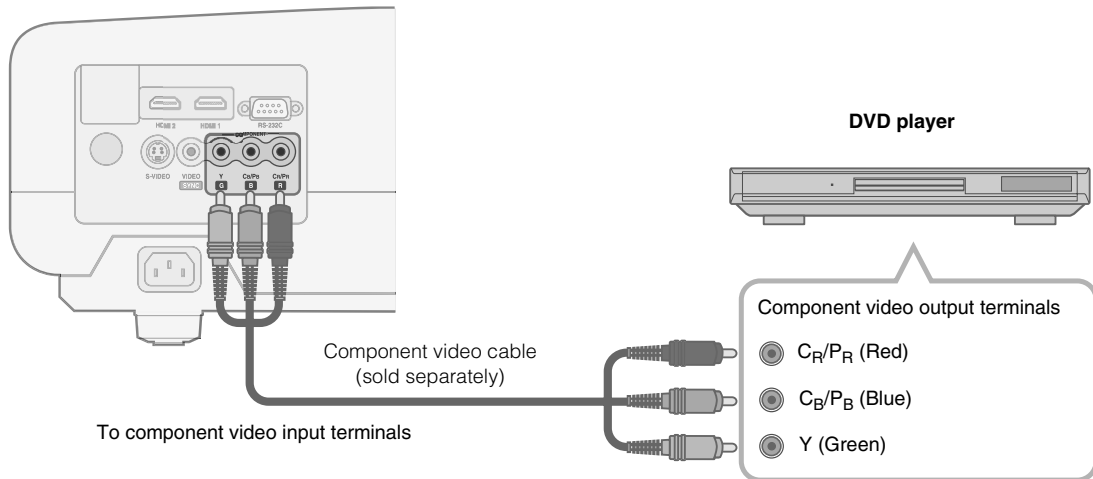

To component video input terminals

● Set "COMP" in the setting menu to "Y Pb/Cb Pr/Cr". (P27 - 16)

Connecting via SCART-RCA Cable

This unit

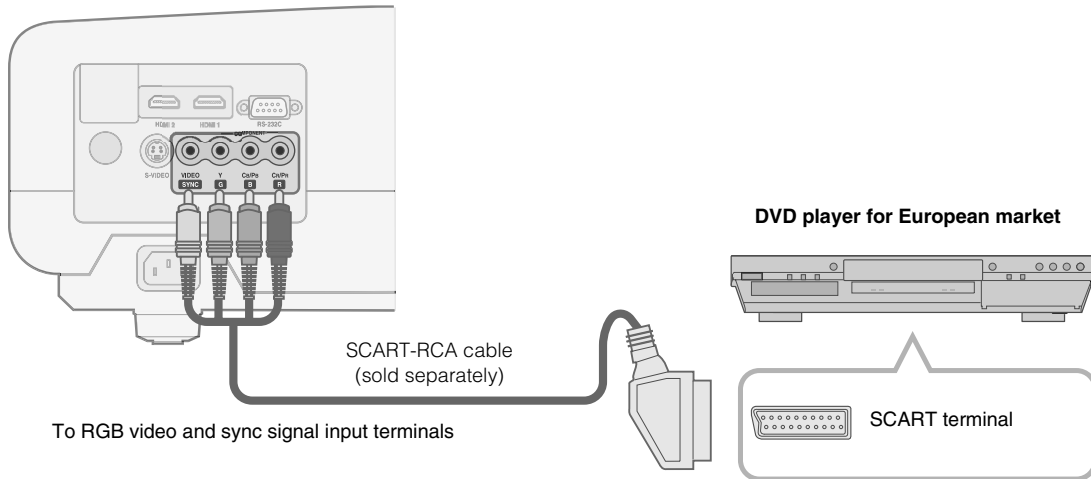

- Set "COMP" in the setting menu to "SCART". (P27 - 16)

Connecting via RGB Video Cable

This unit

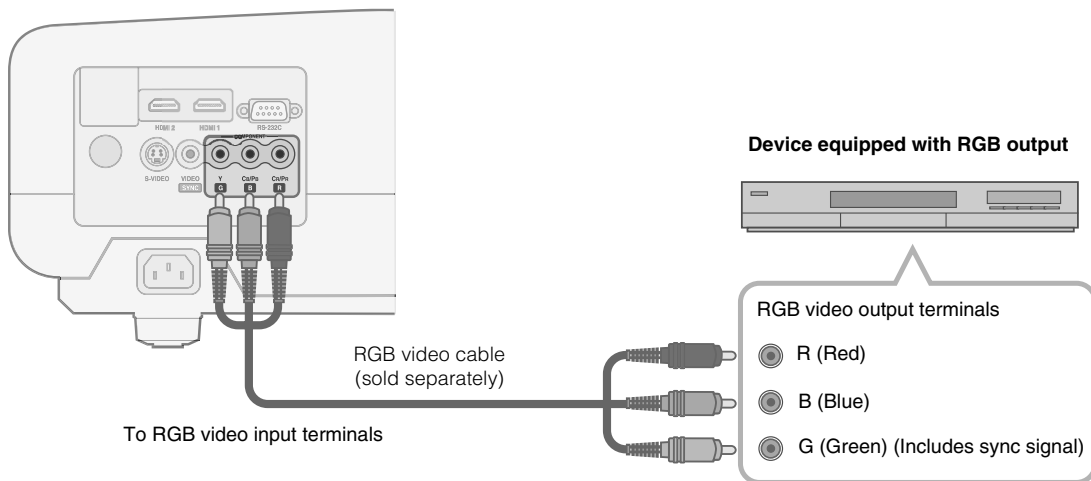

- Set "COMP" in the setting menu to "RGB". (P27 - 16)
- For information on compatible input signals, see "Specifications". (P48)

Installing the Projector and Screen

Install this unit and the screen. Place this unit and the screen perpendicular to each other.
Failing to do so may give rise to trapezoidal distortion of the projected image.

1 Install the projector and screen

■ Left/Right position

*0 % up/down position (center)

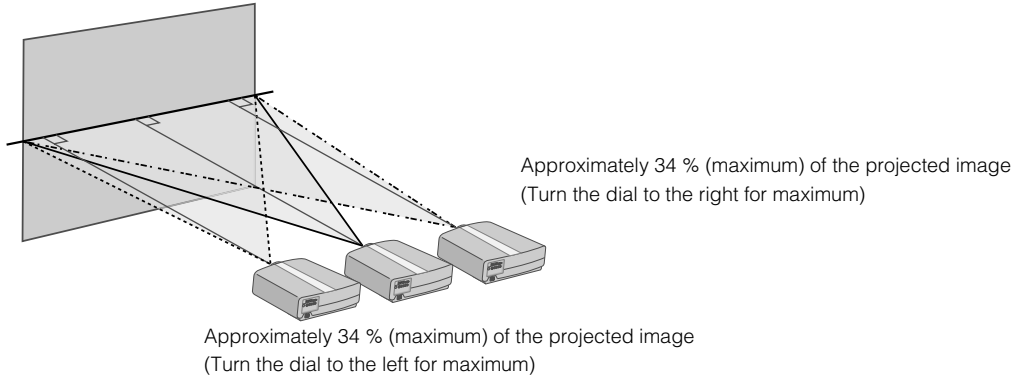

■ Up/Down position

*0 % left/right position (center)

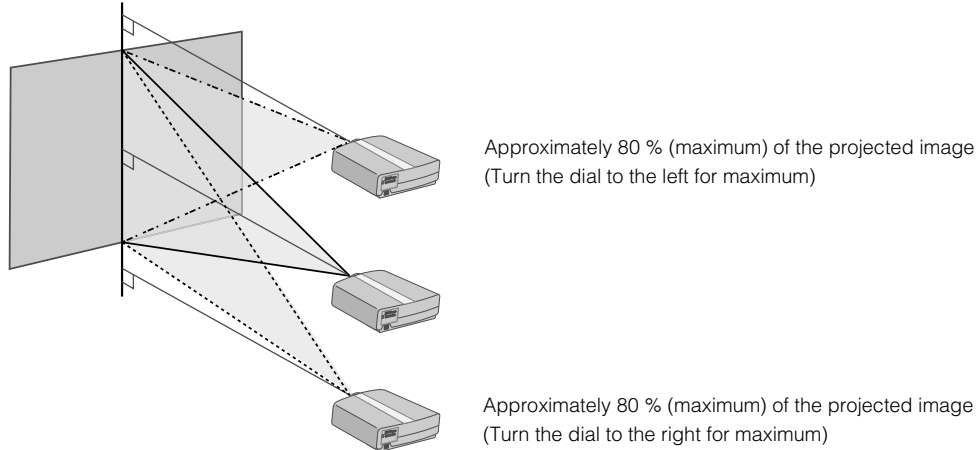

■ Shifting range of projected image

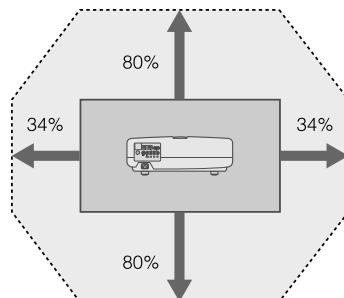

2 Adjust such that the projected image is in the center of the screen

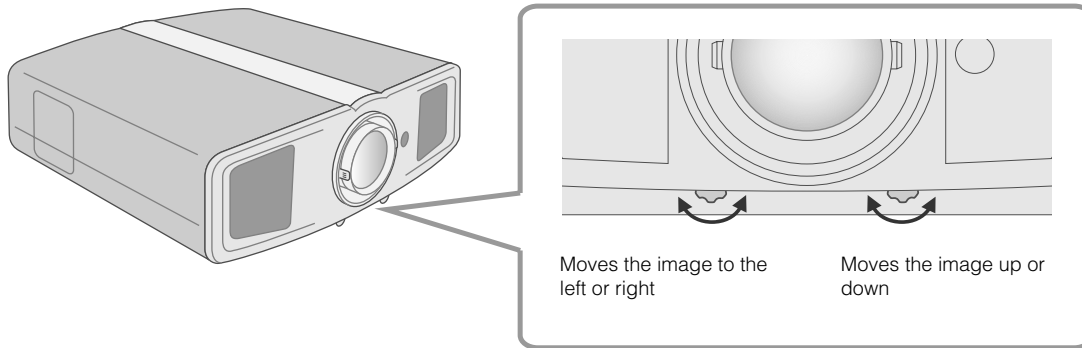

- It may be necessary to set "Pixel Adjust" in the setting menu after adjusting the image position. (P26 - 10)

Screen Size and Projection Distance

Determine the distance from the lens to the screen to achieve your desired screen size. This unit uses a 2.0x manual zoom lens for projection.

Relationship Between Projection Screen Size and Projection Distance

Projection Screen Size (Diagonal Length) Aspect Ratio 16:9	Approximate Projection Distance W (Wide) ~ T (Tele)			Projection Screen Size (Diagonal Length) Aspect Ratio 16:9	Approximate Projection Distance W (Wide) ~ T (Tele)		
60" (Approx. 152.4 cm)	Approx. 1.78 m	~	Approx. 3.63 m	140" (Approx. 355.6 cm)	Approx. 4.24 m	~	Approx. 8.54 m
70" (Approx. 177.8 cm)	Approx. 2.09 m	~	Approx. 4.24 m	150" (Approx. 381.0 cm)	Approx. 4.55 m	~	Approx. 9.16 m
80" (Approx. 203.2 cm)	Approx. 2.40 m	~	Approx. 4.86 m	160" (Approx. 406.4 cm)	Approx. 4.86 m	~	Approx. 9.77 m
90" (Approx. 228.6 cm)	Approx. 2.71 m	~	Approx. 5.47 m	170" (Approx. 431.8 cm)	Approx. 5.16 m	~	Approx. 10.38 m
100" (Approx. 254.0 cm)	Approx. 3.01 m	~	Approx. 6.08 m	180" (Approx. 457.2 cm)	Approx. 5.47 m	~	Approx. 11.00 m
110" (Approx. 279.4 cm)	Approx. 3.32 m	~	Approx. 6.70 m	190" (Approx. 482.6 cm)	Approx. 5.78 m	~	Approx. 11.61 m
120" (Approx. 304.8 cm)	Approx. 3.63 m	~	Approx. 7.31 m	200" (Approx. 508.0 cm)	Approx. 6.08 m	~	Approx. 12.23 m
130" (Approx. 330.2 cm)	Approx. 3.93 m	~	Approx. 7.93 m				

- The projection distances in the table are provided only as a guide. Use them as a reference during installation.
- To adjust the installation, use a projected image of aspect ratio 16:9.

Projecting Image

This section describes the basic operations to project input images on the screen.

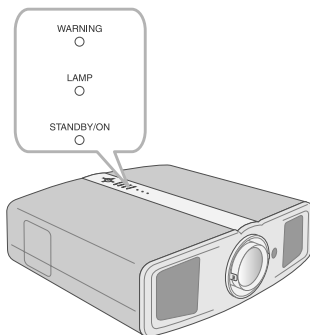
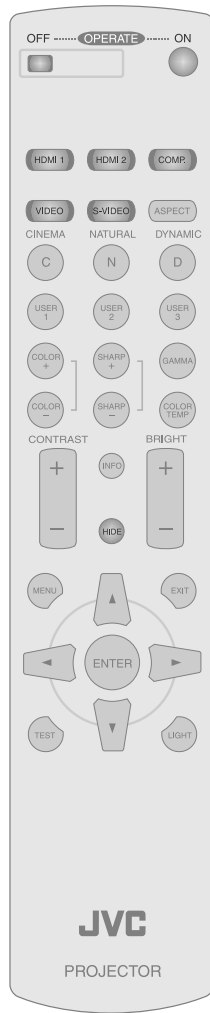

Preparation

- Remove the lens cap.

1 Insert the power plug to the power outlet

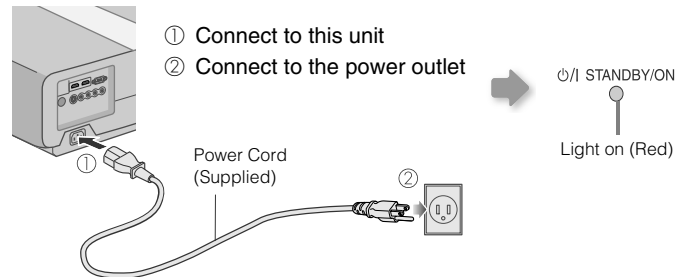

2 Turn on the power



- You can also press the [STANDBY/ON] button on the unit to turn on the power. (P11)

3 Project the image

1 Select input mode



- You can also select the input mode by pressing the [INPUT] button on the unit. (P11)

2 Play back the selected device

4 Adjust the position of the projection screen

- See "Installing the Projector and Screen" for procedures on adjusting the position. (P18)

5 Adjust the image size (zoom)

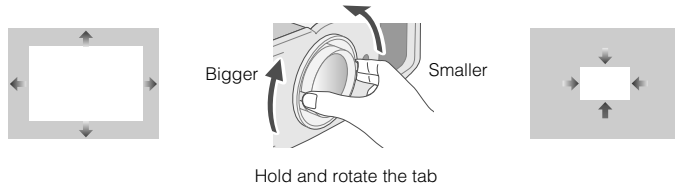

6 Adjust the focus



7 Turn off the power

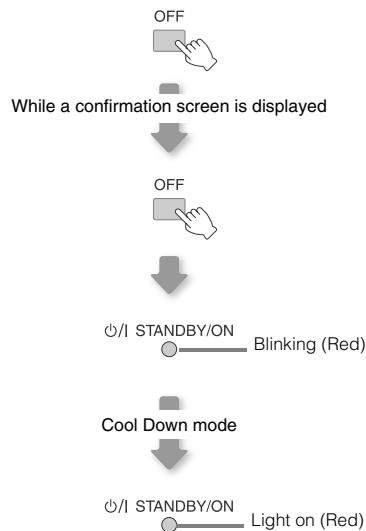

- The power cannot be turned off within approximately 90 seconds after it has been turned on. Start operation only after 90 seconds time.
- You can also press the [STANDBY/ON] button on the unit to turn off the power. (P11)
- Put back the lens cap after use to prevent the lens from dirt.
- Pull out the power plug when the unit will not be used for a prolonged time.



TIPS

You can hide the image temporarily

You can hide the image temporarily.



⏻/I STANDBY/ON

Green light blinks when the image is hidden

- Press the [HIDE] button again to display image.
- The power cannot be turned off when the image is temporarily hidden.



MEMO

About Cool Down mode

- The Cool Down mode is a function to cool down the lamp for approximately 60 seconds after projection is complete. This function prevents the internal parts of the unit from deformation or damage due to overheating of the lamp. It also prevents lamp blowout and premature shortening of lamp life.
- During Cool Down mode, the [STANDBY/ON] indicator blinks in red.
- After the Cool Down mode is complete, the unit automatically returns to standby mode.
- Do not pull out the power plug during Cool Down mode. This may shorten the lamp life and cause a malfunction.

Convenient Features during Projection

You can change the screen size of the projected image or hide the surrounding area of an image for which quality at the outer area has deteriorated.

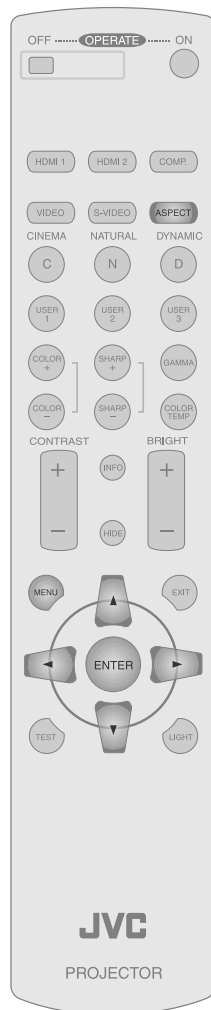

Setting the Screen Size

The projected image can be set to a most appropriate screen size (aspect ratio).

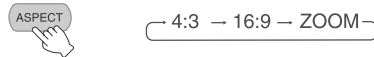

- The screen size can also be set from “Aspect” of the setting menu. (P28 - 18)
- When high definition images are input, the screen size is fixed at “16:9”.

Input Image and Projected Image by Different Screen Size Settings

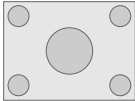
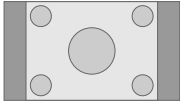
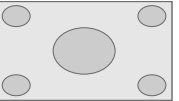
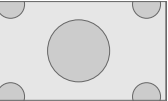
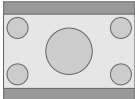
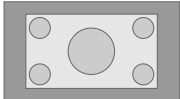
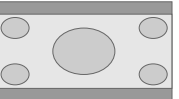
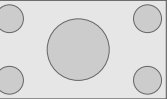
Input Image	Screen Size		
	4:3	16:9	Zoom
 <p>SDTV(4:3)</p>	 <p>Aspect Ratio: Same Most appropriate screen size</p>	 <p>Aspect Ratio: Landscape Image is stretched horizontally</p>	 <p>Aspect Ratio: Same Top and bottom of the image are missing</p>
 <p>SDTV(4:3) Image recorded in landscape (black bands on top and bottom) of DVD software</p>	 <p>Aspect Ratio: Same Small image is projected</p>	 <p>Aspect Ratio: Landscape Image is stretched horizontally</p>	 <p>Aspect Ratio: Same Most appropriate screen size</p>

- Depending on the input image, selecting “4:3” may result in a vertically stretched image while selecting “16:9” provides you with the most appropriate screen size.

Masking the Surrounding Area of an Image

Images for which quality at the outer area has deteriorated can be projected by masking (hiding) the surrounding area of the projected image.

1 Project the image



◀ Image for which quality at the outer area has deteriorated.

2 Mask the image

1 Display the setting menu

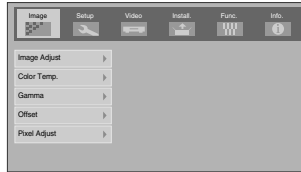

2 Select "Setup" ➔ "Mask"

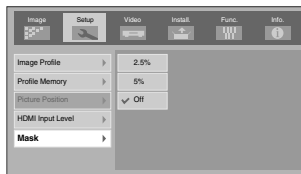
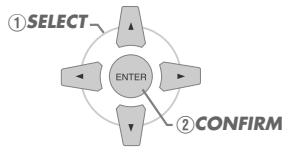

3 Set a mask value

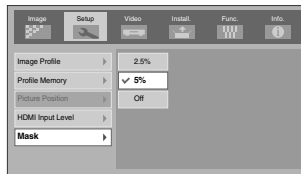
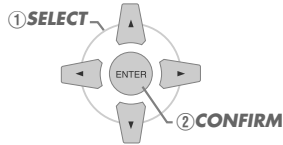

Example:
When the "Mask" value is changed from "Off" ➔ "5%"

MEMO

- Masking is available only when high definition images are input.

3 To end



Setting Menu

Projected images can be adjusted to a desired view by changing the default settings.

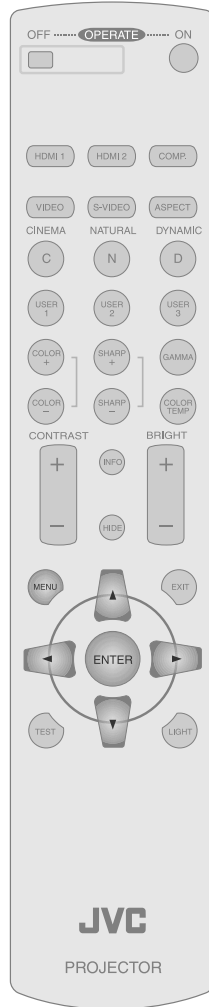

Procedures for Menu Operation

Example:

When "Aspect" is changed from "4:3" to "16:9"

1 Display the setting menu

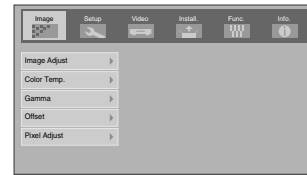

2 Select "Video" → "Aspect"

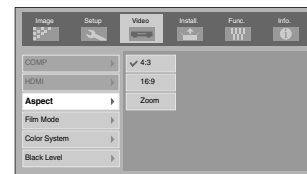
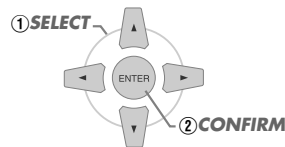

3 Set to "16:9"

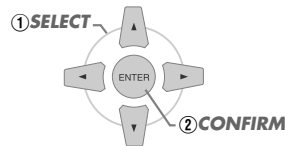

4 To end



Setting Menu

Item values shown in are factory settings.

- Items that can be configured differ according to the input signals.

Image>Image Adjust

01 Contrast

Adjusts the contrast of the projected image.

(Black) -30 ~ 30 (White)

02 Brightness

Adjusts the brightness of the projected image.

(Darken) -30 ~ 30 (Brighten)

03 Color

Adjusts the color density of the projected image.

(Lighten) -30 ~ 30 (Darken)

04 Tint

Adjusts the hue of the projected image.

(Red) -30 ~ 30 (Green)

05 Sharpness

Adjusts the outline of the projected image.

(Soft) -30 ~ 30 (Sharp)

06 DNR

Adjusts the strength of noise removal of the projected image.

(Weak) 0 ~ 30 (Strong)

- “Contrast”, “Brightness”, “Color” and “Sharpness” can also be configured from the remote control. (P12)
- “Tint” can only be adjusted when NTSC signals are input to the video or S-video input terminal.

Image>Color Temp.

07 Color Temp.

Sets the color temperature of the projected image.

Low	Select this to give a reddish tinge to the image.	
Middle	Select this to have a balanced image.	
High	Select this to give a bluish tinge to the image.	
User1*	Red	(Less red) -255 ~ 0 (More red)
	Green	(Less green) -255 ~ 0 (More green)
	Blue	(Less blue) -255 ~ 0 (More blue)
User2*	Red	(Less red) -255 ~ 0 (More red)
	Green	(Less green) -255 ~ 0 (More green)
	Blue	(Less blue) -255 ~ 0 (More blue)

* The red, green and blue colors can be adjusted and registered respectively.

- This setting can also be configured from the remote control. (P12)

Setting Menu (Continued)

Image>Gamma

08 Gamma

Sets the gradation characteristics of the projected image.

Normal	For normal circumstances, select this setting.
A	Sets gamma to "A".
B	Sets gamma to "B".
C	Sets gamma to "C".

- "Normal" is suitable for normal circumstances but "A", "B" or "C" can be selected according to your preference.
- This setting can also be configured from the remote control. (P12)

Image>Offset

09 Offset

Adjusts the respective brightness of the red, green and blue colors. (Offset level)

Red	(Less red) -30 ~ 30 (More red)
Green	(Less green) -30 ~ 30 (More green)
Blue	(Less blue) -30 ~ 30 (More blue)

Image>Pixel Adjust

10 Pixel Adjust

Makes fine adjustments of 1 pixel unit to the red, green and blue colors respectively in the horizontal/vertical direction of the image.

Horiz. Red	(Moves red to left) 1 ~ 7 (Moves red to right)
Horiz. Green	(Moves green to left) 1 ~ 7 (Moves green to right)
Horiz. Blue	(Moves blue to left) 1 ~ 7 (Moves blue to right)
Vert. Red	(Moves red down) 1 ~ 5 (Moves red up)
Vert. Green	(Moves green down) 1 ~ 5 (Moves green up)
Vert. Blue	(Moves blue down) 1 ~ 5 (Moves blue up)

- The horizontal and vertical directions are reversed when the image is flipped to the left or right, or flipped up or down.
- To adjust, use still images with distinct outlines.
- As the adjustments are minor, the effect may be difficult to see for some images.

Setup>Image Profile

11 Image Profile

Configures the image profile. (P32)

Cinema	Select this to view images with movie quality in a dark room.
Natural	Select this to view projected images with quality as-is in a dark room.
Dynamic	Select this to view images with clear quality in a bright room.
User1	Selects image profile registered in "User1".
User2	Selects image profile registered in "User2".
User3	Selects image profile registered in "User3".

- This setting can also be configured from the remote control. (P12)

Setup>Profile Memory**12 Profile Memory**

Registers or deletes image profiles.

Save User1	Registers image profile in "User1".
Save User2	Registers image profile in "User2".
Save User3	Registers image profile in "User3".
Clear User1	Returns image profile in "User1" to factory setting (natural).
Clear User2	Returns image profile in "User2" to factory setting (natural).
Clear User3	Returns image profile in "User3" to factory setting (natural).
Reset Cinema	Returns image profile in "Cinema" to factory setting.
Reset Natural	Returns image profile in "Natural" to factory setting.
Reset Dynamic	Returns image profile in "Dynamic" to factory setting.

- "Contrast", "Brightness", "Color", "Sharpness", "DNR", "Color Temp.", "Gamma" and "Offset" are registered in "Image Profile".

Setup>Picture Position**13 Picture Position**

Adjusts the horizontal/vertical position of the projected image.

- The display position value varies with the input signal.
- This adjustment is available only for analog input signals.

Setup>HDMI Input Level**14 HDMI Input Level**

Configures the input level setting of the HDMI input terminal.

Standard	For normal circumstances, select this setting.
Enhanced	Select this setting when the black-and-white of the projected image is unclear when RGB video signals are input from DVI devices.

- This setting is available only when projecting the HDMI input.

Setup>Mask**15 Mask**

Masks (Hides) the outer area of the projected image.

2.5%	Masks 2.5 % of the screen.
5%	Masks 5 % of the screen.
Off	No masking.

- Masking is available only when high definition images are input.

Video>COMP**16 COMP**

Configures the input signals of the component video input terminals.

Y Pb/Cb Pr/Cr	Select this when component video signals are input.
RGB	Select this when RGB video signals are input.
SCART	Select this when RGB video signals and sync signals are input from SCART plug for European market.

- This setting is available only when projecting the component video input.

Setting Menu (Continued)

Video>HDMI

17 HDMI

Configures the input signals of the HDMI input terminal.

Auto	Automatically configures input signals.
YCbCr(4:4:4)	Select this when Y Cb Cr (4:4:4) video signals are input.
YCbCr(4:2:2)	Select this when Y Cb Cr (4:2:2) video signals are input.
RGB	Select this when RGB video signals are input.

- This setting is available only when projecting the HDMI input.

Video>Aspect

18 Aspect

Configures the screen size (aspect ratio) of the projected image.

4:3	Sets screen size of the projected image to 4:3.
16:9	Sets screen size of the projected image to 16:9.
Zoom	Zooms the image.

- When high definition images are input, the screen size is fixed at "16:9".
- This setting can also be configured from the remote control. (P12, 22)

Video>Film Mode

19 Film Mode

Select this to view movies shot on film.

Auto	For normal circumstances, select this setting.
Off	Select this when you are not watching movies shot on film.

Video>Color System

20 Color System

Configures the color system.

Auto	Configures the color system automatically.
NTSC	Select this when the color system is NTSC.
NTSC4.43	Select this when the color system is NTSC4.43.
PAL	Select this when the color system is PAL.
PAL-M	Select this when the color system is PAL-M.
PAL-N	Select this when the color system is PAL-N.
SECAM	Select this when the color system is SECAM.

- This setting is available only when projecting the video or S-video input.

Video>Black Level

21 Black Level

Configures the black level.

0 %	Select this when the gradation of the dark portions of an image is indistinct with the 7.5 % setting.
7.5 %	Select this when the dark portions of an image appears washed out with the 0 % setting.

- This setting can only be adjusted when NTSC signals are input to the video or S-video input terminal.

Install.>Menu Position**22 Menu Position**

Sets the display position of the menu.

Upper left	Displays menu on the upper left of the screen.
Upper center	Displays menu on the upper center of the screen.
Upper right	Displays menu on the upper right of the screen.
Left center	Displays menu on the left center of the screen.
Center	Displays menu on the center of the screen.
Right center	Displays menu on the right center of the screen.
Lower left	Displays menu on the lower left of the screen.
Lower center	Displays menu on the lower center of the screen.
Lower right	Displays menu on the lower right of the screen.

Install.>Menu Display**23 Menu Display**

Sets the duration for displaying the menu.

15 sec	Displays for 15 seconds.
On	Always display.

Install.>Line Display**24 Line Display**

Sets whether to display the input when switching input.

5 sec	Displays for 5 seconds.
Off	Do not display.

Install.>Flip H**25 Flip H**

Select this when the image is projected from the back of the screen or when the projector is hung from the ceiling.

On	Flips image to the left or right.
Off	Do not flip image to the left or right.

Install.>Flip V**26 Flip V**

Select this when the projector is hung from the ceiling.

On	Flips image up or down.
Off	Do not flip image up or down.

Setting Menu (Continued)

Install.>High Altitude Mode

27 High Altitude Mode

Select this when using the projector in a location of low atmospheric pressure (higher than 900 meters above sea level).

On	Activate.
Off	Do not activate.

Func.>Back Color

28 Back Color

Configures the screen color displayed when there is no input signal.

Blue	Sets screen color to "Blue".
Black	Sets screen color to "Black".

Func.>Sleep Timer

29 Sleep Timer

Sets the lapse time before automatically switching to the standby mode when there is no input signal.

15	Switch to standby mode after 15 minutes.
30	Switch to standby mode after 30 minutes.
60	Switch to standby mode after 60 minutes.
Off	Do not switch to standby mode.

Func.>D-ILA Logo

30 D-ILA Logo

Sets whether to display "D-ILA Logo" during startup.

On	Displays for 5 seconds.
Off	Do not display.

Func.>Lamp Power

31 Lamp Power

Configures the output of the light-source lamp.

Normal	For normal circumstances, select this setting. (170 W)
High	Select this when it is difficult to see the image in a bright room. (200 W)

- Changing the lamp power will not change the lamp time (lamp life).
- The setting cannot be changed within approximately 90 seconds after this unit has been turned on.
- Settings cannot be changed within approximately 60 seconds after they are made.

Func.>Test Pattern

32 Test Pattern

Displays 6 types of test patterns.

- This can also be displayed from the remote control. (P12)

Func.>Language**33 Language**

Sets the language of the menu display.

日本語	Japanese
English	English
Deutsch	German
Español	Spanish
Italiano	Italian
Français	French
Português	Portuguese
Nederlands	Dutch
Svenska	Swedish
Norsk	Norwegian
中文	Chinese (Simplified)

Info.**34 Input**

Displays the currently selected video input.

35 Source

Displays the types of the current input video signals.

36 Lamp Time

Displays the accumulated hours of usage of the light-source lamp.

- This can also be displayed from the remote control. (P12)

Customizing Projected Images

You can adjust the projected image to a desired image quality and register the adjusted value. (Image profile)
Besides the default "Cinema", "Natural" and "Dynamic" settings, there are 3 more types of user-defined settings for image profile.

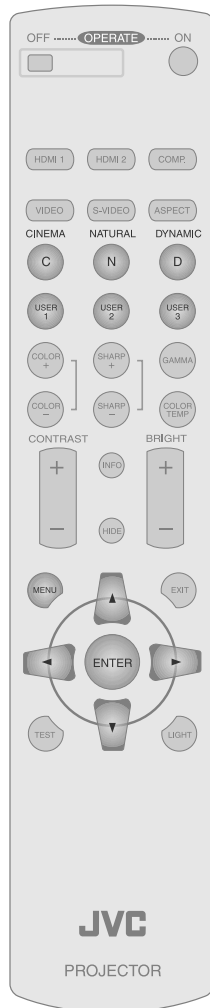

Changing the Default Image Profile Values

"Contrast", "Brightness", "Color", "Sharpness", "DNR", "Color Temp.", "Gamma" and "Offset" are registered in the image profile.

1 Select the image profile

CINEMA NATURAL DYNAMIC



2 Adjust image quality

Example: To adjust "Contrast"

1 Select "Image" → "Image Adjust"

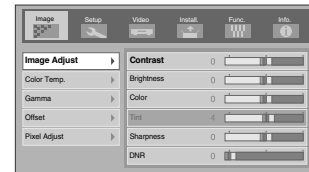
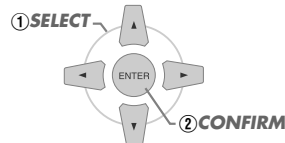

2 Adjust the setting

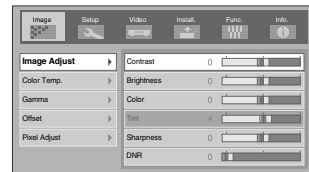
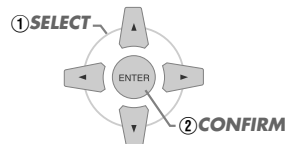

- "Contrast", "Brightness", "Color", "Sharpness", "Color Temp." and "Gamma" can also be adjusted from the remote control. (P12)

3 Other items can also be adjusted

4 To end



- To return to the default values, reset the registered settings with "Profile Memory" in the setting menu. (P27 - 12)

Registering User-defined Image Profiles

1 Select the image profile



2 Adjust image quality

- See "Changing the Default Image Profile Values" for procedures on adjusting the image quality. (P32)

3 Register the image profile

1 Select "Setup" ➔ "Profile Memory"

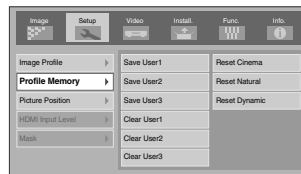
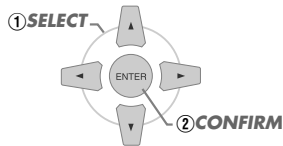

2 Register the setting

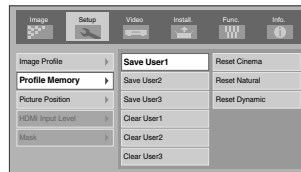
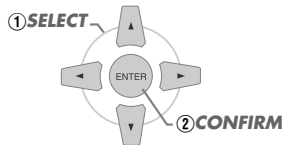

4 To end



- To return to the default values, reset the registered settings with "Profile Memory" in the setting menu. (P27 - 12)



- Adjustment settings of image quality will not be registered if other image profiles are selected before registering these settings.

Troubleshooting

Before sending the unit to your authorized dealer for repair, check the following points.

The following situations are not malfunctions.

- You do not need to worry under the following situations if there is no abnormality on the screen.
 - Part of the top surface or front of the unit is hot.
 - A creaking sound is heard from the unit.
 - An operating sound is heard from the internal of the unit.
- Perform the following operations when the unit is unable to operate normally due to external static or noises.
 - ① When the unit is in standby mode, pull out the power plug, then insert again.
 - ② Press the power button on the unit to turn on the power again.
- A sound may be heard when the lamp is off but there is no danger.
- D-ILA device is manufactured using high-precision technology but there may be some missing pixels or pixels that remain permanently lit up.

Power is not supplied		
Is the power cord disconnected?	Insert the power cord (plug) firmly.	☞ P20
Is the lamp cover properly shut?	Remove the power plug when the unit is in standby mode and close the lamp cover properly. After that, insert the plug again.	☞ P39
Is the lamp in Cool Down mode?	After the Cool Down mode is complete, turn on the power again.	☞ P21

Projected image is dark		
Is the lamp near exhaustion?	Check the lamp time on the information menu. Prepare a new lamp unit or replace as soon as possible when the lamp is near exhaustion.	☞ P38~40

The unit works when power is turned on but stops abruptly after a few minutes		
Are the air inlets and exhaust vent blocked?	Remove the power plug when the unit is in standby mode and remove any blocking object. After that, insert the plug again.	☞ P2, 10
Is the filter dirty?	Clean the filter.	☞ P41

Video image does not appear		
Is the lens cap removed?	Remove the lens cap.	☞ P20
Is the correct external input selected?	Select the correct external input.	☞ P20
Is the AV device properly connected?	Connect the AV device properly.	☞ P14~16
Is the power of the AV device turned on?	Turn on the power of the AV device and play the video.	☞ P20
Are the correct signals being output from the AV device?	Set the AV device properly.	☞ P14~16
Is the setting of the input terminal correct?	Set "COMP" and "HDMI" in the setting menu according to the input signal.	☞ P27 - 16 ☞ P28 - 17
Is the video image temporarily hidden?	Press the [HIDE] button to display the video image again.	☞ P21

Color does not appear or looks strange		
Is the image correctly adjusted?	Adjust "Color" and "Tint" in the setting menu.	☞ P25 - 03 04

Video image is fuzzy

Is the focus correctly adjusted?	Adjust accordingly using the focus adjustment ring.	📖 P21
Is the unit placed too near or too far away from the screen?	Set the unit at a correct distance from the screen.	📖 P18, 19

Video images are missing

Has setting been performed for screen mask?	Set the "Mask" in the setting menu to "Off".	📖 P23, 27 - 15
Is the display out of position?	Alter the "Picture Position" value in the setting menu to ensure that images are not missing.	📖 P27 - 13



Remote control does not work

Are batteries installed correctly?	Match the polarities (⊕ or ⊖) correctly when inserting the batteries.	📖 P13
Are batteries exhausted?	Replace with new batteries.	📖 P13
Is there an obstructive object between the remote control and remote sensor?	Remove any obstructive objects.	📖 P13
Is the remote control held too far away from the unit?	Hold the remote control closer to the sensor when using.	📖 P13

Power is cut off suddenly

Has setting been performed for sleep time?	Set the "Sleep Timer" in the setting menu to "Off".	📖 P30 - 29
--	---	------------

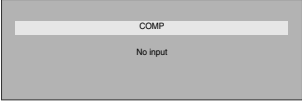
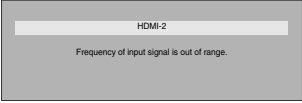
What to Do When These Messages Are Displayed

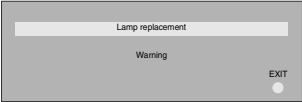
Message	Cause (Details)
	<p>No device is connected to the input terminal. The input terminal is connected but there is no signal.</p> <p>➔ Input the video signals.</p>
	<p>A video signal that cannot be used in this unit has been input.</p> <p>➔ Input video signals that can be used.</p>
	<p>The message is displayed when the accumulated lamp time has exceeded 1900 hours. To clear the message, press the [EXIT] button.</p> <p>➔ Get ready a new lamp unit and replace as soon as possible.</p>
	<p>The message is displayed when the accumulated lamp time has exceeded 2000 hours. The message is displayed each time during projection. To clear the message, press the [EXIT] button.</p> <p>➔ Replace with a new lamp unit and reset the lamp time. (📖 P38~40)</p>

About Warning Indicators

The accumulated lamp time or warning mode of this unit is displayed by the indicators.
For information on indicator display during normal operation, see "Controls and Features" (P10).

No.	Indicator			Content
	STANDBY/ON	LAMP	WARNING	
1	-	Light on	-	Lamp replacement is near (P38 ~ 40) (When accumulated lamp time has exceeded 1900 hours)
2				Lamp has reached end of life (P38 ~ 40) (When accumulated lamp time has exceeded 2000 hours)
3	-	Blinking	Light on	Lamp does not light up and unit is unable to project
4				Lamp is turned off during projection
5				Lamp cover is removed
6	-	-	Light on	There is an error in the circuit operation (Operation error in microcomputer circuit)
7				There is an error in the circuit operation (Operation error in drive circuit)
8				Internal temperature is abnormally high (Internal temperature error)
9				External temperature is high (External temperature error)
10				Cooling fan has stopped (Fan locked)

Actions to Be Taken for Warning Mode

When the unit enters into warning mode (No. 3 to 10), it will automatically stop projection and run the cooling fan for about 60 seconds.

After the cooling fan has stopped, pull out the power plug from the power outlet.

Then, follow the procedures below.

No.	Check	Action
3	<ul style="list-style-type: none"> ● Check that an impact shock has not occurred during operation. ● Check that the lamp unit and lamp cover are correctly installed. 	Turn on the power again.
4		
5		
6	<ul style="list-style-type: none"> ● Check that nothing is blocking the air inlets. ● Check that the external temperature is normal. 	Leave the unit until it cools down. After that, turn on the power again.
7		
8		
9		
10		

If the warning indication is displayed again, wait for the cooling fan to stop. Then pull out the power plug from the power outlet. Call your authorized dealer for repair.

Replacing the Lamp

The lamp is a consumable item. If the image is dark or the lamp is turned off, replace the lamp unit.

- When the lamp replacement time approaches, a message is displayed on the screen and the condition is indicated by the indicator. (P36, 37)



CAUTION

- Pull the power plug from the power outlet. Failure to do so may cause injuries or electric shocks.
- Do not replace the lamp immediately after the unit has been used. Allow a cooling period of 1 hour or more before replacement. The temperature of the lamp is still high and this may cause a burn.
- Do not apply shock to the lamp unit. It may cause lamp blowout.
- Do not use flammable air duster to clean the internal parts of the unit. This may cause fire.



MEMO

Usable Lamp Life

- The usable lamp life for this unit is approximately 2000 hours. The usable lamp life of 2000 hours is merely the average usable life of lamps and we do not provide any guarantee for this figure.
- The lamp life may not reach 2000 hours depending on the operating conditions.
- When the lamp has reached the end of its usable life, deterioration progresses rapidly.
- If the image is dark or the color tone is abnormal, replace the lamp unit as soon as possible.

Purchasing the Lamp Unit

Please consult your authorized dealer.

- Lamp Unit
Part No. : BHL5009-S

Procedure for Lamp Replacement

1 Remove the lamp cover

- Remove the screws with a ⊕ screwdriver.

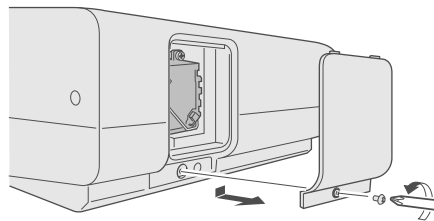

2 Loosen the screws on the lamp unit

- Loosen the screws with a ⊕ screwdriver.

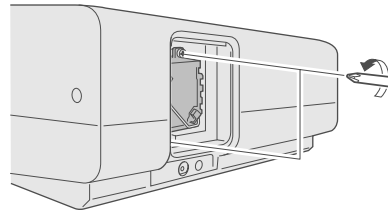

3 Pull out the lamp unit

- Grasp the handle and pull out the lamp unit.

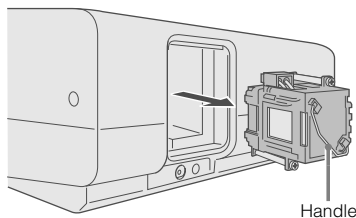

4 Install the new lamp unit

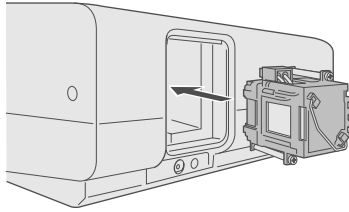

5 Tighten the screws of the lamp unit

- Fasten the screws with a ⊕ screwdriver.

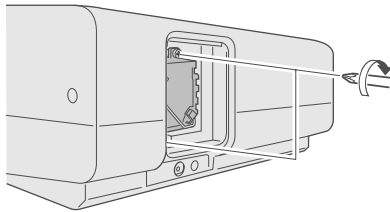

6 Attach the lamp cover

- Insert the top part (with 2 claws) of the lamp cover into the unit.
- Fasten the screws with a ⊕ screwdriver.

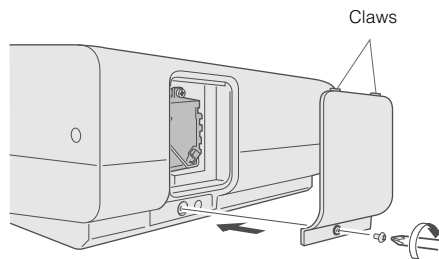

CAUTION

- Use only genuine replacement parts for the lamp unit. Also, never attempt to re-use an old lamp unit. This may cause a malfunction.
- Do not touch the surface of a new lamp. This may shorten the lamp life and cause lamp blowout.



MEMO

After Replacing the Lamp

- Do not place the removed lamp unit at locations reachable by children or near combustible items.
- Dispose used lamp units in the same way as fluorescent lamps. Follow your local community rules for disposal.

Replacing the Lamp (Continued)

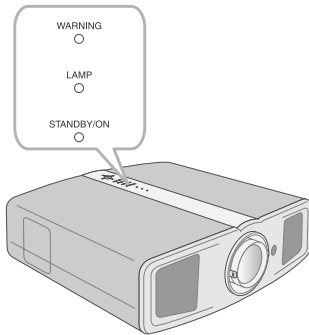
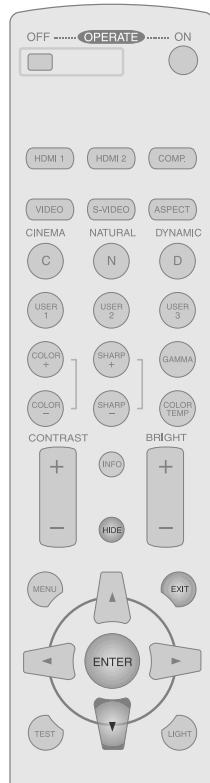

CAUTION

- Reset the lamp time only when you have replaced the lamp.
- Never reset it when the lamp is still in use. Otherwise, the approximate standard for gauging replacement time may be inaccurate and lamp blowout may occur.

Resetting Lamp Time

After installing a new lamp unit, reset the lamp time.

1 Insert the power plug to the power outlet

 / I STANDBY/ON  Light on (Red)

2 Reset lamp time

- Press in the order as shown.

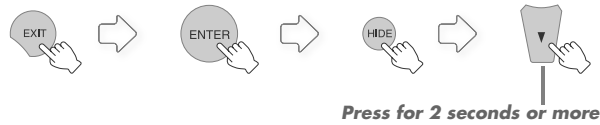

- The [LAMP] indicator and [STANDBY/ON] indicator blink alternately for 3 seconds. After that, the unit switches to standby mode.

Cleaning and Replacing the Filter

Clean the filter regularly or air intake efficiency may deteriorate and malfunction may occur.

1 Remove the inner filter

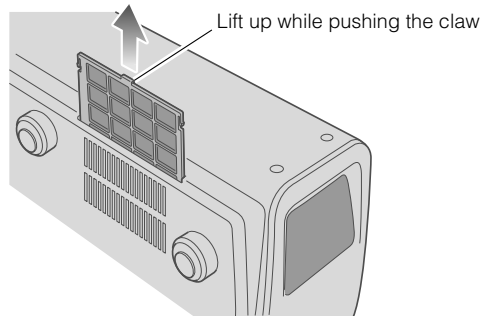

2 Clean the filter

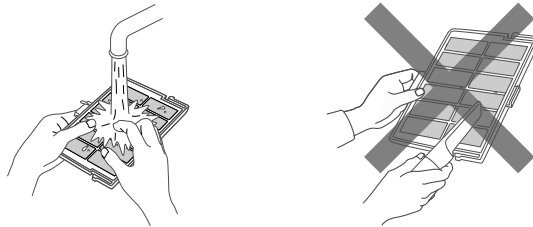

- Wash the filter with water and dry it in a shaded area.
- In extremely soiled cases, use of a neutral detergent is recommended. Put on rubber gloves when using a neutral detergent.
- After washing the filter with water, make sure that it is completely dry before reinstalling. Otherwise, electric shocks or malfunctions may occur.
- Do not clean the filter with a vacuum cleaner or air duster. The filter is soft and may be damaged.

3 Reinstall the inner filter

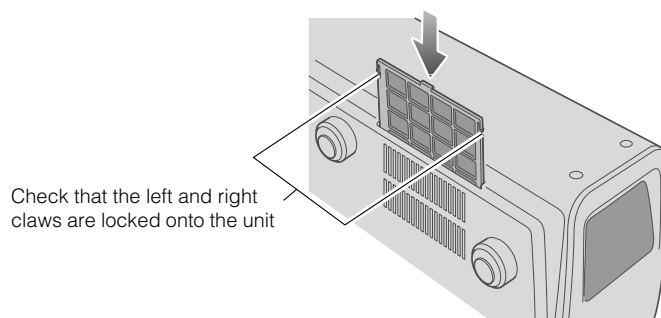

CAUTION

- Pull the power plug from the power outlet.



MEMO

If the filter is damaged or too dirty to be cleaned

- Replace with a new filter. A dirty filter will dirty the internal parts of the unit and cause shadows on the video image.
- To purchase a new filter or when there is dirt in the internal parts, consult your authorized dealer.

■ Inner Filter
Part No. : LC32058-002A

RS-232C Interface

Control of this unit via a computer is possible by connecting the computer to this unit with a RS-232C cross cable (D-Sub 9 pin).

RS-232C Specifications

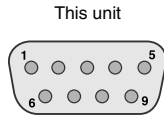

Pin No.	Signal	Operation	Signal Direction
2	RxD	Receive data	This unit ← PC
3	TxD	Transmit data	This unit → PC
5	GND	Signal ground	—
1, 4, 6 – 9	N/C	—	—

● PC refers to the controller such as a personal computer.

Mode	Non-synchronous
Character Length	8 bit
Parity	None
Start Bit	1
Stop Bit	1
Data Rate	19200 bps
Data Format	Binary

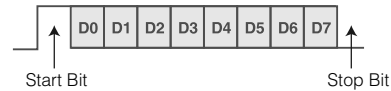

Command Format

The command between this unit and the computer consists of “Header”, “Unit ID”, “Command”, “Data” and “End”.

● Header (1 byte), Unit ID (2 bytes), Command (2 bytes), Data (n bytes), End (1 byte)

■ Header

This binary code indicates the start of communication.

Binary code	Type	Description
21	Operating command	PC → This unit
3F	Reference command	PC → This unit
40	Response command	This unit → PC
06	ACK	This unit → PC (When the command is accepted without error, it returns to PC)

■ Unit ID

This code specifies the unit. The binary code is fixed at “8901”.

■ Command and data

Operating command and data (Binary code)

Command	Type	Data description
0000	Connection check	Checks whether communication is available between this unit and the PC during standby.
5057	Power supply	During standby 31: Turns on the power. During power on 30: Turns off the power. (Standby mode)
4950	Input	During power on 30: S-VIDEO 31: VIDEO 32: COMP. 36: HDMI 1 37: HDMI 2
5243	Remote Control	Sends the same code as the supplied remote control. ● "Remote control code" (P44)

Reference command and data (Binary code)

Command	Type	Data description
5057	Power supply	During standby or power on 30: Standby mode 31: Power-on mode 32: During Cool Down mode 34: Warning mode
4950	Input	During power on 30: S-VIDEO 31: VIDEO 32: COMP. 36: HDMI 1 37: HDMI 2

■ End

This code indicates the end of communication. The binary code is fixed at "0A".

RS-232C Interface (Continued)

■ Remote control code

- Binary code is sent during communication.

Remote control button name	Binary code
▲	37 33 30 31
▼	37 33 30 32
EXIT	37 33 30 33
OPERATE ON	37 33 30 35
OPERATE OFF	37 33 30 36
HIDE	37 33 31 44
MENU	37 33 32 45
ENTER	37 33 32 46
▶	37 33 33 34
◀	37 33 33 36
VIDEO	37 33 34 42
S-VIDEO	37 33 34 43
COMP.	37 33 34 44
TEST	37 33 35 39
CINEMA	37 33 36 39
NATURAL	37 33 36 41
DYNAMIC	37 33 36 42

Remote control button name	Binary code
USER1	37 33 36 43
USER2	37 33 36 44
USER3	37 33 36 45
HDMI 1	37 33 37 30
HDMI 2	37 33 37 31
INFO	37 33 37 34
GAMMA	37 33 37 35
COLOR TEMP	37 33 37 36
ASPECT	37 33 37 37
CONTRAST (+)	37 33 37 38
CONTRAST (-)	37 33 37 39
BRIGHT (+)	37 33 37 41
BRIGHT (-)	37 33 37 42
COLOR (+)	37 33 37 43
COLOR (-)	37 33 37 44
SHARP (+)	37 33 37 45
SHARP (-)	37 33 37 46

RS-232C Communication Examples

This section shows the communication examples of RS-232C.

■ Operating command

Type	Command	Description
Connection check	PC → This unit: 21 89 01 00 00 0A This unit → PC: 06 89 01 00 00 0A	Checks connection
Power (On)	PC → This unit: 21 89 01 50 57 31 0A This unit → PC: 06 89 01 50 57 0A	When power is turned on from standby mode
Power (Off)	PC → This unit: 21 89 01 50 57 30 0A This unit → PC: 06 89 01 50 57 0A	When power is turned off (standby mode) from power-on mode
Input (COMP.)	PC → This unit: 21 89 01 49 50 32 0A This unit → PC: 06 89 01 49 50 0A	When video input is set to component
Remote Control (MENU)	PC → This unit: 21 89 01 52 43 37 33 32 45 0A This unit → PC: 06 89 01 52 43 0A	When the same operation as pressing the [MENU] button on the remote control is made

■ Reference command

Type	Command	Description
Power (On)	PC → This unit: 3F 89 01 50 57 0A This unit → PC: 06 89 01 50 57 0A This unit → PC: 40 89 01 50 57 31 0A	When information on power-on mode is acquired
Input (S-VIDEO)	PC → This unit: 3F 89 01 49 50 0A This unit → PC: 06 89 01 49 50 0A This unit → PC: 40 89 01 49 50 30 0A	When information on S-VIDEO input is acquired

Copyright and Caution

About Trademarks and Copyright

- HDMI, HDMI logo and high definition multimedia interface are trademarks or registered trademarks of HDMI Licensing LCC.
- This product uses Ricoh TrueType fonts manufactured and sold by Ricoh Co., Ltd.

Caution

D-ILA Device Characteristics

Do not project still pictures or pictures that have still segments for a long period of time. The still parts of the picture may remain on the screen. This is a characteristic of D-ILA devices and not a malfunction. The picture will disappear over time.

When Unit is Unused for a Long Time

Prolonged disuse of the unit may effect an error on the functions. Turn on the power occasionally and operate the unit.

Viewing Advice

Looking at the screen continually for a prolonged time will cause your eyes to get tired. Allow your eyes to rest at intervals.

Usage Environment

- Avoid direct exposure of screen to direct sunlight and illumination. Block light using a curtain. Images can be well projected by darkening the brightness of the room.
- Do not use this unit in rooms with cigarette smoke or oily smoke. This may cause the unit to malfunction.

Parts Replacement

This unit contains parts (optical part, cooling fan, etc.) that require replacement to maintain its functioning. The estimated time for parts replacement varies greatly depending on the usage and environment. Please consult your authorized dealer for replacement.

Maintenance Procedures

Dirt on the cabinet

- Gently clean dirt on the cabinet with a soft cloth. In the case of heavy soiling, soak a cloth in water, wring dry and wipe, followed by wiping again with a dry cloth. Pay attention to the following as the cabinet may deteriorate in condition or paint may come off.
 - Do not wipe with thinner or benzene
 - Do not spray volatile chemicals like insecticide
 - Do not allow prolonged contact with rubber or plastic products

Dirt in the air inlets

- Use a vacuum cleaner to suck up the dirt. Otherwise, use a cloth to wipe off the dirt. If dirt is allowed to accumulate in the air inlets, the internal temperature cannot be adjusted and this may cause a malfunction.

Dirt on the lens

- Clean the dirt using commercial blowers or lens cleaning papers for cleaning glasses and cameras. Do not use fluid-type cleaning agents. This may lead to peeling of the surface coating film.

Transporting this Unit

When transporting this unit for repair or during house moving, attach the buffer material on the top and bottom of the lens for protection. Failure to do so may subject the lens to shock causing damage. Attach the buffer material after adjusting the lens to the center position.

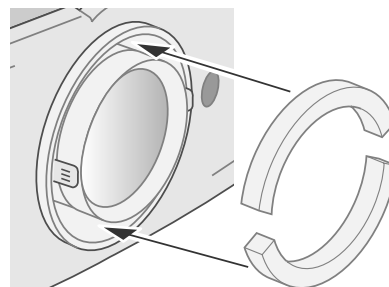

Mounting this Unit

Measures to prevent the unit from toppling or dropping should be taken for safety reasons and accident prevention during emergencies including earthquakes.

When mounting this unit on a pedestal or ceiling, remove the 4 feet on the bottom surface and use all the 4 screw holes (M5 screws) to mount.

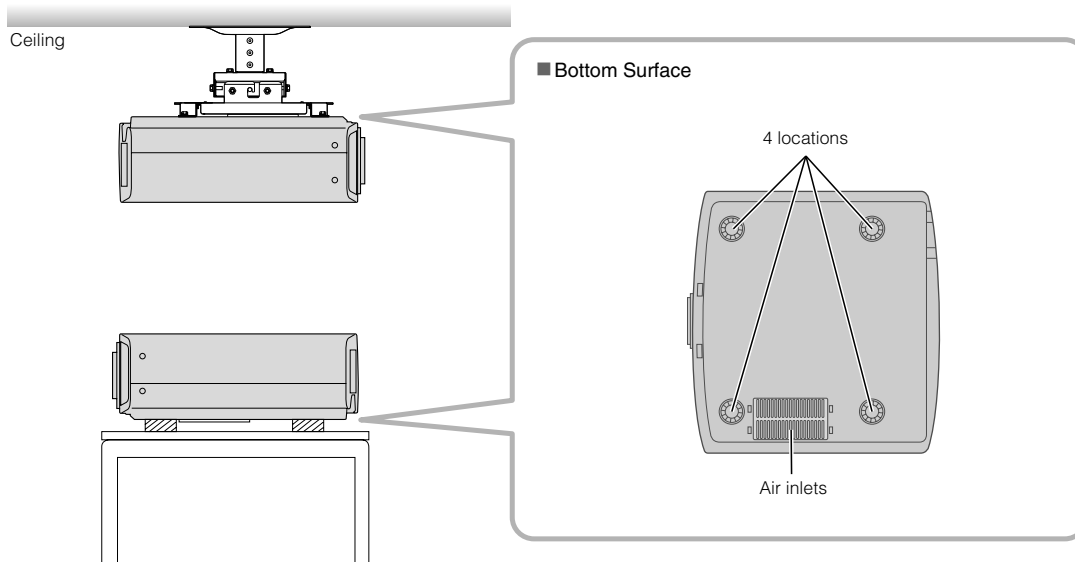

Precautions for Mounting

- Special expertise and techniques are required for mounting this unit. Be sure to ask your dealer or a specialist to perform mounting.
- Depth of the screw holes (screw length) is 30 mm. Use screws shorter than 30 mm but longer than 19 mm.
- When mounting to a pedestal, ensure sufficient space (foot height of 21.5 mm or higher) around the unit so that the air inlets are not blocked.
- Regardless whether the unit is still under guarantee, JVC is not liable for any product damage caused by mounting the unit with non-JVC ceiling fittings or when the environment is not suitable for ceiling-mount.
- When using the unit hanging from a ceiling, pay attention to the surrounding temperature. When a heater is in use, temperature around the ceiling is higher than expected.

Specifications

Product Name	D-ILA Home Theater Projector
Model Name	DLA-RS1
Display Panel/Size	D-ILA device *1 *2 / 0.7" (1920 pixels × 1080 pixels) × 3 (Total no. of pixels: Approx. 6.22 million)
Projection Lens	2.0x manual zoom lens (1.4: 1 ~ 2.8: 1) (Zoom/Focus: Manual)
Light-source Lamp	200 W Ultra-high pressure mercury lamp [Part No.: BHL5009-S]
Screen Size	Approx. 60" ~ 200" (Aspect ratio: 16:9)
Projection Distance	Approx. 1.8 m ~ 12.2 m
Color System	NTSC, NTSC4.43, PAL, PAL-M, PAL-N, SECAM (Auto/Manual switch)
Analog Video Input Format	480i, 480p, 576i, 576p, 720p/50 Hz, 720p/60 Hz, 1080i/50 Hz, 1080i/60 Hz
Digital Video Input Format	480i, 480p, 576i, 576p, 720p/50 Hz, 720p/60 Hz, 1080i/50 Hz, 1080i/60 Hz, 1080p/24 Hz, 1080p/50 Hz, 1080p/60 Hz, VGA 60Hz
Resolution	1920 dots × 1080 dots
Input Terminals	
Video Input (VIDEO)	1-line, RCA pin jack × 1 1.0 V(p-p), 75 Ω, synchronous
S-video Input (S-VIDEO)	1-line, mini DIN 4 pin × 1 Y: 1.0 V(p-p), 75 Ω C: 0.286 V(p-p), 75 Ω (NTSC); 0.3 V(p-p), 75 Ω (PAL)
Component Video Input (COMPONENT)	1-line, RCA pin jack × 3 Y: 1.0 V(p-p), 75 Ω C _B /P _B , C _R /P _R : 0.7 V(p-p), 75 Ω
HDMI Input (HDMI 1, HDMI 2)	2-line, HDMI 19 pin × 2 (HDCP compliant) *3
Power Requirements	AC 110 V - 240 V 50/60 Hz
Power Consumption	280 W (Standby mode: 2.7 W)
Operation Environment	Temperature: 5 °C ~ 35 °C Humidity: 20 % ~ 80 % (No condensation) (Storage Temperature: -10 °C ~ 60 °C)
Installation Height	Below 5000 ft (Approx. 1524 m)
Dimensions (Width × Height × Depth)	455 mm × 172.5 mm × 418.5 mm (17 7/8" × 6 7/8" × 16 1/2") (Excluding lens and protrusion portion)
Mass	11.6 kg (25.5 lbs)
Accessories	(See Page 9)

*1 D-ILA is the abbreviation for Direct drive Image Light Amplifier.

*2 D-ILA devices are manufactured using extremely high-precision technology. Pixel effectiveness is 99.99 %. Only 0.01 % or less of the pixels are either missing or would remain permanently lit up.

*3 HDCP is the abbreviation for High-bandwidth Digital Content Protection system.
The image of HDMI input terminal may not be displayed due to HDCP specification change.

• Design and specifications are subject to change without prior notice.

• Please note that some of the pictures and illustrations may have been abridged, enlarged or contextualized in order to aid comprehension. Images may differ from the actual product.

Dimensions

(Unit: mm)

■ Top Surface

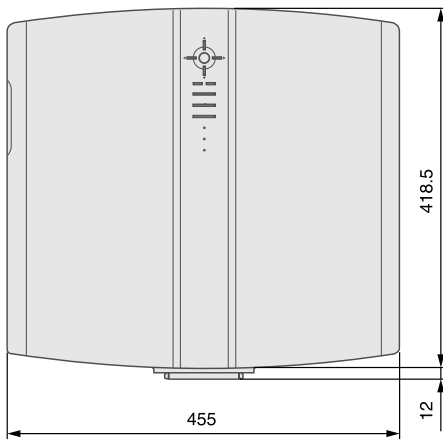

■ Bottom Surface

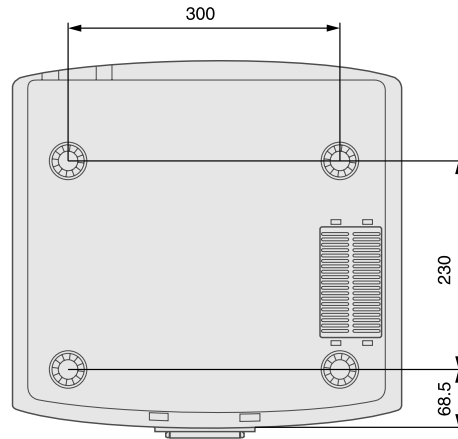

■ Front

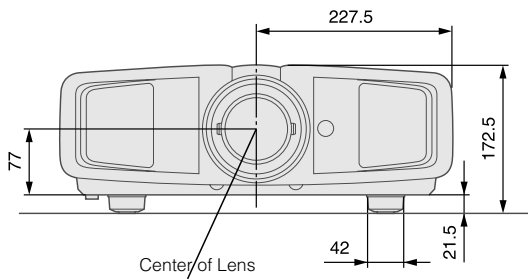

■ Left Side

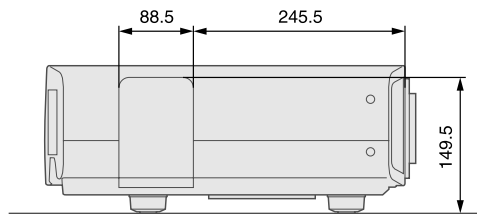

Getting Started

Preparation

Basic Operation

Settings

Troubleshooting

Others

Memo

Free Manuals Download Website

<http://myh66.com>

<http://usermanuals.us>

<http://www.somanuals.com>

<http://www.4manuals.cc>

<http://www.manual-lib.com>

<http://www.404manual.com>

<http://www.luxmanual.com>

<http://aubethermostatmanual.com>

Golf course search by state

<http://golfingnear.com>

Email search by domain

<http://emailbydomain.com>

Auto manuals search

<http://auto.somanuals.com>

TV manuals search

<http://tv.somanuals.com>