

JVC



DVD DIGITAL CINEMA SYSTEM

TH-C90

Consists of XV-THC90, SP-PWC90, SP-THC90F, SP-THC90C and SP-THC90S

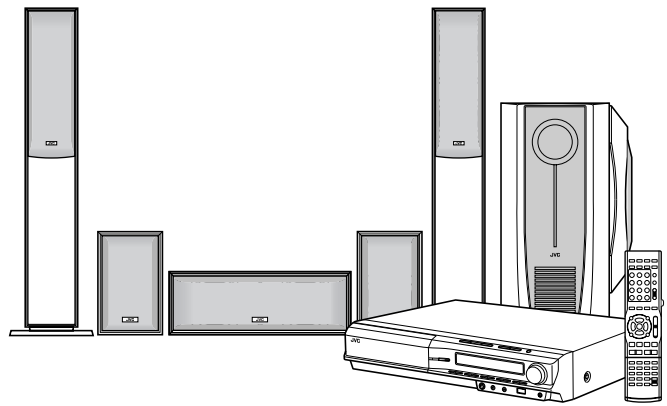

TH-C60

Consists of XV-THC60, SP-PWC60, SP-THC60F, SP-THC60C and SP-THC60S

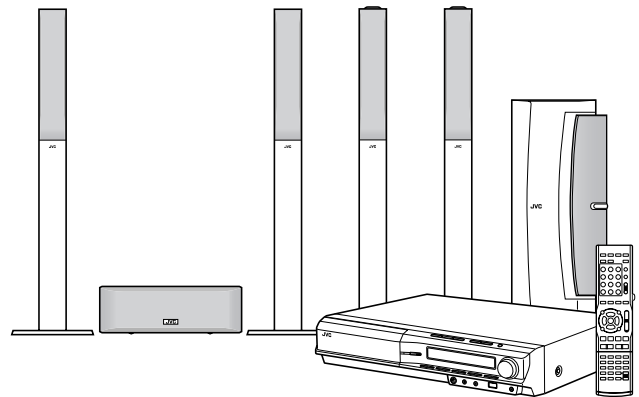

TH-C20

Consists of XV-THC20, SP-PWC20, SP-THC20F, SP-THC20C and SP-THC20S

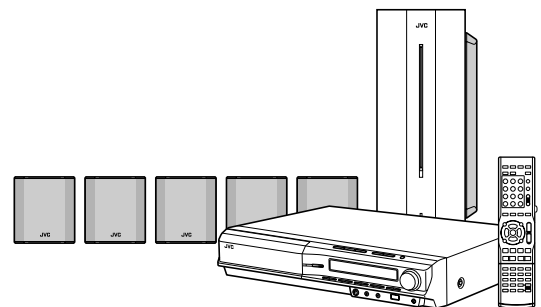

MPEG-4
ASF PLAYBACK

Digital Direct Progressive Scan

INSTRUCTIONS

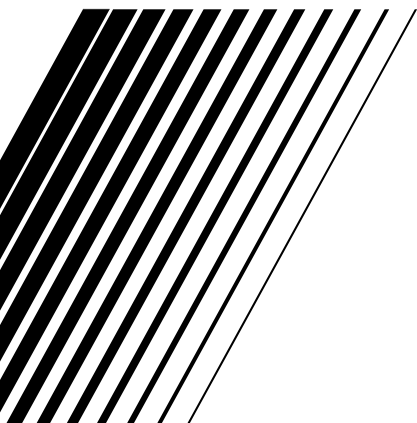

LVT1504-005B
[US, UG, UX]

Warnings, Cautions and Others

IMPORTANT FOR LASER PRODUCTS

1. CLASS 1 LASER PRODUCT
2. **CAUTION:** Do not open the top cover. There are no user serviceable parts inside the unit; leave all servicing to qualified service personnel.
3. **CAUTION:** Visible and/or invisible class 1M laser radiation when open. Do not view directly with optical instruments.

CAUTION

To reduce the risk of electrical shocks, fire, etc.:

1. Do not remove screws, covers or cabinet.
2. Do not expose this appliance to rain or moisture.

CAUTION – button! (XV-THC90/XV-THC60/XV-THC20)

Disconnect the mains plug to shut the power off completely (the STANDBY lamp goes off). When installing the apparatus, ensure that the plug is easily accessible.

The  button in any position does not disconnect the mains line.

- When the system is on standby, the STANDBY lamp lights red.
- When the system is turned on, the STANDBY lamp goes off. The power can be remote controlled.

CAUTION (SP-PWC90/SP-PWC60/SP-PWC20)

The power supply to the subwoofer is linked to the center unit. The POWER ON lamp on the subwoofer lights green when the power is turned on.

Warnings, Cautions and Others

Caution: Proper Ventilation

To avoid risk of electric shock and fire and to protect from damage, place the apparatus on a level surface. The minimal clearances are shown below:

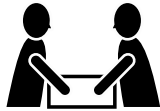
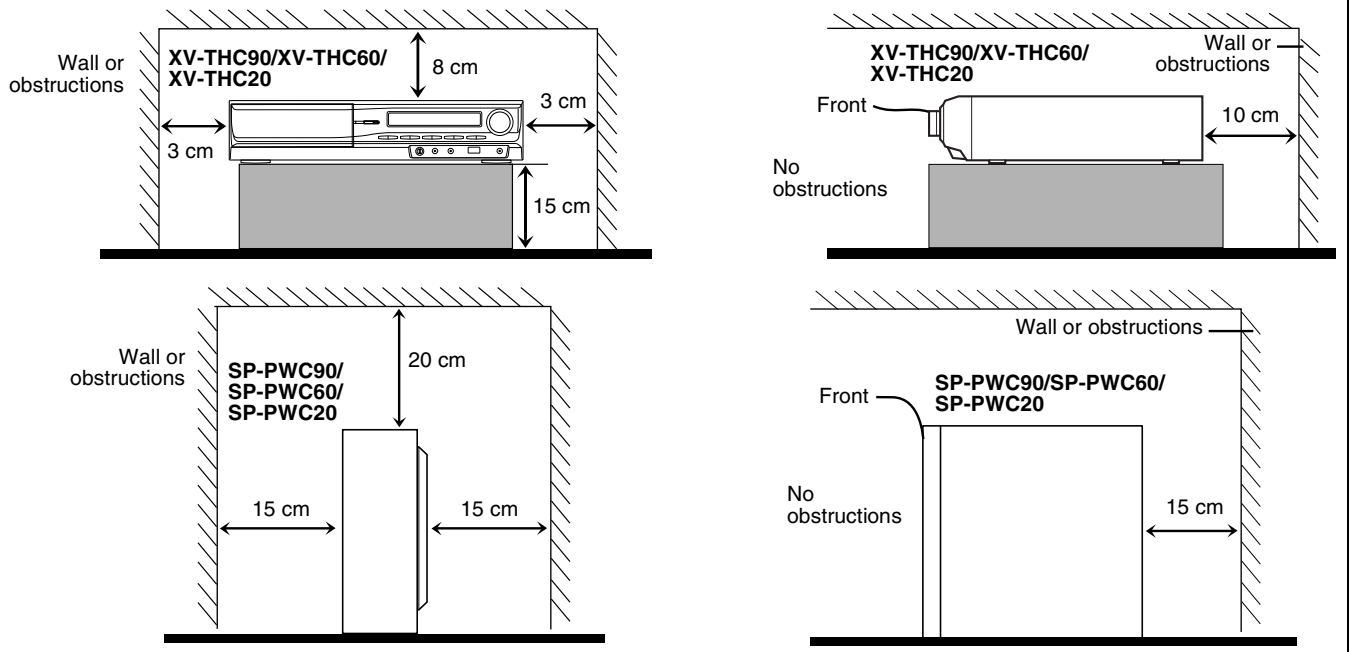

SP-THC90: 47 kg
SP-THC60: 32.5 kg

CAUTION!

To avoid personal injury or accidentally dropping the unit, have two persons unpack, carry, and install the unit.

CAUTION

- Do not block the ventilation openings or holes.
(If the ventilation openings or holes are blocked by a newspaper or cloth, etc., the heat may not be able to get out.)
- Do not place any naked flame sources, such as lighted candles, on the apparatus.
- When discarding batteries, environmental problems must be considered and local rules or laws governing the disposal of these batteries must be followed strictly.
- Do not expose this apparatus to rain, moisture, dripping or splashing and that no objects filled with liquids, such as vases, shall be placed on the apparatus.



[European Union only]

Table of contents

Introduction	2	Playback	21
Notes on handling	2	Basic playback	21
Supplied accessories	2	One Touch Replay	23
About discs	3	Fast-forward/fast-reverse search	23
Playable disc types	3	Skip to the beginning of a desired selection	24
Playable file types	4	Skipping at about 5-minute intervals	24
Description of parts and controls	5	Locating a desired title/group using number buttons	24
Connections	8	Playing back a bonus group	25
Connecting the FM and AM antennas	8	Selecting the desired title/playlist from the control display	25
Connecting the satellite (front, center, surround) speakers	9	Advanced operations	26
Speaker layout	13	Using the surround mode	26
Connecting a TV	13	Using the on-screen bar	27
Connecting the powered subwoofer	14	Playing from a specified position on a disc	29
Connecting to an analog component	14	Using the file control display	30
Connecting a cassette recorder (Only for TH-C90)	14	Resume Playback	31
Connecting to a digital component	14	Selecting a view angle	31
Connecting a USB mass storage class device	15	Selecting the subtitle	31
Connecting the power cord	15	Selecting the audio	32
Operating external components with the remote control	16	Special picture playback	32
Operating the TV	16	Program Playback	34
Operating the DBS tuner or CATV converter	17	Random Playback	35
Operating the VCR	17	Repeat Playback	35
Basic operations	18	Tray lock	36
Turning the system on/off	18	Setting the sound balance	36
Selecting the source to play	19	Setting DVD preferences	37
Adjusting the volume [VOLUME]	19	Using the setup menus	37
Listening with headphones (not supplied)	19	Menu description	37
Turning off the sound temporarily [MUTING]	19	Tuner operations	39
Adjusting the brightness of the indications [DIMMER] ...	19	Setting the AM tuner interval spacing	39
Sleep Timer [SLEEP]	20	Manual tuning	39
Adjusting the output level of the subwoofer and speakers	20	Preset tuning	40
Adjusting the sound	20	Selecting the FM reception mode	40
Changing the scan mode	20	Reducing the noise of AM broadcast	40
		Karaoke operations	41
		Basic Karaoke operations	41
		Reserving songs	42
		Selecting audio	42
		Adding an echo effect to your voice	43
		Shifting the pitch of the playback sound	43
		References	44
		Maintenance	44
		Troubleshooting	44
		Specifications	45

Introduction

Notes on handling

■ Important cautions

Installation of the system

- Select a place which is level, dry and neither too hot nor too cold; between 5°C and 35°C.
- Leave sufficient distance between the system and the TV.
- Do not use the system in a place subject to vibration.

Power cord

- Do not handle the power cord with wet hands.
- A small amount of power is always consumed while the power cord is connected to the wall outlet (center unit only).
- When unplugging the power cord from the wall outlet, always pull on the plug, not the power cord.

To prevent malfunctions of the system

- There are no user-serviceable parts inside. If anything goes wrong, unplug the power cord and consult your dealer.
- Do not insert any metallic object into the system.
- Do not use any non-standard shape disc (like a heart, flower or credit card, etc.) available on the market, because it may damage the system.
- Do not use a disc with tape, stickers, or paste on it, because it may damage the system.

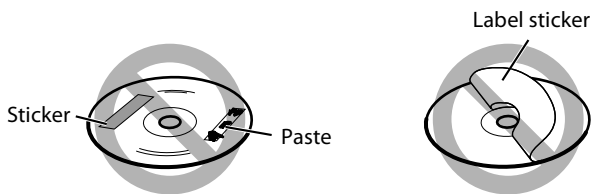

Note about copyright laws

Check the copyright laws in your country before recording from the discs. Recording of copyrighted material may infringe copyright laws.

Note about copyguard system

The discs are protected by copyguard system. When you connect the system to your VCR directly, the copyguard system activates and the picture may not be played back correctly.

■ Safety precautions

Avoid moisture, water and dust

Do not place the system in moist or dusty places.

Avoid high temperatures

Do not expose the system to direct sunlight and do not place it near a heating device.

When you are away

When away on travel or for other reasons for an extended period of time, disconnect the power cord plugs from the wall outlet.

Do not block the vents

Blocking the vents may damage the system.

Care of the cabinet

When cleaning the system, use a soft cloth and follow the relevant instructions on the use of chemically-coated cloths. Do not use benzene, thinner or other organic solvents including disinfectants. These may cause deformation or discoloring.

If water gets inside the system

Turn the system off and disconnect the power cord plug from the wall outlet, then call the store where you made your purchase. Using the system in this condition may cause a fire or electrical shock.









Supplied accessories

Check to be sure you have all of the supplied accessories. The number in parentheses is the quantity of the pieces supplied. If anything is missing, contact your dealer immediately.

- Remote control (1)
- Batteries (2)
- FM antenna (1)
- AM loop antenna (1)
- Power cord (1)
- System cord (1)
- Composite video cord (1)
- AC plug adapters (2) (except for the countries of the Middle East)
- Speaker cords (only for TH-C90/TH-C60)
 - 4 m: For satellite (front left/right) and center speakers (3)
 - 10 m: For satellite speakers (surround left/right) (2)
- Screws
 - TH-C90:
 - M4 x 30 mm (8)
 - TH-C60:
 - M5 x 40 mm (4)
 - M4 x 20 mm (8)
- Speaker cord clamps (only for TH-C60) (4)

Playable disc types

This system has been designed to play back the following discs:

DVD VIDEO		DVD AUDIO	
			
VCD/SVCD		Audio CD	
			
			

The ✓ in the list below shows available disc types and recording formats.

Disc type	Recording format		
	CD-R/-RW* ¹	DVD-R* ¹	DVD-RW* ¹
DVD Video	—	✓	✓
DVD Audio	—	✓	✓
DVD VR	—	✓	✓
VCD/SVCD	✓	—	—
Audio CD	✓	—	—
MP3	✓	✓* ²	✓* ²
WMA	✓	✓* ²	✓* ²
JPEG	✓	✓* ²	✓* ²
ASF	✓	✓* ²	✓* ²
MPEG-2	✓* ³	✓* ²	✓* ²
MPEG-1	✓* ³	✓* ²	✓* ²
DivX	✓	✓* ²	✓* ²

*¹ This system can play finalized discs only.

*² Recorded with UDF Bridge format.

*³ This system may not be able to play back a file if the file size is too large.

- It is possible to play back finalized +R/+RW (DVD Video Format only) discs. “DVD” lights on the display panel when a +R/+RW disc is loaded.
- This system accommodates the NTSC and PAL system. When you play an NTSC disc with the scan mode set to PAL (see page 20), the NTSC video signal is converted to the PAL60 signal and output.
- The Non-DVD side of a “DualDisc” does not comply with the “Compact Disc Digital Audio” standard. Therefore, the use of Non-DVD side of a DualDisc on this product may not be recommended.
- **On some DVD VIDEOS, DVD AUDIOS, VCDs or SVCDs, their actual operation may be different from what is explained in this manual. This is due to the disc programming and disc structure, not a malfunction of this system.**

DVD Logo is a trademark of DVD Format/Logo Licensing Corporation.

Notes on DVD-R and DVD-RW

- This system does not support “multi-border” disc.

Notes on CD-R and CD-RW

- This system can play CD-Rs or CD-RWs recorded with ISO 9660 format.
- This system supports “multi-session” discs (up to 20 sessions).
- This system cannot play “packet write” discs.

Region code of DVD VIDEO

DVD VIDEO players and DVD VIDEO discs have their own Region Code numbers. This system can play back DVD VIDEO discs whose Region Code numbers include the system’s Region Code, which is indicated on the rear panel.

- Example of playable DVD:

For the countries of the Middle East



For the countries of the Southeast Asia



If a DVD with an improper Region Code number is loaded, “REGION CODE ERROR!” appears on the TV screen and playback cannot start.

Some discs may not be played back because of their disc characteristics, recording conditions, or damage or stain on them.

Unplayable discs

DVD-ROM, DVD-RAM, CD-I (CD-I Ready), Photo CD, SACD, etc.

Playing back these discs will generate noise and damage the speakers.

Playable file types

For all playable files

- The system can only recognize and play files with one of the following extensions, which can be in any combination of upper and lower case;
MP3: “.MP3”, “.mp3”
WMA: “.WMA”, “.wma”
JPEG: “.JPG”, “.JPEG”, “.jpg”, “.jpeg”
ASF: “.ASF”, “.asf”
MPEG-2/MPEG-1: “.MPG”, “.MPEG”, “.mpg”, “.mpeg”
DivX: “.DIVX”, “.DIV”, “.divx”, “.div”, and “.AVI”, “.avi”
- Some files may not be played back. In this case, “NOT SUPPORTED” appears on the TV screen.
- Some files may not be played back normally because of their disc characteristics or recording conditions.
- The system recognizes up to 150 tracks (files) per group, 99 groups per disc/device, and the total number of the tracks (files) that the system can play is 4000.
- MP3/WMA/JPEG/ASF/MPEG-2/MPEG-1/DivX files require a longer readout time. (It differs due to the complexity of the directory/file configuration.)
- If different kinds of files are mixed, set the FILE TYPE setting in the PICTURE menu to the appropriate setting for the data to be read (“AUDIO”, “STILL PICTURE” or “VIDEO”). (See page 38.)

For MP3/WMA files

- The system supports MP3/WMA files recorded with a bit rate of 32 – 320 kbps and a sampling frequency of 16 kHz, 22.05 kHz, 24 kHz*, 32 kHz, 44.1 kHz, or 48 kHz.
- If the track information (track title, artist, and album name, etc.) is recorded, it appears in the file control display on the TV screen. (See page 30.)
- We recommend to record each piece of material (song) at a sample rate of 44.1 kHz and at a data transfer rate of 128 (96*) kbps.
* For WMA only

For JPEG files

- We recommend to record a file at 640 x 480 resolution. (If a file has been recorded at a resolution of more than 640 x 480, it will take a longer time to be displayed.)
- This system can only play baseline JPEG files.

For ASF files

- The system supports the types of the advanced simple profile as MPEG-4 files (MPEG-4 ASF).
- The system supports MPEG-4 files with the following conditions:
File format: ASF
Visual profile: MPEG-4 SP (Simple Profile)
Audio CODEC: G.726
Max. picture size: 352 x 288 (CIF)
Max. bit rate: 384 kbps

For MPEG-2/MPEG-1 files

- The stream format should conform to MPEG system/program stream.
- 720 x 576 pixels (25 fps)/720 x 480 pixels (30 fps) is recommended for the highest resolution.
- This system also supports the resolutions of 352 x 576/480 x 576/352 x 288 pixels (25 fps) and 352 x 480/480 x 480/352 x 240 pixels (30 fps).
- The file format should be MP@ML (Main Profile at Main Level)/SP@ML (Simple Profile at Main Level)/MP@LL (Main Profile at Low Level).
- Audio streams should conform to MPEG1 Audio Layer-2 or MPEG2 Audio Layer-2.

For DivX files

- The system supports DivX 6.x, 5.x, 4.x and 3.11.
- The system supports DivX files whose resolution is 720 x 480 pixels or less (30 fps), and 720 x 576 pixels or less (25 fps).
- Audio stream should conform to Dolby Digital (including multi channel) or MPEG1 Audio Layer-3 (MP3).
- The system does not support GMC (Global Motion Compression).
- The file encoded in the interlaced scanning mode may not be played back correctly.
- The system has its own Registration Code for DivX playback.
- If necessary, you can confirm the Registration Code of your system using the OTHERS menu. (See page 39.)

- This product incorporates copyright protection technology that is protected by U.S. patents and other intellectual property rights. Use of this copyright protection technology must be authorized by Macrovision, and is intended for home and other limited viewing uses only unless otherwise authorized by Macrovision. Reverse engineering or disassembly is prohibited.
- “CONSUMERS SHOULD NOTE THAT NOT ALL HIGH DEFINITION TELEVISION SETS ARE FULLY COMPATIBLE WITH THIS PRODUCT AND MAY CAUSE ARTIFACTS TO BE DISPLAYED IN THE PICTURE. IN CASE OF 525 OR 625 PROGRESSIVE SCAN PICTURE PROBLEMS, IT IS RECOMMENDED THAT THE USER SWITCH THE CONNECTION TO THE ‘STANDARD DEFINITION’ OUTPUT.
IF THERE ARE QUESTIONS REGARDING OUR TV SET COMPATIBILITY WITH THIS MODEL 525p AND 625p DVD PLAYER, PLEASE CONTACT OUR CUSTOMER SERVICE CENTER.”

- USE OF THIS PRODUCT IN ANY MANNER THAT COMPLIES WITH THE MPEG-4 VISUAL STANDARD IS PROHIBITED, EXCEPT FOR USE BY A CONSUMER ENGAGING IN PERSONAL AND NON-COMMERCIAL ACTIVITIES.
- DivX, DivX Ultra Certified, and associated logos are trademarks of DivX, Inc. and are used under license.
- Official DivX® Ultra Certified product
- Plays all versions of DivX® video (including DivX® 6) with enhanced playback of DivX® media files and the DivX® Media Format

Description of parts and controls

Front panel (center unit)

The numbers in the figures indicate the pages where the details of the parts are described.

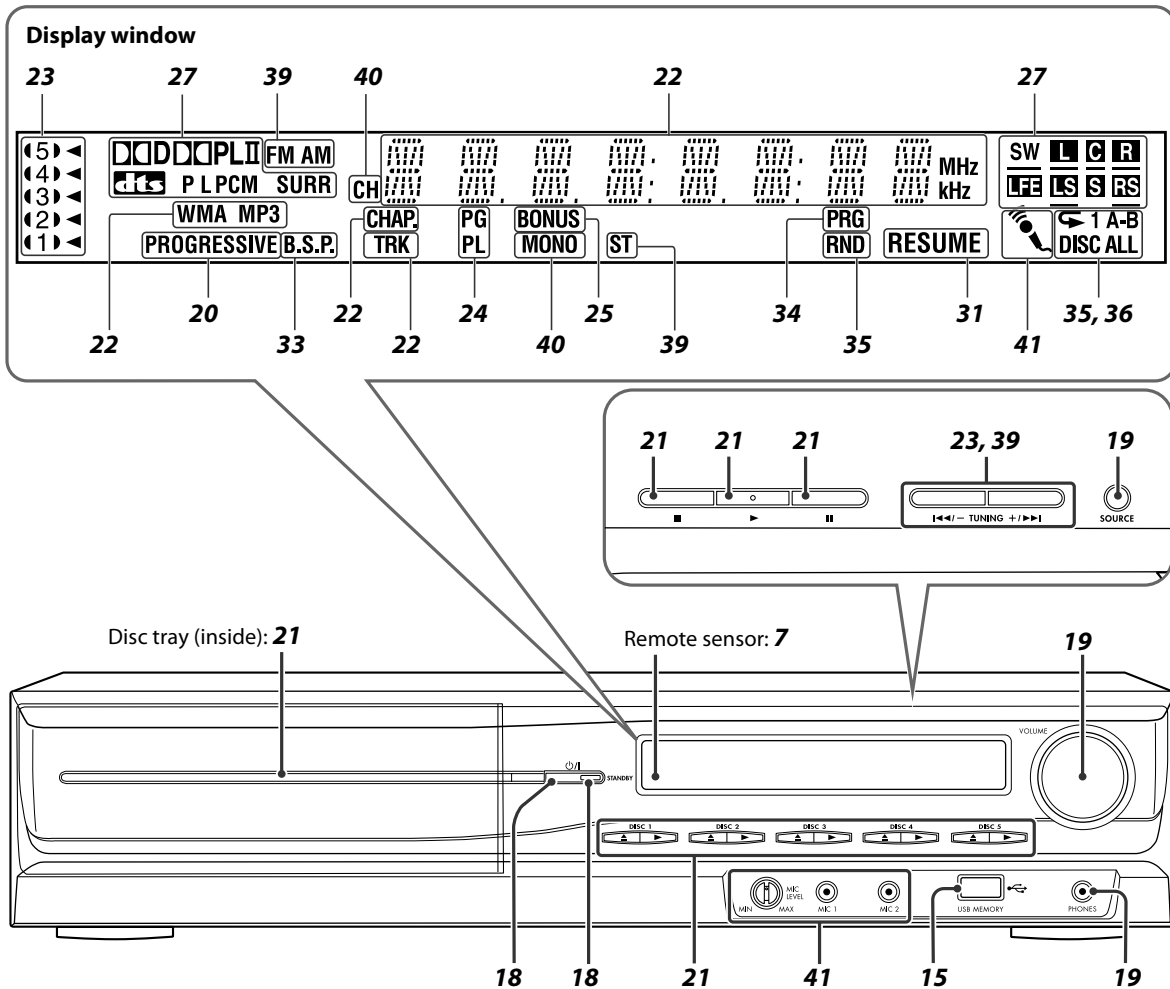

Rear panel (center unit)

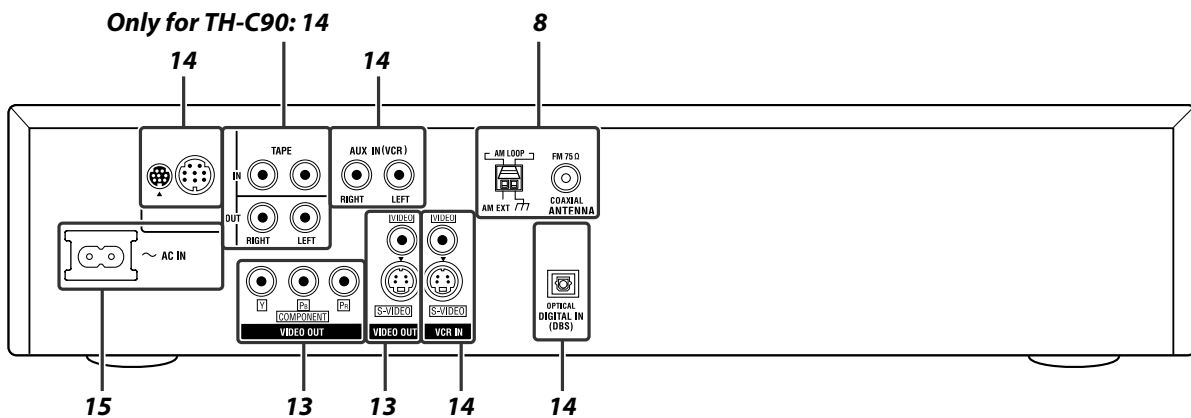

IMPORTANT

Illustrations used in this manual are of TH-C90 unless mentioned otherwise.

Description of parts and controls

Powered subwoofer

Front

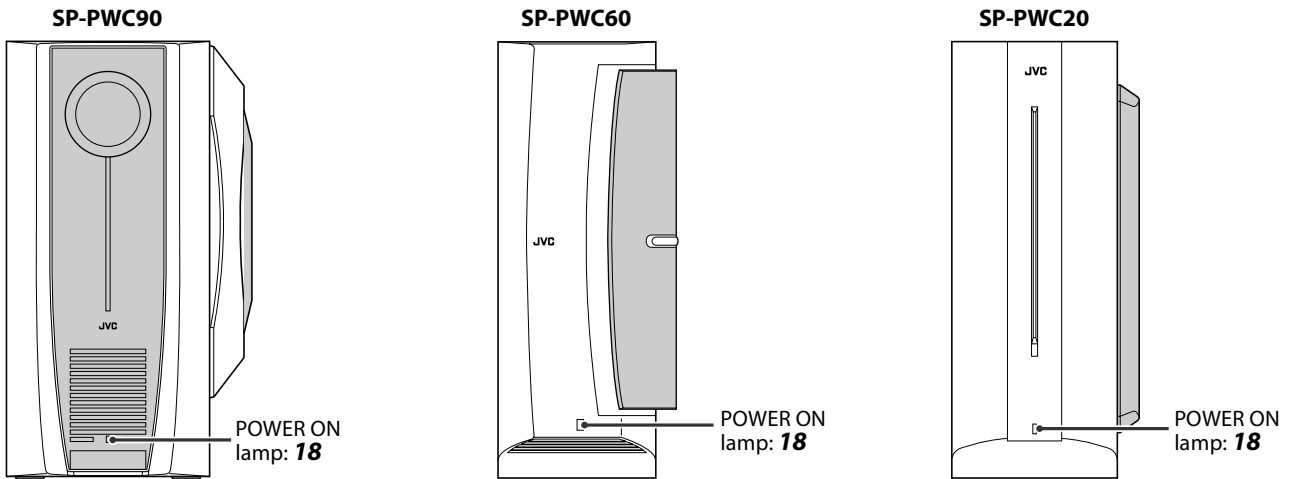

Rear

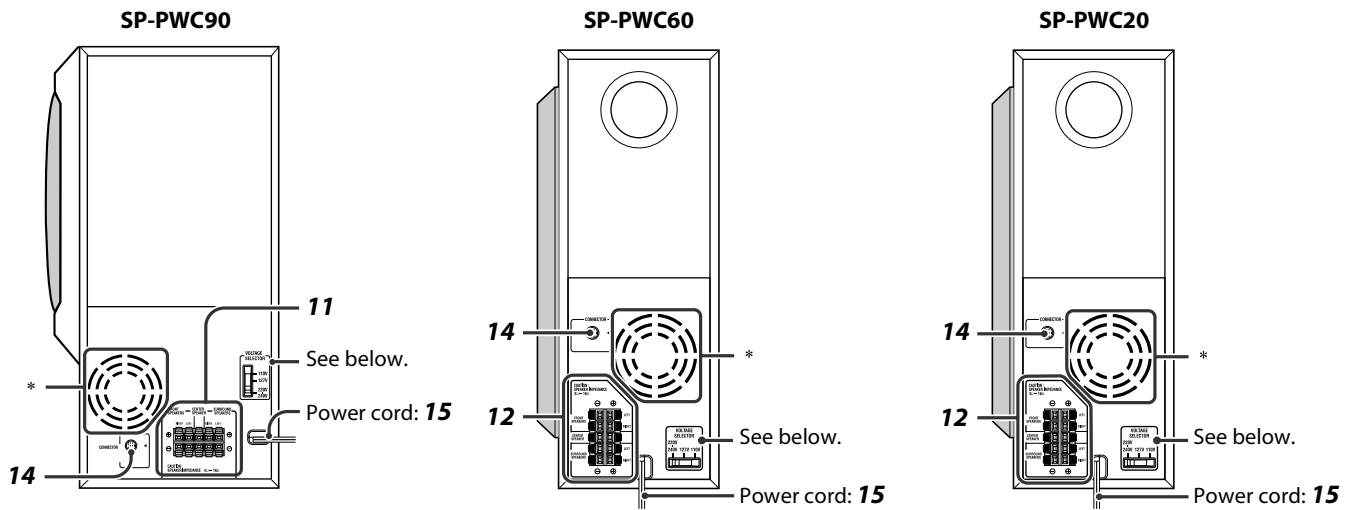

NOTE

- For safety reasons, always ensure that there is sufficient space behind the powered subwoofer.

- * Do not block the ventilation openings to allow proper air circulation by the cooling fan.

Setting the VOLTAGE SELECTOR

Before plugging, set the correct voltage for your area with the voltage selector switch on the rear panel of the powered subwoofer.

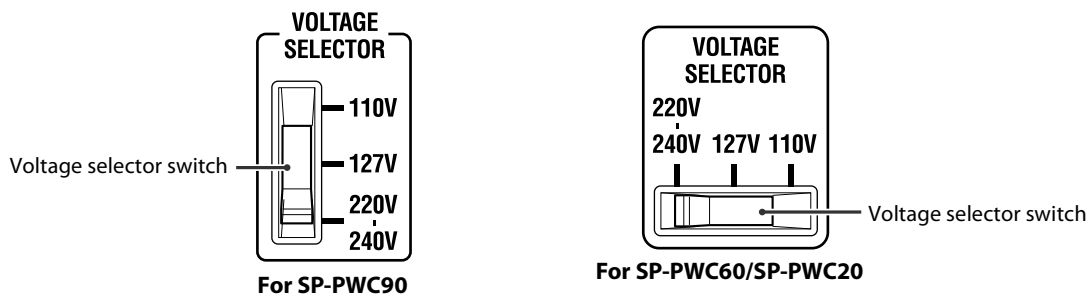

Description of parts and controls

Remote control

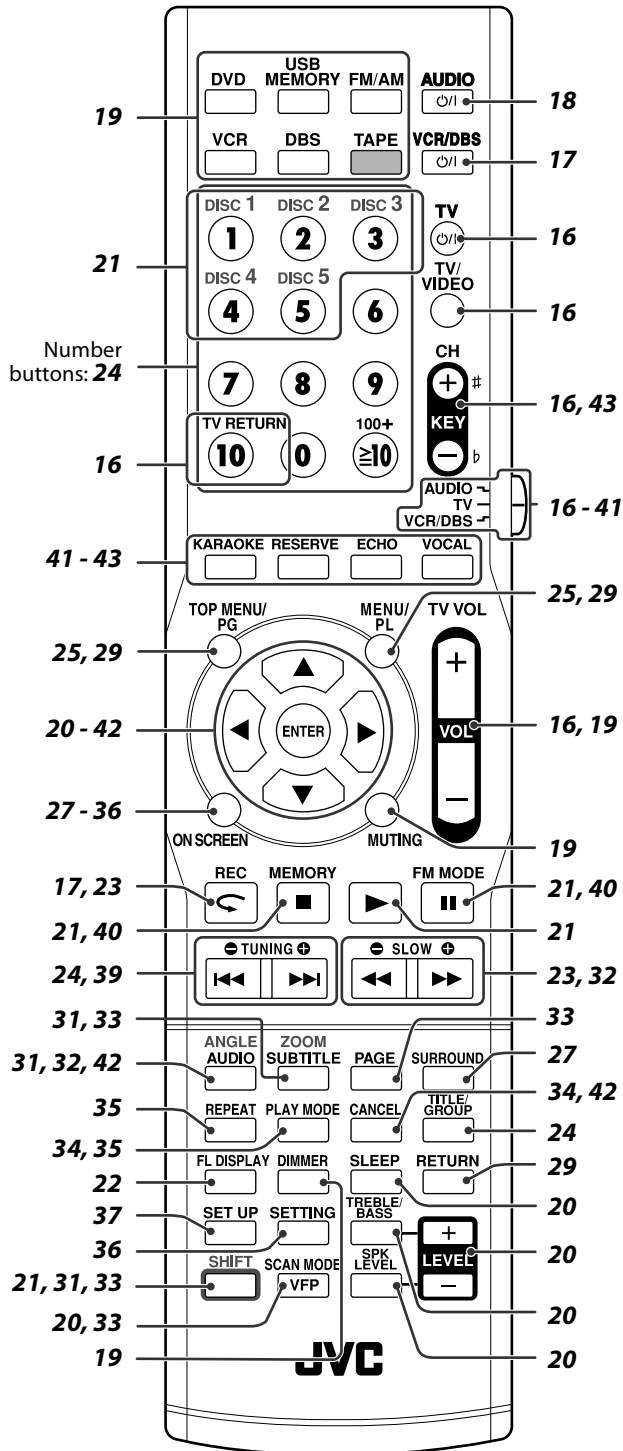

- The button shaded in the illustration (TAPE) is only for TH-C90.

Putting batteries in the remote control

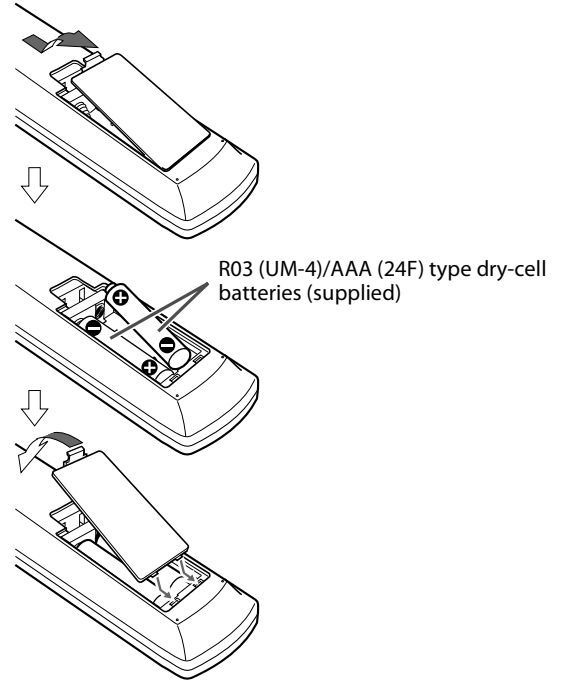

If the range or effectiveness of the remote control decreases, replace both batteries.

CAUTION

- Do not expose batteries to heat or flame.

Operating the system from the remote control

Aim the remote control directly to the front panel of the center unit.

- Do not block the remote sensor.

Connecting the FM and AM antennas

■ AM loop antenna

Setting up supplied AM loop antenna

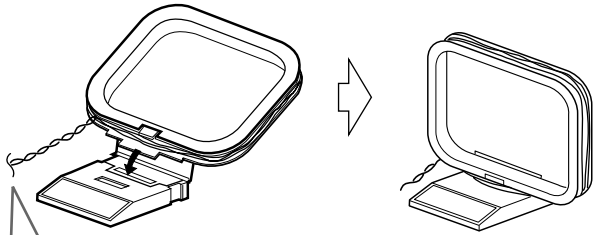

 If the antenna cord is covered with the insulation coat, twist and pull the insulation coat off and remove.

Connecting AM loop antenna

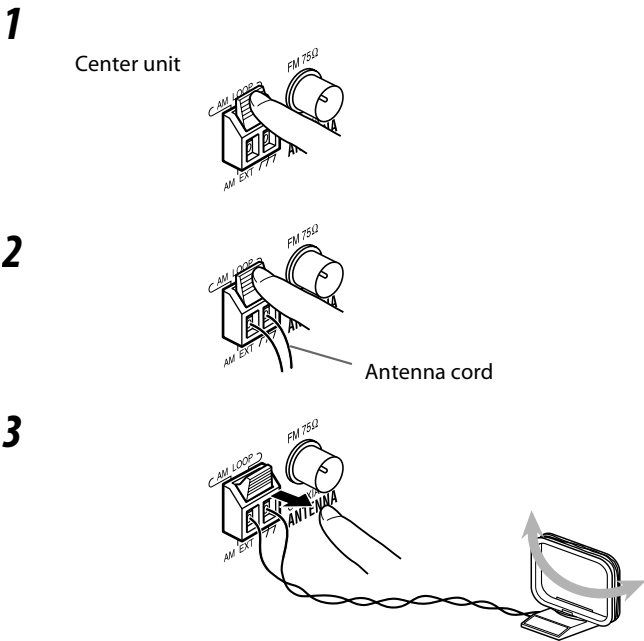

- Turn the loop antenna until you have the best reception during AM broadcast program reception.

NOTE

- Make sure the antenna conductors do not touch any other terminals, connecting cords or power cords. This could cause poor reception.

If reception is poor

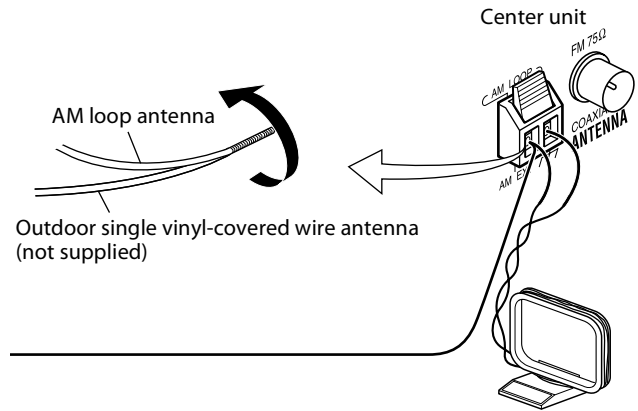

■ FM antenna

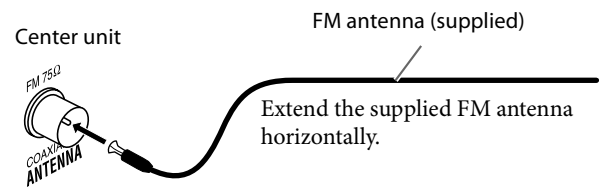

If reception is poor

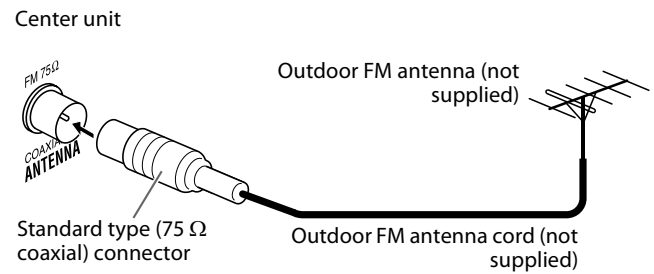

NOTE

- We recommend that you use coaxial cable for the FM antenna as it is well-shielded against interference.

Connecting the satellite (front, center, surround) speakers

Assembling the front speakers — TH-C90



Front speaker (SP-THC90F) (2)



Base plate (2)

Before assembling —

- Prepare a Phillips screwdriver (not supplied). Take care not to drop any component part while assembling; otherwise, it may cause damage to the floor or injury.

1

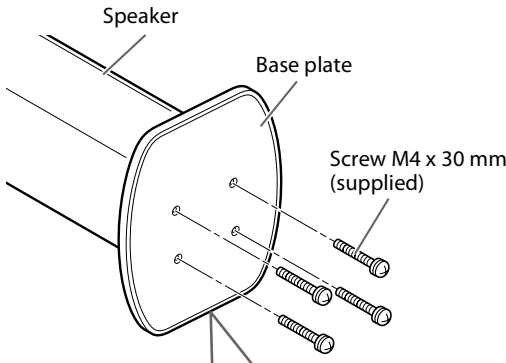

Direction of the base plate:

Make the short side front when fixing the base plate.

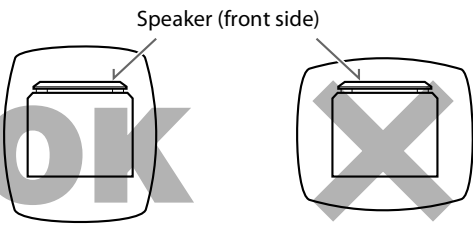

CAUTION

- NEVER insert your finger in between the speaker and the base plate, as it may get hurt.

2

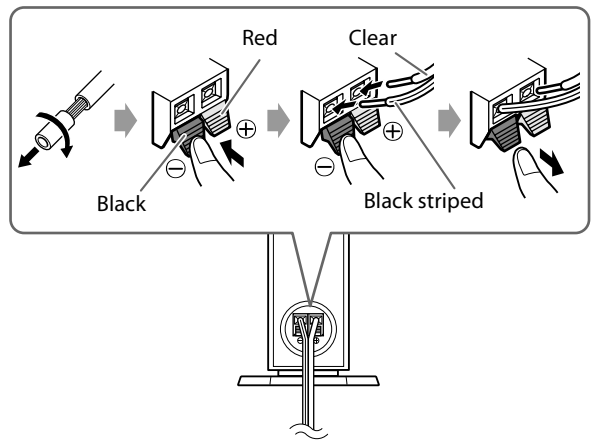

Connecting the center and surround speakers — TH-C90



Center speaker (SP-THC90C) (1)



Surround speaker (SP-THC90S) (2)

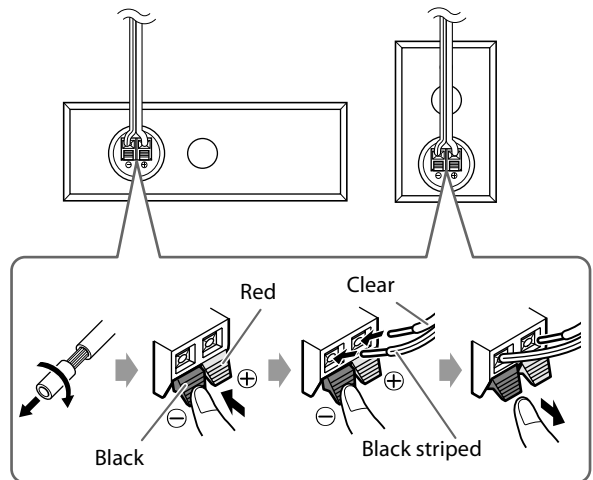

To remove the speaker grilles:

The speaker grilles of the satellite speakers are removable. The following procedure explains the removal of SP-THC90S's speaker grille. You can remove speaker grilles of other speakers by the same procedure.

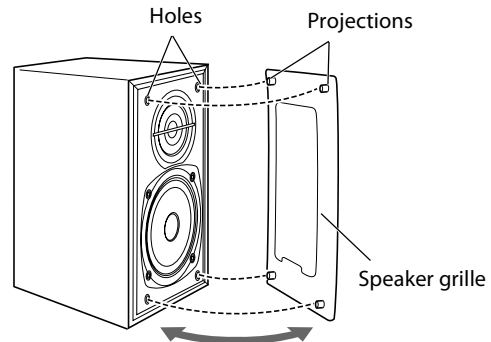

■ **Assembling the front and surround speakers — TH-C60**

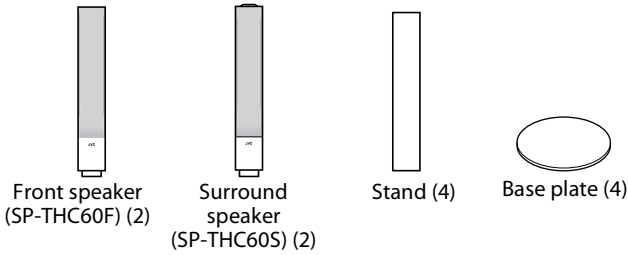

- Check the model name of each speaker from the label on the rear to locate each speaker correctly.

Assembled speakers

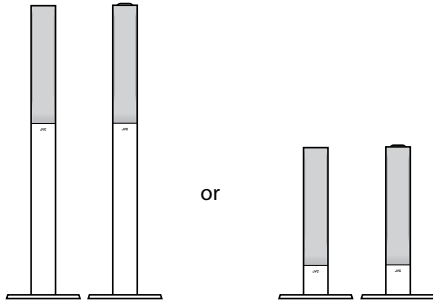

With stand: Refer to steps 1 to 3. Without stand: Refer to steps 2 and 3.

Before assembling —

- Prepare a Phillips screwdriver (not supplied).
- Take care not to drop any component part while assembling; otherwise, it may cause damage to the floor or injury.

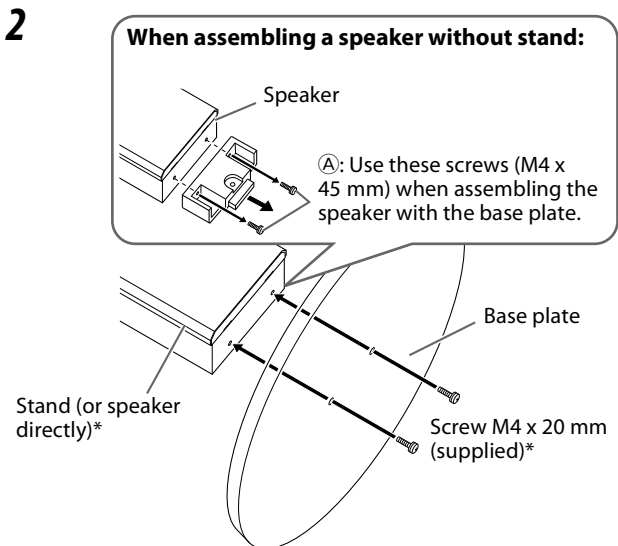
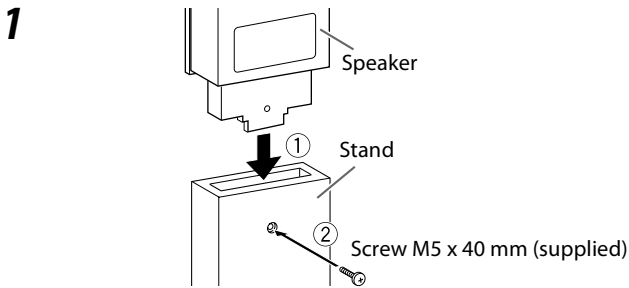

* When assembling the speaker with the base plate, use the screws (A).

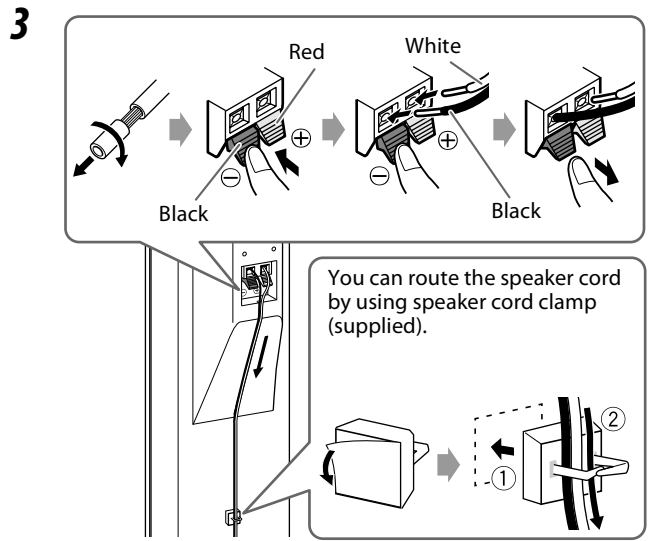

■ **Connecting the center speaker — TH-C60**



Center speaker (SP-THC60C) (1)

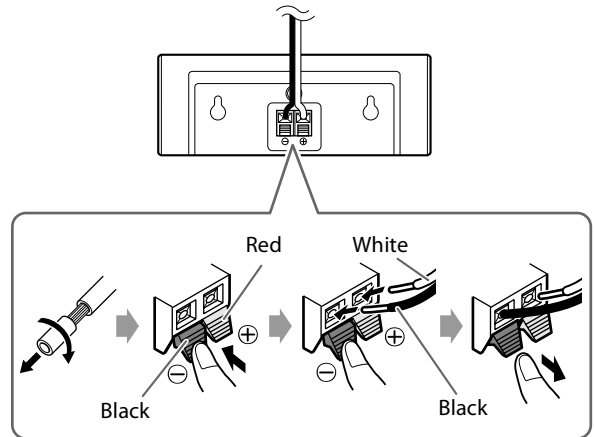

For TH-C20, the front, surround and center speakers are equipped with their speaker cords attached directly to their speaker unit instead of having speaker terminals on their cabinet.

■ Connecting the satellite speakers to the subwoofer — **TH-C90**

Before connecting the speaker cords;
Twist and pull the insulation coat off and remove.

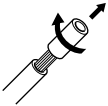

- Connect the black striped cords to the black (⊖) terminals.
- Connect the clear cords to the (⊕) terminals referring to the table below:

FRONT SPEAKERS (LEFT)	White
FRONT SPEAKERS (RIGHT)	Red
CENTER SPEAKER	Green
SURROUND SPEAKERS (LEFT)	Blue
SURROUND SPEAKERS (RIGHT)	Gray

Powered subwoofer
SP-PWC90

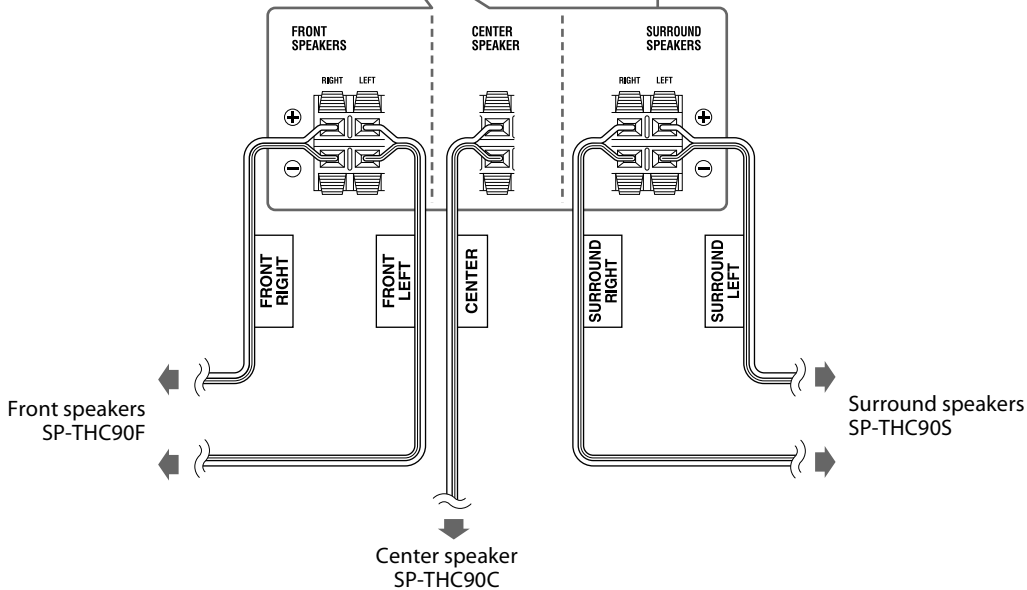
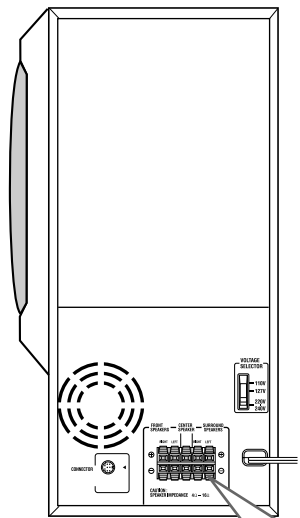

CAUTION

- If you connect speakers other than the supplied ones, use speakers of the same speaker impedance (SPEAKER IMPEDANCE) indicated near the speaker terminals on the rear of the powered subwoofer.
- DO NOT connect more than one speaker to one speaker terminal.
- When installing the surround speakers on the wall;
 - Be sure to have them installed on the wall by qualified personnel.
 - DO NOT install the satellite speakers on the wall by yourself to avoid unexpected damage from falling off the wall due to incorrect installation or weakness in wall structure.
 - Care must be taken in selecting a location for speaker installation on a wall. Injury to personnel or damage to equipment may result if the speakers installed interfere with daily activities.

Precautions for daily use

- When moving the speakers, do not pull the speaker cords; otherwise, the speakers may fall over, causing damage or injury.
- Do not reproduce sounds at so high a volume that the sound is distorted; otherwise, the speakers may be damaged by internal heat buildup.
- When holding a speaker, always grasp the lower portion.
- Do not lean against the speakers, as the speakers could fall down or break, possibly causing an injury. Especially be careful that children do not lean against them.

■ Connecting the satellite speakers to the subwoofer — TH-C60/TH-C20

Note that the illustration below is for SP-PWC60.

Before connecting the speaker cords;
Twist and pull the insulation coat off and remove.

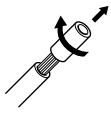
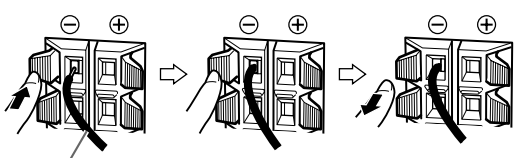
Speaker cord

- Connect the black cords to the black (⊖) terminals.
- Connect the white cords to the (⊕) terminals referring to the table below:

FRONT SPEAKERS (LEFT)	White
FRONT SPEAKERS (RIGHT)	Red
CENTER SPEAKER	Green
SURROUND SPEAKERS (LEFT)	Blue
SURROUND SPEAKERS (RIGHT)	Gray

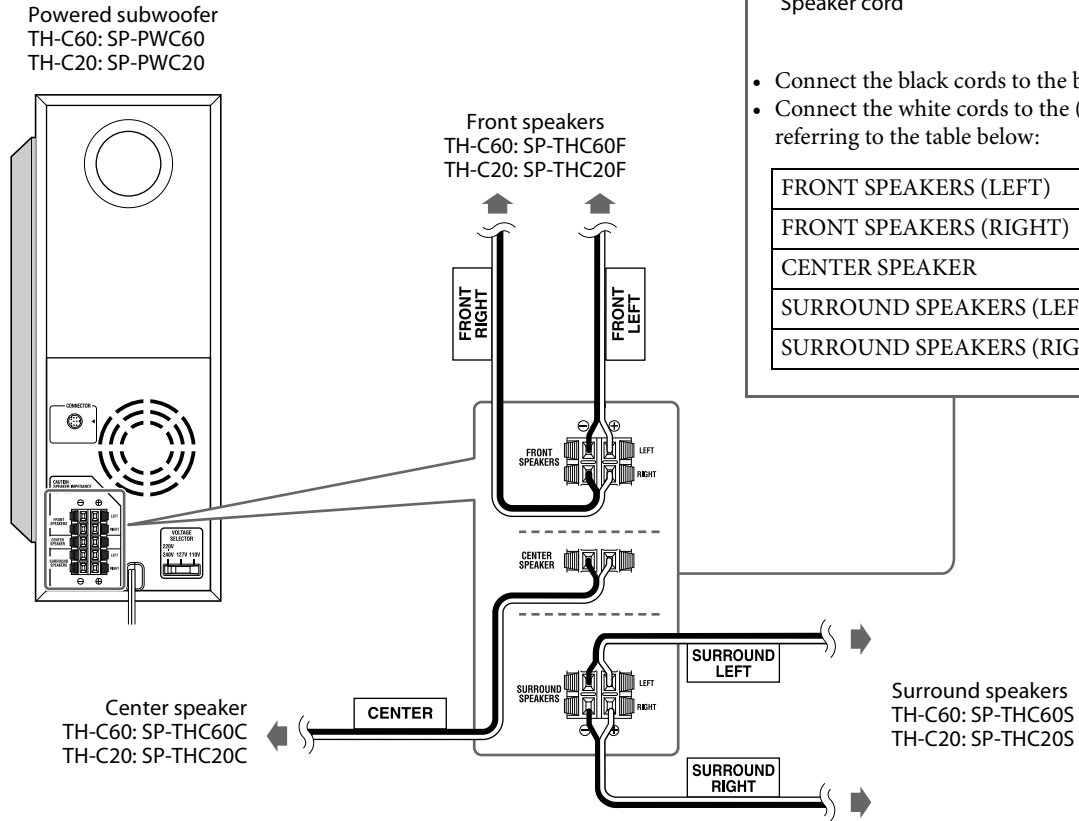

CAUTION

- If you connect speakers other than the supplied ones, use speakers of the same speaker impedance (SPEAKER IMPEDANCE) indicated near the speaker terminals on the rear of the powered subwoofer.
- DO NOT connect more than one speaker to one speaker terminal.
- When installing the satellite speakers on the wall;
 - Be sure to have them installed on the wall by qualified personnel. DO NOT install the satellite speakers on the wall by yourself to avoid unexpected damage from falling off the wall due to incorrect installation or weakness in wall structure.
 - Care must be taken in selecting a location for speaker installation on a wall. Injury to personnel or damage to equipment may result if the speakers installed interfere with daily activities.

Precautions for daily use

- When moving the speakers, do not pull the speaker cords; otherwise, the speakers may fall over, causing damage or injury.
- Do not reproduce sounds at so high a volume that the sound is distorted; otherwise, the speakers may be damaged by internal heat buildup.

For TH-C60:

- When holding a speaker, always grasp the lower portion.
- Do not lean against the speakers, as the speakers could fall down or break, possibly causing an injury. Especially be careful that children do not lean against them.

Speaker layout

To obtain the best possible sound from this system, you need to place all the speakers except the subwoofer at the same distance from the listening position.

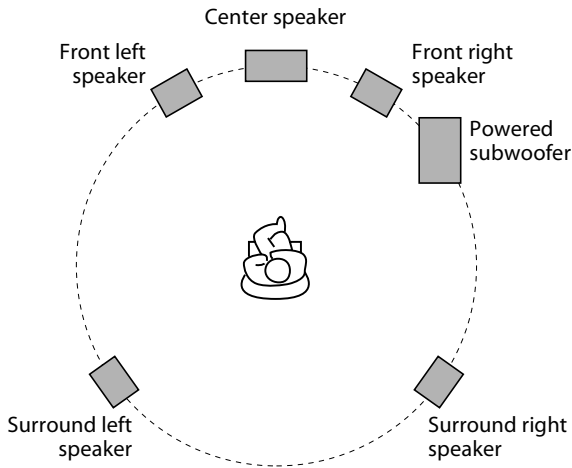

If your speakers cannot be placed at the same distance from the listening position

You can adjust the delay time of the speakers. See “Delay menu (DELAY)” on page 38.

NOTE

- Place the satellite speakers on a flat and level surface.
- The front and center speakers are magnetically shielded to avoid color distortions on TVs. However, if not installed properly, they may cause color distortions. So, pay attention to the following when installing the speakers.
 - When placing the speakers near a TV set, turn off the TV’s main power switch or unplug it before installing the speakers. Then wait at least 30 minutes before turning on the TV’s main power switch again.
- Some TVs may still be affected even though you have followed the above. If this happens, move the speakers away from the TV.
- The surround speakers are not magnetically shielded. If they are located nearby the TV or monitor, it will probably cause color distortion on the screen. To avoid this, do not place the speakers nearby the TV or monitor.
- Be sure to place the powered subwoofer to the TV’s right. If you place the powered subwoofer to the TV’s left, keep sufficient distance between them to prevent the TV screen from appearing mottled.

Connecting a TV

- You can get better picture quality in the order — Component video > S-video > Composite video.
- Distortion of picture may occur when connecting to the TV via a VCR, or to a TV with a built-in VCR.
- You need to set “MONITOR TYPE” in the PICTURE menu correctly according to the aspect ratio of your TV. (See page 38.)

■ To connect a TV equipped with the component video input jacks

If your TV supports progressive video input, you can enjoy a high quality picture by setting the progressive scan mode to active. (See page 20.)

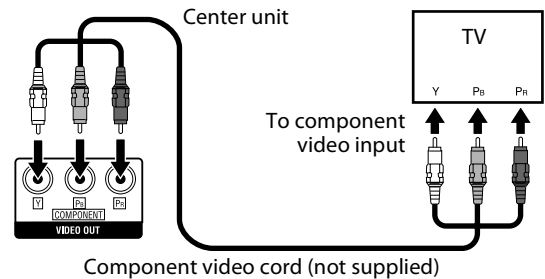

NOTE

- If the component video input jacks of your TV are of the BNC type, use a plug adapter (not supplied) to convert the pin plugs to BNC plugs.
- The component video signals can be output only when you select DVD or USB MEMORY as the source to play. (See page 19.)

■ To connect a TV equipped with the composite or S-video jacks

Center unit

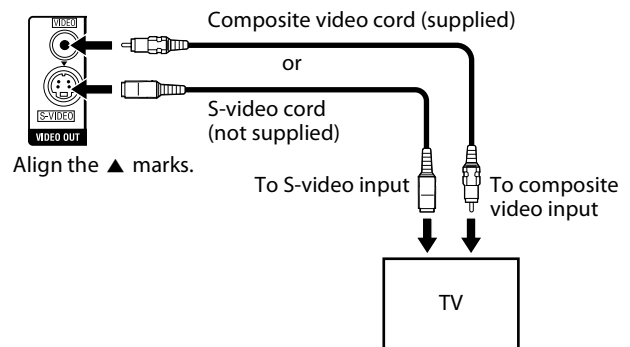

NOTE

- Select the appropriate scan mode according to your TV. (See page 20.)

Connecting the powered subwoofer

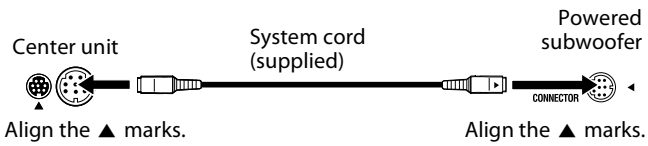

Connecting to an analog component

You can enjoy the sound of an analog component.

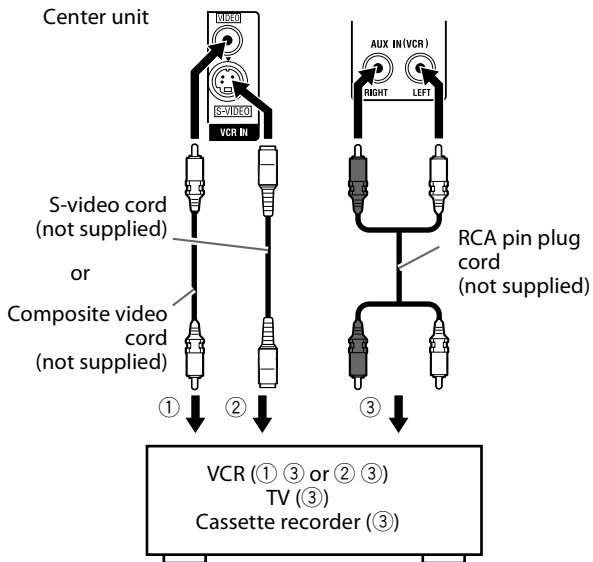

- ① To composite video output
- ② To S-video output
- ③ To audio output

NOTE

- The signals input to the VIDEO jack of the VCR IN jacks will be output only from the VIDEO jack of the VIDEO OUT jacks, not from the S-VIDEO jack of the VIDEO OUT jacks.

Connecting a cassette recorder (Only for TH-C90)

You can enjoy playing tape and also recording tracks/files from this system.

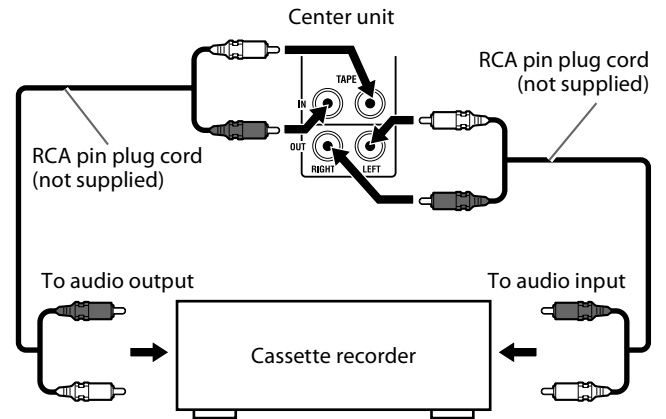

NOTE

- The surround mode takes effect for the signals output from the TAPE OUT jacks. When recording to a tape, set the surround mode to "OFF". (See page 26.)

Connecting to a digital component

You can enjoy the sound of a digital component.

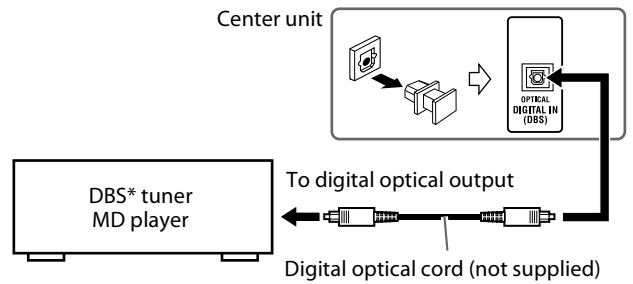

* DBS = Direct Broadcasting Satellite

NOTE

- Only digital audio signals can be input when selecting "DBS" as the source to play. (See page 19.) When connecting a video component such as a DBS tuner, operate this system to listen to the sound.

Connecting a USB mass storage class device

You can connect a USB mass storage class device such as a USB flash memory device, hard disc drive, multimedia card reader, digital camera, etc. to this system.

- After connecting a USB mass storage class device to this system and selecting USB MEMORY as the source, the file control display appears on the TV screen. (See page 30.)

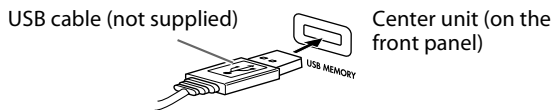

NOTE

- When connecting a USB mass storage class device, refer also to its manual.
- Connect one USB mass storage class device to the system at a time. Do not use a USB hub.
- You cannot charge the USB mass storage class device while connecting it to the USB MEMORY jack.
- While playing back a file in a USB mass storage class device, do not disconnect the device. It may cause a malfunction of both the system and the device.
- JVC bears no responsibility for any loss of data in the USB mass storage class device while using this system.
- When connecting with a USB cable, use a cable less than 1 m in length.
- This system is compatible with the USB 2.0 Full-Speed (not compatible with the USB 1.1).
- You can play back the following types of files in a USB mass storage class device (maximum data transfer rate: 2 Mbps):
 - Music: MP3, WMA
 - Picture: JPEG
 - Movie: MPEG-4 (ASF), DivX (maximum frame rate of 30 fps for progressive)
- You cannot play back a file larger than 2 GB.
- When playing a file which has a large transfer rate, frames or sounds may be dropped during playback.
- This system cannot recognize a USB mass storage class device whose rating exceeds 5 V/500 mA.
- This system may not recognize some USB mass storage class devices.
- This system may not play back some files even though their formats are listed above.

Connecting the power cord

Make sure that all other connections have been completed.

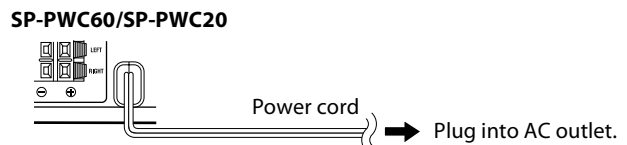
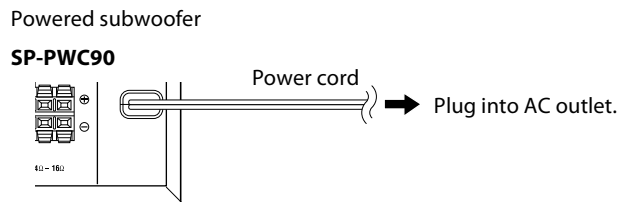
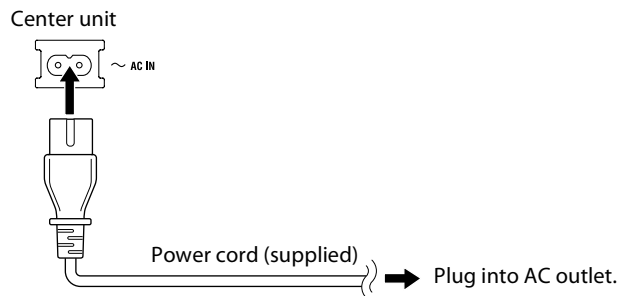

CAUTION

- Disconnect the power cord before cleaning or moving the system.
- Do not pull on the power cord to unplug the cord. When unplugging the cord, always grasp and pull the plug so as not to damage the cord.
- If the AC outlets do not match the AC plugs, use the supplied AC plug adapter (except for the countries of the Middle East).

Operating external components with the remote control

The buttons described below are used on pages 16 and 17.

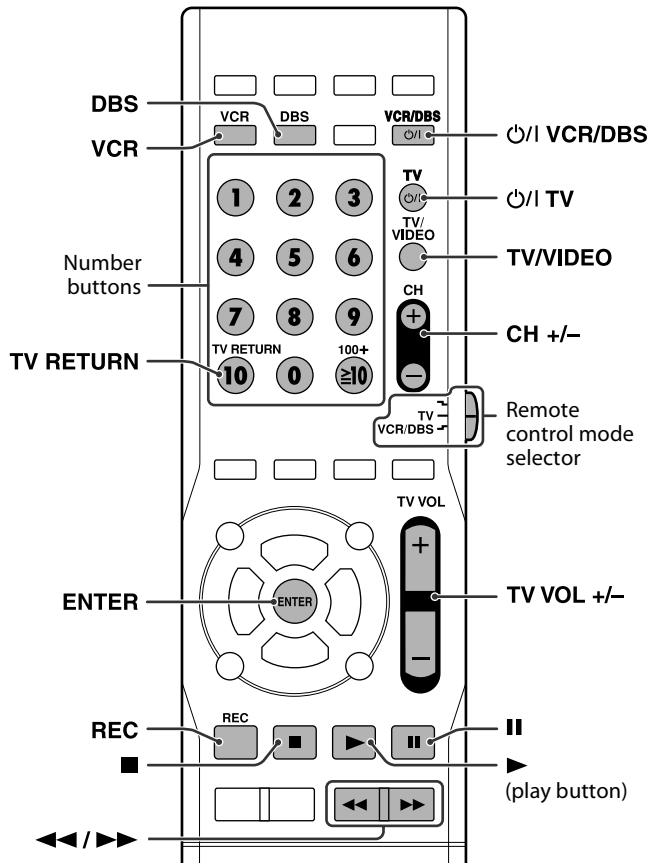

NOTE

- Manufacturers' codes are subject to change without notice.
- Set the codes again after replacing the batteries of the remote control.

Operating the TV

To set the manufacturer's code

- Slide the remote control mode selector to TV.
- Press and hold **TV**.
Keep the button pressed until step 4 is finished.
- Press **ENTER**.
- Press number buttons (1-9, 0) to enter the manufacturer's code (2 digits).

Examples:

For a Hitachi TV: Press 1, then 0.

For a Toshiba TV: Press 0, then 8.

Manufacturer	Code	Manufacturer	Code
JVC	01*	Samsung	12
Hitachi	10	Sanyo	13, 14
Magnavox	02	Sharp	06
Mitsubishi	03	Sony	07
Panasonic	04, 11	Toshiba	08
Philips	15	Zenith	09
RCA	05		

* "01" is the initial setting.

- Release **TV**.

If there is more than one code listed for corresponding brand, try each one until you enter the correct one.

Operation

Aim the remote control at the TV.

IMPORTANT

Before using the remote control to operate a TV;

- Set the remote control mode selector to TV.

The following buttons are available:

- TV**: Turns TV on and off.
- TV VOL +/-**: Adjusts the volume.
- TV/VIDEO**: Selects the input mode (either TV or VIDEO).
- CH +/-**: Changes the channels.
- 1-10, 0, >=10 (100+)**: Selects the channel.
- TV RETURN**: Alternates between the previously selected channel and the current channel.

NOTE

- The operating buttons may differ depending on manufacturers.

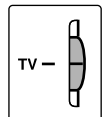

Operating the DBS tuner or CATV converter

■ To set the manufacturer's code

- 1 Slide the remote control mode selector to VCR/DBS.
- 2 Press DBS.
- 3 Press and hold VCR/DBS.
Keep the button pressed until step 5 is finished.
- 4 Press ENTER.
- 5 Press number buttons (1-9, 0) to enter the manufacturer's code (2 digits).

Examples:

For a GI Jerrold product: Press 0, then 1.

For a Sony product: Press 2, then 0.

Manufacturer	Code
Echostar	21
GI Jerrold	01*, 02, 03, 04, 05, 06, 07, 08
Hamlin	15, 16, 17, 18
Pioneer	13, 14
RCA	19
Scientific Atlanta	09, 10
Sony	20
Zenith	11, 12

* "01" is the initial setting.

6 Release VCR/DBS.

If there is more than one code listed for your brand, try each one until you enter the correct one.

■ Operation

Aim the remote control at the DBS tuner or CATV converter.

IMPORTANT

Before using the remote control to operate a DBS tuner or CATV converter;

- 1 Set the remote control mode selector to VCR/DBS.
- 2 Press DBS.

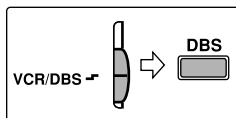

The following buttons are available:

VCR/DBS: Turns DBS tuner or CATV converter on and off.

CH +/-: Changes the channels.

1-10, 0, ≥ 10 (100+): Selects the channel.

Operating the VCR

■ To set the manufacturer's code

- 1 Slide the remote control mode selector to VCR/DBS.
- 2 Press VCR.
- 3 Press and hold VCR/DBS.
Keep the button pressed until step 5 is finished.
- 4 Press ENTER.
- 5 Press number buttons (1-9, 0) to enter the manufacturer's code (2 digits).

Examples:

For a Philips VCR: Press 0, then 9.

For an NEC VCR: Press 2, then 5.

Manufacturer	Code	Manufacturer	Code
JVC	01*, 02, 03	Philips	09
Emerson	11, 26	RCA	05, 06
Fisher	29	Samsung	24
Funai	10, 14, 15, 16	Sanyo	21, 22, 23
Gold Star	12	Sharp	27, 28
Hitachi	04	Shintom	30
Mitsubishi	13	Sony	18, 19, 20
NEC	25	Zenith	08
Panasonic	07, 17		

* "01" is the initial setting.

6 Release VCR/DBS.

If there is more than one code listed for your brand, try each one until you enter the correct one.

■ Operation

Aim the remote control at the VCR.

IMPORTANT

Before using the remote control to operate a VCR;

- 1 Set the remote control mode selector to VCR/DBS.
- 2 Press VCR.

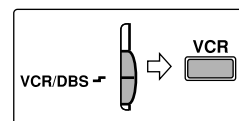

The following buttons are available:

VCR/DBS: Turns VCR on and off.

(play button): Starts playback.

■: Stops operation.

||: Pauses playback.

: Fast forwards video tape.

: Rewinds video tape.

REC: Press this button together with (play button) to start recording or together with || to pause recording.

CH +/-: Changes the TV channels on the VCR.

NOTE

- When operating a VCR or DBS tuner/CATV converter;
 - The source setting of VCR or DBS remains after you have changed the remote control mode selector to AUDIO or TV. When operating VCR or DBS tuner/CATV converter again, it is not necessary to press VCR or DBS after setting the remote control mode selector.

Basic operations

The buttons on the remote control are used to explain most of the operations in this manual. You can use the buttons on the center unit same as on the remote control for operations unless otherwise noted.

IMPORTANT

Before using the remote control for the following operation;

- Set the remote control mode selector to AUDIO.

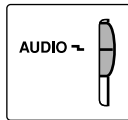

The buttons described below are used on pages 18 to 20.

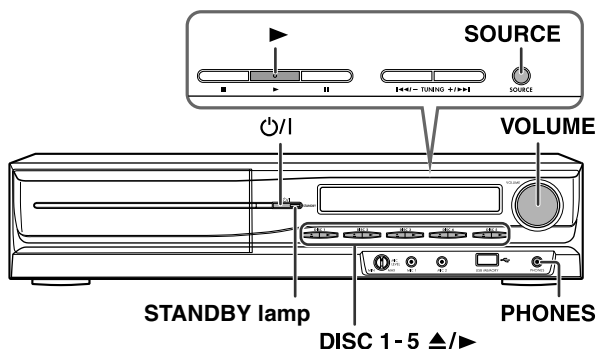
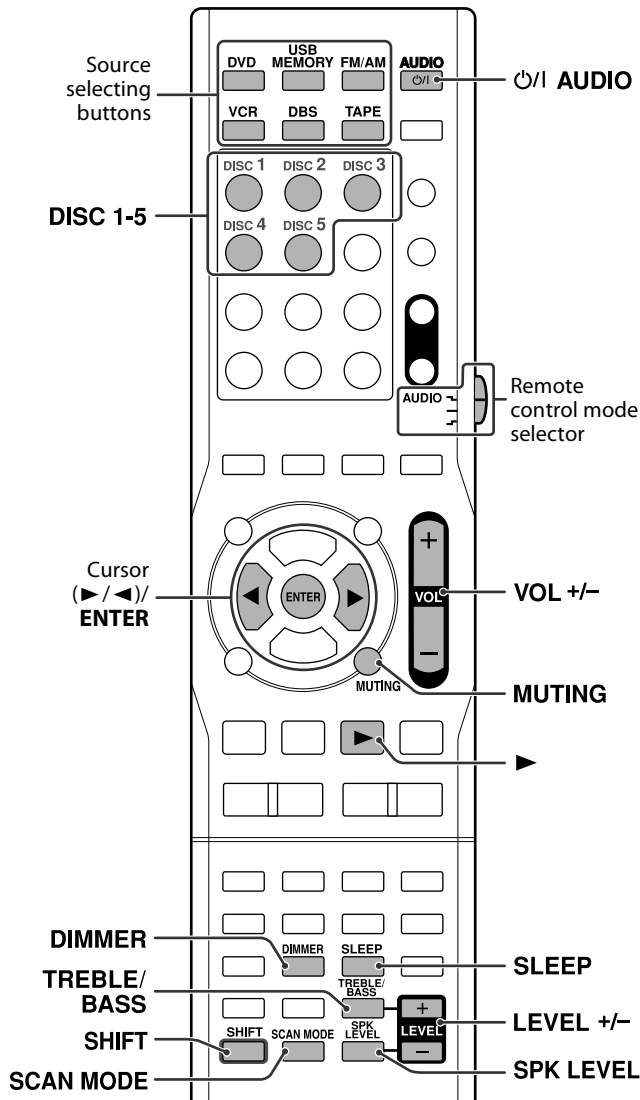

Turning the system on/off

On the remote control:

Press **⏻/⏪ AUDIO**.

On the center unit:

Press **⏻/⏪**.

When DVD or USB MEMORY is selected as the source (see page 19), the following messages will appear on the TV screen.

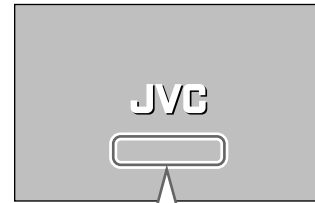

- “OPEN”/“CLOSE”: Appears when opening or closing the disc tray.
- “NOW READING”: Appears when the system is reading the disc/file information.
- “REGION CODE ERROR!”: Appears when the Region Code of the DVD VIDEO does not match the code the system supports. The disc cannot be played back.
- “NO DISC”: Appears when no disc is loaded.
- “NO USB DEVICE”: Appears when no USB mass storage class device is connected.
- “CANNOT PLAY THIS DISC”: Appears when unplayable disc is loaded.
- “CANNOT PLAY THIS DEVICE”: Appears when unplayable USB mass storage class device is connected.

NOTE

- The STANDBY lamp on the center unit lights red when the power is turned off. The lamp goes off when the power is turned on.
- The power supply to the subwoofer is linked to the center unit. The POWER ON lamp on the subwoofer lights green when the power is turned on.
- A small amount of power is consumed even when the power is turned off (center unit only). This is called standby mode and the STANDBY lamp lights in this mode. Unplug the power cord from the AC outlet to turn the power off completely.
- You can also turn on the system by pressing the following buttons:
 - One of the DISC (1-5) buttons (with SHIFT pressed) on the remote control
 - One of the DISC (1-5) ▲ buttons on the center unit
 - One of the source selecting buttons or ► on the remote control
 - One of the DISC (1-5) ► buttons or ► on the center unit

Selecting the source to play

On the remote control:

Press one of the source selecting buttons (DVD, USB MEMORY, FM/AM, VCR, DBS or TAPE*).

DVD:

To play back a disc (DVD VIDEO, VCD etc.). (See page 21.)

USB MEMORY:

To play back a file in a USB mass storage class device. (See "To play a file in a USB mass storage class device" on page 21.)

FM/AM:

To tune in an FM or AM station. (See page 39.) Each time you press the button, the band alternates between FM and AM.

VCR:

To select the source from a component connected to the VCR IN jacks and AUX IN (VCR) jacks. (See page 14.)

DBS:

To select the source from a component connected to the DIGITAL IN (DBS) jack. (See page 14.)

TAPE*:

To select the source from a component connected to the TAPE IN jacks. (See page 14.)

On the center unit:

Press SOURCE repeatedly until the source name you want appears on the display window.

NOTE

- When AM, FM, DBS or TAPE* is selected, this system does not output video signals.
- It may take time to change the source.

* Only for TH-C90

Adjusting the volume [VOLUME]

CAUTION

- Always set the volume to minimum level before starting any source. If the volume is set at a high level, the sudden blast of sound could permanently damage your hearing and/or blow out the speakers.

On the remote control:

Press VOL +/-.

On the center unit:

Turn VOLUME.

- To increase the volume, turn VOLUME clockwise.
- To decrease the volume, turn VOLUME counterclockwise.

Listening with headphones (not supplied)

CAUTION

Be sure to turn down the volume;

- Before connecting or putting on headphones as high volume may damage both the headphones and your hearing.
- Before disconnecting headphones as high volume may be suddenly output from the speakers.

While connecting a pair of headphones to the PHONES jack on the center unit, the system automatically cancels the surround mode (see page 26) currently selected, deactivates the speakers, turns the subwoofer's power off, and activates the headphone mode. "H. PHONE" appears on the display window.

Headphone mode

When using the headphones, the following signals are output regardless of your speaker setting;

- For 2 channel sources, the front left and right channel signals are output from the headphones.
- Multi-channel signals are down-mixed and output from the headphones.
- (For DVD AUDIO) When the disc prohibits down-mixing, only the front left and right channels are output from the headphones.

Turning off the sound temporarily [MUTING]

Press MUTING.

To restore the sound

Perform one of the following:

- Press MUTING again.
- Press VOL +/- (or turn VOLUME on the center unit).

Adjusting the brightness of the indications [DIMMER]

Press DIMMER.

Each time you press the button, you can change the brightness level in 3 steps.

Sleep Timer [SLEEP]

The system turns off automatically when the specified period of time has passed.

Press SLEEP.

Each time you press the button, the shut-off time changes as follows:

– (off) → 10 → 20 → 30 → 60 → 90 → 120 → 150 →
(back to the beginning) (Unit: min.)

Example:



To check the remaining time

Press SLEEP once.

To change the remaining time

Press SLEEP repeatedly.

To cancel

Press SLEEP repeatedly until "SLEEP –" appears.

- Turning off the power also cancels the Sleep Timer.

Adjusting the output level of the subwoofer and speakers

1 Press SPK LEVEL to show the target speaker indication on the display window.

Each time you press the button, the indication of the speakers changes as follows:

FRNT L (Front Left speaker) → FRNT R (Front Right speaker) → CENTER (Center speaker) → SURR L (Surround Left speaker) → SURR R (Surround Right speaker) → SUBWFR (Subwoofer) → (back to the beginning)

2 Press LEVEL +/- to adjust the output level from –6 to +6.

NOTE

- You can also make adjustments by using the setup menu shown on the TV screen. (See page 38.)
- The adjustments take effect for all sources other than FM/AM. For FM/AM, adjust the level separately by repeating the procedure above.

Adjusting the sound

1 Press TREBLE/BASS to show "TRE" or "BASS" on the display window.

Each time you press the button, the indication alternates between "TRE" and "BASS".

- TRE: Select this to adjust treble sound.
- BASS: Select this to adjust bass sound.

2 Press LEVEL +/- to adjust the level from –10 to +10 (in 2 steps).

NOTE

- The adjustments take effect for all sources.

Changing the scan mode

The system can be accommodated to your TV's scan mode.

NOTE

- To use the system in the progressive mode, it is required that the center unit is connected to the TV by using a component video cord (not supplied). (See page 13.)

- While DVD or USB MEMORY is selected as the source and stopped

1 Press and hold SCAN MODE for 2 seconds.

Currently selected scan mode appears on the display window.

2 Press Cursor ► / ◀ to select the desired mode.

- NT. 480I: Select when your TV supports the NTSC interlaced video input only.
- NT. 480P: Select when your TV equipped with component jacks supports the NTSC progressive video input.
- PAL. 576I: Select when your TV supports the PAL interlaced video input only.
- PAL. 576P: Select when your TV equipped with component jacks supports the PAL progressive video input.

You can get better picture quality in the progressive mode ("NT. 480P" or "PAL. 576P") than in the interlace mode ("NT. 480I" or "PAL. 576I").

3 Press ENTER while the selected mode is displayed.

When the progressive mode is selected, the PROGRESSIVE indicator lights on the display window.

NOTE

- Changing the scan mode does not take effect when connecting the TV with the S-video or the composite video cord.
- Although the picture may be distorted when you press ENTER, this is not a malfunction of the system.

- There are some progressive TVs and High-Definition TVs that are not fully compatible with this system, resulting in an unnatural picture when playing back a DVD VIDEO in the progressive scan mode. In such a case, change the scan mode to the interlace mode.
- All JVC progressive TVs and High-Definition TVs are fully compatible with this system.

Playback

- The icon such as  shows the disc formats or file types the operation is available for.

IMPORTANT

Before using the remote control for the following operation;

- 1 Set the remote control mode selector to AUDIO.
- 2 Press DVD or USB MEMORY.

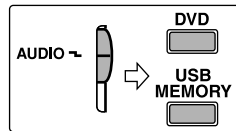

The buttons described below are used on pages 21 to 25.

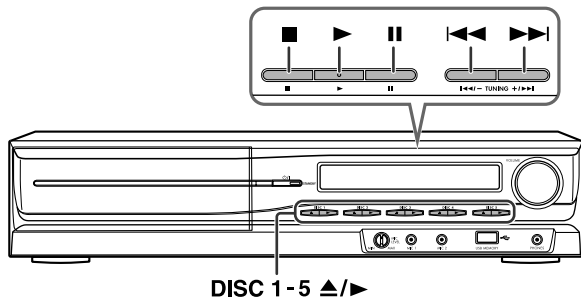
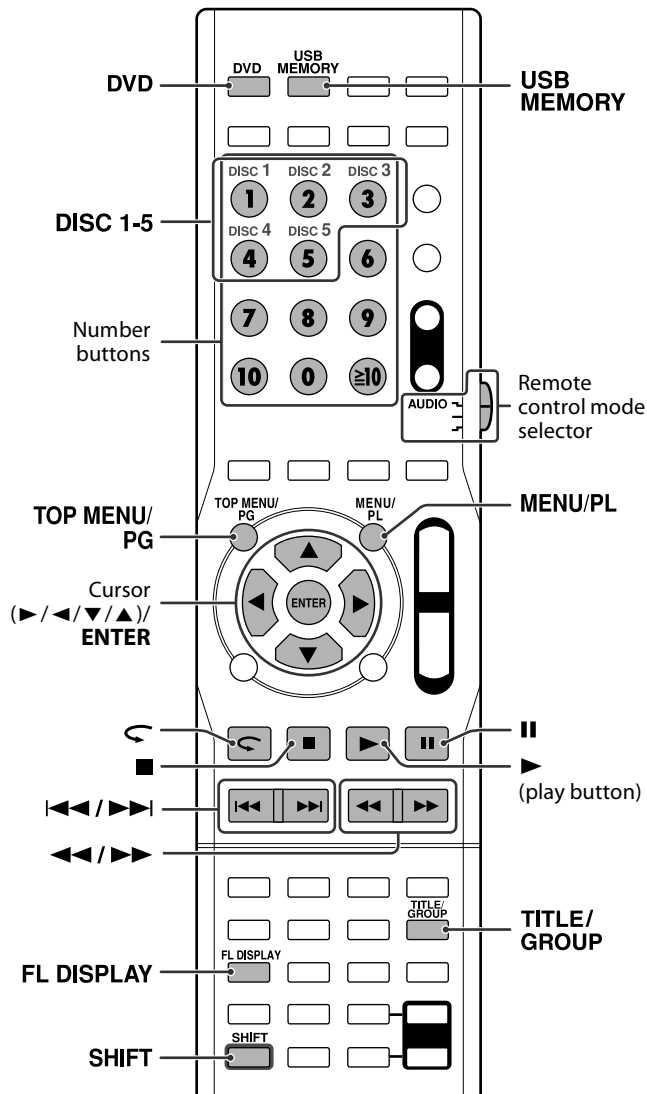

Basic playback

■ To play a disc

- 1 Press the desired **DISC (1-5)**  on the center unit.

The system turns on and the disc tray comes out.

DVD VIDEO	DVD AUDIO	DVD VR
VCD	SVCD	CD
MP3 WMA	JPEG	ASF
MPEG 2/1	DivX	

- 2 Place a disc.

Label side up

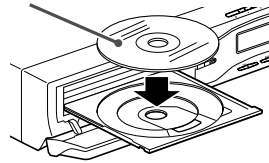

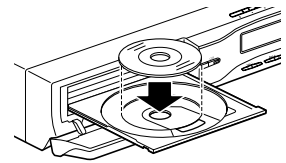

When placing an 8 cm disc



- 3 Press **DISC (1-5)**, with **SHIFT** pressed.

NOTE

- Up to 5 discs can be loaded.
- You can also start playback by pressing the following buttons:
 - DVD or  (play button) on the remote control
 - DISC (1-5)  or  on the center unit
- The system plays back available discs sequentially until you stop playback or until the disc loaded on the DISC 5 tray reaches to the end. However, when DVD VIDEO or DVD AUDIO is loaded in the system, playback of the disc next to the DVD VIDEO or DVD AUDIO will not start.

■ To play a file in a USB mass storage class device

Press **USB MEMORY**.

The operations of the files in a USB mass storage class device depend on the file types stored in the device.

- For details on connecting a USB mass storage class device, see "Connecting a USB mass storage class device". (See page 15.)

■ When playing the following files...

- **For MP3/WMA files**
The file control display (see page 30) appears on the TV screen.
- **For JPEG files**
Each file (still pictures) is shown on the TV screen for about 3 seconds (slide-show). When stopping playback, the file control display (see page 30) appears on the TV screen.
- **For ASF/MPEG-2/MPEG-1 files**
Pressing TOP MENU/PG or MENU/PL shows the file control display (see page 30) on the TV screen during playback.
- **For DivX files**
During the readout time, "READING INDEX" may appear on the TV screen.
Pressing TOP MENU/PG or MENU/PL shows the file control display (see page 30) on the TV screen during playback.

NOTE

- When several types of files are recorded on a disc/device, select appropriate file type on the setup menu. (See page 38.)
- (For JPEG) The system cannot accept operations even though you press any buttons before the entire picture appears on the TV screen.

■ To pause playback

Press **II**.

To continue playback, press  (play button).

■ To stop

Press **■**.

On-screen guide icons

During DVD VIDEO playback, the following guide icons may appear for a while on the TV screen;

- : appears at the beginning of a scene containing multi-subtitle languages.
- : appears at the beginning of a scene containing multi-audio languages.
- : appears at the beginning of a scene containing multi-angle views.
- (Play), (Pause), / (Fast forward/fast-reverse), / (Slow-motion forward/reverse): appears when you perform each operation.
- : the disc cannot accept an operation you have tried to do.

NOTE

- If you do not want the on-screen guide icons to appear, see page 39.

Playback information on the display window

DVD VIDEO

Example: When a DVD VIDEO encoded with Dolby Digital 5.1 ch is played

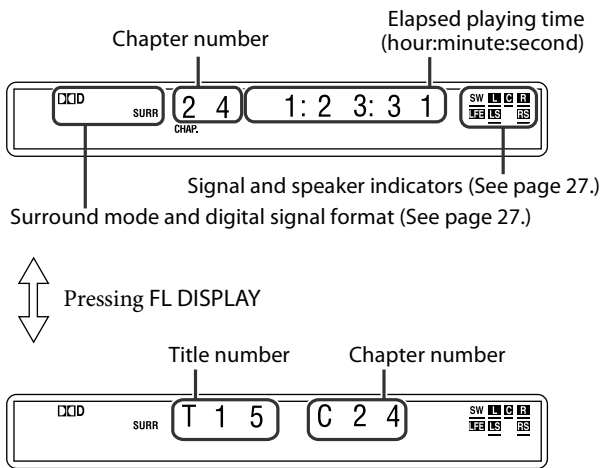

DVD AUDIO

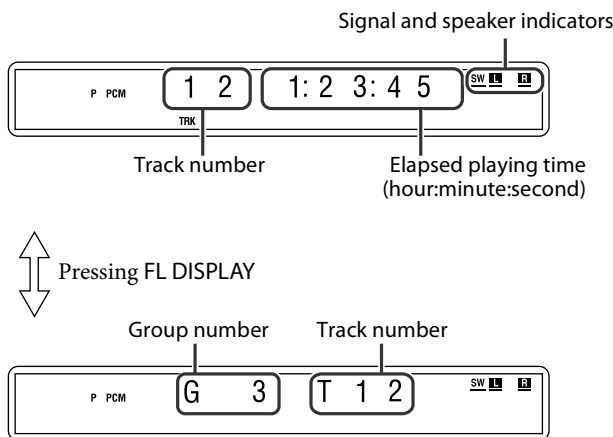

VCD/SVCD/CD

Example: When a CD is played back

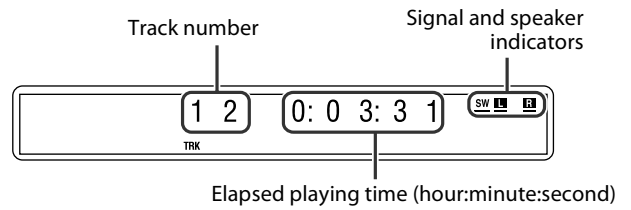

NOTE

- When a VCD or SVCD with PBC function is played, the elapsed playing time does not appear, but "PBC" appears.

MP3/WMA file

Example: When an MP3 file is played back

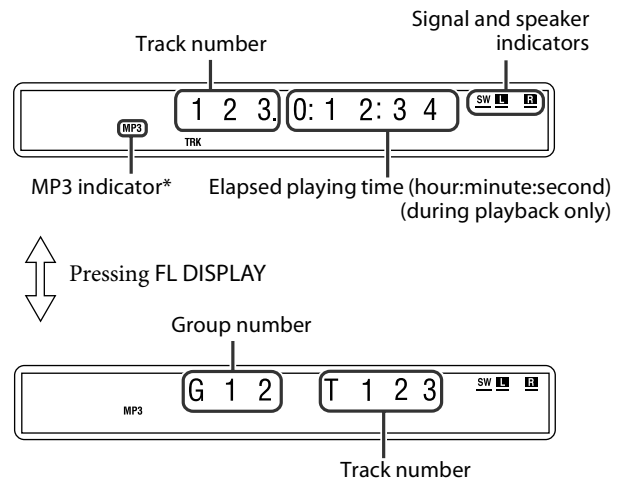

* WMA indicator lights for a WMA file.

JPEG file

Example: When slide-show is played back

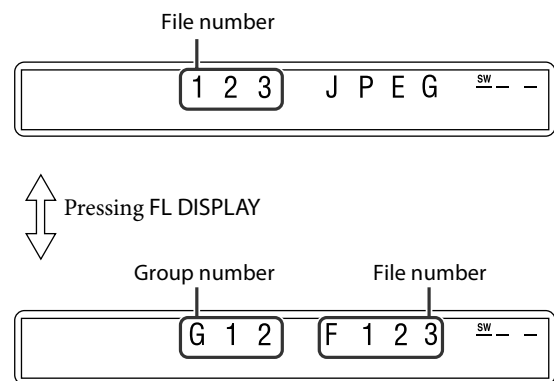

Continued on the next page

ASF/MPEG-2/MPEG-1/DivX file

Example: When an ASF file is played

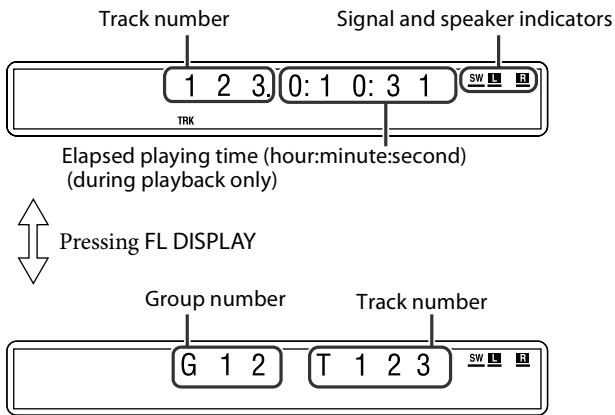

DVD VR disc

Example: During playback on the Original program*

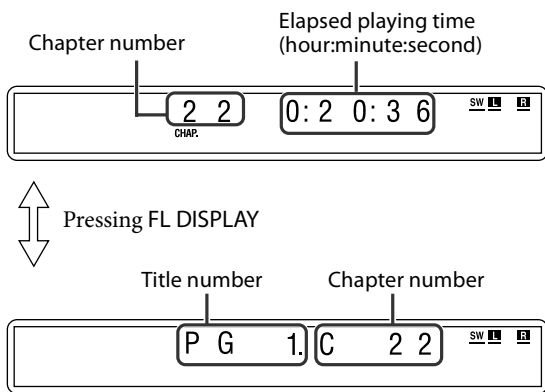

Example: During playback on the Playlist*

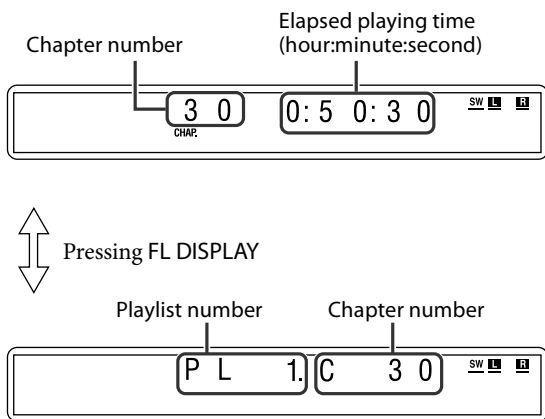

* Pressing TOP MENU/PG or MENU/PL, you can change the play mode. (See page 25.)

NOTE

- You can change the time information mode (except for MP3/WMA/ASF/MPEG-2/MPEG-1/DivX). (See page 28.)
- You can also check the playback information on the TV screen. (See page 27.)

Disc information on the display window

The disc indicators on the display window show the current status of the corresponding disc tray.

Example: When the discs are loaded to disc trays 1, 2 and 5, and the disc in the disc tray 5 is selected.

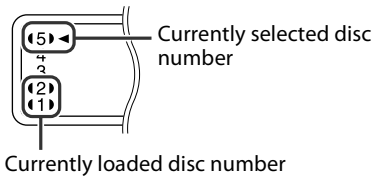

Screen saver

An image may burn in on a TV screen if a static picture is displayed for a long time. To prevent this, the system automatically dims the screen if a static picture is displayed for over 5 minutes (the screen saver function).

- Pressing any button will cancel the screen saver function.
- If you do not want to use the screen saver function, see page 38.

One Touch Replay

You can move back the playback position by 10 seconds from the current position.



■ During playback

Press ◀.

NOTE

- This function works in the same title.
- This function is not available during the repeat playback.
- This feature may not work for some discs.

Fast-forward/fast-reverse search

■ During playback

On the remote control:

Press ►► or ◀◀.

Each time you press the button, the search speed changes (x2, x5, x10, x20, x60).

To return to normal speed playback

Press ► (play button).

On the center unit:

Press and hold ►►| or |◀◀.

Continuously pressing ►►| or |◀◀ increases the fast-forward/reverse search speed (x5, x20).

NOTE

- When a DVD VIDEO, DVD VR, VCD, SVCD, or ASF/MPEG-2/MPEG-1/DivX is played back, no sound comes out during fast-forward/reverse search.
- When a DVD AUDIO, CD, or MP3/WMA is played back, sound is intermittent and low during fast-forward/reverse search.
- This feature may not work for some discs/files.
- For MP3/WMA, the search speed is not shown.
- The search speed for DivX is ►►1, ►►2, ►►3 for forward search, and ◀◀1, ◀◀2 and ◀◀3 for reverse search.

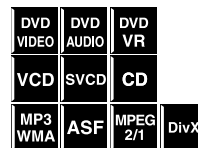

Skip to the beginning of a desired selection

Using ►►|/|◄◄ buttons

- For DVD VIDEO/DVD VR (chapter): During playback
- For VCD/SVCD (track): During playback without PBC function
- For DVD AUDIO/CD/MP3/WMA/JPEG/ASF/MPEG-2/MPEG-1/DivX (track/file): During playback or while stopped

DVD VIDEO	DVD AUDIO	DVD VR
VCD	SVCD	CD
MP3 WMA	JPEG	ASF
MPEG 2/1	DivX	

Press ►►| or |◄◄ repeatedly.

NOTE

- When playing back an MP3/WMA/JPEG/ASF/MPEG-2/MPEG-1/DivX file, you can make operations using the file control display. (See page 30.)
- This feature may not work for some discs/files.

Using number buttons on the remote control

- For DVD VIDEO/DVD VR (title, chapter): While stopped, the title number is selected. During playback, the chapter number is selected.
- For DVD AUDIO (track): During playback or while stopped
- For VCD/SVCD (track): During playback or while stopped without PBC function
- For CD/MP3/WMA/JPEG/ASF/MPEG-2/MPEG-1/DivX (track/file): During playback or while stopped

Press number buttons (0-10, ≥10) to select the desired number.

- For details on using the number buttons, see “How to use the number buttons” below.

How to use the number buttons	
To select 3:	Press 3.
To select 10:	Press 10.
To select 14:	Press ≥10, 1, then 4.
To select 24:	Press ≥10, 2, then 4.
To select 40:	Press ≥10, 4, then 0.
To select 114:	Press ≥10, ≥10, 1, 1, then 4.

Skipping at about 5-minute intervals

You can skip within the file at about 5-minute intervals. This is useful especially when you want to skip within a long file.

MPEG 2/1	DivX
----------	------

- During playback

Press Cursor ► / ◄.

Each time you press the button, the playback position skips to the beginning of the previous or next interval. Each interval is about 5 minutes.

NOTE

- Intervals are automatically assigned from the beginning of a file.
- This feature is available only within the same file.
- This feature may not work for some discs/files.

Locating a desired title/group using number buttons

- During playback or while stopped

1 Press TITLE/GROUP.

“- -” is shown in the title/group display area in the display window.

DVD VIDEO	DVD AUDIO	DVD VR
MP3 WMA	JPEG	ASF
MPEG 2/1	DivX	

Example: During DVD VIDEO playback

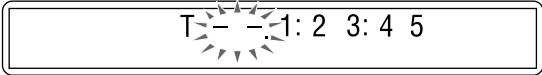

2 While the display window shows “- -”, use number buttons (0-10, ≥10) to enter the desired title or group number.

The system starts playback from the first chapter/track/file of the selected title/group.

- For details on using the number buttons, see “How to use the number buttons” on the left column.

NOTE

- When locating a title of a DVD VR disc, the PG or PL indicator may light on the display window.
- This feature may not work for some discs/files.

Playing back a bonus group

Some DVD AUDIOS have a special group called “bonus group” whose contents are not open to the public. The bonus group is always assigned to the last group of a disc. To play back a bonus group, you have to enter the specific “key number” (a password). The way of getting the key number depends on the disc. After getting the key number, you can play back the bonus group by following the procedure below.



- While the BONUS indicator lights up on the display window

1 Select the bonus group.

For selecting the group, see “Locating a desired title/group using number buttons” described on page 24. The key number entry indication appears.

On the TV



On the display window

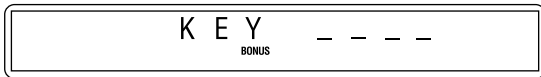

2 Press number buttons (0-9) to enter the key number, then press ENTER.

When you enter the correct key number, playback starts and the BONUS indicator goes off.

- If you enter a wrong number, reenter the correct number.

To clear the key number entry

Perform whichever one of the following:

- Press ■.
- Open the disc tray.
- Turn off the system.

NOTE

- In Random Playback, tracks in the bonus group are not played back.

Selecting the desired title/playlist from the control display

- During playback or while stopped



1 Press TOP MENU/PG or MENU/PL.

The control display is shown on the TV screen, and the system starts playback of the first title/playlist.

- The PLAY LIST is shown only when the playlist is on the DVD VR disc.

TOP MENU/PG: shows the ORIGINAL PROGRAM.

Example:

ORIGINAL PROGRAM					
No	Date	Ch	Time	Title	
1	25/04/04	4ch	19:00	JVC DVD World 2004	
2	17/05/04	8ch	10:30		
3	22/05/04	8ch	17:00	Music Festival	
4	26/05/04	L-1	13:19	children 001	
5	20/06/04	4ch	22:00		
6	25/06/04	L-1	8:23	children 002	

- *1: Title number
- *2: Recording date
- *3: Recording source (TV station, the input terminal of the recording equipment etc.)
- *4: Start time of recording
- *5: Title of the original program/playlist (The title may not be displayed depending on the recording equipment.)
- *6: Current title

MENU/PL: shows the PLAY LIST.

Example:

PLAY LIST					
No	Date	Chap	Length	Title	
1	25/05/04	001	1:03:16	My JVC World	
2	17/06/04	005	1:35:25		
3	20/06/04	003	0:10:23	Favorite music	
4	25/06/04	001	0:07:19	children001-002	

- *7: Playlist number
- *8: Creating date of playlists
- *9: Number of chapters
- *10: Total playing time
- *11: Current playlist

2 Press Cursor ▼ / ▲ to select the desired title/playlist.

The system starts playback of the selected title/playlist.

To clear the control display

Press ENTER.

About the play mode on a DVD VR disc

- Original program (ORIGINAL PROGRAM):
The system can play back the original picture in the recorded order.
- Playlist (PLAY LIST):
The system can play back the playlist edited by the recording equipment.

Advanced operations

- The icon such as  shows the disc formats or file types the operation is available for.

IMPORTANT

Before using the remote control for the following operation;

- Set the remote control mode selector to AUDIO.
- There are exceptions in the operation mentioned above. In such a case, follow each instruction.

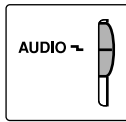

The buttons described below are used on pages 26 to 36.

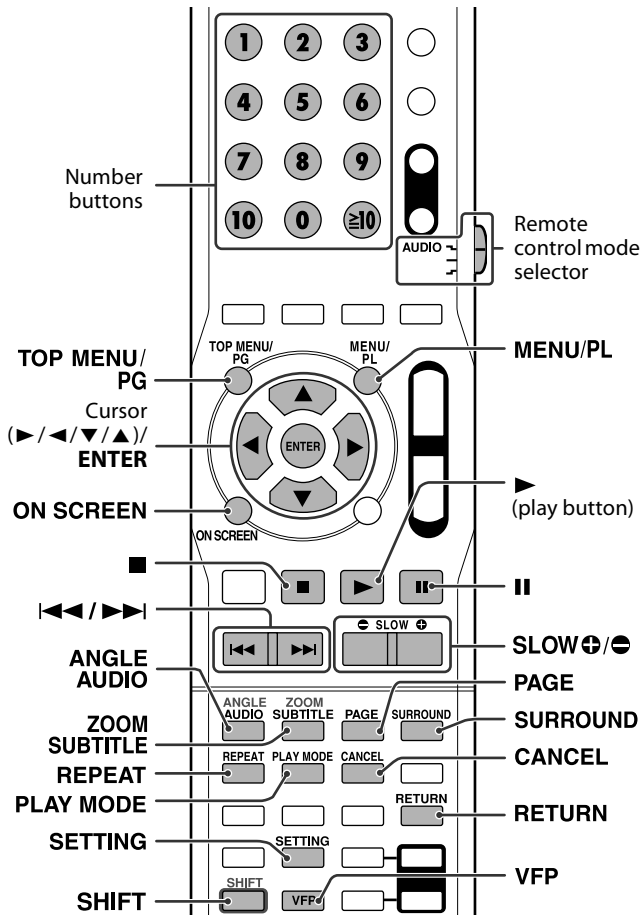

Using the surround mode

You can enjoy more realistic sound field than a stereo sound by using the surround mode.

■ Auto Surround (AUTO SUR)

Used to reproduce the sound as it is recorded without any conversion (downmixing or simulation, etc.). For example, a multichannel source is automatically reproduced in multichannel audio.

■ Dolby Surround

Dolby Pro Logic II*¹

Dolby Pro Logic II has a newly developed multichannel playback format to decode all 2 channel sources — stereo source and Dolby Surround encoded source — into a 5.1 channel.

Dolby Pro Logic II has two modes — Movie mode and Music mode:

• Pro Logic II Movie (MOVIE)

Suitable for reproduction of Dolby Surround encoded sources bearing the mark .

• Pro Logic II Music (MUSIC)

Suitable for reproduction of any 2 channel stereo music sources.

Dolby Digital*¹

Used to reproduce multichannel soundtracks of the software encoded with Dolby Digital (.

- There are other encoding formats of digital surround introduced by Dolby Laboratories, such as Dolby Digital EX.

■ DTS Digital Surround*²

Used to reproduce multichannel soundtracks of the software encoded with DTS Digital Surround (.

DTS Digital Surround (DTS) is another discrete multichannel digital audio format available on CD and DVD software.

- There are other encoding formats of multi-channel digital surround introduced by Digital Theater Systems, Inc., such as DTS-ES, DTS 96/24.

Available Surround modes for each input signal

The ✓ marks show available surround modes.

Signal	Mode	Surround off	Auto Surround	Dolby Surround			DTS Digital Surround	Linear PCM	Packed PCM	DSP	
		OFF	AUTO SUR	MOVIE* ³	MUSIC* ³	DOLBY D	DTS	LPCM	PPCM	STADIUM* ³	ALL ST* ³
Dolby D (Multichannel)		✓	✓	—	—	✓	—	—	—	—	—
Dolby D (2 channel)		✓	✓	✓	✓	—	—	—	—	✓	✓
DTS Digital Surround (Multichannel)		✓	✓	—	—	—	✓	—	—	—	—
DTS Digital Surround (2 channel)		✓	✓	✓	✓	—	—	—	—	✓	✓
Linear/Packed PCM (Multichannel)		✓	✓	—	—	—	—	✓	✓	—	—
Analog (VCR) or Linear/Packed PCM (2 channel)		✓	✓	✓	✓	—	—	—	—	✓	✓

*¹ Manufactured under license from Dolby Laboratories. “Dolby”, “Pro Logic”, “MLP Lossless”, and the double-D symbol are trademarks of Dolby Laboratories.

*² “DTS” and “DTS Digital Surround” are registered trademarks of Digital Theater Systems, Inc.

*³ You can select these modes by pressing SURROUND. (See page 27.)

Continued on the next page

■ **DSP**

• **STADIUM**

STADIUM mode adds clarity and spreads the sound, like in an outdoor stadium.

• **All Channel Stereo**

All Channel Stereo (ALL ST) mode can reproduce a larger stereo sound field using all the connected (and activated) speakers. All Channel Stereo can be used while reproducing 2 channel stereo source.

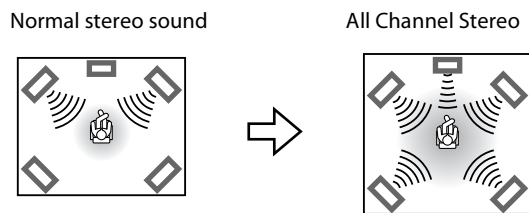

■ **Indicators on the display window**

Digital signal format indicators

- PPCM: Lights when DVD AUDIO packed PCM signals comes in.
- LPCM: Lights when Linear PCM signal comes in.
- DD: Lights when Dolby Digital signals come in.
- dts: Lights when DTS Digital (Surround) signals come in.
- No indication: No digital signal indicator lights when analog signals come in.

Dolby Surround mode indicator

- PLII: Lights when Dolby Pro Logic II mode is activated.

Surround indicator

- SURR: Lights when the surround mode is activated.

Source signal indicators, etc.

Light to indicate the incoming signals.



- L**: Lights when the left channel signal comes in.
- C**: Lights when the center channel signal comes in.
- R**: Lights when the right channel signal comes in.
- LFE**: Lights when the LFE channel signal comes in.
- LS**: Lights when the surround left channel signal comes in.
- RS**: Lights when the surround right channel signal comes in.
- S**: Lights when the monaural surround channel signal or 2 channel Dolby Surround signal comes in.

SW (Subwoofer): Always lights.

The channel with “—” shows that the corresponding speakers are reproducing the channels’ sound. If the channels’ sound decoded into 5.1 channel is reproduced, only “—” lights.

Selecting the surround mode

The system is set up to automatically select the optimal surround mode for input signal from digital multichannel software. When playing back a 2 channel source, you can select the desired surround mode manually.

IMPORTANT

Before using the remote control for the following operation;

- Set the remote control mode selector to AUDIO.

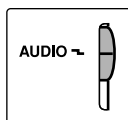

■ **When playing back digital multichannel software (except while OFF is selected)**

The appropriate multichannel surround mode (Dolby Digital, DTS Digital Surround or Linear/Packed PCM) is automatically selected.

■ **When playing back a 2 channel source**

You can select either Dolby Pro Logic II (MOVIE/MUSIC) or the DSP mode.

Press SURROUND repeatedly to select the desired mode.

The surround mode is turned on and the current surround mode appears on the display window.

Each time you press the button, the surround mode changes.

For details on each mode, see “Available Surround modes for each input signal”. (See page 26.)

To turn off the surround mode

Press SURROUND repeatedly until “OFF” appears on the display window.

Storing adjustments — auto memory

When you turn the power off, the system memorizes the current surround mode. The memorized mode is automatically recalled when you turn the power on.

NOTE

- For a down-mixing prohibited DVD AUDIO disc, the system continues to output multi-channel signals with “MULTI CH” shown on the display window even if the surround mode is turned off during playback. On the other hand, the system outputs only the front left and right channel signals with “LR ONLY” shown on the display window when you start playback with the surround mode having been set to “OFF” or “H. PHONE”.
- For ASF, MPEG-2, MPEG-1 and DivX (except DivX version 6), the surround mode takes no effects.

Using the on-screen bar

You can check disc information and you can use some functions using the on-screen bar.

Showing the on-screen bar

- Whenever a disc is loaded

Press ON SCREEN.

Each time you press the button, the on-screen bar changes as follows on the TV screen.

Example: During DVD VIDEO playback



OFF

(The on-screen bar disappears)



(back to the beginning)

- The currently selected item shows green.

■ Contents of the on-screen bar during playback

DVD VIDEO

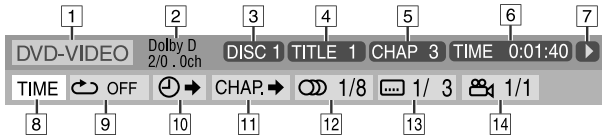

DVD AUDIO

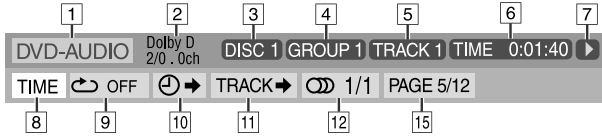

VCD

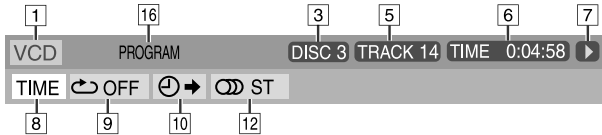

SVCD

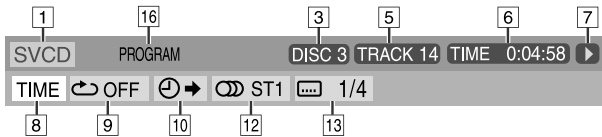

CD

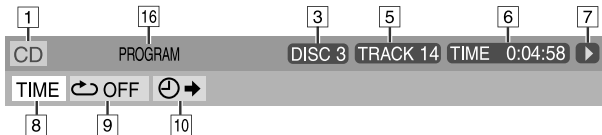

DVD VR disc

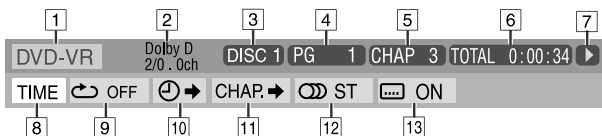

ASF/MPEG-2/MPEG-1/DivX



- 1 Shows disc type.
- 2 Shows audio information.
- 3 Shows disc number.
- 4 For DVD VIDEO: Shows current title number.
For DVD AUDIO: Shows current group number.
For DVD VR: Shows current play mode (PG: for Original program, PL: for Playlist) and title number.
- 5 For DVD VIDEO and DVD VR: Shows current chapter number.
For other type of discs: Shows current track number.
- 6 Shows time information. See “Changing the time information” on the right column.

- 7 Shows playback status.
▶: appears during playback.
▶▶ / ◀◀: appears during fast forward/reverse.
▶ / ◀: appears during playback in forward slow-motion/reverse slow-motion.
⏸: appears when paused.
⏹: appears when stopped.
- 8 Select this to change time information (6). See “Changing the time information” below.
- 9 Select this for Repeat Playback. (See page 35.)
- 10 Select this for time search function. (See page 30.)
- 11 For DVD VIDEO and DVD VR: Select this for chapter search function. (See page 29.)
For DVD AUDIO: Select this for track search function. (See page 29.)
- 12 Select this to change audio language or channel. (See page 32.)
- 13 Select this to change subtitle language and subpicture. (See page 31.)
- 14 Select this to change view angle. (See page 31.)
- 15 Select this to change the page. (See page 33.)
- 16 Shows Playback mode status.
PROGRAM: appears during Program Playback. (See page 34.)
RANDOM: appears during Random Playback. (See page 35.)
- 17 Shows Repeat mode status. (See page 35.)

Changing the time information

You can change the time information in the on-screen bar on the TV screen and the display window of the center unit.

DVD VIDEO	DVD AUDIO	DVD VR
VCD	SVCD	CD

■ During playback

- 1 Press ON SCREEN twice.
The on-screen bar appears on the TV screen.
- 2 Press Cursor ▶ / ◀ to highlight TIME .
- 3 Press ENTER repeatedly to select the desired information.

Example: When elapsed playing time of disc is selected.

TOTAL 1:25:58

- DVD VIDEO/DVD AUDIO/DVD VR
 - TIME: Elapsed playing time of current chapter/track
 - REM: Remaining time of current chapter/track
 - TOTAL: Elapsed time of Title/Group/Program
 - T. REM: Remaining time of Title/Group/Program

- VCD/SVCD/CD
 - TIME: Elapsed playing time of current track
 - REM: Remaining time of current track
 - TOTAL: Elapsed time of disc
 - T. REM: Remaining time of disc

4 Press ON SCREEN.

The on-screen bar disappears.

NOTE

- When playing back DVD VR, “TIME” and “REM” cannot be shown.

Playing from a specified position on a disc

You can start playing a title, chapter or track you specify. You can also play a disc from specified time.

Locating a desired scene from the DVD menu

DVD VIDEOS and DVD AUDIOS generally have their own menus which show disc contents and you can display them on the TV screen. You can locate a desired scene by using these menus.



■ Whenever a DVD VIDEO or DVD AUDIO is loaded

1 Press TOP MENU/PG or MENU/PL.

The menu appears on the TV screen.

Normally, a DVD VIDEO or DVD AUDIO which contains more than one title will have a “top” menu which lists the titles. Press TOP MENU/PG to show the title menu.

Some discs may also have a different menu which is shown by pressing MENU/PL.

See the instructions for each disc regarding its particular menu.

2 Use Cursor ►/◀/▼/▲ to select a desired item.

3 Press ENTER.

- With some discs, you can also select items by entering the corresponding number using number buttons.

NOTE

- This feature may not work for some discs.

Locating a desired scene using a VCD/SVCD menu with PBC

A VCD or SVCD recorded with PBC has its own menus such as a list of contained songs. You can locate a specific scene by using these menus.



■ During playback with PBC function

1 Press RETURN repeatedly until the menu appears on the TV screen.

2 Press number buttons (1-10, ≥10) to select the number of the desired item.

- For details on using the number buttons, see “How to use the number buttons”. (See page 24.)

To return to the menu

Press RETURN repeatedly until the menu screen appears.

When “NEXT” or “PREVIOUS” is shown on the TV screen:

- To go to the next page, press ►►.
- To return to the previous page, press ◀◀.

NOTE

- If you want to play a PBC-compatible VCD/SVCD without using the PBC function, perform any of the following:
 - Start playback by pressing number buttons while stopped.
 - Press ►► repeatedly until the desired track number is displayed, then start playback by pressing ► (play button). The track number appears on the display window instead of “PBC”.
- To activate the PBC function when playing a PBC-compatible VCD/SVCD without using the PBC function, perform any of the following:
 - Press TOP MENU/PG or MENU/PL.
 - Press ■ twice to stop playback, then press ► (play button).

Locating a desired chapter/track using the on-screen bar

■ During playback



1 Press ON SCREEN twice.

The on-screen bar appears on the TV screen.

2 Press Cursor ►/◀ to highlight CHAP.►/ TRACK►.

3 Press ENTER.

Example: During DVD VIDEO playback



4 Press number buttons (0-9) to enter the desired chapter number.

Example:

- To select 8: Press 8.
- To select 10: Press 1, then 0.
- To select 20: Press 2, then 0.
- To select 37: Press 3, then 7.

To correct a misentry

Repeat step 4.

5 Press ENTER.

6 Press ON SCREEN.

The on-screen bar disappears.

NOTE

- You can select up to the 99th chapter/track.

Locating a desired position by specifying the time

- For DVD VIDEO/DVD AUDIO/DVD VR: During playback
- For VCD/SVCD: While stopped or during playback without PBC function
- For CD: During playback or while stopped



■ When specifying the elapsed playing time from the beginning of the disc

Perform the following procedure while stopped.

■ When specifying the elapsed playing time from the beginning of the current title/track

Perform the following procedure during playback.

1 Press ON SCREEN twice.

The on-screen bar appears on the TV screen.

2 Press Cursor ►/◄ to highlight ⏸.

3 Press ENTER.



4 Use number buttons (0-9) to enter the time.

Example: To play back from a point 2 (hours): 34 (minutes): 08 (seconds) elapsed

TIME _:__:__ ⇒ TIME 2:__:__ ⇒
Press 2 Press 3

TIME 2:3__:__ ⇒ TIME 2:34:__:__ ⇒
Press 4 Press 0

TIME 2:34:0_ ⇒ TIME 2:34:08
Press 8

To cancel a misentry

Press Cursor ◀ repeatedly.

5 Press ENTER.

6 Press ON SCREEN.

The on-screen bar disappears.

Using the file control display

You can search and play desired groups and tracks/files using the file control display on the TV screen.

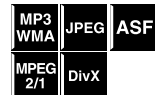

Example: When the source is DVD.

Current group/total group number Playback mode*1 (PROGRAM, RANDOM, REPEAT)

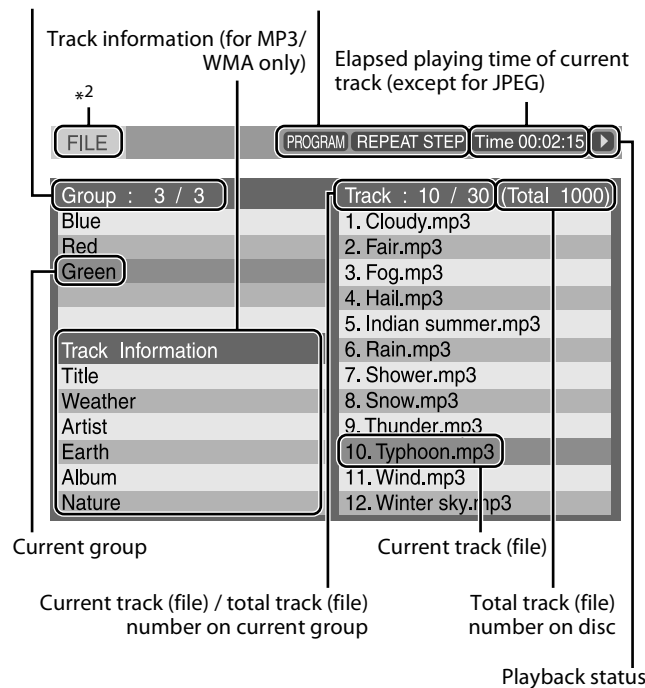

*1 (For JPEG/ASF/MPEG-2/MPEG-1/DivX) The Program and Random mode are not available.

*2 When the source is USB MEMORY, "USB" appears.

The file control display appears automatically during playback (MP3/WMA) or while stopped.

- For MP3/WMA: During playback or while stopped
- For JPEG/ASF/MPEG-2/MPEG-1/DivX: While stopped

1 Press Cursor ►/◄/▼/▲ to select the desired group/track/file.

2 Press ► (play button) or ENTER.

- Track playback/slide-show starts from the selected track/file.
- When you press ENTER for JPEG, only the selected file is played back.

NOTE

- (For MP3/WMA) During playback, you can change the playback track/file by pressing ►/◄ or Cursor ▲/▼.
- You can also check playback information on the display window. (See page 22.)
- Some group, track and file names may not be displayed correctly depending on recording conditions.
- The order of groups, tracks, and files may be displayed differently from the order displayed on your personal computer.

Resume Playback

When Resume Playback is set to "ON" (see page 39) and you stop playback by the following operations, the position where playback has been stopped is stored. (The RESUME indicator lights on the display window.)

- Turning off the power (See page 18.)
- Pressing **■** once
- Changing the source (See page 19.)

DVD VIDEO	DVD AUDIO	DVD VR
VCD	SVCD	MP3 WMA
ASF	MPEG 2/1	DivX

To start playback from the stored position

Press **▶** (play button) or corresponding source button (DVD or USB MEMORY).

- There may be a case when **▶** (play button) does not work after changing the source. In this case, select DVD or USB MEMORY as a source.
- Pressing DISC (1-5) (with SHIFT pressed) on the remote control or DISC (1-5) **▶** on the center unit also resumes disc playback.

To clear the stored position

Press **■** again.

- Opening the disc tray with the playback disc or disconnecting the USB mass storage class device also clears the stored position.

NOTE

- (For DivX) The beginning of a scene where playback has been stopped may be stored.

Selecting a view angle

- During playback of a disc containing multi-view angles

DVD VIDEO	DVD AUDIO
-----------	-----------

When using the ANGLE button:

1 Press ANGLE with SHIFT pressed.

Example: The first view angle is selected out of 3 view angles recorded.

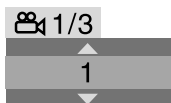

2 Press ANGLE repeatedly with SHIFT pressed, or press Cursor ▼/▲ to select the desired view angle.

When using the on-screen bar:

1 Press ON SCREEN twice.

The on-screen bar appears on the TV screen.

2 Press Cursor ▶/◀ to highlight 1/3.

3 Press ENTER.



4 Press Cursor ▼/▲ to select the desired view angle.

5 Press ENTER.

6 Press ON SCREEN.

The on-screen bar disappears.

NOTE

- During DVD AUDIO playback, this feature is available only for the video part.

Selecting the subtitle

- During playback of a disc/file containing subtitles in several languages

DVD VIDEO	DVD AUDIO	DVD VR
SVCD	DivX	

When using the SUBTITLE button:

1 Press SUBTITLE.

Example (DVD VIDEO): "ENGLISH" is selected out of 3 subtitle languages recorded.

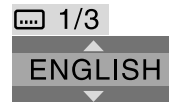

2 Press Cursor ▼/▲ to select the desired subtitle.

For DVD VR

- Pressing SUBTITLE activates the subtitles (subpictures) regardless of whether the subtitles are recorded or not. (Subpictures will not change if no subpicture is recorded.)

For SVCD

- An SVCD can contain up to four subtitles. Pressing SUBTITLE changes the subtitles regardless of whether the subtitles are recorded or not. (Subtitles will not change if no subtitle is recorded.)

When using the on-screen bar:

1 Press ON SCREEN twice.

The on-screen bar appears on the TV screen.

2 Press Cursor ▶/◀ to highlight 1/3.

3 Press ENTER.



4 Press Cursor ▼/▲ repeatedly to select the desired subtitle.

5 Press ENTER.

6 Press ON SCREEN.

The on-screen bar disappears.

NOTE

- To clear the subtitle, press SUBTITLE. Each time you press SUBTITLE, subtitle appears and disappears alternately.
- Some subtitle or audio languages are abbreviated in the pop-up window. See "The language codes list". (See page 37.)
- During DVD AUDIO playback, this feature is available only for the video part.
- For DivX, you cannot operate this procedure using the on-screen bar.

Selecting the audio

- During playback of a disc/file containing audio in several languages



When using the AUDIO button:

1 Press AUDIO.

Example (DVD VIDEO): "ENGLISH" is selected out of 3 audio languages recorded.

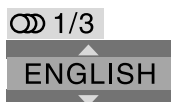

2 Press AUDIO repeatedly or press Cursor ▼/▲ to select the desired audio.

When using the on-screen bar:

1 Press ON SCREEN twice.

The on-screen bar appears on the TV screen.

2 Press Cursor ►/◀ to highlight 1/3.

3 Press ENTER.

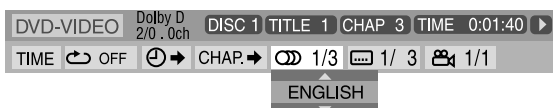

4 Press Cursor ▼/▲ to select the desired audio.

5 Press ENTER.

6 Press ON SCREEN.

The on-screen bar disappears.

NOTE

- Some subtitle or audio languages are abbreviated in the pop-up window. See "The language codes list". (See page 37.)
- "ST", "L", or "R" is displayed when playing a VCD respectively representing "stereo", "left sound" and "right sound".
When playing a SVCD, "ST1", "ST2", "L1", "R1", "L2", or "R2" is displayed.
- For DivX, you cannot operate this procedure using the on-screen bar.

Special picture playback

Frame-by-frame playback

- During playback

Press II repeatedly.

Each time you press the button, the still picture advances by one frame.



To return to normal playback

Press ► (play button).

Playing back in slow-motion

- During playback

1 Press II at the point where you want to start playback in slow-motion from.



The system pauses playback.

2 Press SLOW ⊕.

Playback in forward slow-motion starts.

For DVD VIDEO/DVD AUDIO only:

- To play back in reverse slow-motion, press SLOW ⊖.

Each time you press the button, the playback speed becomes faster (1/32, 1/16, 1/8, 1/4, 1/2).

Example: On the TV



To return to normal playback

Press ► (play button).

NOTE

- Sound cannot be heard during slow-motion playback.
- During DVD AUDIO playback, this feature is available only for the video part.

Selecting browsable still picture recorded on DVD AUDIO

Most DVD AUDIOS include browsable still pictures (B.S.P.), which usually appear by turns automatically during playback according to the playback sequence. You can change the picture (turn the page) manually when the current group/track has selectable pictures (pages).



- During playback and while the B.S.P. indicator lights up on the display window

When using the PAGE button:

Press PAGE repeatedly to select a desired still picture.

When using the on-screen bar:

1 Press ON SCREEN twice.

The on-screen bar appears on the TV screen.

2 Press Cursor ► / ◀ to highlight .

3 Press ENTER.

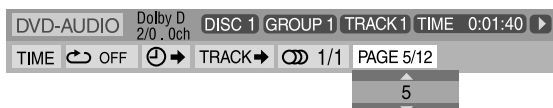

4 Press Cursor ▲ / ▼ to select the desired still picture.

5 Press ENTER.

6 Press ON SCREEN.

The on-screen bar disappears.

Zooming in

- During playback or while paused

1 Press ZOOM with SHIFT pressed.

Each time you press ZOOM with SHIFT pressed, scene magnification changes.

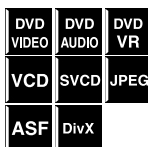

2 While zoomed in, press Cursor ► / ◀ / ▼ / ▲ to move zoom-in area.

To return to normal playback

Press ZOOM repeatedly with SHIFT pressed, to select ZOOM OFF.

NOTE

- The number of the magnification steps varies depending on the disc type.
- During slide-show playback of JPEG, zooming in is not available. In such a case, press **II** to pause slide-show playback, then zoom in.
- During DVD AUDIO playback, this feature is available only for the video part.
- During playback, there may be a case where Cursor (► / ◀ / ▼ / ▲) does not work in step 2 above.

Changing the VFP setting

The VFP (Video Fine Processor) function enables you to adjust the picture character according to the type of programming, picture tone or personal preference.



- During playback

1 Press VFP.

The current VFP settings appear on the TV screen.

Example:

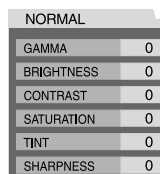

2 Press Cursor ► / ◀ repeatedly to select the VFP mode.

- NORMAL: Normally select this.
- CINEMA: Suitable for movies.

When you select "NORMAL" or "CINEMA", press VFP to complete the setting.

- USER 1 and USER 2: You can adjust parameters that affect picture appearance.

Only when selecting "USER 1" or "USER 2" in step 2, proceed to perform the following operation;

3 Press Cursor ▼ / ▲ repeatedly to select a parameter you want to adjust.

Adjust gradually and confirm picture appearance results are as preferred.

- GAMMA: Controls brightness of neutral tints while maintaining brightness of dark and bright portions (-3 to +3).
- BRIGHTNESS: Controls screen brightness (-8 to +8).
- CONTRAST: Controls screen contrast (-7 to +7).
- SATURATION: Controls screen color depth (-7 to +7).
- TINT: Controls screen tint (-7 to +7).
- SHARPNESS: Controls screen sharpness (-8 to +8).

4 Press ENTER.

Example:



5 Press Cursor ▼ / ▲ to change the setting.

6 Press ENTER.

The current VFP settings appear again.

7 Repeat steps 3 to 6 to adjust other parameters.

8 Press VFP.

NOTE

- Although the setting display disappears in the middle of the procedure, the setting at that time will be stored.

Program Playback

■ While stopped

1 Press PLAY MODE repeatedly until program window appears on the TV screen.

The PRG indicator lights on the display window.



PROGRAM			
No	Disc	Group/Title	Track/Chapter
1			
2			
3			
4			
5			
6			
7			
8			
9			
10			

USE NUMERIC KEYS TO PROGRAM TRACKS.
USE CANCEL TO DELETE THE PROGRAM.

2 Follow the instructions that appear on the TV screen to program the desired chapters/tracks.

- For details on using the number buttons, see “How to use the number buttons”. (See page 24.)
- The content’s numbers that you have to specify for programming varies depending on the disc/file type:
 - DVD VIDEO: Titles and chapters
 - VCD, SVCD, CD: Tracks
 - DVD AUDIO, MP3, WMA: Groups and tracks
- Before you program the tracks in bonus group on a DVD AUDIO, perform the procedure of “Playing back a bonus group” (see page 25) to turn off the BONUS indicator on the display window.
- You can specify the chapters/tracks whose number is up to 99.
- There may be a case that the group or title number can be entered even for discs that contain no groups or titles. In such a case, press ENTER to proceed to the Track/Chapter column.
- When you press ENTER instead of the number buttons in the Track/Chapter column, “ALL” appears and all the tracks or chapters on the selected group or title are programmed as a step.

To clear the programs one by one from the last entered number

Press CANCEL repeatedly.

To clear all programs

Press and hold CANCEL.

You can also clear the program by turning off the system.

3 Press ► (play button).

If all of the programmed tracks/files have been played back, playback stops and the program window appears again. Note that program setting remains.

To check the program contents

During playback, press ■. Playback stops and the program window appears.

To quit the Program mode

While stopped, press PLAY MODE repeatedly until both program window and **RANDOM** disappear from the TV screen.

NOTE

- When the source is USB MEMORY, Program Playback does not work.
- There may be a case where bonus group on a DVD AUDIO cannot be played.
- The Resume function cannot be used with Program Playback.
- DISC (1-5) on the remote control and DISC (1-5) ► on the center unit do not work during Program Playback.
- Program Playback may not work for some discs.

Random Playback

You can play titles or tracks on a disc in random order.



- While stopped

1 Press PLAY MODE repeatedly until **RANDOM appears on the TV screen.**

The RND indicator lights on the display window.

2 Press ► (play button).

- When more than one discs are loaded, the system starts Random Playback of the next disc after completing current disc playback.

To quit Random mode

While stopped, press PLAY MODE repeatedly until both program window and **RANDOM** disappear from the TV screen.

You can also clear the Random mode by turning off the system.

NOTE

- When the source is USB MEMORY, Random Playback does not work.
- The same title/track will not be played back more than once during Random Playback.

Repeat Playback

Repeating the current selection or all discs

- For DVD VIDEO/DVD VR: During playback
- For VCD/SVCD: During playback without PBC function or while stopped
- For DVD AUDIO/CD/MP3/JPEG/ASF/MPEG-2/MPEG-1/DivX: During playback or while stopped



When using the REPEAT button:

Press REPEAT.

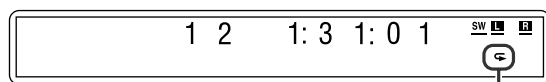

Repeat mode indicator

Each time you press REPEAT, the Repeat mode changes.

Display window	TV screen	Meanings
↺	↺GROUP REPEAT GROUP	Repeats the current group for DVD AUDIO/MP3/WMA/JPEG/ASF/MPEG-2/MPEG-1/DivX.
	↺TITLE	Repeats the current title for DVD VIDEO.
	↺PG	(For DVD VR) Repeats the current title for Original program.
	↺PL	(For DVD VR) Repeats the current playlist for Playlist.
↺ DISC	↺DISC REPEAT DISC	Repeats all titles and tracks on the current disc for DVD VR/VCD/SVCD/CD/MP3/WMA/JPEG/ASF/MPEG-2/MPEG-1/DivX.
	↺ ALL REPEAT ALL	Repeats all the available discs/files.
↺ 1	↺TRACK, ↺STEP REPEAT TRACK, REPEAT STEP	Repeats the current track for DVD AUDIO/VCD/SVCD/CD/MP3/WMA/ASF/MPEG-2/MPEG-1/DivX.
	↺CHAP, ↺STEP	Repeats the current chapter for DVD VIDEO/DVD VR.
No indication	↺OFF	Repeat mode is off. The system plays back the disc/file normally.

NOTE

- When DVD VIDEO or DVD AUDIO is loaded in the system, playback of the disc next to the DVD VIDEO or DVD AUDIO will not start, although ↺ALL /REPEAT ALL on the TV screen or ↺ ALL in the display window is shown.
- For DVD VIDEO and DVD AUDIO, REPEAT ALL and REPEAT DISC may not be available depending on the disc.

When using the on-screen bar (except for MP3/WMA/JPEG/ASF/MPEG-2/MPEG-1/DivX):

1 Press ON SCREEN twice.

The on-screen bar appears on the TV screen.

2 Press Cursor ► / ◀ to highlight ↺ OFF .

3 Press ENTER.

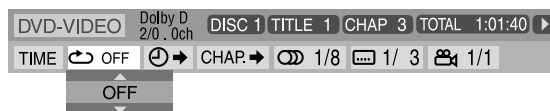

4 Press Cursor ▼ / ▲ repeatedly to select the Repeat mode.

5 Press ENTER.

6 Press ON SCREEN.
The on-screen bar disappears.

To cancel Repeat Playback

Select "OFF" in step 4.

Repeating a desired part [A-B Repeat]

You can repeat playback of a desired part by specifying the beginning (point A) and ending (point B).



- During playback

1 Press ON SCREEN twice.

The on-screen bar appears on the TV screen.

2 Press Cursor ►/◀ to highlight OFF.

3 Press ENTER.



4 Press Cursor ▼/▲ repeatedly to select "A-B".

5 Press ENTER at the beginning of the part you want to repeat (point A).



The repeat mode indicator " A -" appears on the display window.

6 Press ENTER at the end of the part you want to repeat (point B).

The repeat mode indicator on the display window changes to " A - B" and A-B Repeat Playback starts.

7 Press ON SCREEN.

The on-screen bar disappears.

To cancel

Select "OFF" in step 4, then press ENTER.

NOTE

- When playing back a DVD VIDEO/DVD VR, A-B Repeat Playback is possible only within the same title.
- "A-B" cannot be selected during Program and Random Playback.
- "A-B" cannot be selected during playback with PBC function.

Tray lock

You can lock the tray and prohibit unwanted disc ejection.

On the center unit ONLY:

- While the system is turned off

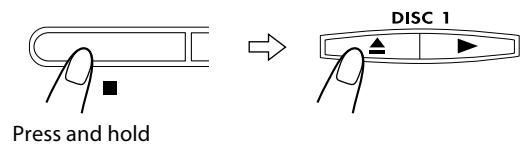

Press and hold

- "LOCKED" appears on the display window.
- If you try to eject the disc, "LOCKED" appears to indicate that the tray is locked.

To cancel

Carry out the same operation again.

- "UNLOCKED" appears on the display window.

Setting the sound balance

IMPORTANT

Before using the remote control for the following operation;

- Set the remote control mode selector to AUDIO.



NOTE

- Before you start operation; There is a time limit when doing the following steps. If the setting is canceled before you finish, start from step 1 again.

1 Press SETTING.

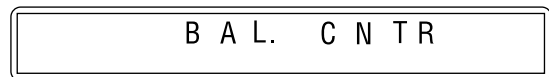

2 Press Cursor ►/◀ to make an adjustment or selection.

You can adjust the balance of the sound between "R (right) -21" and "L (left) -21". To set the balance to normal, select "CNTR (center)".

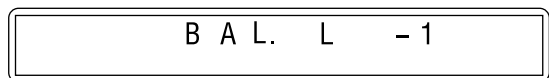

The adjustment is set and the display automatically disappears a few seconds later.

Setting DVD preferences

Using the setup menus

- You can change the language used in the setup menus. See “Menu description” below.

Basic operation on the setup menus

IMPORTANT

Before using the remote control for the following operation;

- Set the remote control mode selector to AUDIO.
- Press DVD or USB MEMORY.

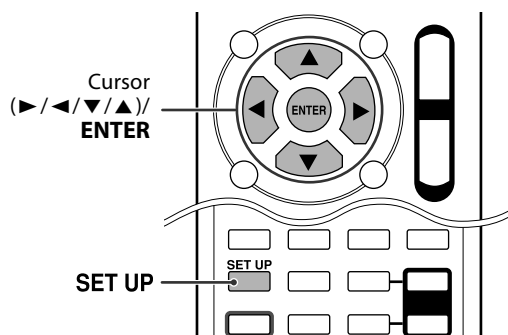
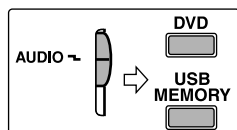

- While stopped

1 Press SET UP.

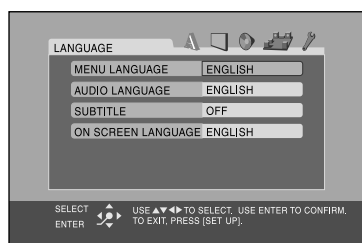

2 Follow the instructions that appear on the TV screen.

Menu description

A: Language menu (LANGUAGE)

■ MENU LANGUAGE

Some DVDs have their own menus in multiple languages.

- Select the initial language*.

■ AUDIO LANGUAGE

Some DVDs have multiple audio languages.

- Select the initial audio language*.

■ SUBTITLE

Some DVDs have multiple subtitle languages.

- Select the initial subtitle language*.

■ ON SCREEN LANGUAGE

Select the language shown on the TV screen when operating this system.

* When the language you have selected is not recorded to a disc, the original language is automatically used as the initial language.

NOTE

- See the following “The language codes list” for the code of each language, such as “AA”, etc.

The language codes list

AA	Afar	IK	Inupiak	RN	Kirundi
AB	Abkhazian	IN	Indonesian	RO	Rumanian
AF	Afrikaans	IS	Icelandic	RW	Kinyarwanda
AM	Ameharic	IW	Hebrew	SA	Sanskrit
AR	Arabic	JJ	Yiddish	SD	Sindhi
AS	Assamese	JW	Javanese	SG	Sangho
AY	Aymara	KA	Georgian	SH	Serbo-Croatian
AZ	Azerbaijani	KK	Kazakh	SI	Singhalese
BA	Bashkir	KL	Greenlandic	SK	Slovak
BE	Byelorussian	KM	Cambodian	SL	Slovenian
BG	Bulgarian	KN	Kannada	SM	Samoan
BH	Bihari	KO	Korean (KOR)	SN	Shona
BI	Bislama	KS	Kashmiri	SO	Somali
BN	Bengali, Bangla	KU	Kurdish	SQ	Albanian
BO	Tibetan	KY	Kirghiz	SR	Serbian
BR	Breton	LA	Latin	SS	Siswati
CA	Catalan	LN	Lingala	ST	Sesotho
CO	Corsican	LO	Laothian	SU	Sundanese
CS	Czech	LT	Lithuanian	SV	Swedish
CY	Welsh	LV	Latvian, Lettish	SW	Swahili
DA	Danish	MG	Malagasy	TA	Tamil
DZ	Bhutani	MI	Maori	TE	Telugu
EL	Greek	MK	Macedonian	TG	Tajik
EO	Esperanto	ML	Malayalam	TH	Thai
ET	Estonian	MN	Mongolian	TI	Tigrinya
EU	Basque	MO	Moldavian	TK	Turkmen
FA	Persian	MR	Marathi	TL	Tagalog
FI	Finnish	MS	Malay (MAY)	TN	Setswana
FJ	Fiji	MT	Maltese	TO	Tonga
FO	Faroese	MY	Burmese	TR	Turkish
FY	Frisian	NA	Nauru	TS	Tsonga
GA	Irish	NE	Nepali	TT	Tatar
GD	Scots Gaelic	NL	Dutch	TW	Twi
GL	Galician	NO	Norwegian	UK	Ukrainian
GN	Guarani	OC	Occitan	UR	Urdu
GU	Gujarati	OM	(Afan) Oromo	UZ	Uzbek
HA	Hausa	OR	Oriya	VI	Vietnamese
HI	Hindi	PA	Panjabi	VO	Volapuk
HR	Croatian	PL	Polish	WO	Wolof
HU	Hungarian	PS	Pashto, Pushto	XH	Xhosa
HY	Armenian	PT	Portuguese	YO	Yoruba
IA	Interlingua	QU	Quechua	ZU	Zulu
IE	Interlingue	RM	Rhaeto-Romance		

Picture menu (PICTURE)

MONITOR TYPE

You can select the monitor type to match your TV when you play DVDs recorded in the picture's height/width ratio of 16:9.

- **16:9/16:9 MULTI (Wide television conversion)**
Select this when the aspect ratio of your TV is fixed on 16:9 (wide TV).
When you play DVDs recorded in the picture's height/width ratio of 4:3, the system adjust the ratio of output signal automatically.
- **4:3 LB/4:3 MULTI LB (Letter Box conversion)**
Select this when the aspect ratio of your TV is 4:3 (conventional TV). While viewing a wide screen picture, the black bars appear on the top and the bottom of the screen.
- **4:3 PS/4:3 MULTI PS (Pan Scan conversion)**
Select this when the aspect ratio of your TV is 4:3 (conventional TV). While viewing a wide screen picture, the black bars do not appear, however, the left and right edges of the pictures will not be shown on the screen.

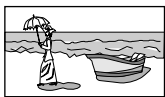

Ex.: 16:9



Ex.: 4:3 LB

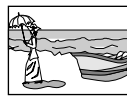

Ex.: 4:3 PS

NOTE

- Even if "4:3 PS" or "4:3 MULTI PS" is selected, the screen size may become "4:3 LB" or "4:3 MULTI LB" with some DVDs. This depends on how DVDs are recorded.
- When selecting "MULTI" options as the monitor type for the multi-color system TV, the system outputs PAL or NTSC video signal according to the disc/file, regardless of the scan mode setting (see page 20).

PICTURE SOURCE

When you set the scan mode to the progressive mode (see page 20), you can obtain optimal picture quality by selecting whether the content on the disc/file is processed by frame (film source) or by field (video source).

Normally set to "AUTO".

- **AUTO**
Used to play a disc/file containing both video and film source materials.
This system recognizes the source type (video or film) of the current disc/file according to the disc/file information.
If the playback picture is unclear or noisy, or the oblique lines of the picture are rough, try to change to other modes.
- **FILM**
Suitable for playing back a film source disc/file.
- **VIDEO**
Suitable for playing back a video source disc/file.

SCREEN SAVER (See page 23.)

You can activate or deactivate screen saver function.

FILE TYPE

When several types of files are recorded on a disc/device, you can select which files to play.

- **AUDIO**
Select this to play MP3/WMA files.
- **STILL PICTURE**
Select this to play JPEG files.
- **VIDEO**
Select this to play ASF/MPEG-2/MPEG-1/DivX files.

Audio menu (AUDIO)

D. RANGE COMPRESSION

(Dynamic range compression)

You can enjoy low level recorded sound clearly at night even at a low volume when listening to the sound with Dolby Digital.

- **AUTO**
Select this when you want to enjoy surround sound with its full dynamic range (no effect applied).
- **ON**
Select this when you want to fully apply the compression effect (useful at midnight).

NOTE

- When you play a multichannel Dolby Digital source with the surround mode is off, the setting of D. RANGE COMPRESSION is set to ON automatically.



Speaker setting menu (SPK. SETTING)

Level menu (LEVEL)

FRONT LEFT SPEAKER/FRONT RIGHT SPEAKER/CENTER SPEAKER/SURROUND RIGHT SPEAKER/SURROUND LEFT SPEAKER

While monitoring the test tone, adjust the center and surround speakers volume as much as that of the front speakers. You can adjust the output level in the -6 dB to +6 dB range.

TEST TONE*

Outputs the test tone.

- * The test tone comes out of all of the activated speakers in the following sequence:
Front left speaker → Center speaker → Front right speaker → Surround right speaker → Surround left speaker → (back to the beginning)

NOTE

- For adjustment of subwoofer output level, see page 39.

Delay menu (DELAY)

FRONT LEFT SPEAKER/FRONT RIGHT SPEAKER/CENTER SPEAKER/SURROUND RIGHT SPEAKER/SURROUND LEFT SPEAKER

Adjust the distance from the listening position to the speakers. **Within the range from 0 ms to 15 ms (by 1 ms).**

Example:

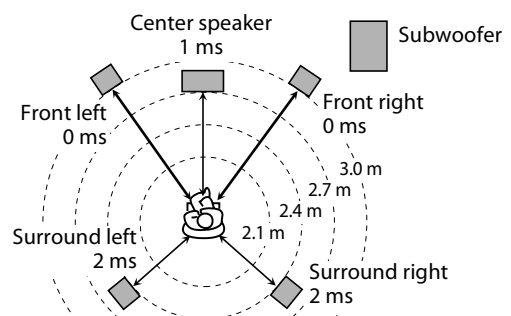

1 ms increase (or decrease) in delay time corresponds to about 30 cm decrease (or increase) in distance.

Set to "0 ms" for the furthest speaker from your position as the basis for the delay time setting.

In this case, set the delay time of each speaker as follows;

- Delay time of front speakers: 0 ms
- Delay time of center speaker: 1 ms
- Delay time of surround speakers: 2 ms

Setting DVD preferences

■ Subwoofer menu (SUBWOOFER)

LEVEL

You can set the output level of the subwoofer in the -6 dB to +6 dB range.

CROSS OVER

The signals below the preset frequency level will be sent to and be reproduced by the subwoofer.
Select one of the crossover frequency levels according to the size of the small speaker connected.

For TH-C90	For TH-C60/ TH-C20	Size of the cone speaker unit built in the speaker
80Hz	120Hz	8 cm
100Hz	150Hz	6 cm
120Hz	200Hz	5 cm

Tuner operations

IMPORTANT

Before using the remote control for the following operation;

- 1 Set the remote control mode selector to AUDIO.
- 2 Press FM/AM.

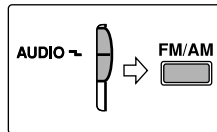

The buttons described below are used on pages 39 and 40.

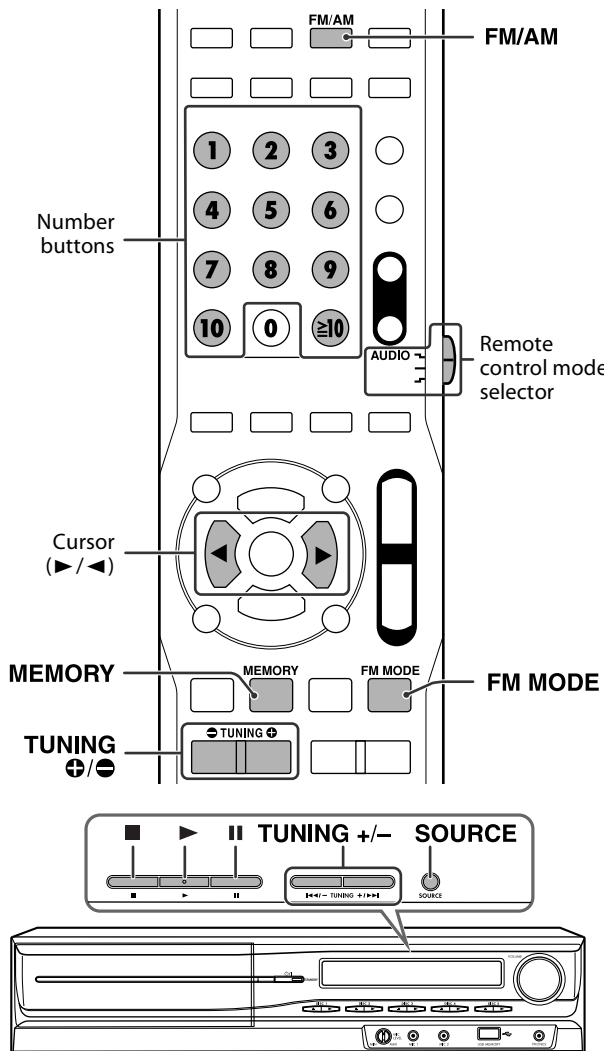

🔧 : Other setting menu (OTHERS)

■ RESUME

You can activate or deactivate Resume Playback function. (See page 31.)

■ ON SCREEN GUIDE

You can activate or deactivate the on-screen guide icons. (See page 22.)

■ DivX registration menu (DivX REGISTRATION)

The system has its own Registration Code for DivX playback. You can confirm the code of your system.

- Once you play back a disc created by using the Registration Code, the system's code is overwritten by a totally different new one for copyright protection purpose.

Setting the AM tuner interval spacing

Some countries space AM stations 9 kHz apart, and some countries use 10 kHz spacing.

You can only change the AM tuner interval spacing while selecting AM as the band.

On the center unit ONLY:

- To change the interval spacing into 10 kHz
Press II while holding down ■.
- To change the interval spacing into 9 kHz
Press ► while holding down ■.

Manual tuning

On the remote control:

- 1 Press FM/AM repeatedly to select the band.

Example: When the system is tuned in to AM 810 kHz.

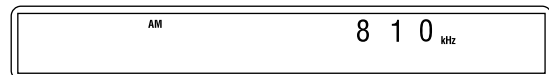

- 2 Press TUNING ⊕/⊖ repeatedly until you find the frequency you want.

When you hold down the button until the system starts searching for stations and then release it, the system stops searching automatically when a station of sufficient signal strength is tuned in to.

On the center unit:

- 1 Press SOURCE repeatedly to select the band (FM or AM).
- 2 Press TUNING +/- repeatedly until you find the frequency you want.

NOTE

- When an FM stereo program is received, the ST indicator lights on the display window.

Preset tuning

Once a station is assigned to a channel number, the station can be quickly tuned in. You can preset 30 FM and 15 AM stations.

■ To preset the stations

1 Tune in the station you want to preset.

- If you want to store the FM reception mode for an FM station, select the reception mode you want. See “Selecting the FM reception mode” on the right column.

Example: When the system is tuned in to FM 103.50 MHz.

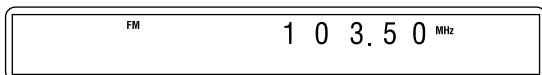

2 Press MEMORY.

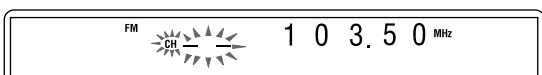

While “CH” and “_ _” are flashing:

3 Press number button(s) (1-10, ≥ 10) to select a preset number you want.

- For details on using the number buttons, see “How to use the number buttons”. (See page 24.)

Example: When the preset channel 1 is selected.

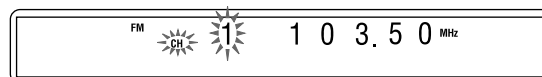

If the setting is canceled before you finish, start from step 2 again.

While the selected number is flashing:

4 Press MEMORY.

“STORED” appears on the display window.

The station is assigned to the selected preset number.

If the setting is canceled before you finish, start from step 2 again.

5 Repeat steps 1 to 4.

- Storing a new station to a used number erases the previously stored one.

■ To tune in to a preset station

1 Press FM/AM repeatedly to select FM or AM.

2 Press number button(s) (1-10, ≥ 10) to select a preset number.

- For details on using the number buttons, see “How to use the number buttons”. (See page 24.)

NOTE

- You can also select a preset number by pressing Cursor ►/◀.

Selecting the FM reception mode

When the stereo FM program currently tuned in is noisy, you can change the FM reception mode to improve the reception.

- While listening to an FM station

Press FM MODE.

The FM reception mode appears on the display window.

Each time you press the button, the FM reception mode changes.

- **AUTO:**
When a program is broadcast in stereo, you will hear stereo sound. (The ST indicator lights on the display window.) When in monaural, you will hear monaural sound. This mode is also useful to suppress static noise between stations.
- **MONO:**
Reception will be improved although you will lose the stereo effect. (The MONO indicator lights on the display window.) In this mode, you will hear noise until you are tuned in to a station.

Reducing the noise of AM broadcast

When listening to an AM broadcast with a lot of noise interference, you can change the Beat Cut mode to reduce the noise.

- While listening to an AM station

Press FM MODE.

The current Beat Cut mode appears on the display window.

Each time you press the button, the Beat Cut mode changes.

- Choose “BEATCUT1” or “BEATCUT2” according to which gives clearer sound.

Karaoke operations

- The icon such as  shows the disc formats or file types the operation is available for.

IMPORTANT

Before using the remote control for the following operation;

- Set the remote control mode selector to AUDIO.

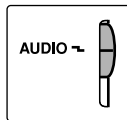

The buttons described below are used on pages 41 to 43.

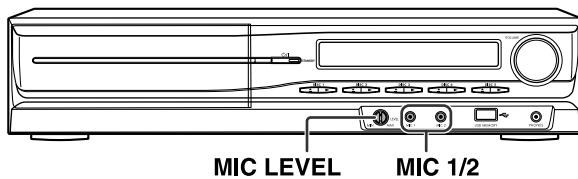
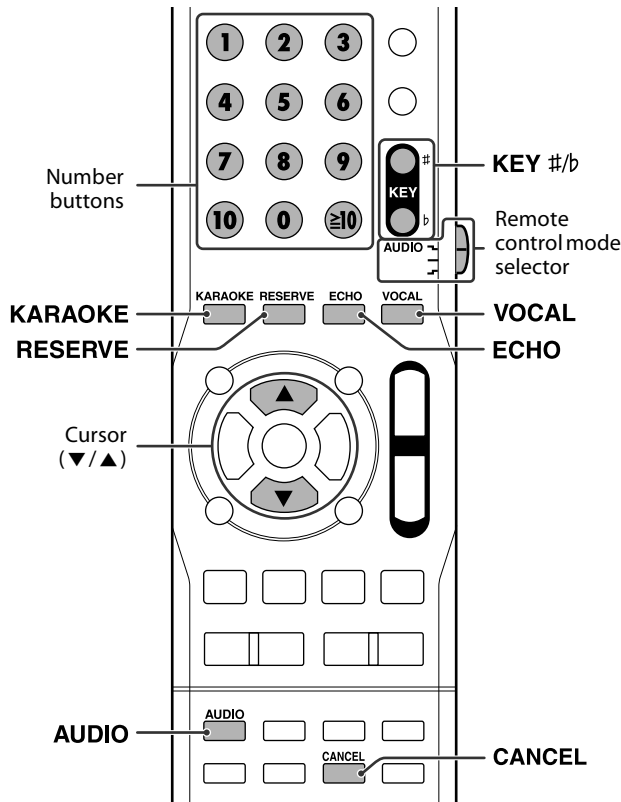

Basic Karaoke operations

1 Connect a microphone to MIC 1 or MIC 2 on the center unit.



2 Press KARAOKE to activate Karaoke function.

The  indicator lights on the display window.

3 Start playback.

- To select audio channels for Karaoke disc (except CD and MP3/WMA disc), see page 42.
- To enjoy Karaoke with a normal disc (containing no multiplex audio or multisound Karaoke audio, etc.) by masking the vocal recorded on the disc, see page 43.

4 Turn MIC LEVEL to adjust the microphone's volume.

- This control adjusts the output volume of both MIC 1 and MIC 2 together.

5 Sing along with the playback of the song.

- To add an echo effect to your voice, see page 43.
- To shift the pitch of the playback sound, see page 43.

To turn off Karaoke function

Press KARAOKE so that  disappears from the display window.

To repeat a disc/chapter/title/track during Karaoke mode

Set the Repeat mode. See "Repeat Playback". (See page 35.)

To enjoy Karaoke using a menu screen

See "Playing from a specified position on a disc". (See page 29.)

NOTE

- While playback is paused, no sound (voice) through the microphone is heard from the speakers. When the headphones are connected, there is a case that the sound (voice) through the microphone comes out from the headphones though playback is paused.
- Karaoke function is available only when the source is DVD.
- You cannot turn on Karaoke function while playing back a DVD AUDIO/DVD VR/JPEG/ASF/MPEG-2/MPEG-1/DivX disc.
- Karaoke function will be canceled by following operations;
 - Changing the source (See page 19.)
 - Playing back a DVD AUDIO/DVD VR/JPEG/ASF/MPEG-2/MPEG-1/DivX disc
- When Karaoke function is on, the surround mode (see page 26) is canceled.

Reserving songs

You can reserve your desired songs (groups/titles and tracks/chapters) to play in the order of your choice.

Up to 12 songs can be reserved with this function.

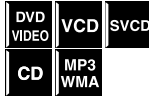

- While stopped with Karaoke function is turned on

1 Press RESERVE.

The reservation list appears on the TV screen.

2 Press number buttons (0-10, ≥ 10) to select the song you want to reserve by specifying the disc, group/title, and track/chapter numbers.

- Press the number buttons to select a song in the following order:
 - Select a disc.
 - Select a title/group.
 - Select a chapter/track.

No	Disc	Gr/Tt	Tr/Chap
1	2	1	2
2	1	2	14
3	4	1	20
4			
5			

- For details on using the number buttons, see "How to use the number buttons". (See page 24.)

To erase a reserved song

Press Cursor $\blacktriangledown/\blacktriangle$ to select the reservation number of unwanted song, then press CANCEL.

To add a song to the reservation list

Press Cursor $\blacktriangledown/\blacktriangle$ to select the reservation number of the song before which you want to insert a new song, then specify a new song by repeating step 2.

3 Repeat step 2 to reserve the rest of your selection.

4 Start playback of the reserved songs.

To hide or show the reservation list

Press RESERVE. Each time you press RESERVE, the reservation list disappears/appears from/on the TV screen.

NOTE

- While the reservation list is not displayed on the TV screen, you cannot start playback of the reserved songs. Be sure to press RESERVE to display the reservation list before you start playback.
- You can additionally reserve a song after the current playing reserved song. In such a case, press \blacksquare and perform the procedure from step 2 through 4.

Selecting audio

Most Karaoke discs have the capability of adding "Guide vocal" or "Guide melody" to the Karaoke accompaniment.

Selecting audio channel(s) [AUDIO]

With most Karaoke discs, you can select audio channel(s) among some options called "with guide vocal", "with guide melody", and "accompaniment only", etc. to enjoy Karaoke to your preference.



- During playback

1 Press AUDIO.

The following indication appears on the TV screen.

Example for a VCD:



2 Press AUDIO repeatedly or press Cursor $\blacktriangledown/\blacktriangle$ repeatedly to select the desired audio channel.

Each time you press AUDIO, audio channel changes as follows:

Example for a VCD:

- ST: To listen to L (left) and R (right) audio channel.
- L: To listen to L (left) audio channel.
- R: To listen to R (right) audio channel.

Masking the vocal recorded on a normal disc [VOCAL MASK]

You can enjoy Karaoke with a normal disc (containing no multiplex audio or multisound Karaoke audio, etc.) by attenuating the frequencies around a human voice with this function.



■ During playback with Karaoke function turned on

Press VOCAL.

Each time you press VOCAL, vocal mask function turns on and off alternately.

NOTE

- The voice may not be masked enough with some discs.

Adding an echo effect to your voice

■ During playback with Karaoke function turned on



Press ECHO repeatedly to select the desired effect level.

“ECHO” and its value appear on the display window.

- Each time you press ECHO, vocal option changes as follows;

OFF → 1 → 2 → 3 → (back to the beginning)

- As the number increases, the effect will be emphasized.

To cancel the sound effect

Select “OFF” in the procedure above.

Shifting the pitch of the playback sound

You can sharp/flat the pitch of a song recorded on a disc by a half-tone interval to match your voice range. Note that this setting is applied only to the current title/track.

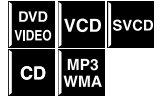

■ During playback with Karaoke function turned on

Press KEY #/b repeatedly to adjust the pitch (-6 to +6).

- Press KEY # to sharp and KEY b to flat the pitch.
- For DVD VIDEO/VCD/SVCD/CD, the following indication appears when pressing KEY #/b.

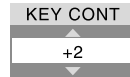

- For MP3/WMA, the following indication is shown in the file control display.



To return to normal playback

Select “0” in the procedure above.

NOTE

- Depending on the type of the recorded source (such as a DTS Digital Surround software, etc.), you may not be able to shift the pitch.

Maintenance

■ Handling Discs

- Remove the disc from its case by holding it at the edge while pressing the center hole lightly.
- Do not touch the shiny surface of the disc or bend the disc.
- Put the disc back in its case after use to prevent warping.
- Be careful not to scratch the surface of the disc when placing it back in its case.
- Avoid exposure to direct sunlight, extreme temperature and moisture.



To clean the disc

Wipe the disc with a soft cloth in a straight line from center to edge.

- **DO NOT use any solvent — such as conventional record cleaner, spray, thinner or benzine — to clean the disc.**



■ Cleaning the system

- Stains on the system should be wiped off with a soft cloth. If the system is heavily stained, wipe it with a cloth soaked in water-diluted neutral detergent and wrung well, then wipe clean with a dry cloth.
- Since the system may deteriorate in quality, become damaged or get its paint peeled off, be careful about the following.
 - DO NOT wipe it with a hard cloth.
 - DO NOT wipe it forcefully.
 - DO NOT wipe it with thinner or benzine.
 - DO NOT apply any volatile substance such as insecticides to it.
 - DO NOT allow any rubber or plastic to remain in contact with it for a long time.

Troubleshooting

PROBLEM	POSSIBLE CAUSE	SOLUTION
Power does not come on.	The power cord and/or system cord is not connected.	Connect the power cord and system cord correctly. (See pages 14 and 15.)
The remote control does not work.	The batteries are exhausted.	Replace the batteries. (See page 7.)
	Sunlight is shining directly on the remote sensor.	Hide the remote sensor from direct sunlight.
No sound.	The system cord and/or speaker cord is not connected.	Check the connection.
	The audio cord is not connected to AUX IN (VCR), TAPE IN (only for TH-C90) and/or DIGITAL IN (DBS) correctly.	Connect the cord correctly. (See page 14.)
	An incorrect source has been selected.	Select the correct source. (See page 19.)
No picture is displayed on the TV screen.	The video cord is not connected correctly.	Connect the cord correctly. (See page 13.)
	The disc or file is not playable.	Use a playable disc or file. (See pages 3 and 4.)
No picture is displayed on the TV screen, the picture is blurred, or the picture is divided into two parts.	The scan mode is set to the progressive mode ("NT. 480P" or "PAL. 576P") though the center unit is connected to the TV which does not support the progressive video input such as a conventional TV.	Change the scan mode to the interlace mode ("NT. 480I" or "PAL. 576I"). (See page 20.)
Video and audio are distorted.	The disc is scratched or dirty.	Replace or clean the disc.
	A VCR is connected between the center unit and the TV.	Connect the center unit and TV directly. (See page 13.)
The picture does not fit the TV screen.	The monitor type is not set correctly.	Set "MONITOR TYPE" properly. (See page 38.)
The broadcast is hard to hear because of noise.	Antennas are disconnected.	Reconnect the antennas correctly and securely. (See page 8.)

If there are any other cases than the noted above or if this system does not seem to work properly, turn off the system and turn it back on.

Specifications

■ Center unit (XV-THC90/XV-THC60/XV-THC20)

Audio section

Digital input*¹:

DIGITAL IN (DBS): -21 dBm to -15 dBm
(OPTICAL) (660 nm ±30 nm)

*¹ Corresponding to Linear PCM, Dolby Digital, and DTS Digital Surround (with sampling frequency — 32 kHz, 44.1 kHz, 48 kHz)

Analog input: AUX IN (VCR)
TAPE IN (Only for XV-THC90)
Analog output: TAPE OUT (Only for XV-THC90)

Video section

Video System: PAL/NTSC

Horizontal Resolution: 500 lines

Signal-to-Noise Ratio: 64 dB

Video output level

Composite: 1.0 V(p-p)/75 Ω
S-video-Y: 1.0 V(p-p)/75 Ω
S-video-C: For PAL: 0.3 V(p-p)/75 Ω
For NTSC: 0.286 V(p-p)/75 Ω

Component-Y: 1.0 V(p-p)/75 Ω

Component-Pb/Pr: 0.7 V(p-p)/75 Ω

Video input sensitivity/Impedance (VCR IN)

Composite: 1.0 V(p-p)/75 Ω
S-video-Y: 1.0 V(p-p)/75 Ω
S-video-C: For PAL: 0.3 V(p-p)/75 Ω
For NTSC: 0.286 V(p-p)/75 Ω

USB storage

USB specification: Compatible with the USB 2.0 Full-Speed

Compatible device: Mass Storage Class

Compatible file system: FAT16, FAT32

Bus power supply: Max. 500 mA

Tuner section

Tuning Range

FM: 87.50 MHz to 108.00 MHz
At 10 kHz intervals
AM: 530 kHz to 1 710 kHz (*1 600 kHz)
At 9 kHz intervals
531 kHz to 1 710 kHz (*1 602 kHz)

* For the countries of the Middle East

General

Power Requirements: AC 110 - 240 V ~, 50/60 Hz

Power Consumption: 25 W (at operation)
1.2 W (in standby mode)

Dimensions (W × H × D): 400 mm × 85 mm × 316 mm
Mass: 3.8 kg

■ Subwoofer (SP-PWC90)

Amplifier section

Front/Center/Surround: 140 W per channel, RMS at 4 Ω at 1 kHz, with 10 % total harmonic distortion.

Subwoofer: 300 W, RMS at 4 Ω at 40 Hz, with 10 % total harmonic distortion.

Speaker section

Speaker unit: 25 cm Bass-reflex

Power Handling Capacity: 300 W

Impedance: 4 Ω

Frequency Range: 25 Hz to 200 Hz

Sound Pressure Level: 74 dB/W·m

General

Power Requirements: AC 110 V/ AC 127 V/
AC 220 - 240 V ~, 50/60 Hz

Power Consumption: 110 W (at operation)
0 W (in standby mode)

Dimensions (W × H × D): 264 mm × 481 mm × 459 mm
Mass: 17.6 kg

■ Subwoofer (SP-PWC60)

Amplifier section

Front/Center/Surround: 135 W per channel, RMS at 4 Ω at 1 kHz, with 10 % total harmonic distortion.

Subwoofer: 135 W, RMS at 4 Ω at 100 Hz, with 10 % total harmonic distortion.

Speaker section

Speaker unit: 16 cm Bass-reflex

Power Handling Capacity: 140 W

Impedance: 4 Ω

Frequency Range: 30 Hz to 200 Hz

Sound Pressure Level: 75 dB/W·m

General

Power Requirements: AC 110 V/ AC 127 V/
AC 220 - 240 V ~, 50/60 Hz

Power Consumption: 135 W (at operation)
0 W (in standby mode)

Dimensions (W × H × D): 171 mm × 411 mm × 458 mm
Mass: 12.3 kg

■ Subwoofer (SP-PWC20)

Amplifier section

Front/Center/Surround: 135 W per channel, RMS at 4 Ω at 1 kHz, with 10 % total harmonic distortion.

Subwoofer: 135 W, RMS at 4 Ω at 100 Hz, with 10 % total harmonic distortion.

Speaker section

Speaker unit: 16 cm Bass-reflex

Power Handling Capacity: 140 W

Impedance: 4 Ω

Frequency Range: 30 Hz to 200 Hz

Sound Pressure Level: 74 dB/W·m

General

Power Requirements: AC 110 V/ AC 127 V/
AC 220 - 240 V ~, 50/60 Hz

Power Consumption: 135 W (at operation)
0 W (in standby mode)

Dimensions (W × H × D): 170 mm × 411 mm × 458 mm
Mass: 11.5 kg

■ Satellite Speakers — SP-XTHC90

Front speakers (SP-THC90F)

Type:	2-way 3-speaker Bass reflex type (Magnetically shielded Type)
Speaker:	13.5 cm cone × 2 6.0 cm cone × 1
Power Handling Capacity:	140 W
Impedance:	4 Ω
Frequency Range:	60 Hz to 20 000 Hz
Sound Pressure Level:	89 dB/W·m
Dimensions (W × H × D):	270 mm × 1 027.5 mm × 320 mm
Mass:	8.8 kg each

Center speaker (SP-THC90C)

Type:	2-way 3-speaker Bass reflex type (Magnetically shielded Type)
Speaker:	10.5 cm cone × 2 4.0 cm cone × 1
Power Handling Capacity:	140 W
Impedance:	4 Ω
Frequency Range:	65 Hz to 20 000 Hz
Sound Pressure Level:	89 dB/W·m
Dimensions (W × H × D):	400 mm × 141 mm × 171.5 mm
Mass:	3.8 kg

Surround speakers (SP-THC90S)

Type:	2-way Bass reflex type
Speaker:	10.5 cm cone × 1 4.0 cm cone × 1
Power Handling Capacity:	140 W
Impedance:	4 Ω
Frequency Range:	75 Hz to 20 000 Hz
Sound Pressure Level:	81 dB/W·m
Dimensions (W × H × D):	140 mm × 228.5 mm × 174 mm
Mass:	1.7 kg each

■ Satellite Speakers — SP-XTHC60

Front speakers (SP-THC60F)

Type:	1-way 2-speaker Bass reflex type (Magnetically shielded Type)
Speaker:	5.5 cm cone × 2
Power Handling Capacity:	140 W
Impedance:	4 Ω
Frequency Range:	100 Hz to 20 000 Hz
Sound Pressure Level:	79 dB/W·m
Dimensions (W × H × D):	280 mm × 1 106 mm × 280 mm
Mass:	3.3 kg each

Center speaker (SP-THC60C)

Type:	1-way 2-speaker Bass reflex type (Magnetically shielded Type)
Speaker:	6.5 cm cone × 2
Power Handling Capacity:	140 W
Impedance:	4 Ω
Frequency Range:	90 Hz to 20 000 Hz
Sound Pressure Level:	82 dB/W·m
Dimensions (W × H × D):	250 mm × 85 mm × 91 mm
Mass:	0.8 kg

Surround speakers (SP-THC60S)

Type:	2-way 3-speaker Bass reflex type
Speaker:	5.5 cm cone × 2 3.0 cm dome × 1
Power Handling Capacity:	140 W
Impedance:	4 Ω
Frequency Range:	100 Hz to 20 000 Hz
Sound Pressure Level:	79 dB/W·m
Dimensions (W × H × D):	280 mm × 1 114 mm × 280 mm
Mass:	3.4 kg each

■ Satellite Speakers — SP-XTHC20

Front speakers (SP-THC20F)

Type:	1-way Bass reflex type (Magnetically shielded Type)
Speaker:	8.0 cm cone × 1
Power Handling Capacity:	140 W
Impedance:	4 Ω
Frequency Range:	90 Hz to 20 000 Hz
Sound Pressure Level:	78 dB/W·m
Dimensions (W × H × D):	106 mm × 119.5 mm × 102 mm
Mass:	0.55 kg each

Center speaker (SP-THC20C)

Type:	1-way Bass reflex type (Magnetically shielded Type)
Speaker:	8.0 cm cone × 1
Power Handling Capacity:	140 W
Impedance:	4 Ω
Frequency Range:	90 Hz to 20 000 Hz
Sound Pressure Level:	78 dB/W·m
Dimensions (W × H × D):	106 mm × 119.5 mm × 102 mm
Mass:	0.55 kg

Surround speakers (SP-THC20S)

Type:	1-way Bass reflex type
Speaker:	8.0 cm cone × 1
Power Handling Capacity:	140 W
Impedance:	4 Ω
Frequency Range:	90 Hz to 20 000 Hz
Sound Pressure Level:	76 dB/W·m
Dimensions (W × H × D):	106 mm × 119.5 mm × 102 mm
Mass:	0.63 kg each

Designs & specifications are subject to change without notice.

Mains (AC) Line Instruction

VOLTAGE SELECTOR

For SP-PWC90

CAUTION for mains (AC) line

BEFORE PLUGGING IN, do check that your mains (AC) line voltage corresponds with the position of the voltage selector switch provided on the outside of this equipment and, if different, reset the voltage selector switch, to prevent from a damage or risk of fire/electric shock.

VOLTAGE SELECTOR

220V
240V 127V 110V

For SP-PWC60/
SP-PWC20

JVC

Free Manuals Download Website

<http://myh66.com>

<http://usermanuals.us>

<http://www.somanuals.com>

<http://www.4manuals.cc>

<http://www.manual-lib.com>

<http://www.404manual.com>

<http://www.luxmanual.com>

<http://aubethermostatmanual.com>

Golf course search by state

<http://golfingnear.com>

Email search by domain

<http://emailbydomain.com>

Auto manuals search

<http://auto.somanuals.com>

TV manuals search

<http://tv.somanuals.com>