

JVC



DVD DIGITAL CINEMA SYSTEM SYSTEMA DVD DIGITAL CINEMA SISTEMA DE CINEMA DE DVD DIGITAL

TH-A9

Consists of XV-THA9, SP-PWA9, SP-XCA9, and SP-XSA9
Consta de XV-THA9, SP-PWA9, SP-XCA9, y SP-XSA9
Consiste em XV-THA9, SP-PWA9, SP-XCA9, e SP-XSA9

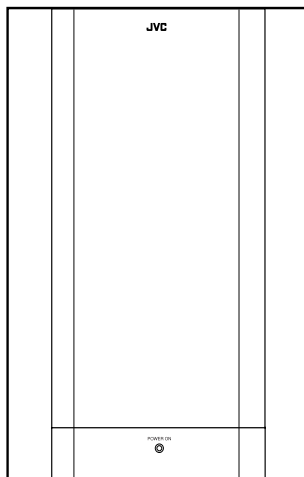

SP-PWA9

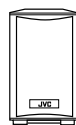

SP-XSA9

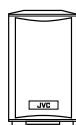

SP-XCA9

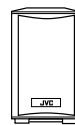
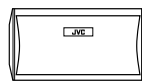

SP-XSA9

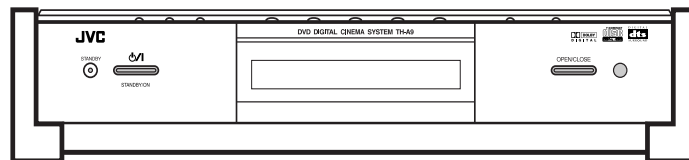

XV-THA9

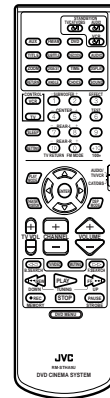

MPEG 1/2 Multichannel

INSTRUCTIONS INSTRUCCIONES INSTRUÇÕES

For Customer Use:

Enter below the Model No. and Serial No. which are located either on the rear, bottom or side of the cabinet. Retain this information for future reference.

Model No. _____

Serial No. _____

LVT0562-010A
[UW]

Warnings, Cautions and Others

Avisos, Precauciones y otras notas

Advertências, precauções e outras notas

Caution - ⏻/I button!

Disconnect the XV-THA9 and SP-PWA9 main plugs to shut the power off completely. The ⏻/I button on the XV-THA9 in any position do not disconnect the mains line. The power can be remote controlled.

Precaución – Botón ⏻/I !

La forma de desconectar completamente el suministro eléctrico para el XV-THA9 y el SP-PWA9 es desenchufándolo de la red. El apagado mediante el botón ⏻/I mantiene una conexión de tensión que permite el encendido del XV-THA9 utilizando el mando a distancia.

Precaução - botão ⏻/I !

Desconecte os plugues principais XV-THA9 e SP-PWA9 para desligar completamente a energia. O botão ⏻/I no XV-THA9, em qualquer posição, não desconecte o cabo de alimentação. A energia pode ser controlada à distância.

CAUTION

To reduce the risk of electrical shocks, fire, etc.:

1. Do not remove screws, covers or cabinet.
2. Do not expose this appliance to rain or moisture.

PRECAUTION

Para reducir el riesgo de descargas eléctricas, fuego, etc.:

1. No quitar los tornillos, tapas o caja.
2. No exponer el aparato a la lluvia ni a la humedad.

PRECAUÇÃO

Para reduzir o riscos de choques eléctricos, incêndio, etc.:

1. Não retire parafusos nem desmonte as tampas ou o gabinete.
2. Não exponha este aparelho à chuva nem à umidade.

CAUTION

- Do not block the ventilation openings or holes. (If the ventilation openings or holes are blocked by a newspaper or cloth, etc., the heat may not be able to get out.)
- Do not place any naked flame sources, such as lighted candles, on the apparatus.
- When discarding batteries, environmental problems must be considered and local rules or laws governing the disposal of these batteries must be followed strictly.
- Do not use this apparatus in a bathroom or places with water. Also do not place any containers filled with water or liquids (such as cosmetics or medicines, flower vases, potted plants, cups, etc.) on top of this apparatus.

PRECAUCIÓN

- No obstruya las rendijas o los orificios de ventilación. (Si las rendijas o los orificios de ventilación quedan tapados con un periódico, un trozo de tela, etc., no se podrá disipar el calor).
- No ponga sobre el aparato ninguna llama al descubierto, como velas encendidas.
- Cuando tenga que descartar las pilas, tenga en cuenta los problemas ambientales y observe estrictamente los reglamentos o las leyes locales sobre disposición de las pilas.
- No utilice este aparato en el cuarto de baño o en lugares donde hay agua. Tampoco coloque ningún recipiente que contenga agua u otros líquidos (frascos de cosméticos o medicinas, floreros, macetas, vasos, etc.) encima de este aparato.

AVISO

- Não obstrua as aberturas e orifícios de ventilação. (Se os orifícios ou aberturas de ventilação estiverem obstruídos por qualquer papel ou tecido, não haverá circulação do ar quente.)
- Não coloque nenhum objeto com chamas, como velas acesas, sobre o aparelho.
- Ao descartar as baterias, leve em consideração os problemas que possam ser causados ao meio ambiente e os regulamentos e leis locais e governamentais sobre recolhimento dessas baterias devem ser rigorosamente seguidos.
- Não utilize este aparelho em banheiros ou em locais com água. Além disso, não coloque nenhum recipiente com água ou qualquer tipo de líquido (como cosméticos ou remédios, vasos com flores, plantas, xícaras, etc.) sobre o aparelho.

Caution: Proper Ventilation

To avoid risk of electric shock and fire and to protect from damage. Locate the apparatus as follows:

- Front: No obstructions and open spacing.
- Sides: No obstructions in 3 cm from the sides.
- Top: No obstructions in 5 cm from the top.
- Back: No obstructions in 15 cm from the back.
- Bottom: No obstructions, place on the level surface.

Precaução: ventilação apropriada

Para prevenir o risco de choque elétrico ou incêndio e para proteger o aparelho contra danos. Localize-o da seguinte maneira:

- Frente: Espaço aberto, sem obstruções
- Lados: Espaço de 3 cm sem obstruções nos lados
- Topo: Espaço de 5 cm sem obstruções acima
- Atrás: Espaço de 15 cm sem obstruções atrás
- Parte inferior: Sem obstruções. Coloque o aparelho em superfície nivelada.

Precaución: Ventilación Adecuada

Para evitar el riesgo de choque eléctrico e incendio y para proteger el aparato contra daños.

Ubique el aparato de la siguiente manera:

- Frente: Espacio abierto sin obstrucciones
- Lados: 3 cm sin obstrucciones a los lados
- Parte superior: 5 cm sin obstrucciones en la parte superior
- Parte trasera: 15 cm sin obstrucciones en la parte trasera
- Fondo: Sin obstrucciones, colóquelo sobre una superficie nivelada

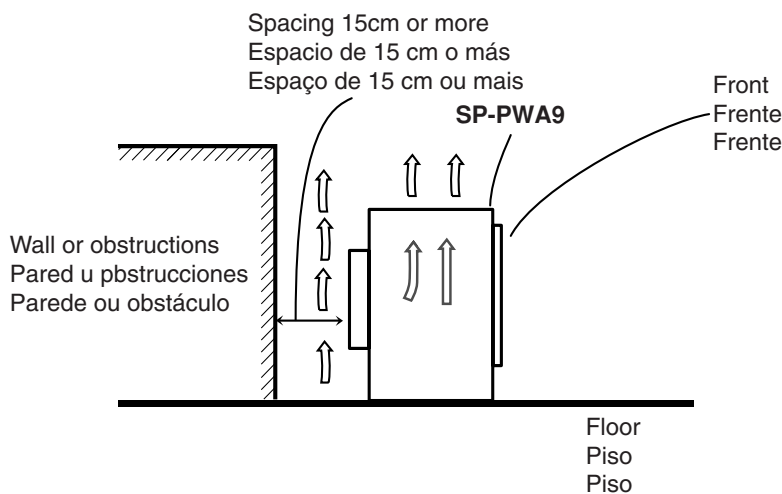
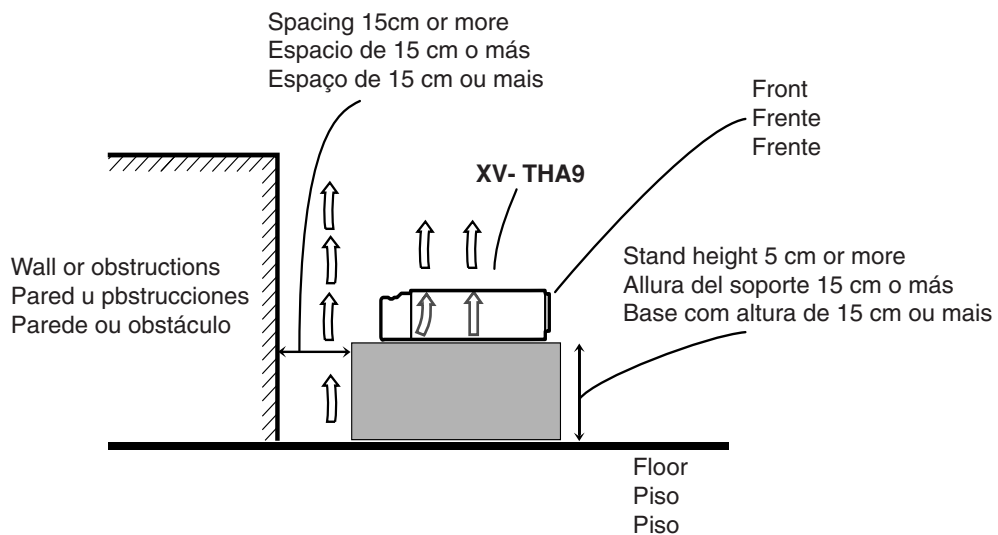

IMPORTANT FOR LASER PRODUCTS/IMPORTANTE PARA LOS PRODUCTOS LÁSER/IMPORTANTE PARA PRODUCTOS LASER

REPRODUCTION OF LABELS/REPRODUCCIÓN DE ETIQUETAS/REPRODUÇÃO, DE ETIQUETAS

- ① CLASSIFICATION MARK, PLACED ON REAR ENCLOSURE
- ① ETIQUETA DE CLASIFICACION, PROVISTA SOBRE LA SUPERFICIE EXTERIOR
- ① ETIQUETA DE CLASSIFICAÇÃO LOCALIZADA NA PARTE POSTERIOR DA CAIXA DO APARELHO.

- ② WARNING LABEL, PLACED INSIDE THE UNIT
- ② ETIQUETA DE ADVERTENCIA, PEGADA EN EL INTERIOR DE LA UNIDAD
- ② ETIQUETA DE ADVERTÊNCIA LOCALIZADA NA PARTE INTERNA DA UNIDADE

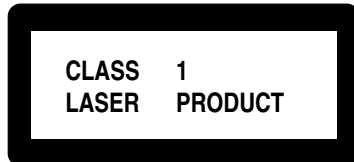

CAUTION: Invisible laser radiation when open and interlock failed or defeated. AVOID DIRECT EXPOSURE TO BEAM. (e)

ADVARSEL: Usynlig laserstråling ved åbning, når sikkerhedsafbrydere er ude af funktion. Undgå udsættelse for stråling (d)

WARNING: Osynlig laserstråling når denna del är öppnad och spårren är urkopplad. Betrakta ej strålen. (s)

VARO: Avattaessa ja suojalukitus ohitettaessa olet alttiina näkymättömälle lasersäteilylle. Älä katso säteeseen (f)

- 1. CLASS 1 LASER PRODUCT
- 2. **CAUTION:** Visible and invisible laser radiation when open and interlock failed or defeated. Avoid direct exposure to beam.
- 3. **CAUTION:** Do not open the top cover. There are no user serviceable parts inside the Unit; leave all servicing to qualified service personnel.

- 1. PRODUCTO LASER CLASE 1
- 2. **PRECAUÇÃO:** O laser emite uma radiação visível que é perigosa, caso o aparelho esteja aberto e a trava inoperante ou danificada. Evite exposição direta ao feixe dos raios.
- 3. **PRECAUÇÃO:** Não abra a caixa do aparelho. Não existem peças reparáveis pelo usuário na parte interna da unidade. Solicite assistência técnica somente a pessoal técnico qualificado.

- 1. PRODUCT LASER CLASE 1
- 2. **PRECAUCIÓN:** En el interior hay radiación láser visible. Evite el contacto directo con el haz.
- 3. **PRECAUCIÓN:** No abra la tapa superior. En el interior de la unidad no existen piezas reparables por el usuario; deje todo servicio técnico en manos de personal calificado.

Table of Contents

Getting Started.....	2	Repeating a current title, chapter or track, or all tracks [REPEAT]	34
Important cautions	2	Repeating a desired part [A-B REPEAT].....	35
Safety precautions	2	Programming the Playing Order [PROGRAM]	36
Checking the supplied accessories.....	2	Random Play [RANDOM]	37
System outline	3	To check the DVD function status	37
Installation.....	4	To check the disc information	38
To hang satellite speakers from the wall	4	To check the time information	38
About discs	5	Receiving radio broadcasts.....	40
Playable disc types.....	5	Setting the AM tuner interval spacing.....	40
Disc structure	5	Tuning in stations manually	40
Video CDs/SVCDs with Playback Control function.....	5	Using preset tuning.....	40
Connections	6	Selecting the FM reception mode.....	41
Connecting the FM and AM antennas	6	Beat cut.....	41
Connecting the powered sub-woofer	6	Preference settings	42
Connecting the TV	6	Using the preference setting menus.....	42
Connecting the TV with the component video input jacks...	7	LANGUAGE MENU settings	43
Connecting speakers	8	Choosing menu language	43
Connecting an audio component.....	9	Choosing audio language	43
Setting the VOLTAGE SELECTOR	10	Choosing subtitle language	43
Connecting the power cord.....	10	Choosing on-screen language.....	43
Putting batteries in the remote control.....	10	DISPLAY MENU settings.....	44
Parts Identification	11	Select monitor type.....	44
Principles of operation	14	Screen saver settings	44
Operation with the remote control	14	On-screen guide settings	44
On-screen displays.....	15	SYSTEM MENU setting	45
Preventing screen burn-out with the screen saver [SCREEN SAVER]	16	AUTO STANDBY	45
Basic operations	17	RESUME.....	45
To turn the system power supply ON and OFF (standby) ..	17	AV COMPULINK MODE.....	45
To turn TV power ON and OFF	17	Limiting playback by children	46
Adjusting volume [VOLUME].....	17	To set Parental Lock for the first time	
Sub-woofer volume control and phase setting.....	18	[PARENTAL LOCK].....	46
Muting the sound [MUTING].....	18	To temporarily release the Parental lock.....	47
Selecting the source to play	18	Amplifier settings.....	48
Changing the decode mode [DECODE]	19	Basic operation for setting amplifier.....	48
Audio channel display indicator	19	Setting balance	48
Using the Sleep Timer [SLEEP].....	20	Setting tone	49
Using the DSP Modes [DSP MODE].....	20	Setting speaker size	49
Using the DVD player	22	Adjusting delay time	49
To turn on the system and TV	22	Adjusting crossover.....	50
To insert a disc	22	Adjusting LFE attenuator	50
To play a disc.....	23	Adjusting dynamic range.....	50
Pausing.....	24	Sound settings	51
Fast forward and backward.....	24	Adjusting sub-woofer level	51
Locating the beginning	24	Adjusting speaker level	51
Resuming playback.....	25	Adjusting DSP effect.....	52
Selecting playback from the DVD menu	25	AV COMPU LINK remote control system.....	53
Selecting the location to view from the		Connection and setup	53
Video CD/SVCD menu	26	Operation	54
To specify the title, chapter, or track number for playback	26	Operating Other Manufacturers' Video	
To play from the beginning of a title, chapter, or track	27	Equipment.....	55
To specify the chapter number for playback [CHAP.		Care and handling of discs.....	57
SEARCH]	27	How to handle discs	57
To specify the time for playback [TIME SEARCH]	28	Troubleshooting	58
To select the screen for playback from the digest screen		Specifications	59
[DIGEST].....	29		
To advance the picture one frame at a time	29		
Slow-Motion Playback [SLOW]	30		
To display Continuous Photos [STROBE]	30		
Zooming a scene [ZOOM].....	31		
Changing the Subtitle Language [SUBTITLE]	31		
Changing the audio language or sound [AUDIO]	32		
Changing the audio channel [AUDIO]	32		
Viewing from Multiple Angles [ANGLE].....	33		
Selecting the Picture Character [THEATER POSITION] ..	34		

Getting Started

Important cautions

Installation of the unit

- Select a place which is level, dry and neither too hot nor too cold between 5°C and 35°C (41°F and 95°F).
- Leave sufficient distance between the unit and the TV.
- Do not use the unit in a place subject to vibrations.

Power cord

- Do not handle the power cord with wet hands!
- A small amount of power 1.9 W is always consumed while the power cord is connected to the wall outlet. (center unit only)
- When unplugging the unit from the wall outlet, always pull the plug, not the power cord.

To prevent malfunction of the unit

- There are no user-serviceable parts inside. If anything goes wrong, unplug the power cord and consult your dealer.
- Do not insert any metallic object into the unit.
- Do not use any non-standard shape disc available on the market, because it may damage the unit.
- Do not use a disc with tape, seals, or paste on it, because damage to the unit may result.

Note about the copyguard system

- The DVD disc is protected by the copyguard system. When you connect the unit to your VCR directly, the copyguard system activates and the picture may not be played back correctly.

Safety precautions

Avoid moisture, water and dust

Do not place your unit in moist or dusty places.

Avoid high temperatures

Do not expose the unit to direct sunlight or place it near a heating device.

When you're away

When away on travel or otherwise for an extended period of time, remove the plug from the wall outlet.

Do not block the vents

Blocking the vents may damage the unit.

Care of the cabinet

When cleaning the unit, use a soft cloth and follow the relevant instructions on the use of chemically-coated cloths. Do not use benzene, thinner or other organic solvents and disinfectants. These may cause deformation or discoloring.

If water gets inside the unit

Turn off the power switch and remove the plug from the wall outlet, then call the store where you made your purchase. Using the unit in this state may cause a fire or electrical shock.

Avoid getting your hand caught in the disc cover

Getting caught may injure your hand.

Checking the supplied accessories

Check to be sure you have all of the following items, which are supplied with the unit.

The number in the parentheses indicates quantity of the pieces supplied.



Remote control (1)

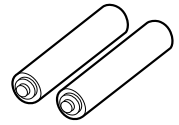

Batteries (2)

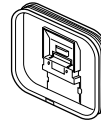

AM Loop Antenna (1)

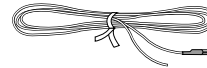

FM Antenna (1)

AC Power Cord (1)



Video Cable (1)

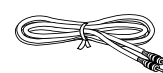

Compulink Cord (1)



System Cable (1)

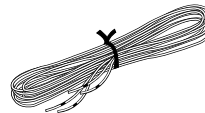

Speaker Cord 5 m (16.4 ft) (3)

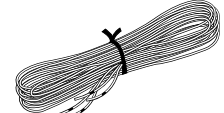

Speaker Cord 10m (32.8 ft) (2)

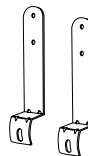

Satellite speaker wall bracket (2)*

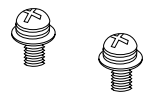

Plug Adapter (2)

Screws (2)*

* Speaker wall brackets and screws are packed together with the satellite speakers.

System outline

This system consists of the unit containing a DVD player, a radio, and a pre-amp, as well as the powered sub-woofer, the center speaker, and four satellite speaker units.

It provides a fully functional DVD theater system by simply connecting to a TV set.

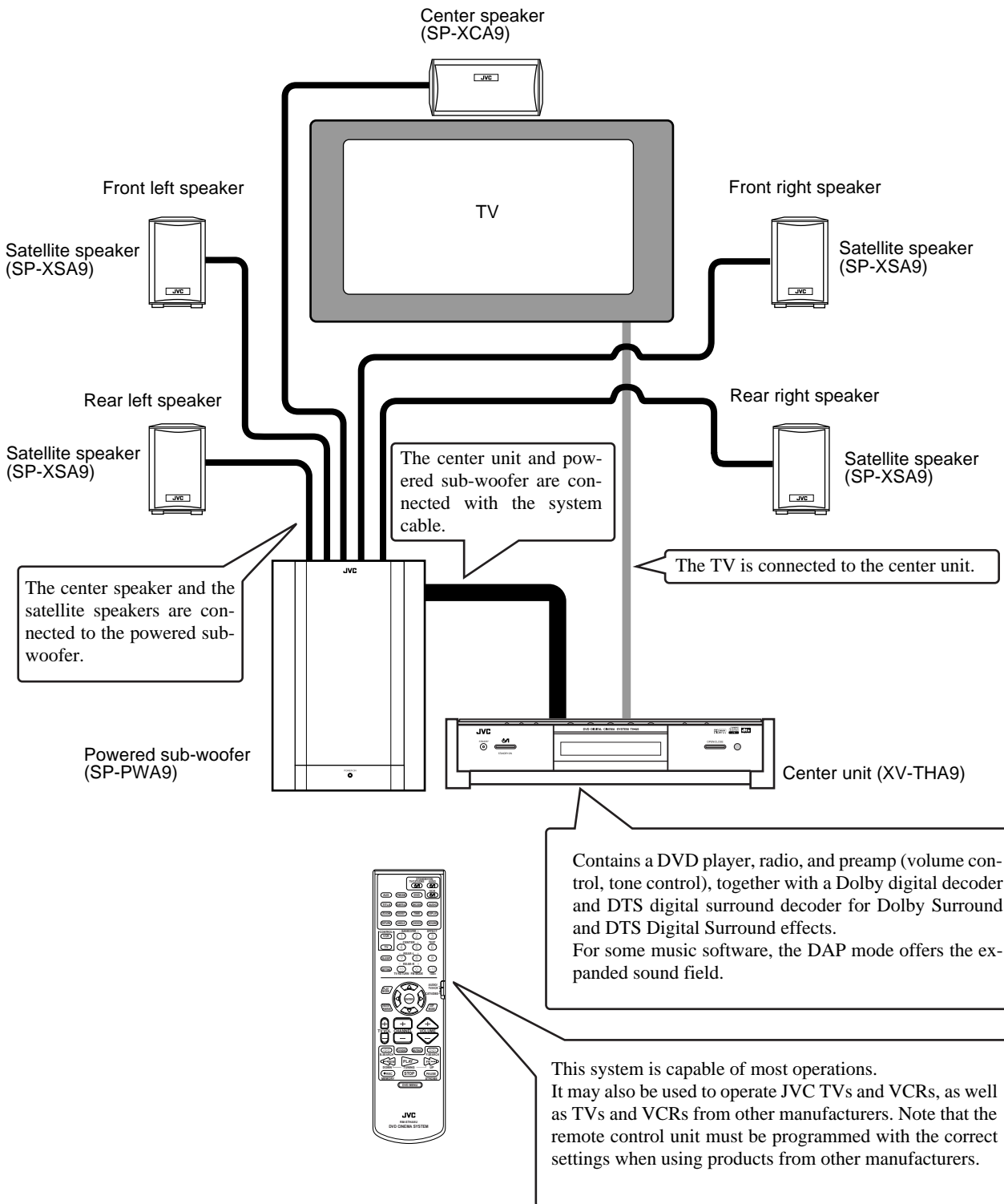

Installation

The following shows an example of the system installation.

System setting example

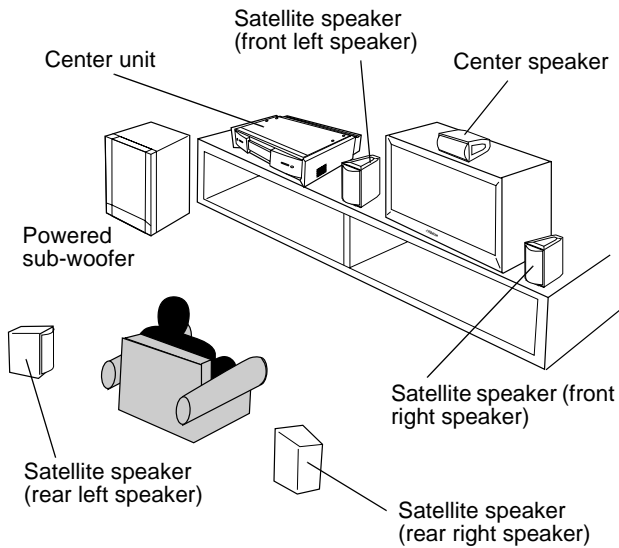

The rear speakers are placed behind the listening position.

CAUTIONS:

- For safety reasons, always ensure that there is sufficient place behind the powered sub-woofer.
- If the front and rear speakers are placed on the furniture etc., always ensure that they are level.

To hang satellite speakers from the wall

Use the supplied bracket to fix satellite speakers to the wall.

CAUTION: ATTACHING THE BRACKETS ON THE WALL

When attaching the brackets on the wall, have them attached to the wall by a qualified person.

DO NOT attach the brackets on the wall by yourself to avoid an unexpected damage of their falling from the wall, caused by incorrect attachment or weakness in the wall.

Location of attachment to wall:

Care is required in selecting a location for attaching satellite speakers to the wall. Injury to personnel, or damage to equipment, may result if the speakers are attached in a location which interferes with daily activities.

Attaching speakers to the bracket

- 1 Use the screw supplied to attach the speaker to the bracket.

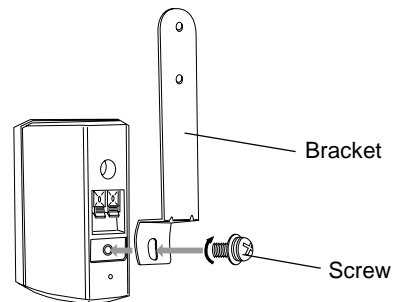

2 Adjusting the angle of the satellite speakers

The angle of the speaker may be adjusted along the channel in the bracket.

When adjusting the angle, loosen the screw slightly, make the adjustment, and then tighten the screw firmly.

Normal position

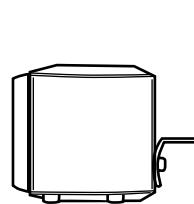

Tilting the speaker

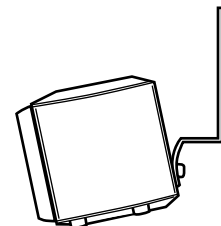

CAUTION:

If the screw is not tightened firmly, it may cause injury to personnel or damage to equipment.

Playable disc types

Playable and non-playable disc types are as follows:

Playable discs



DVD

The DVD Logo is a trademark.



Audio CD



SVCD



VIDEO CD



Non-playable discs

- DVD-ROM
- DVD-RAM
- DVD-R
- DVD-RW
- CD-R*
- CD-ROM
- PHOTO CD
- CD-RW*

* Audio formatted CD-R and CD-RW can be played.

- Playing back discs list as “Non-playable discs” above may generate noise and damage speakers.
- Only audio can be played for CD-G, CD-EXTRA and CD TEXT.

Notes on DVD discs

- DVD players and DVD discs have their own Region Code numbers. This unit only can play back DVD discs whose Region Code numbers include “4”.

Examples of playable DVD discs:



Disc structure

A DVD disc is comprised of “titles”, while an Audio CD, Video CD or SVCD is comprised of “tracks”. Each title may be divided into some “chapters”. For example, if a DVD disc contains some movies, each movie may have its own title number, and each movie may be divided into some chapters. In a DVD karaoke disc, each song usually has its own title number and does not have chapters. In general, each title has independent content, while each chapter in the same title has continuity.

Example: DVD disc

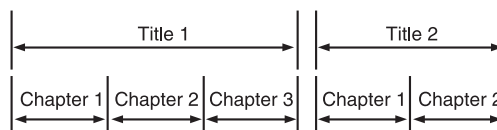

Example: Audio CD/Video CD/SVCD



Video CDs/SVCDs with Playback Control function

What is Playback Control function?

The Playback Control function, allows you to enjoy menu-driven operation and high-resolution still images which have a resolution four times greater than moving pictures.

• Menu-driven playback

You can interact with the screen using a menu display to select and play an entry.

• High-resolution still image display

You can display high-quality images four times clearer than moving pictures.

A selection menu is displayed when you start playing a Video CD or SVCD with the Playback Control feature. The selection menu shows a list of numbers for selection. Some discs may show moving pictures or a divided screen.

1. When a list of numbers is displayed, selecting a number shows its contents.
2. When “▶” or “SELECT” is displayed on the television screen, pressing this button jumps to the specific picture.
3. When the selection menu is re-displayed after you have played your selection, selecting a number again replays its contents. (Some discs may show the menu screen several times.)
When ▶▶ and ◀◀ are shown, pressing “NEXT” or “PREV” can change the selection menu.
4. After playback, press RETURN to go back to the previous screen.

To stop playback, press STOP.

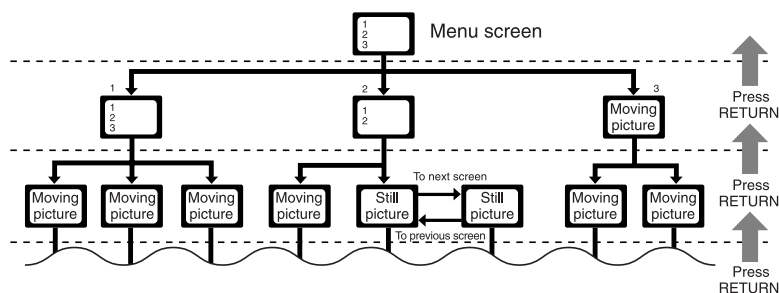

Note:

- When a menu is displayed for a long time (about ten minutes), the screen background automatically gets dark to prevent screen burn-in while the setting is suspended.

Connections

CAUTION:

- Make all connection before plugging the system in an AC outlet.

Connecting the FM and AM antennas

FM antenna connections

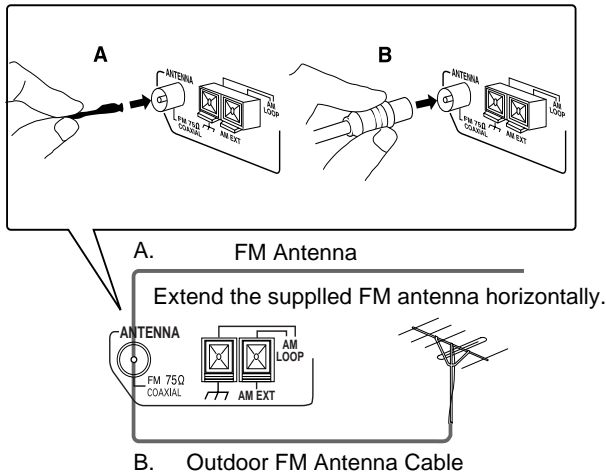

A. Using the supplied FM antenna

The FM antenna provided can be connected to the FM 75 Ω COAXIAL terminal as temporary measure.

B. Using the standard type connector (Not supplied)

A standard type connector should be connected to the FM 75 Ω COAXIAL terminal.

Note:

- If reception is poor, connect the outdoor antenna. Before attaching the 75 Ω coaxial cable (the kind with a round wire going to an outdoor antenna), disconnect the supplied FM antenna.

AM antenna connections

Turn the loop until you have the best reception.

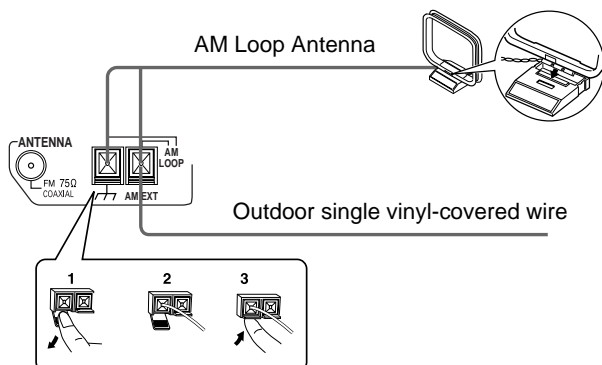

Notes:

- Make sure the antenna conductors do not touch any other terminals, connecting cords and power cord. This could cause poor reception.
- If reception is poor, connect an outdoor single vinyl-covered wire to the AM EXT terminal. (Keep the AM loop antenna connected.)

Connecting the powered sub-woofer

Use the supplied system cable to connect the powered sub-woofer (SP-PWA9).

Center unit (XV-THA9)

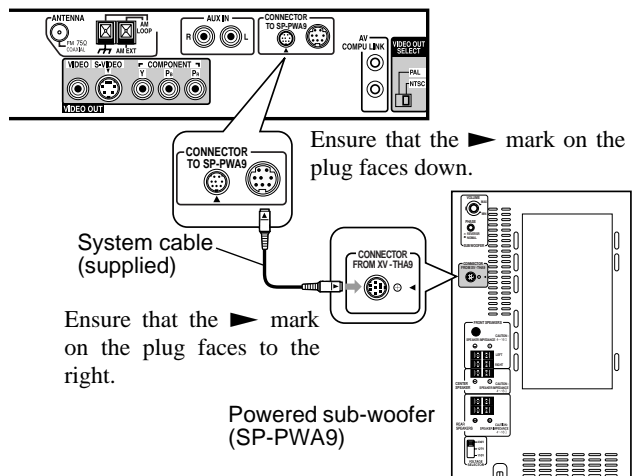

CAUTION:

Use the system cable provided for attaching the center unit and the sub-woofer.

Connecting the TV

Connect the TV to view video images from the unit.

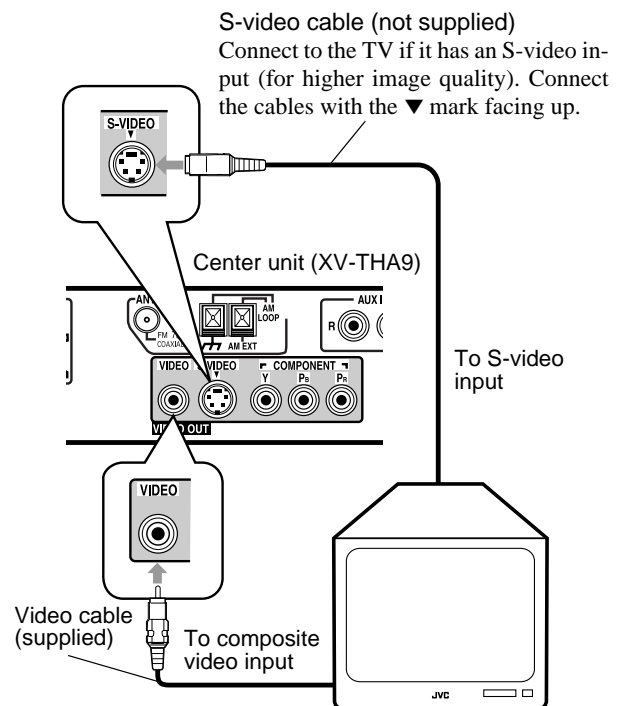

Selecting the color system:

The center unit is compatible with the PAL and NTSC systems. Set the VIDEO OUT SELECT switch on the rear panel to match the color system of your TV. Make sure that the color system of a DVD, Video CD, or SVCD disc labeled on the package matches your TV.

If you use a multi-system TV, you can play discs recorded on both PAL and NTSC systems.

* Refer to the illustration on page 7.

Connecting the TV with the component video input jacks

Connect the TV with the component video input jacks to view high quality picture.

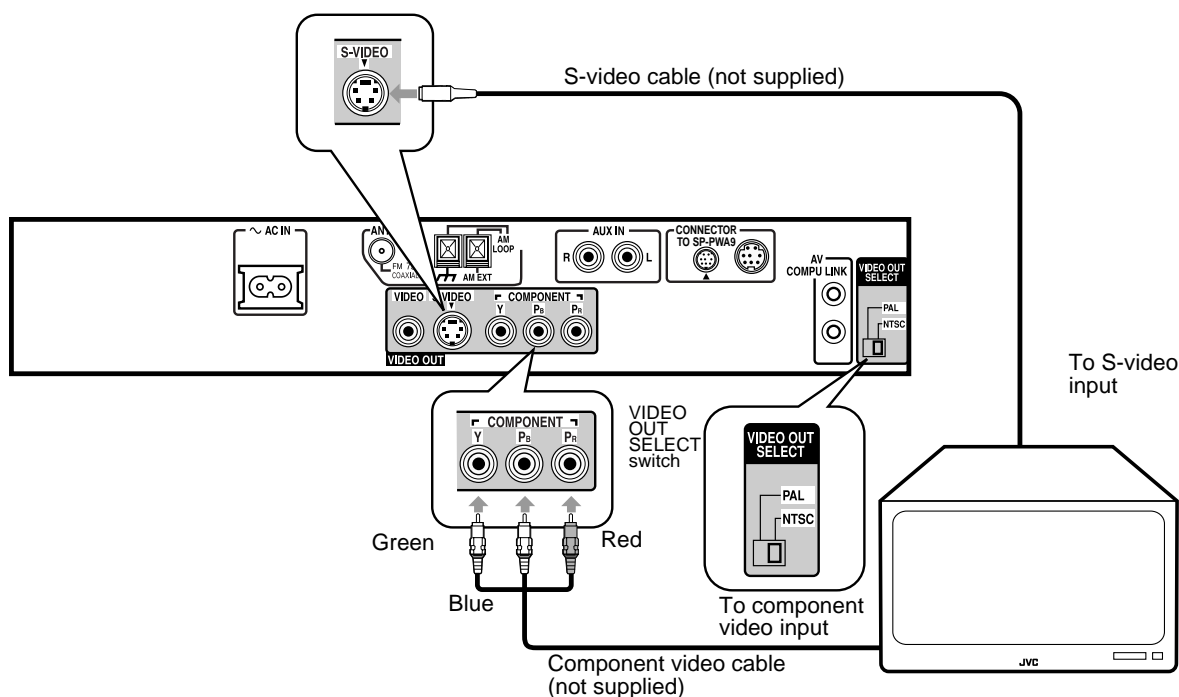

- Connect “Y” to “Y”, “P_B” to “P_B”, and “P_R” to “P_R” correctly.

Selecting the color system:

The center unit is compatible with the PAL and NTSC systems. Set the VIDEO OUT SELECT switch on the rear panel to match the color system of your TV. Make sure that the color system of a DVD, Video CD, or SVCD disc labeled on the package matches your TV. If you use a multi-system TV, you can play discs recorded on both PAL and NTSC systems.

Notes:

- When the component video input jacks of the TV are of the BNC type, use an adapter to convert the pin jacks to BNC jacks (not supplied).
- Connect the S-video cable (not supplied). Otherwise, some functions of the TV may not work.

Connections

Connecting speakers

Connect the satellite speakers and center speaker to the terminals on the powered sub-woofer using the speaker cords supplied. Labels are attached to the speaker cords to indicate the speaker and terminal to which each is to be connected.

- The four satellite speakers may be used at either front or rear.
- Ensure that the left and right speakers are connected to left and right respectively, and that they are connected with the correct polarity (+ve, -ve). The white speaker cord connects to the + terminal, and the black speaker cord connects to the - terminal.

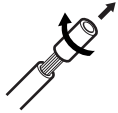

Twist and remove the insulation at the end of each speaker cord.

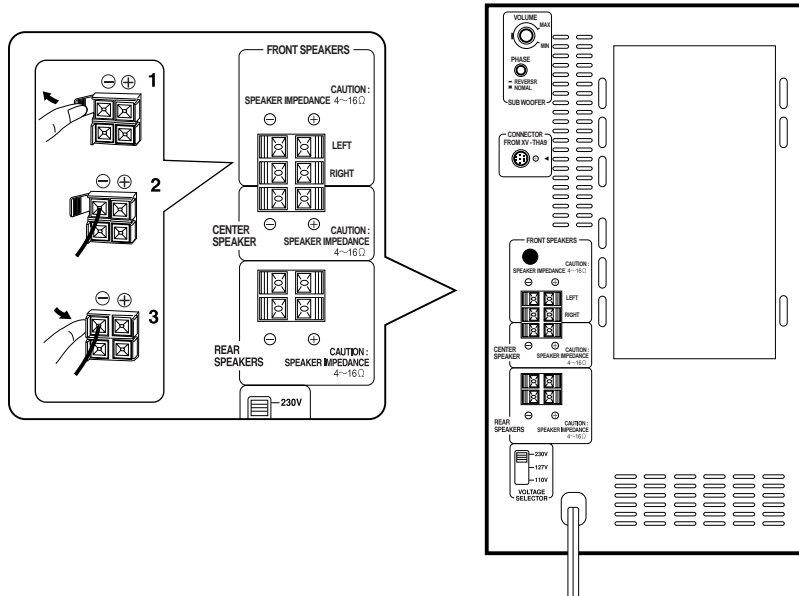

Connecting the front speakers

Connect the right speaker to the FRONT SPEAKERS RIGHT terminal.

Connect the left speaker to the FRONT SPEAKERS LEFT terminal.

Connecting the rear and center speakers

Connect the right rear speaker to the REAR SPEAKERS RIGHT terminals.

Connect the left rear speaker to the REAR SPEAKERS LEFT terminals.

Connect the center speaker to the CENTER SPEAKER terminals.

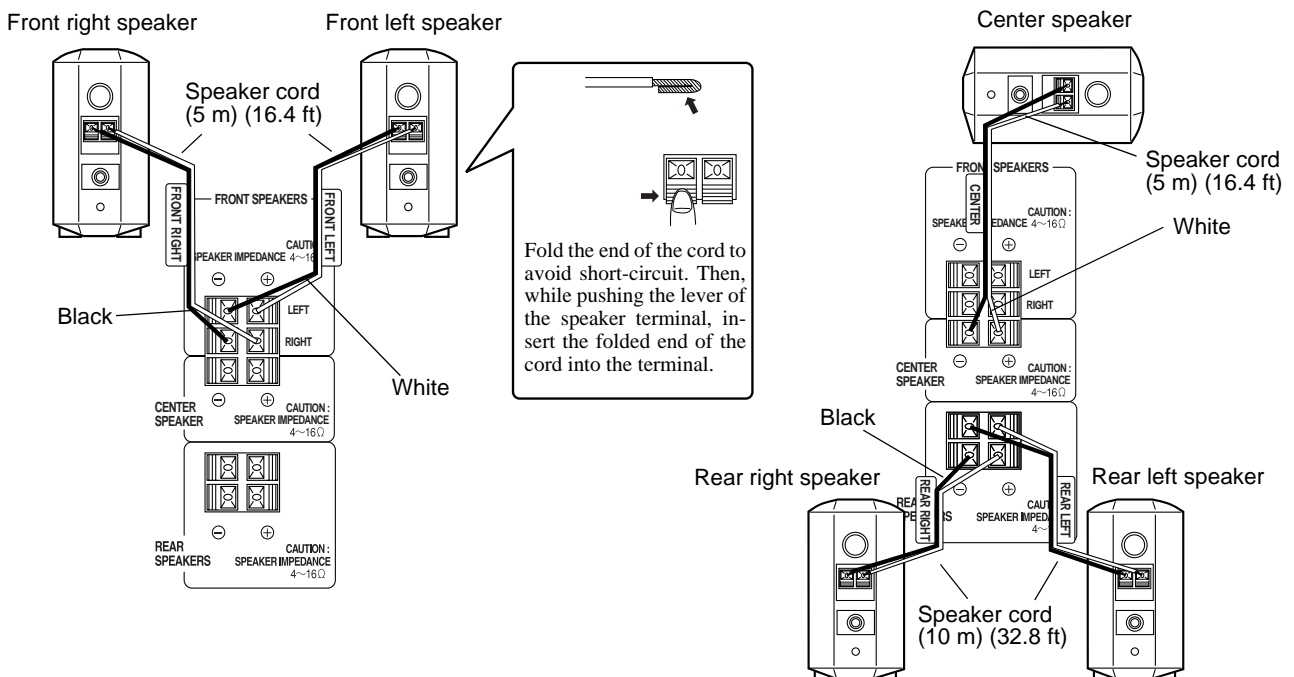

Note:

- Mixing up the polarity of the speaker cords can reduce the stereo effect and sound quality.

Connecting an audio component

You can connect an analog audio component, such as VCR, TV and MD recorder to this system. Refer also to the manuals supplied with your components.

Use the cable with RCA pin plugs (not supplied).
Connect the white plug to the left jack, and the red plug to the right jack.

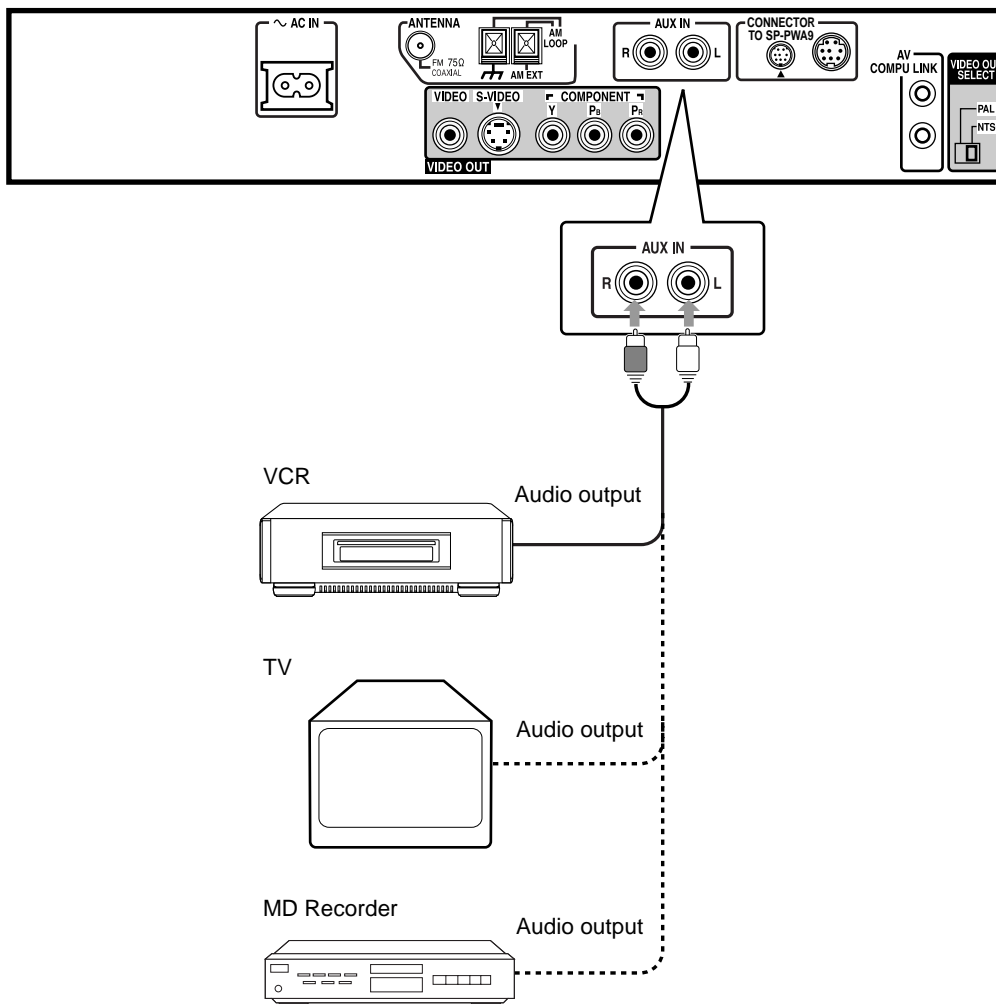

CAUTION:

If you connect a sound-enhancing device such as a graphic equalizer between the source components and the center unit, the sound output through this system may be distorted.

Connections

Setting the VOLTAGE SELECTOR

To avoid damaging the powered sub-woofer, set the VOLTAGE SELECTOR on the rear panel to the correct voltage for your area.

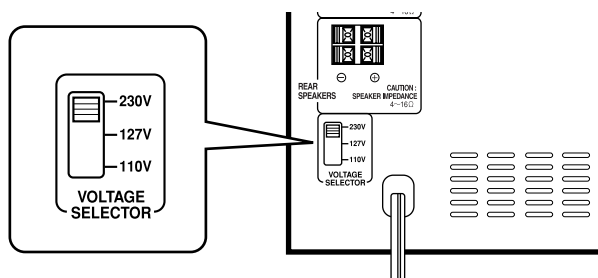

CAUTION:

Do not plug in the power cord of the powered sub-woofer before setting the VOLTAGE SELECTOR to the correct voltage.

Connecting the power cord

Before plugging the center unit and powered sub-woofer into an AC outlets, make sure that all connections have been made.

Plug the power cord into an AC outlet.

The red STANDBY lamp on the center unit lights when the power cord is plugged in.

Keep the power cord away from the connecting cables and the antenna cable. The power cord may cause noise or screen interference.

We recommend that you use a coaxial cable to connect the FM outdoor antenna, since it is well-shielded against interference.

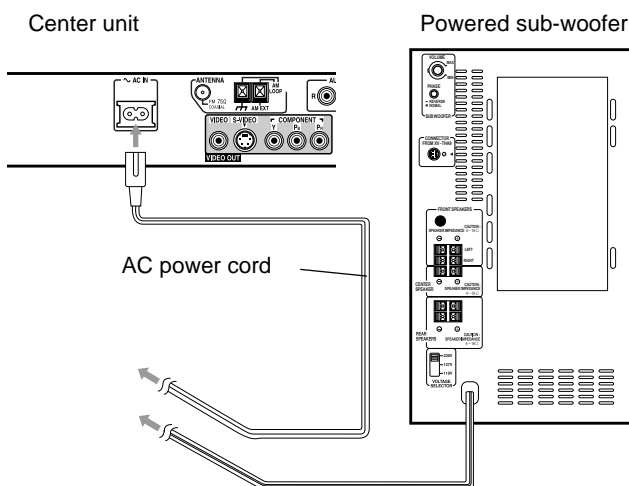

CAUTIONS:

- Do not touch the power cord with wet hands.
- Do not pull on the power cord to unplug the cord. When unplugging the cord, always grasp the plug so as not to damage the cord.

Notes:

- The preset settings such as preset channel and sound adjustment may be erased in a few days in the following cases:
 - When you unplug the power cord.
 - When a power failure occurs.
- The speakers will not produce any sound if the powered sub-woofer power cord is removed from the AC outlet while the center unit is turned on. In this case power will not come on even when the powered sub-woofer power cord is plugged in the AC outlet. Press **⏻** on the center unit, or **AUDIO ⏻** on the remote control to turn power on. This will turn the powered sub-woofer on and sound will be emitted from the speakers.

Putting batteries in the remote control

Before using the remote control, put two supplied batteries first. When using the remote control, aim the remote control directly at the remote sensor on the center unit.

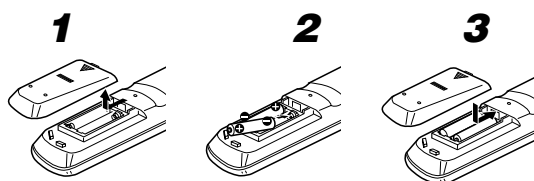

1 On the back of the remote control, remove the battery cover.

2 Insert batteries. Make sure to match the polarity: (+) to (-).

3 Replace the cover.

- If the range or effectiveness of the remote control decreases, replace the batteries. Use two R6P (SUM-3)/AA (15F) type dry-cell batteries.

CAUTIONS:

- Follow these precautions to avoid leaking or cracking cells:
- Place batteries in the remote control so they match the polarity: (+) to (-).
 - Use the correct type of batteries. Batteries that look similar may differ in voltage.
 - Always replace both batteries at the same time.
 - Do not expose batteries to heat or flame.

Parts Identification

Become familiar with the buttons and controls on the center unit and powered sub-woofer before use. Refer to the pages in parentheses for details.

Center unit

Front panel (top view)

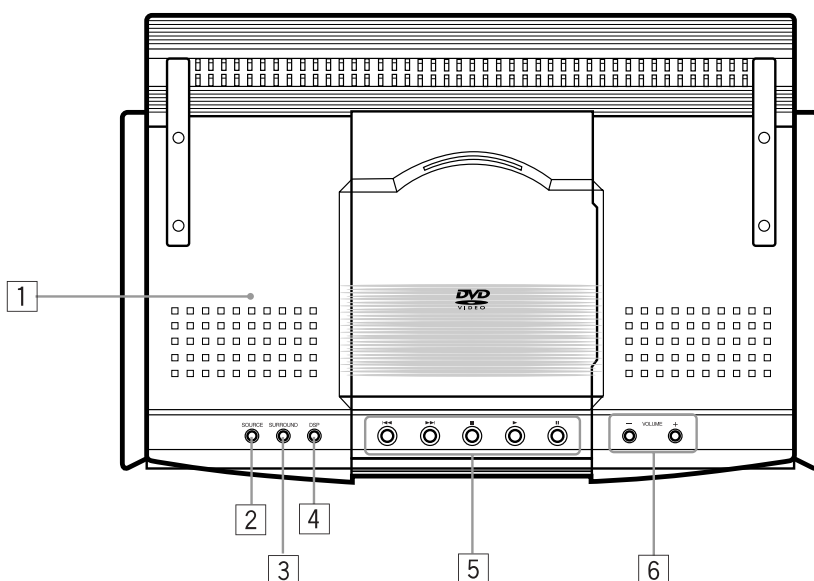

- 1 Disc cover (22)
- 2 SOURCE button (18)
- 3 SURROUND button (18)
- 4 DSP mode button (21)
- 5 DVD control buttons (23, 24, 25)
- 6 VOLUME +/- button (17)

Front panel (front view)

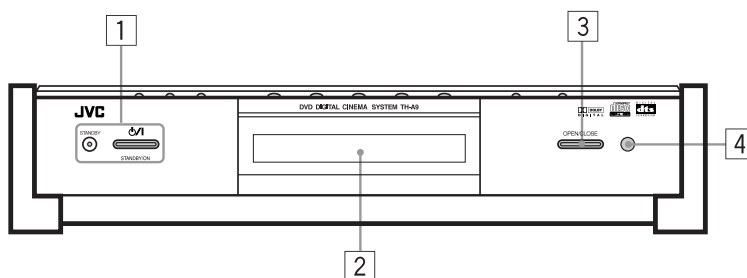

- 1 STANDBY/ON \odot/I button and STANDBY lamp (17)
- 2 Display window
- 3 OPEN/CLOSE button (22)
- 4 Remote sensor

Rear panel

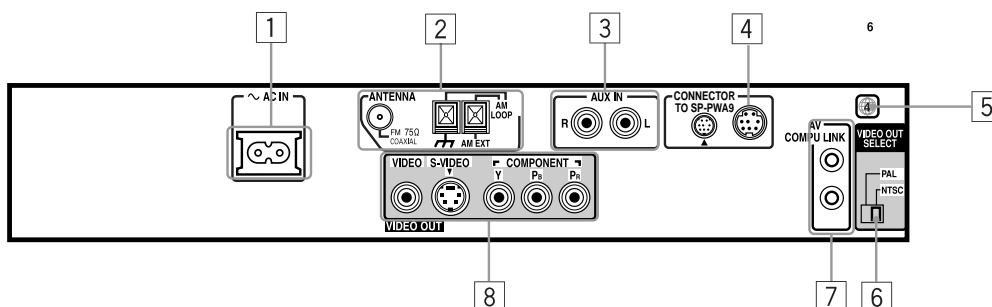

- 1 AC IN socket (10)
- 2 Antenna terminals (6)
- 3 AUX IN terminals (9)
- 4 Connector for powered sub-woofer (6)
- 5 Region code number (5)
- 6 VIDEO OUT SELECT (6,7)
PAL/NTSC
- 7 AV COMPU LINK terminals (53)
- 8 Video output terminals (6, 7)

Parts Identification

Display window

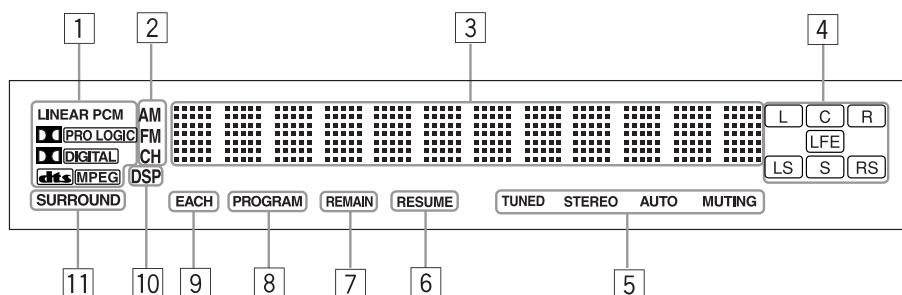

- 1 Decode mode indicator
- 2 Radio indicator (40, 41)
- 3 Multi-information window
Displays time, status information, etc.
- 4 Audio channel indicator (19)
- 5 Radio reception mode indicator (40, 41)
- 6 RESUME indicator (25)
- 7 REMAIN indicator (Timer indicator) (39)
- 8 PROGRAM indicator (36)
- 9 EACH indicator (Timer indicator) (39)
- 10 DSP indicator (21)
- 11 SURROUND indicator (21)

Powered sub-woofer (Front)

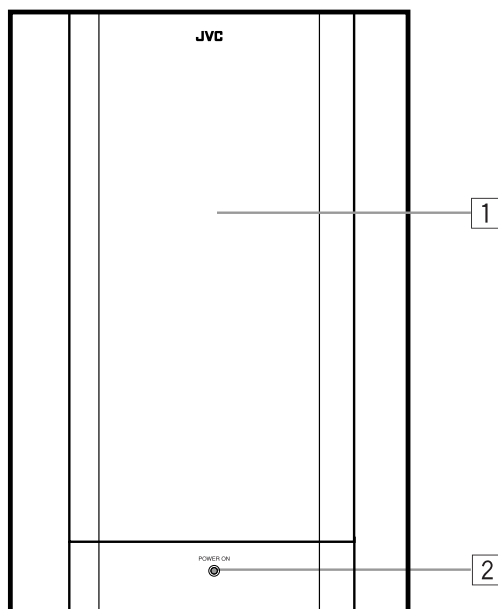

- 1 Speaker
- 2 POWER ON lamp (17)

(Rear)

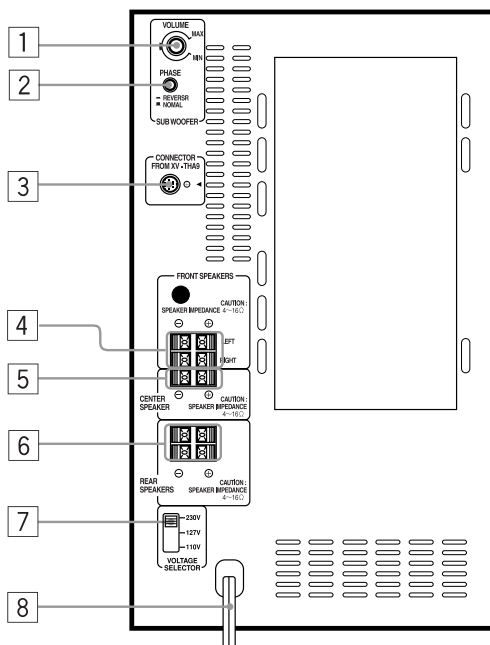

- 1 VOLUME knob (18)
- 2 PHASE button (18)
- 3 Connector for center unit (6)
- 4 FRONT SPEAKERS terminals (8)
- 5 CENTER SPEAKER terminals (8)
- 6 REAR SPEAKERS terminals (8)
- 7 VOLTAGE SELECTOR (10)
- 8 Power cord (10)

Remote controls

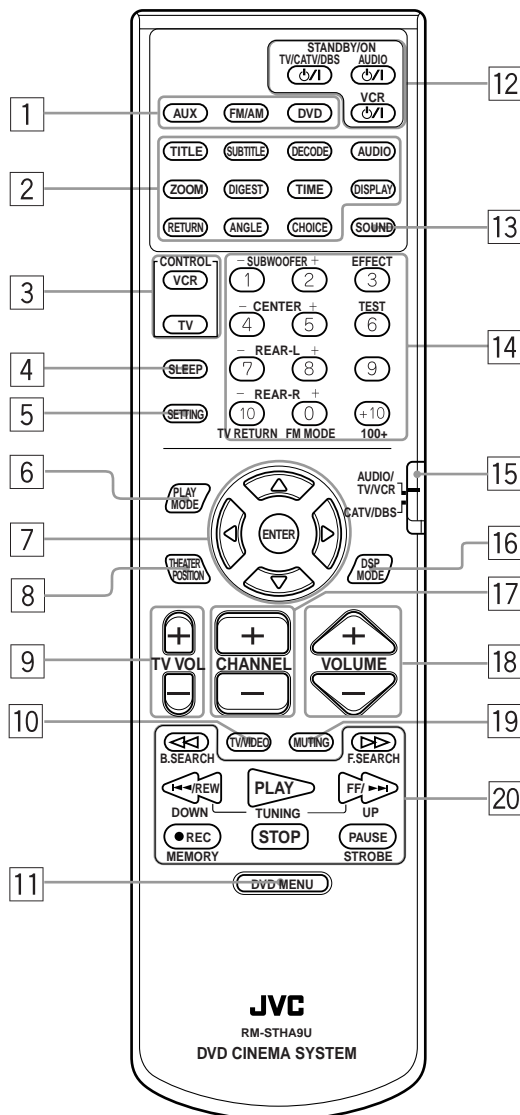

- 1 Source selecting buttons (14, 18, 41)
AUX, FM/AM, DVD
- 2 DVD operating buttons
TITLE (25)
SUBTITLE (31)
DECODE (19)
AUDIO (32)
ZOOM (31)
DIGEST (29)
TIME (38, 39)
DISPLAY (37, 38)
RETURN (26)
ANGLE (33)
CHOICE (42)
- 3 Control buttons VCR/TV (55, 56)
- 4 SLEEP button (20)
- 5 SETTING button (48)
- 6 PLAY MODE button (34, 35, 36, 37)
- 7 Cursor and ENTER buttons (25)
- 8 THEATER POSITION button (34)
- 9 TV VOL +, - button (55)
- 10 TV/VIDEO button (55)
- 11 DVD MENU button (25)
- 12 STANDBY/ON buttons
AUDIO ϕ /I (17, 22)
TV/CATV/DBS ϕ /I (17, 22, 55, 56)
VCR ϕ /I (56)
- 13 SOUND button (51, 52)
- 14 Number buttons
- 15 Remote control mode selector (55)
AUDIO/TV/VCR, CATV/DBS
- 16 DSP MODE button (21)
- 17 CHANNEL +, - button (55, 56)
- 18 VOLUME +, - button (17)
- 19 MUTING button (18)
- 20 Operating buttons (23, 24, 40, 41)

Principles of operation

The system may be operated via the remote control or the buttons on the center unit, or via the menu on the screen.

Operation with the remote control

Select the appropriate mode for the remote control when the remote control is used for operation.

The remote control mode is selected by pressing the source selecting buttons.

Press DVD: The DVD operation buttons, number buttons, PLAY MODE button, THEATER POSITION button and operating buttons operate in DVD mode, enabling operation of the DVD, Audio CD, Video CD and SVCD discs.

Press FM/AM: The number buttons and operating buttons operate in the radio mode. In Radio mode, nothing will be displayed on the TV.

Press AUX: Press to listen to sound inputted to the AUX jacks. In AUX mode, only the VOLUME + and – buttons are operable. Also, nothing will be displayed on the TV.

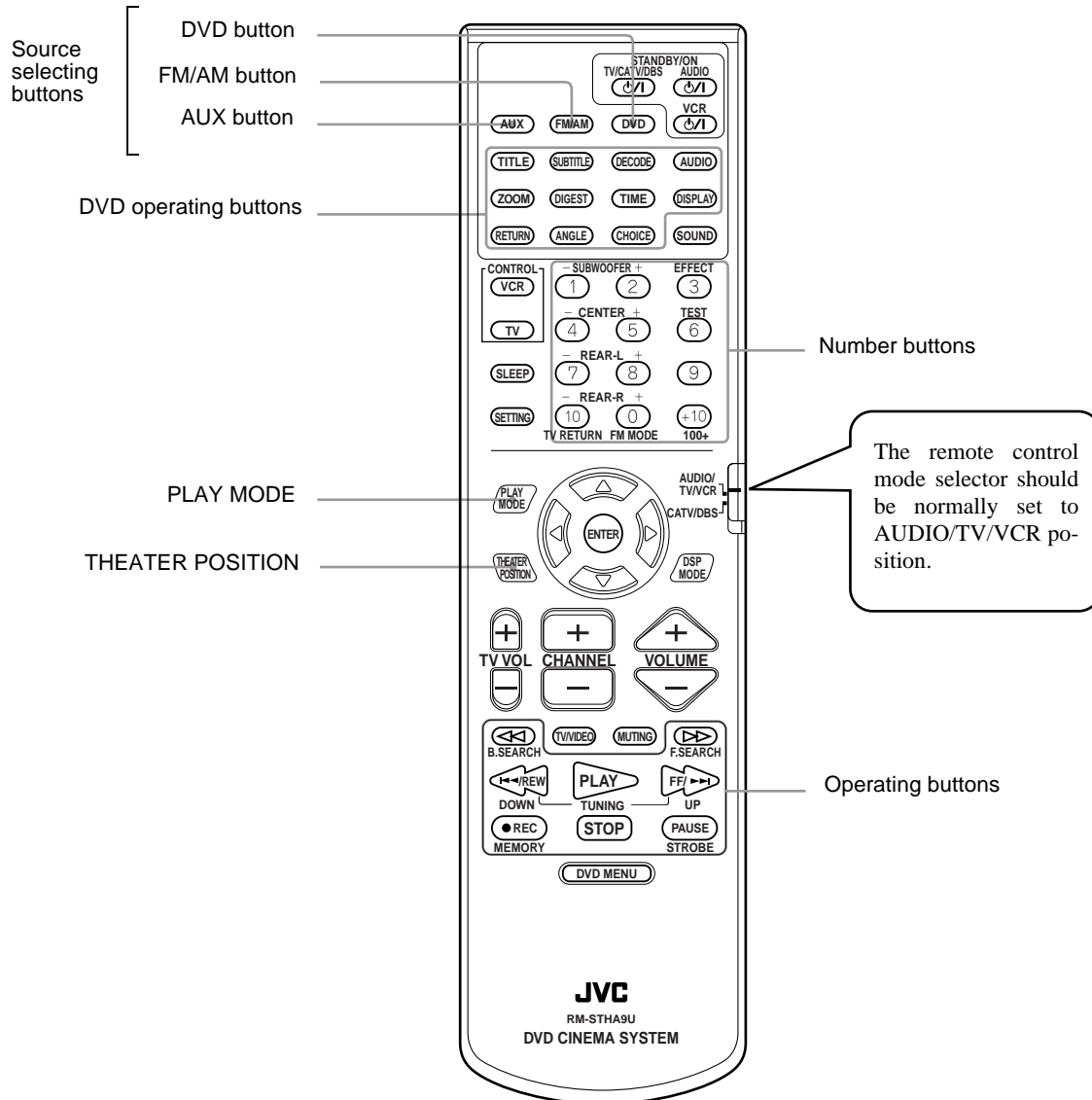

Note:

- The remote control mode is affected by the source selecting buttons as well as the SOUND, VCR, TV buttons, and the remote control mode selector. See pages 51 and 55 for details.

On-screen displays

The center unit provides several on-screen displays.

With some displays, you can set or select preferences or functions, while the others are display-only.

Opening screens

The Opening screen appears automatically in some conditions.

At the bottom, the following information are indicated depending on the center unit's status.

- NOW READING: The center unit is now reading the disc information (TOC).
- REGION CODE ERROR!: The DVD disc loaded cannot be played because the region code of the disc does not match the center unit.
- OPEN: The disc cover is now opening.
- CLOSE: The disc cover is now closing.

Opening display

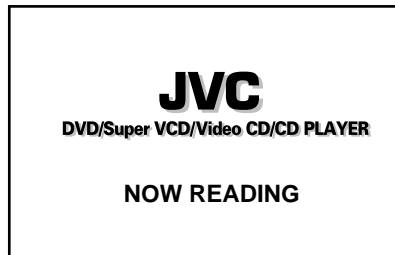

Play mode displays

While stopped

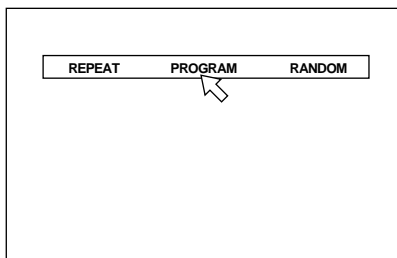

Status displays

DVD function status

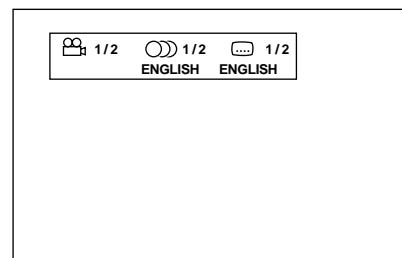

During DVD playback

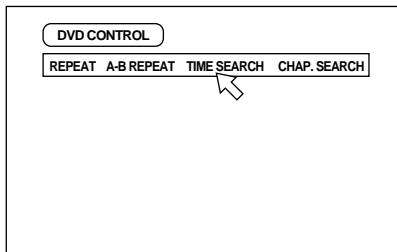

Disc/time (DVD)

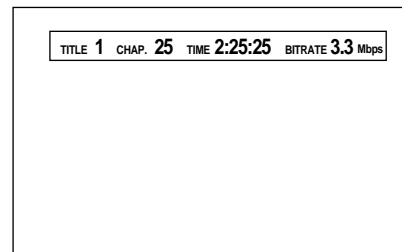

During Audio CD playback

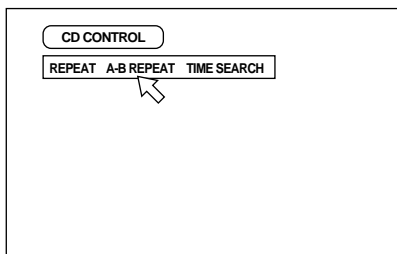

Disc/time (Audio CD/Video CD/SVCD without PBC)

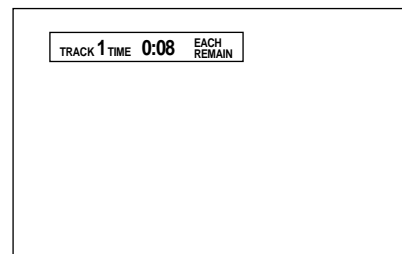

During Video CD/SVCD playback

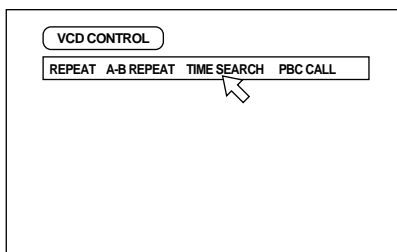

Disc/time (Video CD/SVCD with PBC)

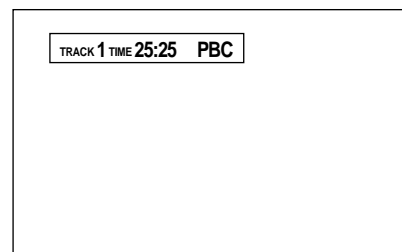

Principles of operation

On-screen menus for setting preferences

LANGUAGE

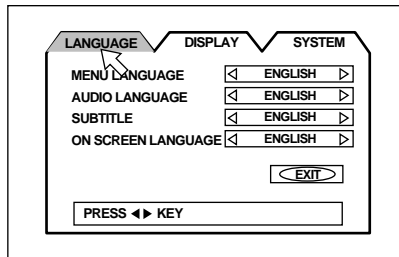

DISPLAY

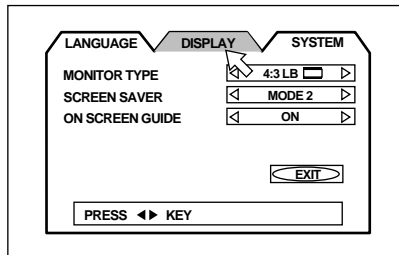

SYSTEM

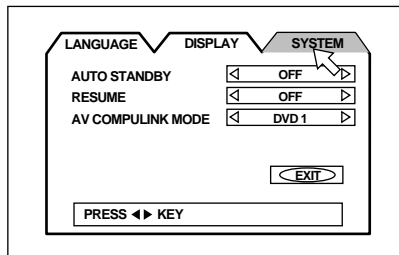

On-screen menus for setting parental lock

PARENTAL LOCK

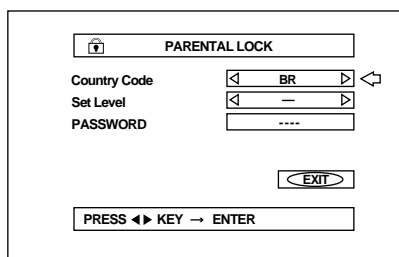

On-screen menus for using discs

The disc status and items are displayed as follows on the on-screen menu for using the disc.

Preventing screen burn-out with the screen saver [SCREEN SAVER]

A television monitor screen may be burned out if a static picture is displayed for a long time. To prevent this, the center unit automatically activates the screen saver function if a static picture, such as an on-screen display or menu, is displayed for over 5 minutes.

- Pressing any button on the center unit or the remote control unit will release the screen saver function and return to the previous display.
- You can select one of several screen saver modes available (see page 44).

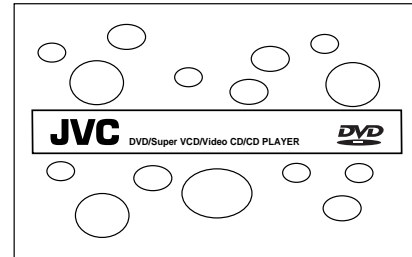

Note:

- The screen saver does not work during playing back an Audio CD or while stopped after played back an Audio CD.

Basic operations

The basic operations for this system are as follows.

IMPORTANT

Check that remote control mode selector is set to the appropriate position:

Set to "AUDIO/TV/VCR" to operate an audio system, TV, or VCR.

Set to "CATV/DBS" to operate a CATV converter or DBS tuner. The system will not operate normally while in CATV/DBS mode.

To turn the system power supply ON and OFF (standby)

From the remote control:

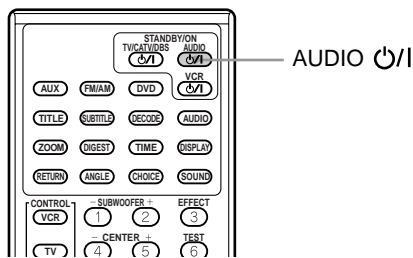

Press **AUDIO**  to turn power on.

The STANDBY lamp goes off, and the current source name (DVD, AM or FM station frequency, or AUX) appears on the display window. At this time, the disc cover slides backwards and the top buttons on the center unit appears.

Press **AUDIO**  again to turn power off (standby).

The STANDBY lamp is lit.

The disc cover slides forward to cover the top buttons on the center unit and the center unit turns off.

On the center unit:

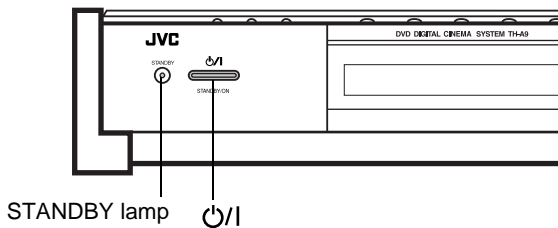

Press  to turn power on.

The STANDBY lamp goes off, and the current source name (DVD, AM or FM station frequency, or AUX) appears on the display window. At this time, the disc cover slides backwards and the top buttons on the center unit appears.

Press  again to turn power off (standby).

The STANDBY lamp is lit.

The disc cover slides forward to cover the top buttons on the center unit and the center unit turns off.

Notes:

- The powered sub-woofer power supply is linked to the center unit. The green POWER ON lamp on the powered sub-woofer lights when power is turned on, and goes off when power is turned off.
- A small amount of power is consumed in the standby mode (center unit only). Remove AC power cord from the AC outlet to turn the center unit off completely.

To turn TV power ON and OFF

JVC TVs may be used as is with the remote control. TVs from other manufacturers require changes to the transmittable signals before they can be used with the remote control. See page 55 for details of changing the transmittable signals.

From the remote control:

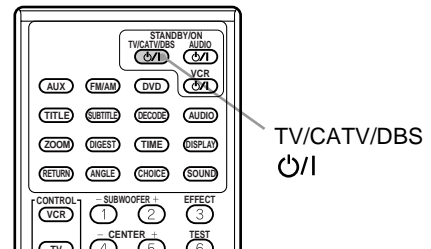

Press **TV/CATV/DBS**  to turn power on.

Press **TV/CATV/DBS**  again to turn power off.

Adjusting volume [VOLUME]

The volume level can be adjusted within the range of "0" (minimum) to "80" (maximum).

Common:

From the remote control

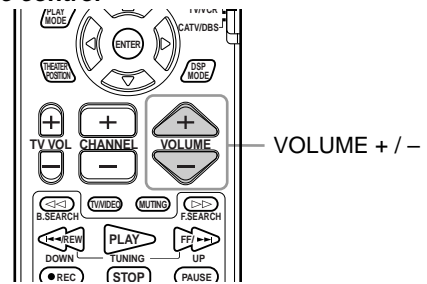

On the center unit

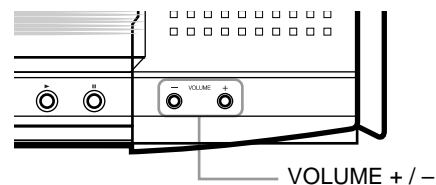

Press **VOLUME +** or **-**.

Press **VOLUME +** to increase volume.

Press **VOLUME -** to decrease volume.

CAUTION:

Always set the volume to the minimum before starting any source.

If the volume is set at its high level, the sudden blast of sound energy can permanently damage your hearing and/or ruin your speakers.

Basic operations

Sub-woofer volume control and phase setting

Use the VOLUME knob and PHASE button at the rear of the powered sub-woofer.

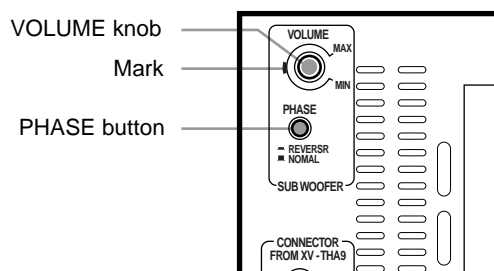

Volume control

Turn the VOLUME knob.

Adjust to a volume appropriate for balance with the other speaker(s).

The mark indicates the volume position in normal use.

- Adjust when the volume from the sub-woofer is too high or too low in relation to the volume from the front speaker.

Phase setting

Play sound through the sub-woofer and adjust the PHASE button to a position (REVERSE or NORMAL) at which the lowest frequency is heard best.

Note:

- Phase is closely related to the distance from the listening position to the front speaker and sub-woofer. While listening, adjust until the lowest frequency is heard best.

Muting the sound [MUTING]

From the remote control only:

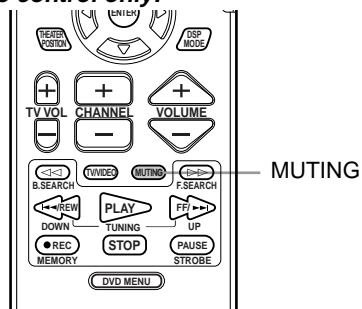

Press MUTING to mute the sound through all speakers connected.

"MUTING" appears on the display window and volume turns off. To restore the sound, press MUTING again so that "OFF" appears on the display.

- Pressing VOLUME +/- also restores the sound.

Selecting the source to play

Selected source name appears

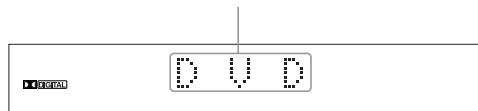

From the remote control:

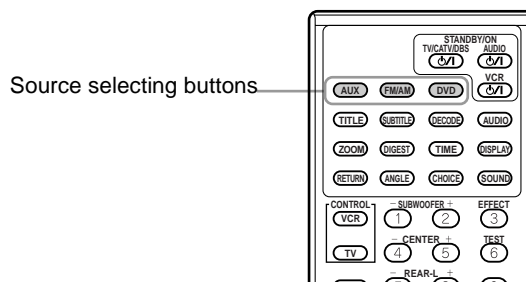

Press one of the source selecting buttons.

- DVD** Select the DVD player.
- FM/AM** Select an FM or AM broadcast. Each time you press the button, the band alternates between FM and AM.
- AUX** Select a component connected to the AUX jacks.

Notes:

- When you press one of the source selecting buttons on the remote control, the system automatically turns on.
- The cooling fan in the center unit turns on as long as the DVD is selected as the playback source. It stops when other playback source (FM/AM or AUX) is selected.

On the center unit:

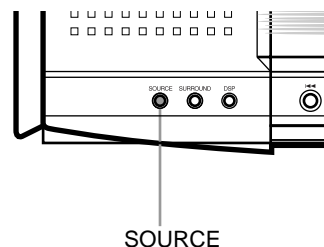

Press SOURCE until the source name you want appears on the display.

The source changes as shown below each time the button is pressed.

→ DVD → AM → FM → AUX → (back to the beginning)

Note:

- When AM or FM is selected, the receiving frequency appears on the display window. At the same time, the AM or FM indicator lights up on the display window.

Changing the decode mode [DECODE]

You can change the decode mode for digital audio playback.

From the remote control only:

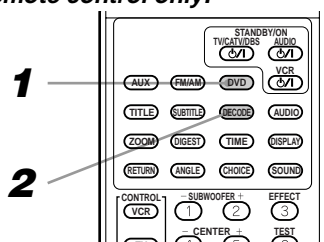

1 Press DVD to select DVD as the source.

2 Press DECODE to select the decode mode.

The display changes as shown below each time the button is pressed.

→ AUTO/PCM → DTS → (back to the beginning)

AUTO/PCM Optimized for all discs playable on this system. (Default)

DTS Select this mode when playing a DVD disc recorded in DTS Surround.
The DTS decoder will be selected as the internal decoder.

When to try changing the decode mode

When the decode mode is set to the default AUTO/PCM setting and a DVD recorded in Dolby Digital Surround or DTS Digital Surround is played, the internal decoder will be automatically selected before audio playback begins. Depending on the disc recorded in DTS Digital Surround, this may result in a brief loss of audio after playback starts. This is due to lost audio signals that were inputted during internal decoder selection.

In these instances, lost audio can be prevented by manually selecting "DTS" beforehand.

However, please note that when the decode mode is set to DTS, you will be unable to playback audio from discs recorded in a mode other than the DTS Digital Surround.

After changing the decode mode and playing back a disc, return the decode mode to "AUTO/PCM".

Note:

- Changing the playback source (e.g. AM/FM) will automatically return the decode mode to "AUTO/PCM".

When a decode mode which differs from the type of disc being played is selected

Insert a DVD disc in the center unit to display the type of audio being played in the Decode mode indicator on the display window. Audio cannot be played if a decode mode which differs from the displayed mode is selected.

The selected decode mode flashes to indicate that the selected decode mode does not allow audio playback.

Example: When DTS is selected as the decode mode for Dolby digital audio.

Flashes



Audio channel display indicator

The audio channel indicator shows the audio channel configuration for the disc currently playing.

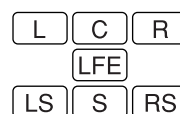

The indicators refer to the speaker channel as follows.

- L:** Left front speaker channel
- R:** Right front speaker channel
- C:** Center speaker channel
- RS:** Right surround speaker channel
- LS:** Left surround speaker channel
- S:** Rear speaker channel (monaural)
- LFE:** Sub-woofer channel

The audio channel indicator indicates the type of disc currently playing as follows.

With Dolby digital 5.1 ch or DTS digital 5.1 ch surround



With Dolby digital (Lt/Rt*)



With stereo sound (e.g. Audio CD)



* Lt/Rt refers to the downmix output when connected to a device that uses Dolby Pro Logic.

Note:

- The audio channel indicator does not show the actual speaker channel that is producing sound.

Basic operations

Using the Sleep Timer [SLEEP]

Using the Sleep Timer, you can fall asleep to music and know the system will turn off by itself rather than play all night.

From the remote control:

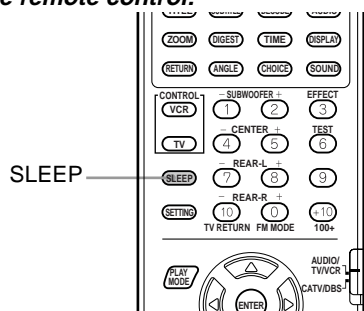

Press **SLEEP** repeatedly.



The shut-off time changes as follows (in minutes):

→10 → 20 → 30 → 60 → 90 → 120 → 150 →
OFF (Canceled) → (back to the beginning)

When the shut-off time comes

The system turns off automatically.

To check or change the time remaining until the shut-off time

Press **SLEEP** once.

The remaining time until the shut-off time appears in minutes.

- To change the shut-off time, press **SLEEP** repeatedly.

To cancel the Sleep Timer

Press **SLEEP** repeatedly until "SLEEP OFF" appears on the display window.

- Turning off the power also cancels the Sleep Timer.



Using the DSP Modes [DSP MODE]

The built-in Surround Processor provides two types of the DSP (Digital Signal Processor) mode — Surround mode and DAP (Digital Acoustic Processor) mode.

Surround modes

With this system, you can use two types of the Surround mode.

Dolby Surround (Dolby Digital and Dolby Pro Logic)*

Used to watch the soundtracks of software encoded with Dolby Digital (bearing the mark ) or with Dolby Surround (bearing the mark ) .

Dolby Digital and Dolby Pro Logic can be selected automatically according to software played back.

DTS Digital Surround**

DTS Digital Surround is a discrete 5.1 channel digital audio format available on CD and DVD software.

To watch the soundtracks of video software bearing the mark , the system can provide you with DTS Digital Surround decoder. DTS Digital Surround is automatically selected according to software played back.

MPEG Multichannel

MPEG Multichannel is another discrete 5.1 channel digital audio format available on DVD software, and uses encoding method called MPEG2-Audio. (MPEG stands for "Motion Picture Expert Group" and has been originally developed for compressing video signals.) To watch the soundtracks of video software bearing the mark , the center unit can provide you with MPEG Multichannel decoder.

Note:

- Change the decode mode from "AUTO/PCM" to "DTS" before playing an Audio CD recorded with DTS Digital Surround. For details, see page 19.

* Manufactured under license from Dolby Laboratories. "Dolby", "Pro Logic", and the double-D symbol are trademarks of Dolby Laboratories. Confidential Unpublished Works. ©1992-1998 Dolby Laboratories, Inc. All rights reserved.

** Manufactured under license from Digital Theater Systems, Inc. US Pat. No. 5,451,942 and other world-wide patents issues and pending. "DTS" and "DTS Digital Surround" are trademarks of Digital Theater Systems, Inc. ©1996 Digital Theater Systems, Inc. All rights reserved.

DAP modes

The sound heard in a concert hall or club consists of direct sound and indirect sound — early reflections and reflections from behind. Direct sounds reach the listener directly without any reflection. On the other hand, indirect sounds are delayed by the distances of the ceiling and walls. These direct sounds and indirect sounds are the most important elements of the acoustic surround effects. The DAP mode can create these important elements, and gives you a real "being there" feeling.

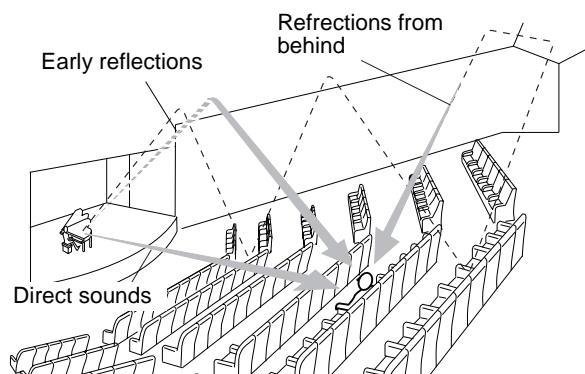

- | | |
|--------------------|--|
| THEATER: | Gives the feeling of a large theater. |
| LIVE CLUB: | Gives the feeling of a live music club with a low ceiling. |
| DANCE CLUB: | Gives a throbbing bass beat. |
| HALL: | Gives clear vocal and the feeling of a concert hall. |
| PAVILION: | Give the spacious feeling of a pavilion with a high ceiling. |

Notes:

- The DSP modes have no effect on monaural sources.
- The **DOLBY DIGITAL** indicator lights up when the signals encoded with Dolby Digital come into the system.
- The **PRO LOGIC** indicator lights up when the signals encoded with Dolby Pro Logic decoder built in this system is activated.
- The **dts** indicator lights up when the signals encoded with DTS Digital Surround come into the system.
- The effects can be adjusted when the DAP mode is selected (see page 52).

To select the DSP mode

From the remote control:

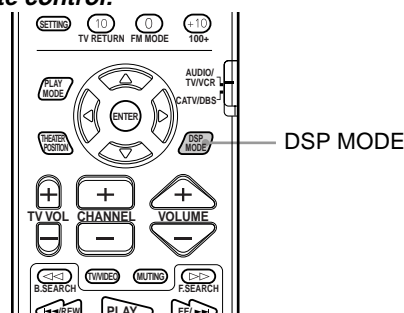

Press DSP MODE.

The currently selected DSP mode appears on the display when the button is pressed, and changes as follows each time the button is pressed subsequently.

- **SURROUND ON** → **THEATER** → **LIVE CLUB** → **DANCE CLUB** → **HALL** → **PAVILION** → **DSP OFF** → (back to the beginning)
- “PRO LOGIC”, rather than “SURROUND ON”, is displayed when a source other than DVD is selected.
- Select “SURROUND ON” when playing a video with audio recorded in Dolby Pro Logic, Dolby digital, or DTS digital surround audio. Selecting “OFF” loses any surround effect, and stereo playback takes place.

Notes:

- It is possible to select only “SURROUND ON” and “SURROUND OFF” when playing a Dolby digital audio or DTS digital audio DVD.
- The DSP mode indicator lights up when DSP mode other than SURROUND is selected.
- The SURROUND indicator lights up when SURROUND mode is selected.

On the center unit:

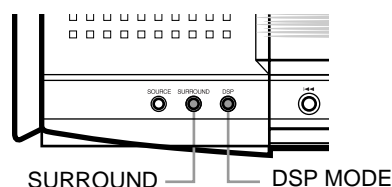

From the unit, SURROUND ON/OFF and DAP mode can be selected independently.

When playing a DVD disc with audio recorded in Dolby surround, Dolby digital, or DTS digital surround audio:

Press SURROUND.

The current status (e.g. “SURROUND OFF”) appears on the display when the button is pressed, and changes between “SURROUND ON” and “SURROUND OFF” each time the button is pressed subsequently.

- “PRO LOGIC”, rather than “SURROUND ON”, is displayed when a source other than DVD is selected.

When selecting DAP:

Press DSP MODE.

The currently selected DAP mode appears on the display when the button is pressed, and changes as follows each time the button is pressed subsequently.

- **THEATER** → **LIVE CLUB** → **DANCE CLUB** → **HALL** → **PAVILION** → **DSP OFF** → (back to the beginning)

Notes:

- The DSP mode indicator lights up when DAP mode is selected.
- The SURROUND indicator lights up when SURROUND mode is selected.

Using the DVD player

DVD **Audio CD** **Video CD** and **Super VCD** represent disc types.

To turn on the system and TV



From the remote control:

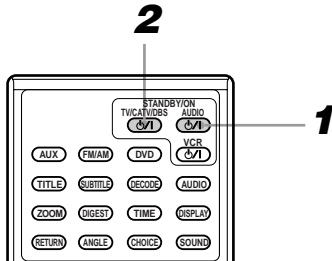

1 Press AUDIO to turn power on.

- Pressing  on the center unit also turns on power.

2 Press TV/CATV/DBS to turn TV on.

- On the TV, select the TV input source to VIDEO (e.g. VIDEO 1).
- To turn on the other manufacturer's TV with TV/CATV/DBS , you need to change the transmittable signal codes beforehand. See page 55.

Notes:

- When you use Audio CDs, since no screen other than opening screen is displayed, turning on the TV may not be required.
- For detailed power on operation including the STANDBY indicator illumination, see page 17.

To insert a disc



After turning on the system and the TV, insert a disc as follows:

On the center unit:

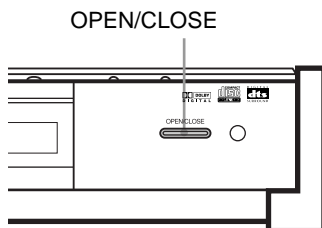

1 Press OPEN/CLOSE to open the disc cover.

- When the current playback source is DVD, "OPEN" appears on the display window. On the TV, "OPEN" message appears on the opening on-screen.

2 Attach a disc.

Attach a disc with label side up so that it is securely seated.

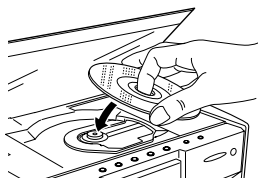

3 Press OPEN/CLOSE to close the disc cover.

- When the current playback source is DVD, "CLOSE" appears on the display window. On the TV, "CLOSE" message appears on the opening on-screen.
- After the disc cover is closed, "READING" appears on the display window. Then, the disc information is read and, if the current playback source is DVD, the information is displayed as described in "Display when a disc is inserted" on page 23. On the TV, while disc information is reading, "NOW READING" message appears on the opening on-screen.

4 Remove the disc after playback has finished.

Press OPEN/CLOSE to open the disc cover.

Then, remove the disc as shown below:

After that, press OPEN/CLOSE to close the disc cover.

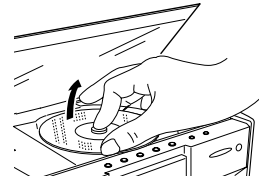

CAUTION:

Do not put anything on the disc cover since it slides back and forth, or opens. Doing so may result in damage to the unit.

Notes:

- The system can play back DVD, Audio CD, Video CD, SVCD, and CD-R/CD-RW (audio-formatted) discs only. Do not insert other disc types. For details about playable disc types, see page 5.
- When OPEN/CLOSE is pressed to close the disc cover, playback automatically begins with some discs.
- You can insert a disc while playing other source (FM/AM or AUX).
- When the disc cover is open, you can directly play the disc by pressing DVD on the remote control or by selecting "DVD" with SOURCE on the center unit.
- If the Region Code of the disc does not match your system, "REGION CODE ERROR!" appears on the opening on-screen on the TV. This means that you cannot play the disc.
- When OPEN/CLOSE is pressed in standby mode, the center unit automatically turns on and the disc cover slides backwards and opens.

Display when a disc is inserted

Opening on-screen:

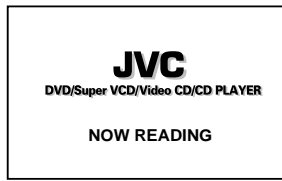

Note:

- Playback begins immediately with some DVD discs.

When a DVD is inserted

Display window:

“READING” → “DVD”

When a Video CD or SVCD is inserted:

Display window:

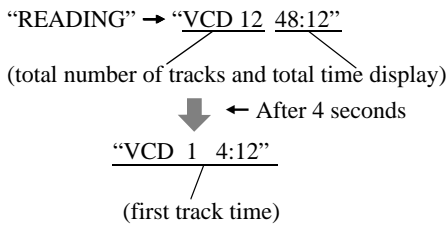

When an Audio CD is inserted

Display window:

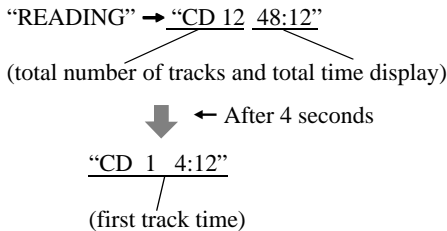

To play a disc



From the remote control:

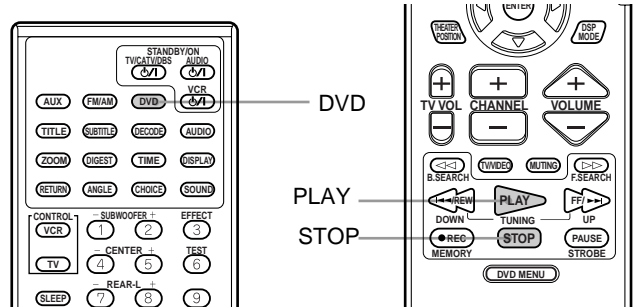

Press **PLAY** or **DVD**.

Playback begins from the first track.

On the center unit:

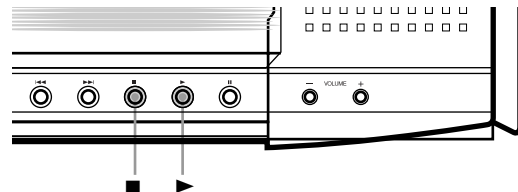

Press **▶**.

Playback begins from the first track.

To stop the disc

On the remote control: Press **STOP**.

On the center unit: Press **■**.

Note:

- For DVDs, Video CDs or SVCDs recorded with PBC (playback control), pressing **PLAY** or **▶** may display the menu on the TV. You may select items from the menu screen thus displayed and call up the locations to be viewed (see pages 25 and 26 for details).

On-screen guide icons

During DVD playback, you may see icons displayed over the picture. These have the following meanings.

- Displayed at the beginning of a scene recorded from multiple angles (see page 33).
- Displayed at the beginning of a scene recorded with multiple audio languages (see page 32).
- Displayed at the beginning of a scene recorded with multiple subtitle languages (see page 31).

A setting is possible to suppress display of these icons. The setting is entered in the on-screen menu under “On-screen guide settings” (see page 44 for details).

About invalid operation icon

When you press a button, if the unit does not accept its operation, appears on your television screen. Operations are occasionally unacceptable even if is not displayed.

Note that some operations may not be accepted. For example, some discs may not allow fast forward, fast backward or slow motion playback.

Using the DVD player

Pausing



From the remote control:

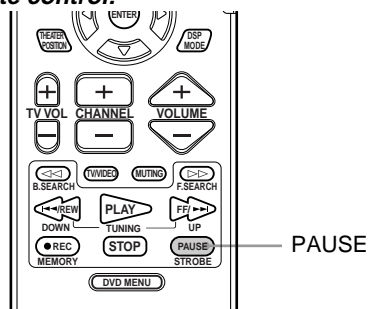

Press PAUSE.

On the center unit:

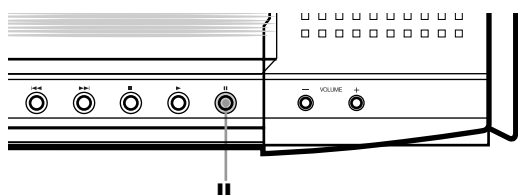

Press II .

Playback is paused.

When using a DVD, Video CD, or SVCD disc, pressing PAUSE or II while paused moves to the next still picture.

To resume playback

From remote control: Press PLAY.

On the center unit: Press ►.

Fast forward and backward



□ During playback

From the remote control:

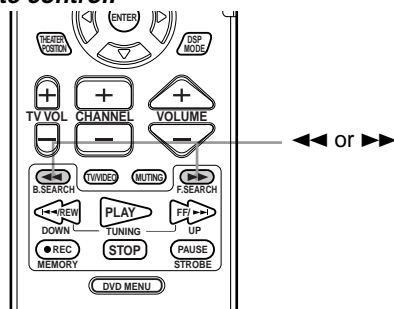

Press ►► or ◀◀.

Each time you press the button, the fast forward or backward speed changes as follows:

2x → 5x → 10x → 20x → 60x

To return to the normal speed

Press PLAY.

On the center unit:

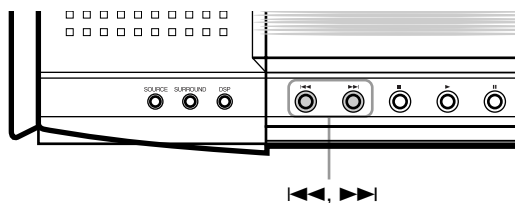

Continuously press ►►► or ◀◀◀.

Continuously pressing the button increases the fast forward or backward speed as follows:

5x → 20x

To return to the normal speed

Release ►►► or ◀◀◀.

Locating the beginning



Locates the beginning of the title or chapter with DVDs.

Locates the beginning of the track with Audio CDs, Video CDs and SVCDs.

- For DVD: During playback
- For Audio CD: During playback or when stopped
- For Video CD/SVCD: During playback or when stopped

From the remote control:

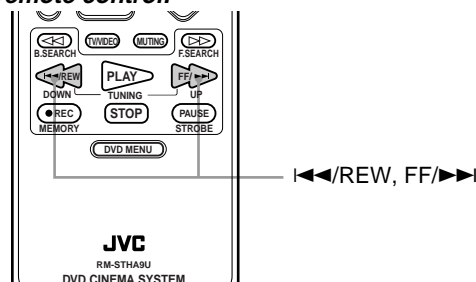

Press FF/►►► or ◀◀◀/REW.

On the center unit:

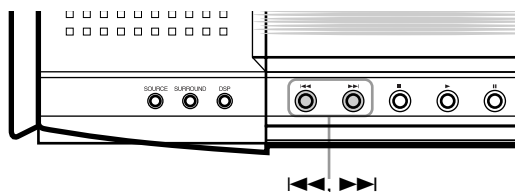

Press ►►► or ◀◀◀.

Press ◀◀◀ to locate the beginning of the current chapter, title, or track. Press ◀◀◀ twice quickly to locate the beginning of the previous one.

Press ►►► to locate the beginning of the next chapter, title, or track.

Note:

- When you play a Video CD or SVCD with PBC function or a DVD disc, the center unit may locate different place, but it will generally locate the beginning of the title or chapter or track.

Resuming playback



The center unit stores the position on a disc where you want to interrupt playback at, and resumes playback from that position later. To let work the resuming playback, the item RESUME in the SYSTEM menu must be set to ON beforehand. Otherwise, set it to OFF. See page 45.

To store the playback position

During playback, press **STOP** or **AUDIO** on the remote control.

Or

During playback, press **■** or on the center unit.

The center unit stores the position at which STOP or **■** is pressed, and the RESUME indicator on the display window is lit. The last stored memory overrides the previous memory.

Note:

- The interrupted position is stored even when **AUDIO** on the remote control, or on the center unit, is pressed to switch power OFF (standby).

To resume playback from the stored position

While stopped, press **PLAY** on the remote control or press **▶** on the center unit.

Playback begins from the stored position.

- When the center unit is in standby mode, you can activate resuming playback by pressing **PLAY** on the remote control.
- Changing the source during playback also stores the interrupted position. To resume playback from the stored position, press **PLAY** or **DVD** on the remote control. Selecting "DVD" by pressing **SOURCE** or pressing **▶** on the center unit will also resume playback.

Notes:

- When you perform the resuming operation for a Video CD or SVCD with the PBC function, the center unit may resume playback from a point slightly earlier than the resume point you stored.
- Resuming playback does not work for Audio CDs.
- Resuming playback does not work for program play and random play.

To clear the stored position

To clear the stored position, perform one of the following operations:

The RESUME indicator on the display window will go out.

- Open the disc cover.
- While stopped, press **STOP** on the remote control or **■** on the center unit once again.
- In standby mode, press **AUDIO** on the remote control or on the center unit once again to turn on the system.

Selecting playback from the DVD menu



DVD discs generally have their own menus which show the disc contents. These menus contain various items such as titles of a movie, names or songs, or artist information, and display them on the TV.

You can locate a desired scene by using the menu.

During playback

From the remote control only:

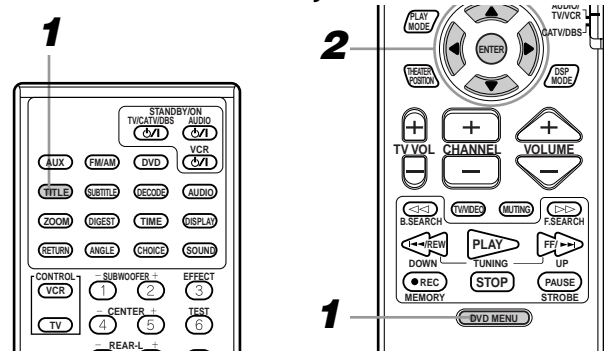

1 Press DVD MENU or TITLE.

The menu appears on the TV screen.

Example

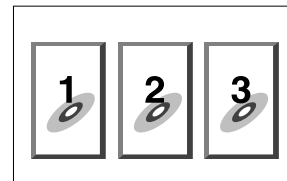

2 Press the cursors to select a desired item, then press ENTER.

The center unit starts playback of the selected item.

- With some discs, you can also select items by entering the corresponding number using the number buttons, which may cause the unit to automatically start playback.

About menu

Normally, a DVD disc which contains more than one title may have a "title" menu which lists the titles. In this case, the menu appears on the TV by pressing **TITLE**. Some DVD discs may also have a different menu which appears by pressing **DVD MENU**. See the instructions of each DVD disc for its particular menu.

Notes:

- When appears on the TV by pressing **TITLE** in step 1:
The disc does not have a menu listing the titles.
- When appears on the TV by pressing **DVD MENU** in step 1:
The disc does not have a menu.

Using the DVD player

Selecting the location to view from the Video CD/SVCD menu



When playing back Video CDs or SVCDs recorded with PBC (playback control), a list of the recorded contents may appear on the TV as a menu. The location to view may be conveniently called up from this menu screen.

- When the menu appears on the TV during playback with PBC.

From the remote control only:

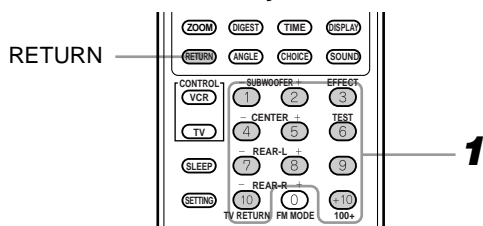

1 Use the number buttons (1~10, +10) to select the desired number of the item.

To select 3 on menu : Press 3.

To select 11 on menu : Press +10 → 1.

Playback starts from the selected item.

Example

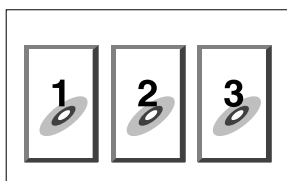

Press RETURN to return to the menu screen.

When “NEXT” or “PREVIOUS” appears on the TV, the center unit generally works as follows:

- Pressing ►► turns to the next page.
- Pressing ◄◄ returns to the previous page.

The method of the operation is different depending on the disc.

Activating the PBC function

To activate the PBC function when a PBC-compatible Video CD or SVCD is being played back without the PBC function, press STOP then press PLAY.

When the PBC function is activated, “PBC” appears on the display window.

You can also activate the PBC function using the on-screen display as follows:

1. Press **PLAY MODE**.
2. Press the ◄/► cursors to move the pointer to [PBC CALL], then press **ENTER**.

During Video CD/SVCD playback

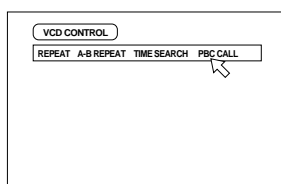

Cancelling the PBC function

If you want to play back a PBC-compatible Video CD or SVCD without activating the PBC function, start playback by using the number buttons instead of the PLAY button.

To specify the title, chapter, or track number for playback



Use the number buttons to specify the title (DVDs) or track number (CDs) to begin playback from the desired location.

- For DVD: While stopped (for title playback)
During playing back a screen other than the menu screen (for chapter playback)
- For Audio CD: During playback or while stopped
- For Video CD/SVCD: During playback without PBC function or while stopped

From the remote control only:

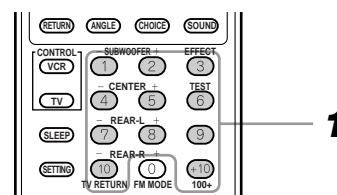

1 Press the number buttons (1~10, +10) to select the desired title, chapter, or track number.

Selecting numbers

Selecting 1~10:

Press the relevant button between 1 and 10.

Selecting 11 or higher:

To select 13: Press +10 → 3 .

To select 24: Press +10 → +10 → 4.

To select 40: Press +10 → +10 → +10 → 10.

The specified title, chapter, or track number appears on the display window, and playback begins from that location.

- You can also see the selected title, chapter, or track number on the on-screen display.

Notes:

- When ◻ appears on the TV.
The title, chapter, or track you have selected is not contained in the disc.
- This function does not work during Video CD/SVCD playback with PBC function.

To play from the beginning of a title, chapter, or track



The beginning of previous or later titles, chapters, or tracks may be skipped.

- For DVD: During playback
- For Audio CD: During playback or while stopped
- For Video CD/SVCD: During playback without PBC function or while stopped

From the remote control only:

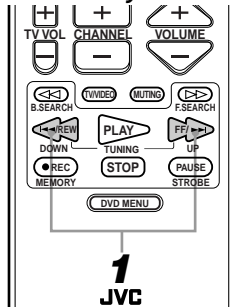

1 Press ►► or ◀◀.

- Press ►► the required number of times to move to a later title, chapter, or track.
- Press ◀◀ the required number of times to return to the previous title, chapter, or track.
- Press ◀◀ once to return to the beginning of the title, chapter, or track currently playing.

Notes:

- Press ►► or ◀◀ on the center unit for the same operation.
- This function may not work with some DVD discs.
- This function does not work during Video CD/SVCD playback with PBC function.

To specify the chapter number for playback [CHAP. SEARCH]

DVD

If the current title of a DVD disc being played is divided into chapters, you can skip to a desired chapter by specifying the chapter number using the on-screen display.

- During playback

From the remote control only:

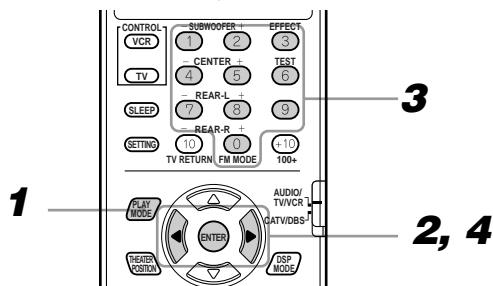

1 Press PLAY MODE.

The on-screen display appears on the TV.

2 Press the ◀/► cursors to move the pointer to [CHAP. SEARCH], then press ENTER.

“GO TO CHAPTER = ” appears under the menu.

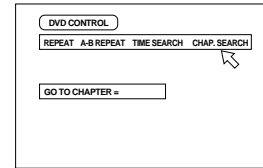

3 Press the number buttons (0 ~ 9) to enter the desired chapter number.

The selected chapter number appears in the message area.

Example:

To select chapter number 8: Press 8.

To select chapter number 37: Press 3 → 7.

4 Press ENTER.

The center unit starts playback from the selected chapter.

To return to the regular display

Press PLAY MODE again.

Notes:

- When the chapter number is incorrect in step 3: Overwrite the incorrect number with the correct number.
- When ◻ is displayed in the TV screen in step 4: The chapter you have selected is not contained in the disc, or chapter search does not work on the disc.
- With some discs, the center unit automatically starts searching for the chapter after entering the chapter number in step 3.

Using the DVD player

To specify the time for playback [TIME SEARCH]



You can play a disc from the desired position by specifying the elapsed time from the beginning of the disc use the TIME SEARCH function.

Note that some DVD discs do not contain time information, and the TIME SEARCH function cannot be used.

- For DVD: During playback
- For Audio CD: During playback
- For Video CD/SVCD: During playback without PBC function

From the remote control only:

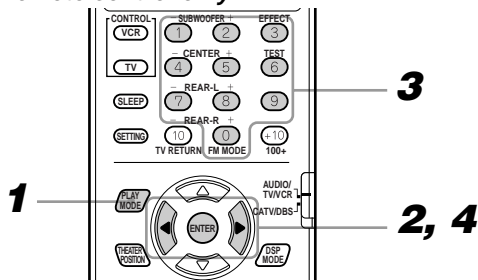

1 Press PLAY MODE.

The on-screen display appears on the TV.

2 Press the ◀/▶ cursors to move the pointer to [TIME SEARCH], then press ENTER.

“GO TO” appears under the menu.

(for DVD)

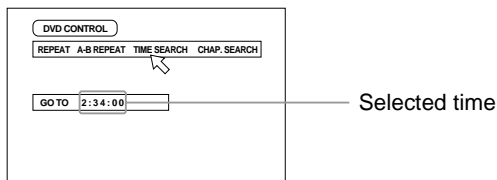

Selected time

(for Audio CD)

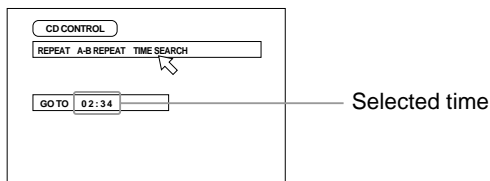

Selected time

(for Video CD/SVCD)

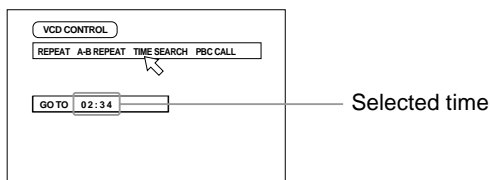

Selected time

3 Use the number buttons (0~9) to enter the time.

The specified time appears in the message area.

Example (for DVD):

To playback from 2(H):34(M):00(S)

You do not have to press “0” to enter the trailing zeros (for the last two digits in the example). Of course, it is possible to enter them.

- You can specify the time in hour/minute/second format for DVD discs, and in minute/second format for Audio, Video CDs and SVCDs.

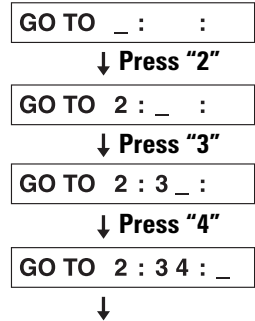

Press ENTER

When you make a mistake:

Press the ◀ cursor to move the cursor to an incorrect number and enter the correct number.

4 Press ENTER.

The center unit starts playback from the selected time.

To return to the regular display

Press PLAY MODE again.

Notes:

- When ⊗ appears on the TV in step 2: The time you have selected is not contained on the disc, or the TIME SEARCH function does not work on the disc.
- During program play or random play, the TIME SEARCH function does not work.

To select the screen for playback from the digest screen [DIGEST]



The center unit can display the opening scene of each title or chapter on a DVD or each track of a Video CD or SVCD.

You can select a desired title, chapter or track from the opening scenes displayed on the TV.

- For DVD: While stopped or during playback
- For Video CD/SVCD: While stopped or during playback without PBC function.

From the remote control only:

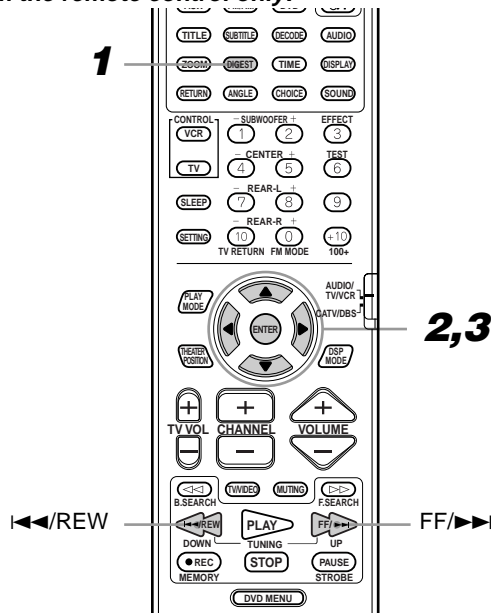

1 Press DIGEST.

- **DVD is stopped**

Up to nine first scenes of each title may be displayed.

- **DVD is playing**

Up to nine first scenes of each chapter in the current title may be displayed.

- **Video CD/SVCD**

Up to nine first scenes of each track may be displayed.



2 Press the ◀/▶/▲/▼ cursors to select the desired title, chapter, or track.

When the disc contains more than 9 titles, chapters, or tracks, the digest screen will have more than one page.

In this case, display a different page of the digest with the method described below.

To display the next page: Press ▶▶▶.

To display the previous page: Press ◀◀◀.

Or

When the selected title, chapter or track is in the upper left-hand corner of the screen, press the ◀ cursor.



When the selected title, chapter, or track is in the lower right-hand corner for the screen, press the ▶ cursor.

3 Press ENTER.

The center unit starts playback from the selected title, chapter or track.

To return to the regular display before pressing ENTER in step 3:
Press DIGEST again.

Note:

- With some discs, depending on the contents, it may take some time until all the scenes appear on the screen.

To advance the picture one frame at a time



Advancing a paused still picture one frame at a time.

- During playback

From the remote control:

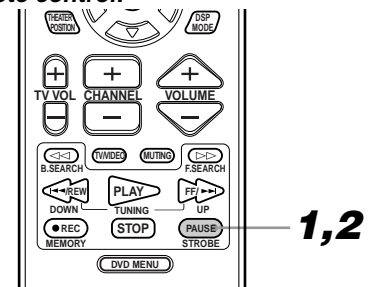

1 Press PAUSE at the location at which the picture is to be advanced.

The picture is paused.

2 Press PAUSE again.

Each time you press PAUSE, the still picture advances to the next frame.

Press PLAY to return to normal playback.

Note:

- You can perform the above operation using || button on the center unit.

Using the DVD player

Slow-Motion Playback [SLOW]

□ During playback

From the remote control only:

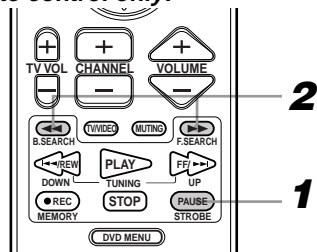

1 Press **PAUSE** at the section you wish to view in slow motion.

The image will pause.

2 Press **▶▶** or **◀◀**.

Pressing **▶▶** will playback your selection in slow motion, starting from the paused frame.

Pressing **◀◀** will playback your selection in reverse slow motion (DVD only).

Each time you press either button during slow-motion, the playback speed will increase as follows:

Forward: 1/32 → 1/16 → 1/8 → 1/4 → 1/3 → 1/2

Reverse: 1/16 → 1/12 → 1/8 → 1/4 → 1/3

Pausing slow-motion playback

Press **PAUSE** to pause slow-motion playback.

Restoring regular playback

Press **PLAY** to resume normal playback.

Notes:

- Audio is automatically muted during slow-motion playback.
- Video CDs and SVCDs cannot be played in reverse slow-motion.

To display Continuous Photos [STROBE]

Nine still pictures may be displayed one after the other.

□ During playback

From the remote control:

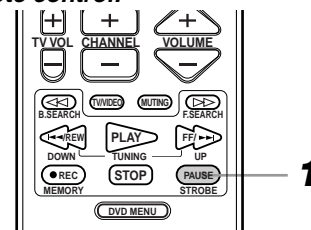

1 Press **PAUSE** continuously to display continuous photos.

When the screen appears displaying the nine pictures, release **PAUSE**.

The screen plays back the nine pictures in strobe-like action.

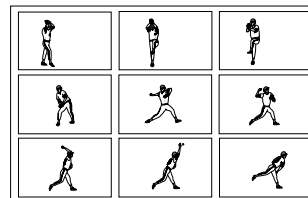

- Press **PAUSE** during strobe playback to pause.
- Press **PAUSE** to display the next nine still pictures.
- Press **PLAY** to resume strobe playback.

To clear the strobe screen, press **PAUSE** continuously until the normal screen appears.

Notes:

- Audio is not played during strobe playback.
- You can perform the above operation using **||** button on the center unit.

Zooming a scene [ZOOM]



□ During playback or while paused.

From the remote control only:

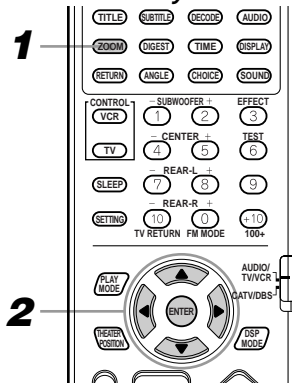

1 Press ZOOM.

“ZOOM” appears on the TV.

The unit zooms in to the center part of the scene to produce a double-sized image.

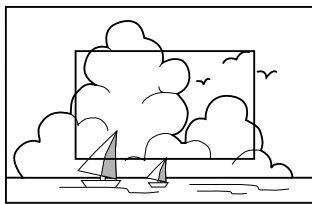

ZOOM



2 Press the ◀/▶/▲/▼ cursors to move the zoomed-in scene.

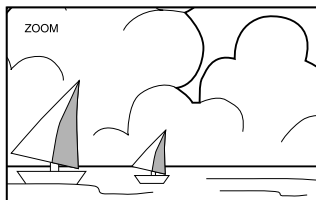

To pause zoom play

Press PAUSE.

To resume zoom play, press PLAY.

To return to normal playback

Press ZOOM again.

Note:

- During Zoom play, the picture may be garbled or noisy.

Changing the Subtitle Language [SUBTITLE]



Some DVD and SVCD discs contain subtitles. With such discs, you can choose which kind of subtitles to display (or turn off subtitles entirely). At the beginning of subtitled parts, appears on the TV.

□ During playback

From the remote control only:

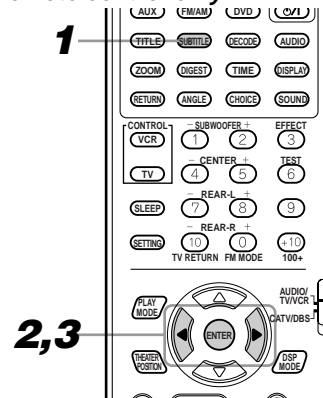

1 Press SUBTITLE.

The on-screen display appears on the TV.

2 Press the ◀/▶ cursors to select the desired subtitle.

Each time you press the ◀/▶ cursors, the subtitle changes.

Example for DVD:

1/3 ENGLISH
↓
2/3 FRENCH
↓
3/3 SPANISH
↓
-/3 (off)

(DVD)

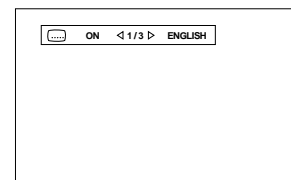

Example for SVCD:

APAGAR -/4
↓
1/4
↓
2/4
↓
3/4
↓
4/4

(SVCD)

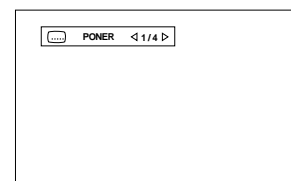

- For SVCD, four subtitle channels are selectable regardless of whether the subtitles are recorded or not.

3 Press ENTER.

The Subtitle selection display disappears on the TV.

Turning subtitles ON/OFF

Press SUBTITLE.

Pressing SUBTITLE toggles subtitle display ON and OFF.

Notes:

- When appears on the TV: You cannot select the subtitle.
- The selected language may be abbreviated on the TV. See “Appendix A: Table of languages and their abbreviations” in this manual.
- The Subtitle selection display will automatically disappear if you do not change the subtitle for 10 seconds.

Using the DVD player

Changing the audio language or sound [AUDIO]

DVD

Some DVD discs contain multiple audio tracks. With such discs, you can choose which audio track to listen to during playback. At the beginning of "multi-audio language" parts,  appears on the TV.

During playback

From the remote control only:

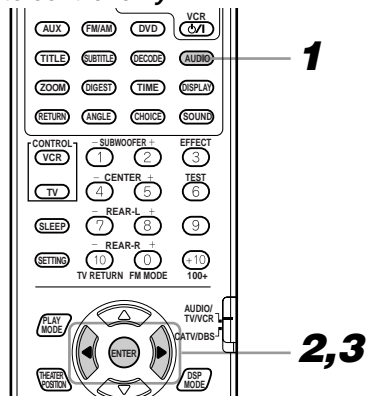

1 Press AUDIO.

The on-screen display appears on the TV.

2 Press AUDIO or the cursors to select the desired audio language or sound.

Each time you press the button, the audio language or sound changes.

Example:

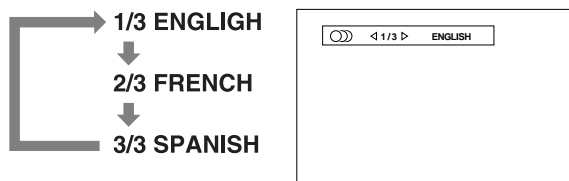

3 Press ENTER.

The Audio selection display disappears on the TV.

Notes:

- When  appears on the TV: You cannot select the audio.
- The selected language may be abbreviated on the TV. See "Appendix A: Table of languages and their abbreviations" in this manual.
- The Audio selection display will automatically disappear if you do not change the audio for 10 seconds.

Changing the audio channel [AUDIO]

Video CD Super VCD

For in some karaoke Video CDs and SVCDs, one of the audio channels includes a vocal while the other does not. With such discs, you can choose to enjoy karaoke without the vocal or with the vocal by selecting the audio channel to be played back.

During playback

From the remote control only:

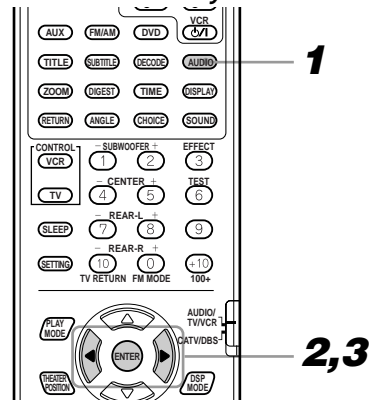

1 Press AUDIO.

The on-screen display appears on the TV.

2 Select the audio channel(s) to be played back using AUDIO or the cursors.

Each time you press the button, the audio channel changes.

Example for Video CD:

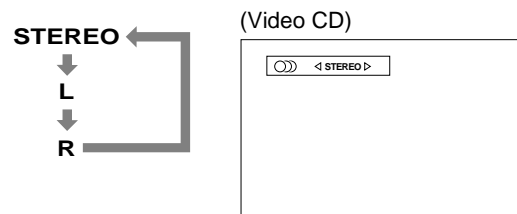

STEREO: You hear normal stereo playback.

L: You hear the L (Left) channel signal played back from both the left and right speakers.

R: You hear the R (Right) channel signal played back from both the left and right speakers.

Example for SVCD:

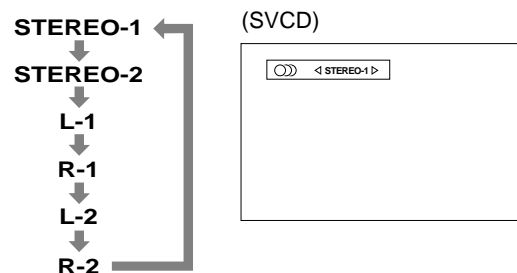

STEREO-1: You hear normal stereo playback of Stereo-1.

STEREO-2: You hear normal stereo playback of Stereo-2.

L-1: You hear the L-1 (Left-1) channel signal played back from both the left and right speakers.

R-1: You hear the R-1 (Right-1) channel signal played back from both the left and right speakers.

L-2: You hear the L-2 (Left-2) channel signal played back from both the left and right speakers.

R-2: You hear the R-2 (Right-2) channel signal played back from both the left and right speakers.

3 Press ENTER.

The Audio selection display disappears on the TV.

Notes:

- When  appears on the TV: You cannot select the audio.
- The Audio selection display will automatically disappear if you do not change the audio for 10 seconds.

Viewing from Multiple Angles [ANGLE]

DVD

You can enjoy a variety of scene angles if the DVD disc contains "multi-angle" parts, where multiple cameras were used to shoot the same scene from different angles. You can select one of these viewing angles from the normal screen or on-screen display. At the beginning of "multi-angle" parts,  appears on the TV.

Using the ANGLE button

During playback

From the remote control only:

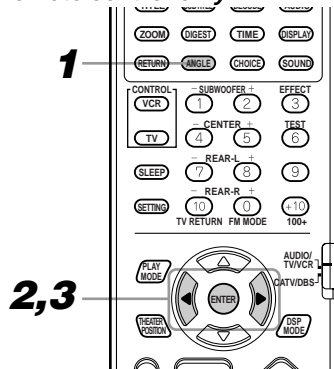

1 Press ANGLE.

The on-screen display appears on the TV.

2 Press ANGLE or the cursors to select the desired angle.

Each time you press the button, the angle changes.

Example:

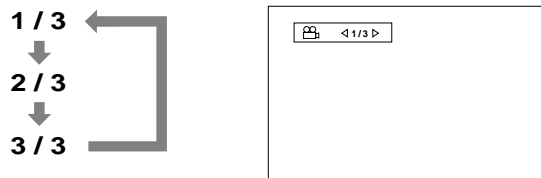

3 Press ENTER.

The Angle selection display disappears on the TV.

Note:

- When  appears on the TV:
The current scene is not recorded from multiple angles.
- The Angle selection display will automatically disappear if you do not change the angle for 10 seconds.

Selecting an angle from the angle list display

During playback

From the remote control only:

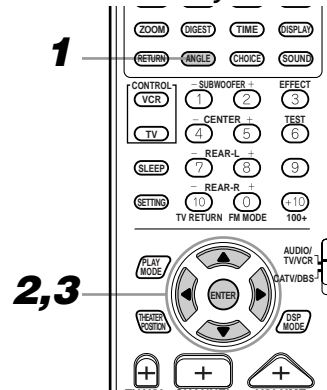

1 Hold down ANGLE for more than 1 second.

Up to nine camera angles recorded on a disc appear on the TV.

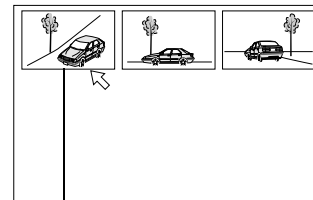

The selected camera angle

2 Press the /▲/▼ cursors to select the desired angle.

3 Press ENTER.

The selected angle appears on the TV.

Note:

- When  appears on the TV:
The current scene is not recorded from multiple angles.
- During the operation above, audio is muted.

Using the DVD player

Selecting the Picture Character [THEATER POSITION]



You can select the quality of the image from among four options (OFF, 1, 2, and 3) according to the type of programming, picture tone or personal preferences.

□ During playback

From the remote control only:

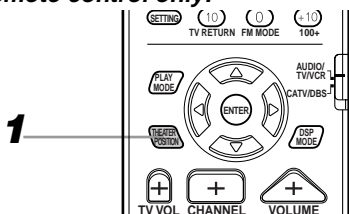

1 Press THEATER POSITION to select the desired picture character.

Each time you press the button, the picture character changes as follows:

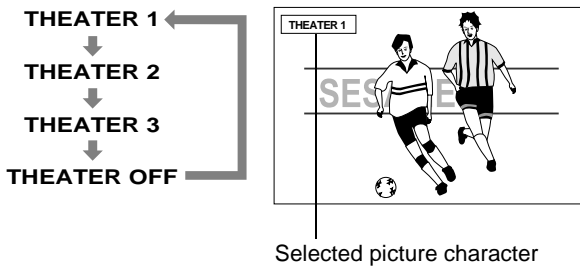

“THEATER OFF” is the normal position. Selecting a higher number results in a darker picture character.

To turn off the on-screen display

Press ENTER.

- The THEATER POSITION screen will automatically close if left idle for more than 5 seconds.

Repeating a current title, chapter or track, or all tracks [REPEAT]



- For DVD: During playback
- For Audio CD: During playback or while stopped
- For Video CD/SVCD: During playback without PBC function or while stopped

From the remote control only:

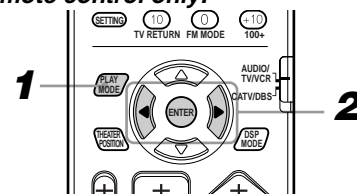

1 Press PLAY MODE.

The on-screen display appears on the TV.

2 Press the ◀/▶ cursors to move the pointer to [REPEAT], then press ENTER.

Each time you press ENTER, the repeat mode changes as follows:

For DVD

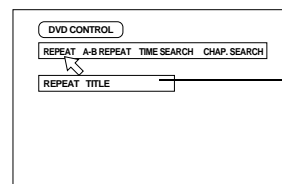

The selected repeat mode appears on the TV.

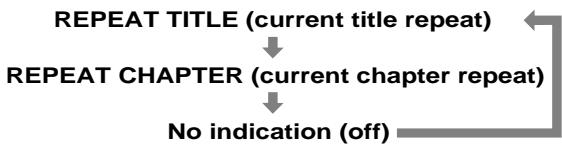

The current title or chapter will be repeated.

For Audio CD, Video CD, and SVCD (for Audio CD)

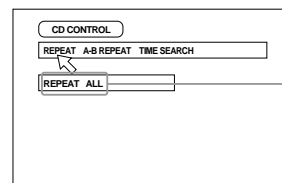

Selected repeat mode

(for Video CD/SVCD)

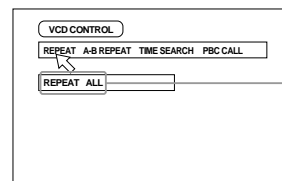

Selected repeat mode

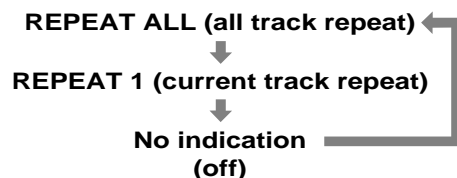

The current track or all tracks is/are played repeatedly.

To stop repeat playback

Press STOP.

- When a DVD disc is set, the center unit stops playback and quits repeat mode.
- When an Audio, Video CD, or SVCD is set, the center unit stops playback but remains in repeat mode.

To quit repeat playback without stopping playback

Move the pointer to [REPEAT] and press ENTER repeatedly until the [REPEAT] display turns off.

To turn off the on-screen display

Press PLAY MODE.

Notes:

- If  appears when pressing ENTER in step 2 during DVD playback. You cannot repeat the title or chapter because of the disc contents.
- With some DVD discs, repeat function does not work.
- Repeat play function cannot be used during Video CD or SVCD playback with PBC function.

Repeating a desired part [A-B REPEAT]



□ During playback

From the remote control only:

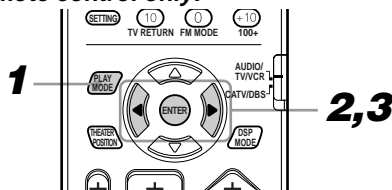

1 Press PLAY MODE.

The on-screen display appears on the TV.

2 Press the cursors to move the pointer to [A-B REPEAT], then press ENTER at the beginning of the part you want to repeat (point A).

3 Press ENTER at the end of the part you want to repeat (point B).

The unit locates "A" and starts repeat playback between "A" and "B".

(for DVD)

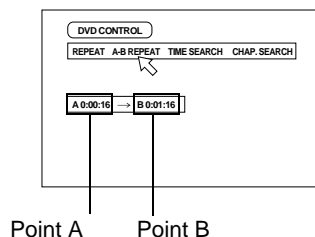

(for Audio CD)

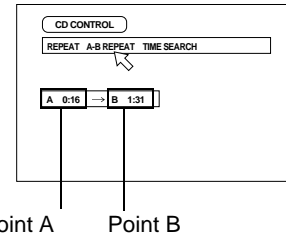

(for Video CD/SVCD)

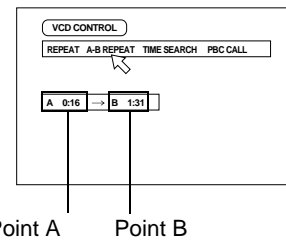

To quit A-B repeat playback

Press STOP. The center unit stops playback and quits A-B repeat mode.

Quitting A-B repeat mode without stopping playback

Move the pointer to [A-B REPEAT] and press ENTER. Pressing the  will also quit A-B repeat mode.

To turn off the on-screen display

Press PLAY MODE.

Notes:

- If  appears when pressing ENTER in step 2 during DVD playback. You cannot repeat the selected portion because of the disc contents.
- The A-B REPEAT function cannot be used during program or random playback.
- With DVD discs, A-B repeat playback is possible only within a single title.

Using the DVD player

Programming the Playing Order [PROGRAM]



You can play titles or tracks on a disc in the desired order using the Program function.

□ While stopped

From the remote control only:

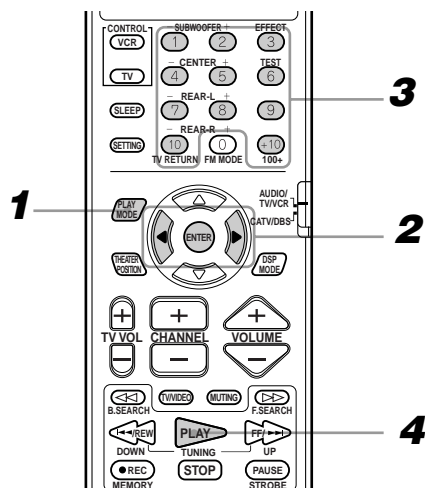

1 Press PLAY MODE.

The on-screen display appears on the TV.

2 Press the ◀/▶ cursors to move the pointer to [PROGRAM] and press ENTER.

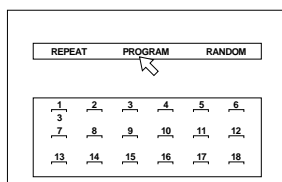

The program table appears under the menu bar (as shown above).

The PROGRAM indicator appears on the display window.

3 Select the titles or tracks in the desired order using the number buttons (1~10, +10).

Up to 18 titles or tracks can be programmed. You may select the same titles or track more than once.

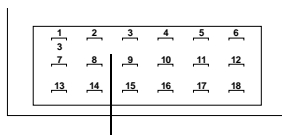

The programmed title/track number is shown under each program number.

Selecting numbers

Selecting 1~10:

Press the relevant button between 1 and 10.

Selecting 11 or higher:

To select 13: Press +10 → 3 .

To select 24: Press +10 → +10 → 4.

To select 40: Press +10 → +10 → +10 → 10.

If you mistakenly select the wrong title or track number press STOP to delete the entered program.

Then re-select the titles or tracks you wish.

4 Press PLAY to start program play.

When all of the programmed titles or tracks have finished playback, the center unit stops. Since the program remains, program playback can be used again.

- You can use repeat playback together with program playback for DVDs, Audio CDs, Video CDs and SVCDs. Select REPEAT ALL to repeatedly play back the all programmed tracks. For details, see page 34.

To turn off the on-screen display

Press PLAY MODE.

To quit program playback and clear the program

Press STOP and then PLAY MODE to display the on-screen on the TV. Then, press STOP once again. Now, the program is cleared. Then, press ENTER.

The PROGRAM indicator on the display window goes off.

Turning off the power, switching source, or opening the disc cover will also clear the program.

To temporarily exit program playback and clear the program.

There are two ways to do this operation:

- While stopped and the on-screen play mode menu is not displayed on TV, press STOP.
- While stopped, press PLAY MODE to display the on-screen on the TV. Then, move the pointer to [PROGRAM] and press ENTER to exit the program playback. Since the program remains, program playback can be used again.

Notes:

- With some DVD discs, program playback does not work.
- During program playback, you can skip to the next title or track by pressing ►►. Also, you can skip back to the beginning of the current title or track by pressing ◀◀. (You cannot skip back to the previous title or track.)
- During program playback, you can see the current title or track by pressing the PLAY MODE. The current title or track illuminates in yellow on the on-screen display. (To turn off the on-screen display, press PLAY MODE again.)

Random Play [RANDOM]



You can play titles or tracks in random order.

- While stopped

From the remote control only:

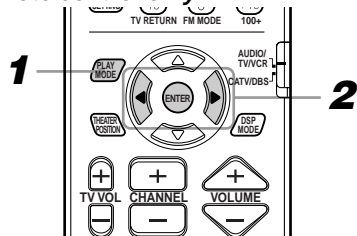

1 Press PLAY MODE.

The on-screen display appears on the TV.

2 Press the ◀▶ cursors to move the pointer to [RANDOM] and press ENTER.

“RANDOM” appears on the display window, and random playback begins.

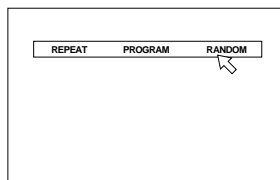

- When all tracks have been played once, random play ends.
- You can use repeat playback together with random playback. Select REPEAT ALL to repeatedly play back the all tracks on the disc. For details, see page 34.

To quit random playback

Press STOP.

Note:

- The same track will not be played back more than once during random play.

To check the DVD function status



You can check the DVD function status of the DVD disc.

- During DVD playback

From the remote control only:

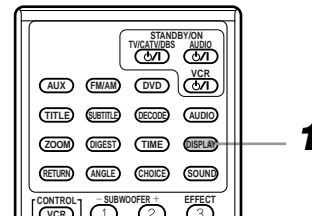

1 Press DISPLAY once.

The on-screen display appears on the TV, and the current selections of the camera angle, audio language and subtitle language are displayed.

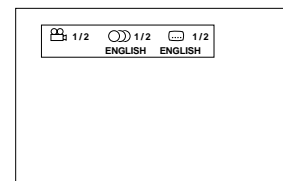

To turn off the DVD function status display

Press DISPLAY twice.

Using the DVD player

To check the disc information



You can check the disc information of the disc.

□ During playback

From the remote control only:

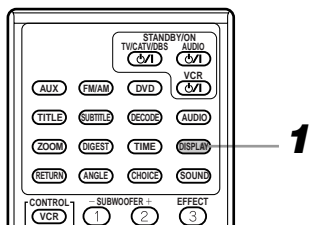

1 Press DISPLAY once for a Audio CD, Video CD, or SVCD or twice for a DVD disc.

The disc information display appears on the TV.

(for DVD)

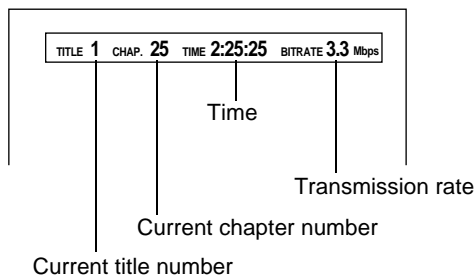

(for Audio CD or Video CD/SVCD playing without PBC)

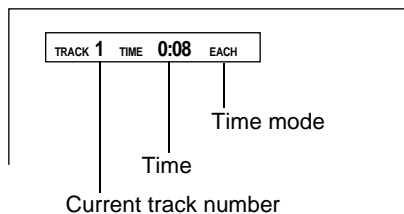

(for Video CD/SVCD playing with PBC)

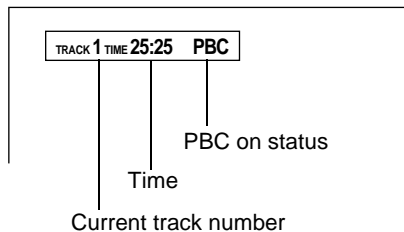

To turn off the on-screen display

Press DISPLAY again.

Note:

- With DVD discs, you can directly enter the disc information on-screen by pressing TIME during playback.

To check the time information



You can check the time information of the disc.

□ For Audio CD: During playback

For Video CD/SVCD: During playback without PBC function.

From the remote control only:

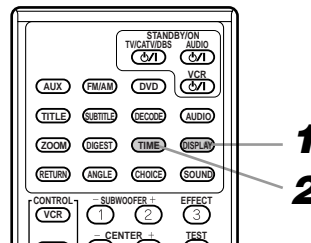

1 Press DISPLAY once.

The time information display appears on the TV.

2 Press TIME.

Each time you press the button, the time indication changes as follows:

For Audio CD

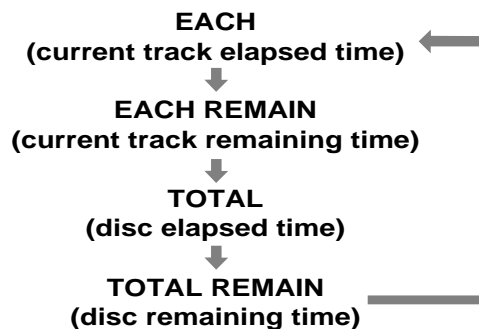

For Video CD/SVCD playing without PBC



The selected time information is displayed on the TV, as well as on the display window.

To turn off the on-screen display

Press DISPLAY again.

To check time on the display window

You can check the time information on the display window, rather than using the on-screen menu.

- During playback or while stopped

From the remote control only:

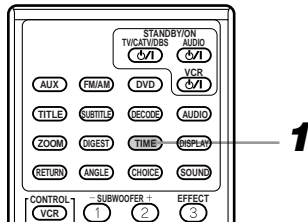

1 Press TIME repeatedly.

Each time you press the button, the time indication changes as follows:

→ EACH → EACH REMAIN → No indication (TOTAL) → REMAIN → (back to the beginning)

The time indicator (REMAIN/EACH) lights up on the display window.

During playback

REMAIN: Disc remaining time

TOTAL: Disc elapsed time

EACH: Current track elapsed time

EACH REMAIN: Current track remaining time

While stopped

REMAIN: Total playback time of the disc

EACH/TOTAL: 0:00

EACH REMAIN: Playback time of the current track

By pressing ►► or ◀◀, playback time for other tracks can be checked.

Receiving radio broadcasts

You can browse through all the stations or use the preset function to go immediately to a particular station.

IMPORTANT

When using the remote control, check to see if its remote control mode selector is set to the correct position:
To operate this unit, set it to "AUDIO/TV/VCR" (except when selecting the DBS tuner as the source).

Setting the AM tuner interval spacing

Some countries space AM stations 9 kHz apart, and other countries use 10 kHz spacing. When shipped, the spacing is set to 10 kHz. If your country uses 9 kHz spacing, you have to set the AM tuner interval spacing to 9 kHz to receive an AM broadcast.

To select the 10 kHz interval

Press FM/AM on the remote control to turn on the AM indicator on the display window. Next, on the center unit, hold down **◀◀** and press **■**. "AM-10 kHz" appears on the display window. Now the 10 kHz interval is selected.

To select the 9 kHz interval

Press FM/AM on the remote control to turn on the AM indicator on the display window. Next, on the center unit, hold down **◀◀** and press **■**. "AM-9 kHz" appears on the display window. Now the 9 kHz interval is selected.

Tuning in stations manually

From the remote control only:

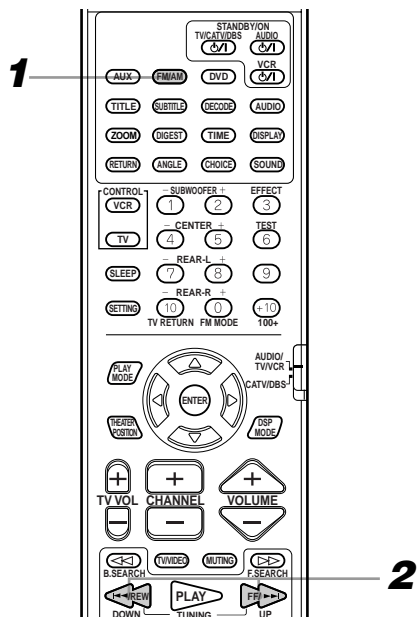

1 Press FM/AM to select the band.

Each time you press the button, the band alternates between FM and AM.

2 Press TUNING UP (FF/▶▶) or TUNING DOWN (◀◀/REW) repeatedly until you find the frequency you want.

- When you hold down the button, the frequency keeps changing. When you releases the button, tuning automatically stops at the next station of sufficient signal strength.

You can use the sound effect, if you want. See "Using the DSP Modes [DSP MODE]" on page 20.

Note:

- When a station of sufficient signal strength is tuned in, the **TUNED** indicator lights up on the display window.
- When an FM stereo program is received, the **STEREO** indicator also lights up.
- On the unit, FM and AM can be selected by repeatedly pressing **SOURCE**. The frequency last tuned appears on the display window, but you cannot tune in to the other station using **▶▶** or **◀◀** on the center unit.

Using preset tuning

Once a station is assigned to a channel number, the station can be quickly tuned. You can preset up to 30 FM and 15 AM stations.

To store the preset stations

Before you start, remember...

- There is a time limit in doing the following steps. If the setting is canceled before you finish, start from step 1 again.

From the remote control only:

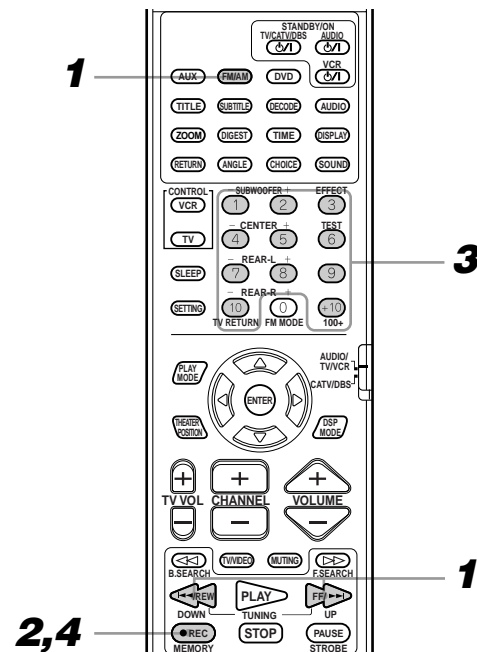

1 Tune in the station you want to preset (see "Tuning in stations manually").

If you want to store the FM reception mode for this stations, select the FM reception mode you want. See "Selecting the FM reception mode" on page 41.

2 Press MEMORY (● REC).

"CH - -" flashes and the channel number position starts flashing on the display window for about 10 seconds.

3 Use the number buttons (1~10, +10) to select a channel number while the channel number position is flashing.

- For channel number 5, press 5.
- For channel number 15, press +10 → 5.
- For channel number 20, press +10 → 10.
- For channel number 30, press +10 → +10 → 10.

4 Press MEMORY (● REC) again while the selected channel number is flashing .

The selected channel number stops flashing.
The station is assigned to the selected channel number.

FM
CH 1 103.5 MHz

5 Repeat steps 1 to 4 until you store all the stations you want.

To erase a stored preset station

Storing a new station on a used number erases the previously stored one.

Note:

- The preset stations will be erased in a few days, if the system is unplugged or power failure occurs.

To tune in a preset station

From the remote control only:

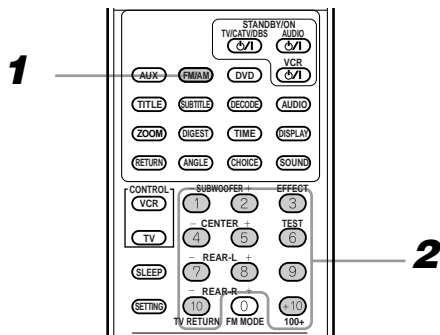

1 Press FM/AM.

Each time you press the button, the band alternates between FM and AM.

2 Press the number buttons (1~10, +10) to select a preset channel number.

- For channel number 5, press 5.
- For channel number 15, press +10 → 5.
- For channel number 20, press +10 → 10.
- For channel number 30, press +10 → +10 → 10.

Selecting the FM reception mode

When an FM stereo broadcast is hard to receive or noisy
You can change the FM reception mode while receiving an FM broadcast.

- You can store the FM reception mode for each preset station.

From the remote control only:

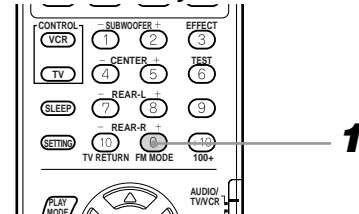

1 Press FM MODE.

Each time you press the button, the FM reception mode alternates between "AUTO" and "MONO."

AUTO: "AUTO MUTING" appears on the display window and the AUTO MUTING indicator lights up on the display window.

When a program is broadcasted in stereo, you will hear stereo sound; when in monaural, you will hear monaural sounds. This mode is also useful to suppress static noise between stations.

MONO: "MONO" appears on the display window and the AUTO MUTING indicator goes off on the display window.

Reception will be improved although you will lose the stereo effect. In this mode, you will hear noise while tuning into the stations.

Beat cut

When listening to an AM broadcast with a lot of noise interference, you can change the BEAT CUT mode to reduce the noise.

From the remote control only:

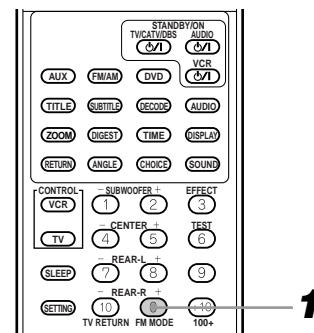

1 Press FM MODE.

Each time you press the button, operation toggles between "BEAT CUT 1" and "BEAT CUT 2" on the display window. Choose the setting that gives clearer sound.

Preference settings

You can set various preferences for playback via three dedicated on-screen displays.

Using the preference setting menus

The procedure how to set the preferences is explained here.

From the remote control only:

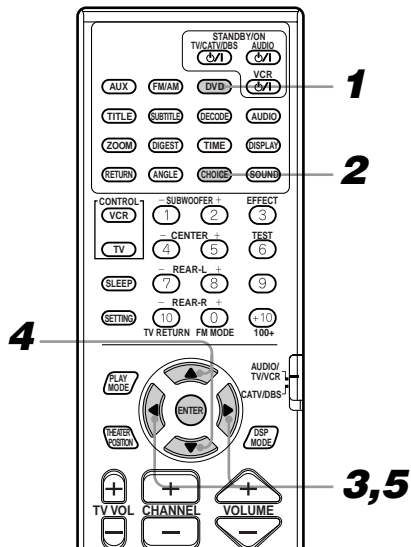

1 Press DVD.

If no disc is inserted, proceed to the next step.
If a DVD, Video CD or SVCD disc is inserted, press STOP.
If an Audio CD disc is inserted, remove it.

2 Press CHOICE.

One of the preference menus appears on the TV.
There are three preference menus: LANGUAGE, DISPLAY and SYSTEM.

3 Move the pointer to the desired tab using the ◀/▶ cursors.

The selected preference menu opens.

4 Move the pointer to the desired item using the ▲/▼ cursors.

5 Press the ◀/▶ cursors to select the desired option in the item.

When you select one of options, it is set for the item.

6 Repeat settings for other items.

- To continue settings in the same menu screen, repeat steps 4 and 5.
- To change the menu screen, press the ▲/▼ cursors until the pointer moves to the tab.

To close the preference menu screen

Press CHOICE again.

Or

Move the pointer to "EXIT" by pressing the ▲/▼ cursors, then press ENTER.

On-screen menu components

Referred to as a "tab".

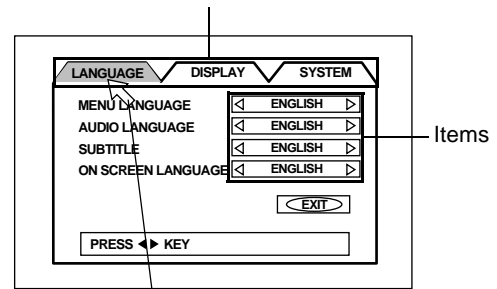

This arrow is referred to as a "pointer".

LANGUAGE

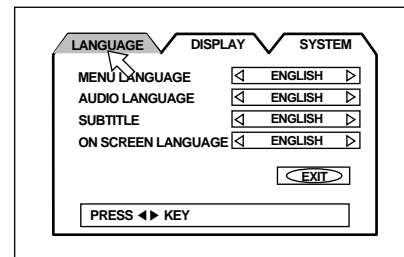

DISPLAY

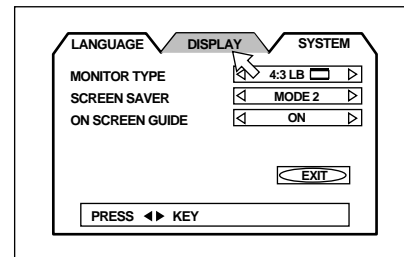

SYSTEM

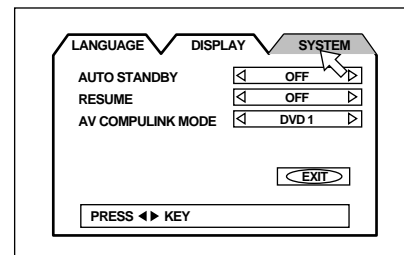

LANGUAGE MENU settings

Choosing menu language

Some DVD discs feature menu display in multiple languages. With these discs, it is possible to set the default language for menu display.

1 Open the LANGUAGE menu.

See "Using the preference setting menus" on page 42

2 Move the pointer to MENU LANGUAGE using the ▲/▼ cursors.

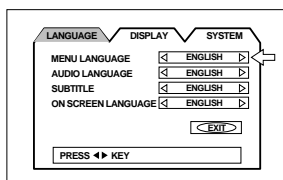

3 Press the ◀/▶ cursors to select a default menu language.

Pressing the cursors toggles between the following options.

↔ ENGLISH ↔ SPANISH ↔ FRENCH ↔ CHINESE ↔ GERMAN ↔ ITALIAN ↔ JAPANESE ↔ language code (AA ~ ZU) ↔

(See "Appendix A: Table of languages and their abbreviations".)

Note:

- When the selected language is not available on the disc, display will switch to an available language.

Choosing audio language

Some DVD discs feature audio playback in multiple languages. With these discs, it is possible to set the default language for audio playback.

1 Open the LANGUAGE menu.

See "Using the preference setting menus" on page 42.

2 Move the pointer to AUDIO LANGUAGE using the ▲/▼ cursors.

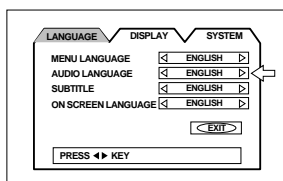

3 Press the ◀/▶ cursors to select a default menu language.

Pressing the cursors toggles between the following options.

↔ ENGLISH ↔ SPANISH ↔ FRENCH ↔ CHINESE ↔ GERMAN ↔ ITALIAN ↔ JAPANESE ↔ language code (AA ~ ZU) ↔

(See "Appendix A: Table of languages and their abbreviations".)

Note:

- When the selected language is not available on the disc, audio playback will switch to an available language.

Choosing subtitle language

Some DVD discs feature subtitle display in multiple languages. With these discs, it is possible to set the default language for subtitle display.

1 Open the LANGUAGE menu.

See "Using the preference setting menus" on page 42.

2 Move the pointer to SUBTITLE LANGUAGE using the ▲/▼ cursors.

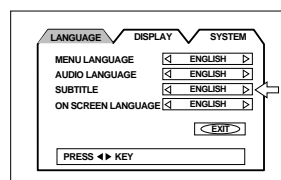

3 Press the ◀/▶ cursors to select a default menu language.

Pressing the cursors toggles between the following options.

↔ ENGLISH ↔ SPANISH ↔ FRENCH ↔ CHINESE ↔ GERMAN ↔ ITALIAN ↔ JAPANESE ↔ language code (AA ~ ZU) ↔

(See "Appendix A: Table of languages and their abbreviations".)

Note:

- When the selected language is not available on the disc, subtitle display will switch to an available language.

Choosing on-screen language

You can select the on-screen display language to be displayed.

1 Open the LANGUAGE menu.

See "Using the preference setting menus" on page 42.

2 Move the pointer to ON SCREEN LANGUAGE using the ▲/▼ cursors.

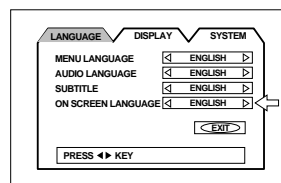

3 Press the ◀/▶ cursors to select the on-screen language you want to display.

ENGLISH
↕
中国语 (Chinese)
↕
ESPAÑOL (Spanish)

English	ON SCREEN LANGUAGE	◀ ENGLISH ▶
Chinese	说明字幕	◀ 中国语 ▶
Spanish	IDIOMA EN PANTALLA	◀ ESPAÑOL ▶

DISPLAY MENU settings

Select monitor type

Most movie DVD discs are recorded for wide-screen TVs with a height/width ratio of 16:9. It is possible to optimize playback of these wide-screen TV images for viewing on a regular TV with a height/width ratio of 4:3.

1 Open the DISPLAY menu.

See "Using the preference setting menus" on page 42.

2 Move the pointer to MONITOR TYPE using the ▲/▼ cursors.

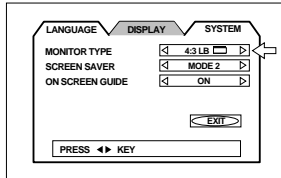

3 Press the ◀/▶ cursors to select monitor type.

Pressing the cursors toggles between the following monitor configurations.

4:3 LB (Letter Box Conversion):



Select this option for playback on a TV with a height/width ratio of 4:3.

The image will be displayed with a black bar at the top and bottom of the screen. The left and right edges of the image are preserved.

4:3 PS (Pan-scan Conversion):

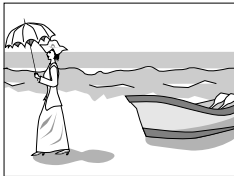

Select this option for playback on a TV with a height/width ratio of 4:3.

The image will be displayed with the right and left edges cropped. No black gap will appear at the top and bottom of the screen.

16:9 WIDE (Wide Television Screen 16:9):



Select this option for playback on a wide-screen TV.

Note:

- If the DVD disc is not optimized for Pan-scan, the image will be shown in 4:3 LB (Letter Box Conversion), even if 4:3 PS (Pan-scan Conversion) is selected.

Screen saver settings

Set the screen saver to prevent screen burn.

1 Open the DISPLAY menu.

See "Using the preference setting menus" on page 42.

2 Move the pointer to SCREEN SAVER using the ▲/▼ cursors.

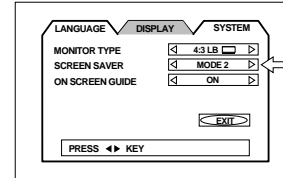

3 Press the ◀/▶ cursors to select a screen saver mode.

Pressing the cursors toggles between the following screen saver modes:

MODE 1: The picture gets dark.

MODE 2: The "screen saver" picture appears and its brightness changes.

OFF: The screen saver function is off.

Notes:

- Please be wary of screen burn when the screen saver is turned OFF.
- The screen saver function does not work for Audio CDs.

On-screen guide settings

During DVD playback, an on-screen guide displaying symbols or letters over the DVD image can be set ON or OFF.

1 Open the DISPLAY menu.

See "Using the preference setting menus" on page 42.

2 Move the pointer to ON SCREEN GUIDE using the ▲/▼ cursors.

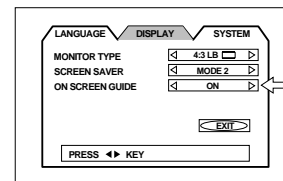

3 Press the ◀/▶ cursors to select ON or OFF.

Pressing the cursors toggles between ON and OFF.

ON: Icons and letters are displayed.

OFF: Icons and letters are not displayed.

Examples of "on-screen guide" icons or characters:



SYSTEM MENU setting

AUTO STANDBY

When the system is stopped for more than 30 minutes or 60 minutes in the source DVD, the system enters standby mode automatically.

1 Open the SYSTEM menu.

See "Using the preference setting menus" on page 42.

2 Move the pointer to AUTO STANDBY using the ▲/▼ cursors.

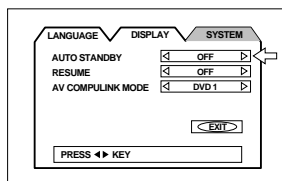

3 Press the ◀/▶ cursors to select the time.

Pressing the cursor toggles between the following options:

60: Time is set to 60 minutes.

30: Time is set to 30 minutes.

OFF: The auto standby function is off.

RESUME

You can select the resume function to be on or off. See page 25.

1 Open the SYSTEM menu.

See "Using the preference setting menus" on page 42.

2 Move the pointer to RESUME using the ▲/▼ cursors.

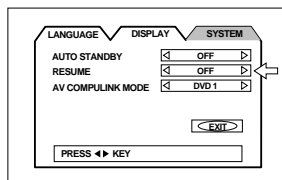

3 Press the ◀/▶ cursors to select ON or OFF.

Pressing the cursor toggles between "ON" and "OFF".

ON: Pressing PLAY while stopped or on standby starts playback from the resume point if it is memorized.

OFF: Pressing PLAY while stopped or on standby starts playback from the beginning of the disc.

AV COMPULINK MODE

If you use the AV Compulink system, you must set this item correctly.

1 Open the SYSTEM menu.

See "Using the preference setting menus" on page 42.

2 Move the pointer to AV COMPULINK MODE using the ▲/▼ cursors.

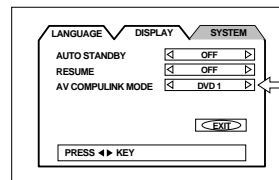

3 Press the ◀/▶ cursors to select DVD1, DVD2 or DVD3.

Select "DVD1," "DVD2" or "DVD3" according to the equipment to be connected. See page 53.

Note:

- If you do not use the AV Compulink system, this setting is not necessary.

Limiting playback by children

This function restricts playback of DVD discs which contain violent (and other) scenes according to the level set by the user. For example, if a movie which includes violent scenes supports the parental lock feature, such scenes which you do not want to let children view can be cut or replaced with other scenes.

To set Parental Lock for the first time [PARENTAL LOCK]

□ While a DVD disc is stopped or no disc is inserted

From the remote control only:

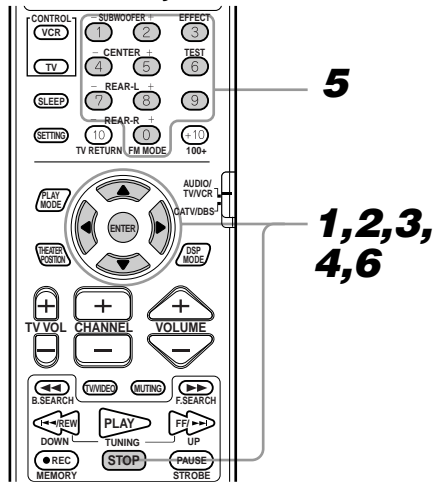

1 Press ENTER while holding down STOP.

The PARENTAL LOCK on-screen display appears on the TV.

2 Press the ▲/▼ cursors to move the pointer to "Country Code", then press the ◀/▶ cursors to select "BR" for country code and press ENTER or the ▼ cursor.

(See "Appendix B: Country code list for parental lock".)

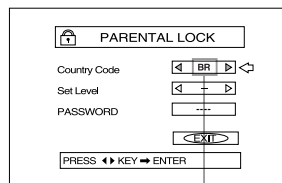

Country code

3 Press the ▲/▼ cursors to move the pointer to "Set Level", then press the ◀/▶ cursors to select the parental lock level.

Each time you press the ◀/▶ cursors, the parental level changes as follows:

→ "1" ~ "8" → "-" (No restriction) → (back to the beginning)

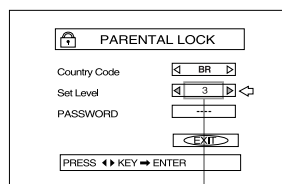

Selected level

- "1" is the strictest level.

Discs rated higher than the level you selected are restricted.

4 Press ENTER or the ▼ cursor.

5 Enter your 4-digit password using the number buttons (0~9).

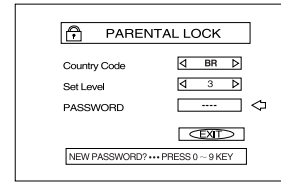

If you enter an undesired password, reenter the password.

6 Press ENTER.

The parental level and password are set. The pointer moves to "EXIT".

To turn off the PARENTAL LOCK on-screen display

Press ENTER again.

To change the settings

□ While a DVD disc is stopped or no disc is inserted

1 Press ENTER while holding down STOP.

The Parental Lock on-screen display appears on the TV.

2 Enter your current 4-digit password using the number buttons (0 to 9) and press ENTER.

If you enter the wrong password, "WRONG! RETRY....." appears on the TV, and you cannot go to next step.

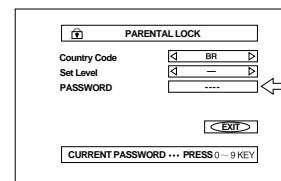

3 Use the ▲/▼ cursors to move the pointer to "Set Level", then use the ◀/▶ cursors to select the parental lock level.

4 Press ENTER.

5 Enter your new 4-digit password using the number buttons (0 to 9) and press ENTER.

The new setting is effective.

To turn off the PARENTAL LOCK on-screen display

Press ENTER again.

Notes:

- When you enter the wrong password more than 3 times in step 2 above, the pointer moves to "EXIT" automatically and the ▲/▼ cursors do not work. Press EXIT to exit Parental Lock on-screen and repeat from the first step.
- If you forget your password in step 2, enter "8888."

To temporarily release the Parental lock

When you set the parental level strictly, some discs may not be played back at all. When you insert such a disc and try to play it, the Parental Lock on-screen display appears on the TV, and the unit will ask you whether you want the parental lock to be temporarily released or not.

1 Use the ▲/▼ cursors to move the pointer to select YES or NO, then press ENTER.

If you select YES, the pointer moves to the PASSWORD field. When selecting NO, remove the disc.

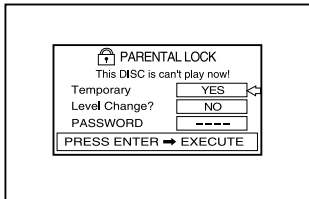

2 Enter your 4-digit password using the number buttons (0 to 9).

If you enter the wrong password, “WRONG! RETRY...” appears on the TV, and you cannot go to next step.

- The Parental lock is released, and the center unit starts playback.

Note:

- When you enter the wrong password more than 3 times in step 2 above, the pointer moves to “NO” automatically and the ▲/▼ cursors do not work. Press EXIT to exit Parental Lock on-screen and remove the disc.

Amplifier settings

Perform amplifier settings (balance, tone, speaker size and delay time, crossover frequency, LFE (Low Frequency Effect) level and dynamic range) for the powered sub-woofer unit to obtain optimum listening performance.

Note:

- Before starting settings, be sure that each speaker is properly installed and your listening position is fixed, since some setting items should be changed according to your listening position with respect to the installed speakers.

Basic operation for setting amplifier

The basic operation for setting each item is as follows:

- While stopped or during playback

From the remote control only:

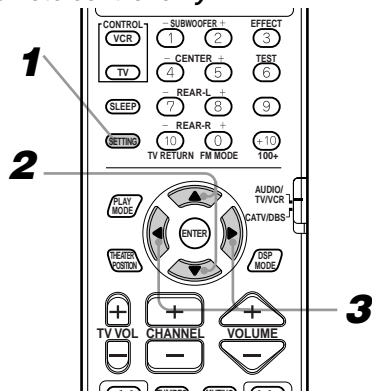

1 Press SETTING.

The system enters power amplifier setting mode and the setting item you have lastly selected appears on the display window.

2 Press the ▲/▼ cursors to select the desired item.

Each time you press the button, the setting item shown on the display window changes as follows:

↔ L/R BALANCE ↔ BASS ↔ TREBLE ↔ FRONT SPK ↔ CENTER SPK ↔ REAR SPK ↔ CENTER DELAY ↔ REAR DELAY ↔ CROSSOVER ↔ LFE ATT. ↔ D.RANGE COMP. ↔

L/R BALANCE

Balance between the right and left front speakers

BASS

Bass (low frequency sound) for the front speakers

TREBLE

Treble (high frequency sound) for the front speakers

FRONT SPK*

Setting the size of the front speakers

CENTER SPK*

Setting the size of the center speaker

REAR SPK*

Setting the size of the rear speakers

CENTER DELAY

Setting the delay time for the center speaker

REAR DELAY

Setting the delay time for the rear speakers

CROSSOVER*

When using a small speaker with weak bass as a front, center or rear speaker, you can redirect bass audio to the sub-woofer.

LFE ATT. LFE (Low Frequency Effect) attenuator

When bass sound is distorted while playing back the program recorded in Dolby Digital or DTS surround, you can lower the sound level using LFE attenuator.

D.RANGE COMP.

You can compress the dynamic range. This may be used when you play back surround effects at night. This function work only for the program recorded in Dolby Digital.

* When you use the supplied speakers with this system, you do not need to change the initial settings for these items.

3 Press the ◀/▶ cursors to select the desired option.

When you select one of options, it is set for the item.

To exit power amplifier setting mode

Press SETTING again.

Setting balance

Adjust the balance between the front L/R speakers.

1 Press SETTING.

The system enters power amplifier setting mode and the setting item you have lastly selected appears on the display window.

2 Press the ▲/▼ cursors until "L/R BALANCE" appears on the display window.

L/R BALANCE

- After a while, the current setting appears.

3 Within 5 seconds, press the ◀/▶ cursors to adjust the balance.

Each time you press the button, the balance level changes as follows:

R-21 to R-1 ↔ CNTR ↔ L-1 to L-21

- R-21 to R-1: The output from the right speaker decreases. (R-21: R channel signal is muted.)
- CNTR: The outputs from both speakers are the same.
- L-1 to L-21: The output from the left speaker decreases. (L-21: L channel signal is muted.)

Holding down the button continuously changes the level.

To exit power amplifier setting mode

Press SETTING again.

Setting tone

Adjust the tone (bass and treble) for the front speakers.

1 Press SETTING.

2 Press the ▲/▼ cursors until "BASS" or "TREBLE" appears on the display.

BASS or TREBLE

- After a while, the current setting value appears.

3 Within 5 seconds, press the ◀/▶ cursors to adjust the bass or treble.

Each time you press the button, the setting value changes 2 steps at a time between -10 and +10. (0: flat level)
Holding down the button continuously changes the value.

To exit power amplifier setting mode

Press SETTING again.

Setting speaker size

Select the speaker size according to the speakers you are using.

- When you use the supplied speakers with this system, set the speaker size as follows:
FRONT SPK: SMALL
CENTER SPK: SMALL
REAR SPK: SMALL

CAUTION:

When using this system's front, center, or rear speakers, select "SMALL" for each. Selecting "LARGE" may result in speaker damage.

1 Press SETTING.

2 Press the ▲/▼ cursors until the following item appears on the display window.

- **FRONT SPK**
For setting the left and right front speaker size
- **CENTER SPK**
For setting the center speaker size
- **REAR SPK**
For setting the left and right rear speaker size
- After a while, the current setting appears.

3 Within 5 seconds, press the ◀/▶ cursors to select the speaker size.

Select "LARGE" when the cone speaker imbedded in the speaker being used has a diameter of 12 cm or more.
Select "SMALL" when the diameter is less than 12 cm.
Select "NONE" when the speaker is not connected, or is not in use.

- When the speakers supplied with this system are used, select "SMALL" for each speaker.
- **FRONT SPK**
Pressing the button toggles between the following settings.
SMALL* ↔ LARGE

- **CENTER SPK**

Pressing the button toggles between the following settings. When the FRONT SPK is selected "SMALL":

SMALL* ↔ NONE

When the FRONT SPK is selected "LARGE":

↔ LARGE ↔ SMALL* ↔ NONE ↔

- **REAR SPK**

Pressing the button toggles between the following settings.

When the FRONT SPK is selected "SMALL":

SMALL* ↔ NONE

When the FRONT SPK is selected "LARGE":

↔ LARGE ↔ SMALL* ↔ NONE ↔

* Select when the supplied speakers with this system are used.

To exit power amplifier setting mode

Press SETTING again.

Adjusting delay time

The delay time for the center speaker and rear speakers is calculated by comparing the distance between the rear/center speakers and the listening point with the distance between the front speakers and the listening point.

1 Press SETTING.

2 Press the ▲/▼ cursors until the following item appears on the display window.

- **CENTER DELAY**
For setting the delay time for the center speaker
- **REAR DELAY**
For setting the delay time for the rear speakers
- After a while, the current setting appears.

3 Within 5 seconds, press the ◀/▶ cursors to select the delay time.

- **CENTER DELAY**
Pressing the button changes the delay time between 0 ms and 5 ms.
When the distance between the listening point and the center speaker is close to the distance to the front speakers, set the delay time to 0 ms. Increase the delay time when the distance to the center speaker is shorter.
 - A 1ms increase/decrease of delay time is equivalent to a 30 cm change in distance.
- **REAR DELAY**
Pressing the button changes the delay time between 0 ms and 15 ms.
When the distance between the listening point and the rear speakers is close to the distance to the front speakers, set the delay time to 0ms. Increase the delay time when the distance to the rear speakers is shorter.
 - A 1ms increase/decrease of delay time is equivalent to a 30 cm change in distance.

To exit power amplifier setting mode

Press SETTING again.

Notes:

- When the center speaker size is set to "NONE" (not used), you cannot adjust CENTER DELAY.
- When the rear speaker size is set to "NONE" (not used), you cannot adjust REAR DELAY.

Amplifier settings

Adjusting crossover

When using a small speaker with weak bass as a front, center, or rear speaker, you can redirect bass audio to the sub-woofer. Select a crossover frequency to match the size of the small speaker being used.

- When you use the supplied speakers with this system, set the crossover frequency as follows:
CROSSOVER: 200Hz

- 1 Press **SETTING**.
- 2 Press the **▲/▼** cursors until **"CROSSOVER"** appears on the display window.
 - After a while, the current setting appears.
- 3 Within 5 seconds, press the **◀/▶** cursors to select the crossover frequency.

Pressing the button changes the crossover frequency as follows:

↔ 200Hz ↔ 120Hz ↔ 100Hz ↔

Crossover frequency	Speaker diameter
100Hz	approx. 10 cm (4")
120Hz	approx. 8 cm (3-3/16")
200Hz*	approx. 4 cm (1-5/8")

* Select when the supplied speakers with this system are used.

To exit power amplifier setting mode

Press **SETTING** again.

Note:

- When **"LARGE"** is set for the front, center and rear speakers, you cannot adjust **CROSSOVER**.

Adjusting LFE attenuator

When bass sound is distorted while playing back the program recorded in Dolby Digital or DTS surround, you can lower the sound level through the LFE attenuator.

- Normally, LFE ATT should be set to **"OFF"**.

- 1 Press **SETTING**.
- 2 Press the **▲/▼** cursors until **"LFE ATT."** appears on the display window.
 - After a while, the current setting appears.
- 3 Within 5 seconds, press the **◀/▶** cursors to select **"ON"** or **"OFF"**.

Pressing the button toggles between **"ON"** and **"OFF"**.

ON: Select when bass sound is distorted.

OFF: Select to turn off LFE ATT. effect.

To exit power amplifier setting mode

Press **SETTING** again.

Adjusting dynamic range

You can compress the dynamic range. This may be used when you play back surround effects at night. This function work only for the program recorded in Dolby Digital.

- The initial setting of **D. RANGE COMP** is **"MID"**.

- 1 Press **SETTING**.
- 2 Press the **▲/▼** cursors until **"D. RANGE COMP"** appears on the display window.
 - After a while, the current setting appears.
- 3 Within 5 seconds, press the **◀/▶** cursors to select the setting.

Pressing the button changes the dynamic range compression as follows:

↔ MAX ↔ MID ↔ OFF ↔

MAX: The dynamic range is fully compressed.

MID: The dynamic range is compressed a little. (Initial setting)

OFF: The dynamic range is not compressed.

To exit power amplifier setting mode

Press **SETTING** again.

Note:

- To enjoy original sound, you should set to **"MID"** or **"OFF"**.

Sound settings

You can adjust the sub-woofer output level, output level of each speaker using a test tone, and DSP effect, to obtain preferable sound for you.

Note that you need to adjust them at the position you will listen to.

Adjusting sub-woofer level

You can adjust the sub-woofer output level to increase or decrease the sound volume from the sub-woofer.

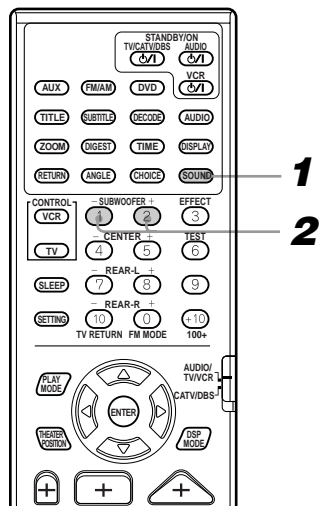

1 Press SOUND.

The system enters sound setting mode.

2 Press SUBWOOFER +/- to adjust the level.

You can adjust the sub-woofer output level between +10 dB and -10 dB. (0 dB: Rated level)

- After 5 seconds, the display returns to the one before entering the sound setting mode.

Adjusting speaker level

While playing a noise-like test tone, you can adjust the output level of each speaker by increasing or decreasing the sound volume from the speaker.

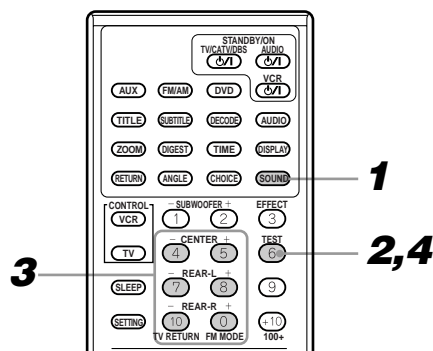

1 Press SOUND.

The system enters sound setting mode.

2 Press TEST to play a test tone.

“TEST TONE L” appears on the display window and the test tone is played from the speakers in the following order.

↔ TEST TONE L ↔ TEST TONE C ↔ TEST TONE R ↔ TEST TONE RS ↔ TEST TONE LS ↔

- The speaker which is set to “OFF” (not used) in “Setting speaker size” will be skipped. See page 49.

3 While listening, adjust each speaker level.

You can adjust each speaker output level between +10 dB and -10 dB. (0 dB: Rated level)

When you press the following button, the current setting value appears on the display window.

- **TEST TONE L (Left front speaker)**
Just listen for your reference.
- **TEST TONE C (Center speaker)**
Press CENTER +/- to adjust the level.
- **TEST TONE R (Right front speaker)**
Just listen for your reference.
- **TEST TONE RS (Right rear speaker)**
Press REAR R +/- to adjust the level.
- **TEST TONE LS (Left rear speaker)**
Press REAR L +/- to adjust the level.

4 Press TEST to stop the test tone.

- After 5 seconds, the display returns to the one before entering the sound setting mode.

Note:

- You can adjust the speaker level without playing a test tone. In this case, perform only steps 1 and 3.

Sound settings

Adjusting DSP effect

You can adjust the strength of DSP (Digital Signal Processor) effect for each DAP mode so that you can customize sound effect. About the DAP, see "Using the DSP Modes [DSP MODE]" on page 20.

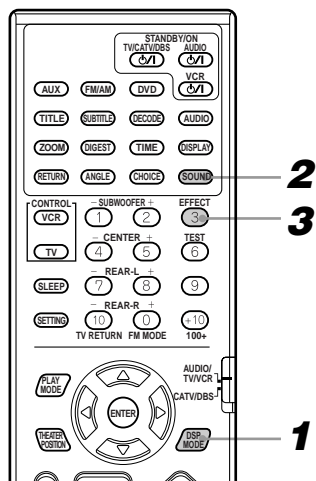

1 Press DSP MODE to select one of DSP modes.

The current DSP mode appears on the display window. Each time you press the button, DSP mode changes as follows.

→SURROUND ON*→ THEATER → LIVE CLUB → DANCE CLUB → HALL → PAVILION → DSP OFF → (back to the beginning)

* "PRO LOGIC" appears when the current source is not DVD.

2 Press SOUND.

The system enters sound setting mode.

3 Press EFFECT to select the desired effect level.

The current effect level appears on the display window. Each time you press the button, the effect level changes as follows.

↔ DSP EFFECT 1 ↔ DSP EFFECT 2 ↔ DSP EFFECT 3 ↔ DSP EFFECT 4 ↔ DSP EFFECT 5 ↔

- The greater number, the greater effect.

4 Repeat steps 1-3 for other DSP mode.

- After 5 seconds, the display returns to the one before entering the sound setting mode.

Note:

- If DAP mode is not selected, you cannot adjust the DSP effect.

AV COMPU LINK remote control system

The AV COMPU LINK remote control system allows you to operate JVC video components (TV and VCR) through the center unit.

AV COMPU LINK

To use this remote control system, you need to connect the video components you want to operate, follow the diagrams and procedure explained here.

Connection and setup

When connecting to a TV

Connect the center unit to a TV via the AV COMPU LINK terminals.

Then, set the AV COMPULINK setting of the center unit as follows.

- When connecting to VIDEO-1 input terminal of the TV: DVD2 (Initial setting)
- When connecting to VIDEO-2 input terminal of the TV: DVD3
- When connecting to VIDEO-3 (DVD) input terminal of the TV: DVD1

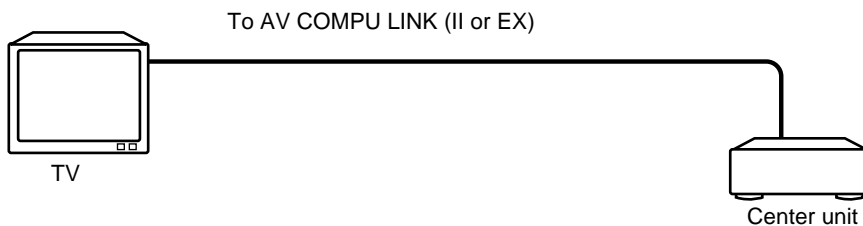

When connecting to a TV and VCR

Connect the center unit to a TV and VCR via AV COMPU LINK terminals.

Then, set the AV COMPULINK setting of the center unit and the VCR's Remote Control Code setting as follows:

- **When connecting to VIDEO-1 input terminal of the TV:**
Center unit's AV COMPULINK setting (Initial setting): **DVD2**
VCR's Remote Control Code: **B**
- **When connecting to VIDEO-2 input terminal of the TV:**
Center unit's AV COMPULINK setting: **DVD3**
VCR's Remote Control Code: **A**
- **When connecting to VIDEO-3 (DVD) input terminal of the TV:**
Center unit's AV COMPULINK setting: **DVD1**
VCR's Remote Control Code: **A**

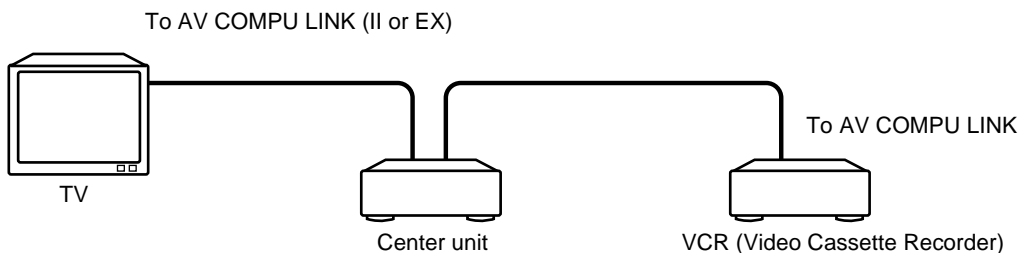

- The AV COMPULINK setting is operated in the on-screen SYSTEM menu. See page 45 for operation.

IMPORTANT!

When you connect the component video output to your TV:

- Set the AV COMPULINK setting on the center unit to "DVD1".

Note:

- There may be no description about connections to a DVD player in the instruction manual of a TV or VCR. However a TV or VCR with AV COMPU LINK terminals indicating "II" or "EX" can be connected to the center unit.

AV COMPU LINK remote control system

Operation

You can enjoy pictures and/or sound by just putting a source component (which plays back the pictures and/or sound such as the center unit or a VCR) into play mode. You do not have to operate the TV including not having to perform power switching.

- 1 Turn on the main power of the TV.**
- 2 Insert a disc into the source component.**
- 3 Press PLAY of the source component.**

The following actions are performed automatically:

- Turning on the power for the TV.
- Setting the source of the TV to the external input (VIDEO-1, VIDEO-2, or VIDEO-3).

Operating Other Manufacturers' Video Equipment

This remote control supplied with the receiver can transmit control signals for other manufacturers' VCRs, TVs, CATV converters and DBS tuners. By changing the transmittable signals from preset ones to the other manufacturers', you can operate the other manufacturer's components using this remote control.

When operating the other manufacturers' components, refer also to the manuals supplied with them. To operate these components with the remote control, first you need to set the manufacturer's code each for VCR, TV, CATV converters, and DBS tuner.

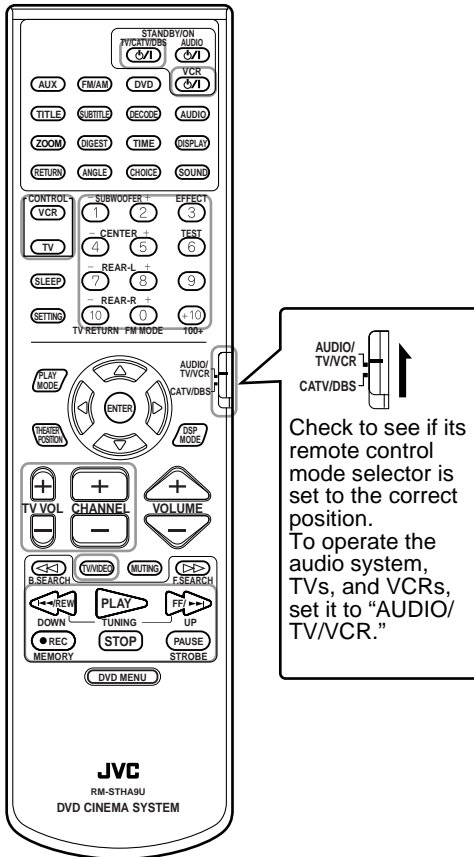

To change the transmittable signals for operating another manufacturer's TV

1 Slide the remote control mode to "AUDIO/TV/VCR."

2 Press and hold TV/CATV/DBS $\odot/|$.

Keep press until step 4 is finished.

3 Press TV.

4 Enter manufacturer's code (2 digits) using buttons 1 - 9, and 0.

See the list below to find the code.

Examples: For a JVC product, press 0, then 1.

For a Hitachi product, press 1, then 0.

5 Release TV/CATV/DBS $\odot/|$.

The following buttons can be used for operating the TV (with the remote control mode selector set to "AUDIO/TV/VCR"):

TV/CATV/DBS $\odot/|$: Turns on and off the TV.

TV VOL +/-: Adjusts the volume.

TV/VIDEO: Sets the input mode (either TV or VIDEO).

After pressing TV (with the remote control mode selector set to "AUDIO/TV/VCR"), you can perform the following operations on a TV:

CHANNEL +/- : Changes the channels.

1 - 10, 0, 100+ (+10): Selects the channels.
100+ (+10) button will function as the ENTER button if your TV requires pressing ENTER after selecting a channel number.

Note:

- Refer to the manual supplied with your TV.

6 Try to operate your TV by pressing TV/CATV/DBS $\odot/|$.

When your TV turns on or off, you have entered the correct code.

If there are more than one code listed for your brand of TV, try each one until the correct one is entered.

Manufacturer	Code	Manufacturer	Code
JVC	01	SAMSUNG	12
HITACHI	10	SANYO	13
MAGNAVOX	02	SHARP	06
MITSUBISHI	03	SONY	07
PANASONIC	04, 11	TOSHIBA	08
RCA	05	ZENITH	09

Manufacturers' codes are subject to change without notice. If they are changed, this remote control cannot operate the equipment.

Operating Other Manufacturers' Video Equipment

To change the transmittable signals for operating a CATV converter or DBS tuner

1 Slide the remote control mode to "CATV/DBS."

2 Press and hold TV/CATV/DBS \odot /I.
Keep press until step 4 is finished.

3 Press TV.

4 Enter manufacturer's code (2 digits) using buttons 1 - 9, and 0.

See the list below to find the code.

Examples:

For a JVC product, press 2, then 1.

For a Pioneer product, press 1, then 3.

5 Release TV/CATV/DBS \odot /I.

After setting the remote control mode selector to "CATV/DBS," you can perform the following operations on the CATV converter or on the DBS tuner:

TV/CATV/DBS \odot /I: Turns on and off the CATV converter or DBS tuner.

CHANNEL +/-: Changes the channels.

1 - 10, 0, 100+ (+10): Selects the channel.
100+ (+10) button will function as the ENTER button if your equipment requires pressing ENTER after selecting a channel number.

Note:

- Refer to the manual supplied with your CATV converter or DBS tuner.

6 Try to operate your CATV converter or DBS tuner by pressing TV/CATV/DBS \odot /I.

When your CATV converter or DBS tuner turns on or off, you have entered the correct code.

If there are more than one code listed for your brand of CATV converter or DBS tuner, try each one until the correct one is entered.

Manufacturer	Code
ECHOSTAR	21
GI JERROLD	01, 02, 03, 04, 05, 06, 07, 08
HAMLIN/REGAL	15, 16, 17, 18
PIONEER	13, 14
RCA	19
SCIENTIFIC ATLANTA	09, 10
SONY	20
ZENITH	11, 12

Manufacturers' codes are subject to change without notice. If they are changed, this remote control cannot operate the equipment.

To change the transmittable signals for operating another manufacturer's VCR

1 Set the remote control mode to "AUDIO/TV/VCR."

2 Press and hold VCR \odot /I.
Keep press until step 4 is finished.

3 Press VCR.

4 Enter manufacturer's code (2 digits) using buttons 1 - 9, and 0.

See the list below to find the code.

Examples:

For a JVC product, press 0, then 1.

For a Funai product, press 1, then 0.

5 Release VCR \odot /I.

Following button can be used for operating the VCR (with the remote control mode selector set to "AUDIO/TV/VCR"):

VCR \odot /I: Turns on and off the VCR.

After pressing VCR (with the remote control mode selector set to "AUDIO/TV/VCR"), you can perform the following operations on the VCR:

PLAY: Starts playback.
◀◀: Rewinds a video tape.
▶▶: Fast winds a video tape.
STOP: Stops operation.
PAUSE: Pauses.
● REC: Starts recording or enters recording pause.

CHANNEL +/- : Changes the TV channels on the VCR.
1 - 10, 0, 100+ (+10): Selects the TV channels.
 100+ (+10) button will function as the ENTER button if your VCR requires pressing ENTER after selecting a channel number.

Note:

- Refer to the manual supplied with your VCR.

6 Try to operate your VCR by pressing VCR \odot /I.

When your VCR turns on or off, you have entered the correct code.

If there are more than one code listed for your brand of VCR, try each one until the correct one is entered.

Manufacturer	Code	Manufacturer	Code
JVC	01, 02, 03	PHILIPS	09
EMERSON	11, 26	RCA	05, 06
FISHER	29	SAMSUNG	24
FUNAI	10, 14, 15, 16	SANYO	21, 22, 23
GOLD STAR	12	SHARP	27, 28
HITACHI	04	SHINTOM	30
MITSUBISHI	13	SONY	18, 19, 20
NEC	25	ZENITH	08
PANASONIC	07, 17		

Manufacturers' codes are subject to change without notice. If they are changed, this remote control cannot operate the equipment.

Care and handling of discs

How to handle discs

When handling a disc, do not touch the surface of the disc. Since discs are made of plastic, they are easily damaged. If a disc gets dirty, dusty, scratched or warped, the image and sound will not be picked up correctly, and such a disc may cause the player to malfunction.

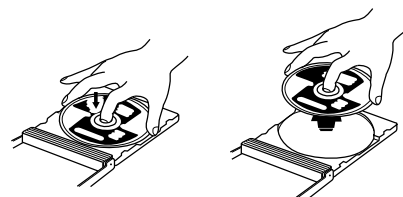

Label side

Do not damage the label side, stick paper to or use any adhesive on its surface.

Storage

Make sure that discs are kept in their cases. If discs are piled on top of one another without their protective cases, they can be damaged. Do not put discs in a location where they may be exposed to direct sunlight, or in a place where the humidity or temperature is high. Avoid leaving discs in your car!

Maintenance of discs

If there are fingerprints or other dirt adhering to a disc, wipe with a soft dry cloth, moving from the center outwards.

If a disc is difficult to clean, wipe with a cloth moistened with water.

Never use record cleaners, petrol, alcohol or any anti-static agents.

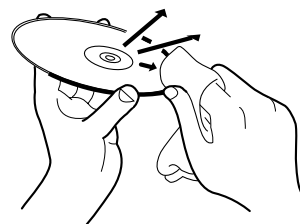

Cleaning the lens

If the lens in the laser pickup is dirty, video image irregularities, sound dropout, etc., could occur.

Open the disc cover and clean the lens as shown below:

- Use a blower (available from a camera store) to blow dust off the lens.

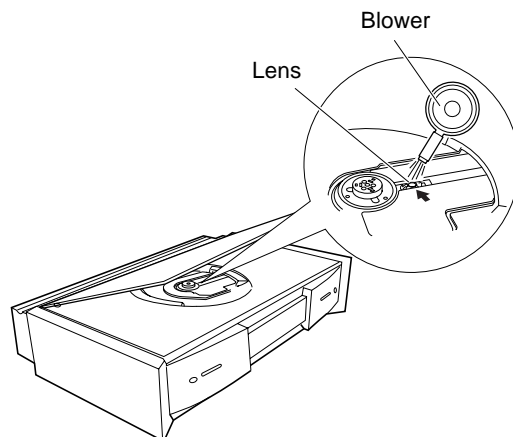

- If there are fingerprints, etc. on the lens, gently wipe clean with a cotton swab.

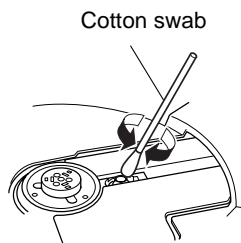

CAUTIONS:

- Do not use irregular shape discs (heat-shape, octagonal, etc.). Using these discs can damage the center unit.
- Sometimes during playback, noise or images may be garbled. This is sometimes due to the disc. (It may not be up to industry standards.)

These symptoms are caused by the discs, not by the malfunction of the center unit.

Troubleshooting

Use this chart to help you solve daily operational problems. If there is any problem you cannot solve, contact your JVC service center.

PROBLEM	POSSIBLE CAUSE	SOLUTION
Power does not come on.	The power cord.	Insert the plug into the socket.
Power is not supplied to the powered sub-woofer	The power cord has been pulled out of the AC outlet. The system cable is not connected.	Press the $\odot/!$ on the center unit to switch power OFF, and then press it again to switch power ON.
The remote control does not work.	It is too far from the center unit, or is not facing the center unit. There is something obstructing the remote sensor.	Avoid any obstacles within approximately 5 m of the detector on the remote control.
	The battery is flat.	Replace the battery.
	The battery has been inserted the wrong way round (+/-).	Insert the battery correctly.
	Sunlight is falling directly on the detector.	Shade the remote control from direct sunlight.
	The entered manufacturer's code number is incorrect.	Enter the correct code number.
The remote control does not work as expected.	The remote control mode selector position is incorrect.	Set it to the correct position. Normally, it should be set to "AUDIO/TV/VCR".
No sound.	The system cable is not connected.	Check the connection.
	The speaker cord is not connected.	Check the connection.
	There is a short in the speaker cord.	Reconnect the speaker cord and press on the center unit to restart the system.
	The powered sub-woofer power supply is off.	Insert the plug firmly into the socket and press $\odot/!$ on the center unit to switch power off, and then press it again to switch power on.
	The audio cord is not connected properly.	Connect the cord properly.
	An incorrect source has been selected.	Select the correct source.
	Muting is on.	Press MUTING to cancel mute.
Sound is emitted from only one speaker.	The speaker cord is not connected correctly.	Connect the cord properly.
	Left-right balance is incorrect.	Adjust balance.
No video.	The video cord is not connected properly.	Connect the cord properly.
	TV input selection is incorrect.	Select the correct input.
Cannot play a disc.	A non-NTSC disc has been inserted. The unit and disc region numbers (local numbers) are incompatible.	Replace the disc.
Video and audio are distorted.	The disc is dirty.	Clean the disc.
	A video deck is connected between the center unit and the TV.	Connect the center unit and TV directly.
The edge is missing on the video image.	Initial setup (monitor type) was incorrect.	Run through initial setup again correctly.
	The TV has been set up incorrectly.	Set up the TV correctly.
Continuous static during FM broadcasts.	The received signal is too weak.	Connect an external FM antenna, or contact your dealer.
	The station is too far away.	Select another station.
	The antenna is not connected correctly.	Check the connection.
Unit does not work correctly.	Lightning or electronic noise interferes with operation of the microcomputer.	Switch power off, and remove and re-insert the power plug in the socket.
	Immediately after beginning to heat the room, the unit was moved to a cold location causing condensation to form inside.	Switch power off and leave the unit a few hours before switching power on again.

Note:

- Problem may be caused by the components connected to the system. So, please read the manuals for the components carefully.

Specifications

Center unit (XV-THA9)

Audio section

Total Harmonic Distortion	0.02 %
AUX Input Level	290 mV/47 k Ω

Video section

Color System	PAL/NTSC selectable
Horizontal Resolution	500 lines
Signal-to-Noise Ratio	68 dB
Output Level	S-video-Y: 1.0 V _{p-p} /75 Ω S-video-C: 0.286 V _{p-p} /75 Ω Composite: 1.0 V _{p-p} /75 Ω Component-Y: 1.0 V _{p-p} /75 Ω Component-Pb/Pr: 0.7 V _{p-p} /75 Ω

Tuner section

Tuning Range	FM: 87.5 MHz to 108.0 MHz AM: 531 kHz to 1 602 kHz (at 9 kHz channel space) 530 kHz to 1 600 kHz (at 10 kHz channel space)
Usable Sensitivity	FM: 12.8 dbf (1.2 μ V/75 Ω) AM loop antenna: 630 μ V/m

Dimensions (W \times H \times D)	360 mm \times 77 mm \times 253 mm (14-3/16 inches \times 3-1/16 inches \times 10 inches)
Mass	3.0 kg (6.6 lbs)
Power Requirements	AC 110 - 230 V \sim , 50/60 Hz
Power Consumption	20 W (at operation) 1.9 W (in standby mode)

Powered Sub-woofer (SP-PWA9)

Amplifier section

Output Power	Front/Rear/Center : 20 W \times 5, 4 Ω , 1 kHz, 0.7 % THD : 30 W \times 5, 4 Ω , 1 kHz, 10 % THD Powered sub-woofer: 100 W, 4 Ω , 100 Hz, 0.7 % THD : 140 W, 4 Ω , 100 Hz, 10 % THD
--------------	--

Speaker section

Speaker	20 cm (7.9 inches), bass-reflex
Frequency Range	25 Hz to 200 Hz

Dimensions (W \times H \times D)	240 mm \times 435 mm \times 455 mm (9-1/2 inches \times 17-3/16 inches \times 17-15/16 inches)
Mass	16.5 kg (36.4 lbs)
Power Requirements	AC 110 / 127 / 230 V \sim , 50/60 Hz selectable with the voltage selector
Power Consumption	120 W (at operation) 0 W (in standby mode)

Satellite Speakers (SP-XSA9)

Speakers	7 cm \times 4 cm (2-13/16 inches \times 1-5/8 inches) bass-reflex, Magnetically Shielded
Power Handling Capacity	30 W
Frequency Range	95 Hz to 20 kHz
Dimensions (W \times H \times D)	65 mm \times 122 mm \times 117 mm (2-9/16 inches \times 4-13/16 inches \times 4-5/8 inches)
Mass	360 g (0.79 lbs)

Center Speaker (SP-XCA9)

Speakers	7 cm \times 4 cm (2-13/16 inches \times 1-5/8 inches) bass-reflex, Magnetically Shielded
Power Handling Capacity	30 W
Frequency Range	95 Hz to 20 kHz
Dimensions (W \times H \times D)	122 mm \times 65 mm \times 115 mm (4-13/16 inches \times 2-9/16 inches \times 4-9/16 inches)
Mass	360 g (0.79 lbs)

Designs & specifications are subject to change without notice.

Appendix A: Table of languages and their abbreviations

When you select the subtitle language or sound, the languages shown below are displayed as abbreviations.
To select the desired language, select the abbreviation corresponding the language you want to.

AA	Afar
AB	Abkhazian
AF	Afrikaans
AM	Ameharic
AR	Arabic
AS	Assamese
AY	Aymara
AZ	Azerbaijani
BA	Bashkir
BE	Byelorussian
BG	Bulgarian
BH	Bihari
BA	Bashkir
BE	Byelorussian
BG	Bulgarian
BH	Bihari
BI	Bislama
BN	Bengali, Bangla
BO	Tibetan
BR	Breton
CA	Catalan
CO	Corsican
CS	Czech
CY	Welsh
DA	Danish
DZ	Bhutani
EL	Greek
EO	Esperanto
ET	Estonian
EU	Basque
FA	Persian
FI	Finnish
FJ	Fiji
FO	Faroese
FY	Frisian
GA	Irish
GD	Scots Gaelic
GL	Galician
GN	Guarani
GU	Gujarati
HA	Hausa
HI	Hindi
HR	Croatian
HU	Hungarian
HY	Armenian
IA	Interlingua
IE	Interlingue

IK	Inupiak
IN	Indonesian
IS	Icelandic
IW	Hebrew
JI	Yiddish
JW	Javanese
KA	Georgian
KK	Kazakh
KL	Greenlandic
KM	Cambodian
KN	Kannada
KO	Korean (KOR)
KS	Kashmiri
KU	Kurdish
KY	Kirghiz
LA	Latin
LN	Lingala
LO	Laothian
LT	Lithuanian
LV	Latvian, Lettish
MG	Malagasy
MI	Maori
MK	Macedonian
ML	Malayalam
MN	Mongolian
MO	Moldavian
MR	Marathi
MS	Malay (MAY)
MT	Maltese
MY	Burmese
NA	Nauru
NE	Nepali
NL	Dutch
NO	Norwegian
OC	Occitan
OM	(Afan) Oromo
OR	Oriya
PA	Panjabi
PL	Polish
PS	Pashto, Pushto
PT	Portuguese
QU	Quechua
RM	Rhaeto-Romance

RN	Kirundi
RO	Rumanian
RU	Russian
RW	Kinyarwanda
SA	Sanskrit
SD	Sindhi
SG	Sangho
SH	Serbo-Croatian
SI	Singhalese
SK	Slovak
SL	Slovenian
SM	Samoan
SN	Shona
SO	Somali
SQ	Albanian
SR	Serbian
SS	Siswati
ST	Sesotho
SU	Sundanese
SV	Swedish
SW	Swahili
TA	Tamil
TE	Telugu
TG	Tajik
TH	Thai
TI	Tigrinya
TK	Turkmen
TL	Tagalog
TN	Setswana
TO	Tonga
TR	Turkish
TS	Tsonga
TT	Tatar
TW	Twi
UK	Ukrainian
UR	Urdu
UZ	Uzbek
VI	Vietnamese
VO	Volapuk
WO	Wolof
XH	Xhosa
YO	Yoruba
ZU	Zulu

Appendix B: Country code list for parental lock

This list is used for the parental Lock operation. For details, see page 46.

AD	Andorra
AE	United Arab Emirates
AF	Afghanistan
AG	Antigua and Barbuda
AI	Anguilla
AL	Albania
AM	Armenia
AN	Netherlands Antilles
AO	Angola
AQ	Antarctica
AR	Argentina
AS	American Samoa
AT	Austria
AU	Australia
AW	Aruba
AZ	Azerbaijan
BA	Bosnia and Herzegovina
BB	Barbados
BD	Bangladesh
BE	Belgium
BF	Burkina Faso
BG	Bulgaria
BH	Bahrain
BI	Burundi
BJ	Benin
BM	Bermuda
BN	Brunei Darussalam
BO	Bolivia
BR	Brazil
BS	Bahamas
BT	Bhutan
BV	Bouvet Island
BW	Botswana
BY	Belarus
BZ	Belize
CA	Canada
CC	Cocos (Keeling) Islands
CF	Central African Republic
CG	Congo
CH	Switzerland
CI	Côte d'Ivoire
CK	Cook Islands
CL	Chile

CM	Cameroon
CN	China
CO	Colombia
CR	Costa Rica
CU	Cuba
CV	Cape Verde
CX	Christmas Island
CY	Cyprus
CZ	Czech Republic
DE	Germany
DJ	Djibouti
DK	Denmark
DM	Dominica
DO	Dominican Republic
DZ	Algeria
EC	Ecuador
EE	Estonia
EG	Egypt
EH	Western Sahara
ER	Eritrea
ES	Spain
ET	Ethiopia
FI	Finland
FJ	Fiji
FK	Falkland Islands (Malvinas)
FM	Micronesia (Fedelated States of)
FO	Faroe Islands
FR	France
FX	France, Metropolitan
GA	Gabon
GB	United Kingdom
GD	Grenada
GE	Georgia
GF	French Guiana
GH	Ghana
GI	Gibraltar
GL	Greenland
GM	Gambia
GN	Guinea
GP	Guadeloupe
GQ	Equatorial Guinea

GR	Greece
GS	South Georgia and the South Sandwich Islands
GT	Guatemala
GU	Guam
GW	Guinea-Bissau
GY	Guyana
HK	Hong Kong
HM	Heard Island and McDonald Islands
HN	Honduras
HR	Croatia
HT	Haiti
HU	Hungary
ID	Indonesia
IE	Ireland
IL	Israel
IN	India
IO	British Indian Ocean Territory
IQ	Iraq
IR	Iran (Islamic Republic of)
IS	Iceland
IT	Italy
JM	Jamaica
JO	Jordan
JP	Japan
KE	Kenya
KG	Kyrgyzstan
KH	Cambodia
KI	Kiribati
KM	Comoros
KN	Saint Kitts and Nevis
KP	Korea, Democratic People's Republic of
KR	Korea, Republic of
KW	Kuwait
KY	Cayman Islands
KZ	Kazakhstan
LA	Lao People's Democratic Republic
LB	Lebanon
LC	Saint Lucia

LI	Liechtenstein
LK	Sri Lanka
LR	Liberia
LS	Lesotho
LT	Lithuania
LU	Luxembourg
LV	Latvia
LY	Libyan Arab Jamahiriya
MA	Morocco
MC	Monaco
MD	Moldova, Republic of
MG	Madagascar
MH	Marshall Islands
ML	Mali
MM	Myanmar
MN	Mongolia
MO	Macau
MP	Northern Mariana Islands
MQ	Martinique
MR	Mauritania
MS	Montserrat
MT	Malta
MU	Mauritius
MV	Maldives
MW	Malawi
MX	Mexico
MY	Malaysia
MZ	Mozambique
NA	Namibia
NC	New Caledonia
NE	Niger
NF	Norfolk Island
NG	Nigeria
NI	Nicaragua
NL	Netherlands
NO	Norway
NP	Nepal
NR	Nauru
NU	Niue
NZ	New Zealand
OM	Oman
PA	Panama

PE	Peru
PF	French Polynesia
PG	Papua New Guinea
PH	Philippines
PK	Pakistan
PL	Poland
PM	Saint Pierre and Miquelon
PN	Pitcairn
PR	Puerto Rico
PT	Portugal
PW	Palau
PY	Paraguay
QA	Qatar
RE	Réunion
RO	Romania
RU	Russian Federation
RW	Rwanda
SA	Saudi Arabia
SB	Solomon Islands
SC	Seychelles
SD	Sudan
SE	Sweden
SG	Singapore
SH	Saint Helena
SI	Slovenia
SJ	Svalbard and Jan Mayen
SK	Slovakia
SL	Sierra Leone
SM	San Marino
SN	Senegal
SO	Somalia
SR	Suriname
ST	Sao Tome and Principe
SV	El Salvador
SY	Syrian Arab Republic
SZ	Swaziland
TC	Turks and Caicos Islands
TD	Chad
TF	French Southern Territories
TG	Togo
TH	Thailand

TJ	Tajikistan
TK	Tokelau
TM	Turkmenistan
TN	Tunisia
TO	Tonga
TP	East Timor
TR	Turkey
TT	Trinidad and Tobago
TV	Tuvalu
TW	Taiwan, Province of China
TZ	Tanzania, United Republic of
UA	Ukraine
UG	Uganda
UM	United States Minor Outlying Islands
US	United States
UY	Uruguay
UZ	Uzbekistan
VA	Vatican City State (Holy See)
VC	Saint Vincent and the Grenadines
VE	Venezuela
VG	Virgin Islands (British)
VI	Virgin Islands (U.S.)
VN	Viet Nam
VU	Vanuatu
WF	Wallis and Futuna Islands
WS	Samoa
YE	Yemen
YT	Mayotte
YU	Yugoslavia
ZA	South Africa
ZM	Zambia
ZR	Zaire
ZW	Zimbabwe

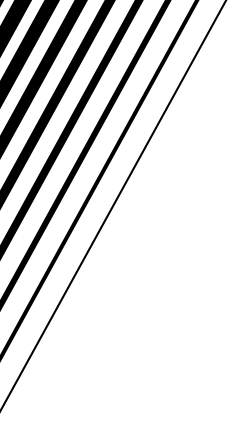

Free Manuals Download Website

<http://myh66.com>

<http://usermanuals.us>

<http://www.somanuals.com>

<http://www.4manuals.cc>

<http://www.manual-lib.com>

<http://www.404manual.com>

<http://www.luxmanual.com>

<http://aubethermostatmanual.com>

Golf course search by state

<http://golfingnear.com>

Email search by domain

<http://emailbydomain.com>

Auto manuals search

<http://auto.somanuals.com>

TV manuals search

<http://tv.somanuals.com>