

Table of contents

Thank you for purchasing this JVC video cassette player. To ensure optimum performance of this unit, please read this instruction manual thoroughly.

Precautions	2
Controls and terminals	3
Wireless remote control	4
Connections	5
Setting the video channel	6
The video cassette	6
Playback	7
Playback features	8
Recording	9
Editing	10
Troubleshooting	10
Specifications	11

Features

- 3 system (PAL/MESECAM/NTSC)
- NTSC playback (on PAL television)
- RF output G/K switchable
- Digital auto tracking
- HQ (High Quality)
- B.E.S.T. picture system
- Auto playback function
- Repeat playback
- Shuttle search
- Still and slow motion
- Line recording
- Scene finder

Automatic features

Auto power on

The video cassette player is automatically turned on when the tape is inserted.

Auto rewind

The video tape is automatically rewound when the end of the tape is reached during the play, recording or shuttle search forward mode.

Auto playback

If the video cassette's safety tab has been removed, playback will begin automatically when the tape is inserted into the video cassette player.

Power off eject

Even when the video cassette player's power is off, pressing the eject button will turn the power on and eject the tape. Once ejected, the power will be turned off again automatically.

Auto head cleaning

When a tape is loaded or ejected the VCP video head is cleaned automatically.



- Only cassettes marked "VHS" can be used with this video cassette player.

Precautions

The rating plate and the safety caution are on the rear of the unit.

WARNING: DANGEROUS VOLTAGE INSIDE

WARNING: TO PREVENT FIRE OR SHOCK HAZARD, DO NOT EXPOSE THIS UNIT TO RAIN OR MOISTURE.

The OPERATE button does not completely shut off mains power from the unit, but switches operating current on and off.

This unit is produced to comply with Standard IEC Publ. 65.

Please follow these precautions. Not doing so may result in damage to the VCP, remote control, or video cassette.

- Avoid extreme heat and direct sunlight.
- Avoid extreme cold.
- Avoid extreme humidity.
- Avoid dust.
- Avoid places subject to vibrations.
- Avoid strong magnetic fields.
- Do not block the VCP's ventilation openings.
- Do not place anything heavy on the VCP or remote control.
- Do not place anything which might spill on top of the VCP or remote control.
- Do not place the VCP on cushions, pillows, or thick carpeting.
- Use the VCP in a stable, horizontal position only.
- Place cassettes in cassette cases and store vertically.

Beware of moisture condensation

Moisture in the air will condense on the VCP when you move it from a cold place to a warm place, or under extremely humid conditions — just as water droplets form on the surface of a glass filled with cold liquid. Moisture condensation on the head drum will cause damage to the tape. In conditions where condensation may occur, keep the VCP's power turned on for a few hours to let the moisture dry.

When transporting

- Be sure to remove cassette from VCP before packing.
- Avoid violent shocks to the VCP during packing and transport.

Controls and terminals

Front panel

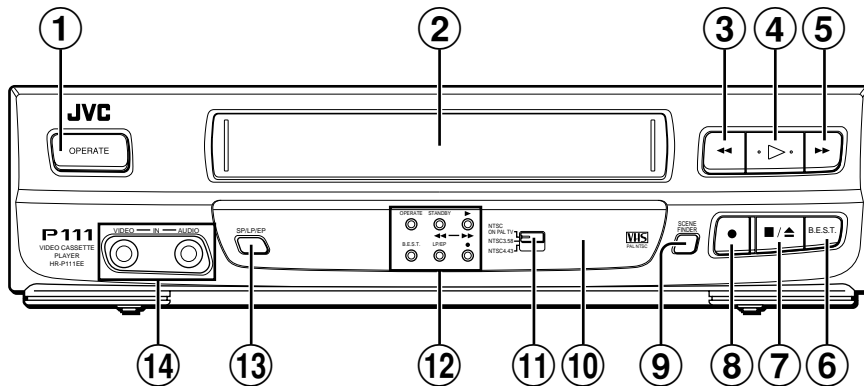

- ① **OPERATE button**
To turn the power on and off (standby mode).
- ② **Cassette loading slot**
Load the video cassette here.
- ③ **Rewind ◀◀ button**
To rewind the video tape and to start reverse shuttle search playback mode.
- ④ **Play ▷ button**
To start playback.
- ⑤ **Fast forward ▶▶ button**
To fast forward the video tape and to start forward shuttle search playback mode.
- ⑥ **B.E.S.T. button**
To set the B.E.S.T. system on.
- ⑦ **Stop/Eject ■/▲ button**
To stop playback and to eject the video tape.
- ⑧ **Record ● button**
To start recording.
- ⑨ **SCENE FINDER button**
To start the scene finder.
- ⑩ **Remote sensor window**
For remote control operation.
- ⑪ **Colour System Output switch**
Select to watch an NTSC tape.
- ⑫ **Mode indicators**
OPERATE indicator
 - Lights when the power turns on.
 - Blinks while a cassette is ejected.**STANDBY/Rewind ◀◀ indicator**
 - Lights when the power turns off (Standby mode).
 - Blinks during rewind mode.
 - Blinks slowly during rewind power off mode.**Play ▷ /Fast forward ▶▶ indicator**
 - Lights during playback mode.
 - Blinks during fast forward mode.
 - Blinks slowly during repeat playback mode.**B.E.S.T. PICTURE indicator**
 - Lights when the B.E.S.T. picture is on.**LP/EP indicator**
 - Lights the tape speed is LP(PAL) or EP(NTSC) mode.**Record ● indicator**
 - Lights during recording mode.
 - Blinks during recording pause mode.
- ⑬ **SP/LP/EP button**
To select the recording tape speed.
- ⑭ **AUDIO/VIDEO IN terminals**
Connect cables coming from the output terminals of another VCR or a camcorder.

Rear panel

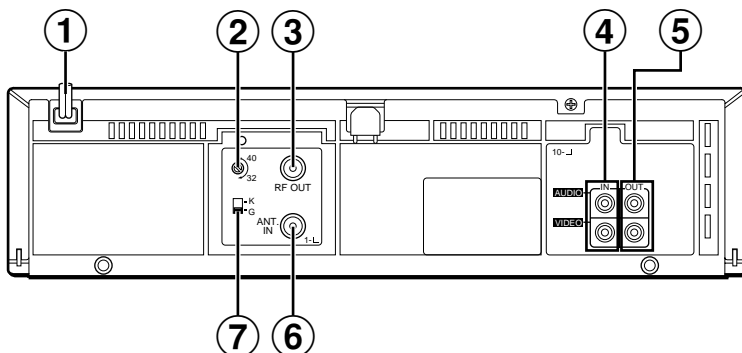

- ① **AC power cord**
- ② **RF channel adjustment screw**
- ③ **RF. OUT terminal**
- ④ **AUDIO/VIDEO IN terminals**
- ⑤ **AUDIO/VIDEO OUT terminals**
- ⑥ **ANT. IN terminal**
- ⑦ **TV system switch**

Wireless remote control

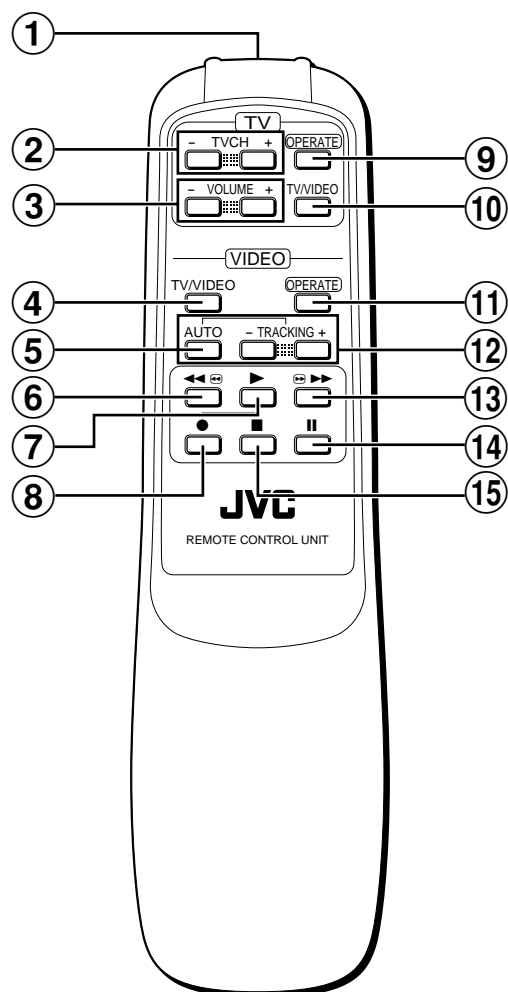
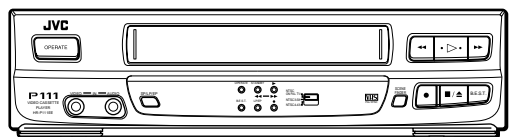

When using the remote control for operation of the video cassette player, make sure that it is pointed at the remote sensor window.

You can also use the player's remote control to operate a JVC television.

- ① **Transmitting window**
- ② **TV channel -/+ buttons**
- ③ **TV VOLUME -/+ buttons**
- ④ **TV/VIDEO (Player) button**
Not function
- ⑤ **Digital AUTO TRACKING button**
To cancel the Auto tracking mode.
- ⑥ **Rewind ◀◀ button**
To rewind the video tape. Also to start reverse shuttle search playback.
- ⑦ **Play ▶ button**
To start playback.
- ⑧ **Record ● button**
Press the Record ● and Play ▶ buttons together, to start recording.
- ⑨ **OPERATE (TV) button**
To turn the TV power on and off.
- ⑩ **TV/VIDEO (TV) button**
To switch TV between TV and VIDEO (or AV).
- ⑪ **OPERATE (Player) button**
To turn the power on and off (standby mode).
- ⑫ **TRACKING -/+ buttons**
To adjust tracking during playback.
- ⑬ **Fast forward ▶▶ button**
To fast forward the video tape. Also to start forward shuttle search playback.
- ⑭ **Pause || button**
To freeze the picture during playback. Also to engage the recording pause mode.
- ⑮ **Stop ■ button**
To stop playback.

Installing batteries

1 Slide the battery compartment cover upward and insert two AA, R6, UM-3 or equivalent size batteries, observing the correct + and - polarities (refer to the illustration).

2 Replace the battery compartment cover.

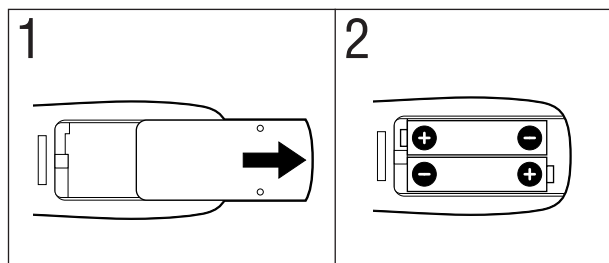

- The maximum operating distance of the remote control is about 8 m.

Connections

Make sure that the power to the video cassette player and TV is off before making the following connections.

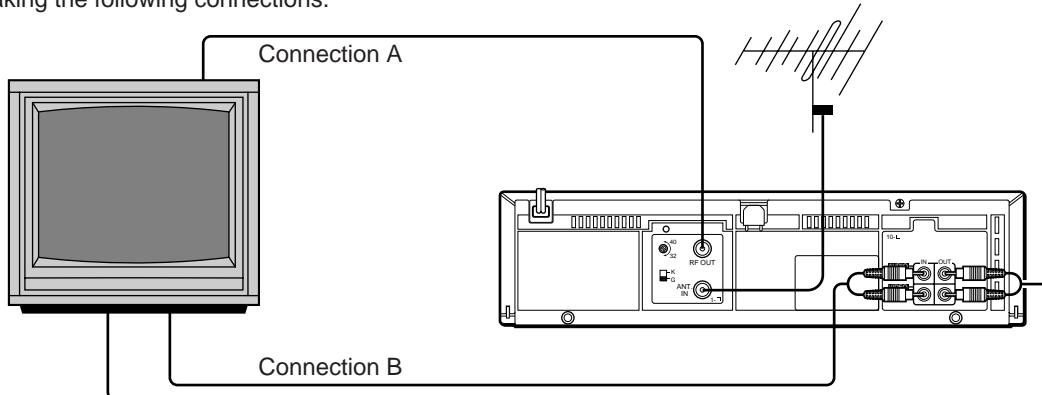

Connection A (basic)

In order to use the video cassette player it must be connected between the antenna and the TV.

- 1 Connect your TV antenna cable to the video cassette player's ANT. IN terminal.
- 2 Connect one end of the provided RF antenna cable to the video cassette player's RF. OUT terminal and the other end to the TV's antenna terminal.
- 3 Connect the power cord to your household AC outlet.

Note:

If you put a TV set directly on this VCP or install it too close to a TV set, noise may occur. If this noise occurs, separate the VCP and the TV set.

Connection B

For connection of a TV that has VIDEO/AUDIO IN/OUT terminals. This connection is necessary to record TV programmes. Use RCA type pin connection cords (available from audio/video stores) for connection. This connection is in addition to connection A.

- 1 Follow steps 1 and 2 of "Connection A".
- 2 Connect the TV's VIDEO OUT and AUDIO OUT terminals to the video cassette player's VIDEO IN and AUDIO IN terminals.
- 3 Connect the TV's VIDEO IN and AUDIO IN terminals to the VCP's VIDEO OUT and AUDIO OUT terminals.
- 4 Connect the power cord to your household AC outlet.

TV system

The TV system switch should be set as follows.

K position: Set to this position for K system areas (Eastern European countries).

G position: Set to this position for G system areas (Western European countries for example).

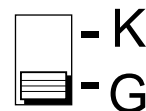

Note:

- When connection B is used to connect the TV and video cassette player, setting the TV system switch is not necessary.

Setting the video channel

To watch videos on your TV, it must be set to the same UHF channel as the video cassette player. This channel is used as the video channel.

This video cassette player has been preset to UHF channel 36.

Note:

- When you have connected the VIDEO/AUDIO OUT terminals of this video cassette player to your TV's video/audio in terminals (connection B of the "Connections" section), setting the video channel is not necessary. In this case simply set the TV's TV/VCR switch to VCR.

1 Turn the video cassette player's power on and load a pre-recorded video tape.

2 Turn on the TV and set it to UHF channel 36.

If UHF channel 36 is being used for broadcasting in your area:

Adjust the TV's channel selector a little at a time until the TV screen is blank (set it towards a higher or lower channel). Adjust the RF channel adjustment screw on the rear panel of the video cassette player a little at a time until the playback picture appears on the TV screen.

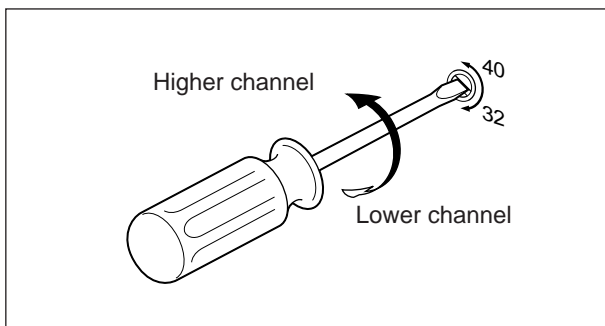

- If the TV's channel selector was set to a higher channel than channel 36, turn the RF channel adjustment screw to the right and vice versa.

3 Adjust the TV picture with the TV's tuning controls.

Using the TV while the video cassette player is connected

To watch a normal TV broadcast, select a TV station with the TV's channel selector.

The video cassette

Inserting a cassette

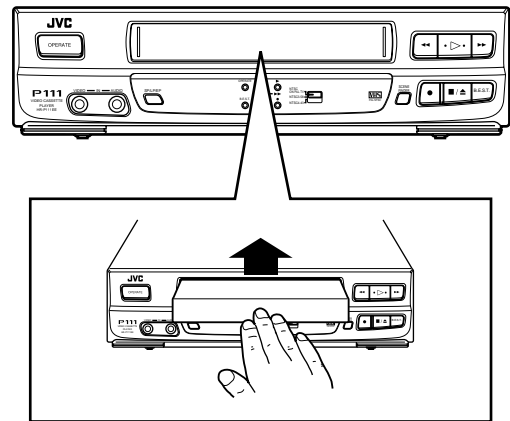

■ Insert the cassette as shown and push it gently into the video cassette player.

The video cassette player will be turned on automatically and the cassette will be loaded.

■ Press the Stop/Eject ■/▲ button to eject a cassette.

During playback or recording, press the ■/▲ button twice (once to stop the tape and once more to eject it).

Notes:

- If the cassette's safety tab has been removed, playback will start automatically when the cassette is inserted.
- A cassette can also be ejected when the power is off.
- The OPERATE indicator blinks while the cassette is ejected.

Special note on Video Cassettes

To prevent accidental recording on a recorded cassette, remove its safety tab. To record on it later, cover the hole with adhesive tape.

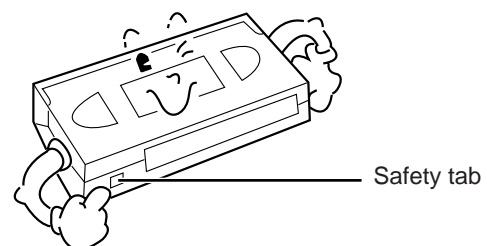

Playback

NTSC, PAL and MESECAM video tapes can be played back on this video cassette player. Refer to the "Colour system output mode selection" section for details.

Before proceeding:

- Turn on the power of the TV and video cassette player.
- Make sure that the TV is set to the video channel or that the TV's TV/VIDEO switch is set to VIDEO (refer to the "Setting the video channel" section for details).

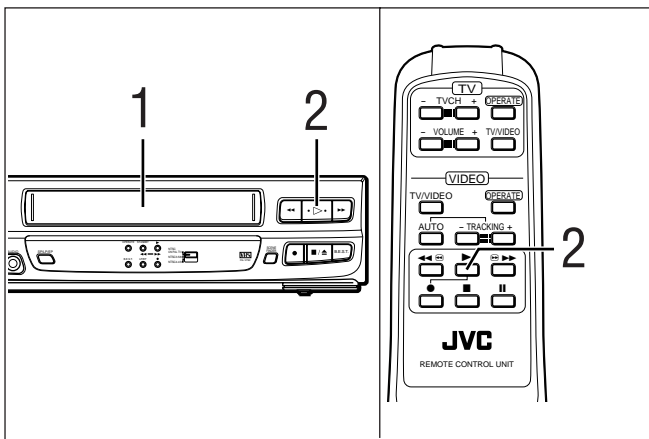

1 Load a pre-recorded cassette.
If the safety tab on the cassette is removed, playback will start automatically.

2 Press the Play ► button to start playback.

■ Press the Stop/Eject ■/▲ button or the remote control's Stop ■ button to stop playback.

To fast forward or rewind the tape:

■ From the stop mode, press the Fast forward ►► or Rewind ◀◀ button.

NTSC Playback on PAL TV

- The vertical size of the playback picture will shrink and some picture "noise" may appear on the screen.
- The playback picture may roll. In this case adjust the picture with the TV's vertical hold knob (with some TV's this adjustment may not be possible).
- The colour of the playback picture may differ from the original.
- In the forward/reverse shuttle search or still modes there may be no colour depending on the TV and video cassette player combination.

Colour system output mode selection

To watch an NTSC tape, it will be necessary to select one of the following output modes.

Selecting the NTSC PLAYBACK ON PAL TV mode

Select this mode to watch NTSC tapes on a PAL system TV.

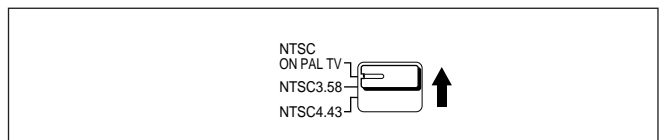

Selecting the NTSC 3.58 mode

Select this mode to watch NTSC tapes on a NTSC system TV.

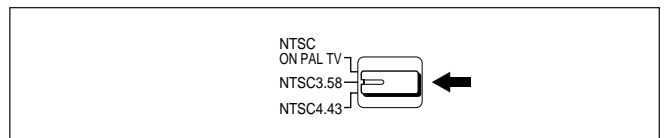

Selecting the NTSC 4.43 mode

Select this mode to watch NTSC tapes on a multi-system TV (that has an NTSC 4.43 setting).

Select NTSC 4.43 to record NTSC 4.43 signal.

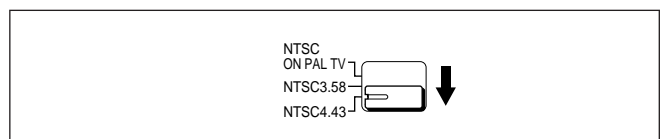

Playback features

Slow motion playback

Slow motion playback is 1/6 of the normal playback speed. The sound will be cut during slow motion playback.

During playback:

1 Press the **Pause II** button for 2 seconds.

■ Press the **Play ►** button to return to the normal playback speed.

Notes:

- If the picture shakes during the slow mode, use the manual tracking +/- buttons to correct the picture.
- There will be some picture disturbance and loss of colour during slow motion playback.
- After the picture has been frozen for approx. 5 minutes, the still mode will disengage to protect the video tape.

Still picture and frame advance

Use this feature to freeze the playback picture and to advance one frame at a time. The sound will be cut during this mode.

During playback:

1 Press the **Pause II** button.
The picture will be frozen.

2 Press the **Pause II** button repeatedly to advance frames.
Each time the button is pressed the still picture will advance one frame.

■ Press the **Play ►** button to resume normal playback.

Notes:

- If the picture shakes during the still mode, use the manual tracking +/- buttons to correct the picture.
- After the picture has been frozen for approx. 5 minutes, the still mode will disengage to protect the video tape.

Shuttle search playback

Use this feature during playback to visually locate any point on a recorded cassette. The sound will be cut during shuttle search operation.

During playback:

1 Press the **Fast forward ►►** or **Rewind ◀◀** button to engage shuttle search forward or reverse.

■ Press the **Play ►** button to resume normal playback.

Notes:

- When the video cassette player is in the stop mode, press the **Play ►** button to start playback before engaging the shuttle search mode.
- For short searches, keep the **Fast forward ►►** or **Rewind ◀◀** button pressed for more than 2 seconds. When released, normal playback will continue.
- Disturbances in the shuttle search picture are normal and do not indicate a problem with the video cassette player.

B.E.S.T. picture system

The B.E.S.T. (Biconditional Equalized Signal Tracking) system checks the condition of the tape in use during recording and playback, and compensates to provide the highest-possible recording and play back pictures.

1 Press the **B.E.S.T.** button.
The B.E.S.T. indicator will light.

■ Press the **B.E.S.T.** button to cancel this feature.

Notes:

- The B.E.S.T. system works for SP, LP and EP modes only after a tape has been inserted record mode is first initiated. It does not work during recording.
- Once the cassette is ejected, the B.E.S.T. data is cancelled.
- Since the B.E.S.T. system works before recording actually starts, there is a delay of approximately 7 seconds after the **Record ●** and **Play ►** buttons on the remote control are pressed, or the **Record ●** button on the video cassette player is pressed.
- When watching a tape recorded with "B.E.S.T." set to on, it is recommended that you leave B.E.S.T. on during playback as well.
- The video cassette player adjusts the playback picture quality based on the quality of the tape in use.

Scene finder

This function helps you check contents of unlabeled recorded tapes at the touch of a signal button.

Anytime except during Record:

1 Press the **SCENE FINDER** button.

- The video cassette player starts high-speed forward search for 30 seconds and then fast-forwards 10 minutes on the tape. This will be repeated until the end of the tape is reached.
- To start scene finder in the reverse direction, press the **SCENE FINDER** button and then the **Rewind ◀◀** button within 2 seconds. It will be repeated until the beginning of the tape.
- During scene finder high-speed search, you can also hear the tape sound. During fast forward (or rewind), you will hear the current TV sound instead.

2 Press the **Stop ■** button to stop scene finder.

Repeat playback

Use this feature to repeat playback of a cassette 20 times.

During playback:

1 Press the **Play ►** button for more than 5 seconds.
The **Play** indicator will blink slowly and playback of the cassette will repeat 20 times automatically.

2 Press the **Stop ■** button to stop repeat playback.
Tape playback will be stopped and the repeat playback mode will be cancelled.

Playback features (cont'd)

Rewind power off

When the tape has finished rewinding, the VCR will turn itself off.

During stop:

- 1 Press the **Rewind** ◀◀ button.
- 2 Press the **OPERATE** button within 2 seconds.
The **STANDBY** indicator will blink.

Tracking adjustment

Automatic tracking is adjusted each time a cassette is inserted in the video cassette player, you may wish to adjust tracking manually during playback.

Manual tracking

- 1 Press the remote control's **AUTO** button.
 - 2 Press the remote control's **TRACKING +** or **-** button to adjust tracking.
- Press the **AUTO** button to return to automatic tracking.

Notes:

- Tracking may need to be adjusted each time a different video tape is inserted for playback.
- Tracking will be automatically set to the reference position when the cassette is ejected.

Recording

Use the following procedure to record TV programmes on a blank video tape.

Before proceeding:

- To record TV programmes, the video cassette player must be connected to the TV as shown in connection B of the "Connections" section.
- Turn on the power of the TV and video cassette player.
- Make sure that the video cassette's safety tab is intact. If it has been removed, cover the hole with adhesive tape.

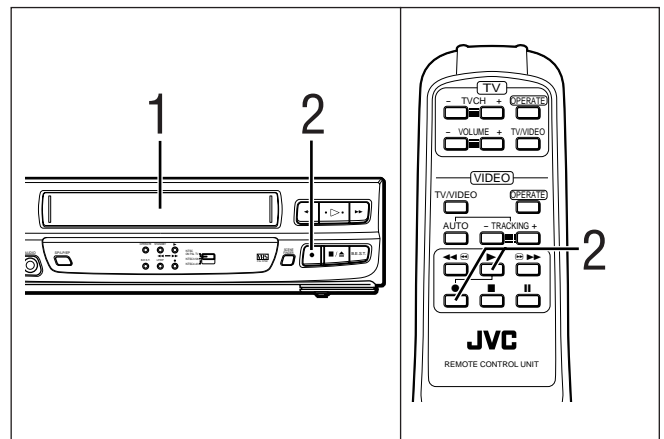

- 1 Load a blank video tape.
 - 2 Press the **Record** ● button to start recording. (On the remote control unit press the **Record** ● and **Play** ► buttons at the same time.)
The recording indicator will light during recording.
- Press the **Stop/Eject** ■/▲ button or the remote control's **Stop** ■ button to stop recording.

To stop recording temporarily:

- Press the **Pause** || button.
The recording indicator will blink.
Press the **Play** ► button to resume recording.

Notes:

- To engage recording standby, press the **Record** ● button and then press the **Pause** || button. The recording indicator will blink during recording standby. Press the **Play** ► button again to start recording.
- If the **Record** ● button does not work, check to see if the cassette safety tab has been removed.
- The player automatically stops when record-standby continues for more than 5 minutes.
- The video tape will be rewound automatically when the end of the tape is reached.

Editing

Editing To/From Another Recorder

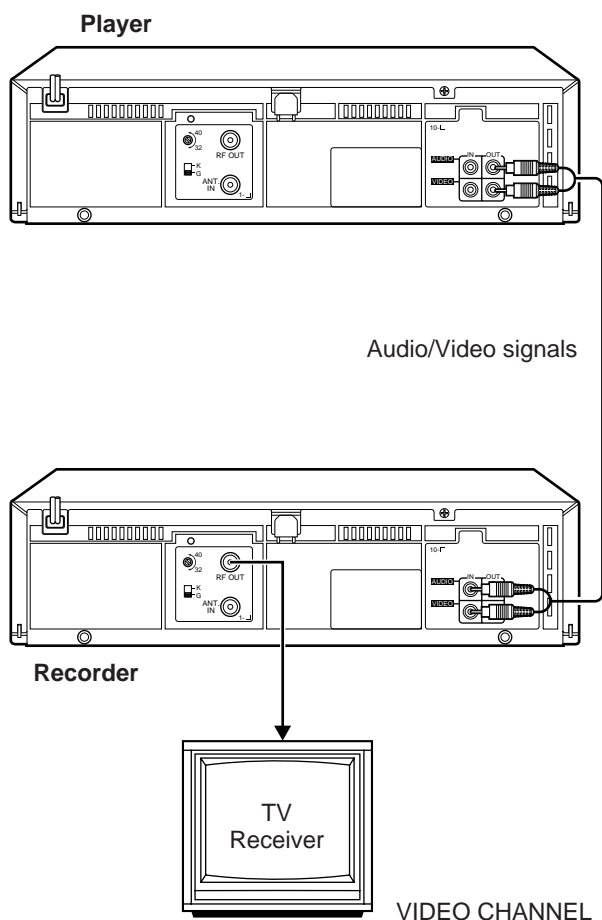

- 1 Connect the player's AUDIO and VIDEO OUT connectors to the recorder's AUDIO and VIDEO IN connectors.
- 2 Put the player in the Play mode.
- 3 Put the recorder in the Record mode.

Notes:

- NTSC tapes being played back in the NTSC PLAYBACK ON PAL TV mode cannot be dubbed to another recorder.
- When you dub an NTSC tape using your recorder as the playback deck, select NTSC 3.58 (or 4.43) with the Colour System Output switch.
- Connections made to the front panel AUDIO/VIDEO input terminals automatically override those made to the rear panel AUDIO/VIDEO input terminals.

Important:

- To edit, both the player and the recorder must be of the same colour system. Press your recorder's Colour system switch to select the appropriate colour system.

Troubleshooting

Problem	Check point
No power	Is the power cord plugged in? Is the power turned on?
Tape cannot be ejected	Was the video cassette player's ■ / ▲ button pressed?
No picture	Is the TV set to the video channel? Is a cassette loaded? Are the connections correct?
No colour	Set the Colour System Output switch according to the recorded tape system. When playing a MESECAM tape, select the NTSC 4.43 mode.
Shuttle search does not function	Is the video cassette player in the playback mode?
Disturbances in playback picture	Is tracking adjusted properly? Is the TV adjusted properly? Install this VCP a little way apart from the TV set.
Remote control does not function	The batteries are weak. Replace the batteries.
Auto playback does not function	The video cassette's recording safety tab has not been removed.
Recording does not function	Are the connections correct? Was the Record button pressed? The video cassette's recording safety tab is removed.
The video cassette player does not function properly	Microcomputer malfunction. Disconnect the power plug from the AC outlet and then re-insert it. The microcomputer will be reset to its initial mode.

About Head cleaning

- If the picture playback becomes blurred, it does not mean that the recorded program has been erased.
- Dirt accumulated on the video heads after long periods of use causes such troubles. In this case, head cleaning requiring highly technical care is necessary.
- For head cleaning, consult the nearest JVC dealer.

Specifications

Format	VHS Standard
Video recording system	Rotary, slant azimuth two-head helical scan system
Rotary heads	2 video heads
RF output	System G/K type modulation UHF ch 32 – 40 adjustable (preset ch 36)
Recording (line input)	PAL, SECAM (MESECAM tape) NTSC 3.58, NTSC 4.43
Playback (line output)	PAL, SECAM (MESECAM tape) NTSC 3.58 NTSC 4.43 Simulated PAL (NTSC tape)

Video

Line input level	0.5 – 2.0 Vp-p/75 ohms, unbalanced
Line output level	1.0 Vp-p/75 ohms, unbalanced
S/N ratio	More than 45 dB
Horizontal resolution	More than 250 lines (PAL/MESECAM) More than 220 lines (NTSC)

Audio

Line input level	–8 dBm/50 k ohms, unbalanced
Line output level	–6 dBm/1 k ohm, unbalanced
Frequency response	100 Hz to 10,000 Hz

Recording/Playback time

CCIR	240 min. with E-240 cassette
NTSC	160 min. with T-160 cassette

FF, REW time	Approx. 2 min. 30 sec. with E-180 cassette
--------------------	--

Power requirements

Rating	AC 110 – 240 V, 50/60 Hz
Operating	AC 90 – 260 V, 50/60 Hz

Power consumption	13 W
-------------------------	------

Operation temperature	5°C to 40°C
Dimensions	360 (W) × 94 (H) × 276 (D) mm
Weight	3.4 kg

Standard accessories

Remote control unit	1
Batteries for remote control	2
RF antenna cable	1

- Design and specifications subject to change without notice.
- Specifications shown are for SP mode unless otherwise specified.



Free Manuals Download Website

<http://myh66.com>

<http://usermanuals.us>

<http://www.somanuals.com>

<http://www.4manuals.cc>

<http://www.manual-lib.com>

<http://www.404manual.com>

<http://www.luxmanual.com>

<http://aubethermostatmanual.com>

Golf course search by state

<http://golfingnear.com>

Email search by domain

<http://emailbydomain.com>

Auto manuals search

<http://auto.somanuals.com>

TV manuals search

<http://tv.somanuals.com>