

JVC

PORTABLE MINIDISC PLAYER

ENGLISH

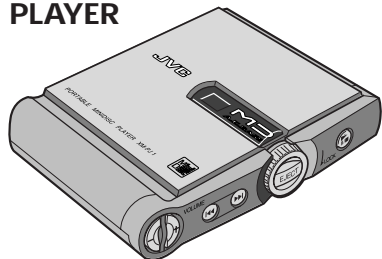

XM-PJ1BU

INSTRUCTIONS

LVT0122-001A [E]

Supplied Accessories

Check the packing carton for these accessories.

AC adaptor (AA-R9017)	1 pc.	Nickel metal hydride battery (rechargeable) (BN-R127)	1 pc.
Headphones	1 pc.	Carrying pouch	1 pc.
Wired remote control	1 pc.		
Charger/adaptor (AC-R124)	1 pc.		

Remove the rechargeable battery from its case before use.
Use numbers indicated in parentheses when asking for replacement parts.

Thank you for purchasing this JVC product. Please read these instructions carefully before starting operation to be sure to obtain optimum performance and a longer service life from the unit.

Power Supply Preparations

Refer to the specifications for information on operating times when using rechargeable battery, dry-cell battery, or both together.

Using nickel metal hydride battery (rechargeable battery) (BN-R127)

- 1 Remove the supplied rechargeable battery from its case.
- 2 Insert the rechargeable battery into the supplied charger/adaptor.

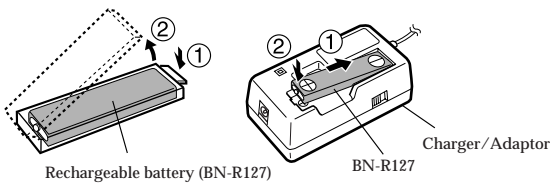

- 3 Set the switch of the charger/adaptor to "CHARGER".
- 4 Connect the supplied AC adaptor.

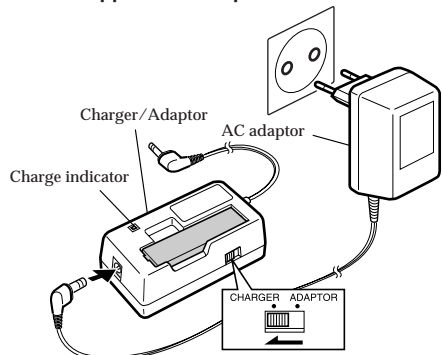

- 5 The charge indicator lights in red and it will go out when recharging is completed. Unplug the AC adaptor from the AC outlet and the charger/adaptor.
- 6 Remove the recharged battery from the charger/adaptor and insert it into the unit.

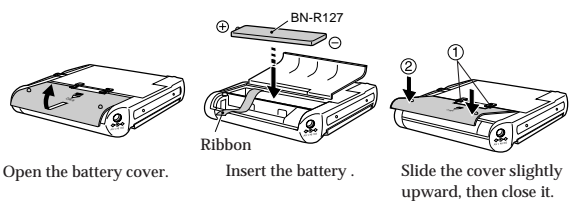

Position the ribbon under the battery in order to easily remove the battery from the case.

Notes:

- You cannot use the MD player during charging the rechargeable battery.
- It takes approximately 1.5 hours to recharge the rechargeable batteries.
- Rechargeable battery has a service life of approximately 300 charge-discharge cycles. If the operating time on one full charge becomes noticeably shorter than it used to be, the battery has reached the end of its service life and should be replaced.
- The AC adaptor and rechargeable batteries may become warm while recharging is in progress. This is not a malfunction.

Using the AC adaptor

CAUTION: Be sure no battery is inserted into the unit.

- 1 Set the switch of the charger/adaptor to "ADAPTOR".
- 2 Connect the supplied AC adaptor and charger/adaptor.

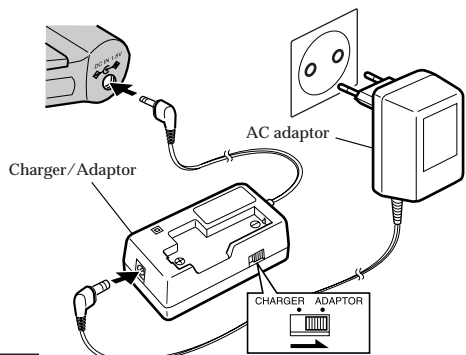

Note:

The unit is in the standby condition when the AC adaptor and charger/adaptor are connected. The primary circuit is always "live" as long as the AC adaptor is connected to an electrical outlet.

Using dry-cell battery (not included)

CAUTION: Do not use the dry-cell battery together with the AC adaptor. Open the battery cover and insert a LR6 (UM-3) alkaline battery into the battery compartment.

Position the ribbon under the battery in order to easily remove the battery from the case.

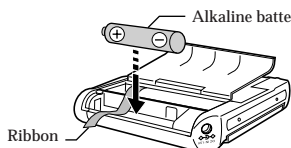

Note:

To lengthen the battery life, you can use both rechargeable battery and the dry-cell battery.

CAUTION!

THIS PRODUCT UTILIZES A LASER. USE OF CONTROLS OR ADJUSTMENTS OR PERFORMANCE OF PROCEDURES OTHER THAN THOSE SPECIFIED HEREIN MAY RESULT IN HAZARDOUS RADIATION EXPOSURE. DO NOT OPEN COVERS AND DO NOT REPAIR YOURSELF. REFER SERVICING TO QUALIFIED PERSONNEL.

WARNING:

TO REDUCE THE RISK OF FIRE OR ELECTRIC SHOCK, DO NOT EXPOSE THIS APPLIANCE TO RAIN OR MOISTURE.

WARNING LABEL,
PLACED INSIDE
THE UNIT

DANGER: Invisible laser radiation when open and interlock failed or defeated. AVOID DIRECT EXPOSURE TO BEAM. (e)

WARNING: Osynlig laserstrålning när denna del är öppnad och spårren är urkopplad. Beträkta ej strålen. (s)

ADVARSEL: Usynlig laserstrålning ved åbning, når sikkerhedsafbrydere er ude af funktion. Undgå udsættelse for stråling. (d)

VARO: Avattaessa ja suo-jälkikutus ohitettaessa olet alttiina näkymättömälle lasersäteilylle. Älä katso säteeseen. (f)

**CLASS 1
LASER PRODUCT**

1. CLASS 1 LASER PRODUCT
2. **DANGER:** Invisible laser radiation when open and interlock failed or defeated. Avoid direct exposure to beam.
3. **CAUTION:** Do not open the top cover. There are no user serviceable parts inside the Unit; leave all servicing to qualified service personnel.

Accidental Operation Prevention Function (Hold Mode)

This function prevents the unit from accidental button operation. The unit and remote control have the HOLD switches, each of which works independently.

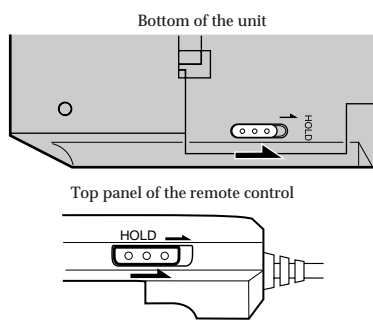

Slide the HOLD switch in the direction shown by the arrow to activate it.

When the HOLD switch of the unit or remote control is activated, no button operation is possible in the unit or the remote control. To operate the unit or remote control normally, return the HOLD switch.

Accidental Opening Prevention Function

To prevent the lid from the accidental opening, turn the EJECT button to the right in order to lock it.

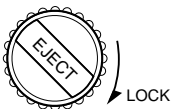

- To open the lid, return the EJECT button to the original position and then press it.
- It is recommended to lock the lid when moving the batteries.

Battery Indicator

The battery indicator appears on the display of the remote control. When the indication changes as follows, power will be shut off a short while after.

Rechargeable battery: Recharge it.



Dry-cell battery: Replace it with new one.

Notes:

- The battery indicator appears when an MD is loaded in the unit.
- The battery indicator also appears when the AC adaptor is used. However, it has no meaning.

Cautions

Batteries

- Before replacing batteries, always turn off the unit.
- Rechargeable nickel metal hydride battery (BN-R127):**
 - Use only the rechargeable battery (BN-R127) supplied with the unit.
 - If the power delivered by the battery lasts for a very short time after recharging, it means that the battery's service life is over. Do not use it any more.
 - Recharging already charged battery will shorten its service life.
 - When recharging battery for the first time or when it has not been used for a long period of time, the play time may be shorter than usual. In a case like this, repeatedly recharge and discharge the battery. This will restore it to its regular state.
 - Do not allow any metal objects to touch the terminals of rechargeable battery since this may cause short-circuiting which is dangerous.
 - Recharging shall be made at the temperature from 10°C to 35°C.
- Dry cell battery and rechargeable battery:**
 - To prevent damage to the batteries and electrolyte leakage, heed the following points.
 - Align the + and - polarities properly when inserting the batteries.
 - Remove the batteries if you do not plan to use the unit for a long period of time.
 - Do not throw batteries into a fire, and do not short-circuit, disassemble or subject them to excessive heat.
 - Do not attempt to recharge dry cell batteries.

Carrying batteries:

When putting dry cell or rechargeable batteries in a pocket or bag, ensure that no other metal objects such as a necklace are placed together with them. Contact with metal may cause short-circuiting which, in turn, may cause a fire. Be absolutely sure to carry the rechargeable battery in the battery carrying case.

Notice about the rechargeable battery

The battery is designated recyclable. Please follow your local recycling regulations.

AC adaptor and charger/adaptor

- Handle the AC adaptor and charger/adaptor carefully. Improper handling is dangerous.
 - Do not touch them with wet hands.
 - Do not place heavy objects on top of them.
 - Do not forcibly bend them.
- Be sure to connect only the AC adaptor and charger/adaptor provided with the unit.
- Disconnect the AC adaptor from the power outlet if the unit is not going to be used for a long time.

Location of Controls

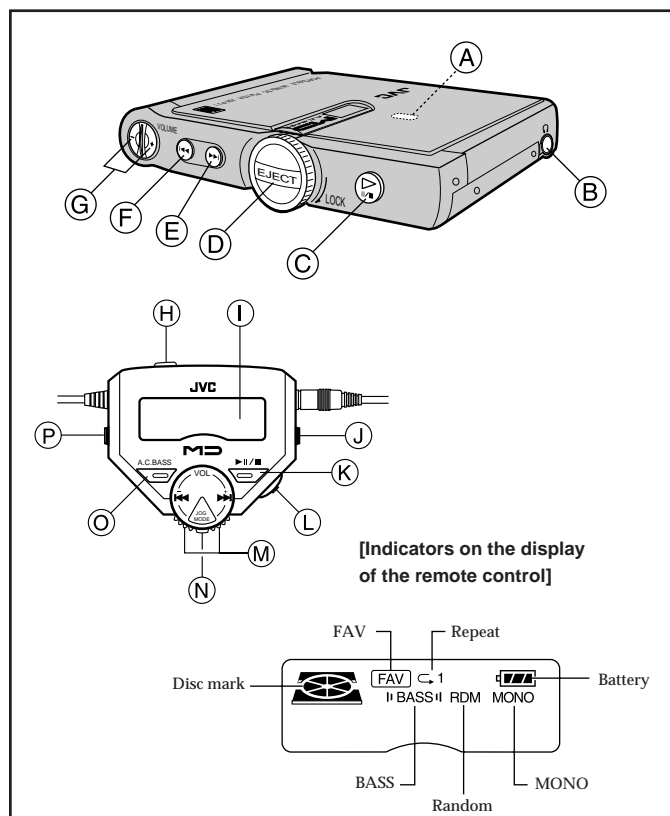

- | | |
|---------------------------------------|---|
| A HOLD switch | J DISPLAY button |
| B Headphones jack (1/4) | K Play / pause / stop button (38 / 7) |
| C Play / pause / stop button (38 / 7) | L FAV (Favorite) button |
| D EJECT button | M JOG dial |
| E Skip / search button (4 <) | N Volume +, - & Skip / search button (4 <) |
| F Skip / search button (4 >) | O A.C.BASS (Active Clear Bass) button |
| G Volume +, - button | P P.MODE (Play Mode) button |
| H HOLD switch | |
| I Display | |

Unit

No altering or remodeling

This can cause malfunctioning.

No dropping or strong impacts

This may damage the unit.

Locations to be avoided

Avoid using the unit in the following locations since they can cause malfunctioning.

1. Bathrooms and other moisture-prone places.
2. Warehouses and other dusty places
3. Very hot places near heating appliances, etc.

Do not leave the unit exposed to direct sunlight for long periods of time

This may deform or discolor the cabinet and may also cause malfunctioning.

Precautions for Listening with the headphones

- Do not play your headset at a high volume. Hearing experts advise against continuous extended play.
- If you experience a ringing in your ears, reduce volume or discontinue use.
- Do not use while operating a motorized vehicle. It may create traffic hazard and is illegal in many areas.
- You should use extreme caution or temporarily discontinue use in potentially hazardous situations.
- Even if your headphones are an open-air type designed to let you hear outside sounds, don't turn up the volume so high that you can't hear what's around you.

When driving a car

In the interest of traffic safety, do not operate the unit while driving.

Normal Play

Follow the numbers in the figure to normal-play.

- 1 Connect the headphones plug firmly.
- 2 Connect the remote control plug firmly.
- 3 Release the HOLD switches.
- 4 Load an MD.
 - Press the EJECT button to open the lid.
 - Insert the MD into the MD slot, with its label side facing up. Insert the MD until it stops. Be sure $\frac{1}{2}$ or $\frac{1}{4}$ mark on the MD directs as shown in the figure.
 - Close the lid.
 - "Toc Reading" appears on the display. Then the track number and playback time appear.
- 5 Adjust the volume level between 0 and 25.
 - Press the Volume +, - button on the unit or turn the JOG dial to the right or left. To continuously change the volume level, depress the volume button or keep turning the JOG dial.
- 6 Press the 3/8 7 button.
 - Playback starts from the first track and ends after playing all the tracks of the MD.

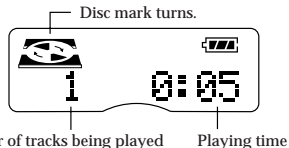
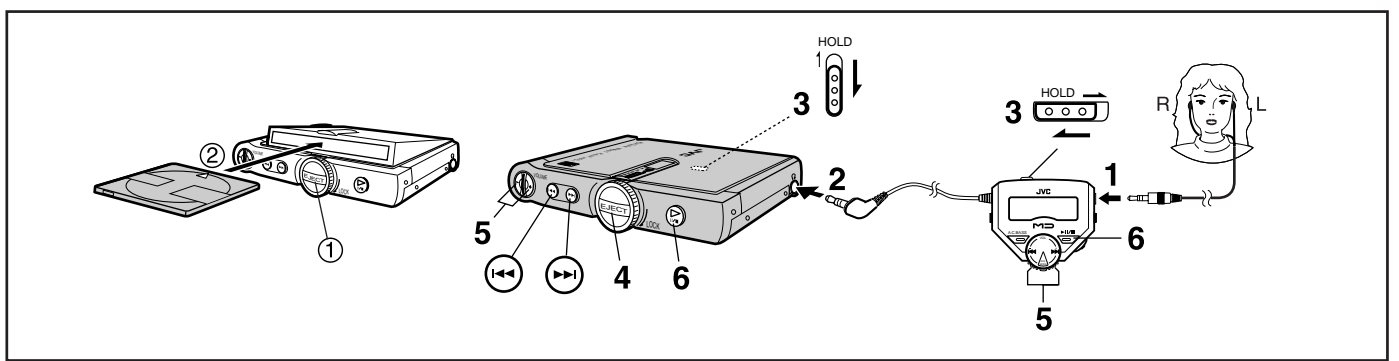

- Notes:**
- If no MD is loaded, "NO DISC" appears on the display and the power will be automatically shut off after approx. 10 seconds.
 - If the MD is recorded in Monaural mode, "MONO" will appear on the display.
 - To eject the MD, press the EJECT button to open the lid. Then, the MD comes out.

Reinforcing the Bass Sound (A.C.BASS)

Press the A.C.BASS button to activate the active clear bass function. The "BASS" indicator appears on the display. The bass level is automatically controlled in conjunction with the sound volume.

To cancel the function, press the same button again to light off the "BASS" indicator.

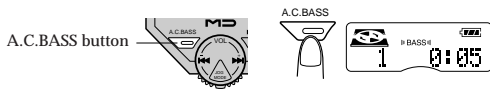

Setting the FAV (Favorite) Music

You can register the music to be played at the beginning of MD playback. You can see whether this function is set or not from the "FAV" indicator on the display.

Play the desired track and press the FAV button for 1 second or more. The "FAV" indicator blinks on the display while the track is being played. After that, it stays lit.



To play the FAV music, play the MD in which FAV information is registered. The "FAV" indicator blinks on the display and your favorite music is firstly played. After the FAV music, the first track of the MD is played.

To cancel the FAV music, in Stop mode, press the FAV button for 1 second or more. "FAV DELETE" blinks on the display twice.

- Notes:**
- You can register only 1 track as for FAV music. New registration will overwrite the previous setting.
 - The FAV information on the MD will be deleted if additional recording or editing such as MOVE and ERASE is made with the other MD recorders.
 - If you start to play the MD with FAV music after removing it once, the FAV music may not firstly start though the "FAV" indicator lights up. In this case, press the FAV button to play the FAV music.

Resume Play

This function allows you to listen from the beginning of the track where play stopped because of the unit was set to Stop mode.

Press the 3/8 7 button.

Showing the Disc Information

Each time you press the DISPLAY button in Stop mode or during playback, the disc information is displayed as follows.

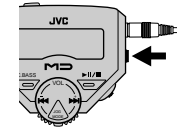

- In Stop mode:**
Disc title* = Total track number and total playback time of the MD = Track title* = Track number and its playback time = (back to the beginning)
- During Playback:**
Track title* = Track number and its playing time = (back to the beginning)
- *: The disc title or track title will scroll if it consists of 11 characters or more. If no title is given, "NO TITLE" appears on the display.

Operation	Button	Display/reference
To pause play	Press during play.	Blinks. Press again to restart play. If nothing is done for 2 minutes, the power will be automatically shut off.
To stop play (Stop mode)	Press during play for 1 second or more.	Stops. Press again to restart play (Resume Play). The current track will be played from the beginning. (See "Resume Play".) If nothing is done for 45 seconds, the power will be automatically shut off.
To turn off the unit (Off mode)	In Stop mode, press for 1 second or more.	The power is shut off after "POWER OFF" appears on the display. To turn on the unit, press the same button again. (Blank)

Operation	Button	Display/reference
Fast forward/reverse	Skip function (unit) Press during play or in Stop mode. Search function (unit) Keep depressed during play.	• During Random Play, the skip buttons cannot be used to skip back to tracks that were played previously in the random sequence.
	Skip function (remote control) During play mode or in Stop mode, press the JOG MODE button and briefly turn the JOG dial to the right or left. Search function (remote control) During play mode, press the JOG MODE button and continuously turn the JOG dial to the right or left.	

Repeat Play and Random Play

You can select Repeat Play or Random Play. In Repeat Play, you can repeat all the tracks or individual track as many times as you like. In Random Play, you can play all the tracks in random order.

Selecting Repeat Play and Random Play in Stop mode

In Stop mode, press the P.MODE button. Each time you press the button, the play mode changes as follows.

- P 1 = P = RDM = P 1 RDM = P RDM = Original display = (back to the beginning)
- P 1 : Repeats 1 track.
- P : Repeats all the tracks.
- RDM : Random play
- P 1 RDM : Repeats one track randomly selected.
- P RDM : Repeats all the tracks in random order.

After selecting one of the above modes, press the 3/8 7 button.

For example, to start Random Play, press the P.MODE button until "RDM" indicator appears and then start playback.

To exit Repeat Play or Random Play, stop the MD and then press the P.MODE button until the display returns to the original one.

Repeat Play during Playback

During Normal Play:
Each time you press the P.MODE button, the play mode changes as follows.
P 1 = P = Original display = (back to the beginning)
Select "P 1" to repeatedly play the current track. Select "P" to repeat all the tracks.

During Random Play:
Each time you press the P.MODE button, the play mode changes as follows.
P 1 RDM = P RDM = Original display = (back to the beginning)
Select "P 1 RDM" to repeatedly play a randomly selected track. Select "P RDM" to repeat all the tracks in random order.

To exit Repeat Play, stop the MD and then press the P.MODE button until the display returns to the original one.

Troubleshooting Guide

Before requesting service for this unit, check the chart below for a possible cause of the problem you are experiencing. Some simple checks or a minor adjustment on your part may eliminate the problem and restore proper operation.

If you are in doubt about some of the check points, or if the remedies indicated in the chart do not solve the problem, refer to the directory of Authorized Service Centers (enclosed with this unit) to locate a convenient service center, or consult your dealer for instructions.

Problem	Check this
Cannot operate.	Is the MD loaded? If not loaded "NO DISC" will appear. <ul style="list-style-type: none"> • Is the HOLD switch released? • Is the battery low?
Cannot play the MD.	<ul style="list-style-type: none"> • Is there moisture condensation on the lens? (Wait for about an hour and then try again.)
Tracks on MD do not play in order, starting with the first track.	<ul style="list-style-type: none"> • Is the Repeat Play or Random Play selected? • Is the FAV function activated?
Cannot hear music—too noisy.	<ul style="list-style-type: none"> • Is the headphones plug inserted all the way? • Is the plug dirty? (Wipe away dirt on the plug.) • Is music recorded on the MD? If not, "BLANK DISC" will appear.
TV picture is distorted. Radio reception is noisy.	Is the unit too near a TV or tuner? (If the TV or tuner is connected to a simple indoor antenna, connect it to an outdoor antenna.)
Power is not turned on.	<ul style="list-style-type: none"> • With both HOLD switches activated, the battery was changed during playback. (Release both HOLD switches and try to operate again.)
FAV registration is impossible.	<ul style="list-style-type: none"> • After FAV music registration, you have changed the battery without stopping the MD. (Turn off the power before changing the battery.)
Charging indicator does not light during charging.	Is the charger too hot? (If so, disconnect the AC adaptor and leave the charger for a while.)

Selecting the Operational Options of Remote Control

Muting a pip tone

When you press the buttons on the remote control, a pip tone is issued except for the A.C.BASS and VOLUME +, - buttons.

To mute the pip tone, while pressing and holding the JOG MODE button in Stop mode or during playback, press the P.MODE button. "BEEP OFF" appears on the display.

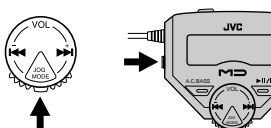

To resume a pip sound, do the same operation again. "BEEP ON" will appear on the display.

Using the Unit with Optional Accessories

Using the unit with an audio system

You can listen to MDs through your audio system.

- Connect a stereo connection cable (not supplied) as shown below after turning off the amplifier.
- Adjust the volume level of the unit to an appropriate level.
- Adjust the volume level on the amplifier.
- Use the unit's buttons for operation. (The remote control will issue a pip tone.)

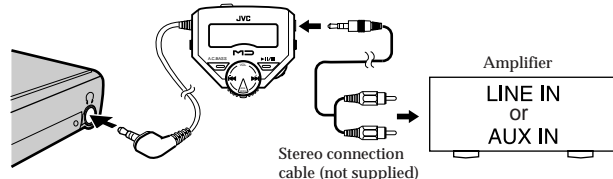

• Direct connection without passing through the remote control may generate noise.

Using the unit with a car audio system

You can listen to an MD through your car audio system. The following options are available for your car audio system.

- Car adaptor (CA-R153)
- Car audio cassette adaptor

Maintenance

Unit:
Wipe the unit and remote control with a soft cloth. Remove stubborn dirt using a cloth which has been dipped in water or soapy water and wrung out, and then wipe dry.

- If you intend to use a chemically treated cleaning cloth, read its directions first.
- Do not use alcohol or paint thinners.

MDs:
If the MD cartridge is dirty wipe it with a damp cloth and then wipe dry.

When storing MDs, avoid locations which are

- Exposed to direct sunlight.
- Susceptible to high levels of humidity or dust.
- Directly exposed to heat from a heating appliance.
- On top of a car dashboard or near the rear window.

MD Messages:

Messages	Meaning	Action
DISC ERROR	There is a problem (damage) with the disc.	Replace the disc.
READ ERROR	Cannot read data.	Remove the MD and reinsert it.

Turning off the backlight

When you turn off the backlight, you can save the battery life.

To turn off the backlight, while pressing and holding the JOG MODE button in Stop mode or during playback, press the DISPLAY button. "LIGHT OFF" appears on the display.

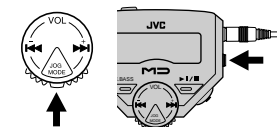

To resume backlighting, do the same operation again. "LIGHT ON" appears on the display. Turning off the unit will also resume backlighting.

CAUTION:

Before connecting the car adaptor, remove the rechargeable battery and the alkaline battery from the unit.

- Connect the car adaptor as shown below.
- Connect the car audio cassette adaptor between the remote control and the cassette slot of your car audio system.
- Adjust the volume level of the unit to an appropriate level.

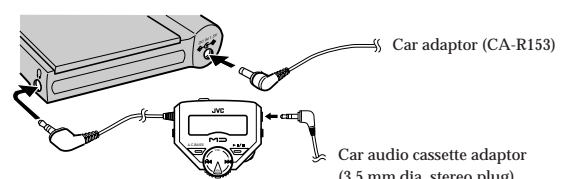

- Notes:**
- Since the insertion direction of the car audio cassette adaptor is limited, be sure whether it can be inserted into the cassette slot of your car audio system.
 - Depending on the vehicle used, noise may occur. In this case, it is recommended to connect a noise filter available on the market between the remote control and car audio cassette adaptor.
 - If your car audio system is equipped with a LINE IN or AUX IN jack, you can connect the output of the remote control to the jack using a stereo mini plug signal cord (not supplied). In this case, you do not need the optional car audio cassette adaptor.

Specifications

Portable MINIDISC player

Type : Minidisc digital audio system
 Sampling frequency : 44.1 kHz
 Compression/expansion method : ATRAC method
 Numbers of channels : 2 channels (stereo)
 Frequency response : 20 Hz to 20,000 Hz
 Wow & flutter : Unmeasurable
 Output : Headphone (3.5 mm dia. stereo x 1)
 5 mW/ch at 10% THD/16 ohms to 47 kohms
 Duration of battery : Approx. 7 hours when using a rechargeable battery (BN-R127) charged for 1.5 hours.
 Approx. 7 hours when using an alkaline battery (LR6-Panasonic)
 Approx. 16 hours when using a rechargeable battery and alkaline battery together
 * Above duration may differ depending on the ambient temperature and conditions.

Power requirements : DC 1.2 V (rechargeable battery), DC 1.5 V (R6 size battery)
 DC IN 1.5 V
 Dimensions (W x H x D) : 82.9 x 18.5 x 103 mm (Excluding buttons and controls)
 Mass : Approx. 124 g (without battery)

AC adaptor (AA-R9017) Input power source : AC 230 V, 50 Hz Output voltage : DC 9 V, 500 mA

Charger/adaptor (AC-R124) Input power source : DC 9 V, 0.5 A Output voltage : DC 1.5 V, 0.7 A

Design and specifications are subject to change without notice. US and foreign patents licensed from Dolby Laboratories Licensing Corporation.

Free Manuals Download Website

<http://myh66.com>

<http://usermanuals.us>

<http://www.somanuals.com>

<http://www.4manuals.cc>

<http://www.manual-lib.com>

<http://www.404manual.com>

<http://www.luxmanual.com>

<http://aubethermostatmanual.com>

Golf course search by state

<http://golfingnear.com>

Email search by domain

<http://emailbydomain.com>

Auto manuals search

<http://auto.somanuals.com>

TV manuals search

<http://tv.somanuals.com>