



SA-DV6000 INSTRUCTIONS

English

**NETWORK PACK STARTUP GUIDE**  
**NETZWERKPACK BEDIENUNGSLEITFADEN**  
**BACK DE RESEAU GUIDE DE DEMARRAGE**  
**GUÍA DE INICIO DEL ADAPTADOR DE RED**  
**GUIDA RAPIDA AL CORREDO DI RETE**

Deutsch

**SA-DV6000**

**INSTRUCTIONS**  
**BEDIENUNGSANLEITUNG**  
**MANUEL D'INSTRUCTIONS**  
**INSTRUCCIONES**  
**ISTRUZIONI**

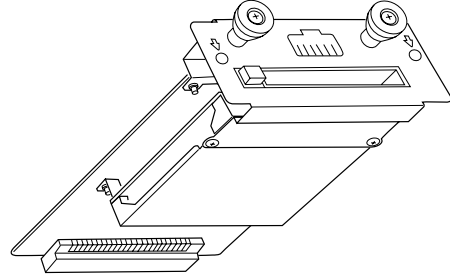

Español

Italiano

**For Customer Use:**  
Enter below the Serial No. which is located on the case. Retain this information for future reference.

Model No. **SA-DV6000**

Serial No. \_\_\_\_\_

This instruction book is made from 100% recycled paper.

LST0124



VICTOR COMPANY OF JAPAN, LIMITED

JVC® is a registered trademark owned by VICTOR COMPANY OF JAPAN, LTD.

JVC® is a registered trademark in Japan, the U.S.A., the U.K. and many other countries.

© 2003 VICTOR COMPANY OF JAPAN, LIMITED

Printed in Japan  
LST0124



## IMPORTANT SAFEGUARDS

1. Read all of these instructions.
2. Save these instructions for later use.
3. All warnings on the product and in the operating instructions should be adhered to.
4. Unplug this appliance system from the wall outlet before cleaning. Do not use liquid cleaners or aerosol cleaners. Use a damp cloth for cleaning.
5. Do not use attachments not recommended by the appliance manufacturer as they may cause hazards.
6. Do not use this appliance near water – for example, near a bathtub, washbowl, kitchen sink, or laundry tub, in a wet basement, or near a swimming pool, etc.
7. Do not place this appliance on an unstable cart, stand, or table. The appliance may fall, causing serious injury to a child or adult, and serious damage to the appliance. Use only with a cart or stand recommended by the manufacturer, or sold with the appliance. Wall or shelf mounting should follow the manufacturer's instructions, and should use a mounting kit approved by the manufacturer. An appliance and cart combination should be moved with care. Quick stops, excessive force, and uneven surfaces may cause the appliance and cart combination to overturn.
8. Slots and openings in the cabinet and the back or bottom are provided for ventilation, and to insure reliable operation of the appliance and to protect it from overheating, these openings must not be blocked or covered. The openings should never be blocked by placing the appliance on a bed, sofa, rug, or other similar surface. This appliance should never be placed near or over a radiator or heat register. This appliance should not be placed in a built-in installation such as a bookcase unless proper ventilation is provided.
9. This appliance should be operated only from the type of power source indicated on the marking label. If you are not sure of the type of power supplied to your home, consult your dealer or local power company. For appliance designed to operate from battery power, refer to the operating instructions.
10. This appliance system is equipped with a 3-wire grounding type plug (a plug having a third (grounding) pin). This plug will only fit into a grounding-type power outlet. This is a safety feature. If you are unable to insert the plug into the outlet, contact your electrician to replace your obsolete outlet. Do not defeat the safety purpose of the grounding plug.
11. For added protection for this product during a lightning storm, or when it is left unattended and unused for long periods of time, unplug it from the wall outlet and disconnect the antenna or cable system. This will prevent damage to the product due to lightning and power-line surges.
12. Do not allow anything to rest on the power cord. Do not locate this appliance where the cord will be abused by persons walking on it.
13. Follow all warnings and instructions marked on the appliance.
14. Do not overload wall outlets and extension cords as this can result in fire or electric shock.
15. Never push objects of any kind into this appliance through cabinet slots as they may touch dangerous voltage points or short out parts that could result in a fire or electric shock. Never spill liquid of any kind on the appliance.
16. Do not attempt to service this appliance yourself as opening or removing covers may expose you to dangerous voltage or other hazards. Refer all servicing to qualified service personnel.
17. Unplug this appliance from the wall outlet and refer servicing to qualified service personnel under the following conditions:
  - a. When the power cord or plug is damaged or frayed.
  - b. If liquid has been spilled into the appliance.
  - c. If the appliance has been exposed to rain or water.
  - d. If the appliance does not operate normally by following the operating instructions. Adjust only those controls that are covered by the operating instructions as improper adjustment of other controls may result in damage and will often require extensive work by a qualified technician to restore the appliance to normal operation.
  - e. If the appliance has been dropped or the cabinet has been damaged.
  - f. When the appliance exhibits a distinct change in performance – this indicates a need for service.
18. When replacement parts are required, be sure the service technician has used replacement parts specified by the manufacturer that have the same characteristics as the original part. Unauthorized substitutions may result in fire, electric shock, or other hazards.
19. Upon completion of any service or repairs to this appliance, ask the service technician to perform routine safety checks to determine that the appliance is in safe operating condition.

PORTABLE CART WARNING  
(symbol provided by RETCO)



## FOR USA AND CANADA



**CAUTION: TO REDUCE THE RISK OF ELECTRIC SHOCK, DO NOT REMOVE COVER (OR BACK). NO USER-SERVICEABLE PARTS INSIDE. REFER SERVICING TO QUALIFIED SERVICE PERSONNEL.**

The lightning flash with arrowhead symbol, alert the user to the presence of uninsulated "dangerous voltage" within the product's enclosure that may be of sufficient magnitude to constitute a risk of electric shock to persons.

The exclamation point within an equilateral triangle is intended to alert the user to the presence of important operating and maintenance (servicing) instructions in the literature accompanying the appliance.

## Information for USA

This device complies with part 15 of the FCC Rules. Changes or modifications not approved by JVC could void the user's authority to operate the equipment.

## INFORMATION (FOR CANADA)

This Class B digital apparatus complies with Canadian ICES-003.

## RENSEIGNEMENT (POUR CANADA)

Cet appareil numérique de la Class B est conforme à la norme NMB-003 du Canada.

## INFORMATION FOR USA

### INFORMATION

This equipment has been tested and found to comply with the limits for a Class B digital device, pursuant to Part 15 of the FCC Rules. These limits are designed to provide reasonable protection against interference when this equipment is used in a residential installation. This equipment generates, uses, and can radiate radio frequency energy and, if not installed and used in accordance with the instructions, may cause harmful interference to radio communications. However, there is no guarantee that interference will not occur in a particular installation. If this equipment does cause harmful interference to radio or television reception, which can be determined by turning the equipment off and on, the user is encouraged to try to correct the interference by one or more of the following measures:

- Reorient or relocate the receiving antenna.
- Increase the separation between the equipment and receiver.
- Connect the equipment into an outlet on a circuit different from that to which the receiver is connected.
- Consult the dealer or an experienced radio/TV technician for help.

**CAUTION**  
**CHANGES OR MODIFICATIONS NOT APPROVED BY JVC COULD VOID USER'S AUTHORITY TO OPERATE THE EQUIPMENT.**

**THIS DEVICE COMPLIES WITH PART 15 OF THE FCC RULES. OPERATION IS SUBJECT TO THE FOLLOWING TWO CONDITIONS: (1) THIS DEVICE MAY NOT CAUSE HARMFUL INTERFERENCE, AND (2) THIS DEVICE MUST ACCEPT ANY INTERFERENCE, RECEIVED, INCLUDING INTERFERENCE THAT MAY CAUSE UNDESIRABLE OPERATION**

## Supplement (SA-DV6000U)

This equipment is in conformity with the provisions and protection requirements of the corresponding European Directives. This equipment is designed for professional video appliances and can be used in the following environments:

- Residential (including both of the location type class 1 and 2 found in IEC 1000-2-5)
- Commercial and light industrial (including, for example, theatres)
- Urban outdoors (based on the definition of location type class 6 in IEC 1000-2-5)

In order to keep the best performance and furthermore for electromagnetic compatibility we recommend to use cables not exceeding the following lengths:

Port	Cable	Length
LAN	SHIELDED TWIST PAIR CABLE	10 meters

## Safety Precautions

Thank you for purchasing this product.  
(These instructions are for SA-DV6000U)  
Before beginning to operate this unit, please read the instruction manual carefully in order to make sure that the best possible performance is obtained.

Due to design modifications, data given in this instruction book are subject to possible change without prior notice.

**WARNING:**  
**TO REDUCE THE RISK OF FIRE OR ELECTRIC SHOCK, DO NOT EXPOSE THIS APPLIANCE TO RAIN OR MOISTURE.**

**AVERTISSEMENT:**  
**POUR EVITER LES RISQUES D'INCENDIE OU D'ELECTRO-CUTION, NE PAS EXPOSER L'APPAREIL A L'HUMIDITE OU A LA PLUIE.**

**POWER SYSTEM**  
**Connection of POWER supply**  
The power for the network pack is supplied through the VCR that is connected to the network pack.

This equipment is in conformity with the provisions and protection requirements of the corresponding European Directives. This equipment is designed for professional video appliances and can be used in the following environments:

- residential area (in houses) or rural area
- commercial and light industry; e.g. offices or theatres
- urban outdoors

In order to keep the best performance and furthermore for electromagnetic compatibility. Use the PC Card which acquired a CE mark.

### Caution

Where there are strong electromagnetic waves or magnetism, for example near a radio or TV transmitter, transformer, motor, etc., the picture may be disturbed. In such case, please keep the apparatus away from the sources of the disturbance.

## Product Components

Network Pack  
SA-DV6000

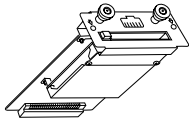

Network Pack Startup Guide  
(This document)



English

Board for encoding/decoding video/audio data by connecting to BR-DV6000.

This document describes the basic matters for use of the Network Pack.

### CD-ROM

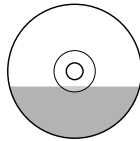

The following software and these Instructions are included on the provided CD-ROM.

#### • PC Application Software

Application software to enable this product to be used more conveniently.

#### • Network Pack User's Guide (pdf)

Reference guide for the Network Pack.

#### • PC Application Software User's Guide

User's guide for the provided PC application software.

Setting of the SA-DV6000 is performed on the menu screen of the BR-DV6000 VCR. For details on the setting methods, please see the Network Pack User's Guide (pdf) included on the provided CD-ROM.

#### SA-DV6000 Users Guide (pdf)

When the Streamproducer program included on the provided CD-ROM is installed, the Network Pack User's Guide (pdf) is automatically installed on the PC and added to the Start menu.

#### [Start/Programs/JVC/SA-DV6000U/User's Guide]

The Adobe Acrobat Reader is required to view PDF files.

## Contents

Features .....	4
Precautions .....	4
What the SA-DV6000 can be used for .....	6
Names and Functions of Parts .....	8
Installation Method .....	9
Check if Correctly Installed .....	10
Specifications .....	11

## Features

- By installing this product to the BR-DV6000, it is possible to encode the image/sound from VCR input or tape playback in real-time, as well as to decode streaming data that has been stored on CompactFlash memory card. Video data is converted to MPEG-4 and audio data is converted to G726 or µlaw.
- Connecting a network cable to the LAN connector or installing a LAN-card etc. in the PC card slot enables real-time streaming.
- The real-time streaming data can be viewed by using Windows Media Player or Quick Time.
- Installing a Compact Flash card in the PC card slot enables real-time capturing.
- Network distribution of the video/audio file created by the SA-DV6000 is possible when the "Streamproducer" program included on the provided CD-ROM is installed on the PC.

## Precautions

- Be sure to turn the VCR's power supply OFF before the SA-DV6000 is attached to the VCR.
- Be sure to turn the VCR's power supply OFF before inserting or removing CF (Compact Flash) cards, etc., into and from the VCR. Inserting or removing cards while the VCR's power supply is turned ON can result in corruption of the recorded sections of the card or damage to the card itself.
- The SA-DV6000 accepts the following cards for which operation has been confirmed: (As of June 2003)

Operating voltage 3.3 V/5 V  
Current consumption 250 mA  
• Wired LAN-card

US: EA2900-117 (Revision C) (Name of manufacturer: Socket Communications, Inc)<sup>\*1</sup>  
Europe: EA2903-162 (Revision C) (Name of manufacturer: Socket Communications, Inc)<sup>\*1</sup>  
Asia: EA2906-194 (Revision C) (Name of manufacturer: Socket Communications, Inc)<sup>\*1</sup>

(The Revision designation is indicated in the upper right of the serial number label affixed to the package.)

• Wireless LAN-card  
TEW-201PC, TEW-202CF (Name of manufacturer: TRENDware)

WCFT1 (Name of manufacturer: LINKSYS)<sup>\*2</sup>  
• CF (Compact Flash) card

SDCFB-16 ~ SDCFB-256 (Name of manufacturer: SanDisk)<sup>\*1</sup>  
\*1: Use PCMCIA card TYPE I or TYPE II adapter

\*2: Use PCMCIA card TYPE II adapter

Do not use other cards that those for which operation has been confirmed. Improper installation may cause damage to the SA-DV6000.  
For the latest operational check card, visit the website below or contact your JVC dealer.  
<http://www.jvc-victor.co.jp/english/pro/prodi/>

\* The names of actual companies and products mentioned in this document may be the trademarks or registered trademarks of their respective owners.  
In this document, symbols like ™, ®, ©, etc. have been omitted.

E-4

## Precautions (cont'd)

### Streamproducer Operating Environment

- Under the following conditions, the Streamproducer can be used in the required operating environment.
  - When using 1 VCR or 1 file.
  - When recording of the image is not performed.
  - When switched distribution is not performed.

### Required operating environment

Hardware	
CPU	Pentium III 700 MHz
Memory	128 MB
Display	XGA (1024 X 768)
Hard disk	* 50 MB for installation * 1 hour viewing time requires empty hard disk space equivalent to 25 MB (high compression) to 200 MB (low compression).
Network	* 1 LAN system for connecting the network pack * Other network environment for distribution if distribution is to be performed in other environment than that described above.
Software	
OS	Windows 2000 Professional, Windows XP Home Edition, Windows XP Professional
Others	Streamproducer is an application applicable to Microsoft Windows Media. Please check the compatibility of the latest version of Windows Media from the JVC website.

- When using multiple VCRs or files, the following operating environment is recommended in order to make full use of the application's functions.

### Recommended Operation Environment

Hardware	
CPU	Pentium IV 2.2 GHz or higher
Memory	512 MB or more
Display	SXGA (1280 X 1024) or more

Other operating environment demands are the same as the required operating environment demands.

### MEMO

The described required operating environment and recommend operating environment are both meant as guidelines to ensure optimal use of the application but are not meant as guarantee of operation. Also, even if you use a computer that complies with the operating environment, optimal use of the application may not be obtainable due to the configuration of your system.

E-5

**What the SA-DV6000 can be used for (cont'd)**

**Connecting a notebook computer for remote control with monitor**

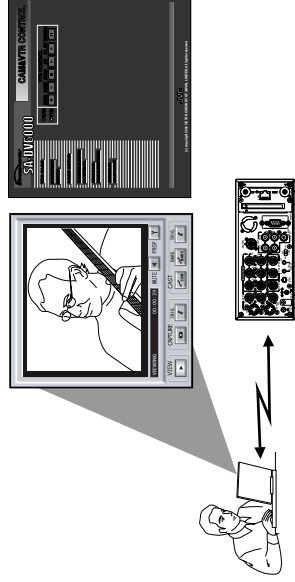

VCR settings and VCR control can be performed using a notebook computer.

**Operation method**

☞ See "Streamcodec" in the Network Pack User's Guide.

**Distributing VCR images on an intranet**

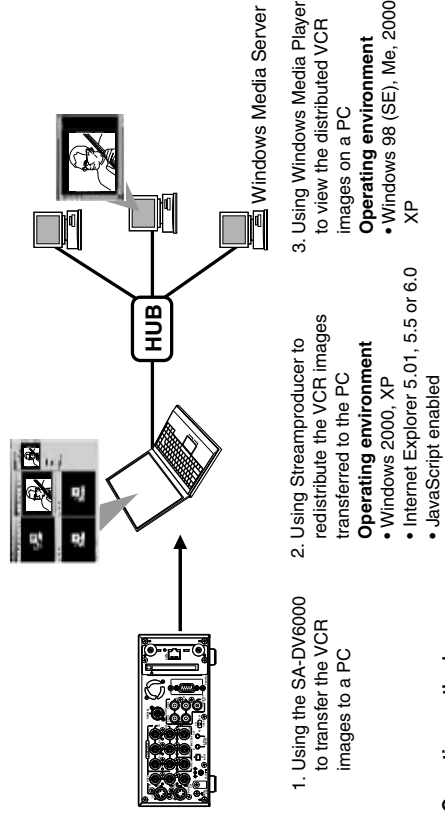

1. Using the SA-DV6000 to transfer the VCR images to a PC
  2. Using Streamproducer to redistribute the VCR images transferred to the PC
  3. Using Windows Media Player to view the distributed VCR images on a PC
- Operating environment**
- Windows 2000, XP
  - Internet Explorer 5.01, 5.5 or 6.0
  - JavaScript enabled

**Operation method**

☞ See the User's Guide to the "Streamproducer" software for network distribution.  
 • See "Network settings", "LAN card" in the Network Pack User's Guide (pdf)

**What the SA-DV6000 can be used for**

**Sending VCR video/audio by e-mail using CF (Compact Flash) card**

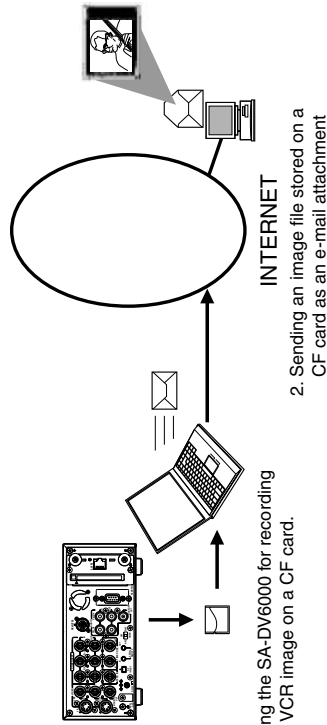

1. Using the SA-DV6000 for recording the VCR image on a CF card.
2. Sending an image file stored on a CF card as an e-mail attachment

**Operation method**

☞ See Network Pack User's Guide (pdf) "CF card recording"

**Viewing and filing VCR images on your PC using "Streamcapture"**

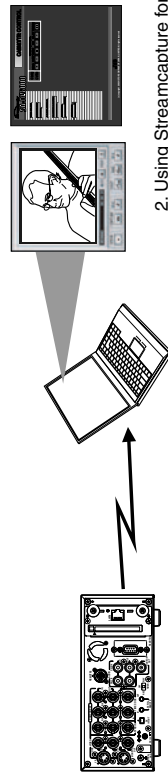

1. Using the SA-DV6000 to transfer the VCR images to a PC
2. Using Streamcapture for viewing and/or filing the VCR images on a PC

**Operation method**

☞ • See "LAN card", "Streamcapture" in the Network Pack User's Guide (pdf)  
 • See the User's Guide to the "Streamproducer" software for network distribution.

**Operating environment**

- Windows 2000, Windows XP Home Edition, Windows XP Professional
- Internet Explorer 5.01, 5.5 or 6.0
- JavaScript enabled

## Names and Functions of Parts

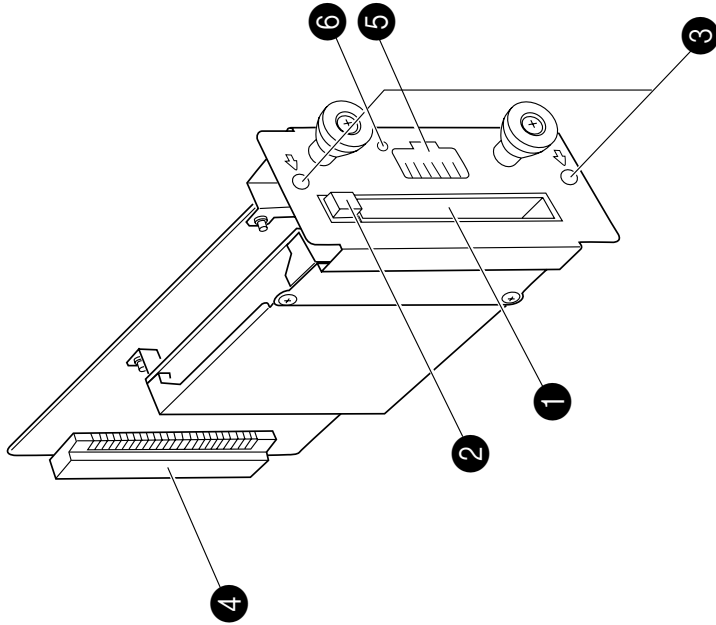

### CAUTION

Please don't touch the metal parts other than the panel.

- 1 PC Card Slot**  
Insert LAN card, CompactFlash card, etc. here.
- 2 EJECT Button**  
Push to eject the card.
- 3 Mounting screw holes**  
Used to install this product to the rear panel of the BR-DV6000 with screws.
- 4 Connector**  
Connects by pushing in the connector for connecting to the VCR main unit.
- 5 LAN Connector**  
Connect LAN cable here.
- 6 LINK LED**  
Lights up when network is connected.

E-8

## Installation Method

Follow the following procedure to install this product to the BR-DV6000 DV Video Cassette Recorder.

- 1 Switch off the VCR power.
- 2 Remove the two screws ② from the cover of the optional board installation slot on the far right side of the rear panel.
- 3 Remove the cover ③.
- 4 Insert the board of this product (SA-DV6000) along the guide rails, correctly align the connectors and push in.
- 5 Fix the SA-DV6000 onto the BR-DV6000 main unit using the two screws ② that were removed in step ②.

### BR-DV6000

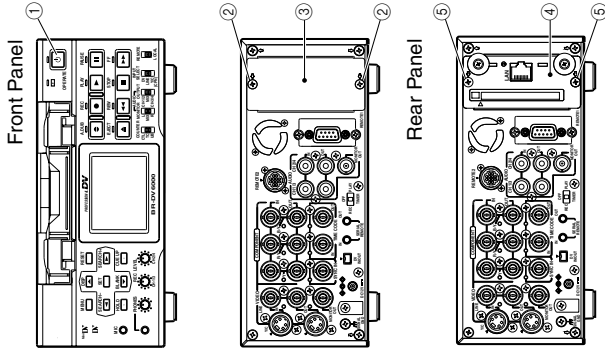

English

E-9

### Check if Correctly Installed

Follow the following procedure to check whether this product has been correctly installed.

- ① Turn OFF the power of the BR-DV6000.
- ② Insert a card into the Card Slot of this product (SA-DV6000).

**Memo**  
Insert the card with its surface facing the LAN connector. (The ▷ mark located near the slot denotes the direction of the card.)

- ③ Turn ON the power of the BR-DV6000 VCR.

- ④ Confirm the card status.  
Make sure that the correct card status indicator that matches the type of card you inserted is displayed on the LCD of BR-DV6000.

\* The card status can be confirmed when BR-DV6000 LCD screen is in enlarged display mode.

**NOTE**

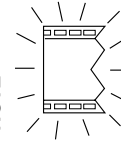

When the power is turned on and the initialization process takes place, the card status indicators shown on the left will blink.

**CAUTION**

To remove the card, turn the BR-DV6000's power off, and then press the Eject button ⑤ to eject the card.

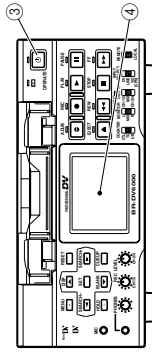
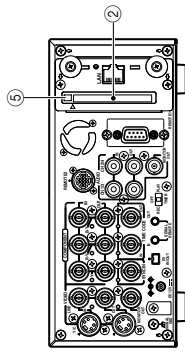
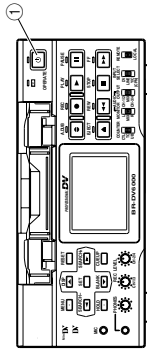

: Blinks during initialization (When power on)



: Effective for LAN Card or internal LAN



: CompactFlash Card



### Specifications

- Mass: 190 g (main unit only)
- Power supply: Supplied from the BR-DV6000
- Power consumption: DC 12 V  $\pm$  250 mA (main unit only)
- Allowable operating temperature: 0°C to 40°C
- Allowable storage temperature: -20°C to 60°C
- Allowable operating humidity: 30% to 80% RH
- Network interface: RJ-45 (category 5), 10 BASE-T/100 BASE-Tx
- PC card slot: TYPE II x 1 (Not compatible with Card Bus)
- Provided accessories: CD-ROM  
INSTRUCTIONS  
Warranty Card (USA and Canada only)

● External Dimensions (Unit: mm)

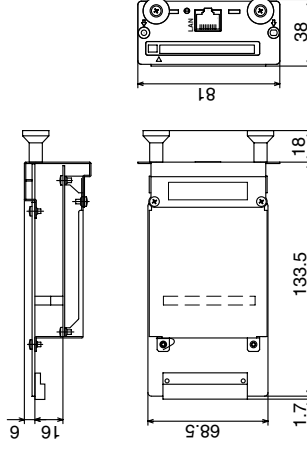

Design and specifications are subject to change without notice.

**JVC**<sup>®</sup>

SA-DV6000 NETWORK PACK

**NETWORK PACK**

**SA-DV6000**

**User's Guide**

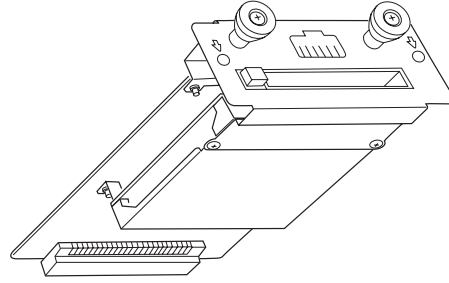

**JVC**<sup>®</sup>  
VICTOR COMPANY OF JAPAN, LIMITED

**JVC** is a registered trademark owned by VICTOR COMPANY OF JAPAN, LTD.  
**JVC** is a registered trademark in Japan, the U.S.A., the U.K. and many other countries.  
© 2003 VICTOR COMPANY OF JAPAN, LIMITED

 LST0154

LST0154



# Contents

Introduction .....	3
<b>Basic</b>	
Inserting/removing CF memory card/LAN card .....	4
Using LAN terminal .....	5
LCD screen .....	6
<b>Menu Settings</b>	
Menu screen structure .....	7
NETWORK PACK menu screen items .....	8
Setting the NETWORK PACK menu screen .....	10
Setting network parameters .....	11
NETWORK settings menu screen item .....	12
Setting user names and passwords .....	14
Inputting character data for network settings .....	15
Restoring factory default .....	16
<b>Encoding</b>	
About video/audio encoding .....	17
Encoding parameter settings .....	18
<b>LAN connection</b>	
About LAN Connection .....	19
Wired LAN .....	20
Wired Connection, single VTR to single Client PC .....	20
Wired Connection, Multiple VTR to single Client PC .....	21
Wired Connection, Multiple Client PC to a single VTR .....	21
Wireless LAN .....	22
Wireless Connection, single VTR to single Client PC .....	23
Wireless Connection, Multiple VTR to single Client PC .....	24
Wireless Connection, Multiple Client PC to a single VTR .....	25
Proxy Settings .....	26
<b>Using LAN card/LAN terminal</b>	
Streaming and capturing Video .....	28
Recording to DV tape and Client PC Simultaneously .....	29
Recording to DV tape and Client PC independently .....	30
Streaming and capturing from a Pre-Recorded DV tape .....	31
<b>Recording on a CF card</b>	
Preparing for CF card recording .....	32
Recording to DV tape and CF card Simultaneously .....	33
Recording to DV tape and CF card Independently .....	34
Recording from a Pre-Recorded DV tape to a CF card .....	35
Specifying the range of a DV tape and recording to CF memory card .....	36
Deleting all clip files on a CF memory card .....	37
<b>Movie Clip</b>	
Selecting playback mode of movie clip .....	38
Playing back a CF memory card .....	39
Selecting another clip while playing a clip .....	41
Protecting a clip file on a CF memory card .....	42
Deleting a clip file on a CF memory card .....	43
Playing back CF memory card clips on your PC .....	44
Transferring a clip on a CF memory to a server .....	45
Transferring multiple clips on a CF memory card to a server .....	46
<b>Network remote control</b>	
Controlling the BR-DV6000/SA-DV6000 via a network .....	47
NETWORK SETUP page .....	49
FTP client setup .....	50
FTP Server Account / ESS-ID / WEP key / LEAP Server Account Setup .....	51
PORT SETUP page .....	52
VTR control .....	53
ENCODE PARAMETERS .....	54
STREAMCAPTURE(Playing back Video / audio using a PC and saving to file) .....	56
Transferring clips on a CF memory card to a server .....	60
<b>Others</b>	
TOP PAGE can be customized .....	61
Connecting Windows Media Player .....	62
Connecting QuickTime Player .....	63
About updating the network pack .....	64
Troubleshooting .....	65
Checking communication / connection .....	67
Terminology .....	68
About IP address/proxy server .....	70

# Introduction

The SA-DV6000 Network Pack is designed to enhance and complement the BR-DV6000 DV Video Cassette Recorder functionality. By adding networking capabilities to the BR-DV6000, the SA-DV6000 allows users to connect to and stream video and audio from the VTR in real-time, from anywhere in the world.

Viewers can connect using Windows Media Player, Quick Time Player, or the application software provided with SA-DV6000.

All while recording the highest quality video to DV tape.

It is also possible to operate the BR-DV6000 (PLAY, STOP, REC, etc.) via a network.

The SA-DV6000 allows real-time streaming of video from BR-DV6000's Video inputs as well as from pre-recorded DV and miniDV tapes.

With bit rates ranging from 56 to 512Kbps, the SA-DV6000 supports many connection types, from MODEMS and ISDN to broadband. When using the trigger mode function of this unit, video can be recorded to a client PC on a network.

The SA-DV6000 even allows the BR-DV6000 VTR to become a publishing point for a media server.

When used with a CompactFlash memory card, the SA-DV6000 features can enhance productivity of any studio.

At the same time as recording to a DV tape, scene file (streaming data) and clip list (CSV file) that contains information such as the starting and ending points, time code, etc. are automatically recorded to the Compact Flash Memory.

This log file is readable by database, spreadsheet, and text editing programs, and can be used with non-linear editing systems.

The log and scene files are small enough to send anywhere, instantly through email.

Using the provided application (CFViewer), you can view thumbnail images of all recorded scenes, and even perform basic assemble editing for review.

In addition, the CF card prevents SA-DV6000 obsolescence.

As improvements are made, just download the files from our Web Site onto a CF card, and update your SA-DV6000.

Characters and symbols used in this instruction book

Caution	Cautionary notes concerning operation of the unit
Memo	Reference such as restrictions of features, etc.
etc.	Reference page or item

\* In general, the names of products manufactured by other companies and mentioned in these instructions are trademarks or registered trademarks of these companies.

Symbols like ™, ®, etc., are not used in these instructions.

## Basic

### Inserting/removing CF memory card/LAN card

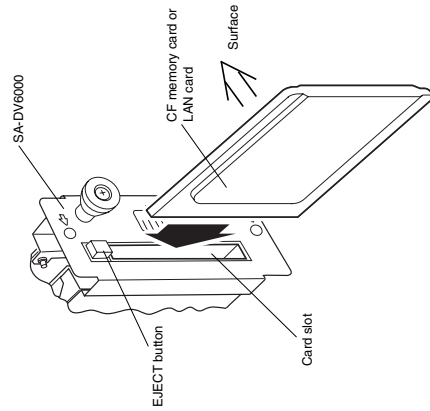

- This SA-DV6000 accepts the following cards for which operation has been confirmed: (As of 01/02/03)
    - Operating system: Windows 98 SE / VISTA
    - Current consumption: Max. 250 mA
  - Wired LAN card
    - US: EA2900-117 (Revision C) (Name of manufacturer: Societ Communications, Inc.)<sup>1</sup>
    - Europe: EA2903-162 (Revision C) (Name of manufacturer: Societ Communications, Inc.)<sup>1</sup>
    - Asia: EA2906-194 (Revision C) (Name of manufacturer: Societ Communications, Inc.)<sup>1</sup>
  - Wireless LAN card
    - TEW-201PC (Name of manufacturer: TRENDnet)
    - TEM-5FC16 (firmware version 0.8.3 or later) (Name of manufacturer: TRENDnet)
    - WCF11 (Name of manufacturer: LINKSYS)<sup>2</sup>
    - AIR-PCM350 (Name of manufacturer: Cisco Systems)
  - CF (Compact Flash) card
    - FC01D, LDK102040 (Name of manufacturer: SanDisk)<sup>1</sup>
    - SDCFB-16 – SDCFB-256 (Name of manufacturer: SanDisk)<sup>1</sup>
- \*1: Use PCMCIA card TYPE I or TYPE II adapter  
\*2: Use PCMCIA card TYPE II adapter

For the latest operational check card, visit the website below or contact your JVC dealer.  
<http://www.jvc-victor.co.jp/english/pro/prodv/>

### Caution

- Make sure the power of BR-DV6000 is off when inserting/removing a CF memory card/LAN card. Inserting/removing a card with the unit power on may damage the data storage section of the CF memory card or the card itself.
- Do not remove the power cable with the power of the BR-DV6000 on. Recorded section on the CF Memory Card or the CF Memory Card itself may be damaged as a result.
- Do not use the wireless LAN card continuously for more than 48 hours.

### Inserting card

1. Turn off the BR-DV6000 power.
2. Insert a card into the SA-DV6000 card slot.
3. Turn on the BR-DV6000 power.

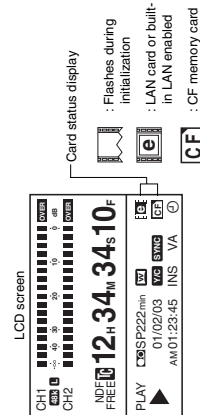

### Removing card

1. Turn off the BR-DV6000 power.
2. Press the EJECT button of SA-DV6000 and remove the card.

## Basic

### Using LAN terminal

Other than the use of a LAN card, this unit is also equipped with a LAN terminal for LAN connection.

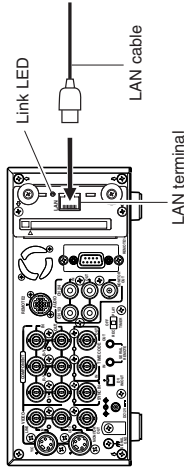

### LAN cable types

- When connecting directly to a PC, use a 10/100 BASE-T cross cable.
- When connecting to a network hub, use a 10/100 BASE-T straight cable.

### Connecting to the LAN terminal

Completely insert the connector of the LAN cable.

### Caution

- Do not remove the LAN cable when the Link LED is on. For a short time, menus cannot be opened.
- Do not connect/disconnect the LAN cable when recording to a CF memory card.
- Do not mount a LAN card when the Link LED is on.

### Link LED

The Link LED will light when connected to a network using the LAN terminal.  
When mounted with a LAN card, the Link LED will not light.

### When using both LAN card and LAN terminal

When mounted with a LAN card, the LAN card will be given priority for LAN connection. In this case, communication via the LAN terminal is not possible.

### Memo

When mounted with a CF memory card, the following can be performed:

- Transferring of a clip recorded on a CF memory card to a server via the LAN terminal.

## Basic

Information from Network Pack SA-DV6000 is displayed on the BR-DV6000 LCD screen. Card status and warnings will be displayed when setting the LCD screen to the Enlarged display mode.

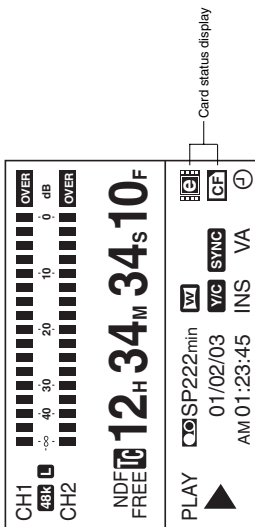

### ■ Card status displays

Display	Description
	Flashing display during initialization (after power on).
	LAN card is inserted in the Network Pack, or built-in LAN is enabled.
	Video/audio data is being sent via LAN card.
	CF memory card is inserted in Network Pack.
	CF memory card is being recorded with data.
	Card is inserted in Network Pack but transmission is not available. There is possibility of unit malfunction. Contact your nearest JVC dealer.

### Receiving Level Indicator of Wireless LAN

If you are using wireless LAN card that can detect receiving level, receiving level indicator is shown next to the card status information on LCD of the BR-DV6000. The indicator shows value from 5 to 0. 5 means maximum level and 0 means minimum level. (The indicator is for reference. The value does not guarantee communication.)  
Some cards may not be able to accurately display the strength of the signals of the wireless LAN if communication is abruptly interrupted.

■ **CF Memory card warning display**  
Displays CF memory card status and system errors.

\* For details concerning warning displays, see page 65.

### When inputting the 44.1kHz sampling audio signal

This unit is not compatible with audio sampling frequency of 44.1kHz. When playing back a tape recorded with audio of 44.1kHz on BR-DV6000 or when inputting audio in the 44.1kHz mode into the DV terminal, the audio will be processed as muted sound. However, the video will be processed as normal.

### About restrictions of BR-DV6000

Only BR-DV6000 marked with (A) at the end of the model name on the Rating Label is compatible with this unit (SA-DV6000).

If a line appears between the time code and level meter on the LCD screen (Enlarged display mode) while SA-DV6000 is mounted on BR-DV6000, the BR-DV6000 in use is not compatible with SA-DV6000 and requires an upgrade.  
For details, consult your JVC dealer.

## Menu settings

When attaching Network Pack SA-DV6000 to BR-DV6000 DV Video cassette recorder, NETWORK PACK CONFIG menu and MOVIE CLIP menu are added to the BR-DV6000 TOP MENU screen. (These menus will not appear during initialization when the unit is first turned on.)

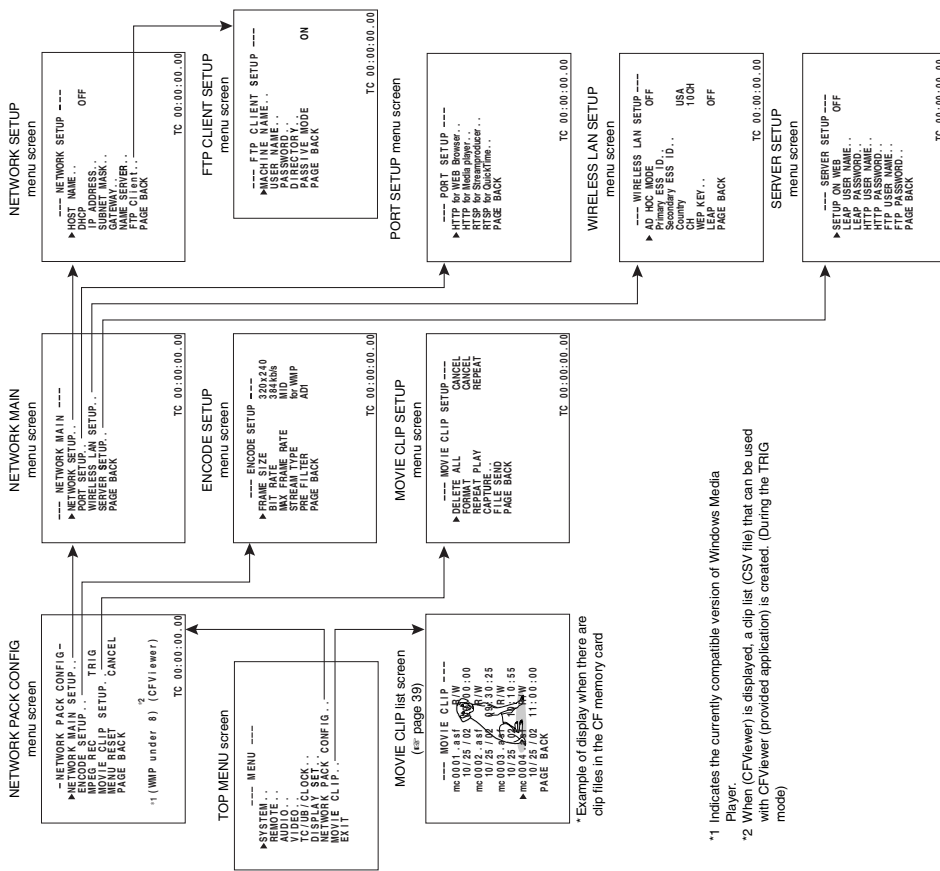

\* Example of display when there are clip files in the CF memory card

\*1 Indicates the currently compatible version of Windows Media Player.  
\*2 When (CF-Viewer) is displayed, a clip list (CSV file) that can be used with CF-Viewer (provided application) is created. (During the TRIG mode)

## Menu settings

● indicates default factory setting.

Item	Setting	Description																																																																																																														
NETWORK MAIN SETUP		Displays menu screen for network related settings. (see page 11)																																																																																																														
ENCODE SETUP		Displays menu screen for setting video and audio compressions.																																																																																																														
★	FRAME SIZE ● 320 × 240 160 × 120	Sets the video compression size. 320 × 240: Sets the image size to 320 × 240 pixels. (SIF) 160 × 120: Sets the image size to 160 × 120 pixels. (QSIF) (1/4 image size of SIF.)																																																																																																														
★	BIT RATE 56K 128K 256K ● 384K 512K	Sets streaming speed (bps). 56K: MPEG4 24 kbps (G726 16 kbps for WMP) (ulaw 64kbps for QT) 128K: MPEG4 104 kbps (G726 16 kbps for WMP) (ulaw 64kbps for QT) 256K: MPEG4 224 kbps (G726 32 kbps for WMP) (ulaw 64kbps for QT) 384K: MPEG4 352 kbps (G726 32 kbps for WMP) (ulaw 64kbps for QT) 512K: MPEG4 472 kbps (G726 40 kbps for WMP) (ulaw 64kbps for QT)																																																																																																														
★	MAX FRAME RATE ● MID MIN	Sets the frame rate per second. The maximum transmitted frames per second varies depending on the FRAME SIZE and BIT RATE settings as shown below. ■ NTSC signal																																																																																																														
		<table border="1"> <thead> <tr> <th rowspan="2">BIT RATE</th> <th colspan="6">FRAME SIZE</th> </tr> <tr> <th colspan="2">320 × 240</th> <th colspan="2">160 × 120</th> <th colspan="2">160 × 120</th> </tr> <tr> <td></td> <th>MAX</th> <th>MID</th> <th>MIN</th> <th>MAX</th> <th>MID</th> <th>MIN</th> </tr> </thead> <tbody> <tr> <td>512K</td> <td>15</td> <td>10</td> <td>7.5</td> <td>30</td> <td>15</td> <td>10</td> </tr> <tr> <td>384K</td> <td>15</td> <td>10</td> <td>7.5</td> <td>30</td> <td>15</td> <td>10</td> </tr> <tr> <td>256K</td> <td>15</td> <td>7.5</td> <td>5</td> <td>30</td> <td>15</td> <td>7.5</td> </tr> <tr> <td>128K</td> <td>7.5</td> <td>5</td> <td>3</td> <td>15</td> <td>10</td> <td>7.5</td> </tr> <tr> <td>56K</td> <td>3</td> <td>1</td> <td>1</td> <td>10</td> <td>7.5</td> <td>5</td> </tr> </tbody> </table> <table border="1"> <thead> <tr> <th rowspan="2">BIT RATE</th> <th colspan="6">FRAME SIZE</th> </tr> <tr> <th colspan="2">320 × 240</th> <th colspan="2">160 × 120</th> <th colspan="2">160 × 120</th> </tr> <tr> <td></td> <th>MAX</th> <th>MID</th> <th>MIN</th> <th>MAX</th> <th>MID</th> <th>MIN</th> </tr> </thead> <tbody> <tr> <td>512K</td> <td>12.5</td> <td>5</td> <td>5</td> <td>25</td> <td>12.5</td> <td>12.5</td> </tr> <tr> <td>384K</td> <td>12.5</td> <td>5</td> <td>5</td> <td>25</td> <td>12.5</td> <td>5</td> </tr> <tr> <td>256K</td> <td>12.5</td> <td>5</td> <td>5</td> <td>25</td> <td>12.5</td> <td>5</td> </tr> <tr> <td>128K</td> <td>5</td> <td>5</td> <td>1</td> <td>12.5</td> <td>12.5</td> <td>5</td> </tr> <tr> <td>56K</td> <td>1</td> <td>1</td> <td>1</td> <td>12.5</td> <td>5</td> <td>5</td> </tr> </tbody> </table> <p>* The frame rates shown in the table are not guaranteed values.</p>	BIT RATE	FRAME SIZE						320 × 240		160 × 120		160 × 120			MAX	MID	MIN	MAX	MID	MIN	512K	15	10	7.5	30	15	10	384K	15	10	7.5	30	15	10	256K	15	7.5	5	30	15	7.5	128K	7.5	5	3	15	10	7.5	56K	3	1	1	10	7.5	5	BIT RATE	FRAME SIZE						320 × 240		160 × 120		160 × 120			MAX	MID	MIN	MAX	MID	MIN	512K	12.5	5	5	25	12.5	12.5	384K	12.5	5	5	25	12.5	5	256K	12.5	5	5	25	12.5	5	128K	5	5	1	12.5	12.5	5	56K	1	1	1	12.5	5	5
BIT RATE	FRAME SIZE																																																																																																															
	320 × 240		160 × 120		160 × 120																																																																																																											
	MAX	MID	MIN	MAX	MID	MIN																																																																																																										
512K	15	10	7.5	30	15	10																																																																																																										
384K	15	10	7.5	30	15	10																																																																																																										
256K	15	7.5	5	30	15	7.5																																																																																																										
128K	7.5	5	3	15	10	7.5																																																																																																										
56K	3	1	1	10	7.5	5																																																																																																										
BIT RATE	FRAME SIZE																																																																																																															
	320 × 240		160 × 120		160 × 120																																																																																																											
	MAX	MID	MIN	MAX	MID	MIN																																																																																																										
512K	12.5	5	5	25	12.5	12.5																																																																																																										
384K	12.5	5	5	25	12.5	5																																																																																																										
256K	12.5	5	5	25	12.5	5																																																																																																										
128K	5	5	1	12.5	12.5	5																																																																																																										
56K	1	1	1	12.5	5	5																																																																																																										
★	STREAM TYPE ● for WMP for QT	Sets the player for stream playback. for WMP : Media Player, Provided application for QT : Quick Time																																																																																																														
		<p><b>Memo</b></p> <ul style="list-style-type: none"> <li>No sound will be heard when playing back using QuickTime while in the WMP mode.</li> <li>No sound will be heard when playing back using Media Player while in the QT mode.</li> <li>Set to WMP mode when recording to CF memory card.</li> </ul>																																																																																																														
	PRE FILTER ● AD1 AD2	AD1 is effective for video with many still images and AD2 is effective for video with motion.																																																																																																														
	PAGE BACK	Pressing the SET button or SEARCH- button returns to the NETWORK PACK CONFIG menu screen.																																																																																																														

→ OVER

## Menu settings

### NETWORK PACK menu screen items

Item	Setting	Description
MPEG REC	● TRIG SPLIT OFF	Selects the operation method for recording video data to a CF memory card or sending data to a Client PC from a LAN card/LAN terminal. TRIG: Operation will start when pressing the REC and PLAY buttons of BD-DV6000 at the same time. Use this setting when simultaneously recording to a DV tape. SPLIT: Use this setting when recording or transferring with CF memory card or LAN card/LAN terminal only. Operation starts when pressing the SET button of BR-DV6000. OFF: Recording will not be made to the CF Memory Card. Transmission of streaming data to a PC from the LAN card/LAN terminal is possible.
MOVIE CLIP SETUP		Displays the menu screen for CF memory card related settings such as formatting or deleting all recorded clip files.
DELETE ALL	● CANCEL EXECUTE	Selecting EXECUTE and pressing the SET button deletes all clip files on the CF memory card. Protected clip files are not deleted.
FORMAT	● CANCEL EXECUTE	Selecting EXECUTE and pressing the SET button starts formatting the card. All recorded clips are erased. Caution: All protected clip files and other files will also be erased.
PLAY MODE	OFF REPEAT 1 ● REPEAT	Playback is performed from the specified clip file to the latest clip file and pauses at the specified clip file. Specified clip file is played backed 3 times. Playback is performed 3 times from the specified clip file to the latest clip file.
CAPTURE		When pressing the SET button, the FILE CAPTURE screen appears. Recording can be made to the CF memory card by specifying the range of the DV cassette tape in the FILE CAPTURE screen settings. (see page 36)
FILE SEND		When pressing the SET button, the clip file specified from a CF memory card can be transferred to a specified server via FTP. Transfer will be performed via the LAN terminal. (see page 46)
PAGE BACK		Pressing the SET button returns to the NETWORK PACK CONFIG menu screen.
MENU RESET	● CANCEL EXECUTE	Selecting EXECUTE and pressing the SET button returns NETWORK PACK CONFIG menu screen settings to the original factory settings.
PAGE BACK		Pressing the SET button SEARCH- button returns to the TOP MENU screen.

### Memo

When setting MPEG REC to SPLIT, the following will appear in the NETWORK PACK CONFIG menu screen.  
CF REC: PUSH SET

## Menu settings

Menu screen settings can be made regardless of whether a card is inserted. Settings will be stored in the SA-DV6000 memory even when turning the power off.

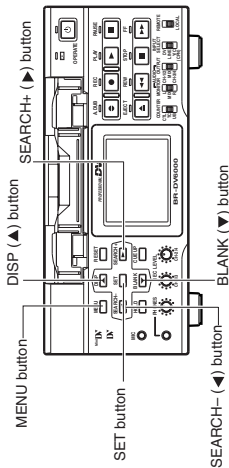

- The NETWORK PACK CONFIG menu screen will not appear during card initialization (flashing display).

1. Turn on the BR-DV6000 power.
2. Press the MENU button. The TOP MENU screen appears.
3. Press the DISP (▲) or the BLANK (▼) button, move the cursor (▶) to NETWORK PACK CONFIG and press the SET button or SEARCH+ (▶) button.
  - The NETWORK PACK CONFIG menu screen appears.

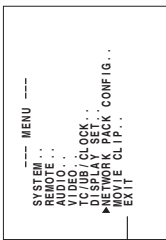

4. Select the item to set.
 

Press the DISP (▲) or the BLANK (▼) button, move the cursor to the desired item to set and press the SET button.

  - The selected menu screen appears.
  - When selecting MPEG REC or MENU RESET, the setting area flashes and the setting can be changed. Set the item according to step 6.
  - When selecting NETWORK MAIN SETUP, the network related setting screen appears. (see page 11)

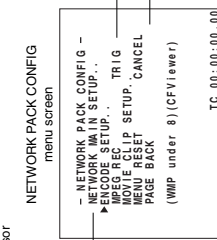

5. Select an item within the menu screen.
 

Press the DISP (▲) or the BLANK (▼) button, move the cursor (▶) to the desired item to set and press the SET button.

  - The setting area flashes and the setting can be changed.
6. Change the setting.
 

Press the DISP (▲) or the BLANK (▼) button to change the setting and press the SET button.

  - Flashing of the setting area stops and the new setting is confirmed.

■ When changing multiple settings, repeat steps 5 and 6 above.

7. Return to the TOP MENU screen.
 

Press the DISP (▲) or the BLANK (▼) button, move the cursor (▶) to PAGE BACK and press the SET button or SEARCH- (◀) button.

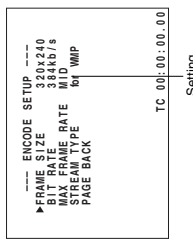

8. When quitting menu screen setting and returning to the normal screen, perform one of the following operations.
  - Press the MENU button.
  - Move the cursor (▶) to EXIT in the TOP MENU screen and press the SET button.

## Menu settings

When using a LAN card or LAN terminal, network related settings for SA-DV6000 are made using NETWORK MAIN SETUP of the NETWORK PACK CONFIG menu. Settings will be stored in the SA-DV6000 memory even when turning the power off.

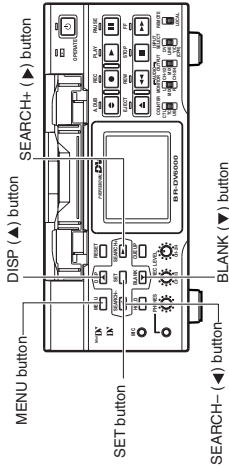

- Settings are made by viewing the LCD screen or video monitor.

1. Turn on the BR-DV6000 power.
2. Check to see that the card status display has changed from a flashing to constant display.
3. Press the MENU button to display the TOP MENU screen.
4. Press the DISP (▲) or the BLANK (▼) button, move the cursor (▶) to NETWORK PACK CONFIG and press SET button or SEARCH+ (▶) button.
  - The NETWORK PACK CONFIG menu screen appears.

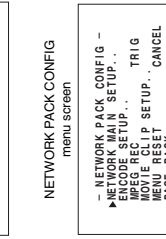

5. Press the DISP (▲) or the BLANK (▼) button, move the cursor (▶) to NETWORK MAIN SETUP and press the SET button or SEARCH+ (▶) button.
  - The NETWORK MAIN menu screen will appear.

The NETWORK MAIN menu screen is structured by four screens.

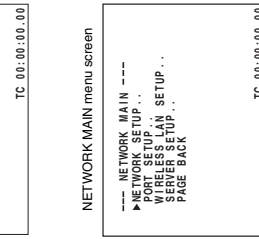

- NETWORK SETUP**
  - PORT SETUP**
  - WIRELESS LAN SETUP**
  - SERVER SETUP**
6. Press the DISP (▲) or the BLANK (▼) button, move the cursor (▶) to SETUP and press the SET button or SEARCH+ (▶) button.
    - The selected SETUP screen appears.

Items with ". ." at the end of the name are set in the INPUT screen.
  7. To return to the NETWORK MAIN SETUP menu screen, select PAGE BACK and press the SET button or, press the SEARCH- (◀) button.

8. To return to the normal screen after completing setting, perform one of the following operations.
  - Press the MENU button
  - Select PAGE BACK to return to the TOP MENU screen. Select EXIT in the TOP MENU screen and press the SET button.

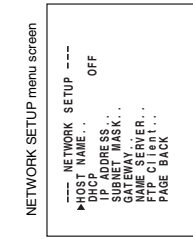

## Menu settings

### NETWORK Settings menu screen item

NETWORK SETUP menu screen ● indicates default factory setting. ☆ indicates items that can also be set from the Web.

Item	Setting	Description
☆ HOST NAME		Displays the host name input setting screen. (4 ~ 64 alphanumerical characters) [Factory setting: none]
☆ DHCP	●OFF ON	Select whether DHCP server is used. OFF: Use this setting when using LAN connection rather than DHCP. ON: When this setting is used, IP ADDRESS and SUBNET MASK, GATEWAY must also be set. When using this setting, IP ADDRESS and SUBNET MASK, GATEWAY are automatically set. * When DHCP is set to ON, WLAN ADHOC MODE cannot be set to AHDM or IBSS.
☆ IP ADDRESS		Displays the IP address setting screen. When using LAN connection with DHCP set to OFF, this setting is required. Set a unique IP address. IP ADDRESS setting is not available when DHCP is set to ON. [Factory setting] 192.168.100.101]
☆ SUBNET MASK		Displays the subnet mask input screen. This setting is required when using LAN connection with DHCP set to OFF. SUBNET MASK setting is not available if DHCP is set to ON. [Factory setting: 255.255.255.000]
☆ GATE WAY		Displays the gateway address input screen. GATEWAY setting is not available when DHCP is set to ON. [Factory setting: 192.168.100.254]
☆ NAME SERVER		Sets the address of the domain name server. [Factory setting: 0.0.0.0]
FTP Client		Displays the FTP client setting screen.
☆ MACHINE NAME		Displays the host name/IP address input screen of the FTP server. (Max.64 alphanumerical characters) [Factory setting: none]
☆ USER NAME		Displays the user name input setting screen for logging onto an FTP server. (Max.16 alphanumerical characters) In the case of "anonymous", user name will be inputted automatically. [Factory setting: anonymous]
☆ PASSWORD		Displays the password input setting screen for logging onto an FTP server. (Max.8 alphanumerical characters)
☆ DIRECTORY		Displays save folder input setting screen of the FTP server. [Factory setting:/home/none]
☆ PASSIVE MODE	●OFF ON	Selects ON/OFF of the PASSIVE mode. If data connection cannot be established with the PASSIVE mode set to OFF, set the PASSIVE mode to ON.
PAGE BACK		Pressing the SET button or SEARCH- button returns the unit to the NETWORK SETUP screen.
PAGE BACK		Pressing the SET button or SEARCH- button returns the unit to the NETWORK MAIN SETUP screen.

→ OVER

## Menu settings

### NETWORK Settings menu screen item

PORT SETUP menu screen ● indicates default factory setting.

Item	Setting	Description
☆ HTTP for WEB Browser	1 : ●80 : 32767	The screen for setting RTSP and HTTP port numbers appears. HTTP for Web Browser can be set with the Web browser HTTP port number and HTTP for Media Player can be set with the Media Player HTTP port number. RTSP for Streamproducer can be set with the Streamproducer RTSP port number and RTSP for Quick Time can be set with the Quick Time RTSP port number. Normally, the unit can be used without changing the factory settings. If there are port restrictions for the LAN environment of your PC, consult your network administrator.
☆ HTTP for Media player	1 : ●8080 : 32767	* When changing a port number, refer to "5-1. Connecting with Camcorder" of the "Streamproducer" User's Guide of the network distribution software to change port settings.
☆ RTSP for Streamproducer	1 : ●8554 : 32767	* Do not use the same port numbers for RTSP and HTTP. * When a port number is changed, switch the power of the BR-DV6000 off once, and then switch it on again.
☆ RTSP for Quick Time	1 : ●554 : 32767	
PAGE BACK		Pressing the SET button or SEARCH- button returns to the NETWORK SETUP menu screen.

### WIRELESS LAN SETUP menu screen

Item	Setting	Description
☆ AD HOC MODE	●OFF AHDM IBSS	Wireless LAN setting OFF: Use this setting when performing communication via access point AHDM/IBSS: Use this setting when performing communication in AD HOC mode with a PC connected with a wireless LAN card (page 16) * When this item is set to AHDM or IBSS, DHCP cannot be set to ON.
☆ Primary ESS ID	NONE	Displays the wireless LAN ESS-ID input setting screen (Max. 32 alphanumerical characters)
☆ Secondary ESS ID	NONE	
☆ Country	●USA EU FRN SPN JPN	Setting for the country using wireless LAN USA: USA, EU: Europe, FRN: France SPN: Spain, JPN: Japan (Set according to operating environment.)
☆ CH	1CH : ●10CH : 14CH	Wireless LAN channel setting CH setting changes depending on the Country setting. USA: 1 ~ 11CH, EU: 1 ~ 13CH, FRN: 10 ~ 13CH, SPN: 10, 11CH, JPN: 1 ~ 14CH
☆ WEP KEY		When encrypting data, set the WEP KEY (10 or 26 characters consisting of letters a - f and numbers). Must be compatible with access point authentication for the use of this item.
☆ LEAP	ON ●OFF	Set to ON when connecting a Cisco Systems wireless LAN device and using the LEAP function. <b>Memo</b> The LEAP function is exclusive to Cisco Systems wireless LAN devices. For details concerning the LEAP function, see the instruction manual accompanying the wireless LAN device.
PAGE BACK		Pressing the SET button or SEARCH- button returns to the NETWORK MAIN SETUP menu screen.

→ OVER

## Menu settings

### NETWORK Settings menu screen item

SERVER SETUP menu screen ● indicates default factory setting.

Item	Setting	Description
SETUP ON WEB	ON ● OFF	Set to ON when changing the USER NAME and PASSWORD from the Web.  <b>Memo</b> If higher security is desired, set this function to OFF so that changes cannot be made from the Web.
LEAP USER NAME		Displays the LEAP USER NAME input screen. (4 ~ 32 alphanumeric characters) Set when using the LEAP function. [Default setting: leap-user]
LEAP PASSWORD		Displays the LEAP PASSWORD input screen. (4 ~ 32 alphanumeric characters) Set when using the LEAP function. [Default setting: sa-dv-jvc]
HTTP USER NAME		Displays the HTTP USER NAME input screen. (3 ~ 8 alphanumeric characters) Set when connecting from the Web browser. [Default setting: jvc]
HTTP PASSWORD		Displays the HTTP PASSWORD input screen. (4 ~ 8 alphanumeric characters) Set when connecting from the Web browser. [Default setting: sa-dv6k]
FTP USER NAME		Displays the FTP USER NAME input screen. (3 ~ 8 alphanumeric characters) Used when uploading USER PAGE. [Default setting: ftp-user]
FTP PASSWORD		Displays the FTP PASSWORD input screen. (4 ~ 8 alphanumeric characters) Used when uploading USER PAGE. [Default setting: sa-dv]
PAGE BACK		Pressing the SET button or SEARCH- button returns to the NETWORK MAIN SETUP menu screen.

### Setting user names and passwords

#### Changing the user name

When changing the HTTP USER NAME or FTP USER NAME, "NEXT STEP SET PASSWORD" will appear on the screen and the PASSWORD menu screen is displayed.

When input is canceled in the PASSWORD menu screen, the user name will also be canceled.

It is possible to change only the password.

When changing the LEAP USER NAME setting, the PASSWORD menu screen will not appear automatically.

#### Setting passwords

Set LEAP, HTTP and FTP PASSWORD using the procedure shown below.

1. First, enter the currently used password when "ENTER OLD PASSWORD" is displayed.  
(When setting the password for the first time, enter the factory set value as the OLD PASSWORD.)
2. Next, enter the new password when "ENTER NEW PASSWORD" is displayed.
3. Lastly, enter the new password again when "CONFIRM NEW PASSWORD" is displayed.

#### Caution

- Do not forget to take a memo of the password. The password cannot be redisplayed.
- Each character input on the PASSWORD menu screen is hidden using asterisks (\*).
- In case the password is forgotten, performing MENU RESET will return the unit to its factory settings.

## Menu settings

### Inputting character data for network settings

Network related settings are made in the individual input setting screens.

Here, HTTP USER NAME is set as an example. Other settings are also made in the same manner.

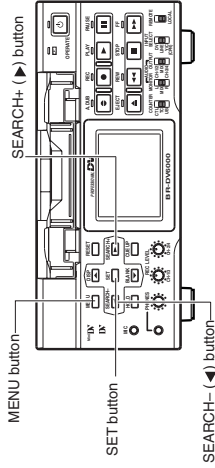

HTTP USER NAME input setting screen  
Currently inputted number of characters/  
max. number of characters

--- HTTP USER NAME --- 3/8

jvc

Character selection area

abcdefghijklmnopqrstuvwxyz  
0123456789-./@#%&\*~

TC 00:00:00.00

Setting area

Character selection area

BS: Backspace (delete previous character)  
A: Alternates between uppercase and lowercase.

J: The set text is confirmed and returns to the previous screen.  
▲: The set text is canceled and returns to the previous screen.

--- USER NAME --- 4/8

jvc

Character selection area

abcdefghijklmnopqrstuvwxyz  
0123456789-./@#%&\*~

TC 00:00:00.00

--- USER NAME --- 5/8

jvc

Character selection area

abcdefghijklmnopqrstuvwxyz  
0123456789-./@#%&\*~

TC 00:00:00.00

--- USER NAME --- 6/8

jvc-1234

Character selection area

abcdefghijklmnopqrstuvwxyz  
0123456789-./@#%&\*~

TC 00:00:00.00

Example: Changing HTTP USER NAME from jvc to jvc-1234

- 1. Select HTTP USER NAME in the SERVER SETUP menu screen and press the SET button.

• The USER NAME input setting screen appears.

1. Characters are selected from the character selection area on the bottom of the screen.  
Press the SEARCH+ (▶) or the SEARCH- (◀) button to flash " " in the character selection area and press the SET button.

- The setting changes to "jvc\_" and the following digit of the setting area flashes.

2. Press the SEARCH+ (▶) or the SEARCH- (◀) button to select "1" in the character selection area and press the SET button.

- The setting changes to "jvc\_1" and the following digit of the setting area flashes.

3. Repeat the above step to set "jvc\_1234" in the setting area.

- To delete or edit set characters, select "BS" within the character selection area and press the SET button.  
The previous character will be deleted. The character on the left will be deleted each time this operation is repeated.

- When pressing the SEARCH+ (▶) or the SEARCH- (◀) button while holding down the STOP button, the cursor will move 5 characters at a time.

- The currently inputted number of characters and the maximum number of characters are displayed on the upper right of the screen.

- To cancel a setting, select the "▲" within the character selection area and press the SET button. The unit will return to the previous screen (SERVER SETUP menu screen).

4. When completed, select "J" within the character selection area and press the SET button.  
• When changing the HTTP USER NAME or FTP USER NAME "NEXT STEP SET PASSWORD" will appear on the screen and the PASSWORD menu screen is displayed. Set the password using the procedure shown above.

#### Memo

When setting is completed for items other than HTTP USER NAME and FTP USER NAME, the unit will return to the previous screen (NETWORK MAIN SETUP or SERVER SETUP menu screen).





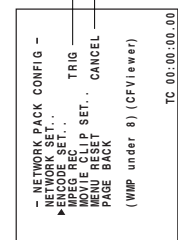
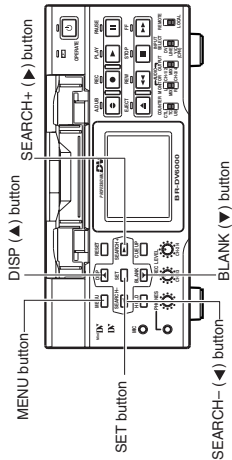

Setting

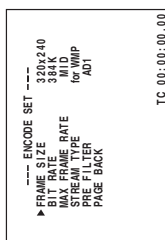

- With the BR-DV6000 power ON, check to see that the network pack has initialized and the card status display has stopped flashing.
- Press MENU button until the TOP MENU screen appears in the video monitor or LCD display.
- Press the DISP (▲) or BLANK (▼) button to move the cursor (▶) to NETWORK PACK CONFIG and press the SET button. The NETWORK PACK CONFIG menu is displayed.
- Press the DISP (▲) or BLANK (▼) button to move the cursor (▶) to ENCODE SET and press the SET button.
  - The ENCODE SET menu appears. From this menu you can adjust the frame size (FRAME SIZE), bit rate (BIT RATE) and frame rate (MAX FRAME RATE).
- Press the DISP (▲) or BLANK (▼) button to the desired parameter and select the parameter to change by pressing the SET button.
  - The max frame rate is set as MAX, MID, and MIN. The actual frame rates associated with these values are determined by the current bit rate and frame size settings, as shown below (for NTSC)\*.

\* Frame rates for PAL models are shown on Page 8.

BIT RATE	FRAME SIZE					
	320 × 240		160 × 120			
	MAX	MID	MIN	MAX	MID	MIN
512K	15	10	7.5	30	15	10
384K	15	10	7.5	30	15	10
256K	15	7.5	5	30	15	7.5
128K	7.5	5	3	15	10	7.5
56K	3	1	1	10	7.5	5

Audio bit rates are described in BIT RATE of page 8.

### Memo

Bit rates are to be used only as a guide. There will be a slight difference depending on the video recorded.

The SA-DV6000 supports both wired and wireless LAN cards for connection directly to a Client PC, to a local Intranet or to the Internet. Other than the use of a LAN card, the SA-DV6000 is also equipped with a LAN terminal for LAN connection. When using a LAN card, however, the LAN terminal will be disabled. Up to 10 clients can access the VTR simultaneously, all viewing the video stream. If the client is a media server or equivalent, numerous clients will be able to view streaming data via the server. (The number of client connections allowed differs depending on the server.)

A list of the currently supported network interface cards can be found on Page 4. The SA-DV6000 supports:

- Both static and dynamic (DHCP) IP addressing
- User selectable user name and password
- HTTP and RTSP port setting
- Connections via Windows Media Player, Quick Time Player, Internet Explorer, or JVC's Streamproducer
- WLAN Ad Hoc mode setting
- WEP with 128 bit encryption

### NOTES

- Operation is only guaranteed for Windows 2000 (Professional or Server) and Windows XP (Home or Professional)
- Only Internet Explorer 5.0 or later is supported
- Only Windows Media Player 7.1 or later is supported (Not compatible with WMP9.)

Examples of configurations are described in the following pages. In order to construct a system with more flexibility than a conventional system, the configurations shown on the following pages will be used.

## LAN connections

### Wired LAN

The SA-DV6000 supports wired LAN connections to client computers either locally, through an intranet or over the internet. Connecting multiple VTR to a Client PC, or multiple Client PC to a VTR is supported. In addition, it is possible for a client to remotely control the VTR as well.

A list of LAN card currently supported by the SA-DV6000 is shown on Page 4. Any compatible LAN card can be used in the Client PC. For LAN card settings on the Client PC side, see the instruction manual of the Client PC or LAN card.

#### ■ Wired Connections, Single VTR to Single Client PC

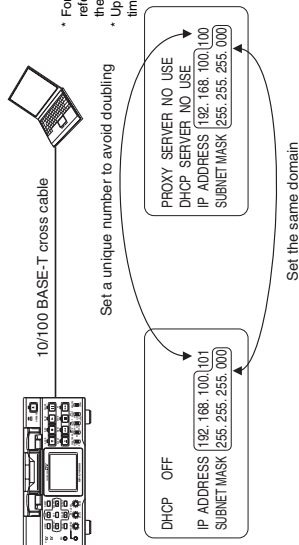

\* For the PC settings when using a LAN card, refer to the instruction manual included with the LAN card.  
\* Up to 10 clients can access at the same time.

#### NOTE:

Refer to the appropriate manual for setting the LAN card or Client PC

Perform the following settings for the above configuration.

- DHCP should be OFF<sup>2</sup>
- VTR and Client PC are set the same domain and different IP addresses.
- The Netmask of both the VTR and computer must be the same
- A CAT-5 cross cable is used between the VTR and computer
- Set the network connection of the Client PC to use no proxy server. Please refer to Page 27 for information regarding this setting if troubles are encountered.

<sup>2</sup> In case the connecting Client PC is not a server equipped with a DHCP feature.

## LAN connections

### Wired LAN

#### ■ Wired Connections, Multiple VTR to Single Client PC

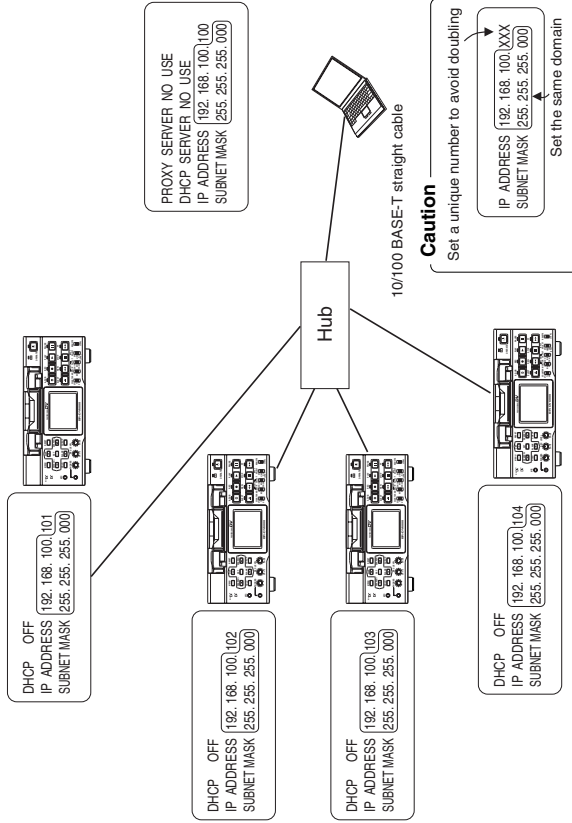

#### NOTE:

Refer to the appropriate manual for setting the PC LAN card

Perform the following settings for the above configuration.

- DHCP should be OFF<sup>3</sup>
- VTR and Client PC are set the same domain and different IP addresses.
- The Netmask of all the VTR and the computer must be the same
- Straight-through CAT-5 cables are used
- If the computer is located remotely and accessing the VTR through the Internet, the Infrastructure must allow through access to the VTR. Consult your IT department.
- Set the network connection of the Client PC to use no proxy server. Please refer to Page 27 for information regarding this setting if troubles are encountered.

<sup>3</sup> In case the connecting Client PC is not a server equipped with a DHCP feature.

## LAN connections

### ■ Wired Connections, Multiple Client PC to a Single VTR

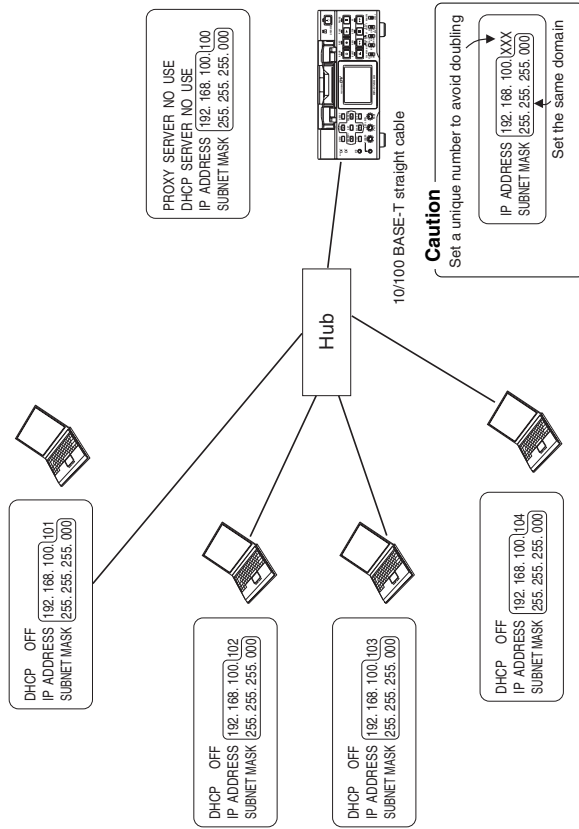

SA-DV6000 allows up to a maximum of 10 clients to be connected at the same time via a network for viewing streaming data. If the client is a media server or equivalent, more clients can view streaming data via the server. (The number of client connections allowed differs depending on the server.)

Perform the following settings for the above configuration.

- DHCP must be OFF.
- Connect using a CAT-5 straight cable.
- If clients will be connecting through an Intranet or the Internet, consult your IT department and request a IP address for the VTR.
- VTR and Client PC are set the same domain and different IP addresses.

## LAN connections

### Wireless LAN

The SA-DV6000 supports wireless LAN connections to client computers either locally, through an Intranet or over the Internet. Connecting multiple VTR to a Client PC, or multiple Client PC to a VTR is supported. In addition, it is possible for a client to remotely control the VTR as well.

A list of LAN card currently supported by the SA-DV6000 is shown on Page 4. Any compatible LAN card can be used in the Client PC. For Client PC settings, see the instruction manual of the LAN card or computer.

#### Wireless Caveats

Low-powered wireless connections are prone to interference from many sources, including, but not limited to, other wireless LANs, cordless telephones, and satellite radio. For further details, see the instruction manual of the used wireless LAN card.

Adverse condition of signals may result in the video being cut-off, noise and in some cases, a disconnection of the network.

In addition, although there are several channels available, as shown below, there is a five channel overlap for each channel, limiting the actual number of channels available in environments where other wireless LANs are present. For example, if a wireless LAN using channel 2 is already in use at near position, the lowest channel you can use for your setup would be channel 7.

#### Cautionary items concerning Wireless LAN (WLAN)

- For the WLAN ESSID ID, input the values of ESSID set in:  
Ad hoc mode: PC of other party  
Infrastructure: Access point
- WLAN AD HOC MODE  
When IBSS is set, the NETWORK MODE setting of the wireless LAN card on the PC side must be set to 802.11 Adhoc. When AdHoc is set, the NETWORK MODE setting of the wireless LAN card on the PC side must be set to Adhoc. Depending on the LAN card on the PC side, only 802.11 Adhoc mode may be available.
- WLAN CH is the wireless frequency band used for communication. If there is an access point, adapter, etc., using the same band in the proximity, there may be a hindrance in the communication and may reduce throughput or the quality of communication. When setting, check the settings of surrounding access points, etc., to avoid doubling.

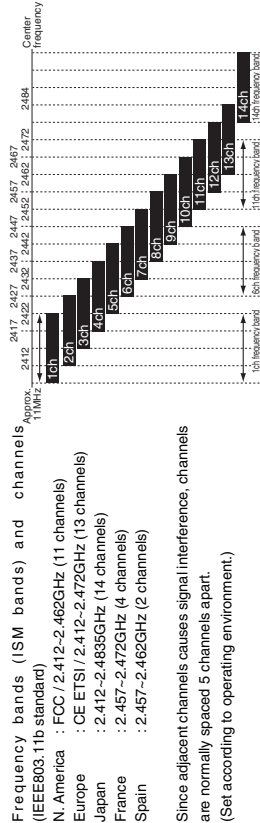

## LAN connections

### Wireless Connections, Single VTR to Single Client PC

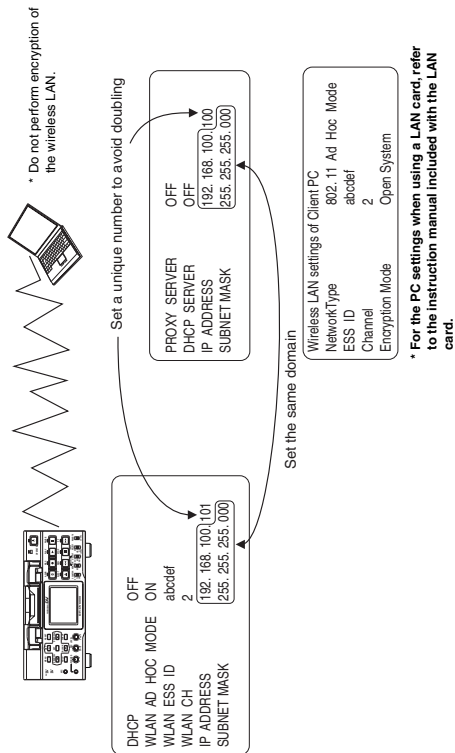

### NOTE

Refer to the appropriate manual for setting the PC LAN card

Perform the following settings for the above configuration.

- DHCP must be OFF.
- VTR and Client PC are set the same domain and different IP addresses.
- The Netmask of both the VTR and Client PC must be the same
- If the WLAN card in the PC is set to 802.11 ADHOC, set the WAN AD HOC MODE to IBSS. If the WLAN card in the PC is set to ADHOC, set the WLAN AD HOC MODE to AHDM.
- The WLAN ESS ID on both the SA-DV6000 and the computer must be the same. The VTR default ESS ID is 'NONE'.
- The SA-DV6000 and the computer must be set to use the same channel (WLAN CH).
- If WEP data encryption is used, the same key must be used in the SA-DV6000 and the PC. The PC encryption mode must be set to 'Open System'.
- Set the network connection of the Client PC to use no proxy server. Please refer to Page 27. Setting a Proxy Server for information regarding this setting if troubles are encountered.

## LAN connections

### Wireless Connections, Multiple VTR to Single Client PC

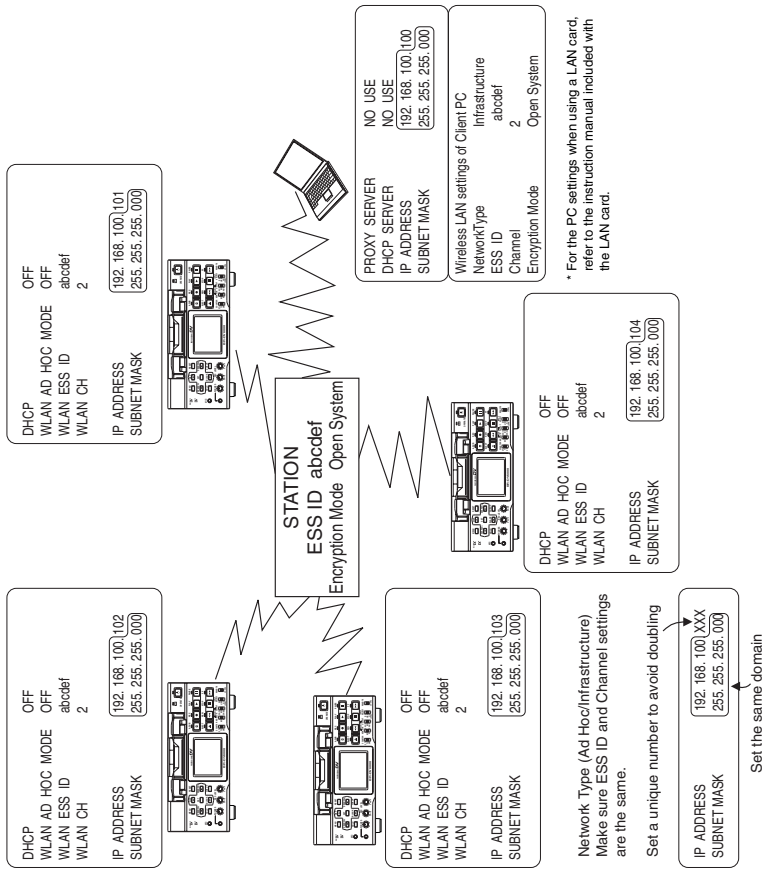

### NOTE

Refer to the appropriate manual for setting the PC LAN card

Perform the following settings for the above configuration.

- DHCP should be OFF\*.
- VTR and Client PC are set the same domain and different IP addresses.
- The Netmask of all the VTR and the Client PC must be the same.
- The WLAN AD HOC MODE must be set OFF.
- The WLAN ESS ID must be the same in the access point and all VTR. The VTR default ESS ID is 'NONE'.
- The WLAN channel must be the same for the PC, the access point and all VTR.
- If WEP data encryption is used, the same key must be used on the PC, the access point, and all VTR. The PC encryption mode must be set to 'Open System'.
- If the computer is located remotely and accessing the VTR through the Internet, the Infrastructure must allow through access to the VTR. Consult your IT department.
- Set the network connection of the Client PC to use no proxy server. Please refer to Page 27 for information regarding this setting if troubles are encountered.

\* In case the connecting Client PC is not a server equipped with a DHCP feature.

## LAN connections

### Wireless Connections, Multiple Client PC to a Single VTR

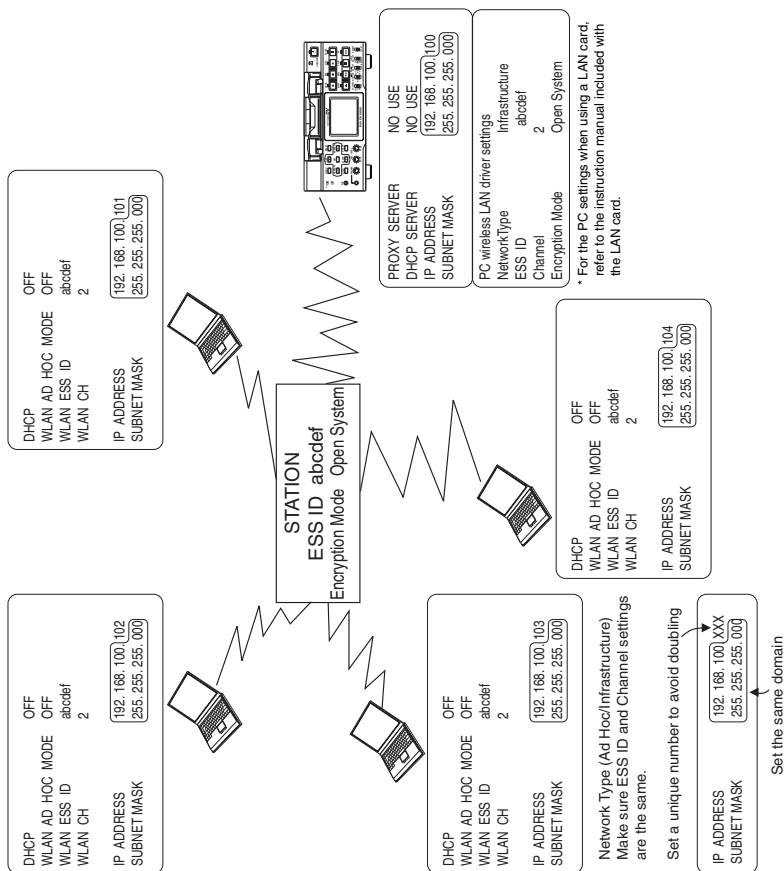

SA-DV6000 allows up to a maximum of 10 clients to be connected at the same time via a network for viewing streaming data. If the client is a media server or equivalent, more clients can view streaming data via the server. (The number of client connections allowed differs depending on the server.)

A total of 10 clients can connect simultaneously, clients can be using Streamproducer and Windows media player to view the VTR's output.

Configure the VTR as follows:

- DHCP must be OFF.
- The WLAN AD\_HOC Mode must be OFF.
- The WLAN ESS ID, WLAN CH, and WEP encryption key must match the access point
- If clients will be connecting through an Intranet or the Internet, consult you IT department and request a IP address for the VTR.
- VTR and Client PC are set the same domain and different IP addresses.

## LAN connections

It is necessary to select whether to use a proxy server or not depending on the network environment.

To determine if you are using a proxy server.

1. From Internet Explorer, click on the 'Tools' in the menu bar, and then click on 'Internet Options'.
2. From the window that opens, click on the 'Connections' tab.
3. From the 'Connections' window, click on the 'LAN Settings' button.
4. If 'Use a proxy server' is checked in the window that opens, then you use a proxy server to access the Internet.
  - If this is not checked, then you don't use a proxy server, and your configuration is complete.
5. Click on the 'Advanced' button.
6. In the 'Exceptions' box of the window that opens, enter the first portion of the VTR IP address followed by \*.\* For example, the IP address of a VTR may be 192.168.100.101, so 192.168.\*.\* has been entered
7. Click 'OK' in all open windows.

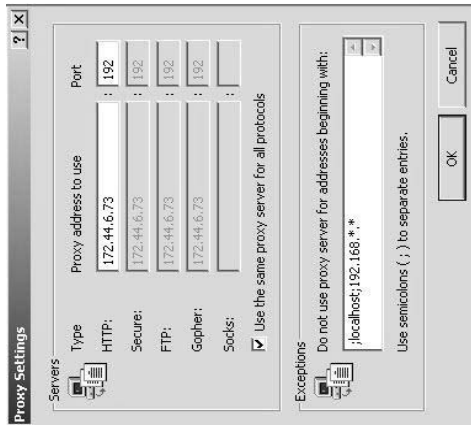
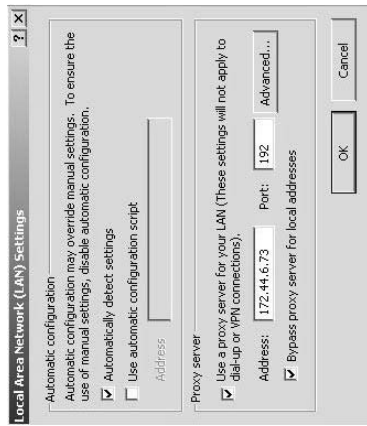

## Using LAN card/LAN terminal

### Streaming and Capturing Video

The SA-DV6000 can send video on a pre-recorded DV tape or video from the video input of BR-DV6000.

Capturing (save to disk) of video transmitted by means of streaming can be started/ended on the Client PC. There are three trigger modes that are supported that, in combination with the trigger mode of the provided application software, enable the VTR operator to start and stop the recording onto the PC hard drive.

- TRIG – This mode is used to simultaneously record video onto a DV tape and a PC disk. Recording to both is controlled by the REC and PLAY button on the BR-DV6000 VTR. The PC user must have the trigger mode of Streamcapture or Streamproducer enabled.
- SPLIT – This mode allows independent record to DV tape or PC disk. Recording to DV tape is controlled by the REC and PLAY button on the VTR. The PC user must have the trigger mode of Streamcapture or Streamproducer enabled.

- OFF – This disables the VTR operators' control of the PC recording. VTR operation is as normal. The PC user can control the saving of the video on the computer. Instructions for using this mode can be found in the Trigger mode function of the Streamproducer Users Guide.

#### Memo

When performing a different type of transmission, switch the PB/DV IN setting in the SYSTEM menu of the VTR. In addition, set the INPUT SELECT switch of the VTR to "DV".

## Using LAN card/LAN terminal

### Recording to DV tape and Client PC Simultaneously

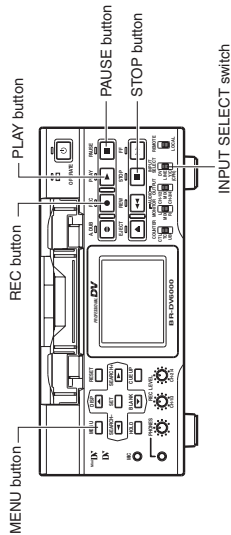

1. Insert a LAN card into the Network Pack, or connect a LAN cable into the LAN terminal.
2. Turn on the BR-DV6000 power.  
Check to see that the LAN card display is showing on the LCD screen. (When using a LAN card)
3. Select the input signal using the INPUT SELECT switch.
4. Insert a recordable DV cassette tape.
5. Press the MENU button to display the TOP MENU screen.
6. Set the NETWORK PACK CONFIG menu screen.

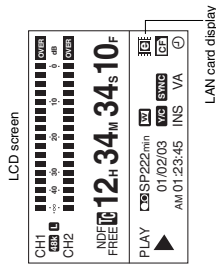

7. When pressing the REC and PLAY buttons of the BR-DV6000 with Streamproducer or Streamcapture software operating in the Trigger mode, recording to the DV cassette tape and Client PC will start simultaneously.  
(Hold down the REC button then press the PLAY button. If the PLAY button is pressed first, the video may flicker momentarily.)
  - The LAN card display on the LCD screen will be as follows:  
 : Red display during data transmission. (When using a LAN card)
8. To stop transmission or recording, press the PAUSE button.
  - BR-DV6000 will be in the standby mode.
9. To resume transmission or recording, press the PAUSE button.
10. To end operation, press the STOP button to stop transmission then disconnect network connection. Then turn off the power.  
Lastly, remove the LAN card.

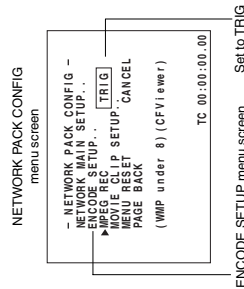

#### Memo

- Streaming data will be sent from the LAN card or LAN terminal even when a DV cassette tape is not inserted.
- When the DV cassette tape reaches the end during recording, the transmission of streaming data from the LAN card/LAN terminal is also stopped.



## Using LAN card/LAN terminal Recording to DV tape and Client PC Independently

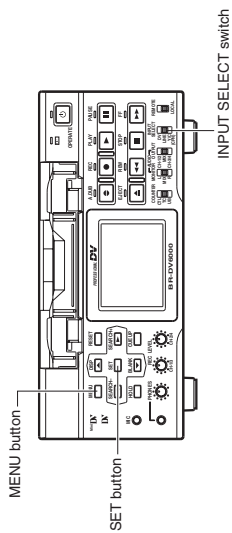

1. Insert a LAN card into the Network Pack, or connect a LAN cable into the LAN terminal.
2. Turn on the BR-DV6000 power.  
Check to see that the LAN card display is showing on the LCD screen. (When using a LAN card)
3. Select the input signal using the INPUT SELECT switch.
4. Press the MENU button to display the TOP MENU screen.
5. Set the NETWORK PACK CONFIG menu screen.

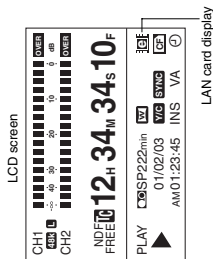

NETWORK PACK CONFIG menu screen

ENCODER SETUP menu screen

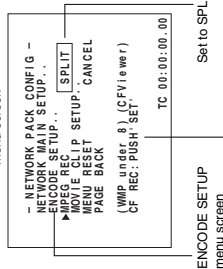

ENCODER SETUP menu screen

Displayed only when setting MPEG REC to SPLIT.

### Memo

- Pressing the SET button does not record the image onto the inserted DV cassette tape.

## Using LAN card/LAN terminal Streaming and Capturing from a Pre-Recorded DV tape

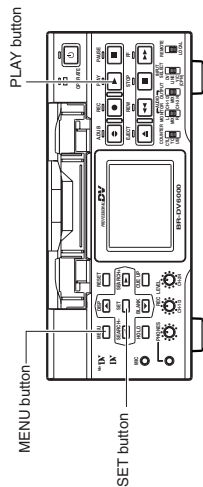

1. Insert a LAN card into the Network Pack, or connect a LAN cable into the LAN terminal.
2. Turn on the BR-DV6000 power.  
Check to see that the LAN card display is showing on the LCD screen. (When using a LAN card)
3. Insert the recorded DV cassette tape.
4. Press the MENU button to display the TOP MENU screen.
5. Set the NETWORK PACK CONFIG menu screen.

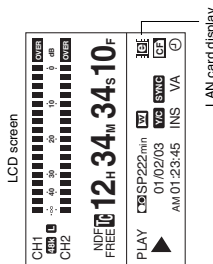

NETWORK PACK CONFIG menu screen

ENCODER SETUP menu screen

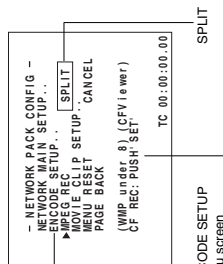

ENCODER SETUP menu screen

Displayed only when setting MPEG REC to SPLIT.

6. When operating Streamproducer or Streamcapture in the Trigger mode and making network connection with SA-DV6000, sending of streaming video/audio data will start from the LAN card or LAN terminal.
  - The LAN card display on the LCD screen will be as follows:
    - Red display during data transmission. (When using a LAN card)
7. Press the PLAY button of BR-DV6000 to start DV cassette tape playback.
8. Press the SET button at the scene to start disk recording with Streamproducer or Streamcapture.
9. To stop recording to the disk, press the SET button.
10. Press the SET button to resume recording to the disk.
11. To end operation, first disconnect the network connection and then turn off the power. Lastly, remove the LAN card.

## Recording on a CF card

CF card recording cannot be performed when transmitting streaming data from the LAN terminal during the SPLIT mode. If the CF memory card is unformatted when performing any of the operations shown below, "NO CF FORMAT" will appear in the LCD screen/video monitor.

- Executing DELETE ALL
- Recording to the CF memory card

### Caution

If the unit enters MOVIE CLIP by operating the menu or the Operation button during formatting CF card, a display of the LCD viewer can go wrong. However, if you operate the menu after formatting has been completed, you will be able to regain a normal display.

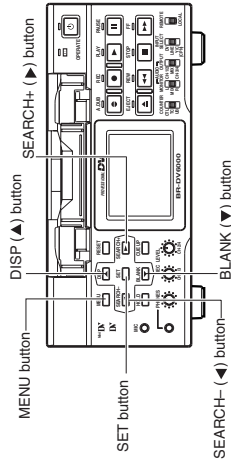

NO CF FORMAT

1. Press the MENU button to display the TOP MENU screen.
2. Use the DISP (▲) or the BLANK (▼) button to select NETWORK PACK CONFIG menu screen → MOVIE CLIP SETUP menu screen.
3. Set FORMAT in the MOVIE CLIP SETUP menu screen to "EXECUTE" and press the SET button.

NETWORK PACK CONFIG menu screen

```

NETWORK PACK CONFIG -
NETWORK MAIN SETUP . .
ENCODE SETUP . . . TRIG
MOVIE CLIP SETUP . . .
MENU RESET CANCEL
PAGE BACK
(WMP under 8) (CFViewer)
    
```

MOVIE CLIP SETUP menu screen

```

MOVIE CLIP SETUP ---
DELETE ALL ---
REPEAT PLAY CANCEL
CAPTURE . . .
FILE SEND
PAGE BACK
FORMAT
    
```

Set to EXECUTE  
Flashing display during  
formatting

MOVIE CLIP SETUP menu screen

```

MOVIE CLIP SETUP ---
DELETE ALL ---
REPEAT PLAY CANCEL
FORMAT
FILE SEND
PAGE BACK
    
```

## Preparing for CF card recording

CF card recording cannot be performed when transmitting streaming data from the LAN terminal during the SPLIT mode. If the CF memory card is unformatted when performing any of the operations shown below, "NO CF FORMAT" will appear in the LCD screen/video monitor.

- Executing DELETE ALL
- Recording to the CF memory card

### Caution

If the unit enters MOVIE CLIP by operating the menu or the Operation button during formatting CF card, a display of the LCD viewer can go wrong. However, if you operate the menu after formatting has been completed, you will be able to regain a normal display.

NO CF FORMAT

1. Press the MENU button to display the TOP MENU screen.
2. Use the DISP (▲) or the BLANK (▼) button to select NETWORK PACK CONFIG menu screen → MOVIE CLIP SETUP menu screen.
3. Set FORMAT in the MOVIE CLIP SETUP menu screen to "EXECUTE" and press the SET button.

NETWORK PACK CONFIG menu screen

```

NETWORK PACK CONFIG -
NETWORK MAIN SETUP . .
ENCODE SETUP . . . TRIG
MOVIE CLIP SETUP . . .
MENU RESET CANCEL
PAGE BACK
(WMP under 8) (CFViewer)
    
```

MOVIE CLIP SETUP menu screen

```

MOVIE CLIP SETUP ---
DELETE ALL ---
REPEAT PLAY CANCEL
CAPTURE . . .
FILE SEND
PAGE BACK
FORMAT
    
```

Set to EXECUTE  
Flashing display during  
formatting

MOVIE CLIP SETUP menu screen

```

MOVIE CLIP SETUP ---
DELETE ALL ---
REPEAT PLAY CANCEL
FORMAT
FILE SEND
PAGE BACK
    
```

## Recording on a CF card Recording to DV tape and CF card Simultaneously

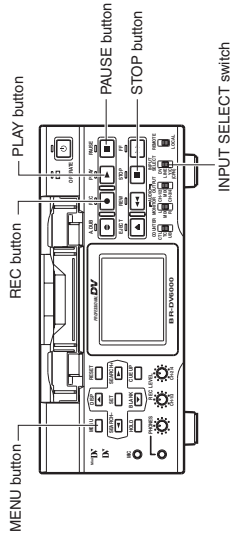

- "NO CF FORMAT" will appear if the inserted CF memory card is not formatted. Format the card in the MOVIE CLIP SET menu screen. (see page 32)
- 1. Insert a CF memory card into the Network Pack.
- 2. Turn on the BR-DV6000 power. Check to see that the CF display appears on the LCD screen. (When the power is turned on, the CF display will flash during initialization.)
- 3. Insert a recordable DV cassette tape.
- 4. Select the input signal using the INPUT SELECT switch.
- 5. Press the MENU button to display the TOP MENU screen.
- 6. Set the NETWORK PACK CONFIG menu screen.
  1. Set MPEG REC to "TRIG".
  2. Set the video/audio compression in the ENCODE SETUP menu screen. (see page 8)
  3. When completed with settings, press the MENU button to return to the normal screen.

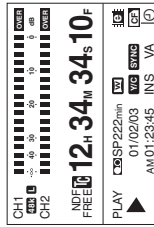

Red display during recording  
Initializing

NETWORK PACK CONFIG menu screen

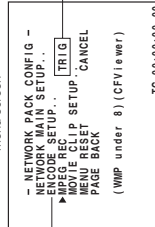

Set to TRIG

ENCODE SETUP menu screen

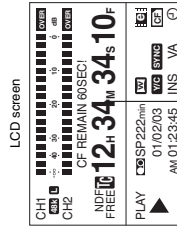

CF memory card remaining warning

### Memo

- Streaming data can be transmitted to a PC during LAN terminal connection.
- When the DV cassette tape has reached the end during recording, CF memory card recording will also stop.
- Every time recording is performed, the recorded event is stored in the clip list of the CF memory card.
- All events can be played back on the MOVIE CLIP screen. (see page 39)
- The CF memory card remaining warning is displayed on the LCD screen (see page 65)
- If the recording made to the CF Memory Card is only about 5 seconds or so or when short files are continuously registered, file(s) may not be created or the still images displayed during thumbnail (CF file) selection may take some time to appear.
- When recording to a CF Memory Card while in the TRIG mode, clip list (CSV file) will be created for viewing using the CFViewer.
- The CSV file name will be the value of the user's bit (UB) set in BR-DV6000. CFViewer will not function properly when there are frequent changes in the UB value (when using UB as the time code). For details concerning UB, please refer to the operator's manual of BR-DV6000.
- Video recorded on a CF Memory Card will start slightly slower than that recorded on tape.



## Recording on a CF card

## Recording to DV tape and CF card Independently

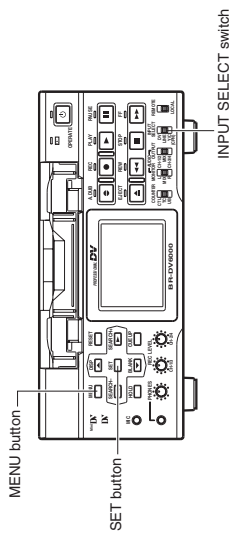

- "NO CF FORMAT" will appear if the inserted CF memory card is not formatted. Format the card in the MOVIE CLIP SET menu screen. (See page 32)

1. Insert a CF memory card into the Network Pack.

2. Turn on the BR-DV6000 power. Check to see that the [CF] display appears on the LCD screen. (When the power is turned on, [CF] display will flash during initialization.)

3. Select the input signal using the INPUT SELECT switch.

4. Press the MENU button to display the TOP MENU screen.

5. Set the NETWORK PACK CONFIG menu screen.

1. Set MPEG REC to "SPLIT".
2. Set the video/audio compression in the ENCODE SETUP menu screen. (See page 8)
3. When completed with settings, press the MENU button to return to the normal screen.

6. Press the SET button of BR-DV6000 to start recording streaming data on the CF memory card.

7. To stop recording, [CF] display will light red.

8. To resume recording, press the SET button.

9. To end recording, press the SET button.

10. Before turning off the power, check to make sure the [CF] indicator on the LCD screen is white.

### Memo

- Streaming data can be transmitted to a PC during LAN terminal connection.
- When recording only to the CF memory card, the clip list will not be registered.
- The CF memory card remaining warning is displayed on the LCD screen (See page 65)

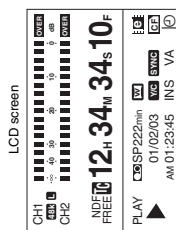

[CF] : Red display during recording  
 [CF] : Initializing

### NETWORK PACK CONFIG menu screen

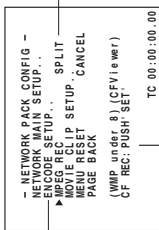

ENCODE SETUP menu screen  
 Displayed only when setting MPEG REC to SPLIT.

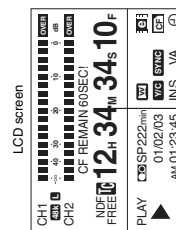

CF memory card remaining warning

## Recording on a CF card

## Recording from a Pre-Recorded DV tape to a CF card

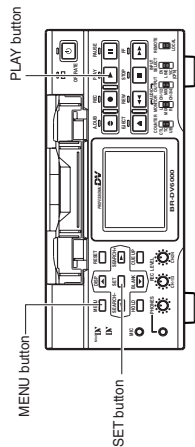

- "NO CF FORMAT" will appear if the inserted CF memory card is not formatted. Format the card in the MOVIE CLIP SET menu screen. (See page 32)

1. Insert a CF memory card into the Network Pack.

2. Turn on the BR-DV6000 power. Check to see that the [CF] display appears on the LCD screen. (When the power is turned on, [CF] display will flash during initialization.)

3. Insert the recorded DV cassette tape.

4. Press the MENU button to display the TOP MENU screen.

5. Set the NETWORK PACK CONFIG menu screen.

1. Set MPEG REC to "SPLIT".
2. Set the video/audio compression in the ENCODE SETUP menu screen. (See page 8)
3. When completed with settings, press the MENU button to return to the normal screen.

6. Press the PLAY button of BR-DV6000 to start DV cassette tape playback.

7. During recording, the [CF] display appears in red.

8. To stop recording, press the SET button.

9. To resume recording, press the SET button once more.

10. To end recording, press the SET button.

11. Before turning off the power, check to make sure the [CF] indicator on the LCD screen is white.

### Memo

- Streaming data can be transmitted to a PC during LAN terminal connection.
- When recording only to the CF memory card, the clip list will not be registered.
- The CF memory card remaining time is displayed on the LCD screen
- While recording DV input to a CF Memory Card in the SPLIT mode, do not operate the VTR section. Recording to the CF Memory Card may stop as a result.

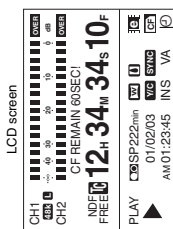

[CF] : Red display during recording  
 [CF] : Initializing

### NETWORK PACK CONFIG menu screen

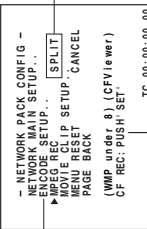

ENCODE SETUP menu screen  
 Displayed only when setting MPEG REC to SPLIT.

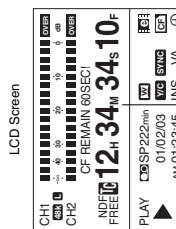

CF memory card remaining warning

## Recording on a CF card Specifying the range of a DV tape and recording to a CF memory card

Recording to a CF Memory Card can be made by specifying the range of video recorded on a DV cassette tape.

### Operation

1. Insert a CF memory card into the network pack.
2. Turn on the power of BR-DV6000. Check to make sure the [CF] mark appears on the LCD screen. (When the power is first turned on, [CF] mark will flash during initialization.)
3. Insert the DV cassette tape to play back.

#### TOP MENU Screen

```

--- MENU ---
SYSTEM ..
AUDIO ..
VIDEO ..
CLUB/CLOCK..
DUB ..
NETWORK PACK CONFIG..
MOVIE CLIP..
EXIT
    
```

#### 4. Display the FILE CAPTURE screen.

1. Press the MENU button and display the TOP MENU screen.
2. Press the DISP (▲) or BLANK (▼) button to set the cursor (▶) to NETWORK PACK CONFIG and press the SET button or SEARCH+ (▶) button.
  - The NETWORK PACK CONFIG screen appears.
  - During initialization of the network pack (while [CF] mark is flashing), NETWORK PACK CONFIG will not appear.
3. Press the DISP (▲) or BLANK (▼) button to set the cursor (▶) to MOVIE CLIP SETUP and press the SET button or SEARCH+ (▶) button.
  - The MOVIE CLIP SETUP screen appears.
4. Press the DISP (▲) or BLANK (▼) button to set the cursor (▶) to CAPTURE and press the SET button.
  - The FILE CAPTURE screen appears and the cursor (▶) will be pointing at IN POINT SET.

#### NETWORK PACK CONFIG Screen

```

- NETWORK PACK CONFIG -
NETWORK MAIN SETUP..
ENCODE SETUP.. TRIG
▶MOVIE CLIP SETUP..
MENU RESET CANCEL
PAGE BACK
(WMP under 8) (CF viewer)
    
```

#### 5. Specify the range to record to CF memory card.

1. Operate the VTR and press the SET button when the video position to start recording appears in the LC screen.
  - The time code of the position to start recording appears below the IN POINT display and the cursor (▶) will move to OUT POINT SET.
  - To accurately specify the position to start recording, use pause, frame advance function, etc.
2. Operate the VTR and press the SET button when the video position to end recording appears in the LCD screen.
  - The time code of the position to end recording appears below the OUT POINT display.
  - To accurately specify the position to end recording, use pause, frame advance function, etc.
- IN POINT and OUT POINT can be changed if recording has yet to be started.

#### FILE CAPTURE Screen

```

--- FILE CAPTURE ---
OUT POINT SET
CAPTURE
PAGE BACK
IN POINT OUT POINT
    
```

#### 6. Record the specified range.

1. Move the cursor (▶) to CAPTURE and press the SET button.
  - Recording to the CF memory card will start and "REC" will appear in red during recording
2. When recording is completed, the "REC" display will disappear and the cursor (▶) will move to IN POINT SET.
  - The set IN POINT and OUT POINT will be cleared and the display will disappear.
  - The recorded clip name will appear on the bottom of the screen.

### Caution

- Set the OUT POINT (position to end recording) at least 5 seconds from the IN POINT (position to start recording).
- When moving to another screen, IN POINT and OUT POINT will be cleared.
- During recording, moving to another screen is not possible.
- To cancel recording, pressing the MENU, EJECT or STOP button.
  - When canceling recording by pressing the MENU or EJECT button:
    - The clip up to the point recording was cancelled is recorded to the CF memory card and the unit returns to the normal screen.
  - When canceling recording by pressing the STOP button:
    - The clip up to the point recording was cancelled is recorded to the CF memory card and the unit returns to the initial state of the FILE CAPTURE screen.
- Since the red REC display appears until the file is closed, the display will appear even when passing the OUT POINT. However, operation will be performed correctly.

## Recording on a CF card Deleting all clip files on a CF memory card

MOVIE CLIP SETUP of the NETWORK PACK CONFIG menu screen is used to delete all clips on a CF memory card.

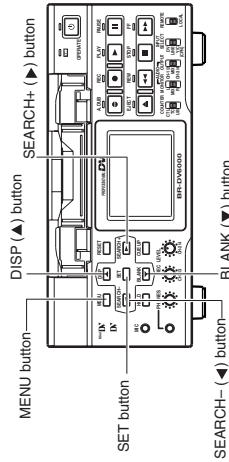

#### 1. Insert an already recorded CF memory card.

#### 2. Turn on the BR-DV6000 power.

Check to see that the [CF] display appears on the LCD screen. (The [CF] mark will flash when first turning on the power or during initialization.)

#### 3. Press the MENU button to display the TOP MENU screen.

#### 4. Use the DISP (▲) or BLANK (▼) button to select NETWORK PACK CONFIG menu screen → MOVIE CLIP SETUP menu screen.

#### 5. Set DELETE ALL in the MOVIE CLIP SETUP menu screen to "EXECUTE" and press the SET button.

- Deletion is executed and "DELETE..." appears flashing on the screen.

#### 6. When deletion is completed, to the MOVIE CLIP SETUP menu screen returns. DELETE ALL setting will return to "CANCEL".

#### 7. To return to the NETWORK CONFIG menu screen, select PAGE BACK and press the SET button or SEARCH- (◀) button.

- To return to the normal screen, press the MENU button.

### Memo

- Protected clip file and clip list (CSV file) are not deleted.

#### NETWORK PACK CONFIG menu screen

```

- NETWORK PACK CONFIG -
NETWORK MAIN SETUP..
ENCODE SETUP.. TRIG
▶MOVIE CLIP SETUP..
MENU RESET CANCEL
PAGE BACK
(WMP under 8) (CF viewer)
    
```

#### MOVIE CLIP SETUP menu screen

```

--- MOVIE CLIP SETUP ---
DELETE ALL EXECUTE
FORMAT CANCEL
REPEAT PLAY REPEAT
PAGE BACK
    
```

#### Set to EXECUTE

#### Deleting

```

--- MOVIE CLIP SETUP ---
DELETE ALL EXECUTE
FORMAT CANCEL
REPEAT PLAY REPEAT
CAPTURE PLAY
PAGE BACK
PAGE BACK
-DELETE-
    
```

#### MOVIE CLIP SETUP menu screen

```

--- MOVIE CLIP SETUP ---
DELETE ALL CANCEL
FORMAT CANCEL
REPEAT PLAY REPEAT
FILE SEND
PAGE BACK
    
```

# Movie clip

NETWORK PACK CONFIG menu screen

```

NETWORK PACK CONFIG --
NETWORK MAIN SET..
ENCODE SET..
MOVIE CLIP SETUP..
MENU RESET
PAGE BACK
(WMP under 8) (CFViewer)
    
```

MOVIE CLIP SET menu screen

```

--- MOVIE CLIP SET ---
DELETE ALL
CANCEL
REPEAT PLAY
CAPTURE..
FILE SEND
PAGE BACK
    
```

## Selecting play back mode of movie clip

The repeat play selection determines how the movie clip files are played, either individually or in sequence.

If the repeat play is set to OFF, playback is performed from the specified clip file to the latest clip file and pauses at the specified clip file.

If the repeat play is set to REPEAT1, specified clip file is played back 3 times.

If the repeat play is set to REPEAT, play back is performed 3 times from the specified clip file to the latest clip file.

1. Press the MENU button to display the TOP MENU screen.
2. Form the NETWORK PACK CONFIG menu, select MOVIE CLIP SET.
3. Move the cursor (▶) to REPEAT PLAY and press the SET button.
4. Press the DISP (▲) or BLANK (▼) button, selecting the desired mode and press the SET button.

### Memo

The MOVIE CLIP screen cannot be accessed during transmission. When entering the MOVIE CLIP screen, the transmitted screen may flicker momentarily.

# Movie clip

When simultaneously recording the video to a DV cassette and CF memory card, recording event will be registered to the clip list of the CF memory card each time recording is performed. The clip list is stored with the recorded event number (clip number) and the date/time when the recording was started. All events (clip numbers) can be played back on the MOVIE CLIP screen.

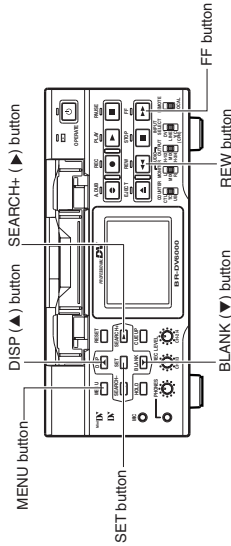

1. MOVIE CLIP will not appear during card initialization (flashing [ ] display).
2. Turn on the BR-DV6000 power. Check to see that the [CF] display appears on the LCD screen. (When the power is turned on, [ ] display will flash during initialization.)
3. Display the MOVIE CLIP screen.
  - 1 Press the MENU button to display the TOP MENU screen.
  - 2 Press the DISP (▲) or BLANK (▼) button, move the cursor (▶) to MOVIE CLIP and press the SET button or SEARCH+ (▶) button.

TOP MENU screen

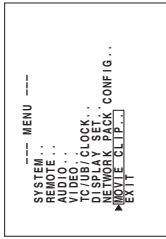

### Memo

- When a MOVIE CLIP menu item is selected and the SET button is pressed
- with no clips recorded on the CF memory card, "NO CLIP" will flash for about 3 seconds.
  - if there is no CF memory card inserted, "NO CF CARD" will flash for about 3 seconds.
  - If a still image does not appear even when selecting the clip to play back, move the cursor and reselect the clip.

CLIP FUNCTION screen

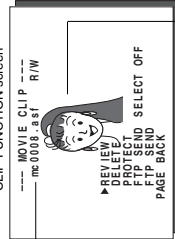

Selected clip number      Still image (starting point) of the selected clip

## Playing back a CF memory card

1. Insert an already recorded CF memory card.
2. Turn on the BR-DV6000 power. Check to see that the [CF] display appears on the LCD screen. (When the power is turned on, [ ] display will flash during initialization.)
3. Display the MOVIE CLIP screen.
  - 1 Press the MENU button to display the TOP MENU screen.
  - 2 Press the DISP (▲) or BLANK (▼) button, move the cursor (▶) to MOVIE CLIP and press the SET button or SEARCH+ (▶) button.

- The movie clip list of the latest clip page recorded on the CF memory card and the still image (starting point) of the latest clip number appear by overlapping.

MOVIE CLIP screen

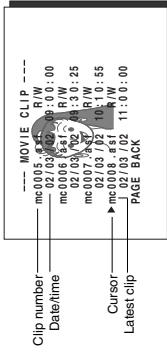

The clip page in the MOVIE CLIP screen displays 4 lists per page.

4. Select the clip to play back.
  - 1 Press the DISP (▲) or BLANK (▼) button and move the cursor (▶) to the clip to play back.
  - 2 Press the DISP (▲) button up scrolls to the page with larger (newer) clip numbers.
  - 3 Press the DISP (▼) button down scrolls to the page with smaller (older) clip numbers.
  - 4 Press the [FF] button to scroll to the next page. Press the [REW] button to scroll to the previous page.
  - 5 Press and hold the [FF] button for about 2 seconds to scroll to the page with the newest clip.
  - 6 Press and hold the [REW] button for about 2 seconds to scroll to the page with the oldest clip.
- 2 Press the SET button.
  - Still image (starting point) of the selected clip appears.

### Note

- ASF files recorded using another device may not play back properly on this unit.
- If recording into the CF card is carried out within 5 seconds, either a file cannot be made or it becomes difficult to display a thumbnail (a still picture displayed when CLIP FILE is selected).

## Movie clip

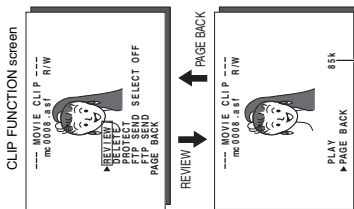

### Memo

- The video encoded by the SA-DV6000 is so designed that it is displayed in a correct aspect ratio by personal computer monitor. When the CF played-back video is viewed by video-out connector output of the BR-DV6000 or observed on a liquid crystal monitor screen, the aspect ratio may look different. This is because a simple output is made on the video for a personal computer and is therefore normal and not a malfunction.
- When REPEAT PLAY in the MOVIE CLIP SETUP screen is set to "REPEAT", repeat playback is performed. (See page 9)

## Playing back a CF memory card

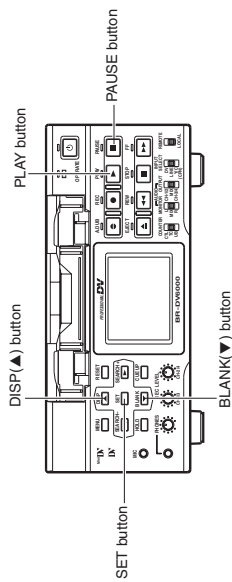

5. Play back the clip.  
Press the DISP (▲) or BLANK (▼) button, move the cursor to REVIEW and press the SET button.
    - The movie clip is played back after the clip no. flashes. The value of the recorded pixel size (320 x 240 or 160 x 120) appears during displaying the still image. The value of the recorded max. bit rate appears during playback.
  6. To pause playback, press the PAUSE button.
  7. To resume playback, press the PLAY button once more.
  8. The following operations are performed when the playback of the selected clip ends. (When REPEAT PLAY in the MOVIE CLIP SETUP screen is set to "OFF")
    - When there are no following clips, the unit pauses at the beginning of the current clip.
    - If following clips exist, the clip no. flashes and then playback is performed. When all remaining clips are played back, the unit pauses at the beginning of the played back clip.
- Selecting PAGE BACK during playback or pausing and press the SET button will return to the MOVIE CLIP screen.

## Movie clip

### Selecting another clip while playing a clip

- Playback will remain on the current clip even when the FF button is pressed if the latest clip is being played back.
- Pressing the REW button during playback of the oldest clip will start playback at the starting point of that clip.
- Pressing the REW button again pauses at the starting point of the following the next clip.
- To move to the next clip during middle of playback or pausing, press the FF button of BR-DV6000.
  - The playback of the current clip stops and the unit pauses at the starting point of the next clip.
- To move to the previous clip during middle of playback or pausing, press the REW button of BR-DV6000.
  - The playback of the current clip stops and the unit pauses at the starting point of the current clip.
- To move to the latest clip during middle of playback or pausing, press the FF button of BR-DV6000 for more than 2 seconds.
  - The unit pauses at the starting point of the latest clip.
  - To start playback, press the PLAY button.
- To move to the oldest clip during middle of playback or pausing, press the REW button of BR-DV6000 for more than 2 seconds.
  - The unit pauses at the starting point of the oldest clip.
  - To start playback, press the PLAY button.

## Movie clip

Clips recorded on a CF memory card can be protected using the MOVIE CLIP screen.

### Protecting a clip file on a CF memory card

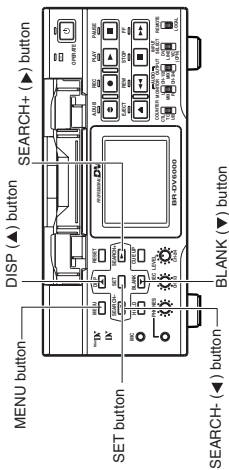

- When executing FORMAT in the MOVIE CLIP SETUP menu screen, protected clips will also be deleted.
- Protected clips will not be deleted even when executing DELETE ALL in the MOVIE CLIP SETUP menu screen.
- Insert an already recorded CF memory card.
  - Turn on the BR-DV6000 power. Check to see that the [CF] display appears on the LCD screen. (When the power is turned on, [CF] display will flash during initialization.)
  - Display the MOVIE CLIP screen.
    - Press the MENU button to display the TOP MENU screen.
    - Press the DISP (▲) or BLANK (▼) button, move the cursor (▶) to MOVIE CLIP and press the SET button or SEARCH+ (▶) button.
      - The latest page of the MOVIE CLIP screen appears.
        - Clip number
  - Select the clip to protect. Press the DISP (▲) or BLANK (▼) button, move the cursor (▶) to the clip to protect and press the SET button.
    - The CLIP FUNCTION screen of the selected clip appears.
  - Press the DISP (▲) or BLANK (▼) button, move the cursor to PROTECT in the CLIP FUNCTION screen and press the SET button.
    - The selected clip is protected.
      - The RW display on the right of the clip number will change to an R display.
- To return to the MOVIE CLIP screen after completing setting, select PAGE BACK and press the SET button or SEARCH+ (▶) button.

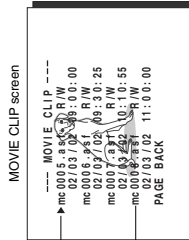
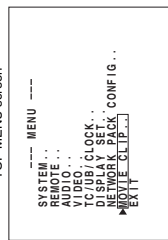

Clip number

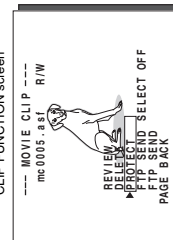

## Movie clip

Clips recorded on a CF memory card can be deleted using the MOVIE CLIP screen.

### Deleting a clip file on a CF memory card

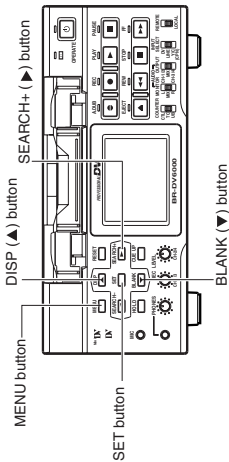

- Insert an already recorded CF memory card.
- Turn on the BR-DV6000 power. Check to see that the [CF] display appears on the LCD screen. (When the power is turned on, [CF] display will flash during initialization.)
- Display the MOVIE CLIP screen.
  - Press the MENU button to display the TOP MENU screen.
  - Press the DISP (▲) or BLANK (▼) button, move the cursor (▶) to MOVIE CLIP and press the SET button or SEARCH+ (▶) button.
    - The latest page of the MOVIE CLIP screen appears.
      - Clip number
  - Select the clip to delete. Press the DISP (▲) or BLANK (▼) button, move the cursor (▶) to the clip to delete and press the SET button.
    - The CLIP FUNCTION screen of the selected clip appears.
  - Press the DISP (▲) or BLANK (▼) button, move the cursor to DELETE in the CLIP FUNCTION screen and press the SET button.
    - A "DELETE OK?" confirmation message appears. (Confirmation screen)
  - To delete, select YES using the DISP (▲) or BLANK (▼) button and press the SET button.
    - "DELETE . ." flashes on the screen for about 5 seconds and then the MOVIE CLIP screen returns. The clip is deleted from the MOVIE CLIP screen.

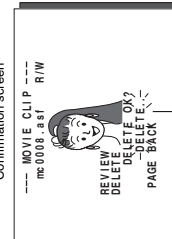
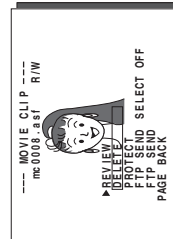
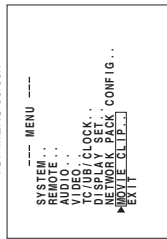

Deleting Flashing display

#### Memo

- Protected clips cannot be deleted even when selecting DELETE.
- In this case, "PROTECT!" will flash for about 2 seconds and then CLIP FUNCTION screen returns.
- After deleting a clip and there are no remaining clips left on the CF memory card, "NO CLIP!" flashes on the screen for about 3 seconds and then the TOP MENU screen returns.
- To delete all clips, use the MOVIE CLIP SET in the NETWORK PACK CONFIG menu screen. (see page 37)

## Movie clip

### Playing back CF memory card clips on your PC

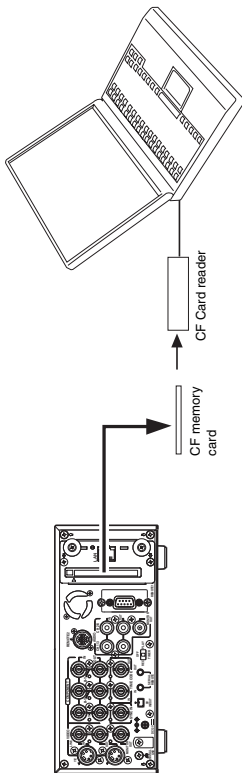

Clips recorded on a CF memory card can be played back on your PC.

\* If the PC is equipped with PCMCIA slot(s), CF card reader is not required.

#### Caution

- Clips recorded on CF memory cards are stored in ASF file format.
- To play back a clip on your PC, Windows Media Player 7.01 is required. (WM9 is not supported.)
- Windows Media Player is compatible with Windows XP or Windows 2000/98(SE)/Me operating system.
- Media Player can be downloaded from the Microsoft Website.

During this time, download the following codec software as well.

- The codec software is automatically downloaded when opening the clip file and running Windows Media Player.
- Video codec (decoder) ISO MPEG4
- Audio codec (decoder) G.726

#### Operation

1. Load data already recorded on a CF memory card to your PC using a CF card reader, etc.
2. Launch Explorer, etc., and open the recorded clip file in ASF format.
  - Windows Media Player launches and the clip is played back.

#### Memo

Video and audio files (clip files) in CF memory cards can be appended to email as attachment files.

## Movie clip

### Transferring a clip on a CF memory to a server

A clip recorded on a CF memory card can be transferred to a server via FTP.

#### Caution

- Before using this function, it is necessary to set the destination, etc. of the clip using the FTP CLIENT SETUP menu on the LCD screen or Web.

#### Operation

1. Insert a pre-recorded CF memory card into the network pack. Then, connect the BR-DV6000 to the network using the LAN terminal of the network pack.
2. Turn on the power of BR-DV6000. Check to make sure the [CE] mark appears on the LCD screen. (When the power is first turned on, [ ] mark will flash during initialization.)
3. Make sure the BR-DV6000 is not in operation.

#### 4. Display the MOVIE CLIP screen.

1. Press the MENU button to display the TOP MENU screen.
2. Press the DISP (▲) or BLANK (▼) button to select MOVIE CLIP and press the SET button or SEARCH+ (▶) button.
  - The MOVIE CLIP screen appears.
  - During initialization of the network pack (while [ ] mark is flashing), NETWORK PACK CONFIG will not appear.

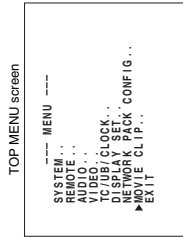

#### 5. Select the clip to transfer to a server

1. Press the DISP (▲) or BLANK (▼) button to select the clip to transfer.
  - Use the [FF] button to move to the next page and the [REW] button to move to the previous page.
  - Pressing the [FF] button for about 2 seconds will move to the page with the latest clip.
  - Pressing the [REW] button for about 2 seconds will move to the page with the oldest clip.
2. Press the SET button to display the CLIP FUNCTION screen of the selected clip.
  - A still-image of the top screen of the selected clip and the FUNCTION LIST will appear.

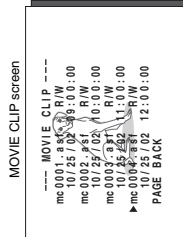

#### 6. Transfer the selected clip to a server.

1. In the CLIP FUNCTION screen, set the cursor (▶) to FTP SEND.
2. When the SET button is pressed, "WAIT A MINUTE PLEASE!" will appear and transfer will start.

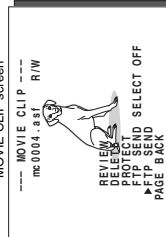

#### 7. When the transfer is completed, the "WAIT A MINUTE PLEASE!" display will disappear.

- If the transfer is unsuccessful, "FTP SEND ERROR!!" will appear. In this case, check the settings of the FTP CLIENT SETUP screen or the used network environment.



## Movie clip

### Transferring multiple clips on a CF memory card to a server

Multiple clips on a CF memory card can be transferred to a server at once via FTP.

#### Caution

- Before using this function, it is necessary to set the destination, etc. of the clip using the FTP CLIENT SETUP menu on the LCD screen or Web.

#### Operation

1. Insert a pre-recorded CF memory card into the network pack. Then, connect the BR-DV6000 to the network using the LAN terminal of the network pack.
2. Turn on the power of BR-DV6000. Check to make sure the [ ] mark appears on the LCD screen. (When the power is first turned on, [ ] mark will flash during initialization.)
3. Make sure the BR-DV6000 is not in operation.

TOP MENU screen

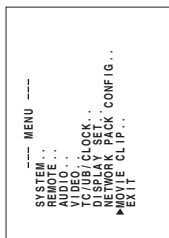

MOVIE CLIP screen

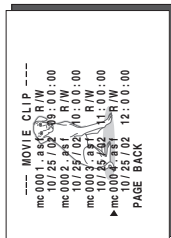

CLIP FUNCTION screen



MOVIE CLIP SETUP screen

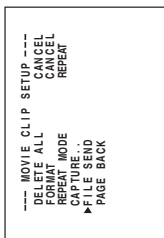

4. Display the MOVIE CLIP screen.
  - 1 Press the MENU button to display the TOP MENU screen.
  - 2 Press the DISP (▲) or BLANK (▼) button to select MOVIE CLIP and press the SET button or SEARCH+ (▶) button.
- The MOVIE CLIP screen appears.
- During initialization of the network pack (while [ ] mark is flashing), NETWORK PACK CONFIG will not appear.

#### 5. Select the clip to transfer to a server

- 1 Press the DISP (▲) or BLANK (▼) button to select the clip to transfer.
  - Use the [FF] button to move to the next page and the [REW] button to move to the previous page.
  - Pressing the [FF] button for about 2 seconds will move to the page with the latest clip.
  - Pressing the [REW] button for about 2 seconds will move to the page with the oldest clip.
- 2 Press the SET button to display the CLIP FUNCTION screen of the selected clip.
  - A still-image of the top screen of the selected clip and the FUNCTION LIST will appear.
- 3 Press the DISP (▲) or BLANK (▼) button to set the cursor (▶) to FTP SEND SELECT OFF.
  - If already selected, FTP SEND SELECT ON will appear.
- 4 Press the SET button.
- 5 To cancel the selection, set the cursor (▶) to FTP SEND SELECT ON and press the SET button.
- 6 The display will change to FTP SEND SELECT OFF.
  - Set the cursor (▶) to PAGE BACK and press the SET button to return to the MOVIE CLIP screen. Repeat steps from 5-1.
  - "\*" will appear in front of the selected clips.

#### 6. Display the MOVIE CLIP SETUP screen.

- 1 In the MOVIE CLIP screen, set the cursor (▶) to PAGE BACK and press the SET button to return to the NETWORK PACK CONFIG screen.
- 2 Set the cursor (▶) to MOVIE CLIP SETUP and press the SET button to display the MOVIE CLIP SETUP screen.

#### 7. Transfer the selected clips to a server.

- 1 Set the cursor (▶) to FILE SEND.
- 2 When the SET button is pressed, "WAIT A MINUTE PLEASE!" will appear and transfer will start.

#### 8. When the transfer is completed, the "WAIT A MINUTE PLEASE!" display will disappear.

- If the transfer is unsuccessful, "FTP SEND ERROR!!" will appear. In this case, check the settings of the FTP CLIENT SETUP screen or the used network environment.

46

## Network remote control

### Controlling the BR-DV6000/SA-DV6000 via a network

With the Network Pack, BR-DV6000/SA-DV6000 can be controlled via LAN.

It is also possible to playback video and audio from SA-DV6000 on your PC in the STREAMCAPTURE screen in realtime (live display) as well as save data to files.

Peer-to-peer connection that directly connects the unit with a PC is explained here.

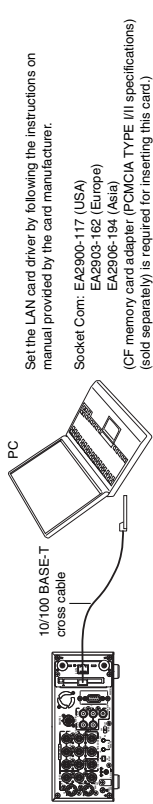

- There are the 3 types of users for Web access:
- Users referred as "jvc" (can be changed) that can perform all operations, "ENCODE" users that can view all data but only change the encoding settings, and "BROWSE" users that can only view data.
- The default password for each user type is "sa-dv6k" for "jvc" users, first 4 characters of the password set for "jvc" users for "ENCODE" users (default is "sa-d") and fixed password of "sa-dv" for "BROWSE" users.
- The following is an explanation when login is made a user permitted with all operations. In the case of other users, the OK button and Cancel button will be disabled even if operations on the screen are allowed.

1. Turn your PC and BR-DV6000 power off.
2. Insert the PCMCIA LAN card to specify into SA-DV6000.  
If you do not own a LAN card, the LAN terminal may be used instead.
3. Connect the unit and PC using a 10/100 BASE-T cross cable.
4. Turn the PC and BR-DV6000 power on.
5. Insert a recordable DV cassette tape or a pre-recorded DV cassette tape.
6. PC settings
  - Set the LAN card driver according to the manual provided by the card manufacturer.
  - Network settings (≡ page 12)
    - 1 Set the following items in the TCP/IP properties:
      - \* DHCP server: is not used.
      - IP address: 192.168.100.101
      - Subnet mask: 255.255.255.000
    - 2 Setting the proxy server.
  - Set the proxy server using the "LAN SETTINGS" of Windows.
  - When using peer-to-peer communication that directly connects the PC and SA-DV6000, deselect the "Use a proxy server" checkbox.
  - When the "Use a proxy server" setting must be enabled due to a LAN environment (in-company LAN, etc.), click "Advanced..." and input the IP address of BR-DV6000 in "Exceptions" of the "Use a proxy server" setting. (≡ "About proxy servers," Page 27)
7. Launch the browser on your PC and enter 192.168.100.101 (default factory setting) in the address bar and press ENTER.
  - A confirmation window for user ID and password appears.
8. Input the user ID and password.
  - 1 For the user ID, input "jvc" (factory setting).  
For the password, input "sa-dv6k" (factory setting) or the name set in the SERVER SETUP menu screen.  
(≡ HTTP USER NAME, HTTP PASSWORD on page 14)
  - 2 Check to make sure the inputted user ID and password are correct and click the OK icon.  
(Check "Save password" so that the password does not need to be inputted for future accesses.)

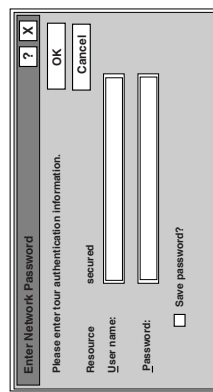

9. If the user ID and password are correct, the NETWORK PACK SETUP screen appears on the PC monitor.
  - BR-DV6000/SA-DV6000 settings and operations can be controlled using the NETWORK PACK SETUP. (≡ page 49)

→ OVER

47

## Network remote control

### Controlling the BR-DV6000/SA-DV6000 via a network

#### Caution

- When setting the NETWORK PACK SETUP screen (NETWORK SETUP, PORT SETUP, VTR CONTROL or ENCODE PARAMETERS) and the same menu screen is displayed on the LCD screen of BR-DV6000, values set in the NETWORK PACK SETUP screen will not appear instantly on menu screen of the LCD screen of BR-DV6000.

The values set in the NETWORK PACK SETUP screen will appear after the menu screen of BR-DV6000 is closed once and reopened.

- During VTR control, noise may be heard from the speakers. However, this is not a malfunction. If the noise becomes irritating, open the "Sound & Multimedia" property from the Windows Control Panel and set the sound of "Windows Explorer Start Navigation" of "Sound Events" to off.

\* For setting details, see Windows' Help.

- Check to make sure that REMOTE SEL NET in the REMOTE [1/2] menu screen of BR-DV6000 is set to "LOC+REM". VTR control will not be available when REMOTE SEL NET is set to "OFF".

- Depending on the cache setting of your browser, the parameters updated in the VTR's menu may not be effective immediately.
- When changing the password, "ENCODE" users will be fixed with the first 4 characters of the set password and "BROWSE" users will be fixed with "sa-dv" as the password.

## Network remote control

### NETWORK SETUP page

Clicking NETWORK SETUP on the left of the Streamcorder screen displays the NETWORK SETUP screen for performing network related settings.

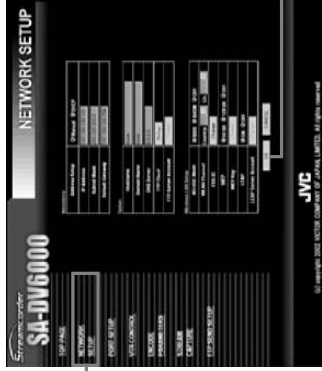

Screen selection

\* At the present, there will be influence on the operation when setting the Domain Name or DNS Server.

Clicking the OK icon will confirm the inputted setting.

Contact your network administrator for any unclear points concerning network settings.

Item	Setting	Description	Factory setting
Address Setup	MANUAL DHCP	The address setting mode can be selected. MANUAL : Select for MANUAL mode. DHCP : Select for DHCP mode.	MANUAL
IP Address		The IP address can be set.	192.168.100.101
Subnet Mask		The subnet mask can be set.	255.255.255.000
Default Gateway		The gateway address can be set.	192.168.100.254
Host Name		The host name can be set. (Max: 63 alphanumerical characters)	none
Domain Name		The domain name can be entered. (Max: 63 alphanumerical characters)	none*
DNS Server		The address of the domain name system server can be set.	0.0.0.0*
FTP Client		When SETUP is selected, the FTP CLIENT SETUP screen appears. (see page 50)	
FTP Server Account		When selecting Change, settings can be made in the FTP Server Account Setup screen. (see page 51)	
AD-HOC MODE	IBSS AHD OFF	The AD-HOC mode can be set.	OFF
WLAN Channel	1 CH : 10 CH : 14 CH	• WLAN Channel can be set. • Select the region of use using the COUNTRY setting. USA: U.S., EU: Europe, FRN: France, SPN: Spain, JPN: Japan	10 CH
ESS-ID		When selecting Change, settings can be made in the ESS-ID Setup screen. (Max: 32 alphanumerical characters) (see page 51)	
WEP	64 Bit 128 Bit OFF	WEP is set.	OFF
WEP Key		When selecting Change, settings can be made in the WEP Key Setup screen. (see page 51)	
LEAP	ON OFF	When set to ON, LEAP Server Account can be set.	OFF
LEAP Server Account		When Change is selected, settings can be made in the LEAP Server Account Setup screen. (see page 51)	

#### Caution

If the IP address is changed in the Streamcorder screen, the unit will automatically jump to the new IP address. However, the screen may not be displayed correctly depending on the environment. In this case, access by specifying the new IP address using a browser. (see operation 7 on pages 47)



## Network remote control

### NETWORK SETUP page

#### ■ FTP client setup

Settings for transferring clips recorded on a CF memory card to a server via FTP are performed.

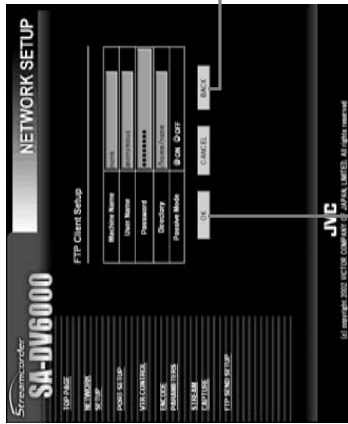

Clicking BACK will return to the previous NETWORK SETUP screen.

Clicking OK will confirm the input settings.

Item	Content	Factory setting
Machine Name	Input the host name of the FTP server.	none
User Name	Input the user name for logging onto the FTP server.	anonymous
Password	Input the password for logging onto the FTP server.	/home/none
Directory	Input the save folder of the FTP server.	OFF
Passive Mode	Select ON/OFF of the PASV mode. If data connection cannot be established with the PASV mode set to OFF, set the PASV mode to ON.	OFF

#### Memo

For transferring clips on a CF memory card to a server, see page 60.

## Network remote control

### NETWORK SETUP page

#### ■ FTP Server Account Setup screen

Item	Description	Factory setting
User Name	Input the FTP user name.	ftp-user
Old password	Input the currently used password.	sa-dv
New Password	Input the new password.	
Confirm New	For confirmation, input the new password again.	

#### ■ Primary ESS-ID

Item	Description	Factory setting
Current ESS-ID	Input the currently used ESS-ID.	NONE
New ESS-ID	Input the new ESS-ID.	
Confirm New	For confirmation, input the new ESS-ID again.	

#### ■ Secondary ESS-ID

Item	Description	Factory setting
Current ESS-ID	Input the currently used ESS-ID.	NONE
New ESS-ID	Input the new ESS-ID.	
Confirm New	For confirmation, input the new ESS-ID again.	

#### ■ WEP Key Setup screen

Item	Description	Factory setting
Current Wep Key	Input the currently used Wep Key.	
New Wep Key	Input the new Wep Key.	
Confirm New	For confirmation, input the new Wep Key again.	

#### ■ LEAP Server Account Setup screen

Item	Description	Factory setting
User Name	Input the LEAP user name.	leap-user
Old Password	Input the currently used password.	sa-dv
New Password	Input the new password.	
Confirm New	For confirmation, input the new password again.	

## Network remote control

### PORT SETUP page

Clicking PORT SETUP on the left of the Streamcorder screen displays the PORT SETUP screen for performing port settings.

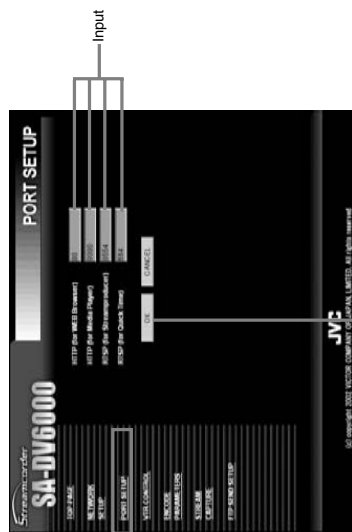

Clicking the OK icon will confirm the inputted setting.

Item	Description	Factory setting
HTTP (for WEB Browser)	The HTTP port for WEB browser can be set. (1 to 32767)	80
HTTP (for Media Player)	The HTTP port for Media Player can be set. (1 to 32767)	8080
RTSP (for Streamproducer)	The Streamproducer RTSP port number can be set. (1 ~ 32767)	8554
RTSP (for Quick Time)	Quick Time RTSP port number can be set. (1 ~ 32767)	554

**\* Changing ports require special knowledge. Always consult the administrator of the connecting network when making changes.**  
**\* Do not use the same port numbers for RTSP and HTTP.**

### Caution

If the port is changed in the Streamcorder screen, the unit will automatically jump to the new port. However, the screen may not be displayed correctly depending on the environment. In this case, access by specifying the new port using a browser. (See operation 7. on pages 47)

## Network remote control

### VTR control

VTR can be controlled using a network connection.

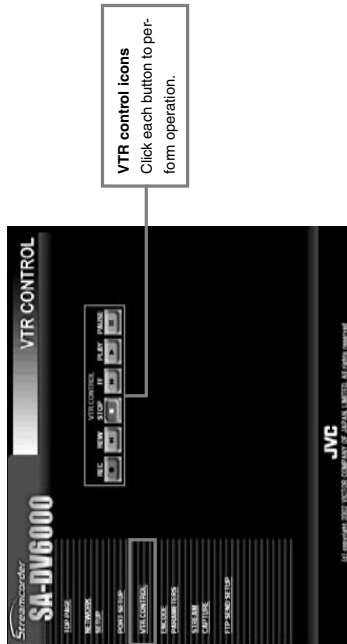

**VTR control icons**  
Click each button to perform operation.

■ To control the VTR in the Streamcorder screen, the following menu items of BR-DV6000 must be set in advance.

REMOTE [1/2] menu screen

```

REMOTE [1/2]
REMOTE SEL NET
REMOTE SEL SER ON
REMOTE SEL DV ON
REMOTE SEL JVC ON
▶ LOCAL FUNCTION STP+EFFT
PREROLL
NEXT PAGE
PAGE BACK
    
```

- Set REMOTE SEL NET in the REMOTE [1/2] menu screen to LOC+REM or ON.  
When set to OFF, the VTR cannot be controlled from the Streamcorder screen.

■ VTR control icon operations are as follows:

Previous mode	REC	REW	STOP	FF	PLAY	PAUSE/STILL
STOP	REC	REW	—	FF	PLAY	STILL
FF	—	REW	STOP	—	PLAY	STILL
REW	—	—	STOP	FF	PLAY	STILL
PLAY	REC	SHTL-20	STOP	SHTL+20	—	STILL
FWD	—	SHTL-20	STOP	SHTL+20	PLAY	STILL
REV	—	—	STOP	—	PLAY	STILL
STILL	REC-PAUSE	SHTL-20	STOP	SHTL+20	PLAY	—
REC	—	—	STOP	—	—	REC-PAUSE
REC-PAUSE	REC	—	STOP	—	REC	—

Clicking VTR control icon

—: Mode will not change

VTR mode	State of buttons pressed
STOP	STOP
FF	FF
REW	REW
PLAY	PLAY
FWD	PLAY + FF
REV	PLAY + REV
STILL	PLAY + PAUSE
REC	PLAY + REC
REC-PAUSE	PLAY + REC + PAUSE

## Network remote control

## ENCODE PARAMETERS

Clicking ENCODE PARAMETERS on the left of the Streamcoder screen displays the ENCODE PARAMETERS screen for performing video/audio compression settings.

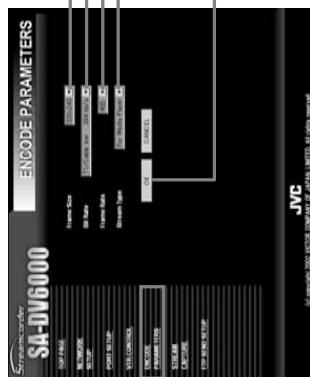

Screen selection

**Setting**  
Select the setting from the pull-down menu.

Click the OK icon to confirm setting.

## Network remote control

## ENCODE PARAMETERS

● indicates default factory setting.

Item	Setting	Description
Stream Type	● For Media Player For Quick Time	Sets the player for stream playback.  <b>Memo</b> <ul style="list-style-type: none"> <li>No sound will be heard when playing back using QuickTime while in the WMP mode.</li> <li>No sound will be heard when playing back using Media Player while in the QT mode.</li> <li>Set to WMP mode when recording to CF memory card.</li> </ul>
PRE FILTER	● AD1 AD2	AD1 is effective for video with many still images and AD2 is effective for video with motion.

### Setting range

● indicates default factory setting.

Item	Setting	Description
Frame Size	● 320 × 240 160 × 120	Sets the video compression size. 320 × 240: Sets the image size to 320 × 240 pixels. (SIF) 160 × 120: Sets the image size to 160 × 120 pixels. (QSIF) (1/4 image size of SIF)
Bit Rate	56K (bps) 128K (bps) 256K (bps) ● 384K (bps) 512K (bps)	Sets the video streaming speed.
Frame Rate	● MAX MID MIN	Sets the frame rate per second. The maximum transmitted frames per second varies depending on the FRAME SIZE and BIT RATE settings as shown below: ■ NTSC signal

BIT RATE	320 × 240			160 × 120		
	MAX	MID	MIN	MAX	MID	MIN
512K	15	10	7.5	30	15	10
384K	15	10	7.5	30	15	10
256K	15	7.5	5	30	15	7.5
128K	7.5	5	3	15	10	7.5
56K	3	1	1	10	7.5	5

BIT RATE	320 × 240			160 × 120		
	MAX	MID	MIN	MAX	MID	MIN
512K	12.5	5	5	25	12.5	12.5
384K	12.5	5	5	25	12.5	5
256K	12.5	5	5	25	12.5	5
128K	5	5	1	12.5	12.5	5
56K	1	1	1	12.5	5	5

\* The frame rates shown in the table are not guaranteed values.

→ OVER

## Network remote control STREAMCAPTURE (Playing back video/audio using a PC and saving to file)

Click the characters "STREAMCAPTURE" on the left of the Streamcorder screen to display the Streamcapture screen shown below. Video and audio sent from SA-DV6000 via LAN can be played back on your PC in the Streamcapture screen or data can be saved to files. It can be used on a PC that has Streamproducer installed.

- Since video on the STREAMCAPTURE screen is converted video data, images will take more time to appear than the actual video of the BR-DV6000.

**Video display**  
The display size can be changed in the Property dialog box. (see page 59)

**Status/Time elapsed display**

- The current status is displayed. VIEWING: Video or audio from SA-DV6000 is being played back in realtime (live display). CAPTURING: Video or audio is being saved in your PC. STOP: Playback is stopped. WAITING: TRIG recording standby.

Clicking the button will display the Property dialog box. Video display size and the save destination folder can be changed. (see page 59)

Operation buttons .....	Clicking will start operation. When on, the button will light.
VIEW	Click to play back or stop video/audio from SA-DV6000 on your PC. (ON when the Streamcapture screen is opened.)
CAPTURE	Click to save video or audio to a PC. <b>Default destination</b> My Document\Streamcorder (IPAddress) <b>Saved file name:</b> The file name based on the capture start time will be used. 0 2 0 3 0 4 - 1 5 3 0 0 .asf Year Month Day Hour Minute Second
CAPTURE-TRIG.	Click when saving the video/audio from SA-DV6000 to your PC when starting recording with BR-DV6000. (see page 57)
CAST-VIEW	Click when sending the video/audio from SA-DV6000 to another PC. (see page 57)
CAST-BARS	Click when transmitting color-bars rather than video from SA-DV6000. (Video from SA-DV6000 will be displayed in the video display of the Streamcapture screen. Color bars will not be displayed.)
CAST-TRIG.	Click when sending the video/audio from SA-DV6000 to another PC when starting recording with BR-DV6000. (see page 57)
MUTE	Click to turn on/off the mute setting. When on, the playback sound will be muted.

**Caution**  
Set the stream type to "for WMIP". (see page 55)

## Network remote control STREAMCAPTURE (Playing back video/audio using a PC and saving to file)

### About the Trigger Mode function (TRIG)

The Trigger Mode function can be used to save and transmit video/audio from SA-DV6000 to your PC by synchronizing to the button operations of BR-DV6000.

1. Set MPEG REC in the NETWORK PACK CONFIG menu to "TRIG" or "SPLIT" using steps 1 ~ 8 of page 10.
  - TRIG: Records/transmits video/audio streaming data to your PC at the same time as the recording to the DV cassette tape set in BR-DV6000.
  - SPLIT: Records/transmits video/audio streaming data to your PC regardless of whether the DV cassette is set.
2. Click the CAPTURE-TRIG./CAST-TRIG. button in the Streamcapture screen.
  - Button lights and the program enters the trigger standby mode.

**Memo**

- When the CAPTURE-TRIG. button is on: Saves the video/audio from SA-DV6000 to your PC by synchronizing to the button operations of BR-DV6000.
- When the CAST-TRIG. button is on: Transmits video/audio from SA-DV6000 to another PC by synchronizing to the button operations of BR-DV6000.
- When saving and transmitting video/audio at the same time, light both CAPTURE-TRIG. and CAST-TRIG. buttons.

3. Turning trigger on
  - When SA-DV6000 is in the TRIG mode: press REC and PLAY of BR-DV6000 at the same time.
  - When SA-DV6000 is in the SPLIT mode: press the SET button of BR-DV6000.
  - Saving of file or transmission will start on the PC.
4. Turning trigger off
  - When SA-DV6000 is in the TRIG mode: press the STOP button of BR-DV6000.
  - When SA-DV6000 is in the SPLIT mode: press the SET button of BR-DV6000.
  - File recording on the PC will end. Furthermore, transmitted video screen will display color bars.

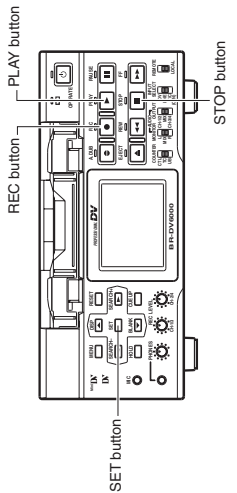
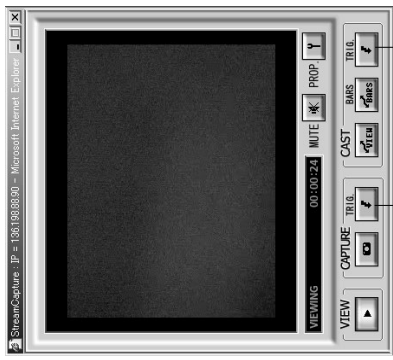
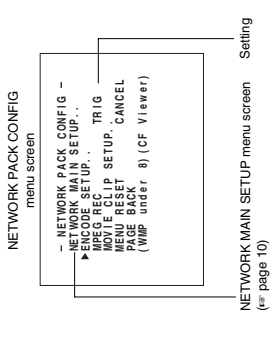

→ OVER

## Network remote control STREAMCAPTURE (Playing back video/audio using a PC and saving to file)

### About the Cast function (CAST)

The Cast function can be used to send video/audio from SA-DV6000 to another PC.

#### <Sending method>

Display the video to send in the video display window of the Streamcapture screen and click the CAST-VIEW button.

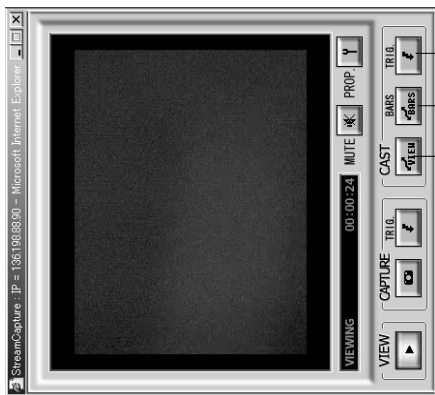

CAST-VIEW button  
CAST-BARS button  
CAST-TRIG button

#### <Color bar transmission>

When clicking the CAST-BARS button, color bars are transmitted rather than the video from SA-DV6000.

- Video of the receiving side will be displayed with color bars. (Video from SA-DV6000 will be displayed in the video display of the Streamcapture screen. Color bars will not be displayed.)
- Click the CAST-VIEW button to switch back to the transmission of video from SA-DV6000.

- To stop the transmission of video from SA-DV6000 / color bars, turn off the CAST-VIEW/CAST-BARS button.
- In this case, the connection with the receiving side will be disconnected.

#### <Trigger transmission>

When transmitting video/audio from SA-DV6000 to another PC by synchronizing to the button operations of BR-DV6000, click the CAST-TRIG. Button. (see page 57)

#### <Receiving sent video>

Video sent using the Cast function can be received using Windows Media Player.

1. Launch Windows Media Player and select (Open URL) from the (File) menu.

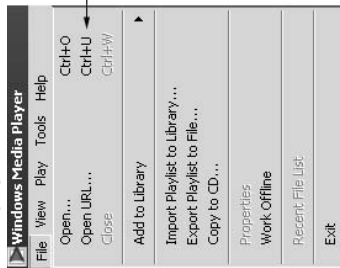

2. Input the IP address and port number of the PC sending data using Streamcapture.

\* The settings can be checked in "Internet URL" of the Cast dialog box. (see page 59)

- Internet connection



- LAN connection

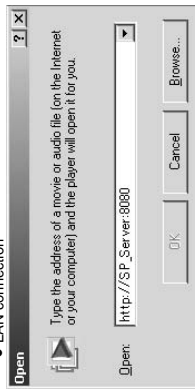

3. Click OK to view the received video.

#### Caution

When Windows Media Player is receiving a video being sent, sometimes the connection with a server can be cut off. In such a case, press the PLAY button of Windows Media Player again.

58

## Network remote control STREAMCAPTURE (Playing back video/audio using a PC and saving to file)

### Various setting dialog boxes

Property dialog box

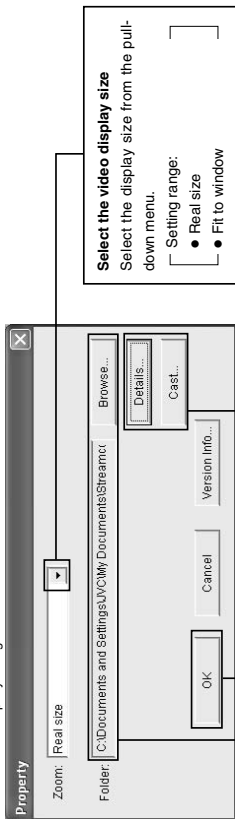

Click the OK button to confirm settings.

#### Select the video display size

Select the display size from the pull-down menu.

- Setting range:
- Real size
- Fit to window

#### Save destination folder

The default save destination is as follows:  
Set this field when changing the save destination folder.

My Document\Streamcorder (IPAddress)  
When changing the destination folder, press the Browse... button and select the desired folder. The changed destination folder will be the default folder for future save operations.

#### Advanced settings dialog box

Change RTSP (for Control Command) port and RTP (for AV Data) port for NetworkPack communication.  
Please confirm correct value to Network Administrator.

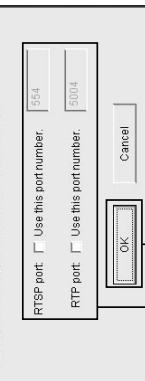

Click the OK button to confirm settings.

#### Cast dialog box

Change HTTP port network broadcast using Streamcapture.  
Please confirm correct value to Network Administrator.

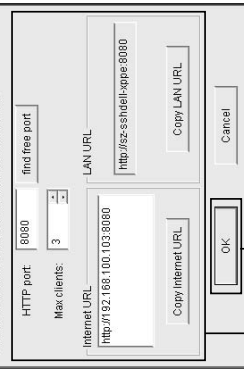

Click the OK button to confirm settings.

#### HTTP port:

Port number of the network used when sending video/audio is set. Normally, no user setting is required.

#### Max clients:

Sent video/audio can be received up to the number specified in this dialog box.

#### Internet/LAN URL:

When receiving video/audio, the URL displayed here is entered in Windows Media Player.

#### Copy Internet URL:

Copies Internet URL to clipboard

#### Copy LAN URL:

Copies LAN URL to clipboard

Port numbers of the network used on the PC side during communication with the network pack are set.  
RTSP port: used for handling commands. Use [TCP].  
RTP port: used for receiving video data. Use [UDP].  
Normally, available ports are automatically searched and set.  
If there are restrictions to the port numbers due to the LAN environment settings of your PC, consult your network administrator.  
When specifying the port numbers for use, check each checkbox and input the number in the edit box on the right.

## Network remote control Transferring clips on a CF memory card to a server

By connecting the LAN terminal of the SA-DV6000 to a network, clips on a CF memory card can be transferred to a server via FTP.

### Caution

Before using this function, it is necessary to set the destination, etc. of the clip using the FTP CLIENT SETUP screen. (See page 50)

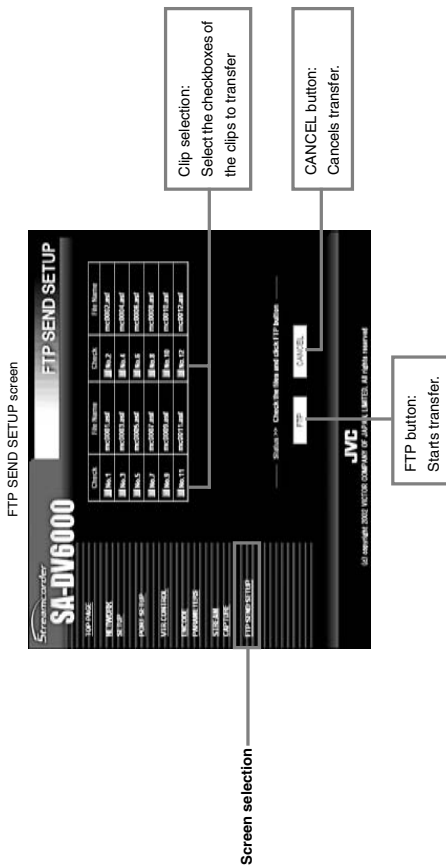

### Preparations

- Insert a pre-recorded CF memory card into the network pack.
- Connect the LAN terminal of the network pack to a network.
- In the FTP CLIENT SETUP screen of the Streamcorder, set the transfer destination of the clips.

### Operating the FTP SEND SETUP screen

1. Click FTP SEND SETUP on the left side of the Streamcorder screen to display the FTP SEND SETUP screen as shown above.
2. Select the clips to transfer.  
Select the checkboxes of the file numbers to transfer. (Multiple selections allowed)
3. Click the FTP button to transfer the selected clips to the server.  
To cancel transfer, click the CANCEL button.

## Others

TOP PAGE can be customized as desired.

TOP PAGE created on a PC is uploaded by FTP.

1. Set the unit so that NETWORK SETUP can be displayed.  
(See page 47)
2. Create HTML on the PC using a commercially available HTML editor, etc.  
Save the created HTML file under the name of "index.html".



3. Use a commercially available FTP program on the PC to upload index.html created in step 2 above to SA-DV6000.

FTP program settings (Execute using the set value.)

IP Address : 192.168.100.101

Remote Port : 21

USER ID : ftp-user

PASSWORD : sa-dv

It is also possible to upload link pages from index.html, images, etc.

### Caution

- Make sure the uploaded files do not exceed 100KB in total.
- The HTML display will fit properly on the screen when creating at a size of about 500 × 360 pixels.
- Once uploaded, the file is overwritten and cannot be reproduced. Download and backup necessary files in the FTP.

## Others

### Connecting Windows Media Player

Connect the SA-DV6000 to Windows Media Player using the network.

1. Set STREAM TYPE in the ENCODE SETUP menu to "for WMP".
2. Open Windows Media Player.

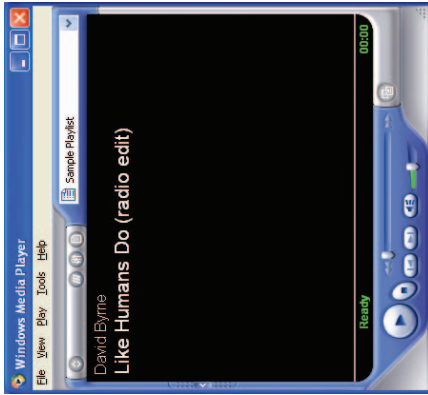

3. Select [File] → [Open URL].

The following dialog box will appear.

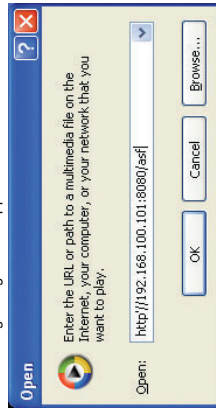

4. Set the IP address of the VTR.

`http://***.***.***.###/asf`

\* → IP address of VTR

# → HTTP Port number set in "for Media Player"

5. When completed with setting, select OK to establish connection.

#### Memo

- If there is a lag between the video and audio, set the sampling frequency of input and the audio mode of BR-DV6000 to match, stop playback on Media Player and try again.
- WMP for Mac OS not supported.
- Use QuickTime Player. (see page 63)

## Others

### Connecting QuickTime Player

Connect the SA-DV6000 to QuickTime Player using the network.

1. Set STREAM TYPE in the ENCODE SETUP menu to "for QT".
2. Open QuickTime Player.



3. Select [File] → [Open URL with New Player].

The following dialog box will appear.

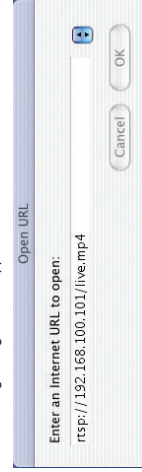

4. Set the IP address of the VTR.

`rtsp://***.***.***/live.mp4`

\* → IP address of VTR

5. When completed with setting, select OK to establish connection.

#### Memo

- When quickly alternating Play and Still operations on QuickTime, a 455 error dialog may appear. In this case, turn off the BR-DV6000 and turn the power back on.
- When repeating Open and Close operations on the QuickTime Player, there may be a lag between the audio and video. In this case, restart QuickTime.
- If there is a lag between the video and audio, set the sampling frequency of input signals and the audio mode of BR-DV6000 to match, close QuickTime and launch again.

## Others

The network pack firmware version can be updated.  
For details concerning version update data, visit the JVC homepage.

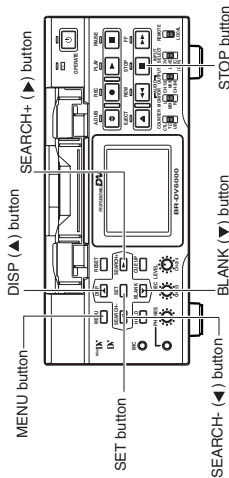

## About updating the network pack

NETWORK PACK CONFIG menu screen

```

NETWORK PACK CONFIG -
▶ NETWORK MAIN SETUP . .
▶ RECORD SETUP . . . TRIG
▶ MOVIE CLIP SETUP . CANCEL
MENU REBSET
PAGE BACK
(WMP under 8) (CF viewer)
TC 00:00:00.00
    
```

UPDATE menu screen

```

UPDATE -----
▶SOFTWARE UPDATE
PAGE BACK CANCEL
W.X.X.XY
2003.XX.XX.XX:XX:XX
INSERT AN UPDATE CF CARD
TC 00:00:00.00
    
```

1. Insert a CF memory card with update data into the slot.
2. Turn on the BR-DV6000 power.
3. Press the MENU button to display the TOP MENU screen.
4. Set the cursor to NETWORK PACK CONFIG and press the SET button while holding the STOP button of the VTR.
  - The NETWORK PACK CONFIG menu screen added with the UPDATE item appears.
5. Press the DISP (▲) or BLANK (▼) button, set the cursor to UPDATE and press the SET button or SEARCH+ (▶) button.
  - The UPDATE menu screen appears.
6. Set the cursor to SOFTWARE UPDATE and press the SET button.
  - CANCEL display will flash and changes will be allowed.
7. Using the DISP (▲) or BLANK (▼) button, set the display to EXECUTE and press the SET button.
  - Update will begin and "UPDATE.." will flash on the screen during the process.
8. When update is completed, the normal screen appears.

### Caution

During update, do not turn the power off or perform menu or VTR operations. Malfunction may occur as a result.

■ UPDATE menu screen contents ● indicates default settings.

Item	Setting	Description
NETWORK UPDATE	● CANCEL EXECUTE	Set EXECUTE and press the SET button to start update.
PAGE BACK		Press the SET button to return to the NETWORK PAC CONFIG menu screen.

## Others

When there is a system error, network error, unit malfunction, etc., SA-DV6000 displays the error on the BR-DV6000 LCD screen.

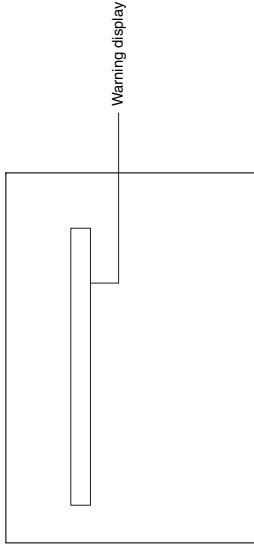

<LCD screen or viewfinder screen>

Screen display	Cause	Remedy	Reference page
<File system related>			
CF REMAIN 60SEC! (Flashing for 3 sec.)	Remaining time became less than 60 seconds during recording to CF memory card.	Stop recording and replace with a new CF memory card, or delete files on the current CF memory card to secure recording space.	33
CF REMAIN 30SEC!	Remaining time became less than 30 seconds during recording to CF memory card.		
CF REMAIN 20SEC!	Remaining time became less than 20 seconds during recording to CF memory card.		
CF REMAIN 10SEC!	Remaining time became less than 10 seconds during recording to CF memory card.		
CF FULL! (Displayed until CF recording stops)	Remaining time has run out during recording to CF memory card.		
CF FULL! (Flashing for 3 sec.)	Recording is being attempted on CF memory card with remaining time of less than 10 seconds.		
FORMAT ERROR!	Failed to format CF memory card.	Check the CF memory card and format again. If the card still cannot be formatted, contact your nearest JVC-authorized service agent.	32
NO CF FORMAT! (Flashing)	CF memory card is unformatted, or an unknown format is being used.	Check the CF memory card and format.	32
TIME CODE ERROR!	Attempted to set the same value for IN POINT and OUT POINT.	Set the OUT POINT at least 5 seconds from IN POINT.	36
IN POINT NOT SET!	IN POINT has not been set.		36
IN/OUT POINT NOT SET!	Both IN POINT and OUT POINT have not been set.		36
CAPTURE STOP!	STOP button was pressed during capturing.		
WAIT A MINUTE, PLEASE!	Clips on the CF card are being transferred to a server.	Wait until the display disappears.	45 46
FILE NO REGISTRATION!	File to transfer has not been selected.		46
FILE SEND ERROR!	File transfer was unsuccessful.	Check the FTP CLIENT SETUP setting or the used network environment.	45 46
ACTION ESCAPE!!	Operation was canceled.		36
CUE UP REC	Specified range of the DV tape is being recorded.		36

→ OVER



## Others

### Troubleshooting

Screen display	Cause	Remedy	Reference page
<Operation related>			
NO CF CARD! (Flashing for 3 sec.)	There is no CF memory card inserted.	Insert a CF memory card.	4
PROTECT! (Flashing for 3 sec.)	Deletion of a protected clip file was attempted.	To delete the clip file, remove the protection.	42
NO CLIP! (Flashing for 3 sec.)	There is no CF memory card inserted, or there is no clip file available.	Check the CF memory card.	—
SET WLAN AD HOC MODE OFF! (Flashing for 3 sec.)	Use of DHCP server was attempted while in the AD HOC mode.	Set DHCP in the NETWORK SET menu mode.	12
SET DHCP OFF! (Flashing for 3 sec.)	Selection of AD HOC mode was attempted while using DHCP server.	Set WLAN AD HOC MODE in the NETWORK SET menu screen to OFF when using DHCP server.	12
OVERLAP HTTP! (Flashing for 3 sec.)	Port set for HTTP for WEB Browser is already in use.	Set an unused port.	13, 52
OVERLAP ASF_HTTP! (Flashing for 3 sec.)	Port set for HTTP for Media Player is already in use.	Set an unused port.	13, 52
OVERLAP ASF-RTSP! (Flashing for 3 sec.)	Set port for RTSP for Streamproducer is already in use by another port.	Set an unused port.	13, 52
OVERLAP QT-RTSP! (Flashing for 3 sec.)	Set port for RTSP for Quick time is already in use by another port.	Set an unused port.	13, 52
ILLEGAL SETTING! (Flashing for 3 sec.)	Set value exceeded setting range.	Set a value within the setting range.	12
DATA LENGTH 10 or 26 (Flashing for 3 sec.)	Setting made with other than 10 or 26 characters.	Set using 10 or 26 characters.	13
CHARACTER IS SHORT! (Flashing for 3 sec.)	Set number of characters is 2 or less / 3 or less.	Set using 3 or more / 4 or more characters.	14
SET LEAP MODE OFF! (Flashing for 3 sec.)	Attempted to use LEAP while in the ADHOC mode.	Set LEAP to OFF when in the ADHOC mode.	14
SAME OLD PASSWORD! (Flashing for 3 sec.)	The new password is the same as the old password.	Set a password different from the old password.	14
GARBAGE! (Flashing display while optimizing)	Optimization of internal ROM disk currently being processed.	Please wait until process is completed.	—
IP ADDRESS ERROR! (Flashing display until network connection is established)	Failed to acquire IP address when DHCP is ON.	Set DHCP again.	12
NO UPDATE FILES! (Flashing for 3 sec.)	There is no update data in the CF memory card.	Insert a CF memory card with UPDATE data into the slot.	64
NO UPDATE CARD! (Flashing for 3 sec.)	CF memory card is not inserted.	Insert a CF memory card with UPDATE data into the slot.	64
UPDATE FAILED!	Update was not successful.	Contact your JVC dealer.	64
COPY GUARD!	Signal of recording origin is protected with copy guard.	Input recording signal with no copy guard protection.	—

### Memo

If the input signal is switched during transmission or CF recording, the video may flicker. However, the video will return to normal after a certain time. (The time will differ depending on the selected encoding parameter.)

## Others

### Checking communication/connection

By using the PING command standard to Windows, it is possible to check whether the connection is correct and that communication can be made from the PC to SA-DV6000.

1. Launch the command prompt.
  - For Windows 2000  
From the Start button, select [Programs] → [Accessories] → [Command Prompt].
2. Input the following and press the Enter key.  
PING xxx.xxx.xxx.xxx (xxx.xxx.xxx.xxx is the IP address of the other party)  
Input example: When the IP address of the other party is "192.168.0.10"  
PING 192.168.0.10
3. Check to see that the other party is successfully displayed.  
If connection is not successful, "Request timed out" or "Destination host unreachable" message will appear.

## Others

## Terminology

- **IP address**  
Identification number assigned to each computer that is connected to a network. The address is used for communication between network devices.
- **LAN (Local Area Network)**  
A network structured within a relatively small range such as in a single building or an office of a company.
- **DHCP (Dynamic Host Control Protocol)**  
Method of automatically assigning IP address within a network. When a computer is connected to a network, the DHCP server automatically assigns the IP address.
- **WAN (Wide Area Network)**  
A network structured within a wide area such as between the main office of a company and its branch offices. Internet is also generally referred to as WAN.
- **Netmask**  
An IP address has the following two roles: 1) address for identifying the network, and 2) address for identifying individual computers. Netmask is a 32-bit value that defines the number of bits of the IP address to use for identifying the network.
- **Gateway**  
Hardware and software that translates different types of protocols when a computer communicates with another computer outside the network. The gateway IP address is referred to as the gateway address.
- **RTP (Realtime Transport Protocol)**  
Protocol to transmit in realtime digitalized video/audio data via a network.
- **RTSP (Real Time Streaming Protocol)**  
Protocol to control realtime transmission of video/audio data via a network.
- **HTTP (Hypertext Transport Protocol)**  
Protocol used when transferring HTML (Hypertext Markup Language) files between WWW server and browser.
- **Protocol**  
A set rule for a computer or communication device to perform communication over a network, etc.
- **IEEE802.11b**  
International standard for wireless LAN with maximum communication speed of 11Mbps.
- **Channel (wireless LAN)**  
Frequency range used by wireless LAN. The same frequency must be set by two sides for proper communication. If there is an access point, adapter, etc., using the same band in the proximity, there may be a hindrance in the communication and may reduce throughput or the quality of communication. When setting, check the settings of surrounding access points, etc., to avoid doubling.
- **ESS-ID (wireless LAN)**  
Network identification name used by wireless LAN. The name is used to distinguish other wireless LAN devices.
- **Ad hoc mode (wireless LAN)**  
A mode for direct communication without passing through an access point.
- **Infrastrucure (wireless LAN)**  
Form of communication via an access point.

## Others

## Terminology

- **Encryption mode**  
Setting for encrypting the flow of data during wireless communication. Following settings are available:  
None (Open System): No encryption. Setting will be unavailable and throughput will be improved. However, there is the risk of information leakage.  
40bit WEP: Encryption is performed using 40-bit encryption key.  
128bit: Encryption is performed using 104-bit + 24-bit (1V) keys. Although throughput will decline compared to Open System, security of data will be improved.
- **Access point (wireless LAN)**  
Relay point for infrastructure communication. It can also serve as the relay point for cable LAN or wireless LAN.
- **ASF (Advanced Streaming Format)**  
Data streaming format developed by Microsoft Corporation (U.S.) for transmission of video and audio.
- **Host name**  
Name of a device (not limited to a computer but all connection devices with an IP address) on a network.
- **Port number**  
Number used for detecting applications and service during TCP/IP communication.
- **TCP/IP**  
Abbreviation for Transmission Control Protocol/Internet Protocol and is one of the protocols used during network connection.
- **UDP**  
Different from TCP, UDP is a low-level protocol that does not perform receive checks. In some cases, missing and distorted images may occur due to packet loss.

## Others

### About IP address/proxy server

#### ■ About IP address

#### Global IP address and local IP address

There are 2 types of IP addresses: "global IP address" and "local IP address".

**Global IP address:** Just as different IP addresses are needed on a network, all PCs using the Internet worldwide must use a unique IP address. This IP address is referred to as "global IP address".

Normally, the global address is assigned by the IS provider.

**Local IP address:** In an environment not connected to the Internet (within a household, within a company, etc.), separate IP addresses can be used freely within a network.

This IP address is referred to as "local IP address".

#### IP address classes

IP addresses are categorized into 3 classes depending on the number of PCs structuring a network.

"Class A IP addresses" are used for large-scale networks. "Class B IP addresses" are used for medium-scale networks and "Class C IP addresses" are used for small-scale networks.

Within a network, all IP addresses must be of the same class. Each IP address is structured by a series of 4 digit numbers separated by a period. The first number of the IP address indicates the class.

Class indicated here  
xxx.xxx.xxx.xxx

IP address

First number of the IP address	Class	Application (number of PCs structuring the network)
1-127	Class A	For large-scale networks (max. approx. 16 million units)
128-191	Class B	For medium-scale networks (max. approx. 65,000 units)
192-223	Class C	For small-scale networks (max. approx. 120 units)

\* "224 - 255" are normally not used for IP addresses.

For example, a network structured by a few PCs to dozens of PCs would use Class C IP addresses.

Normally, the following special IP addresses are used when structuring a network.

Class	Set IP address
Class A	10.0.0.0 - 10.255.255.255
Class B	172.16.0.0 - 172.31.255.255
Class C	192.168.0.0 - 192.168.255.255

#### About proxy server

A proxy is a "relay point" for accessing the Internet. When enabling "Use a proxy server", the proxy server will make access to the Internet.

Since various access information is cached at this time, downloading will be faster when reloading the same information from the Internet since the data is loaded from the proxy server.

## Free Manuals Download Website

<http://myh66.com>

<http://usermanuals.us>

<http://www.somanuals.com>

<http://www.4manuals.cc>

<http://www.manual-lib.com>

<http://www.404manual.com>

<http://www.luxmanual.com>

<http://aubethermostatmanual.com>

Golf course search by state

<http://golfingnear.com>

Email search by domain

<http://emailbydomain.com>

Auto manuals search

<http://auto.somanuals.com>

TV manuals search

<http://tv.somanuals.com>