

# JVC



## CD PORTABLE COMPONENT SYSTEM

# PC-X290

Consists of CA-PCX290 and SP-PCX290

COMPACT  
**disc**  
DIGITAL AUDIO

SP-PCX290

CA-PCX290

SP-PCX290

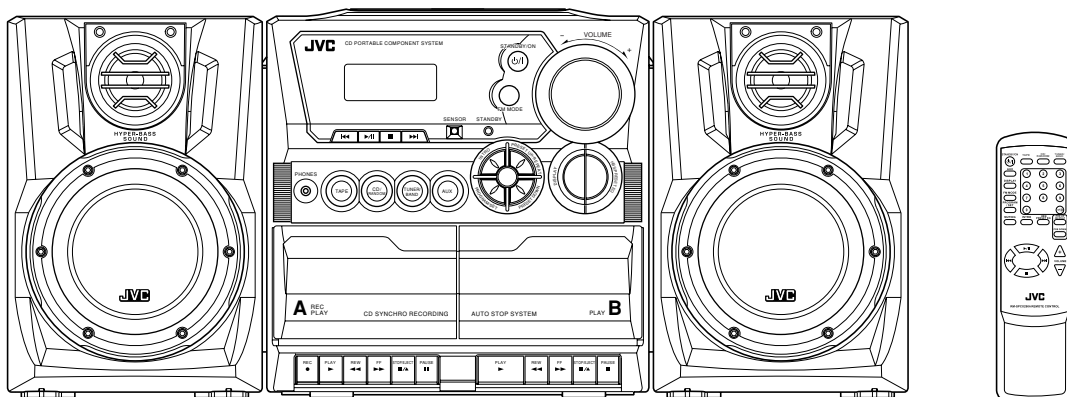

## INSTRUCTIONS

LVT1189-001A  
[B]

# Warnings, Cautions and Others

## IMPORTANT for the U.K.

**DO NOT** cut off the mains plug from this equipment. If the plug fitted is not suitable for the power points in your home or the cable is too short to reach a power point, then obtain an appropriate safety approved extension lead or consult your dealer.

**BE SURE** to replace the fuse only with an identical approved type, as originally fitted.

If nonetheless the mains plug is cut off ensure to remove the fuse and dispose of the plug immediately, to avoid a possible shock hazard by inadvertent connection to the mains supply.

If this product is not supplied fitted with a mains plug then follow the instructions given below:

### IMPORTANT:

**DO NOT** make any connection to the terminal which is marked with the letter E or by the safety earth symbol or coloured green or green-and-yellow.

The wires in the mains lead on this product are coloured in accordance with the following code:

Blue : Neutral  
Brown : Live

As these colours may not correspond with the coloured markings identifying the terminals in your plug proceed as follows:

The wire which is coloured blue must be connected to the terminal which is marked with the letter N or coloured black.

The wire which is coloured brown must be connected to the terminal which is marked with the letter L or coloured red.

**IF IN DOUBT - CONSULT A COMPETENT ELECTRICIAN.**

## CAUTION—STANDBY/ON $\odot$ /I button!

Disconnect the mains plug to shut the power off completely (all lamps and indications go off). The STANDBY/ON  $\odot$ /I button in any position does not disconnect the mains line.

- When the unit is on standby, the STANDBY lamp lights red.
- When the unit is turned on, the STANDBY lamp goes off.

The power can be remote controlled.

## CAUTION

To reduce the risk of electrical shocks, fire, etc.:

1. Do not remove screws, covers or cabinet.
2. Do not expose this appliance to rain or moisture.

## IMPORTANT FOR LASER PRODUCTS

1. CLASS 1 LASER PRODUCT
2. **CAUTION:** Do not open the top cover. There are no user serviceable parts inside the unit; leave all servicing to qualified service personnel.
3. **CAUTION:** Visible and invisible laser radiation when open and interlock failed or defeated. Avoid direct exposure to beam.
4. REPRODUCTION OF LABEL: CAUTION LABEL, PLACED INSIDE THE UNIT.

**CAUTION -** INVISIBLE LASER RADIATION WHEN OPEN AND INTERLOCKS DEFEATED. AVOID EXPOSURE TO BEAM.  
**VORSICHT !** UNSICHTBARE LASERSTRAHLUNG TRITTS AUS. WENN DECKEL, GEÖFFNET UND WENN SICHERHEITSVERRIEGELUNG ÜBERBRÜCKT IST. NICHT DEM STRAHL AUSSETZEN!  
**WARNING -** OSYNLIG LASERSTRÅLNING NÄR DENNA DEL ÄR ÖPPNAD OCH SPÄRR ÄR URKÖPPLAD STRÅLEN ÄR FARLIG.  
**ADVARSEL -** USYNLIG LASERSTRÅLNING VED ÅBNING NÄR SIKKERHEDSAFBRYDERE ER UDE AF FUNKTION. UNDGÅ UDSÆTTELSE FOR STRÅLING.

## CAUTION

- Do not block the ventilation openings or holes. (If the ventilation openings or holes are blocked by a newspaper or cloth, etc., the heat may not be able to get out.)
- Do not place any naked flame sources, such as lighted candles, on the apparatus.
- When discarding batteries, environmental problems must be considered and local rules or laws governing the disposal of these batteries must be followed strictly.
- Do not expose this apparatus to rain, moisture, dripping or splashing and that no objects filled with liquids, such as vases, shall be placed on the apparatus.

## Caution: Proper Ventilation

To avoid risk of electric shock and fire, and to prevent damage, locate the apparatus as follows:

### 1 Front:

No obstructions and open spacing.

### 2 Sides/ Top/ Back:

No obstructions should be placed in the areas shown by the dimensions below.

### 3 Bottom:

Place on the level surface. Maintain an adequate air path for ventilation by placing on a stand with a height of 10 cm or more.

### Front view

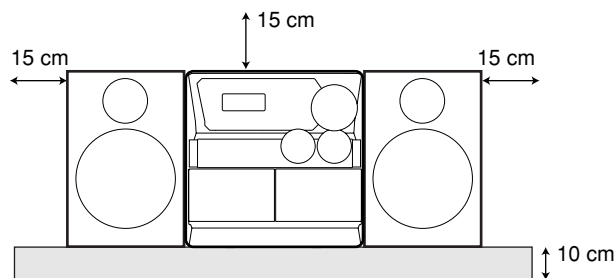

PC-X290

### Side view

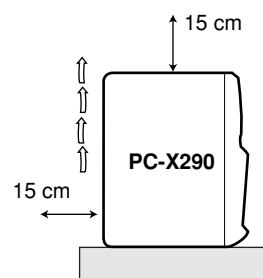

## **SAFETY INSTRUCTIONS**

### **“SOME DOS AND DON'TS ON THE SAFE USE OF EQUIPMENT”**

This equipment has been designed and manufactured to meet international safety standards but, like any electrical equipment, care must be taken if you are to obtain the best results and safety is to be assured.

\*\*\*\*\*

Do read the operating instructions before you attempt to use the equipment.

Do ensure that all electrical connections (including the mains plug, extension leads and interconnections between pieces of equipment) are properly made and in accordance with the manufacturer's instructions. Switch off and withdraw the mains plug when making or changing connections.

Do consult your dealer if you are ever in doubt about the installation, operation or safety of your equipment.

Do be careful with glass panels or doors on equipment.

\*\*\*\*\*

DON'T continue to operate the equipment if you are in any doubt about it working normally, or if it is damaged in any way—switch off, withdraw the mains plug and consult your dealer.

DON'T remove any fixed cover as this may expose dangerous voltages.

DON'T leave equipment switched on when it is unattended unless it is specifically stated that it is designed for unattended operation or has a standby mode.

Switch off using the switch on the equipment and make sure that your family know how to do this. Special arrangements may need to be made for infirm or handicapped people.

DON'T use equipment such as personal stereos or radios so that you are distracted from the requirements of traffic safety. It is illegal to watch television whilst driving.

DON'T listen to headphones at high volume as such use can permanently damage your hearing.

DON'T obstruct the ventilation of the equipment, for example with curtains or soft furnishings.

Overheating will cause damage and shorten the life of the equipment.

DON'T use makeshift stands and NEVER fix legs with wood screws — to ensure complete safety always fit the manufacturer's approved stand or legs with the fixings provided according to the instructions.

DON'T allow electrical equipment to be exposed to rain or moisture.

ABOVE ALL

- NEVER let anyone, especially children, push anything into holes, slots or any other opening in the case—this could result in a fatal electrical shock.;
- NEVER guess or take chances with electrical equipment of any kind
- it is better to be safe than sorry!

# Introduction

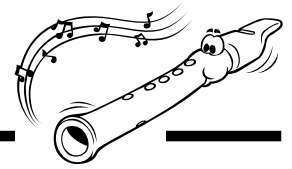

We would like to thank you for purchasing one of our JVC products. Before operating this unit, read this manual carefully and thoroughly to obtain the best possible performance from your unit, and retain this manual for future reference.

## About This Manual

This manual is organized as follows:

- The manual mainly explains operations using the buttons and controls on the unit. You can also use the buttons on the remote control if they have the same or similar names (or marks) as those on the unit. If operation using the remote control is different from that using the unit, it is then explained.
- Basic and common information that is the same for many functions is grouped in one place, and is not repeated in each procedure. For instance, we do not repeat the information about turning on/off the unit, setting the volume, changing the sound effects, and others, which are explained in the section “Common Operations” on pages 9 to 11.
- The following marks are used in this manual:



Gives you warnings and cautions to prevent damage or risk of fire/electric shock. Also gives you information which is not good for obtaining the best possible performance from the unit.



Gives you information and hints you had better know.

## Precautions

### Installation

- Install in a place which is level, dry and neither too hot nor too cold—between 5°C and 35°C.
- Install the unit in a location with adequate ventilation to prevent internal heat built-up in the unit.
- Leave sufficient distance between the unit and the TV.
- Keep the speakers away from the TV to avoid interference with TV.



DO NOT install the unit in a location near heat sources, or in a place subject to direct sunlight, excessive dust or vibration.

### Power sources

- When unplugging from the wall outlet, always pull the plug, not the AC power cord.



DO NOT handle the AC power cord with wet hands.

### Moisture condensation

Moisture may condense on the lens inside the unit in the following cases:

- After starting heating in the room
  - In a damp room
  - If the unit is brought directly from a cold to a warm place
- Should this occur, the unit may malfunction. In this case, leave the unit turned on for a few hours until the moisture evaporates, unplug the AC power cord, and then plug it in again.

### Others

- Should any metallic object or liquid fall into the unit, unplug the unit and consult your dealer before operating any further.
- If you are not going to operate the unit for an extended period of time, unplug the AC power cord from the wall outlet.



DO NOT disassemble the unit since there are no user serviceable parts inside.

If anything goes wrong, unplug the AC power cord and consult your dealer.

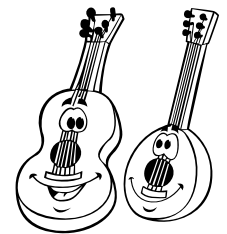

<b>Location of the Buttons and Controls .....</b>	<b>3</b>
Front Panel .....	3
Remote Control .....	5
<b>Getting Started .....</b>	<b>6</b>
Unpacking .....	6
Putting the Batteries into the Remote Control .....	6
Connecting the Speakers .....	6
Connecting Other Equipment .....	7
Power Supply .....	8
<b>Common Operations .....</b>	<b>9</b>
Turning On or Off the Power .....	9
Setting the Clock .....	9
Selecting the Sources .....	9
Adjusting the Volume .....	10
Reinforcing the Bass Sound .....	10
Selecting the Sound Modes .....	10
Ensuring Good FM and AM Reception .....	11
<b>Listening to FM and AM Broadcasts .....</b>	<b>12</b>
Tuning in a Station .....	12
Presetting Stations .....	12
Tuning in a Preset Station .....	12
<b>Playing Back CD .....</b>	<b>13</b>
Loading CD .....	13
Playing Back the Entire Disc .....	13
Basic CD Operations .....	13
Programming the Playing Order of the Tracks	
—Program Play .....	14
Playing at Random—Random Play .....	15
Repeating Tracks or CD—Repeat Play .....	15
Playing Introductions—Intro Play .....	15
<b>Playing Back Tapes .....</b>	<b>16</b>
Playing Back a Tape .....	16
<b>Recording .....</b>	<b>17</b>
Recording onto a Tape on Deck A .....	17
Dubbing Tapes .....	18
Recording Disc—Disc Synchronized Recording .....	18
<b>Maintenance .....</b>	<b>19</b>
<b>Troubleshooting .....</b>	<b>20</b>
<b>Specifications .....</b>	<b>20</b>

# Location of the Buttons and Controls

Become familiar with the buttons and controls on your unit.

## Front Panel

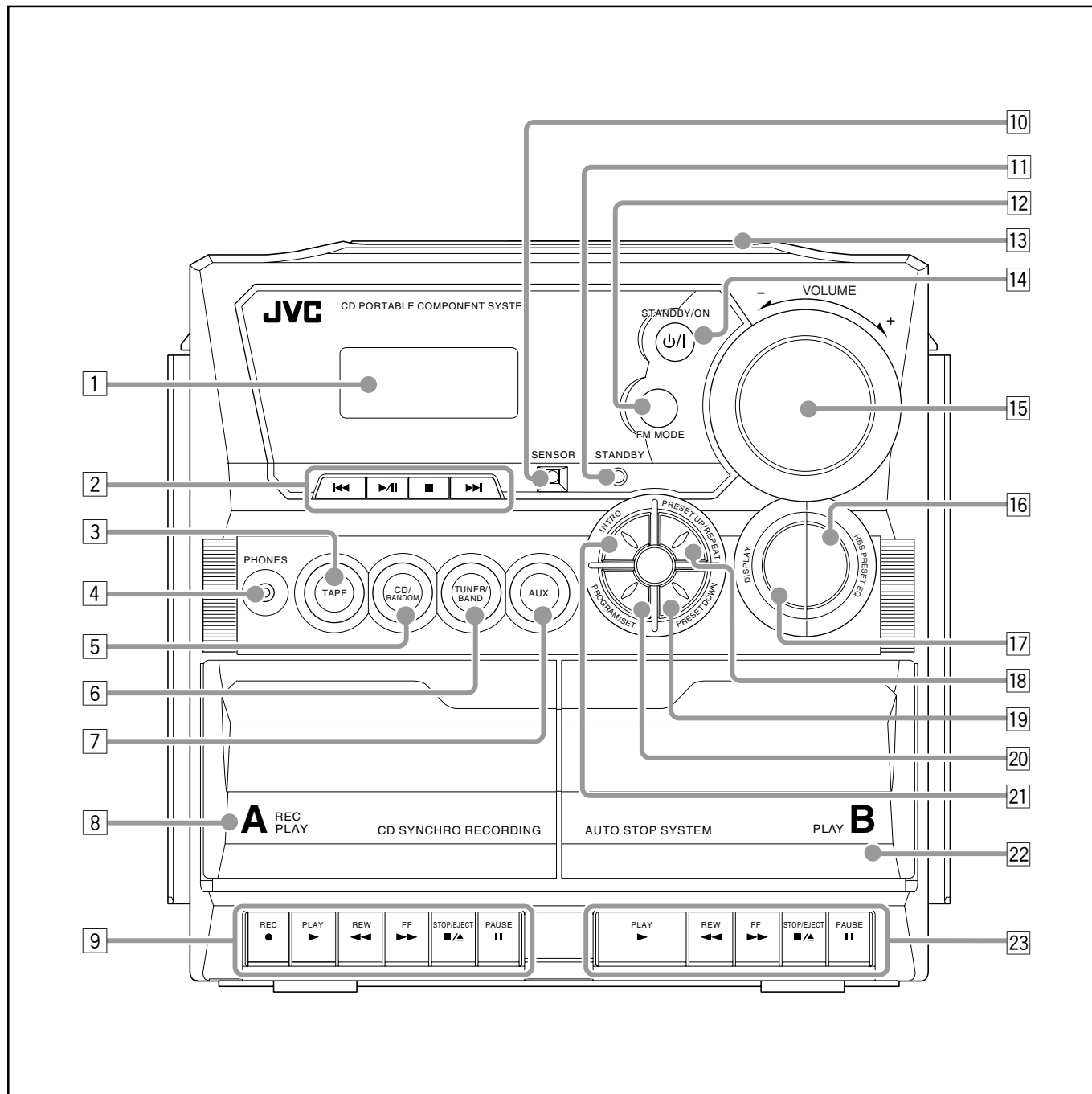

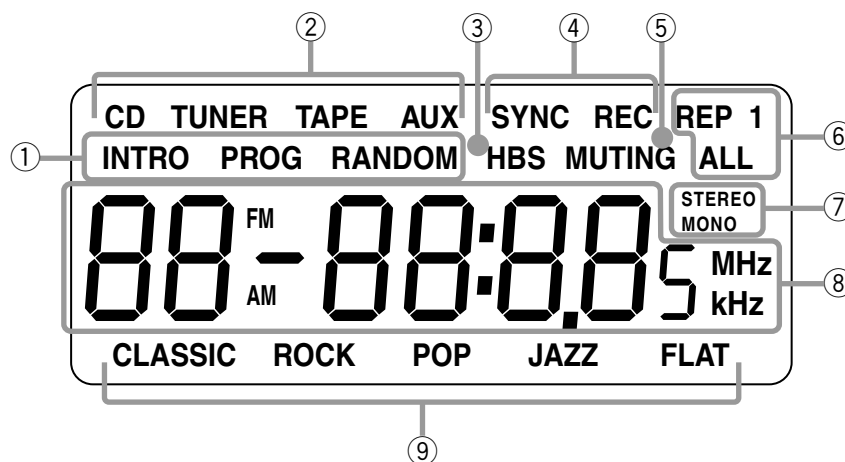
**Display Window**

See pages in the parentheses for details.

**Front Panel**

- 1 Display window
- 2 Operation buttons
  - ◀◀ (9, 12 – 14), ▶/|| (play/pause) (13 – 15), ■ (13 – 15), ▶▶ (9, 12 – 15)
- 3 TAPE button (9, 16, 18)
- 4 PHONES jack (10)
- 5 CD/RANDOM button (9, 13, 15, 18)
- 6 TUNER/BAND button (9, 12)
- 7 AUX button (9)
- 8 Deck A cassette holder (16)
- 9 Operation buttons for deck A (16 – 18)
  - REC ●, PLAY ▶, REW ◀◀, FF ▶▶, STOP/EJECT ■/▲, PAUSE ||
- 10 SENSOR (Remote sensor)
- 11 STANDBY lamp (9)
- 12 FM MODE button (12)
- 13 ▲ OPEN (CD door open/close) (13)
- 14 STANDBY/ON Ⓞ/I button (9)
- 15 VOLUME +/- control (10)
- 16 HBS/PRESET EQ (Equalizer) button (10)
- 17 DISPLAY button (9)
- 18 PRESET UP/REPEAT button (12, 15)
- 19 PRESET DOWN button (12)
- 20 PROGRAM/SET button (9, 12, 14)
- 21 INTRO button (15)
- 22 Deck B cassette holder (16)
- 23 Operation buttons for deck B (16)
  - PLAY ▶, REW ◀◀, FF ▶▶, STOP/EJECT ■/▲, PAUSE ||

**Display Window**

- 1 CD play mode indicators (14, 15)
  - INTRO, PROG, RANDOM
- 2 Source indicators (9)
  - CD, TUNER, TAPE, AUX
- 3 HBS (Hyper Bass Sound) indicator (10)
- 4 SYNC REC indicator (18)
- 5 MUTING indicator (10)
- 6 Repeat mode indicators (15)
  - REP 1/ALL
- 7 Tuner operation indicators (12)
  - STEREO, MONO
- 8 Main display
- 9 Equalizer pattern indicators (10)
  - CLASSIC, ROCK, POP, JAZZ, FLAT



## Remote Control

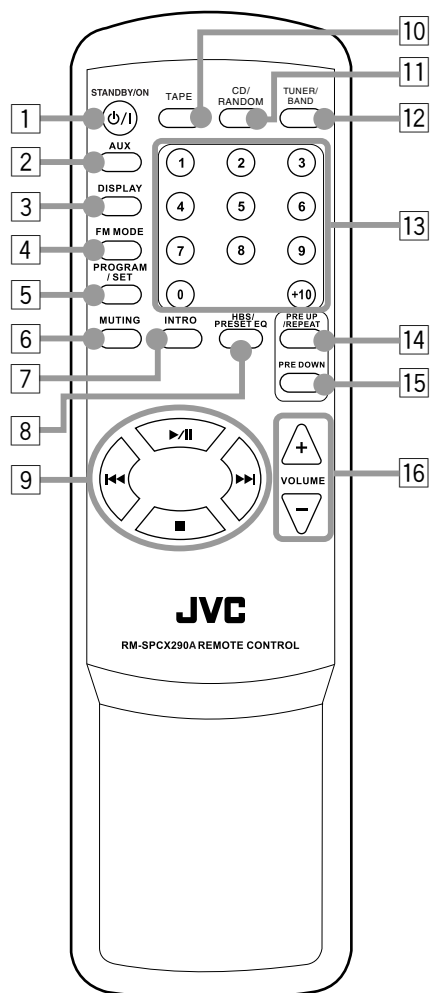

## Remote Control

- 1 STANDBY/ON  $\phi$ /I button (9)
- 2 AUX button (9)
- 3 DISPLAY button (9)
- 4 FM MODE button (12)
- 5 PROGRAM/SET button (9, 12, 14)
- 6 MUTING button (10)
- 7 INTRO button (15)
- 8 HBS (Hyper Bass Sound)/PRESET EQ (Equalizer) button (10)
- 9  $\lll$ / $\lll$ / $\lll$ / $\lll$ / $\lll$ / $\lll$  buttons (12 – 15)
- 10 TAPE button (9, 16, 18)
- 11 CD/RANDOM button (9, 13, 15, 18)
- 12 TUNER/BAND button (9, 12)
- 13 Number buttons (12 – 14)
- 14 PRE UP/REPEAT button (12, 15)
- 15 PRE DOWN button (12)
- 16 VOLUME +/- buttons (10)

Remote sensor

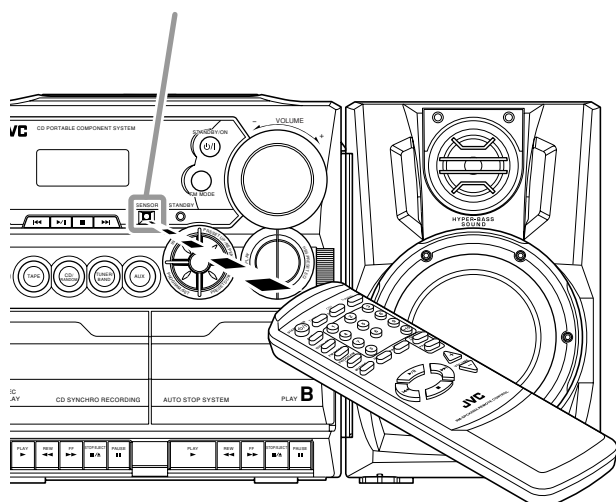

When using the remote control, point it at the remote sensor on the front panel.



## Unpacking

After unpacking, check to be sure that you have all the following items.

The number in the parentheses indicates the quantity of the pieces supplied.

- Remote control (1)
- AC power cord (1)
- Battery (R03(UM-4)/AAA(24F)) (2)

If any is missing, consult your dealer immediately.

## Putting the Batteries into the Remote Control

Insert the batteries—R03(UM-4)/AAA(24F)—into the remote control, by matching the polarity (+ and –) on the batteries with the + and – markings on the battery compartment.

When the remote control can no longer operate the unit, replace both batteries at the same time.

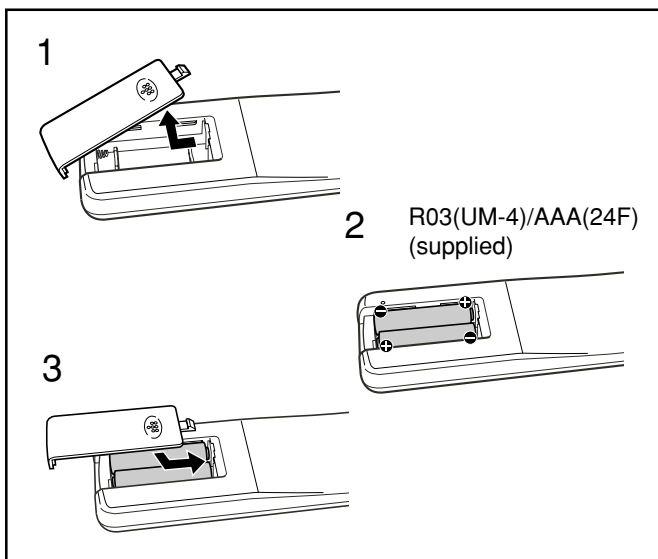

- DO NOT use an old battery together with a new one.
- DO NOT use different types of batteries together.
- DO NOT expose batteries to heat or flame.
- DO NOT leave the batteries in the battery compartment when you are not going to use the remote control for an extended period of time. Otherwise, it will be damaged from battery leakage.

## Connecting the Speakers

### To connect speakers

You can connect the speakers using the speaker cords.

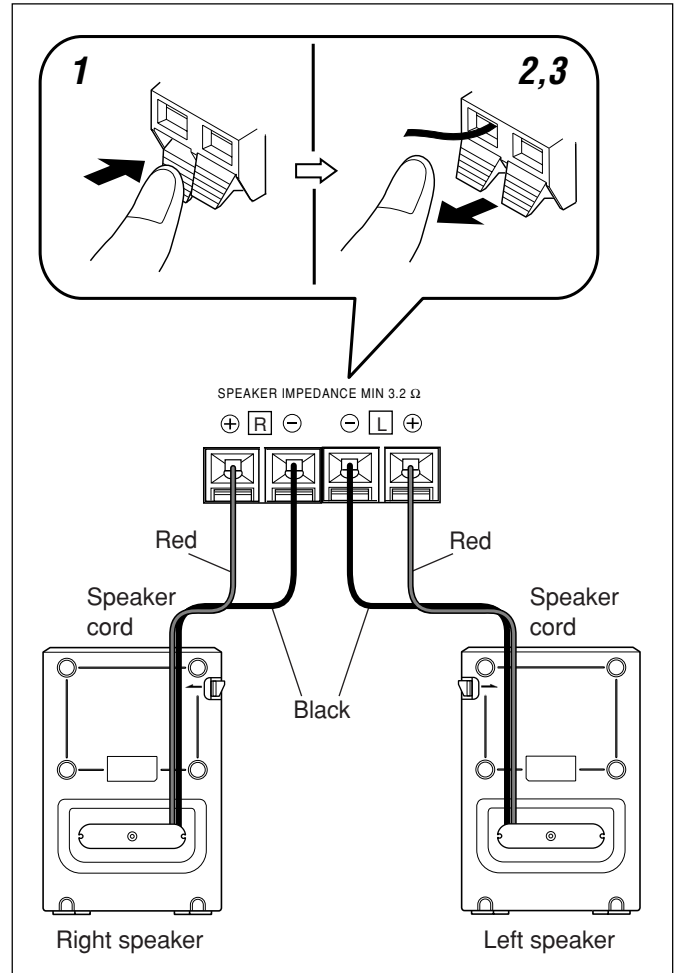

**1 Hold the clamp of the speaker terminal.**

**2 Insert the end of the speaker cord into the terminal.**

Match the polarity of the speaker terminals: red (⊕) to red (⊕) and black (⊖) to black (⊖).

**3 Release the finger from the clamp.**

### IMPORTANT:

- Use only speakers with the same speaker impedance as indicated by the speaker terminals on the rear of the unit.
- DO NOT connect more than one speaker to one speaker terminal.

## Attaching the speaker system to the main unit

Fit the speaker into the grooves on the main unit (①) and slide down the speaker vertically (②) as the illustration shows.

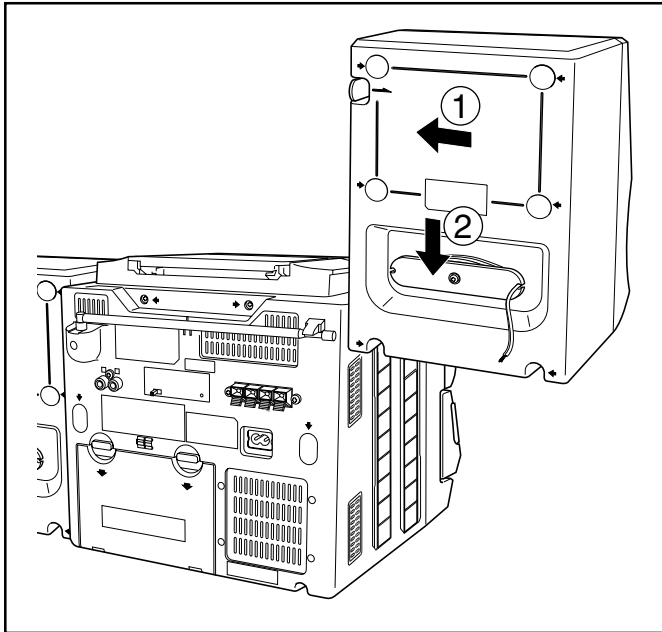

## Detaching the speaker system from the main unit

With the lever on the back of the unit pushed in the direction of the arrow (①), lift up the speaker vertically (②) as the illustration shows.

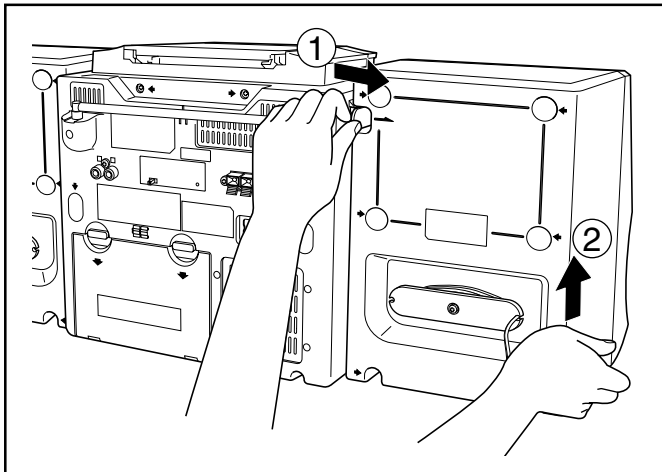

## Connecting Other Equipment

You can connect an audio equipment as a playback device. When you connect and use this equipment, refer also to its manual.



- DO NOT connect any equipment while the power is on.
- DO NOT plug in any equipment until all connections are complete.

Be sure that the plugs of the audio cords are color coded: White plugs and jacks are for left audio signals, and red ones for right audio signals.

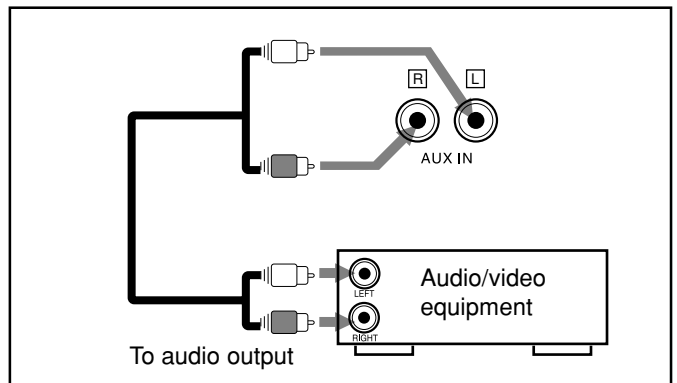

**For playing the other equipment through this unit,** connect between the audio output jacks on the other equipment and AUX IN jacks by using audio cords (not supplied).



## Power Supply

Use AC power or dry batteries (not supplied) to operate the unit.

- As long as the AC power cord is connected to a power source, the unit operates on AC power rather than on the batteries in it.

### To connect the AC power cord

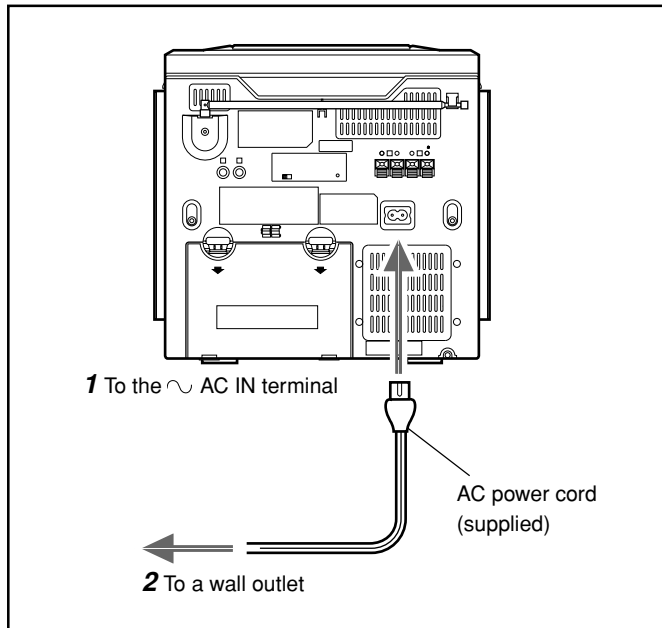

### To insert the batteries

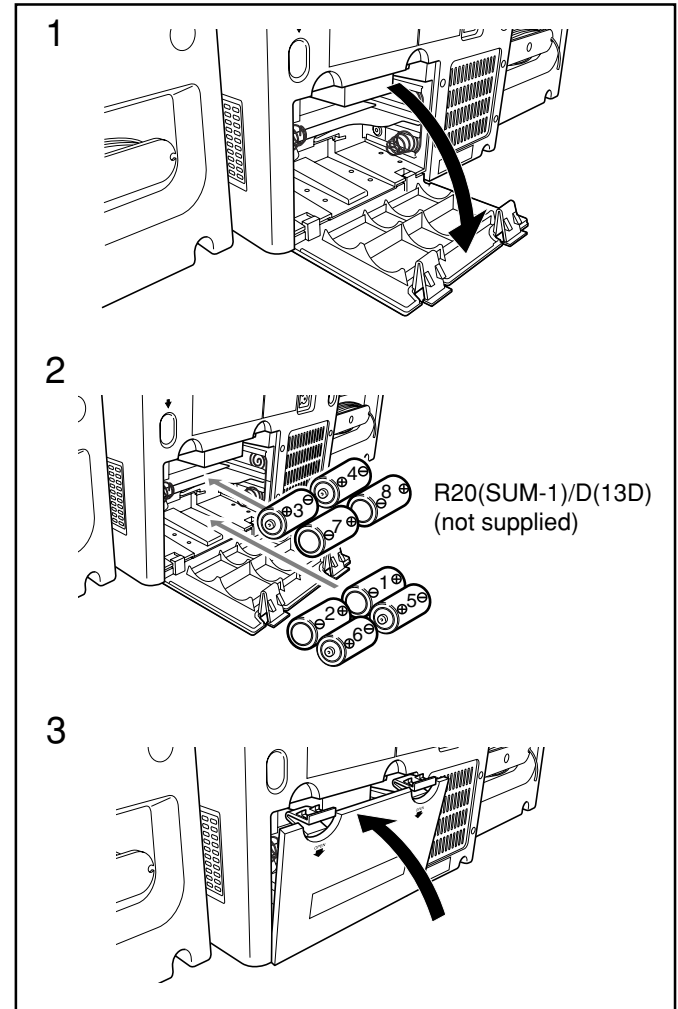

- DO NOT use an old battery together with a new one.
- DO NOT use different types of batteries together.
- DO NOT expose batteries to heat or flame.
- DO NOT leave the batteries in the battery compartment when you are not going to use the unit for an extended period of time. Otherwise, it will be damaged from battery leakage.



Remove batteries when storing this unit over one month.

# Common Operations

## Turning On or Off the Power

To turn on the unit, press STANDBY/ON .

- When you use the batteries for power supply, the backlight of the display dims to save power consumption.



To turn off the unit (on standby), press STANDBY/ON  again.

The STANDBY lamp on the unit lights red.

A little power is always consumed even while the unit is on standby.

To switch off the power supply completely, unplug the AC power cord from the AC outlet. If the batteries are inserted in the unit, take them out.



**When you unplug the AC power cord or if a power failure occurs**

The clock is reset to "0:00" right away, while the tuner preset stations (see page 12) will be erased in a few days. If the batteries are inserted in the unit, this has no effect on the memory.

## Setting the Clock

Before operating the unit any further, first set the clock built in this unit.

- When the unit is turned on with CD or tuner selected, press DISPLAY first to show the clock indication.

### 1 Press and hold PROGRAM/SET for more than 2 seconds.

The hour digits start flashing on the display.



### 2 Press or to adjust the hour, then press PROGRAM/SET.

The minute digits start flashing on the display.

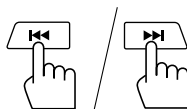

### 3 Press or to adjust the minute, then press PROGRAM/SET.

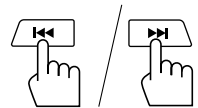

#### If there is a power failure

The clock loses the setting and is reset to "0:00." You need to set the clock again. If the batteries are inserted in the unit, this has no effect on the memory.



#### To show the clock when CD or tuner is selected

Press DISPLAY.

- Each time you press the button, the display changes the clock indication and the normal indication alternately. (Operating the unit while clock indication is displayed change the display to the normal indication.)

## Selecting the Sources

To select the FM/AM broadcasts, press TUNER/BAND.

To select CD, press CD/RANDOM then press /II. (See pages 13 – 15.)

To select tapes, press TAPE then press PLAY  for the deck you want. (See page 16.)

To select the external equipment as the source, press AUX.

The source indicator for the selected source appears on the display.

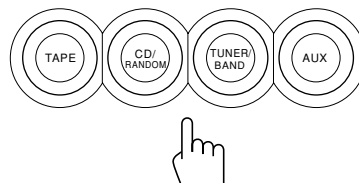

## Adjusting the Volume

You can adjust the volume level only while the unit is turned on.

Turn the **VOLUME +/-** clockwise to increase the volume or counterclockwise to decrease it.

- The volume level can be adjusted in 31 steps (00 VOL to 30 VOL).

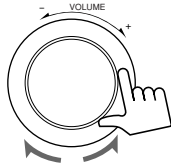

15 VOL

When using the remote control, press **VOLUME +** to increase the volume or press **VOLUME -** to decrease it.

To turn off the sound temporarily

**On the remote control ONLY:**

Press **MUTING**.

The sound is turned off and the **MUTING** indicator appears on the display.

To restore the sound, press **MUTING** again.

The **MUTING** indicator goes off.

- Adjusting the volume level also cancels the muting.



### For private listening

Connect a pair of headphones to the **PHONES** jack. No sound comes out of the speakers. Be sure to turn down the volume before connecting or putting on headphones.



DO NOT turn off (on standby) the unit with the volume set to an extremely high level; otherwise, a sudden blast of sound can damage your hearing, speakers and/or headphones when you turn on the unit or start playing any source next time. REMEMBER you cannot adjust the volume level while the unit is on standby.

## Reinforcing the Bass Sound

The Hyper Bass Sound function provided for this unit can enhance the bass sound while listening to any source at low volume.

- You can use this function only for playback.

To turn on the function, press and hold **HBS/PRESET EQ** for more than 1 second so that the **HBS** indicator appears on the display.

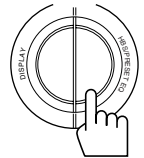

01 00:03

To turn off the function, press and hold the button for more than 1 second again so that the **HBS** indicator goes off from the display.

## Selecting the Sound Modes

You can select one of the 5 preset sound modes.

**SEA (Sound Effect Amplifier) modes:**

**CLASSIC:** Good for classical music.

**ROCK:** Boosts low and high frequency. Good for acoustic music.

**POP:** Good for vocal music.

**JAZZ:** Good for jazz music.

**FLAT:** Normal sound.

- This function only affects the playback sound, but does not affect your recording.

To select the sound modes, press **HBS/PRESET EQ** repeatedly until the indicator for the sound mode you want appears on the display.

- Each time you press the button, the sound modes change as follows:

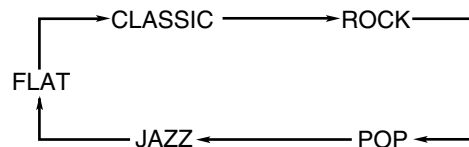
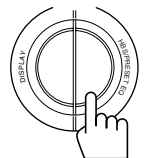

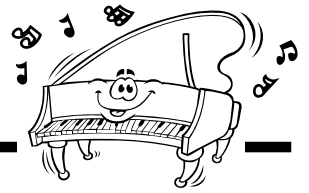

## Ensuring Good FM and AM Reception

**FM reception:** Pull out the antenna and reorient it for better reception.

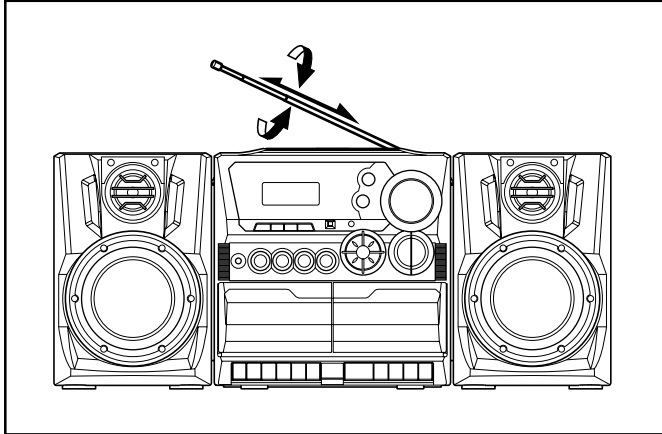

**AM reception:** Reorient the main unit for better reception.

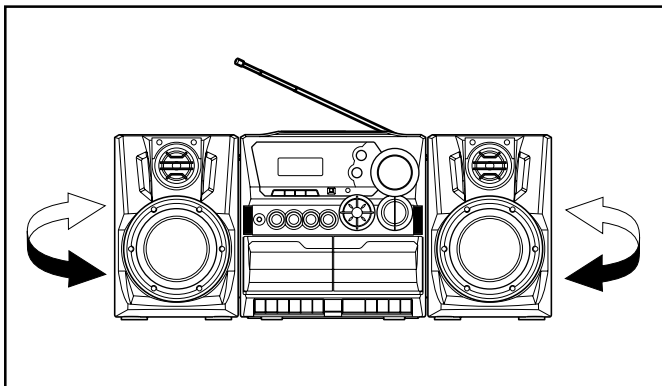

### For better reception of both FM and AM

- Make sure the antenna conductors do not touch any other terminals and connecting cords.
- Keep the antennas away from metallic parts of the unit, connecting cords, and the AC power cord.

# Listening to FM and AM Broadcasts



## Tuning in a Station

### 1 Press TUNER/BAND.

The unit automatically tunes in the previously tuned station (either FM or AM).

- Each time you press the button, the band alternates between FM and AM.



### 2 Press and hold ◀◀ or ▶▶ for more than 1 second.

The unit starts searching for stations and stops when a station of sufficient signal strength is tuned in. If a program is broadcast in stereo, you can hear stereo sounds (the STEREO indicator appears).

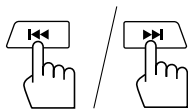

### 3 Press PRESET UP/REPEAT or PRESET DOWN to select a preset number.

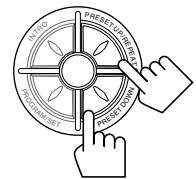

### 4 Press PROGRAM/SET again.

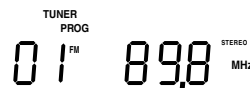

The tuned station in step 1 is stored in the preset number selected in step 3.

- Storing a new station on a used number erases the previously stored one.

To stop during searching, press ◀◀ or ▶▶.



When you press ◀◀ or ▶▶ briefly and repeatedly the frequency changes step by step.



When you unplug the AC power cord or if a power failure occurs

The preset stations will be erased in a few days. If this happens, preset the stations again. If the batteries are inserted in the unit, this has no effect on the memory.

### To change the FM reception mode

When an FM stereo broadcast is hard to receive or noisy, press FM MODE so that the MONO indicator appears on the display. Reception improves.

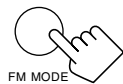

To restore the stereo effect, press FM MODE again so that the MONO indicator goes off.

- The stereo effect is also restored when you tune in another station.

## Presetting Stations

You can preset 10 FM and 10 AM stations.

In some cases, test frequencies have been already memorized for the tuner since the factory examined the tuner preset function before shipment. This is not a malfunction. You can preset the stations you want into memory by following the presetting method.

- There is a time limit in doing the following steps. If the setting is canceled before you finish, start from step 2 again.

### 1 Tune in the station you want to preset.

- See "Tuning in a Station" above.



### 2 Press PROGRAM/SET.



## Tuning in a Preset Station

### 1 Press TUNER/BAND.

The unit automatically tunes in the previously tuned station (either FM or AM).

- Each time you press the button, the band alternates between FM and AM.



### 2 Select a preset number. Press PRESET UP/REPEAT or PRESET DOWN.

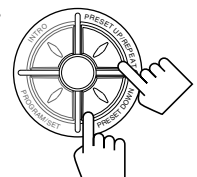

**On the remote control ONLY:**  
Press the number buttons.

For preset number 5, press 5.

For preset number 10, press +10, then 0.

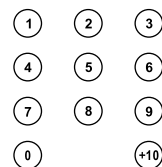

# Playing Back CD

This unit has been designed to play back the following CDs: Audio CD, CD-R, and CD-RW.

Continued use of irregular shape CDs (heart-shape, octagonal, etc.) can damage the unit.

## When playing a CD-R or CD-RW

User-edited CD-Rs (Recordable) and CD-RWs (Rewritable) can be played back only if they are already “finalized.”

- You can play back your original CD-Rs or CD-RWs recorded in music CD format. (However, they may not be played back depending on their characteristics or recording conditions.)
- Before playing back CD-Rs or CD-RWs, read their instructions or cautions carefully.
- Some CD-Rs or CD-RWs may not be played back on this unit because of their disc characteristics, damage or stain on them, or if the player’s lens is dirty.
- CD-RWs may require a longer readout time. (This is caused by the fact that the reflectance of CD-RWs is lower than for regular CDs.)

## Loading CD

### On the unit ONLY:

**1** Press **▲ OPEN** on the disc door to open the disc door.

**2** Place a disc correctly with its label side up as shown below.

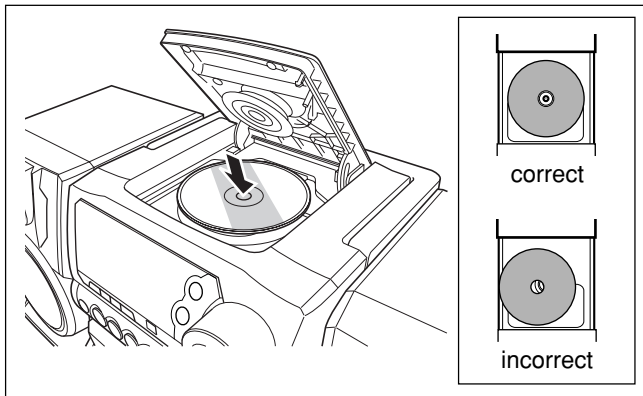

**3** Press **▲ OPEN** again to close the disc door.

## Playing Back the Entire Disc

You can play CD continuously.

**1** Load CD.

**2** Press **CD/RANDOM**, then **▶/II**.

CD play starts from the first track.

- Pressing CD/RANDOM while the source is CD starts Random play (see page 15). In this case, press just **▶/II** to start playback.

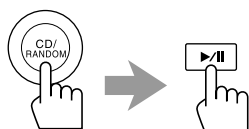

Track number      Elapsed playing time

To stop during play, press **■**.

To remove the disc, press **▲ OPEN**.

## Basic CD Operations

While playing a CD, you can do the following operations.

### To stop play for a moment

Press **▶/II**.

While pausing, the elapsed playing time flashes on the display.



To resume play, press **▶/II** again.

### To locate a particular point in a track

During play, press and hold **◀◀** or **▶▶**.

- **◀◀** : Fast reverses the disc.
- **▶▶** : Fast forwards the disc.

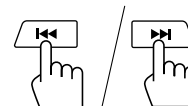

### To go to another track

Press **◀◀** or **▶▶** repeatedly before or during playback.

- **◀◀** : Goes back to the beginning of the current or previous tracks.
- **▶▶** : Skips to the beginning of the next or succeeding tracks.

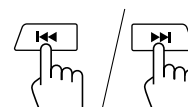

If you press and hold **◀◀** or **▶▶** before playing you can change the tracks continuously.

### To go to another track directly using the number buttons

#### On the remote control ONLY:

Pressing the number button(s) before or during play allows you to start playing the track number you want.

Ex.: For track number 5, press 5.

For track number 10, press +10, then 0.

For track number 15, press +10, then 5.

For track number 20, press +10, +10, then 0.

For track number 32, press +10, +10, +10, then 2.

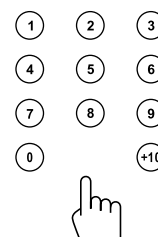



## Programming the Playing Order of the Tracks —Program Play

You can arrange the order in which the tracks play before you start playing. **You can program up to 20 tracks.**

- To use Repeat play (see page 15) for Program play, press PRESET UP/REPEAT after starting Program play.
- There is a time limit in doing the following steps. If the setting is canceled before you finish, start from step 2 again.

### 1 Load CD.

- If the current playing source is not the CD player, press CD/RANDOM before going to the next step.

### 2 Press PROGRAM/SET.

The PROG indicator flashes on the display.



- If a program has been stored in memory, the program is called up.

### 3 Select a track from the CD. Press ◀◀ or ▶▶ to select the track number.

**On the remote control ONLY:**  
Press the number buttons.

- For how to use the number buttons, see “To go to another track directly using the number buttons” on page 13.

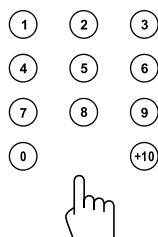
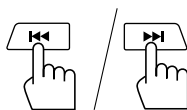
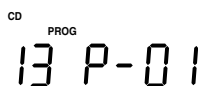

### 4 Press PROGRAM/SET.



### 5 Repeat steps 3 and 4 to program other tracks if you want.

### 6 Press ▶/II while the PROG indicator flashes.

The tracks are played in the order you have programmed.

- If the PROG indicator goes off before you press ▶/II, press PROGRAM/SET, then press ▶/II to start playback.



To stop during play, press ■.

The PROG indicator goes off from the display and the unit exits from Program play. (The program you have made is stored in memory until you erase the program.)

### To check the program contents

Before playing, you can check the program contents by pressing PROGRAM/SET.

- Each time you press the button, the programmed tracks are shown on the display.



### To add tracks in the program

- 1 Press PROGRAM/SET repeatedly to show the last programmed track.
- 2 Press PROGRAM/SET repeatedly until “00” appears as the track number.
- 3 Enter the track number(s) you want to add by repeating steps 3 and 4 on the left.

### To edit the program

- 1 Press PROGRAM/SET repeatedly to show the program number you want to edit.
- 2 Enter the track number you want by following steps 3 and 4 on the left.

### To erase the entire program before or after play

- 1 Press PROGRAM/SET.  
The PROG indicator flashes on the display.

- 2 Press ■.

- Ejecting a CD will also erase the entire program.



#### If you cannot enter a track number

You are trying to program a track number that does not exist on the CD (for example, selecting track 14 on a CD that only has 12 tracks).



#### After you have programmed 20 tracks

The program number returns to “P-01.” Programming more tracks overwrite the tracks already programmed to those numbers.



## Playing at Random—Random Play

The tracks of loaded CD will play at random.

- To use Repeat play for Random play, press PRESET UP/REPEAT so that REP ALL indicator lights up on the display after starting Random play (Random play will be canceled when you select REP 1).

### 1 Load CD.

- If the current playing source is not the CD player, press CD/RANDOM before going to the next step.

### 2 Press CD/RANDOM so that the RANDOM indicator appears on the display.

Random play starts.

- If you press CD/RANDOM during CD playback, the Random play starts after the current track ends.



CD      RANDOM  
05      0:03

The tracks are played at random.

Random play ends when all the tracks are played once.

To skip the currently playing track, press ►►.

To stop during play, press ■.

The RANDOM indicator goes off from the display and the unit exits from Random play.

- To cancel Random play without stopping playback, press CD/RANDOM so that the RANDOM indicator goes off.

## Repeating Tracks or CD—Repeat Play

You can have the CD, the program or the individual track currently playing repeat as many times as you like.

To repeat play, press PRESET UP/REPEAT during or before playing. To use Repeat play for Program play, Random play and Intro play, press the button before or after starting playback.

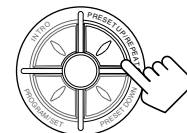

- Each time you press the button, Repeat play mode changes as follows, and the REP ALL or REP 1 indicator appears on the display:

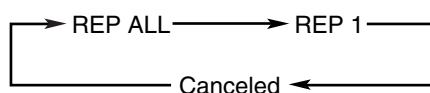

**REP ALL** : Repeats all the tracks (continuously or at random), or all the tracks in the program.

**REP 1** : Repeats one track (except for Random play).



When you select Random play REP 1 is canceled.

To stop during play, press ■.

The REP indicator goes off from the display and the unit exits from Repeat play.

- To cancel Repeat play without stopping playback, press PRESET UP/REPEAT repeatedly until the REP indicator goes off.

## Playing Introductions—Intro Play

Every track or every programmed track of a CD can be played for the beginning ten seconds.

To use Intro play, press INTRO.

Intro play starts and the INTRO indicator appears. To use Intro play for Program play and Random play, press the button after starting playback.



To stop during play, press ■.

The INTRO indicator goes off from the display and the unit exits from Intro play.

- To cancel Intro play without stopping playback, press INTRO again until the INTRO indicator goes off.



If you press INTRO while playing a track after ten seconds from the beginning

The introduction of the next track begins to play.

# Playing Back Tapes



You can play back only type I (Normal) tapes.

## Playing Back a Tape

- 1 Press **STOP/EJECT** ■/▲ for the deck you want to use.

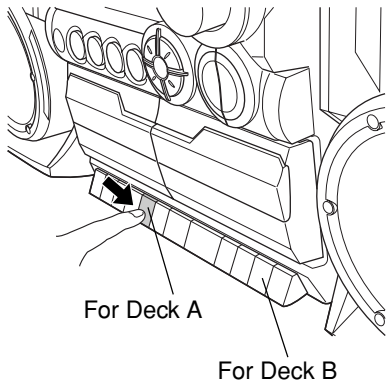

- 2 Put a cassette in, with the exposed part of the tape down.

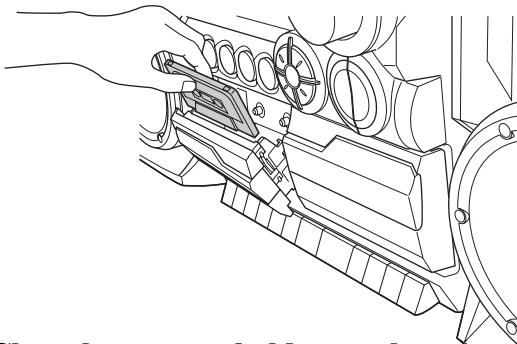

- 3 Close the cassette holder gently.

- 4 Press **TAPE**.



- 5 Press **PLAY** ►.

The tape play starts.

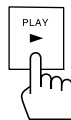

When the tape plays to the end, the deck automatically stops.

To stop during play, press **STOP/EJECT** ■/▲.

To operate the other deck, press **STOP/EJECT** ■/▲, then **PLAY** ► on the other deck.

To fast wind to the left or to the right, press **REW** ◀◀/ **FF** ▶▶ while the tape is not running.

To remove the cassette, press **STOP/EJECT** ■/▲.

To play the tapes in the decks B and A continuously

- 1 Set the cassette tapes in the decks A and B.
  - If the tape direction is set wrong, replace the cassette.

- 2 Press **PLAY** ► for the deck B.  
The tape in the deck B begins to play.

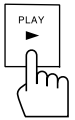

- 3 Press **PAUSE** ||, then press **PLAY** ► for the deck A.  
When the tape in the deck B ends, the tape in the deck A automatically begins to play.

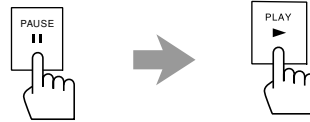

The use of the C-120 or thinner tape is not recommended, since characteristic deterioration may occur and this tape easily jams in the pinch-rollers and the capstans.

# Recording

## IMPORTANT:

- It should be noted that it may be unlawful to re-record pre-recorded tapes, records, or discs without the consent of the owner of copyright in the sound or video recording, broadcast or cable program and in any literary, dramatic, musical, or artistic embodied therein.
- The recording level is automatically set correctly, so it is not affected by the VOLUME +/- . Thus, during recording you can adjust the sound you are actually listening to without affecting the recording level.
- While recording, you can hear sound modes through the speakers or headphones (see page 10). However, the sound is recorded without these effects.
- If recordings you have made have excessive noise or static, the unit may be too close to a TV. Increase the distance between the TV and the unit.
- You can use only type I (Normal) tapes for recording.

## To protect your recording

Cassettes have two small tabs on the back to protect unexpected erasure or re-recording.

To protect your recording, remove these tabs.

To re-record on a protected tape, cover the holes with adhesive tape.

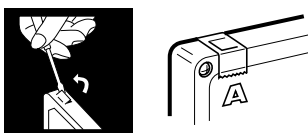

## To keep the best recording and playback sound quality

If the heads, capstans, and pinch rollers of the cassette decks become dirty, the following will occur:

- Impaired sound quality
- Discontinuous sound
- Fading
- Incomplete erasure
- Difficulty in recording

## To clean the heads, capstans, and pinch rollers

Use a cotton swab moistened with alcohol.

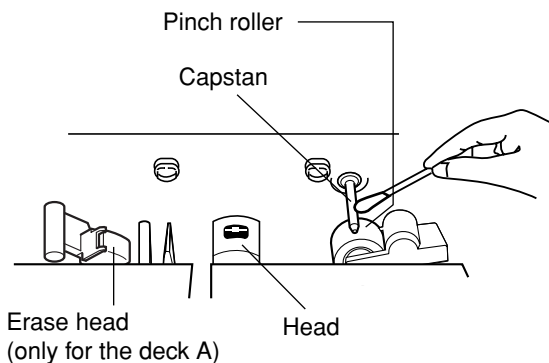

## To demagnetize the heads

Turn off the unit, and use a head demagnetizer (available at electronics and record shops).

## Recording onto a Tape on Deck A

### On the unit ONLY:

**1** Put a recordable cassette into the deck A with the exposed part of the tape down.

- See also page 16.

**2** Close the cassette holder gently.

**3** Start playing the source—FM, AM\*, CD player, deck B, or auxiliary equipment connected to AUX IN jacks.

- When the source is CD, you can also use Disc Synchronized Recording (see page 18).
- When the source is the deck B, you can also use the dubbing method. (See “Dubbing Tapes” on page 18.)

\* See “To record an AM station—Beat Cut” on page 18.

**4** Press REC ● for the deck A.

The recording starts.

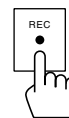

To stop during recording, press STOP/EJECT ■/▲ for the deck A.

To remove the cassette, press STOP/EJECT ■/▲ for the deck A.



You cannot press REC ● in the following cases:

- If no cassette is inserted.
- If a protected tape is inserted.

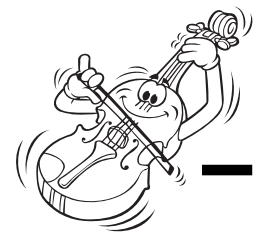

## To record an AM station—Beat Cut

While recording an AM broadcast, beats may be heard (which are never heard when listening to the broadcast without recording it).

If this occurs, set the BEAT CUT switch on the back of the unit to 1 or 2 to reduce the beating sound.

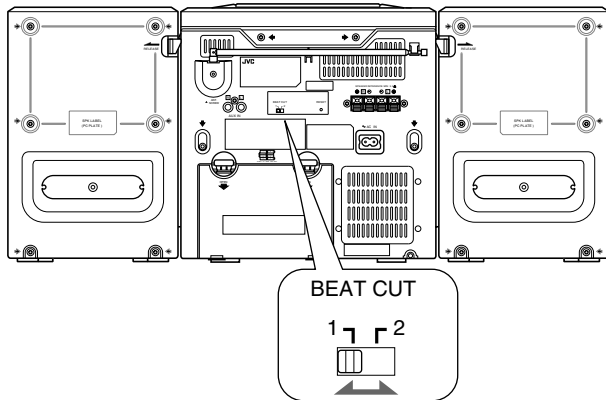

## Dubbing Tapes

**1** Press TAPE.



**2** Put the source cassette into the deck B, and a recordable cassette into the deck A.

**3** Press PAUSE **||**, then press REC **●** for the deck A.

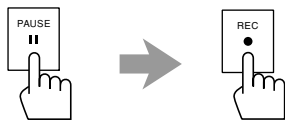

**4** Press PLAY **▶** for the deck B.

Dubbing starts.

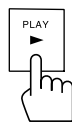

To stop during dubbing, press STOP/EJECT **■/▲** for the deck A.

## Recording Disc

### —Disc Synchronized Recording

You can start disc play and recording at the same time.

**1** Put a recordable cassette into the deck A with the exposed part of the tape down.

- See also page 16.

**2** Close the cassette holder gently.

**3** Press CD/RANDOM select the CD player as the source.

- If you want to record tracks in the desired order, program the playing order (see page 14).



**4** Press REC **●**.

The CD playback and recording start automatically. The SYNC REC indicator appears on the display.

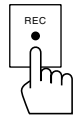

CD SYNC REC  
01 0:03

- When the end of the tape is reached, recording stops and the CD playback is paused. When CD playback ends, press STOP/EJECT **■/▲** to stop the recording.

- If you press REC **●** while playing back the CD, the CD player returns to the beginning of that track and the recording starts from that track.



You cannot press REC **●** in the following cases:

- If no cassette is inserted.
- If a protected tape is inserted.

To stop recording for a moment, press PAUSE **||**.

The recording is paused, but the CD playback does not stop.

To resume recording, press PAUSE **||** again.

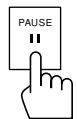

To stop recording, press STOP/EJECT **■/▲**.

The recording stops and the CD playback is paused.

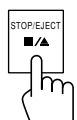

To remove the cassette, press STOP/EJECT **■/▲** while recording is stopped.

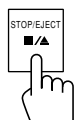

# Maintenance



To get the best performance of the unit, keep your discs, tapes, and mechanism clean.

## Handling discs



- Remove the disc from its case by holding it at the edge while pressing the center hole lightly.
- Do not touch the shiny surface of the disc, or bend the disc.
- Put the disc back in its case after use to prevent warping.

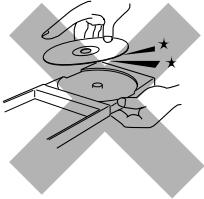

- Be careful not to scratch the surface of the disc when placing it back in its case.
- Avoid exposure to direct sunlight, temperature extremes, and moisture.



### To clean the disc

Wipe the disc with a soft cloth in a straight line from center to edge.



DO NOT use any solvent—such as conventional record cleaner, spray, thinner, or benzine—to clean the disc.

## Handling cassette tapes

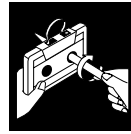

- If the tape is loose in its cassette, take up the slack by inserting a pencil in one of the reels and rotating.
- If the tape is loose, it may get stretched, cut, or caught in the cassette.

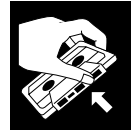

- Be careful not to touch the tape surface.



- Avoid the following places to store the tape:
  - In dusty places
  - In direct sunlight or heat
  - In moist areas
  - Near a magnet

# Troubleshooting



If you are having a problem with your unit, check this list for a possible solution before calling for service. If you cannot solve the problem from the hints given here, or the unit has been physically damaged, call a qualified person, such as your dealer, for service.

Symptom	Cause	Action
No sound is heard.	<ul style="list-style-type: none"> <li>• Connections are incorrect or loose.</li> <li>• Muting is activated.</li> </ul>	<ul style="list-style-type: none"> <li>• Check all connections and make corrections. (See pages 6 – 8.)</li> <li>• Press MUTING to cancel the mute. (See page 10.)</li> </ul>
The disc sound is discontinuous.	The disc is scratched or dirty.	Clean or replace the disc. (See page 19.)
The disc does not play.	The disc is placed upside down.	Place the disc with the label side up.
Impossible to record.	Small tabs on the back of the cassette are removed.	Cover the holes with adhesive tape.
Operations are disabled.	The built-in microprocessor may malfunction due to external electrical interference.	Unplug the AC power cord after removing the batteries from the unit, and then plug it back in.
Unable to operate the unit from the remote control.	<ul style="list-style-type: none"> <li>• The path between the remote control and the remote sensor on the unit is blocked.</li> <li>• The batteries are exhausted.</li> </ul>	<ul style="list-style-type: none"> <li>• Remove the obstruction.</li> <li>• Replace the batteries.</li> </ul>

## Resetting the unit

If “Troubleshooting” (see above) does not eliminate malfunctioning (failure to operate or display properly etc.), press the reset switch on the back of the unit with something having a sharp point.



### If you reset the unit

Resetting causes the unit to restore its factory default settings and results in all the settings made by the user being deleted.

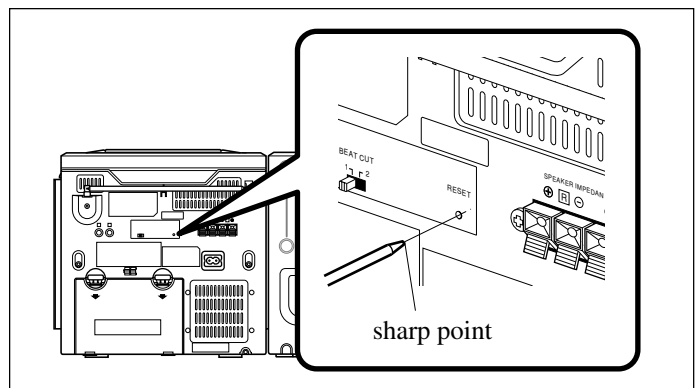

# Specifications

Design and specifications are subject to change without notice.

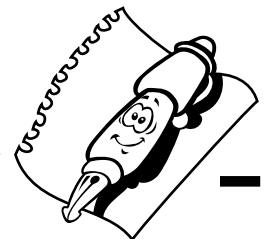

## Amplifier section—CA-PCX290

Output Power:

5 W + 5 W at 3.2 Ω (10% THD)

Audio input sensitivity/Impedance (at 1 kHz)

AUX: 1 000 mV/47 kΩ

Speakers/Impedance: 3.2 Ω – 8 Ω

## Tuner

FM tuning range: 87.5 MHz – 108.0 MHz

AM tuning range: 522 kHz – 1 629 kHz

## CD player

CD Capacity: 1 CD

Dynamic range: 60 dB

Signal-to-noise ratio: 75 dB

## Cassette deck

Frequency response

Normal (type I): 50 Hz — 10 000 Hz

Wow and flutter: 0.15% (WRMS)

## General

Power requirements: AC 230 V~, 50 Hz

DC 12 V (“R20(SUM-1)/D(13D)” batteries (8))

Power consumption: 20 W (at operation)

3 W (on standby)

Dimensions (approx.): 270 mm x 274 mm x 298 mm (W/H/D)

Mass (approx.): 4.1 kg

## Supplied accessories

See page 6.

## Speaker section—SP-PCX290

Type: 2-way bass-reflex type

Speaker units: Woofer: 10 cm cone x1

Tweeter: 5 cm cone x1

Power handling capacity: 5 W

Impedance: 3.2 Ω

Frequency range: 50 Hz — 18 000 Hz

Dimensions (approx.): 180 mm x 270 mm x 228 mm (W/H/D)

Mass (approx.): 1.7 kg each





## Free Manuals Download Website

<http://myh66.com>

<http://usermanuals.us>

<http://www.somanuals.com>

<http://www.4manuals.cc>

<http://www.manual-lib.com>

<http://www.404manual.com>

<http://www.luxmanual.com>

<http://aubethermostatmanual.com>

Golf course search by state

<http://golfingnear.com>

Email search by domain

<http://emailbydomain.com>

Auto manuals search

<http://auto.somanuals.com>

TV manuals search

<http://tv.somanuals.com>