

JVC®

I'Art™ PRO

Projection Television Users Guide

**For Models:
AV-65WP94
AV-56WP94**



Illustration of AV-56WP94 and RM-C12G

Important Note:

In the spaces below, enter the model and serial number of your television (located at the rear of the television cabinet). Staple your sales receipt or invoice to the inside cover of this guide. Keep this user's guide in a convenient place for future reference. Keep the carton and original packaging for future use.

Model Number: _____

Serial Number: _____

LCT1468-001B-A
1003-TN-II-IM

Important Safety Precautions



CAUTION
RISK OF ELECTRIC SHOCK
DO NOT OPEN



CAUTION: To reduce the risk of electric shock. Do not remove cover (or back). No user serviceable parts inside. Refer servicing to qualified service personnel.



The lightning flash with arrowhead symbol, within an equilateral triangle is intended to alert the user to the presence of uninsulated "dangerous voltage" within the product's enclosure that may be of sufficient magnitude to constitute a risk of electric shock to persons.



The exclamation point within an equilateral triangle is intended to alert the user to the presence of important operating and maintenance (servicing) instructions in the literature accompanying the appliance.

WARNING: TO PREVENT FIRE OR SHOCK HAZARDS, DO NOT EXPOSE THIS TV SET TO RAIN OR MOISTURE.

CAUTION: TO INSURE PERSONAL SAFETY, OBSERVE THE FOLLOWING RULES REGARDING THE USE OF THIS UNIT.

1. Operate only from the power source specified on the unit.
2. Avoid damaging the AC plug and power cord.
3. Avoid Improper installation and never position the unit where good ventilation is unattainable.
4. Do not allow objects or liquid into the cabinet openings.
5. In the event of trouble, unplug the unit and call a service technician. Do not attempt to repair it yourself or remove the rear cover.

Changes or modifications not approved by JVC could void the warranty.

- When you don't use this TV set for a long period of time, be sure to disconnect both the power plug from the AC outlet and antenna for your safety.
- To prevent electric shock do not use this polarized plug with an extension cord, receptacle or other outlet unless the blades can be fully inserted to prevent blade exposure.

IMPORTANT RECYCLING INFORMATION

This product utilizes both a Cathode Ray Tube (CRT) and other components that contain lead. Disposal of these materials may be regulated in your community due to environmental considerations. For disposal or recycling information, please contact your local authorities, or the Electronic Industries Alliance: <http://www.eiae.org>



- As an “ENERGY STAR®” partner, JVC has determined that this product or product model meets the “ENERGY STAR®” guidelines for energy efficiency.

Important Safeguards

CAUTION:

Please read and retain for your safety.

Electrical energy can perform many useful functions. This TV set has been engineered and manufactured to assure your personal safety. But **improper use can result in potential electrical shock or fire hazards**. In order not to defeat the safeguards incorporated in this TV set, observe the following basic rules for its installation, use and servicing. Also follow all warnings and instructions marked on your TV set.

INSTALLATION

- 1 Your TV set is equipped with a polarized AC line plug (one blade of the plug is wider than the other). This safety feature allows the plug to fit into the power outlet only one way. Should you be unable to insert the plug fully into the outlet, try reversing the plug. Should it still fail to fit, contact your electrician.
- 2 Operate the TV set only from a power source as indicated on the TV set or refer to the operating instructions for this information. If you are not sure of the type of power supply to your home, consult your TV set dealer or local power company. For battery operation, refer to the operating instructions.
- 3 Overloaded AC outlets and extension cords are dangerous, and so are frayed power cords and broken plugs. They may result in a shock or fire hazard. Call your service technician for replacement.
- 4 Do not allow anything to rest on or roll over the power cord, and do not place the TV set where power cord is subject to traffic or abuse. This may result in a shock or fire hazard.
- 5 Do not use this TV set near water — for example, near a bathtub, washbowl, kitchen sink, or laundry tub, in a wet basement, or near swimming pool, etc.
- 6 If an outside antenna is connected to the TV set, be sure the antenna system is grounded so as to provide some protection against voltage surges and built-up static charges. Section 810 of the National Electrical Code provides information with respect to proper grounding of the mast and supporting structure, grounding of the lead-in wire to an antenna discharge unit, size of grounding conductors, location of antenna discharge unit, connection requirements for the grounding electrode.

(POLARIZED-TYPE)

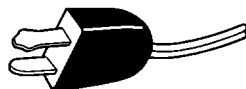

- 7 An outside antenna system should not be located in the vicinity of overhead power lines or other electric light or power circuits, or where it can fall into such power lines or circuits. When installing an outside antenna system, extreme care should be taken to keep from touching such power lines or circuits as contact with them might be fatal.

EXAMPLE OF ANTENNA GROUNDING AS PER NATIONAL ELECTRICAL CODE

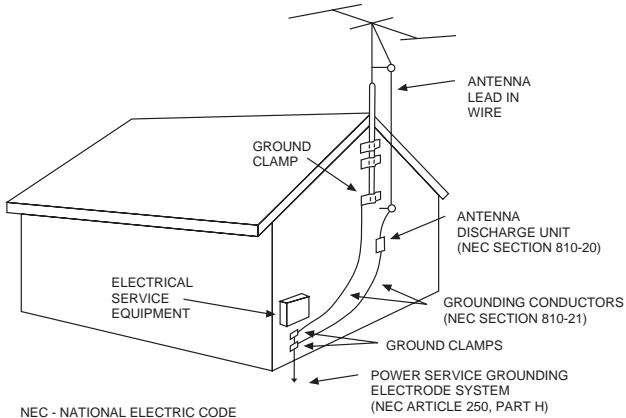

- 8 TV sets are provided with ventilation openings in the cabinet to allow heat generated during operation to be released.

Therefore:

- Never block the bottom ventilation slots of a portable TV set by placing it on a bed, sofa, rug, etc.
- Never place a TV set in a “built-in” enclosure unless proper ventilation is provided.
- Never cover the openings with a cloth or other material.
- Never place the TV set near or over a radiator or heat register.

- 9 To avoid personal injury:

- Do not place a TV set on a sloping shelf unless properly secured.
- Use only a cart or stand recommended by the TV set manufacturer.
- Do not try to roll a cart with small casters across thresholds or deep pile carpets.
- Wall or shelf mounting should follow the manufacturer’s instructions, and should use a mounting kit approved by the manufacturer.

Use

- 10 Caution children about dropping or pushing objects into the TV set through cabinet openings. Some internal parts carry hazardous voltages and contact can result in a fire or electrical shock.
- 11 Unplug the TV set from the wall outlet before cleaning. Do not use liquid or an aerosol cleaner.
- 12 Never add accessories to a TV set that has not been designed for this purpose. Such additions may result in a hazard.



PORTABLE CART WARNING
(Symbol provided by RETAC)

- 13 For added protection of the TV set during a lightning storm or when the TV set is to be left unattended for an extended period of time, unplug it from the wall outlet and disconnect the antenna. This will prevent damage to product due to lightning storms or power line surges.
- 14 A TV set and cart combination should be moved with care. Quick stops, excessive force, and uneven surfaces may cause the TV set and cart combination to overturn.

Service

- 15 Unplug this TV set from the wall outlet and refer servicing to qualified service personnel under the following conditions:
 - A. When the power cord or plug is damaged or frayed.
 - B. If liquid has been spilled into the TV set.
 - C. If the TV set has been exposed to rain or water.
 - D. If the TV set does not operate normally by following the operating instructions. Adjust only those controls that are covered in the operating instructions as improper adjustment of other controls may result in damage and will often require extensive work by a qualified technician to restore the TV set to normal operation.
 - E. If the TV set has been dropped or damaged in any way.
 - F. When the TV set exhibits a distinct change in performance — this indicates a need for service.
- 16 Do not attempt to service this TV set yourself as opening or removing covers may expose you to dangerous voltage or other hazards. Refer all servicing to qualified service personnel.
- 17 When replacement parts are required, have the service technician verify in writing that the replacement parts he uses have the same safety characteristics as the original parts. Use of manufacturer's specified replacement parts can prevent fire, shock, or other hazards.
- 18 Upon completion of any service or repairs to this TV set, please ask the service technician to perform the safety check described in the manufacturer's service literature.
- 19 When a TV set reaches the end of its useful life, improper disposal could result in a picture tube implosion. Ask a qualified service technician to dispose of the TV set.
- 20 Note to CATV system installer.

This reminder is provided to call the CATV system installer's attention to Article 820-40 of the NEC that provides guidelines for proper grounding and, in particular, specifies that the cable ground shall be connected to the grounding system of the building, as close to the point of cable entry as practical.

Warnings

Screen Burn-in

By displaying fixed images for extended periods of time, can leave a subtle but permanent ghost image in your picture. This is referred to as "burn-in". To avoid this, mix your viewing pattern.

Examples include, but are not limited to the following:

- Stock-market report bars
- Shopping channel logos and pricing displays
- Video game patterns or scoreboards
- Bright station logos
- Internet web sites or other computer-style images.
- DVD discs, video tapes, laser discs
- Broadcast, cable, satellite channels or digital television tuners/converters.

Note: Warranty **DOES NOT** cover screen burn-in or uneven picture tube aging.

For example...

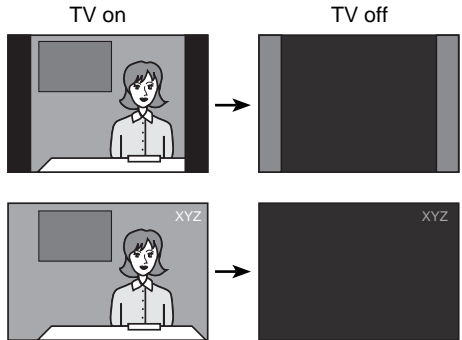

Caring for the Cabinet

Normally, light dusting with a soft, non-scratching duster will keep your TV clean.

If you wish to wipe down the television, first unplug it. Then wipe gently with a soft cloth, slightly moistened with water. You can add a few drops of mild liquid detergent to the water to help remove spots of oily dirt.

- DO NOT allow liquid to enter the TV through the ventilation slots.
- DO NOT use strong or abrasive cleaners on the TV.
- DO NOT spray liquids or cleaners directly on the TV's surface.
- DO NOT rub or scrub the TV harshly. Wipe the set gently with a soft cloth.

Caring for the Screen

The screen is treated with an electrostatic-proof coating. When it gets dirty, wipe it gently with a soft cloth. If the screen is very dirty, wipe it down with a cloth dipped in a diluted kitchen cleaner and thoroughly wrung-out. Then wipe immediately after with a clean, dry cloth.

Do not apply alcohol, organic solvents (like acetone), acidic or alkaline cleansers to the screen. These will remove the coating layer and cause discolorations.

Do not push or hit the screen. This could cause scratches on the screen surface and image distortions.

Table of Contents

Quick Setup 8

Unpacking your TV	8
TV Models	10
TV Remote Control	11
Getting Started	12
The Remote Control	12
Connecting Your Devices	13
Interactive Plug In Menu	23

Remote Programming 26

Setting CATV, VCR and DVD Codes	26
CATV or Satellite Codes	26
VCR Codes	27
DVD Codes	28
Search Codes	29

Onscreen Menus 30

Using the Guide	30
Onscreen Menu System	31

Initial Setup 33

Auto Tuner Setup	33
Channel Summary	33
V-Chip	34
Set Lock Code	40
Adjusting CRT Color Conversion	41
Auto Demo	43
Language	43
Closed Caption	44
Auto Shut Off	46
XDS ID	46
ATSC Monitor Out	47
Noise Muting	47
Front Panel Lock	48
V1 Smart Input	48
Position Adjustment	49
Power Indicator	49
TV Speaker	50
Audio Out	50
Center CH Input	50
ATSC Sound	51
Digital-In	51

Picture Adjust 52

Picture Settings	52
Adjust Picture Settings	52
Color Temperature	53
Digital Noise Clear	53
VSM	53
Natural Cinema	54
Reset	54

Sound Adjust 55

Sound Settings	55
Adjust Sound Settings	55
Reset	55
A.H.S	56
BBE	56

Clock Timers 57

Set Clock	57
On/Off Timer	58

Button Functions 59

Multi Screen Function	59
Split	59
Index	60
Freeze	60
Swap	60
Select	60
Power	61
Number Buttons	61
100+ Button	61
Input	61
Digital-In	61
Channel +/-	61
Volume +/-	62
Return +/TV	62
Muting	62
Menu	62
OK	62
Back	62
Video Status	63
TheaterPro D6500K	63
Sleep Timer	63
Display	64
Aspect	65
Aspect Ratios	66
ML/MTS	66
TV/CATV Slide Switch	67
VCR/DVD Slide Switch	67
VCR Buttons	67
DVD Buttons	67
Light	67
Super Focus	67

Button Functions - Digital . . . 68

Digital CH (DCS)	68
Sub Channel +/-	68
iLINK/Timer	69
EPG	73

Appendices 76

OSD Warning	76
Troubleshooting	77
Warranty	79
Authorized Service Centers	81
Specifications	82
Notes	83

Quick Setup

Unpacking your TV

Thank you for your purchase of a JVC Color Television. Before you begin setting up your new television, please check to make sure you have all of the following items. In addition to this guide, your television box should include:

1 Television

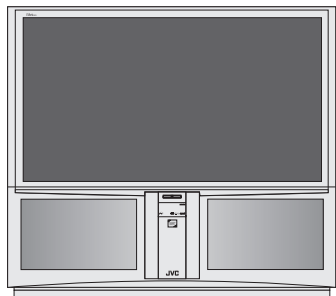

1 Remote Control



Two AA Batteries



Note: Your television and/or remote control may differ from the examples illustrated here.

Once you have unpacked your television, the next step is to connect it to your antenna/cable or satellite system and to connect the audio/video devices you want to use with your television. To make these connections you will use plugs like the ones illustrated below.

Coaxial Cables



Used to connect an external antenna or cable TV system to your TV.

Component Cables Composite Cables Audio Cables



Used to connect audio/video devices like VCRs, DVD players, stereo amplifiers, game consoles, etc.

S-Video Cable



Used to make video connections with S-Video VCRs, Camcorders and DVD players.

(continued...)

AV CompuLink Cable



Used to connect JVC AV CompuLink capable components for an automated home theater.

DVI-D Single Link 19-pin Cable

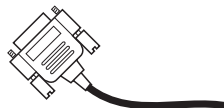

Used to connect high bandwidth digital content protection DTV decoders, DVD players and D-VHS players

i.LINK Cable

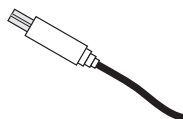

Used to connect an i.LINK compatible device to your TV.

Optical Audio Cable

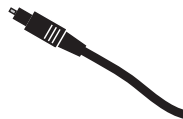

Used to connect an amplifier that has an optical digital input terminal.

We recommend that before you start using your new television, you read your entire User's Guide so you can learn about your new television's many great features. If you're anxious to start using your television right away, a quick setup guide follows on the next few pages.

NOTE: Before you connect your television to another device, please refer to the proper diagrams for your specific TV and remote. These will help assist you in understanding how to connect your television to another device, as well as use the remote to set up your television.

Rear Panel Diagram

MODELS:
AV-65WP94
AV-56WP94

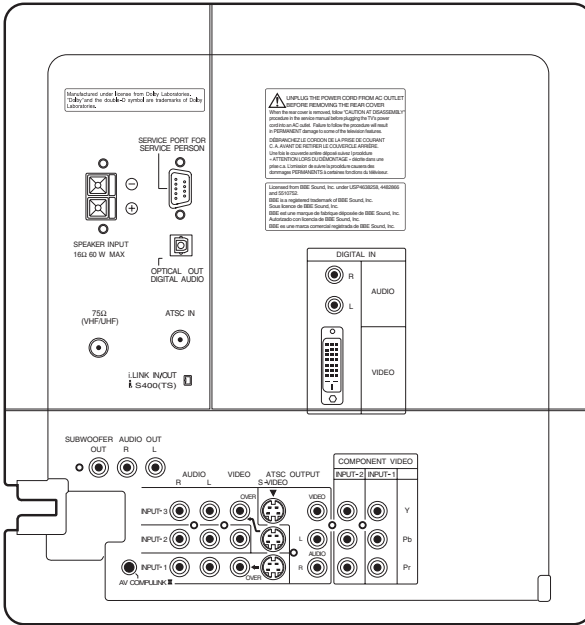

NOTE: The terminal labeled "SERVICE PORT FOR SERVICE PERSON", is only to be used by a service person. DO NOT use this terminal.

Front Panel Diagram

MODELS: AV-65WP94, AV-56WP94

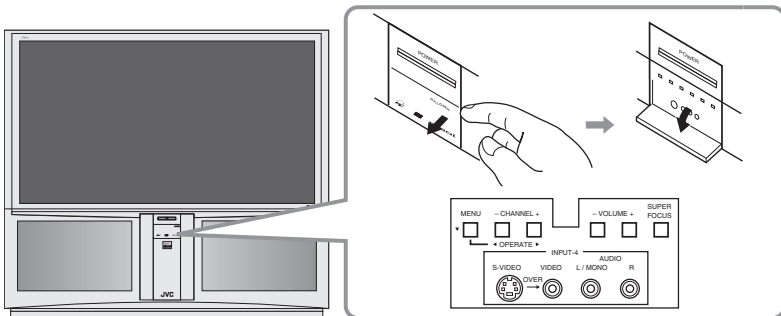

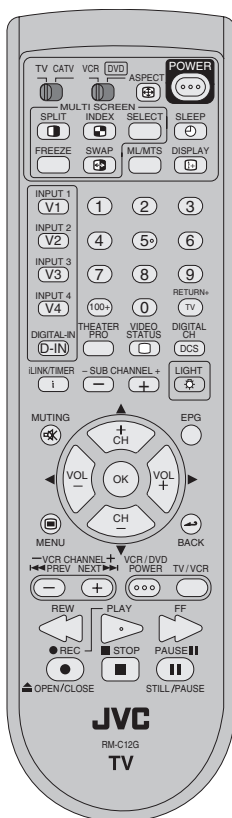

RM-C12G

MODELS:
AV-65WP94
AV-56WP94

- For information on remote control buttons, see pages 59 - 73.
- The DIGITAL CH (DCS), iLINK/TIMER, SUB CHANNEL +/- and EPG buttons are for digital channels. If your TV is connected to an ATSC antenna, you can use these buttons.

Getting Started

These quick setup pages will provide you, in three easy steps, with the basic information you need to begin using your new television right away.

If you have questions, or for more detailed information on any of these steps, please consult other sections of this manual.

Step 1 – The Remote Control

Before you can operate your remote control, you first need to install the batteries (included).

Slide the cover on the back of the remote down towards the bottom of the remote control. Insert two batteries (included) carefully noting the “+” and “-” markings, placing the “-” end in the unit first. Slide the cover back into place.

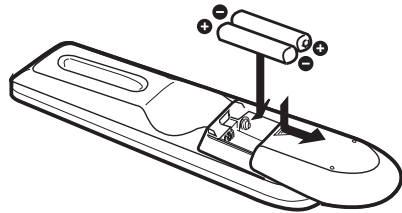

When you change the batteries, try to complete the task within three minutes. If you take longer than three minutes, the remote control codes for your VCR, DVD, and/or cable box/satellite receiver may have to be reset. See pages 26 - 29.

Key Feature Buttons

The four key feature buttons at the center of the remote can be used for basic operation of the television. The top and bottom buttons will scan forward and back through the available channels. To move rapidly through the channels using JVC's **Hyperscan** feature, press and hold CH+ or CH-. The channels will zip by at a rate of five channels per second. The right and left buttons will turn the volume up or down. These buttons are also marked with four arrows and are used with JVC's onscreen menu system. To use the onscreen menus, press the MENU button.

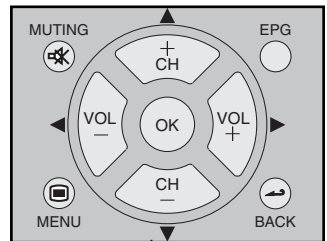

Basic Operation

Turn the television on and off by pressing the **POWER** button at the top right corner of the remote. If this is the first time you are turning on the TV, the interactive plug-in menu appears.

- Make sure the TV/CATV switch is set to TV. Move the switch to CATV only if you need to operate a cable box.
- Slide the VCR/DVD selector switch to VCR to control a VCR. Slide to DVD to control a DVD player. Please see pages 26 to 29 for instructions on programming your remote control to operate a cable box, VCR or DVD player.

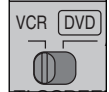
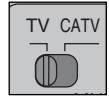

Step 2 – Connecting Your Devices

Please follow the flow chart below to determine which connection setup is right for you. Then, refer to the appropriate diagrams to connect your television to other devices that you may have. After you are finished connecting your devices, plug the power cord into the nearest power outlet and turn on the TV.

A VCR is not necessary for operation of the television. If you follow these diagrams and the television does not work properly, contact your local cable operator.

- To connect a DVD player, see **Diagram #3**. A DVD player is optional.
- If you have a satellite television system, please refer to the satellite TV manual.

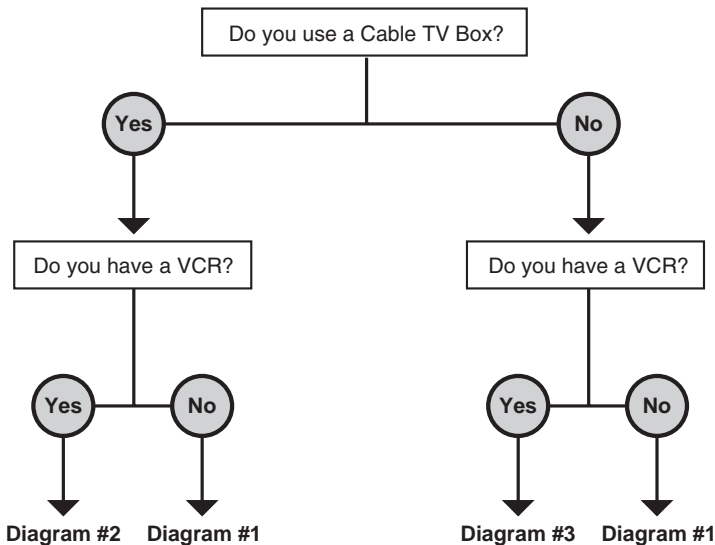
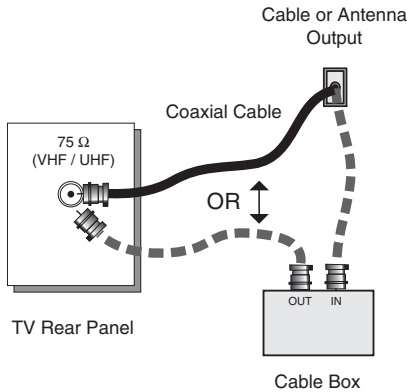
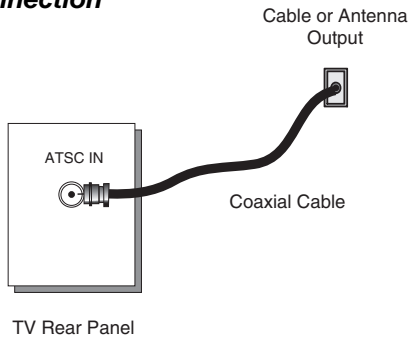

Diagram #1



ATSC Antenna Connection



Notes:

- If you do not have a cable box, connect the cable wire from the wall outlet into the back of the TV.
- If you want to connect both an NTSC and ATSC antenna or cable, use a two way splitter.

Diagram #2

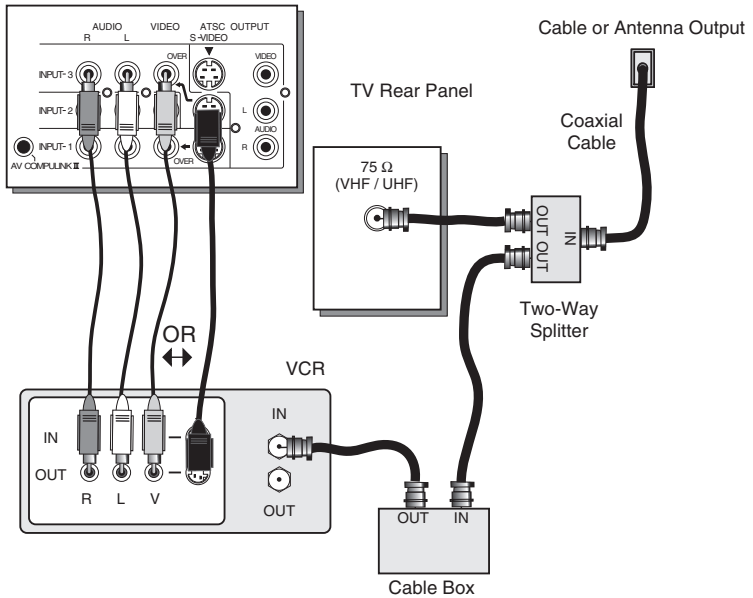

Recording a broadcast from ATSC connection

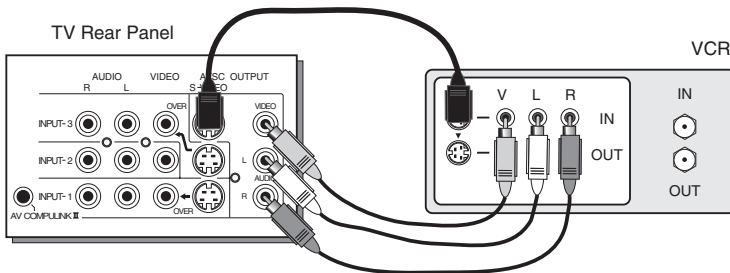

Notes:

- If your VCR is a mono sound unit, it will have only one audio out jack. Connect it to the LEFT AUDIO INPUT on the front of the TV.
- Use the S-Video connection if possible for superior picture quality.
- Your VCR must be turned on to view premium cable channels.
- When you play the limited recording program or the limited copied media, ATSC OUTPUT does not output anything.
- If you are recording an analog signal through the ATSC Monitor output, do not press the EPG button or do not operate ATSC MONITOR OUT in the Initial Setup Menu while recording. If you press or operate it, the picture may be blurred.

Notes:

- Green, blue and red are the most common colors for DVD cables. Some models may vary colors. Please consult the user's manual for your DVD player for more information.
- Be careful not to confuse the red DVD cable with the red audio cable. It is best to complete one set of connections (DVD or audio output) before starting the other to avoid accidentally switching the cables.
- You may also connect the DVD player to Input 1.

Diagram #3

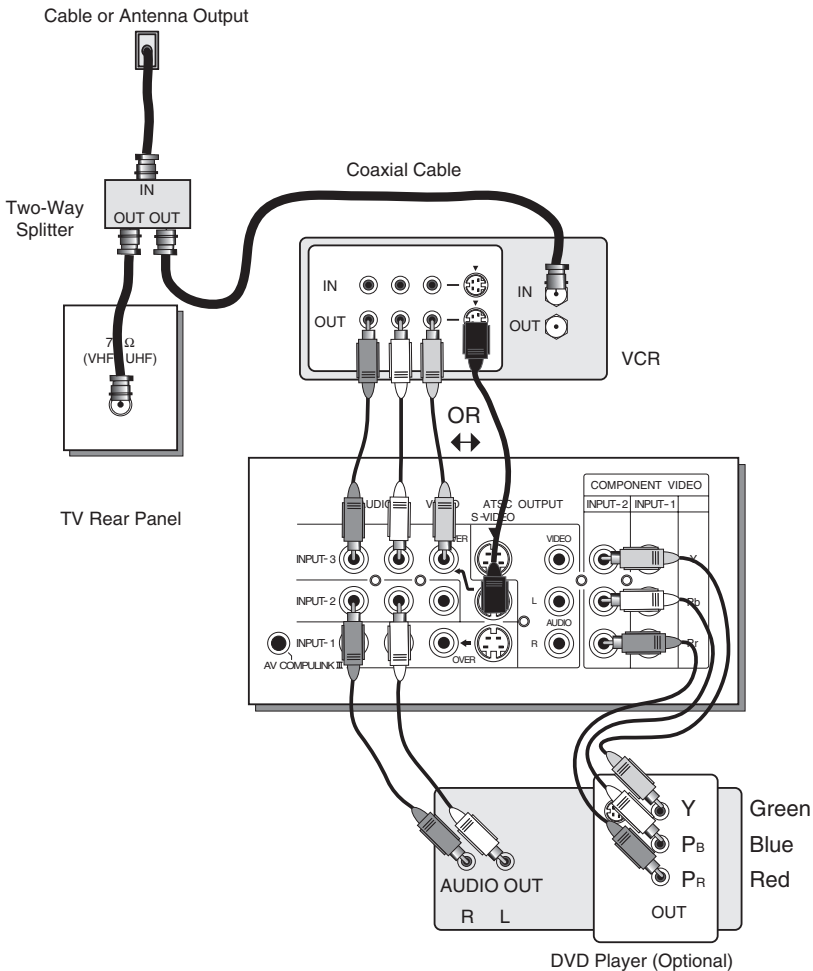

Connecting to JVC AV Compu Link

JVC's AV CompuLink feature makes playing video tapes or DVDs totally automatic. Simply insert a pre-recorded tape into your JVC brand VCR or DVD into your JVC DVD player and the device will automatically turn on and begin playback. At the same time, using the AV CompuLink, the VCR or DVD player sends a signal to the television telling it to turn on and switch to the proper video input.

- The AV CompuLink cable may be included with the JVC AV CompuLink unit you wish to connect. If it is not, contact JVC Parts Department at (800)-882-2345, or www.jvcservice.com for part # EWP 805-012.
- AV CompuLink can only be used with JVC brand products.

AV CompuLink Cable



To Connect: Plug one end of the AV CompuLink cable into the AV COMPULINK INPUT on your VCR, DVD, or other CompuLink device. Plug the other end of the AV CompuLink cable into the AV COMPULINK at the rear of the television.

Note:

- The AV CompuLink cable has a male 3.5 mm (mono) plug on each end.

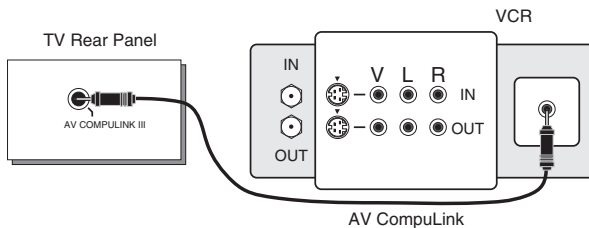

Notes:

- In order for the VCR playback to begin automatically, the recording tabs must be removed from the VHS tape. If the tab is in place, automatic switching will occur when you push the VCR's PLAY button.
- If your JVC brand VCR has "A code/B code remote control switching" (see your VCR's instruction book), using VCR A code will switch the TV to input 1.
- Refer to your DVD instruction book for detailed connection information.
- To connect a JVC HiFi receiver or amplifier for a completely automated home theater, see the receiver connection instructions for detailed connection information.
- AV CompuLink is compatible with select AV CompuLink receivers.

Connecting to a Camcorder

You may connect a camcorder, game console or other equipment to your television by using the front input jacks (Input 4) located under the front panel door. To access, pull on the door to open it. You can also connect these using the television's rear input jacks, using the same instructions.

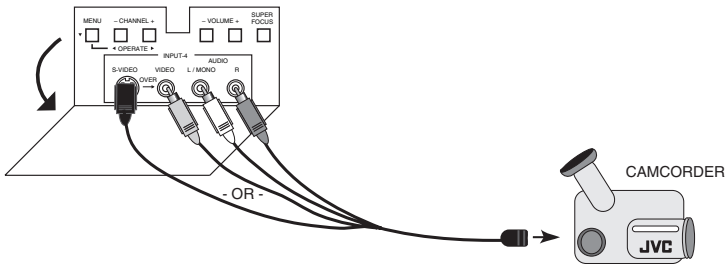

- 1) Connect a yellow composite cable from the camcorder VIDEO OUT, into the VIDEO IN on the front of the TV, **OR** connect an S-Video cable from the front of the TV to the camcorder.
- 2) Connect a white cable from the camcorder LEFT AUDIO OUT, into the LEFT AUDIO IN on the front of the TV.
- 3) Connect a red cable from the camcorder RIGHT AUDIO OUT, into the RIGHT AUDIO IN on the front of the TV.

Note:

- If your camcorder is a mono sound model it will have only one AUDIO OUT. Connect it to the LEFT AUDIO IN on the front of the TV.

Connecting to the Surround Amplifier

Note: Please read the benefit of this feature on page 50.

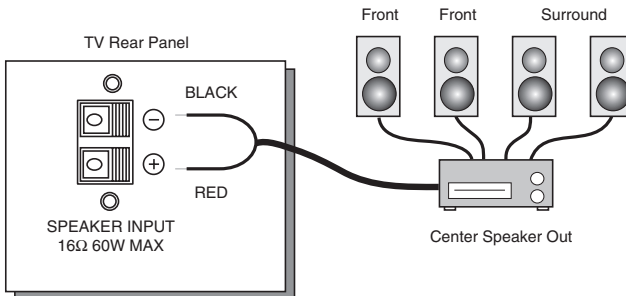

- 1) Connect the black speaker cable from the TV's SPEAKER INPUT ⊖ terminal to the surround amplifier's CENTER SPEAKER OUTPUT ⊖ terminal.
- 2) Connect the red speaker cable from the TV's SPEAKER INPUT ⊕ terminal to the surround amplifier's CENTER SPEAKER OUTPUT ⊕ terminal.

Connecting to an External Amplifier

Subwoofer Out - Use a powered subwoofer with the surround feature to simulate a home theater system. Simply connect the subwoofer to the back of the TV.

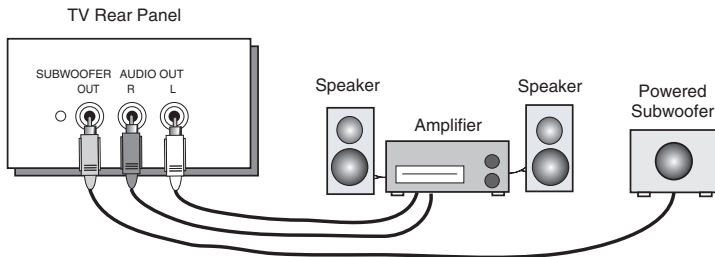

- 1) Connect a white cable from the LEFT AUDIO OUTPUT on the back of the TV to the LEFT AUDIO INPUT on the amplifier.
- 2) Connect a red cable from the RIGHT AUDIO OUTPUT on the back of the TV to the RIGHT AUDIO INPUT on the amplifier.
- 3) Connect a black cable from the SUBWOOFER OUT on the back of the TV to the LINE INPUT of the subwoofer.

Notes:

- Refer to your amplifier's manual for more information.
- You can use AUDIO OUTPUT for your home theater system.

Connecting to an amplifier using your optical output

You can connect an amplifier that has an optical digital input terminal by using an optical digital cable from the optical output. The signal that is output can be PCM or Dolby Digital.

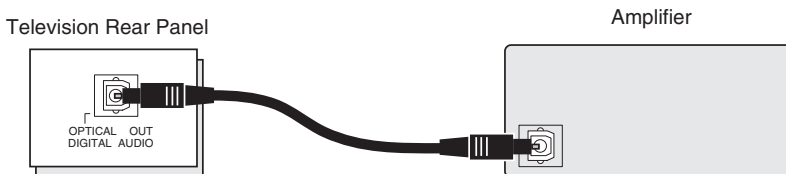

- 1) Connect the optical cable from the back of the television to the back of the amplifier.

Notes:

- This terminal can only output ATSC audio.
- In order to use the optical output connection, select PCM or Dolby Digital on ATSC SOUND in the INITIAL SETUP MENU. See page 51.
- Refer to your owners manual on using your amplifier.

Connecting to a Digital TV Receiver w/HDCP

By inputting a high bandwidth digital content protection high definition picture source to the digital-in terminal of this television, high-definition pictures can be displayed on the screen in their digital form. (This terminal is for use in the future when high bandwidth digital content protection DTV decoders and DVD players and D-VHS are put on the market.)

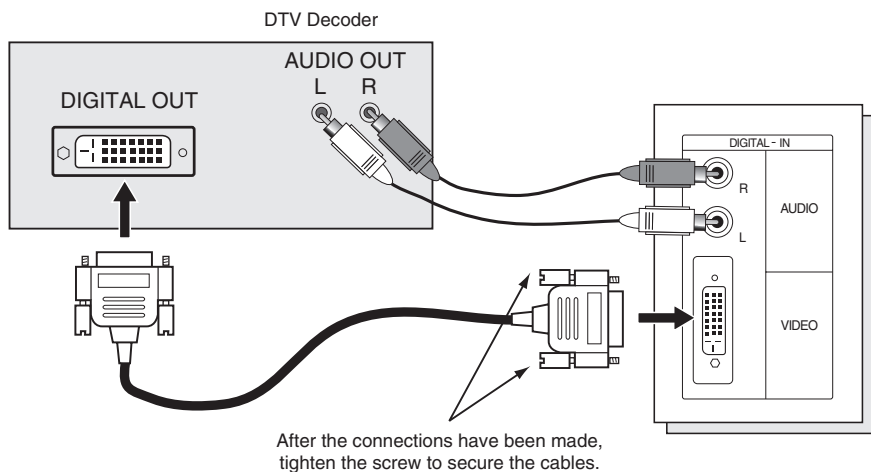

- 1) Connect the DTV DIGITAL RGB OUTPUT TERMINAL to the DIGITAL INPUT TERMINAL of the television, and then tighten the 2 screws.
 - 2) Connect the DTV decoder LEFT AUDIO OUTPUT to the DIGITAL-IN LEFT AUDIO INPUT.
 - 3) Connect the DTV decoder RIGHT AUDIO OUTPUT to the DIGITAL-IN RIGHT AUDIO INPUT.
- The Digital-In terminal can only be used with 1080i, 720p and 480p picture signals. Set the DTV decode digital-out terminal output setting to 1080i, 720p or 480p. For detailed information, refer to the DTV decoder instruction manual. If you can not display the picture because your DTV decoder does not have a digital-out terminal output setting, use the component video input (or the S-Video input or video input). Refer to page 14. In this case the picture will be displayed as an analog signal.
 - The digital-in terminal is not compatible with the picture signal of a personal computer.
 - Use a DVI-D single link 19-pin cable (commercially available) in order to digitally connect the television with a DTV decoder.

If 480p signals (640x480 or 720x480) are displayed on the screen, the horizontal balance may be slightly shifted. In cases such as this, the horizontal balance can be adjusted by accessing "DIGITAL-IN" in the INITIAL SETUP menu. (Refer to page 51.)

Connecting to an AV Receiver using your television's V1 Smart Input

By connecting your AV Receiver to your television's V1 Smart Input, you can watch picture sources from many different devices, without having to change or use the other input connections on your TV. This allows you to free up the other input connections so you can connect more devices to your television.

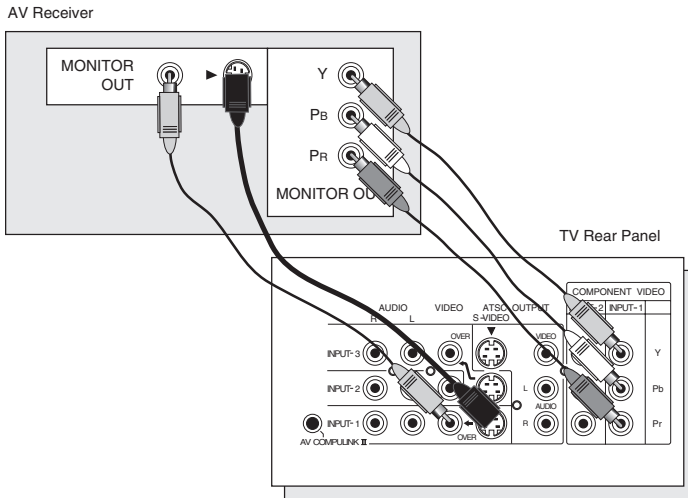

- 1) Connect an S-Video Cable from the AV Receiver's MONITOR OUT, to the S-Video INPUT-1 on the back of your television.
- 2) Connect a Yellow Composite Cable from the AV Receiver's MONITOR OUT, into the VIDEO INPUT-1 on the back of your television.
- 3) Connect a Green Component Cable from the AV Receiver's Y MONITOR OUT, into the Y VIDEO INPUT-1 on the back of your television.
- 4) Connect a Blue Component Cable from the AV Receiver's Pb MONITOR OUT, into the Pb VIDEO INPUT-1 on the back of your television.
- 5) Connect a Red Component Cable from the AV Receiver's Pr MONITOR OUT, into the Pr VIDEO INPUT-1 on the back of your television.

Note:

- Please refer to your AV Receiver instruction manual for more information on connecting your speakers and other devices like a DVD player.
- Use your AV Receiver's remote to switch to the different devices you have connected.
- Some AV Receivers may not respond when the V1 Smart Input function is turned on.
- If you have video connections for each input device connected to your AV Receiver, you should not connect them using both S-Video and Composite connection at the same time when you are using V1 Input as the V1 Smart Input. In this case we recommend using the S-Video connection.

Connecting an iLINK compatible device to the back of your television

i.LINK is a digital series interface that allows devices equipped with an i.LINK connector to exchange digital video signals, digital audio signals and device control signals bi-directionally over a single cable. (For example, a JVC D-VHS VCR).

i.LINK refers to the IEEE1394-1995 industry specification and extensions thereof. The  logo is used for products compliant with the i.LINK standard.

This projection television uses a four-pin i.LINK connector to input and output MPEG2 video signals, audio signals and control signals.

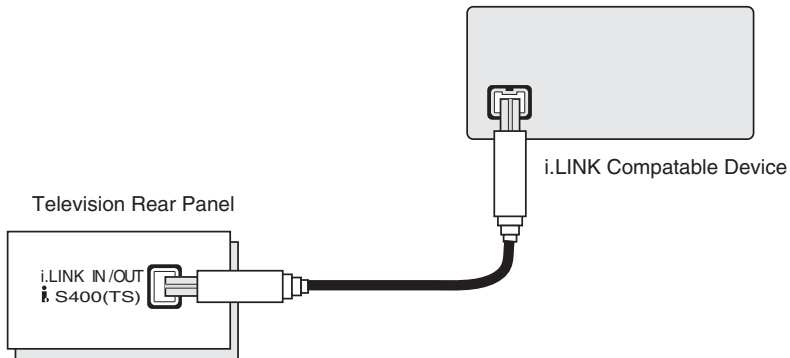

- 1) Connect the i.LINK cable from the back of the television to the back of the i.LINK compatible device.

Notes:

- Use only the S400 i.LINK cable when connection your devices.
- See page 69 on how to select the i.LINK device.
- Refer to your owners manual on using your i.LINK device.
- When recording or playing back video with an iLink device, if you perform the Auto Tuner Setup, the video signal you are recording or playing back may stop or you may not be able to perform the Digital Auto Tuner Setup.

Step 3 – The Interactive Plug In Menu

When you turn your television on for the first time the interactive plug-in menu will appear. The plug-in menu helps you to get your TV ready to use by letting you set your preferences for:

- The language in which you want the onscreen menus to appear.
- Setting the TV's clock to the correct time so your timer functions will work properly. You can choose "AUTO" or "MANUAL" for setting the clock.
- The auto tuner setup of which channels you wish to receive. You can set up using Analog Auto Tuner Setup (Analog broadcasting) and Digital Auto Tuner Setup (Digital broadcasting).

We recommend you complete the interactive plug-in items before you start using your television.

Language

After the "JVC INTERACTIVE PLUG IN MENU" has been displayed, the TV automatically switches to the LANGUAGE settings. You can choose to view your onscreen menus in three languages: English, French (Français) or Spanish (Español).

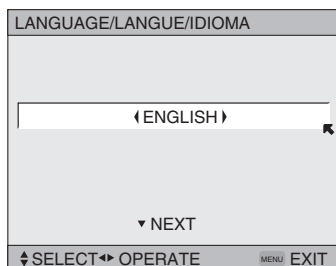

To choose a language:
(ENGLISH, FRANÇAIS or ESPAÑOL)



To NEXT (To set clock)

(To be continued...)

Auto Clock Set

Before you use any of your TV's timer functions, you must first set the clock. You may precisely set your clock using the XDS time signal broadcast by most public broadcasting stations. If you do not have this in your area, you will have to set the clock manually. See manual clock set below. To set the clock using the XDS signal:

- ◀▶ To choose AUTO
- ▼ To TIME ZONE
- ◀▶ To select your time zone: (Atlantic, Eastern, Central, Mountain, Pacific, Alaska or Hawaii)
- ▼ To move to D.S.T. (Daylight Savings Time)
- ◀▶ To turn D.S.T. ON or OFF
- ▼ To NEXT (To Auto Tuner Setup)

Notes:

- The Daylight Savings Time feature automatically adjusts your TV's clock for Daylight Savings. The clock will move forward one hour at 2:00 am on the first Sunday in April. The clock will move back one hour at 2:00 am on the last Sunday in October.
- You will have to reset the clock after a power interruption. You must set the clock before operating any timer functions.

Manual Clock Set

To set your clock manually (without using the XDS signal), choose MANUAL. If you choose AUTO, see auto clock set above.

- ◀▶ To choose MANUAL
- ▼ To TIME
- ◀▶ To set the hour
- ▼ To minute
- ◀▶ To set the minute
- ▼ To TIME ZONE
- ◀▶ To select your time zone: (Atlantic, Eastern, Central, Mountain, Pacific, Alaska or Hawaii)
- ▼ To move to D.S.T. (Daylight Savings Time)
- ◀▶ To turn D.S.T. ON or OFF
- ▼ To Start Clock

Note:

- You will have to reset the clock after a power interruption. You must set the clock before operating any timer functions.
- When you set the TIME ZONE and D.S.T manually, they are used as the setting for the EPG.

(To be continued...)

Auto Tuner Setup

In auto tuner setup, the TV automatically scans through all available channels, memorizing the active ones and skipping over blank ones or channels with weak signals. This means when you scan (using the CHANNEL +/- buttons) you will receive only clear, active channels. There are two tuner modes to choose from, ANALOG or DIGITAL.

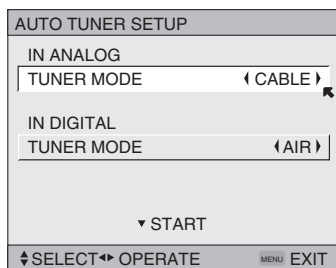

- ◀▶ To choose CABLE or AIR (or SKIP when you skip Analog Auto Tuner Setup)
- ▲▼ To ATSC
- ◀▶ To choose CABLE or AIR (or SKIP when you skip Digital Auto Tuner Setup)
- ▼ To START

After Analog Auto Tuner Setup is finished, Digital Auto Tuner Setup starts.



When the setup is finished, THANK YOU!! SETUP IS NOW COMPLETE is displayed. Your quick setup is now complete. You can now begin watching your television, or you can continue in this guide for more information on programming your remote control, or using the JVC onscreen menu system to customize your television viewing experience.

Notes:

- If you want to cancel the Auto Tuner Setup, press the MENU button.
- Noise muting will not work during Auto Tuner Setup.
- Skip appears only for interactive plug-in menu. If you choose SKIP, it finished without doing the Auto Tuner Setup.
- The interactive plug-in menu setting does not appear if your TV has been turned on before. In this case, use the menu to perform these settings. See pages 43, 57 and 33.

Cable Box and Satellite Users: After your auto tuner setup is complete, you may, (depending on the type of hookup), have only 1 channel, usually 3 or 4 in the auto tuner memory. This is normal.



The Quick Setup is complete

Remote Programming

Setting the CATV, VCR and DVD Codes

You can program your remote to operate your cable box, satellite receiver, VCR or DVD player by using the instructions and codes listed below. If the equipment does not respond to any of the codes listed below or to the code search function, use the remote control supplied by the manufacturer.

Cable Box or Satellite Codes

The remote control is programmed with cable box and satellite codes for power on/off, channel up/down, and 10 key operation.

- 1) Find the cable box or satellite brand from the list of codes shown below.
 - 2) Slide the 2-way selector switch to "CATV".
 - 3) Press and hold down the DISPLAY button, then enter the first code number listed with the 10 key pad.
 - 4) Release the DISPLAY button, and confirm the operation of the cable box/satellite receiver.
- If your cable or satellite box does not respond to the first code, try the others listed. If it does not respond to any code, try the search codes function, on page 29.

Cable Box	Codes	Cable Box	Codes	Digital Satellite Systems	Codes
ABC	024	Puser	032	Digital Satellite Systems	
Archer	032, 025	RCA	061, 070		
Cableview	051, 032	Realistic	032		
Citizen	022, 051	Regal	058, 064, 040, 041, 042, 045, 068		
Curtis	058, 059				
Diamond	024, 032, 025	Regency	034		
Eagle	029	Rembrandt	037, 032, 051, 038		
Eastern	034				
GC Brand	032, 051	Samsung	051		
Gemini	022, 043	Scientific Atlanta	057, 058, 059		
General Instrument/Jerrol	065, 024, 025, 026, 027, 020, 021, 022, 057, 023, 072, 074	SLMark	051, 047		
		Sprucer	051, 056		
Hamlin	040, 041, 042, 045, 058, 064	Stargate	032, 051		
		Telecaption	067		
Hitachi	049, 024	Television	047, 051		
Macom	049, 050, 051, 054	Texscan	044		
		Tocom	035, 036, 066, 074		
Magnavox	033	Toshiba	050, 048		
Memorex	030	Unika	032, 025		
Movietime	032, 051	Universal	022, 032		
Oak	039, 037, 048	Videoway	052		
Panasonic	055, 056, 060, 071, 073	Viewstar	029, 030		
		Zenith	063, 046		
Paragon	063	Zenith/Drake Satellite	046		
Philips	028, 029, 030, 052, 053, 031, 069				
Pioneer	047, 062				
Pulsar	051, 032				
				Hitachi	100, 113, 114, 115
				Express VU	100, 113
				G.E.	106
				G.I.	108, 120, 121, 122
				Gradiente	112
				Hitachi	104, 111
				HNS (Hughes)	104
				Magnavox	102, 103
				Panasonic	105
				Philips	102, 103, 116
				Primestar	108
				Proscan	106, 109, 110
				RCA	106, 109, 110
				Sony	107
				Star Choice	104, 108
				Toshiba	101, 104, 117, 118, 119
				Uniden	102, 103

Remote Programming

VCR Codes

The remote control is programmed with VCR codes for power on/off, play, stop, fast-forward, rewind, pause, record, channel up/down operation.

- 1) Find the VCR brand from the list of codes shown below.
 - 2) Slide the first 2-way selector switch to "TV" and the other 2-way selector switch to "VCR".
 - 3) Press and hold down the DISPLAY button, then enter the first code number listed with the 10 key pad.
 - 4) Release the DISPLAY button, and confirm the operation of the VCR.
- If your VCR does not respond to the first code, try the others listed. If it does not respond to any of the codes, try the search codes function on page 29.
 - After you program your remote, some VCR buttons may not work properly. If so, use the VCR's remote.
 - To record, hold down the REC button on the remote and press PLAY.

VCR	Codes	VCR	Codes	VCR	Codes
Admiral	035	Marantz	003, 004, 005	Samsung	037, 060, 062, 033, 089
Aiwa	027, 032, 095	Marta	064		
Akai	029, 072, 073, 074	Memorex	024, 067	Samtron	089
Audio Dynamic	003, 005	MGA	038, 040, 047, 048, 041, 042	Sansui	003, 026, 020, 052
		Minolta	058, 045, 093	Sanyo	063, 067, 091, 071
Bell & Howell	063, 071	Mitsubishi	038, 040, 047, 048, 041, 042, 078, 090	Scott	059, 060, 062, 067, 038, 040, 047, 048, 026, 020
Broksonic	020, 026, 094	Multitech	047, 027, 062		
Canon	023, 025	NEC	003, 004, 005, 000	Sears	063, 064, 065, 066, 058
CCE	043	Olympic	024, 023	Sharp	035, 036, 080, 088
Citizen	064	Optimus	028, 021, 035, 064	Shintom	075
Craig	063, 029, 064	Orion	026, 020	Signature 2000	027, 035
Curtis Mathes	045, 024, 027, 093	Panasonic	023, 024, 021, 022	Singer	075
Daewoo	043, 059, 024, 092	Penney	024, 058, 045, 063, 003, 004, 005, 093	Sony	028, 029, 030, 053, 054, 055
DBX	003, 004, 005			Pentax	058, 005, 045, 093
Dimensia	045, 093	Philco	031, 024, 027, 023, 026, 020, 043	Sylvania	031, 023, 024, 027
Emerson	043, 026, 077, 061, 025, 042, 020, 076	Philips	031, 023, 024, 086	Symphonic	027, 081
Fisher	063, 066, 067, 065, 071, 091			Pioneer	023
Funai	027, 026, 020, 000	Proscan	045, 058, 023, 024, 031, 046, 059, 060, 093, 033, 087	Tatung	003, 004, 005
G.E.	033, 045, 024	Quasar	021, 022, 023, 024	Teac	003, 004, 027, 005
Go Video	037, 051, 049, 050, 089	Radio Shack	033, 024, 063, 036, 067, 040, 027	Technics	021, 022, 023, 024
Goldstar	064	RCA	033, 045, 058, 023, 024, 031, 046, 059, 060, 083, 084, 085, 087, 093, 096	Teknika	024, 027, 070
Gradiente	083, 084, 081, 000, 001			Realistic	024, 063, 036, 067, 040, 027
Hitachi	023, 045, 058, 093, 027, 081	Wards		Toshiba	059, 046, 079
Instant Replay	024, 023			Vector Research	005
Jensen	003	Yamaha		Yamaha	063, 003, 004, 005
JVC	003, 004, 005, 000, 001, 002, 006, 007			Zenith	044, 082, 064, 094
Kenwood	003, 004, 064, 005				
LG	064				
LXI	027, 064, 058, 065, 066, 063, 067				
Magnavox	031, 023, 024, 086				

Remote Programming

DVD Codes

The remote control is programmed with DVD codes for power on/off, play, stop, fast-forward, rewind, previous/next chapter, tray open/close, and still/pause operation.

- 1) Find the DVD player brand from the list of codes shown below.
 - 2) Slide the first 2-way selector switch to "TV" and the other 2-way selector switch to "DVD".
 - 3) Press and hold down the DISPLAY button, then enter the first code number listed with the 10 key pad.
 - 4) Release the DISPLAY button, and confirm the operation of the DVD player.
- If your DVD player does not respond to the first code, try the others listed. If it does not respond to any of the codes, try the search codes function on page 29.
 - After you program your remote, some DVD buttons may not work properly. If so, use the DVD player's remote.

DVD Player	Codes	DVD Player	Codes	DVD Player	Codes
Aiwa	043	Mintek	057	Sharp	028
Apex	040, 054, 055	Mitsubishi	025	Sylvania	038
Bose	058	Next Base	056	SMC	048
Denon	020, 037	Onkyo	041, 052	Sony	024, 045, 046, 047
Funai	038	Oritron	044	Technics	020
Go-Video	032	Panasonic	020	Thomson	021
Harman Kardon	053	Philips	023, 036	Toshiba	023
Hitachi	031	Pioneer	022	Venturer	051
JVC	000	Polk Audio	036	Vialta	050
Kenwood	035, 020	Raite	033	Wave	042
KLH	051	RCA	021, 026	Yamaha	020, 049
Konka	039	Sampo	034	Zenith	027, 032
Koss	050	Samsung	030		

Remote Programming

Search Codes

Cable/Satellite Search Codes Function

- 1) Slide the first 2-Way Mode Selector switch to CATV.
- 2) Press and hold down the POWER button, then press the RETURN+/TV button for more than three seconds.
- 3) Release the RETURN+/TV button, then release the POWER button.
- 4) Press the POWER button on the remote, and see if the cable or satellite box responds.
- 5) If there was a response, press RETURN+/TV. The codes are now set. If there was no response, repeat Step 4. If you repeat Step 4 a total of 80 times without a response, use the remote control that came with your equipment.
- 6) Press RETURN+/TV to exit.

VCR/DVD Search Codes Function

- 1) Slide the first 2-way selector switch to "TV" and the other 2-way selector switch to "VCR" or "DVD".
- 2) Press and hold down the VCR or DVD POWER button, then press the RETURN+/TV button for more than three seconds.
- 3) Release the RETURN+/TV button, then release the VCR or DVD POWER button.
- 4) Press the VCR or DVD POWER button, and see if the VCR or DVD responds.
- 5) If there was a response, press RETURN+/TV. The codes are now set. If there was no response, repeat Step 4. If you repeat Step 4 a total of 80 times for the VCR (40 times for the DVD player), and there is no response, use the remote control that came with your equipment.
- 6) Press RETURN+/TV to exit.

Onscreen Menus

Using the Guide

Certain symbols are used throughout this guide to help you learn about the features of your new television. The ones you will see most frequently are:

- ▲▼ Up and Down arrows mean press the CH+ or CH- buttons. Pressing the CH+ or CH- buttons let you:
 - Move vertically in a main menu screen
 - Move through a submenu screen
 - Move to the next letter, number, or other choice in a submenu
 - Back up to correct an error
 - Scan through TV channels (when not in a menu screen)
- ◀▶ Left and right arrows mean press the VOLUME+ or VOLUME- buttons to move left or right to:
 - Select a highlighted menu item
 - Select an item in a submenu
 - Select numbers in certain menu options
 - Turn the volume up or down (when not in a menu screen)
-  The “press button” icon means you should press the button named on your remote control. (Button names appear in SMALL CAPITAL LETTERS.)
- The “helping arrow” icon points to the highlighted or selected item in a menu.

To bring up the onscreen menu, press the MENU button on the remote control. The item that appears in green is the one currently selected. If you use the Menu button on the TV's front panel instead of the remote, an additional menu screen showing INPUT and ASPECT will appear between INITIAL SETUP and PICTURE ADJUST. The “interactive plug-in menu” will appear the first time the TV is plugged in.

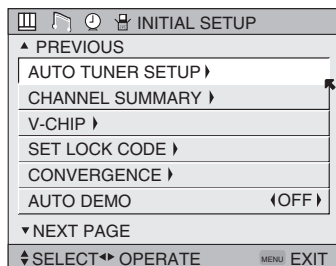

Note:

- Menus shown in this book are illustrations, not exact replications of the television's onscreen displays.

Onscreen Menus

The Onscreen Menu System

Your television comes with JVC's onscreen menu system. The onscreen menus let you make adjustments to your television's operation simply and quickly. Examples of the onscreen menus are shown on the next page. Detailed explanations on using each menu follow later in this guide. For information about the interactive plug-in menu, see pages 23 - 25.

The Onscreen Menu System

To open the onscreen menu system, press the MENU button on the remote control. You navigate within the onscreen menu by using the four directional arrow buttons on the remote control. (These buttons are also the CH +/- and VOL +/- buttons. Channel and volume functions will not operate when the onscreen menu is active).

The selected feature and option on a menu screen are highlighted in a different color.

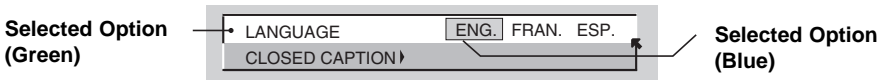

To move to a different feature use the ▲ ▼ arrows to move up or down the list. When you press the up arrow at the top of the list or the down arrow at the bottom, the next menu screen will appear. Use the arrows ◀ ▶ to select an option from the highlighted feature. Pressing MENU on the remote control will close the onscreen menu system and return you to normal television viewing.

Each menu and its features will be discussed in the following pages of this guide.

Notes:

- If you do not press any buttons for a few seconds, the onscreen menu will automatically shut off.
- Button names in this guide are shown in SMALL CAPITAL LETTERS.
- Menus may appear in different sizes onscreen depending on the aspect ratio selected.
- Some menu items may not appear in menu screens when certain aspect ratios or inputs are selected.

Onscreen Menus



Press the MENU button

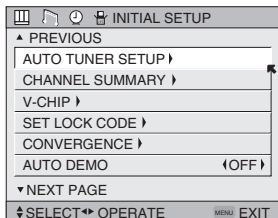
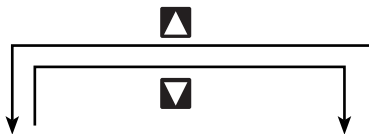

INITIAL SETUP 04

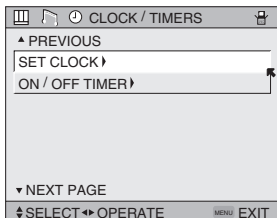

CLOCK/TIMERS

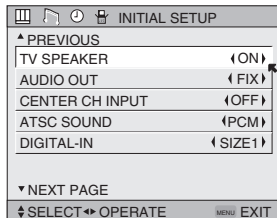

INITIAL SETUP 01

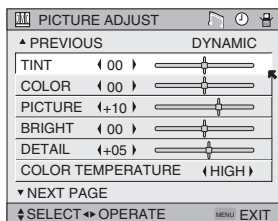

PICTURE ADJUST 01

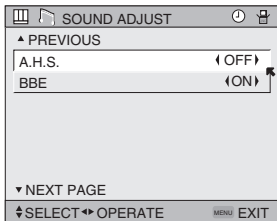

SOUND ADJUST 02

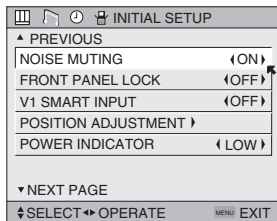

INITIAL SETUP 02

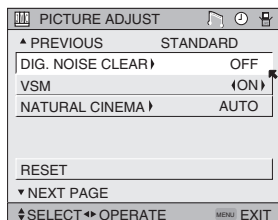

PICTURE ADJUST 02

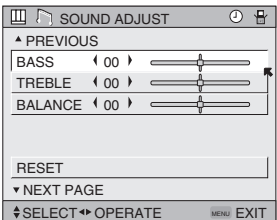
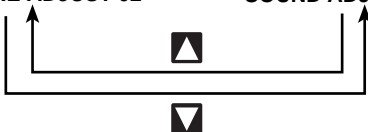

SOUND ADJUST 01

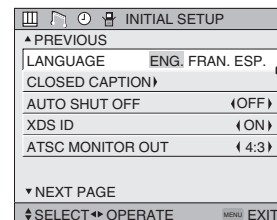

INITIAL SETUP 03



To INITIAL SETUP 04

Notes:

- The DIGITAL-IN menu can only be displayed when a 480p picture signal is input to the digital-in terminal and the picture is being displayed on the screen.
- When the Menu button on the TV front panel is pressed, the FRONT PANEL CONTROL menu between INITIAL SETUP 04 and PICTURE ADJUST 01 will appear.

Initial Setup

Auto Tuner Setup

The auto tuner setup function is described on page 25 as the interactive plug-in menu. If you need to run the auto tuner setup again, follow the steps below.



Press the MENU button



To AUTO TUNER SETUP



To operate



To choose ANALOG TUNER MODE or DIGITAL TUNER MODE



To choose CABLE or AIR



Press the Ok button to start

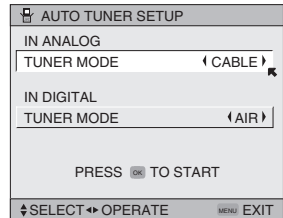

Programming will take approximately 2 to 4 minutes. The auto tuner is finished when the message **PROGRAMMING OVER!** appears onscreen.



Press the Menu button when finished

Channel Summary

Channel summary allows you to customize the line-up of channels received by your TV. You can add or delete channels from the line-up or prevent any unauthorized viewers from watching any or all 181 channels.



Press the MENU button



To CHANNEL SUMMARY



To operate

The channel summary screen will now be displayed with the channels set to scan marked with an "✓". You can delete channels from the scan by removing the "✓". If any channels were missed during auto tuner setup and you wish to add them, you may be placing an "✓" next to the channel number.



To the SCAN column



Press the Ok button to include or delete from scan



Press the MENU button when finished

You can block access to a channel by activating the channel lock.



Press the MENU button



To CHANNEL SUMMARY



To operate



To the Lock Column ()



Press the ZERO button to lock or unlock that channel



Press the MENU button when finished

Analog Channels

CHNO.	SCAN	Lock	CHNO.	SCAN	Lock
01			06	✓	
02	✓		07	✓	
03			08		
04	✓		09	✓	
05	✓		10		

Digital Channels

CHNO.	SCAN	Lock	CHNO.	SCAN	Lock
(D 01)			(D 06)	✓	
(D 02)	✓		(D 07)	✓	
(D 03)			(D 08)		
(D 04)	✓		(D 09)	✓	
(D 05)	✓		(D 10)		

Initial Setup

Channel Guard Message

When a viewer attempts to watch a guarded channel, the following message appears:

To watch a channel that you have locked, enter the Lock Code using the 10 key pad.

If the wrong code is entered, the message "INVALID LOCK CODE!" will flash on the screen.

The channel cannot be accessed until the correct code is entered.

THIS CHANNEL IS LOCKED BY
CHANNEL GUARD.
PLEASE ENTER LOCK CODE BY
10 KEY PAD TO UNLOCK IT.

NO. - - - -

Notes:

- Once a channel has been unlocked, it will remain unlocked until the television is turned off.
- See also "Set Lock Code", page 40.

V-Chip

Your TV is equipped with V-Chip technology which enables you to block channels or content that you feel to be inappropriate for children, based on US and Canada rating guidelines. V-Chip has no effect on video signals from a DVD discs, VCR tapes or Camcorder connection.

Note: Some programs, and movies are broadcast without a ratings signal. Even if you set up V-CHIP ratings limits, these programs will not be blocked. See page 35 for information on how to block unrated programs.

You can customize the V-Chip settings of your television to match your personal tastes. The V-Chip menu below is the starting point for your V-Chip settings

You can use US V-Chip settings (for programming broadcast from the United States), Canadian V-Chip settings (for programming broadcast from Canada), and movie ratings. You may use any or all of the settings (US V-Chip, Canada V-Chip, Movie ratings). Descriptions for setting each of the three V-Chip formats appear in the next six pages along with descriptions of the rating categories.

To access the rating categories:



Press the MENU button



To V-CHIP



To operate (Lock icon  will appear)



Press ZERO to access the V-Chip menu



To turn V-Chip ON or OFF (V-Chip must be turned ON for rating settings to operate)



To move to SET US TV RATINGS, SET MOVIE RATINGS, or SET CANADIAN RATINGS (see following pages for descriptions of each item)

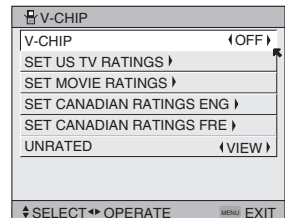

Initial Setup

Unrated Programs

Unrated programming refers to any programming which does not contain a rating signal. Programming on television stations which do not broadcast rating signals will be placed in the "Unrated Programming" category.

Examples of Unrated programs:

- Emergency Bulletins
- News
- Public Service Announcements
- Sports
- Some Commercials
- Locally Originated Programming
- Political Programs
- Religious Programs
- Weather

Note:

- TV programs or movies that do not have rating signals will be blocked if the unrated category is set to BLOCK.

Directions to Block Unrated Programs

You can block programs that are not rated.



Press the MENU button



To V-CHIP



To operate (The lock icon  appears)



Press ZERO to access V-Chip setup options



To UNRATED



To VIEW or BLOCK



Press MENU when done

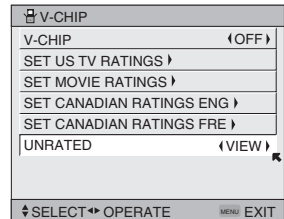

Initial Setup

US V-Chip Ratings

U.S. PARENTAL RATING SYSTEMS

Programs with the following ratings are appropriate for children.

TV Y is Appropriate for All Children

Programs are created for very young viewers and should be suitable for all ages, including children ages 2 - 6.

TV Y7 is for Older Children

Most parents would find such programs suitable for children 7 and above. These programs may contain some mild fantasy violence or comedic violence, which children should be able to discern from reality.

Programs with the following ratings are designed for the entire audience.

TV G stands for General Audience

Most parents would find these programs suitable for all age groups. They contain little or no violence, no strong language, and little or no sexual dialog or situations.

TV PG Parental Guidance Suggested

May contain some, but not much, strong language, limited violence, and some suggestive sexual dialog or situations. It is recommended that parents watch these programs first, or with their children.

TV 14 Parents Strongly Cautioned

Programs contain some material that may be unsuitable for children under the age of 14 including possible intense violence, sexual situations, strong coarse language, or intensely suggestive dialog. Parents are cautioned against unattended viewing by children under 14.

TV MA Mature Audiences Only

These programs are specifically for adults and may be unsuitable for anyone under 17 years of age. TV MA programs may have extensive V, S, L, or D.

Viewing Guidelines

In addition to the ratings categories explained above, information on specific kinds of content are also supplied with the V-Chip rating. These types of content may also be blocked. The content types are:

- **V/FV** is for VIOLENCE/FANTASY VIOLENCE
- **S** stands for SEXUAL CONTENT
- **L** stands for strong LANGUAGE
- **D** stands for suggestive DIALOG

Initial Setup

Setting US V-Chip Ratings



Press the MENU button



To V-CHIP



To operate (lock icon  appears)



Press ZERO to access the V-Chip menu



To turn V-Chip ON or OFF





To move to SET US TV RATINGS

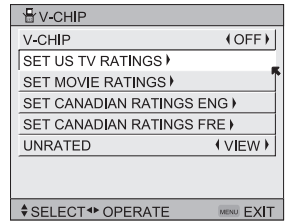

To operate



Directions to set US V-Chip Ratings

Line up the cursor in the column (TV PG, TV G, etc.) with the content row (V/FV, S, etc.) and press the  or  to move the cursor to the correct location. Press Ok to turn the locking feature on or off. An item is locked if the  icon appears instead of a “—”.

For example. To block viewing of all TV 14 shows, move the cursor to the top row of that column and add a lock icon. Once you've put a lock on the top row, everything in that column is automatically locked.



To the TV 14 Column



Press the Ok button to lock



Press the MENU button when finished

Note:

- If you want to change the setup, move the cursor to the top column and change the lock icon to “—” by pressing OK again. You may then select individual categories to block.

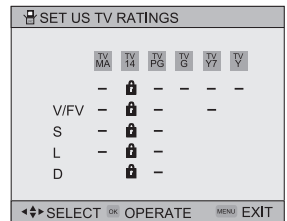

Initial Setup

Movies Ratings

❑ NR – Not Rated

This is a film which has no rating. In many cases these films were imported from countries which do not use the MPAA ratings system. Other NR films may be from amateur producers who didn't intend to have their film widely released.

NR (Not Rated) Programming may contain all types of programming including children's programming, foreign programs, or adult material.

❑ G – General Audience

In the opinion of the review board, these films contain nothing in the way of sexual content, violence, or language that would be unsuitable for audiences of any age.

❑ PG – Parental Guidance

Parental Guidance means the movie may contain some contents such as mild violence, some brief nudity, and strong language. The contents are not deemed intense.

❑ PG-13 – Parents Strongly Cautioned

Parents with children under 13 are cautioned that the content of movies with this rating may include more explicit sexual, language, and violence content than movies rated PG.

❑ R – Restricted

These films contain material that is explicit in nature and is not recommended for unsupervised children under the age of 17.

❑ NC-17 – No One Under 17

These movies contain content which most parents would feel is too adult for their children to view. Content can consist of strong language, nudity, violence, and suggestive or explicit subject matter.

❑ X – No One under 18

Inappropriate material for anyone under 18.

Directions to set Movie (MPAA) Ratings



Press the MENU button



To V-CHIP



To operate (Lock icon  appears)



Press ZERO to access V-Chip setup options



To SET MOVIE RATINGS



To enter movies menu

For example:

To block viewing of X and NC-17 rated from shows:



To the X Column



Press the Ok button to lock



To the NC-17 Column



Press the Ok button to lock



Press the MENU button to finish

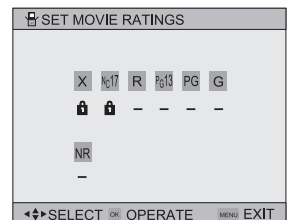

Canadian V-Chip Ratings

❑ E – Exempt

Exempt programming includes: news, sports, documentaries and other information programming, talk shows, music videos, and variety programming.

❑ C – Programming Intended for Children

Violence Guidelines: There will be no realistic scenes of violence. Depictions of aggressive behavior will be infrequent and limited to portrayals that are clearly imaginary, comedic or unrealistic in nature.

❑ C8+ – Programming Intended for Children 8 and Over

Violence Guidelines: Any realistic depictions of violence will be infrequent, discreet, of low intensity and will show the consequences of the acts. There will be no offensive language, nudity or sexual content.

❑ G – General Audience

Programming will contain little violence and will be sensitive to themes which could affect younger children.

❑ PG – Parental Guidance

Programming intended for a general audience, but which may not be suitable for younger children. Parents may consider some content not appropriate for children aged 8-13.

❑ 14+ – 14 Years and Older

Parents are strongly cautioned to exercise discretion in permitting viewing by pre-teens and early teens. Programming may contain mature themes and scenes of intense violence.

❑ 18+ – Adult

Material intended for mature audiences only.

Directions to set Canadian V-Chip Ratings



Press the MENU button



To V-CHIP



To operate (lock icon  appears)



Press ZERO to access V-Chip setup options



To SET CANADIAN RATINGS ENG (for English)



To enter ratings menu

For example:

To block viewing of programming rated 14+ and 18+:



To the 18+ Column



Press the Ok button to lock



To the 14+ Column



Press the Ok button to lock



Press the MENU button to finish

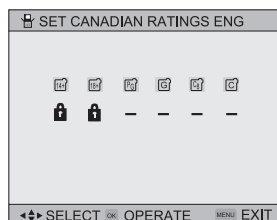

Initial Setup

Set Lock Code

Channel guard and V-Chip settings are protected by a four-digit lock code. Your TV comes preset with a lock code of "0000". You may change the code to any four-digit number you wish. To change the lock code, follow the steps below.



Press the MENU button



To SET LOCK CODE



To operate (lock icon  appears)



Press ZERO to access the lock code

The first digit will be highlighted



To select the number



To move to the next digit

Continue to follow these directions for all four numbers



Press the Ok button to finish (your lock code is now set)



Press the MENU button when finished

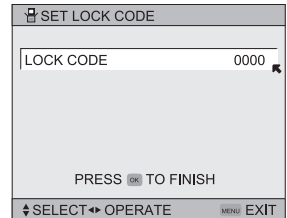

When a viewer attempts to watch a blocked channel, this message appears:

THIS PROGRAM EXCEEDS
YOUR RATING LIMITS.
PLEASE ENTER LOCK CODE BY
10 KEY PAD TO UNLOCK
NO. - - - -

The channel will remain blocked until the correct lock code is entered (see above for information on setting your lock code).

Notes:

- After a power interruption you must reset the lock code.
- Write your lock code number down and keep it hidden from potential viewers.
- If you forget the lock code, a new code may be set using the steps listed above.

Initial Setup

Adjusting CRT Color Convergence

This TV has three color projection tubes: one for red, green, and blue. When mixed together in the proper portions, the output of these three color tubes can produce any color. To produce these colors, however, the beams must be precisely aligned over each other so that the colors can be mixed. The process of aligning these picture beams is called "convergence".

Attention:

- Please have your TV on for at least 20 minutes before using this feature.
- This adjustment will be needed only when the colors of the characters/lines are separated and lack in distinction. If not, please don't perform the adjustment.

Colors may become separated after the TV has been moved, or over a long period of time if regularly subjected to low levels of vibrations. If the colors become separated, please perform the adjustments below again. **In the beginning, please be sure to perform AUTO convergence adjustment.**

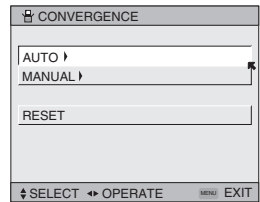

Auto



Press the MENU button



To CONVERGENCE



To Enter



To select "AUTO" (*The convergence adjustment will start. It will take about 50 seconds.*)

When the adjustment is finished, it will return to what you were watching.

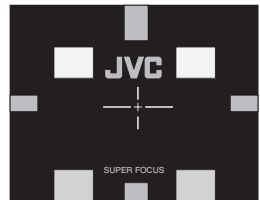

Note:

- You can reset the adjustment if you do not like the results. See the next page.
- If you want to adjust it more, you can perform the manual color convergence adjustment. See the next page.
- You can also access this feature by pressing the SUPER FOCUS button on the front panel of your TV.

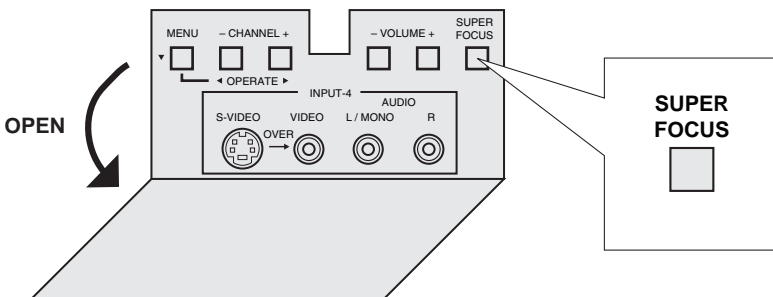

Initial Setup

Adjusting CRT Color Convergence (continued...)

Manual



Press the MENU button



To CONVERGENCE



To enter



To choose MANUAL



To enter

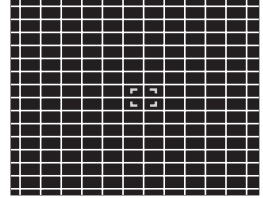

If all the lines are white, no convergence adjustment is necessary. If not, you need to perform the manual color convergence below.



Select the location you want to adjust by using the number buttons on the remote control.

You can select any of the 63 points.

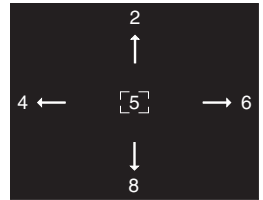

Press the SELECT button to change the color of the box [] to the color of the cross you wish to adjust (red or blue).



Adjust the position of the cross.

Adjust the three color crosses until they overlap and appear as a single white cross.



Press the Ok button

Notes:

- When you adjust the convergence, make sure you start with the center position (position 5), and work your way around radially for best results.
- When you make the adjustment in the center (position 5), you are making the adjustment for the whole screen. In other positions, you are making the adjustment only in that area.
- You can reset the adjustment if you do not like the results. See below.
- If you perform AUTO CONVERGENCE after performing MANUAL CONVERGENCE, your manual convergence you performed will be cancelled.

Reset

RESET resets all convergence adjustments to the factory default settings.



Press the MENU button



To CONVERGENCE



To enter



To RESET



To enter

When the adjustment is reset, it will return to what you were watching.

Initial Setup

Auto Demo

Your TV is equipped with D.I.S.T 1500i. This feature allows you to view the demonstration in picture quality with D.I.S.T 1500i on or off.



Press the MENU button



To AUTO DEMO



To turn AUTO DEMO ON
(The Auto Demo starts.)

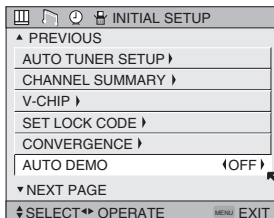

(appears for three minutes)

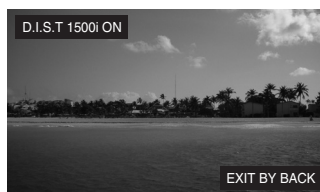

(appears for one minute)

To stop AUTO DEMO



Press the BACK button

Language

The language function is described on page 23 as the interactive plug-in menu. If you need to choose the language again, follow the steps below.



Press the MENU button



To LANGUAGE



To choose a language: ENG. (English), FRAN.
(French) or ESP. (Spanish)



Press the MENU button when finished

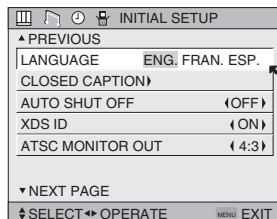









Initial Setup

Closed Caption







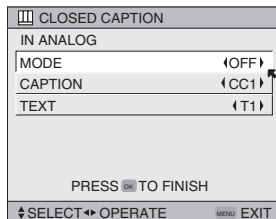

Many broadcasts now include an onscreen display of dialog called closed captions. Some broadcasts may also include displays of additional information in text form. Your television can access and display this information using the closed caption feature. To activate the closed caption feature, follow the steps below. There are three methods.

Analog Setting

-  Press the MENU button
-  To CLOSED CAPTION
-  To enter
-  To MODE
-  To select CAPTION, TEXT or OFF
-  To CAPTION or TEXT
-  To select a caption (CC1 to CC4) or text channel (T1 to T4)
-  Press the Ok button to save
-  Press the MENU button when finished



Digital Auto Setting

-  Press the MENU button
-  To CLOSED CAPTION
-  To enter
-  To SERVICE TYPE
-  To select 1, 2, 3, 4, 5, 6 or OFF
-  To CC DISPLAY
-  To select AUTO
-  Press the Ok button to save
- The font/type and color are set automatically.*
-  Press the MENU button when finished

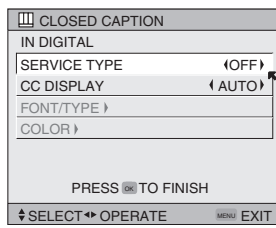

Note:

- You cannot select the FONT/TYPE when you select AUTO mode.

Initial Setup

Digital Manual Setting



Press the MENU button



To CLOSED CAPTION



To enter



To SERVICE TYPE



To select 1, 2, 3, 4, 5, 6 or OFF



To CC DISPLAY



To select MANUAL



To FONT/TYPE



To enter



To select FONT SIZE, FONT STYLE, ITALIC, UNDERLINE, BOLD or POSITION



To select the setting you like

FONT SIZE: DEFAULT, STANDARD, SMALL, LARGE

FONT STYLE: DEFAULT, SERIF MONO, SERIF,
 SANS MONO, SANS, CASUAL,
 CURSIVE, SMALL CAPITAL

ITALIC, UNDERLINE, BOLD: YES or NO

POSITION: DEFAULT or BOTTOM



Press the Ok button to save



To COLOR



To enter



To select TEXT COLOR, TEXT OPACITY, BKGND
COLOR (Background Color) or BKGND OPACITY
(Background Opacity)



To select the setting you like

TEXT COLOR, BKGND COLOR:

DEFAULT, BLACK, WHITE, RED, GREEN, BLUE, YELLOW, MAGENTA or CYAN

TEXT OPACITY, BKGND OPACITY:

DEFAULT, SOLID, TRANSPARENT, TRANSLUCENT or FLASHING



Press the Ok button to save



Press the MENU button when finished

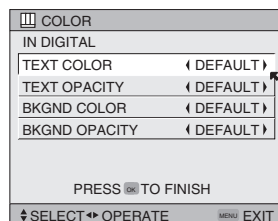
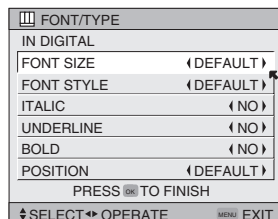
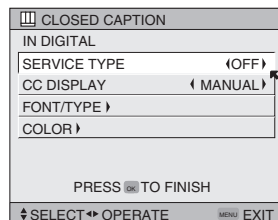

Notes:

- Closed caption subtitles are usually found on closed caption channel CC1. Some programs may include additional text information which is usually found on text channel T1. The other channels are available for future use.
- Closed captioning may not work correctly if the signal being received is weak or if you are playing a video tape.
- Most broadcasts containing closed captioning will display a notice at the start of the program.
- When you have DEFAULT selected: Font Size is "Standard", Text Color is "White", Text Opacity is "Solid", Background Color is "Black", Background Opacity is "Solid".

Initial Setup

Auto Shut Off

This function automatically shuts off your TV when there is no signal from the channel the TV is on.



Press the MENU button



To AUTO SHUT OFF



To turn ON or OFF



Press the MENU button when finished

- If the channel that you have on does not receive a signal for more than one minute, the blinking text "NOT RECEIVING A SIGNAL" appears on the screen, and starts the countdown. If no signal is being received within 10 minutes, the TV shuts itself off.

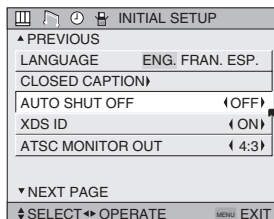

XDS ID

XDS ID Display provides a channel's call letters, the network's name, and even a program name. The XDS ID information is provided by the broadcaster.



Press the MENU button



To XDS ID



To turn ON or OFF



Press the MENU button when finished

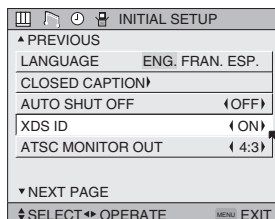

Initial Setup

ATSC Monitor Out

You can select the aspect mode for ATSC from 4:3 or 16:9.



Press the MENU button



To ATSC MONITOR OUT



To select 4:3 or 16:9



Press the MENU button when finished

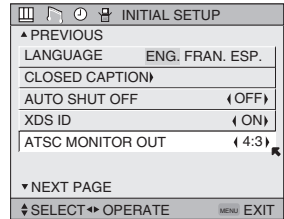

Notes:

- When you want to watch a program recorded in 16:9 mode, select "FULL" ratio. See page 65.
- Set the mode to 4:3 or 16:9 before you record a program using the ATSC MONITOR OUT.
- Make sure the mode you choose is the same as the TV's aspect ratio when the recorded program is played back, so that you can obtain a good picture quality, free from any unnatural distortions.

Noise Muting

This feature inserts a blank blue screen over channels which are not broadcasting or are too weak to be received clearly.



Press the MENU button



To NOISE MUTING



To turn noise muting ON or OFF



Press the MENU button when finished

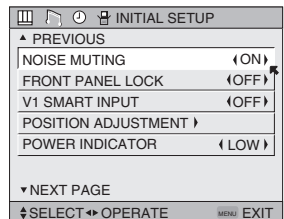

Note:

- Noise muting will not work during auto tuner setup or when you operate channel summary.

Initial Setup

Front Panel Lock

This allows you to lock the keys on the front of the TV, so that a child may not accidentally change your viewing preferences.



Press the MENU button



To FRONT PANEL LOCK
To turn ON or OFF



Press the MENU button when finished

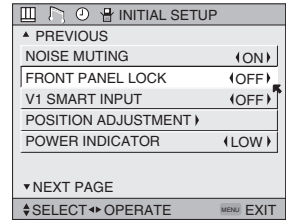

You can turn off this feature in the following ways:

- Unplug the power cord, and plug it back in. Do this if your batteries die, or you lose your remote control.
- Use the remote control.
- Press the MENU button on the front of the TV for more than 3 seconds. In this case, the OSD for FRONT PANEL LOCK will appear.

Note:

- To turn ON/OFF the TV, press the power button for more than 3 seconds. This feature will remain ON.

V1 Smart Input

This feature is used if you have connected an AV Receiver to your television. By turning this feature on, your television can automatically detect the signal source from your components that are connected to your AV Receiver.



Press the MENU button



To V1 SMART INPUT
To turn ON or OFF



Press the MENU button when finished

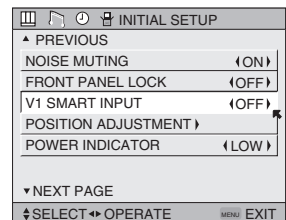

Notes:

- If you do not have an AV Receiver connected to your television, turn this feature OFF. By doing so, you can take advantage of using AV CompuLink components with your television.
- Some AV Receivers may not work with this function.

Initial Setup

Position Adjustment

Position adjustment allows you to adjust the position of the picture on the screen vertically when the aspect is set to panorama, cinema, or full.



Press the MENU button



To POSITION ADJUSTMENT



To enter



To adjust the position



Press the MENU button to finish

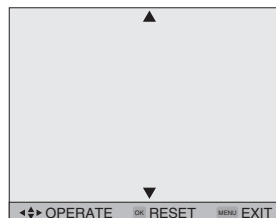

Notes:

- To reset the adjustment to the center, press the OK button.
- When the arrow disappears, while you are adjusting the position, the position is at its maximum limit.
- If you select regular size with aspect or Multi Screen, position adjustment option is not seen.
- When you change the screen size, perform the position adjustment again.
- Position adjustment allows you to adjust the screen position vertically and horizontally when the aspect is set to HD panorama or cinema zoom for 1080i signal.

Power Indicator

Power indicator allows you to adjust the brightness of the power indicator



Press the MENU button



To POWER INDICATOR



To adjust POWER INDICATOR LOW, HIGH or OFF

Notes :

- When OFF is selected :
The LED disappears if the you have a TV signal.
The LED is lit as "LOW" when there is no TV signal.

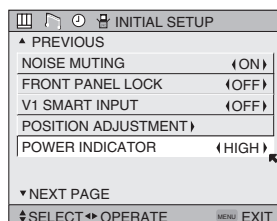

Initial Setup

TV Speaker

If your TV is connected to a stereo system, you can turn off the TV speakers and listen to the audio through your stereo.



Press the MENU button



To TV SPEAKER



To turn the TV's speakers ON or OFF



Press the MENU button when finished

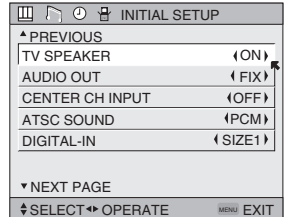

Notes:

- Before you turn the TV speaker setting from OFF to ON, **make sure that the TV volume level is low!** If the TV volume is set too high, the sound level will be extremely loud.
- After a power interruption, the TV speaker settings will return to "ON".

Audio Out

If your television is connected to an external speaker source, audio out gives you the option of controlling the volume level with your TV's remote control.



Press the MENU button



To AUDIO OUT



To VARI or FIX



Press the MENU button when finished

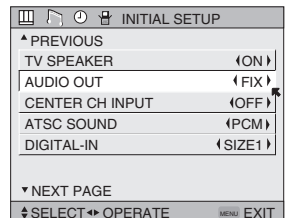

VARI: Lets you adjust the volume of the external speakers using the VOLUME +/- buttons on your TV's remote control.

FIX: The volume of the external speakers is adjusted using the audio device's remote control.

Center CH Input

When you are using a surround system, you can substitute the speaker of this television for the center speaker of your surround system. Set CENTER CH INPUT to on when you use the speaker as the center speaker of your surround system.



Press the MENU button



To CENTER CH INPUT



To adjust CENTER CH INPUT to "ON" or "OFF"



Press the MENU button when finished

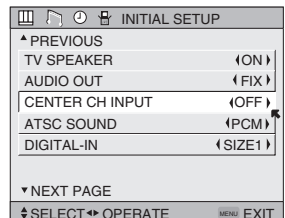

Initial Setup

ATSC Sound

You can select the optical digital sound output, either PCM or Dolby Digital when your TV is connected to an amplifier that has Dolby Digital decoder. If you select Dolby Digital, you can enjoy listening in 5.1ch sound when watching digital broadcasts.



Press the MENU button



To ATSC SOUND



To select PCM or DOLBY DIGITAL



Press the MENU button when finished

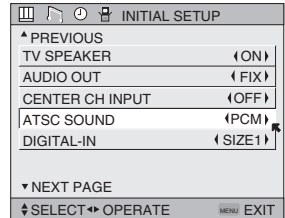

Notes:

- If your amplifier does not have Dolby Digital decoder, select PCM. If you don't select PCM, it cannot output the sound from the speakers.
- For connecting an amplifier using the optical output, see page 19.



Manufactured under license from Dolby Laboratories. "Dolby", and the double-D symbol are trademarks of Dolby Laboratories. Confidential unpublished works. Copyright 1992-1997 Dolby Laboratories. All rights reserved.

Digital-In

The DIGITAL-IN option can only be displayed in the INITIAL SETUP menu when a 480p picture signal is being input to the DIGITAL-IN terminal. This option adjusts the position when a 480p picture signal is being displayed on the screen. There are two types of 480p picture signals: 640x480 and 720x480. If the displayed picture is slightly shifted, the position can be adjusted by selecting either SIZE1 or SIZE2.



Press the MENU button



To DIGITAL-IN



To enter



To select SIZE1 or SIZE2



Press the MENU button when finished

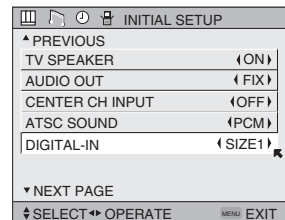

Note:

- The DIGITAL-IN menu can only be displayed when a 480p picture signal is input to the Digital-In terminal and the picture is being displayed on the screen.

Picture Adjust

Picture Settings

These settings allow you to change and adjust the way the picture appears on your television.

TINT

Tint allows you to adjust the levels of red and green in your TV picture.

COLOR

The color function lets you make all the colors in the TV picture appear either more vivid or subtle.

PICTURE

Picture allows you to adjust the levels of black and white on the TV screen, giving you a darker or brighter picture overall.

BRIGHT

You can adjust the overall brightness of the TV picture with the Bright control.

DETAIL

The Detail feature adjusts the level of fine detail displayed in the picture.

Adjust the Picture Settings



Press the MENU button



To TINT, COLOR, PICTURE, BRIGHT or
DETAIL



To enter

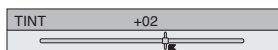

To adjust the setting



To move to the next setting



Press the MENU button when finished

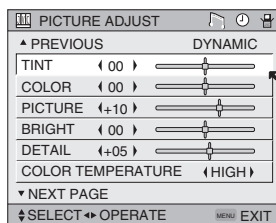

Note:

- You can reset the picture adjustments you set all at once to the default setting when you select RESET. See page 54.

Picture Adjust

Color Temperature

You can decide how strong or dull the colors appear on the TV screen.



Press the MENU button



To COLOR TEMPERATURE



To enter

COLOR TEMPERATURE LOW HIGH



To set LOW or HIGH



Press the MENU button when finished

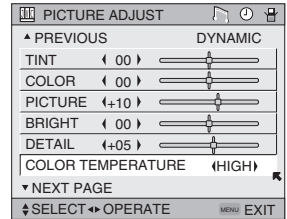

Digital Noise Clear

With digital noise clear, this helps take out static or noise from a channel that may not be coming in clearly.



Press the MENU button



To DIG. NOISE CLEAR



To enter



To select the mode "LOW", "HIGH" or "OFF"

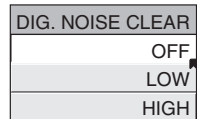

(VSM) Velocity Scan Modulation

Velocity scan modulation circuitry varies the electron beam's horizontal scanning speed to help accentuate the differences in picture brightness to sharpen the edges of images.



Press the MENU button



To VSM



To enter

VSM ON OFF



To turn VSM ON or OFF

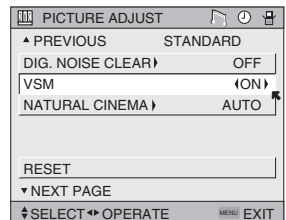

Picture Adjust

Natural Cinema

Natural Cinema corrects the problem of blurred edges which may occur when viewing a program originally shot on film (such as motion pictures) or animation. If you notice blurring at the edges of these programs, press NATURAL CINEMA and set it to AUTO. Natural Cinema helps correct conversion errors that occur when film, which is shot at 24 frames-per-second, is broadcast at the television rate of 30 frames-per-second.



Press the MENU button



To NATURAL CINEMA



To enter



To Select AUTO, ON or OFF

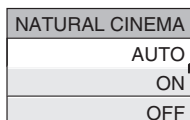

Notes: The natural cinema mode is automatically set to “AUTO” in the following cases:

- Turning on or off
- Changing the channel or input mode

Reset

Reset resets all picture adjustments (tint, color, picture, bright, detail, color temperature, dig. noise clear and VSM) at once to the default settings.



Press the MENU button



To RESET



To enter

The onscreen menu disappears for a moment, and then the settings are reset to the default setting for the above picture adjustments.



Press the MENU button when finished

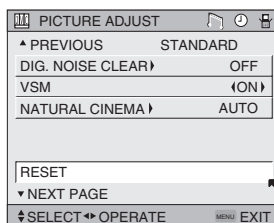

Sound Adjust

Sound Settings

These settings allow you to change and adjust the sound on your television.

BASS – You can increase or decrease the level of low-frequency sound in the TV's audio with the bass adjustment.

TREBLE – Use treble to adjust the level of high-frequency sound in your TV's audio.

BALANCE – Adjust the level of sound between the TV's left and right speakers with the balance setting.

Adjust the Sound Settings



Press the MENU button



To BASS, TREBLE or BALANCE



To adjust the setting



To move to the next setting



Press the MENU button when finished

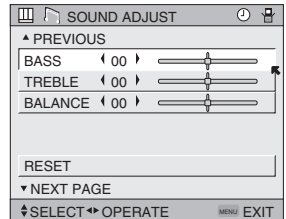

Notes:

- You can reset the sound adjustments (BASS, TREBLE and BALANCE) you set at once as the default setting when you select RESET.
- You can adjust BALANCE only when A.H.S. is off. See page 56.

Reset

Reset resets all Sound Adjustments (Bass, Treble and Balance) at once to the default settings.



Press the MENU button



To RESET



To enter

The onscreen menu disappears for a moment, and then the settings are reset to the default setting for the above sound adjustments.



Press the MENU button when finished

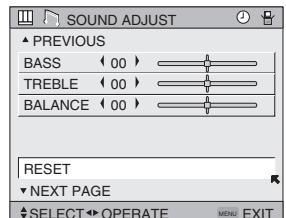

Sound Adjust

A.H.S

A.H.S. - Adds a more spacious surround sound. Music gives basic effect and movie for more effect. If you do not want more surround sound, select off.



Press the MENU button



To A.H.S.



To select MUSIC, MOVIE or OFF



Press the MENU button when finished

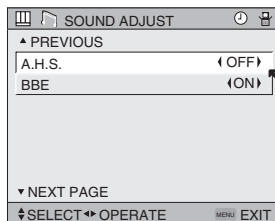

BBE

BBE - BBE high definition audio adds natural, clear and extraordinary sound quality to any program.



Press the MENU button



To BBE



To select ON or OFF



Press the MENU button when finished

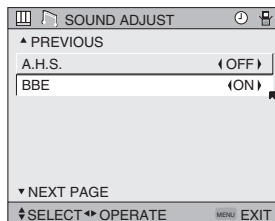

Note: BBE is a registered trademark of BBE Sound, Inc. For U.S., licensed from BBE Sound, Inc. under USP 4638258, 4482866 and 5510572. For Canada, licensed from BBE Sound, Inc. BBE is a registered trademark of BBE Sound, Inc.

Set Clock

The set clock function is described on page 24 as the interactive plug-in menu. You can choose to set the clock automatically, or manually. If you need to set the clock again, follow the steps below.



Press the MENU button



To SET CLOCK



To operate

When you set the clock automatically, choose AUTO by pressing the ◀ or ▶ arrows.



To TIME ZONE



To select your time zone



To D.S.T. (daylight savings time)



To turn D.S.T. ON or OFF



Press Ok to finish



Press the MENU button when finished

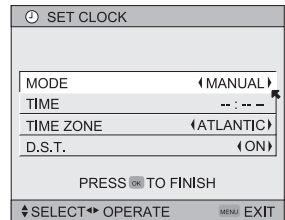

When you set the clock manually, choose MANUAL by pressing the ◀ or ▶ arrows.



To move to the hour



To set the hour



To move to minutes



To set the minutes



To TIME ZONE



To select your time zone

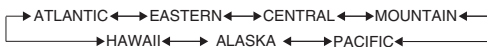

To D.S.T. (daylight savings time)



To turn D.S.T. ON or OFF



Press Ok to start clock

THANK YOU !!



Press the MENU button when finished

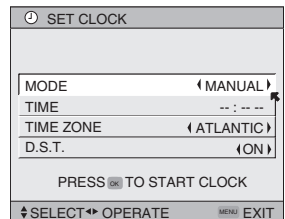

Note:

- When you set the TIME ZONE and D.S.T manually, they are used as the setting for the EPG.

Clock/Timers

On/Off Timer

The on/off timer lets you program your television to turn itself on or off. You can use it as an alarm to wake up, to help you remember important programs, or as a decoy when you're not home.



Press the MENU button



To ON/OFF TIMER



To operate (begins with ON TIME)



To set the hour (AM/PM) you want the TV to turn on



To move to minutes



To set the minutes



To accept ON TIME and move to OFF TIME (the time the TV will turn off). Set the OFF TIME the same way as ON TIME



To accept OFF TIME and move to CHANNEL



To select channel



To ON VOLUME



To set the volume level



To move to MODE



Choose ONCE or EVERYDAY



To ON/OFF TIMER



Choose YES to accept the timer setting, choose NO if you don't wish to accept



Press the Ok button to finish



Press the MENU button to exit the menu

ON/OFF TIMER	
ON TIME	7:00 PM
OFF TIME	10:00 PM
CHANNEL	03
ON VOLUME	CURRENT
MODE	← EVERYDAY →
ON/OFF TIMER	← NO →
PRESS [OK] TO FINISH	
SELECT [LEFT] OPERATE	MENU EXIT

Notes:

- The on/off time cannot be set to locked or guarded channels.
- In order for the on/off timer to work, the clock must be set.
- After a power interruption, the timer settings must be reset.

Button Functions

Multi Screen Function

Your television has two kinds of screen: SPLIT (2 channels) and INDEX (12 channels).

Note: After you press any multiscreen button, if you press the MENU button, only the picture adjust screen will appear.

Split

Activate the split-screen option by pressing SPLIT on the remote control.

A channel (or input) will now appear onscreen. The channel (or input) you were watching before pressing SPLIT will appear on the left, the new channel will appear on the right. The sound will continue to come from the main screen channel (or input). To turn split-screen off and return to normal television viewing, press SPLIT again or press the BACK button.

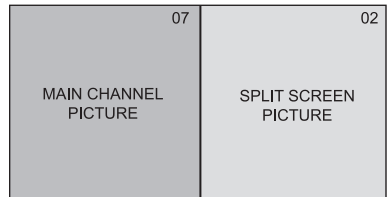

Note:

- You can enter the SPLIT mode when the screen is in NORMAL or INDEX mode.
- Split-screen functions will not work with locked channels or channels blocked by V-Chip ratings limits. A grey screen will display instead.
- With split-screen, the picture from the component terminal and HDCP terminal will not be displayed.
- The aspect of MAIN CHANNEL PICTURE becomes 16:9 when you input the picture of 480p, 720p and 1080i from the component terminal and HDCP terminal.
- After you press the SELECT button, and select SPLIT SCREEN when you press the OK button, select normal screen. If you don't operate, the MAIN CHANNEL SCREEN will be automatically selected about 8 seconds later.

Button Functions

Cable Box Note:

The Multi-Screen function may not operate when used with certain cable boxes. This is because while some models of cable boxes may receive up to 181 channels, and may only send the signal from one channel to your television. (Please refer to diagram on page 14). For the Multi screen function to operate correctly, it must have access to all available channels. Since the television is receiving the signal from only one channel from the cable box, it is impossible for the Multi-screen function to display a second, different channel. Because there are many different models of cable boxes in use today, if you are having problems operating your Multi-screen function feature with your cable box, we recommend you contact your local cable company for connection advice.

Index

This allows you to quickly look at up to 12 channels at a time so that you can decide which one to watch.

1	2	3	4
5	6	7	8
9	10	11	12

Notes:

- Only RF (NTSC) input signal will be displayed.
- You can watch the channel added in channel summary. See page 33.

Freeze

Pressing the FREEZE button causes the screen to change to the split-screen display with the still picture displayed on the right. In order to return to the normal display, press the FREEZE button once again.

Note: When the screen is in freeze mode, if you do not operate it within 15 minutes, this function will cancel out.

Swap

You can exchange the channel (or input) displayed in the split-screen window for the main screen image by pressing the SWAP button.

Note: This function will only work in SPLIT mode.

Select

With SELECT, you can select the picture (channel) while viewing split-screen. When you press SELECT button, the channel number on the top will be highlighted. Each press of SELECT will shift the channel.

Button Functions

Power

Turns the TV on or off.



Press the POWER button

Number Buttons - 10Key Pad

Use the number buttons on the remote control to move directly to a specific channel. For example, to move to channel 7:



0 (Zero)



7 (Seven)

Note: When you select the digital channel, first press the DCS button, next press the number buttons. See page 68.

100+ Button

Use the 100+ button to directly access channels above channel 99. For example, to move to channel 124, press 100+, 2 (Two), 4 (Four).

Input

Selects the signal input source for the television: Input-1, 2, 3 or 4 for video devices like VCR's DVD players, or camcorders.



INPUT 1, 2, 3, 4

Notes:

- When you return to TV mode, press the RETURN +/TV button or direct 10 key pad.
- You can also access the FRONT CONTROL PANEL screen by using the MENU button on the front of the TV instead of the remote control. It appears between INITIAL SETUP and PICTURE ADJUST screen, and it has INPUT and ASPECT menus. Choose INPUT or ASPECT by pressing MENU ▼ on the front panel and choose input or aspect by using the CHANNEL +/- buttons (◀ OPERATE ▶).

Digital-In

Use this button to directly select the digital-in input.



Press the DIGITAL-IN button

Channel +/-

Use these buttons to move up or down all the available channels your TV is able to receive. You can select the digital channel as well as the analog channels. If you select a digital channel, you can select them in order of RF.

Button Functions

Volume +/-

Use these buttons to raise or lower the TV's volume level.

Return +/TV

The RETURN+/TV button has three functions:

Return - Returns to the channel viewed just before the channel currently onscreen.

Return+ - Lets you program a specific channel to return to while scanning through the channels using the CH+ and CH- buttons.

TV - Returns to the TV mode.



RETURN+/TV and hold for three seconds

RETURN CHANNEL
PROGRAMMED!

The channel currently active has been programmed as your Return+ channel. Now scan through the channels using the CHANNEL+/- buttons.



RETURN+/TV

You will return to your programmed channel.

- To cancel your Return+ channel, press and hold the RETURN+ button for three seconds. The message "RETURN CHANNEL CANCELLED!" will appear.
- Return+ works only with the CHANNEL+/- buttons. Pressing any number key will cancel Return+.

Muting

The MUTING button instantly turns the volume down completely when you press it. To restore the volume to its previous level, press MUTING again.

Menu

The MENU button allows you to access JVC's onscreen menu system. Press MENU to activate the onscreen menu system.

- See individual topics like "Sound Adjust" for specific information on using menus.

OK

This button confirms your selection when you are in one of the onscreen menus. When you have selected a digital program on your television and you press the Ok button, the minor channel selection OSD appears.

Back

This button allows you to go back in the menu to change a selection or correct a mistake.

Button Functions

Video Status

The video status button gives you a choice of four TV picture display settings, including a display of your own preferences.

Standard - Resets the picture display to the factory settings.

Dynamic - Gives a vivid picture with better contrast when viewing in a brightly lit room.

Theater - Gives a rich, film-like look to video when viewing in a dimly lit room.

Game - Used for when you are playing video games connected to your TV.

VIDEO STATUS
STANDARD
DYNAMIC
THEATER
GAME



Press the VIDEO STATUS button

By every press of the VIDEO STATUS button, you change the mode.

Note: You can also change the mode by pressing the ▲▼ buttons.

TheaterPro D6500K

The TheaterPro D6500K color temperature technology function makes sure that the video you watch is set to the standard color temperature, so that what you see is as true to what the film to video editors intended it to be.



Press the THEATERPRO button

Sleep Timer

The Sleep Timer can turn the TV off for you after you fall asleep. Program it to work in intervals of 15 minutes, for a total time of up to 180 minutes.



Press the SLEEP button



Sleep Timer Message

20 seconds before the automatic shutoff, this message will appear:

GOOD NIGHT!!
PUSH SLEEP TIMER BUTTON
TO EXTEND

You then have 20 seconds to press the SLEEP button to delay the shut off for another 15 minutes.

Button Functions

Display

The display screen shows the current status of timers, inputs, and XDS ID.



Press the DISPLAY button

The screen to the right shows the following information:

- The current channel or AV input (Channel 05)
- The current time (12:20 pm)
- Sleep timer status/minutes remaining (The Sleep Timer is off)
- On/off timer status (Set to turn on everyday at 7:00 PM, off at 10:00 PM)
- Each Press of the DISPLAY button changes the display mode:

05 KLVX PBS	
JAZZ FESTIVAL	
NOW	12:20 PM
SLEEP TIMER	OFF
ON/OFF TIMER	EVERYDAY
ON TIME	7:00 PM
OFF TIME	10:00 PM



Display - Full screen shown above

Time - Shows the current time only

Channel - Shows the current channel

Off - Turns display off

Notes:

- You may also turn off the display at any step by pressing MENU.
- If the clock, sleep timer or on/off timer are not set, the display screen will show: "CLOCK NOT SET", "SLEEP TIMER OFF", and "ON/OFF TIMER OFF" respectively.

Button Functions

Aspect

This feature will help you adjust the picture you are watching to give you the best possible picture quality.

Aspect Ratios

PANORAMA - With this ratio a normal 4:3 aspect picture is stretched to fit the dimensions of the 16:9 aspect screen.

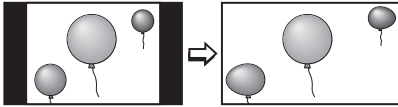

CINEMA - This ratio "zooms in" on the center part of a 4:3 aspect picture, blowing it up to fill the 16:9 screen.



FULL - This is the ratio to use when watching 16:9 High-Definition broadcasts.

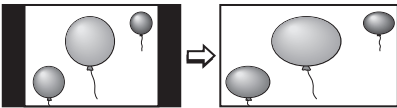

HD PANORAMA - This ratio stretches the High-Definition 16:9 aspect image to eliminate the black side bars.

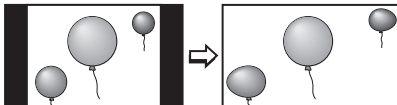

REGULAR - The regular ratio is used when you want to watch a 4:3 broadcast or recorded program without modifying the original picture to fit the dimensions of your 16:9 screen. The 4:3 picture will fill the screen from top to bottom, while black bars will appear to fill up the remaining space along the picture's sides. The 4:3 picture will be centered within the boundaries of the 16:9 screen.

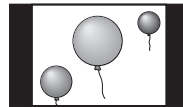

CINEMA ZOOM - This ratio stretches the High-Definition 16:9 aspect image to eliminate the black surrounding bars.



Button Functions

Aspect Ratios (Continued)



Press the ASPECT button

- *By pressing the ASPECT button, you can change the size.*

When you change the aspect ratios, it is different from their broadcast or recorded program.

NTSC, 480i, 480p,
HDCP 480p

ASPECT
PANORAMA
CINEMA
FULL
REGULAR

HD, HDCP 1080i

ASPECT
HD PANORAMA
CINEMA ZOOM
FULL

720P, HDCP 720p

ASPECT
FULL

Notes:

- You can also choose the size by pressing the ▲▼ buttons.
- When you change the aspect ratio or signal, reset the picture position to center.

ML/MTS

MTS technology allows several audio signals to be broadcast in analog at once, giving you a choice in what you wish to hear with a TV program. In addition to mono or stereo sound, an MTS broadcast may also include a second audio program (SAP).



Press the ML/MTS button

By every press of the ML/MTS button, you change the mode

	MTS
ON AIR	STEREO
ON AIR	SAP
	MONO

Notes:

- When you are receiving a digital broadcast, you can change the language by pressing the ML/MTS button.
- Keep the TV in stereo mode to get the best sound quality. The sound will work in stereo mode even if a certain broadcast is in mono sound only.
- Choose the mono setting to reduce excessive noise on a certain channel or broadcast.
- Selecting SAP will allow you to hear an alternative soundtrack, if one is available.
- MTS unavailable if your television's Input source is in input 1, 2, 3 or 4 mode, as described on page 61.
- ML/MTS will not work when you are using the Digital-In.
- You can also change the mode by pressing the ▲▼ buttons.

Button Functions

TV/CATV Slide Switch

Use either the television's own tuner or a cable box to select channels. Set this switch to **TV** to operate the television's built-in tuner. Move the switch to **CATV** to operate a cable box.

Note:

- See page 26 for information on programming your remote for cable box operation.

VCR/DVD Slide Switch

You can control a VCR or DVD player with the buttons on the lower part of the remote control. Move the slide switch to **VCR** or **DVD** to operate.

Notes:

- The remote is preset with the code 000 to control JVC-brand VCR's. For any other manufacturer's brand VCR, please see the code chart and instructions on page 27.
- The remote is preset with the code 000 to control JVC-brand DVD players. For any other manufacturer's brand DVD player, please see the code chart and instructions on page 28.

VCR Buttons

You can use this remote control to operate the basic functions of your VCR. These functions include: play, record, rewind, fast-forward, stop, pause, channel scan, TV/VCR, power on, and power off.

Move the selector switch to **VCR** to operate.

- The remote is preset with the code 000 to control JVC-brand VCR's. For any other manufacturer's brand VCR, please see the code chart and instructions on page 27.

DVD Buttons

You can also use this remote control to operate the basic functions of your DVD player. These functions include: play, rewind, fast-forward, stop, still/pause, previous/next, tray open/close, power on, and power off.

Move the selector switch to **DVD** to operate.

- The remote is preset with the code 000 to control JVC-brand DVD players. For any other manufacturer's brand DVD player, please see the code chart and instructions on page 28.

Light

All remote control buttons are illuminated, except for the TV/CATV slide switch, VCR/DVD slide switch and Light button. Press the **LIGHT** button to turn the illumination on for 4 seconds.

Super Focus

This button is only located on the front panel of your TV. When you press the **SUPER FOCUS** button on the front of the TV, you can access the auto convergence mode in the convergence menu screen automatically. See page 41.

Button Functions - Digital

Digital CH (DCS)

When you choose the digital channel, first press the Digital Ch (DCS) button, then press the number buttons on the remote control.

For example, to move to channel D23:



Press the DIGITAL CH (DCS) button



Press 2 (two)



Press 3 (three)

Sub Channel +/-

The main channel sometimes has minor channels (Sub Channels). By using the SUB CHANNEL +/-, you can select a sub channel and main channel, and you can also move to the next main channel.



Press the SUB CHANNEL + or -

By pressing the SUB CHANNEL + or -, you can change the sub channel and main channel. In case you select a channel by using the sub channel +/-, you can select it in order of the major channel.

You can also select the Sub Channel by the following method:



Press the Ok button



Press the VOLUME + or - to select the minor channel



Press the Ok button when you want to change to the minor channel

Note:

- If there are more than 2 major channels, select the digital channel by using the ▲▼ buttons and then press the OK button.

Button Functions - Digital

iLINK/Timer

iLINK Timer has four menus - Timer, Timer List, Controller and Device.

By connecting a D-VHS VCR with an iLINK cable, you can set the timer easily.

Notes:

- If the iLINK is not connected, "Controller" and "Device" will not appear.
- The iLINK/Timer function will only work when you are receiving digital programming only.
- Before you set the timer, connect the D-VHS VCR with the iLINK cable and select the device. See pages 22 and below.
- When you have set the timer, don't insert or disconnect the iLINK cable.

Device

To operate the iLINK timer and controller, select the D-VHS device.



Press the iLINK/TIMER button



To Device

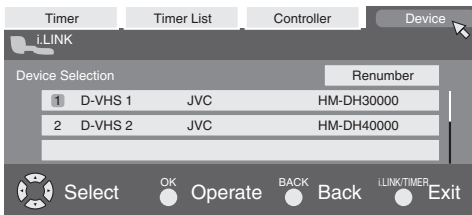

To select your device connecting with iLINK



Press the OK button

A  moves to the selected D-VHS number

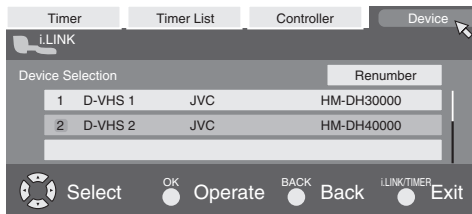

Notes:

- If you do not select the device, you cannot use the iLINK timer functions.
- If the iLINK is not connected, this OSD and selected device will not appear.
- Even if you disconnect one device, it is still listed here. If you want to remove the device from the list, select "Renumber". The list will now only show devices that are connected.

Button Functions - Digital

Controller

You can operate a D-VHS VCR connected with an iLINK cable by using this controller.

Notes:

- If the iLINK is not connected, the Controller OSD will not appear.
- If you want to stop the recording on the D-VHS VCR, press the ■ (stop) button.
- Some controller operations may differ from your D-VHS VCR operations.



Press the iLINK/TIMER button



To Controller

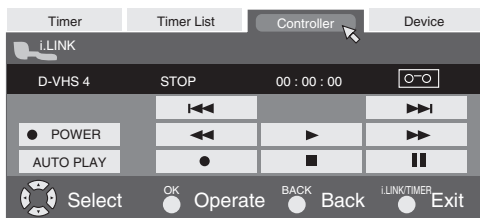

To operate the controller

The cursor starts to move from POWER if the D-VHS power is off. Press the Ok first.

The cursor starts to move from PLAY if the D-VHS power is on.



To select the key you want to operate



Press the Ok button

In order to watch the picture from a D-VHS, press the iLINK/TIMER button and press the ▶ on Controller. When you want to return to the TV screen, press the . This will stop the play of the D-VHS and return you to the TV screen.

AUTO PLAY button

When the AUTO PLAY button is on, and you play the D-VHS, the TV screen will switch automatically to the picture from the D-VHS. You can use the VCR buttons on the remote control to operate them.

Button Functions - Digital

Timer

You can set the two timers: Record and view. The timer starts the recording or turns to the channel you set for it automatically.



Press the iLINK/TIMER button



To TIMER

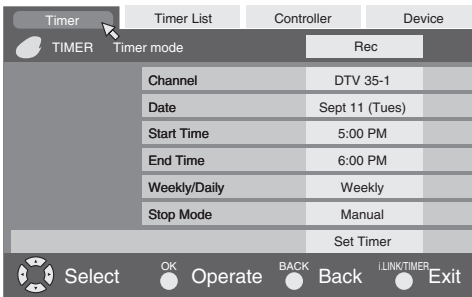

▼ To TIMER MODE



To select Rec or View



To CHANNEL



To select the channel you want to set the timer for



To DATE



To select the date



To START TIME



To set the start time



To END TIME



To set end time



To WEEKLY/DAILY



To select ONCE, WEEKLY, Mon-Fri or DAILY



To STOP MODE



To select MANUAL or EVENT



To SET TIMER



Press the OK button

If you set the Rec on timer mode, set recording **R** is added in front of the program title.

If you set the View on timer mode, set viewing **V** is added in front of the program title.

Notes:

- In order for the iLINK timer setting to work, you must set the clock on your television. See page 57.
- When you want to edit the timer settings, see TIMER LIST on page 72.

Button Functions - Digital

Timer List

When you want to confirm the timer you set or edited, or delete the timer setting, use this function.

Timer Edition



Press the iLINK/TIMER button



To TIMER LIST

Timer	Timer List	Controller	Device	
TIMER				
1. V	88-8 WWWWWWW	May 18 (Wed)	10:00 AM 10:30 AM	Once
2. R	80-3 PBS1DTV	May 18 (Wed)	6:00 AM 7:00 AM	Mon - Fri Timer
3. R	335-1 KDVRet	May 18 (Wed)	8:00 AM 8:30 AM	Daily Event
4. R	80-3 PBS1DTV	May 18 (Wed)	6:00 PM 7:00 PM	Mon - Fri Timer

Select OK Operate BACK Back iLINK/TIMER Exit



To select the timer list you want to edition



Press the Ok button



To change the setting you want to

Timer	Timer List	Controller	Device
TIMER			
Timer mode		Rec	
1. V	88-8 WWWWWWW	Channel	DTV 35-1
Date		Sept. 10 (Wed)	
2. R	80-3 PBS1DTV	Start Time	5:00PM
End time		6:00PM	
3. R	335-1 KDVRet	Weekly/Daily	Weekly
4. R	80-3 PBS1DTV	Stop mode	Manual
Delete		Set Timer	

Select OK Operate BACK Back iLINK/TIMER Exit



To SET TIMER



Press the Ok button

Timer Deletion



Press the iLINK/TIMER button



To TIMER LIST



To select the timer list you want to delete



Press the Ok button



(Down and Left) to delete



Press the Ok button

Button Functions - Digital

EPG

You can set the recording timer or viewing timer by selecting the program from the Easy Programming Grid (EPG).

Notes:

- The EPG function will only work when you are receiving digital programming only.
- The EPG will not show the correct time and date if you have not performed the set clock function on your television. See page 57.
- You may not be able to set the Rec/View timer unless it has the detailed data on EPG. If you cannot set the timer by using EPG, set it manual. See page 71.
- When it is recording a program by the timer setting, or it is recording the program by the D-VHS with iLink cable, you can not see the EPG.

Easy Rec Timer

You can set the timer recording easily.



Press the EPG button



To select time zone



To select the channel



Press the OK button



The detail information of the program appears.



To Easy Rec



Press the OK button

The timer is set. The **R** mark is added in front of the program title.



Note:

- If you set the Easy Rec timer to the program which is starting now, the recording starts when you press the EPG button to release the EPG onscreen.
- The time and date on the EPG may be incorrect, depending on the broadcasted signal that you are receiving. Please be careful especially when using the EZ REC TIMER (see page 74), and the EZ VIEW TIMER (see page 75). There is a possibility that the signal that you are receiving, may have the incorrect time and date. If this is the case, then the EPG will record or show the wrong program.

Button Functions - Digital

Easy Rec Timer - Edit

You can edit (change to view) or delete the Easy Rec Timer you set.



Press the EPG button



To select the time zone



To select the channel



Press the Ok button

The detail information of the program appears.

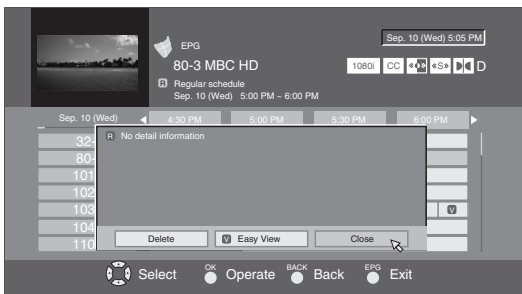

To Easy View or Delete



Press the Ok button

When you change to Easy View, the **V** mark is added in front of the program title.

Button Functions - Digital

Easy View Timer

When you set the Easy View Timer, the digital program you set the timer for turns on automatically.



Press the EPG button



To select the time zone



To select the channel



Press the Ok button

The detail information of the program appears.



To Easy View



Press the Ok button

The timer is set. The **V** mark is added in front of the program title.

Easy View Timer - Edit

You can edit (change to rec timer) or delete the easy view timer you set.



Press the EPG button



To select the time zone



To select the channel



Press the Ok button

The detail information of the program appears.



To Easy Rec or Delete



Press the Ok button

When you change to Easy Rec, the **R** mark appears in front of the program title.

OSD Warnings

Weak Signal

This OSD warning appears when the digital channel that you have selected is too weak to receive or no signal is being detected for that channel. The position of the OSD warning will move automatically every two seconds to prevent the screen from burn-in. See page 6.



No Program

This OSD warning appears on the television when the television is receiving a carrier signal, but the carrier signal does not contain any broadcast programming.

Troubleshooting

PROBLEMS	CHECK
There is no power	<ul style="list-style-type: none"> • See if the power cord became unplugged. • Check for a blown fuse or circuit breaker or a power outage.
There is no picture or sound	<ul style="list-style-type: none"> • The antenna could be disconnected. • The input mode could be set improperly. See page 61. • The tuner (Auto Tuner Setup) could be set improperly. See page 33. • The TV station may be having difficulties. Check to see if other stations are working.
Remote control is not operating properly or at all	<ul style="list-style-type: none"> • Check to see that the batteries are still working and properly installed. • Make sure the remote has a clear sight path to the TV. • Check that the TV/CATV switch is in the proper position. • You may be too far from the TV. You must be within 23 feet (7 meters).
You cannot select a certain channel	<ul style="list-style-type: none"> • Make sure the channels have been programmed. See "Channel Summary", page 33. • Check to see if the channel is locked. See "Channel Summary - Lock" page 34.
The power turns off by itself	<ul style="list-style-type: none"> • Make sure the set did not become unplugged. • Perhaps the On/Off Timer is set. See page 58. • Check to see if the Sleep Timer was set. See page 63.
The clock is wrong	<ul style="list-style-type: none"> • The power was interrupted and the clock was not reset. See page 57.
The color quality is poor	<ul style="list-style-type: none"> • Tint and Color may be improperly adjusted. See page 52. • The Video Status mode may be turned to the wrong setting. See page 63.
There are lines across the picture	<ul style="list-style-type: none"> • There could be interference from another electrical appliance, such as a computer, another TV or VCR. Move any such appliances further away from the TV.
The picture is spotted	<ul style="list-style-type: none"> • There could be interference from a high-wattage appliance, like a hairdryer or vacuum, operating nearby. Move the antenna away from the appliance or change to a coaxial cable connection which is less prone to interference.
There are double pictures (ghosts)	<ul style="list-style-type: none"> • A building or passing airplane can reflect the original signal and produce a second, slightly delayed one. Adjust your antenna position.
Picture is snowy (image noise)	<ul style="list-style-type: none"> • Your antenna may be damaged, disconnected or turned. Check the antenna connection. If the antenna is damaged, replace it.
Screen is 40% black	<ul style="list-style-type: none"> • The Closed Caption Text mode is on. Turn it off in the Closed Caption Menu, page 44.
Stereo or bilingual programs can't be heard	<ul style="list-style-type: none"> • Make sure the MTS settings are correct. See "ML/MTS" on page 66.
There is no sound from the TV's speaker	<ul style="list-style-type: none"> • The Center CH Input may be turned on. See page 50.
Static electricity	<ul style="list-style-type: none"> • It is normal to feel static electricity if you brush or touch the screen.
You hear occasional crackling sounds	<ul style="list-style-type: none"> • It is normal for the TV to make crackling sounds when first turned on or off. Unless the sound or picture become abnormal, this is fine.
The AUTO DEMO finished automatically	<ul style="list-style-type: none"> • The TV recieved a signal from the AV CompuLink • The On Timer that you programmed has started. • The channel that the AUTO DEMO is using is a channel that is blocked by V-Chip. • The Auto Shut Off that you programed has occurred.

Troubleshooting

PROBLEMS	CHECK
The square appears and blinking	<ul style="list-style-type: none">• It appears when you are operating the Auto Convergence. If not, then this may be a problem with the Auto Convergence. Contact a service agent.
The power turns off and the LED on the front panel is blinking.	<ul style="list-style-type: none">• Check the fan on the back of the TV and make sure nothing has obstructed or entered the fan. If nothing entered or is blocking the fan, contact a service agent.

JVC COMPANY OF AMERICA warrants this product and all parts thereof, except as set forth below **ONLY TO THE ORIGINAL PURCHASER AT RETAIL** to be **FREE FROM DEFECTIVE MATERIALS AND WORKMANSHIP** from the date of original retail purchase for the period shown below. ("The Warranty Period")

PARTS 1 YEAR	LABOR 1 YEAR
---------------------	---------------------

This limited warranty is valid only in the fifty (50) United States, The District of Columbia and Commonwealth of Puerto Rico.

WHAT WE WILL DO:

If this product is found to be defective within the warranty period, JVC will repair or replace defective parts at no charge to the original owner.

Such repair and replacement services shall be rendered during regular business hours by JVC authorized service centers. Parts used for replacement are warranted only for the remainder of this Warranty Period. Televisions with a screen size of 25 inches and larger are covered on an in-home basis.

WHAT YOU MUST DO FOR WARRANTY SERVICE:

Either contact the selling dealer (retailer) or call 1-800-252-5722 to arrange In-home service. In-home service will require clear access to the Television by the service technician.

WHAT IS NOT COVERED:

This limited warranty provided by JVC does not cover:

1. Products which have been subject to abuse, accident, alteration, modification, tampering, negligence, misuse, faulty installation, lack of reasonable care, or if repaired or serviced by anyone other than a service facility authorized by JVC to render such service, or if affixed to any attachment not provided with the products, or if the model or serial number has been altered, tampered with, defaced or removed. **AV-65WP94 ONLY:** If the upper unit is removed from the lower unit by anyone other than a dealer or service facility authorized by JVC.
2. Initial installation, installation and removal from "built-in" entertainment centers and other mounting systems.
3. Operational adjustments covered in the Owner's Manual, normal maintenance, including head cleaning.
4. Damage that occurs in shipment, due to an act of God, and cosmetic damage.
5. Signal reception problems and failures due to line power surge.
6. Products used for commercial purposes (including but not limited to rental).
7. Accessories.
8. Batteries (except that Rechargeable Batteries are covered for 90 days from date of purchase).

There are no express warranties except as listed above.

THE DURATION OF ANY IMPLIED WARRANTIES, INCLUDING THE IMPLIED WARRANTY OF MERCHANTABILITY, IS LIMITED TO THE DURATION OF THE EXPRESS WARRANTY HEREIN.

JVC SHALL NOT BE LIABLE FOR ANY LOSS OF USE OF THE PRODUCT, INCONVENIENCE, OR ANY OTHER DAMAGES, WHETHER DIRECT, INCIDENTAL OR CONSEQUENTIAL (INCLUDING, WITHOUT LIMITATION, DAMAGE TO TAPES, RECORDS OR DISCS) RESULTING FROM THE USE OF THIS PRODUCT, OR ARISING OUT OF ANY BREACH OF THIS WARRANTY, ALL EXPRESS AND IMPLIED WARRANTIES, INCLUDING THE WARRANTIES OF MERCHANTABILITY AND FITNESS FOR PARTICULAR PURPOSE, ARE LIMITED TO THE WARRANTY PERIOD SET FORTH ABOVE.

Some states do not allow the exclusion of incidental or consequential damages or limitations on how long the warranty lasts, so these exclusions or limitations may not apply to you. This warranty gives you specific legal rights and you may also have other rights which vary state to state.

JVC COMPANY OF AMERICA
DIVISION OF JVC AMERICAS CORP.

1700 Valley Road
Wayne, New Jersey 07470

<http://www.jvc.com>

REFURBISHED PRODUCTS CARRY A SEPARATE WARRANTY. THIS WARRANTY DOES NOT APPLY. FOR DETAILS OF REFURBISHED PRODUCT WARRANTY, PLEASE REFER TO THE REFURBISHED PRODUCT WARRANTY INFORMATION PACKAGED WITH EACH REFURBISHED PRODUCT.

For customer use:

Enter below the Model No. and Serial No. which is located either on the rear, bottom or side of the cabinet.

Retain this information for future reference.

Model No.: _____

Serial No.: _____

Purchase Date: _____

Name Of Dealer: _____

Authorized Service Centers

QUALITY **JVC** SERVICE

HOW TO LOCATE YOUR JVC SERVICE CENTER

TOLL FREE: 1 (800) 537-5722

<http://www.jvc.com>

Dear Customer,

In order to receive the most satisfaction from your purchase, please read the instruction booklet before operating the unit. In the event that repairs are necessary, call our Customer Relations Department at 1-800-537-5722 or visit our website at **www.JVC.com**

Remember to retain your Bill of Sale for Warranty Service.

_____ **Don't service the television yourself** _____

Caution

To prevent electrical shock, do not open the cabinet. There are no user serviceable parts inside. Please refer to qualified service personnel for repairs.

Accessories

To purchase accessories for your JVC product, please call toll free:1 (800) 882-2345 or on the web at **www.JVC.com**

Specifications

Model	AV-65WP94	AV-56WP94
Type	Rear Projection Television	
Reception Format	NTSC, BTSC System (Multi-Channel Sound) ATSC Terrestrial	
Reception Range	VHF 2 to 13, UHF 14 to 69 Sub, Mid, Super, Hyper and Ultra bands (180 channel frequency synthesizer system)	
Power Source	AC 120V, 60 Hz	
Power Consumption	320W	
Screen Size	65 inch / 165 cm measured diagonally, 16:9 ratio	56 inch / 142 cm measured diagonally, 16:9 ratio
Speakers	16 cm round X 2, 5.5 cm round X 2	
Speaker Input	16 Ohms / 60W (Maximum)	
Audio Output	Full Range - 10W + 10W	
Antenna Terminal (VHF/UHF, ATSC IN)	75 ohms (F-type connector x 2)	
External Input Jacks	Video: 1 Vp-p, 75 ohms Audio: 500 mVrms (-4dBs) high impedance	
Component Input Jack	Y: 1Vp-p positive, 75 ohms (negative sync provided) Pb/Pr: 0.7 Vp-p 75 ohms	
S-Video Input Jacks	Y: 1Vp-p positive, 75 ohms (negative sync provided) C: 0.286 Vp-p (burst signal), 75 ohms	
Audio Output Jacks (VARI/FIX)	Vari: More than 0 1000mVrms (+2.2dBs) FIX: 500mVrms (-4dBs) Low impedance (1000 Hz when modulated 100%)	
Subwoofer Output Jack	More than 0 1000mVrms (+2.2dBs) Low impedance (80 Hz when modulated 100%)	
Optical Output Digital Audio	Digital Out (optical) x 1	
ATSC Output	Video: 1Vp-p, 75ohms Y: 1Vp-p, 75 ohms C: 0.286Vp-p (burst signal), 75 ohms Audio: 250mVrms (-10dBs) Fs-18dB Low Impedance	
iLINK In/Out Jack	TS IN/OUT (4-pin, S400) x 1 IEEE1394 compliant DTCP digital copy protection compatible	
AV CompuLink III Jack	3.5 mm mini jack X 1	
Digital-In	DVI-D Single Link 19 pin Note: The Digital-In terminal is not compatible with picture signals of a personal computer	
Dimensions (in) W X H X D (cm)	61 3/4 x 58 7/8 x 28 3/4 156.6 x 149.5 x 72.8	53 7/8 x 54 5/8 x 26 3/8 136.8 x 138.6 x 66.7
Weight (lbs / kg)	256 / 116	225 / 102
Accessories	Illuminated remote control unit / AA batteries X 2	

Specifications subject to change without notice.

Notes

Notes

JVC COMPANY OF AMERICA
Division of JVC Americas Corp.
1700 Valley Road
Wayne, New Jersey, 07470



JVC CANADA, INC.
21 Finchdene Square
Scarborough, Ontario
Canada, M1X 1A7

Free Manuals Download Website

<http://myh66.com>

<http://usermanuals.us>

<http://www.somanuals.com>

<http://www.4manuals.cc>

<http://www.manual-lib.com>

<http://www.404manual.com>

<http://www.luxmanual.com>

<http://aubethermostatmanual.com>

Golf course search by state

<http://golfingnear.com>

Email search by domain

<http://emailbydomain.com>

Auto manuals search

<http://auto.somanuals.com>

TV manuals search

<http://tv.somanuals.com>