

JVC[®]

**For model:
AV-61S902**

PROJECTION TELEVISION USER'S GUIDE

D-ILA[™]
HOLOGRAM





IMPORTANT NOTE TO THE CUSTOMER

In the space below, enter the serial number for your television (located at the rear of the television cabinet). Staple your sales receipt or invoice to the inside cover of this guide. Keep this user's guide in a convenient place for future reference. Keep the carton and original packaging for future use.

Serial Number

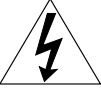
IMPORTANT SAFETY PRECAUTIONS

**CAUTION**
**RISK OF ELECTRIC SHOCK
DO NOT OPEN**

**CAUTION: To reduce the risk of electric shock.
Do not remove cover (or back).
No user serviceable parts inside.
Refer servicing to qualified service personnel.**

The lightning flash with arrowhead symbol, within an equilateral triangle is intended to alert the user to the presence of uninsulated "dangerous voltage" within the product's enclosure that may be of sufficient magnitude to constitute a risk of electric shock to persons.

The exclamation point within an equilateral triangle is intended to alert the user to the presence of important operating and maintenance (servicing) instructions in the literature accompanying the appliance.



The lamp assembly in this product contains mercury. Disposal of the lamp assembly may be regulated due to environmental considerations. For information on replacement, disposal or recycling procedures, please contact JVC Customer Relations at 1-800-252-5722.

WARNING: TO PREVENT FIRE OR SHOCK HAZARDS, DO NOT EXPOSE THIS TV SET TO RAIN OR MOISTURE.

CAUTION: TO INSURE PERSONAL SAFETY, OBSERVE THE FOLLOWING RULES REGARDING THE USE OF THIS UNIT.

1. Operate only from the power source specified on the unit.
2. Avoid damaging the AC plug and power cord.
3. Avoid Improper installation and never position the unit where good ventilation is unattainable.
4. Do not allow objects or liquid into the cabinet openings.
5. In the event of trouble, unplug the unit and call a service technician. Do not attempt to repair it yourself or remove the rear cover.

Changes or modifications not approved by JVC could void the warranty.

* When you don't use this TV set for a long period of time, be sure to disconnect both the power plug from the AC outlet and antenna for your safety.

* To prevent electric shock do not use this polarized plug with an extension cord, receptacle or other outlet unless the blades can be fully inserted to prevent blade exposure.

IMPORTANT SAFEGUARDS

CAUTION:

Please read and retain for your safety.

Electrical energy can perform many useful functions. This TV set has been engineered and manufactured to assure your personal safety. But *improper use can result in potential electrical shock or fire hazards*. In order not to defeat the safeguards incorporated in this TV set, observe the following basic rules for its installation, use and servicing.

And also follow all warnings and instructions marked on your TV set.

INSTALLATION

- 1 Your TV set is equipped with a polarized AC line plug (one blade of the plug is wider than the other).

(POLARIZED-TYPE)

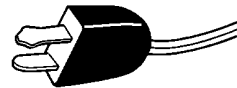

This safety feature allows the plug to fit into the power outlet only one way. Should you be unable to insert the plug fully into the outlet, try reversing the plug.

Should it still fail to fit, contact your electrician.

- 2 Operate the TV set only from a power source as indicated on the TV set or refer to the operating instructions for this information. If you are not sure of the type of power supply to your home, consult your TV set dealer or local power company. For battery operation, refer to the operating instructions.
- 3 Overloaded AC outlets and extension cords are dangerous, and so are frayed power cords and broken plugs. They may result in a shock or fire hazard. Call your service technician for replacement.
- 4 Do not allow anything to rest on or roll over the power cord, and do not place the TV set where power cord is subject to traffic or abuse. This may result in a shock or fire hazard.
- 5 Do not use this TV set near water — for example, near a bathtub, washbowl, kitchen sink, or laundry tub, in a wet basement, or near swimming pool, etc.

6 If an outside antenna is connected to the TV set, be sure the antenna system is grounded so as to provide some protection against voltage surges and built-up static charges. Section 810 of the National Electrical Code provides information with respect to proper grounding of the mast and supporting structure, grounding of the lead-in wire to an antenna discharge unit, size of grounding conductors, location of antenna discharge unit, connection requirements for the grounding electrode.

7 An outside antenna system should not be located in the vicinity of overhead power lines or other electric light or power circuits, or where it can fall into such power lines or circuits. When installing an outside antenna system, extreme care should be taken to keep from touching such power lines or circuits as contact with them might be fatal.

EXAMPLE OF ANTENNA GROUNDING AS PER NATIONAL ELECTRICAL CODE

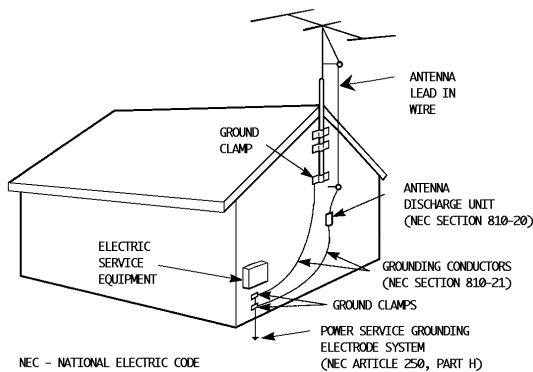

8 TV sets are provided with ventilation openings in the cabinet to allow heat generated during operation to be released. Therefore:

- Never block the bottom ventilation slots of a portable TV set by placing it on a bed, sofa, rug, etc.
- Never place a TV set in a “built-in” enclosure unless proper ventilation is provided.
- Never cover the openings with a cloth or other material.
- Never place the TV set near or over a radiator or heat register.

9 To avoid personal injury:

- Do not place a TV set on a sloping shelf unless properly secured.
- Use only a cart or stand recommended by the TV set manufacturer.
- Do not try to roll a cart with small casters across thresholds or deep pile carpets.
- Wall or shelf mounting should follow the manufacturer’s instructions, and should use a mounting kit approved by the manufacturer.

USE

- 10** Caution children about dropping or pushing objects into the TV set through cabinet openings. Some internal parts carry hazardous voltages and contact can result in a fire or electrical shock.
- 11** Unplug the TV set from the wall outlet before cleaning. Do not use liquid or an aerosol cleaner.
- 12** Never add accessories to a TV set that has not been designed for this purpose. Such additions may result in a hazard.

13 For added protection of the TV set during a lightning storm or when the TV set is to be left unattended for an extended period of time, unplug it from the wall outlet and disconnect the antenna. This will prevent damage to product due to lightning storms or power line surges.

14 A TV set and cart combination should be moved with care. Quick stops, excessive force, and uneven surfaces may cause the TV set and cart combination to overturn.



SERVICE

15 Unplug this TV set from the wall outlet and refer servicing to qualified service personnel under the following conditions:

- A. When the power cord or plug is damaged or frayed.
- B. If liquid has been spilled into the TV set.
- C. If the TV set has been exposed to rain or water.
- D. If the TV set does not operate normally by following the operating instructions. Adjust only those controls that are covered in the operating instructions as improper adjustment of other controls may result in damage and will often require extensive work by a qualified technician to restore the TV set to normal operation.
- E. If the TV set has been dropped or damaged in any way.
- F. When the TV set exhibits a distinct change in performance — this indicates a need for service.

16 Do not attempt to service this TV set yourself as opening or removing covers may expose you to dangerous voltage or other hazards. Refer all servicing to qualified service personnel.

17 When replacement parts are required, have the service technician verify in writing that the replacement parts he uses have the same safety characteristics as the original parts. Use of manufacturer’s specified replacement parts can prevent fire, shock, or other hazards.

18 Upon completion of any service or repairs to this TV set, please ask the service technician to perform the safety check described in the manufacturer’s service literature.

19 Note to CATV system installer.
This reminder is provided to call the CATV system installer’s attention to Article 820-40 of the NEC that provides guidelines for proper grounding and, in particular, specifies that the cable ground shall be connected to the grounding system of the building, as close to the point of cable entry as practical.

Welcome...

Thank you for purchasing JVC's model AV-61S902 "D'Ahlia" HDTV-ready projection television which uses the high-quality D-ILA projection system.

The D'Ahlia is one of the highest quality and most technologically advanced televisions available today.

It is recommended that you read this instruction manual before using the television in order to learn about the many features.

Cautions related to the safe use of the device and important information which will help you to be able to use this device for a long time are in Appendixes A to C.

Once again, thank you for purchasing this television and please enjoy using it.

In order to be able to use the television for a long time

This television uses a lamp to project the picture onto the screen.

Before using the television, please read the safety cautions and information about this television which are summarized below.

1. When the power is turned on, the warming-up commences

This television uses a lamp to project the picture onto the screen.

Once the lamp has warmed up, you can enjoy the pictures at their full brightness.

What happens when the power is turned on is explained below.

Immediately after the power is turned on, since the lamp has not had time to warm up, the picture is displayed only dimly on the screen. As the lamp warms up, the picture becomes brighter. It takes approximately one minute for the lamp to warm up to its normal operating temperature.

There are 10 LED indicators on the front panel of the television and these can be used as a guide.

When the POWER button is pressed, the 10 LED indicators light green and then go out one at a time approximately every 5 seconds.

2. Cooling the inside of the television and the lamp

Cooling is also performed while the television being shut down.

When the POWER button is pressed to turn the power off, the following operations are performed.

When the television is turned off, the picture on the screen darkens from the outsides like a pair of curtains closing. If the POWER button is pressed again while the curtains are still closing, the power can be turned back on again.

Once the curtains have fully closed and the screen is dark, cooling is performed for approximately one minute.

While the cooling is being performed, the 10 LED indicators on the front panel light two at a time while moving clockwise. The television can not be operated while the cooling is being performed.

After the cooling has been performed for approximately one minute, the power is turned off.

Do not remove the electric plug until after the cooling has been completed. If the electric plug is removed without performing the cooling operation, the internal circuits and lamp may overheat leading to the life of the lamp being shortened and the possibilities of malfunctions.

Do not block the ventilation holes

Do not block the ventilation holes while the power is turned on. Do not block the air intake holes behind the speaker grills.

Clean the air filter once every three months.

In order for cold air to be fed inside the device, the two filters which are behind the speaker grills, must be regularly cleaned. If cold air is not fed into the device, the internal circuits and lamp may overheat leading to the life of the lamp being shortened and the possibilities of malfunctions. Refer to Appendix A for the details about cleaning the air filters.

3. The lamp is a consumable item

Replace the lamp when it has blown or when the pictures becomes dark. The lamp is a user-replaceable item. The lamp must be recycled. For a detailed explanation of how to recycle the lamp, refer to Appendix B and the instruction that are included with the replacement lamp kit.

4. The television requires a lot of electric power

It is recommended that the television is connected directly to the wall socket, and not to another device. When connecting the television to a wall socket that is being used by another device or when using an extension cord, be careful not to exceed the capacity of the socket.

Do not turn the power on and off repeatedly in a short time.

It subjects the television and lamp to stress and may lead to malfunctions and the life of the lamp being shortened.

5. The screen is made of plastic

Handle the screen carefully as it scratches easily. Do not rub, hit or press it with any hard objects.

When the screen is dirty, gently wipe it with a soft cloth. Refer to Appendix A for details of how to clean the screen.

6. Caution! Warm air from air duct

This unit has an air duct for cooling. The duct will blow warm air while the television is operating. When placing the television, make sure not to locate the unit too close to wallpaper. The warm air could cause the color of the wallpaper to change. Also take care to keep children and pets away from the warm air ducts. Long exposure to the warm air from the ducts could cause a minor burn.

7 Caution! Moving this unit

This unit has casters. When you are moving the unit, try to only push the unit from the sides. Attempting to push the unit from the front or back could cause the unit to tip over.

When lifting this unit, do not hold by the screen frame. Holding the screen frame could cause it to detach from the unit and fall.

8. Do not replace the lamp immediately after use

The lamp becomes extremely hot during use. If the lamp is touched immediately after use before it has had a chance to cool down, there is a danger of burns. Be careful when handling the lamp.

9. Do not touch the lamp glass

If the lamp is used when there is dirt from fingers on the lamp glass, there is a possibility of the lamp breaking. Be careful not to touch the lamp glass.

10.ILA element characteristics

Do not project still pictures or pictures which have still segments for a long time.

The still parts of the picture may remain on the screen. This is a characteristic of ILA elements and not a malfunction. The picture will disappear over time.

11.Condensation

When a heater is turned on or the television is moved from a cold place to a hot place, droplets of water may be formed on the lamp and screen. This is called condensation. If the television is used while this condensation is still present, the picture may seem distorted, and the inside of the screen may become dirty.

In such cases, wait until the condensation has gone before using the television.

12 Do not open the rear cabinet of this unit

This unit has a DIGITAL-IN terminal. Opening the rear cabinet will violate the copyright of program or software shown on this television. Please do not open the rear cabinet.

Table of Contents

Introduction. 8

Watching television9

Connections

Connections Checklist10

Audio/Video Connectors10

Front Panel Diagram11

Rear Panel Diagram.....11

Cable and VCR Connections.....12

S-Video Connection13

DTV Decoder Connection15

DVD Player Connection17

AV Compu Link.....18

Front Panel Inputs19

Home Theater20

Remote Control

Install the Batteries.....21

Remote Control Basics21

Remote Programming

Setting the CATV, VCR and DVD Codes

Cable Box or Satellite setup22

VCR setup23

DVD setup24

Search Codes25

Menu Functions

Onscreen Menus

The Onscreen Menu System26

Using the Onscreen Menus27

Plug In Menu28

Language.....28

Auto Tuner Setup29

Set Clock

Auto (XDS)30

Manual30

Finish30

Initial Setup

Auto Tuner Setup31

Antenna31

Channel Summary32

Channel Summary-Lock.....32

V-Chip.....33

U.S. Parental Rating Systems33

Set Ratings Guidelines.....34

To Set TV Ratings Levels34

To Set Movie (MPAA) Ratings Levels..34

Unrated Programs.....35

Menu Functions (Continued)

Notes About Unrated Programs35

Warning Message35

Set Lock Code35

Initial Setup 2

Language.....36

Closed Caption36

Vertical Position37

DSD37

DIGITAL-IN.....37

Picture Adjust

Tint38

Color38

Picture39

Bright39

Detail39

Picture Adjust 2

YNR40

DNR40

Noise Muting41

Set Video Status.....41

Sound Adjust

Bass42

Treble42

Balance42

MTS (Multi-channel TV Sound)43

Some Sound Advice43

Initial Setup 3

Super Bass.....44

TV Speaker.....44

Audio Settings

Sound Mode.....45

Dolby Pro Logic45

Pro Logic 3D-Phonic47

Other Sound Modes.....47

Switching the surround function on/off ..47

CLOCK/TIMERS

Clock/Timers48

Aspect

Aspect49

Aspect Ratios.....49

Table of Contents

Button Functions

Split	50
Swap	50
Freeze	50
Menu	51
Exit	51
Display	51
Sleep Timer	51
BBE	52
Sound	52
Muting	52
Video Status	52
Natural Cinema	52
Aspect	52
Number Buttons-10 Key Pad	53
100+ Button	53
Return+	53
V-chip	53
Input	54
Menu (on TV's Front Panel)	54
Light	54
VCR Buttons	55
DVD Buttons	55
TV/CATV Switch	55
VCR/DVD Switch	55

Troubleshooting

Troubleshooting	56
-----------------------	----

Appendices

Appendix A - Cleaning the Filters	58
Appendix A - Caring for the Cabinet	59
Appendix A - Caring for the Screen	59
Appendix B - Changing the Lamp	60
Appendix B - Replacement Lamp Kit	60
Appendix B - Replacement Lamp	60
Appendix B - Warning Messages	63
Appendix B - Recycling Information	63
Appendix C - LED Display	64
Limited Warranty	65
Authorized Service Centers	66
Specifications	67

Introduction

After removing the product from the box, use the following procedure to prepare the television.

1 Check the accessories

Check that nothing is missing.

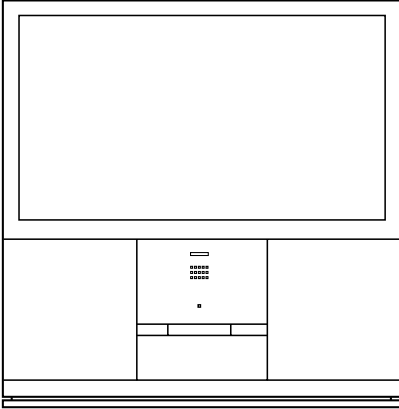

Television

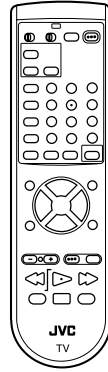

Remote Control

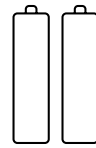

Two AA Batteries

2 Prepare the remote control

- 1) Refer to page 21 and insert the batteries.
- 2) In order to control the television with the remote control, set the TV/CATV switch to TV. Set the VCR/DVD switch to VCR. (The detailed information is in the "Remote Control Basics" section on page 21.)

3 Connect the antenna

Refer to page 12 to page 14 and connect the antenna.

4 Set the television

- 1) Insert the electric plug of the main unit into the wall socket.
- 2) Press the power button and turn the television power on.
It takes a little while from when the power button is pressed to when the picture appears on the screen.
(The detailed information about turning the power on and off is on the next page.)
- 3) Use the PLUG IN MENU and set the television.
When the television power is turned on for the first time, the PLUG IN MENU is displayed on the screen.
Refer to page 28 to page 30 and perform the LANGUAGE, AUTO TUNER SET UP, and SET CLOCK settings.
(The detailed information about the basic menu operations is in the "Using the Onscreen Menus" section on page 27.)

Caution:

- If this is not the first time that this television has been turned on, the PLUG IN MENU will not be displayed. In this case, the same settings can be performed from the INITIAL SETUP MENU and CLOCK/TIMER MENU.

The above completes the basic preparation which is necessary to watch the television.

Please enjoy using this television after reading the "Watching television" section on the next page and understanding about turning the power on and off.

Watching television

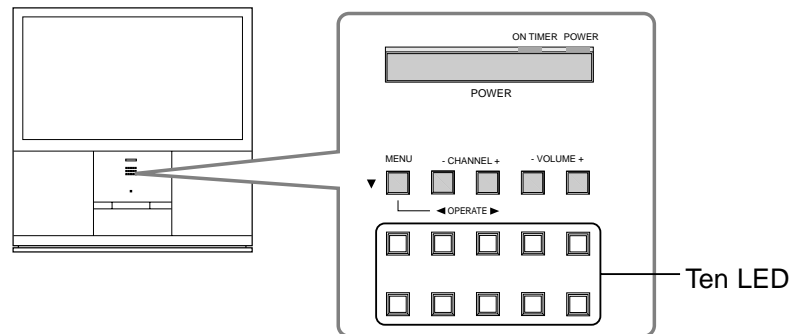

POWER ON (STARTING UP)

In order to control the television with the remote control, set the TV/CATV switch to TV. Press the POWER button. The POWER lamp on the front of the main unit lights red. After a while, the picture appears on the screen.

Notes:

- This television uses a lamp to project the picture onto the screen. As the lamp warms up, the picture can be seen more clearly. There are 10 LED indicators on the front panel. These can be used as a guide to when the warming up will be finished.
- When the power is turned on, the 10 LED indicators light green and then go out one at a time approximately every 5 seconds.

Adjusting the volume

The volume is adjusted by pressing either the VOLUME + or – buttons on the main unit or the VOL + or – buttons on the remote control. When you want to turn the sound off temporarily, press the MUTING button. Pressing the MUTING button again returns the sound to its previous volume.

Choosing a channel

A channel is selected by using the 10-key pad on the remote control. For single digit channels, first press “0” and then the channel number. For channels numbers 100 and higher, first press “100+” and then the last two digits. The channels can be selected in order by pressing either the CHANNEL + or – buttons on the main unit or the CH + or – buttons on the remote control.

HYPER SCAN

If the remote control CH + or - button is held down, after scanning a few channels at the normal speed, the chan-

Note: Only the channels which were added with the AUTO TUNER SET UP function can be selected by CH+ or – buttons

nels are scanned at a speed of 5 per minute.

If a CATV BOX is being used, setting the remote control TV/CATV switch to CATV allows the CATV BOX to be operated with the remote control. When this switch is set to CATV, only the CATV BOX can be operated with the remote control. When you want to operate the television again, return the TV/CATV switch to TV.

POWER OFF (SHUTTING OFF)

Press the POWER button. The picture on the screen darkens from the outsides like a pair of curtains closing. 10 LED indicators on the front panel light two at a time in a clockwise direction. While the lights are moving clockwise, the inside of the television and the lamp are being cooled. This is called the cooling mode. After the cooling has been performed for approximately one minute, the power is turned off.

Note: The television can not be operated while in the cooling mode. If you decide that you want to turn the power on while in the cooling mode, please wait until the cooling has been completed.

CAUTION: Do not remove the electric plug until after the cooling has been completed. If the electric plug is removed without performing the cooling operation, the internal circuits and lamp may overheat leading to the life of the lamp being shortened and the possibilities of malfunctions.

Cancelling the shutting off

If the power button is pressed again while the curtains are still closing, the shutting off is cancelled and the television can be watched again.

Connections



RF Cable

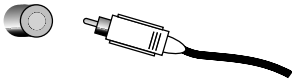

A/V Plug

S-Video Plug

AV Compu Link Plug

■ Front Panel Diagram

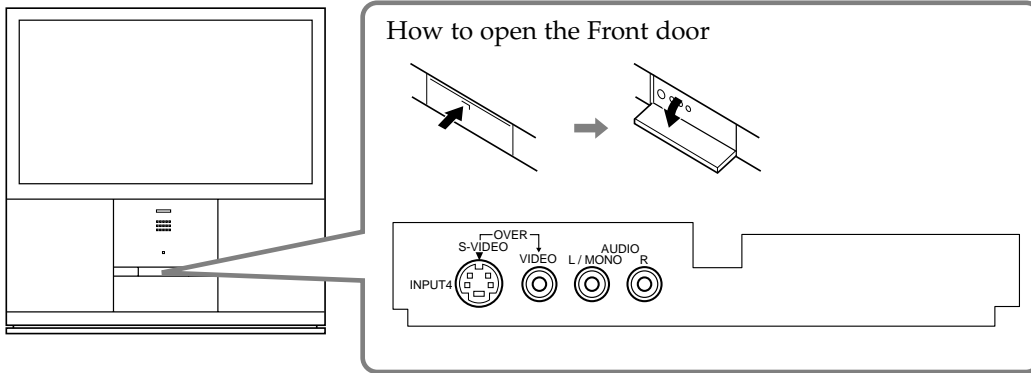

■ Rear Panel Diagram

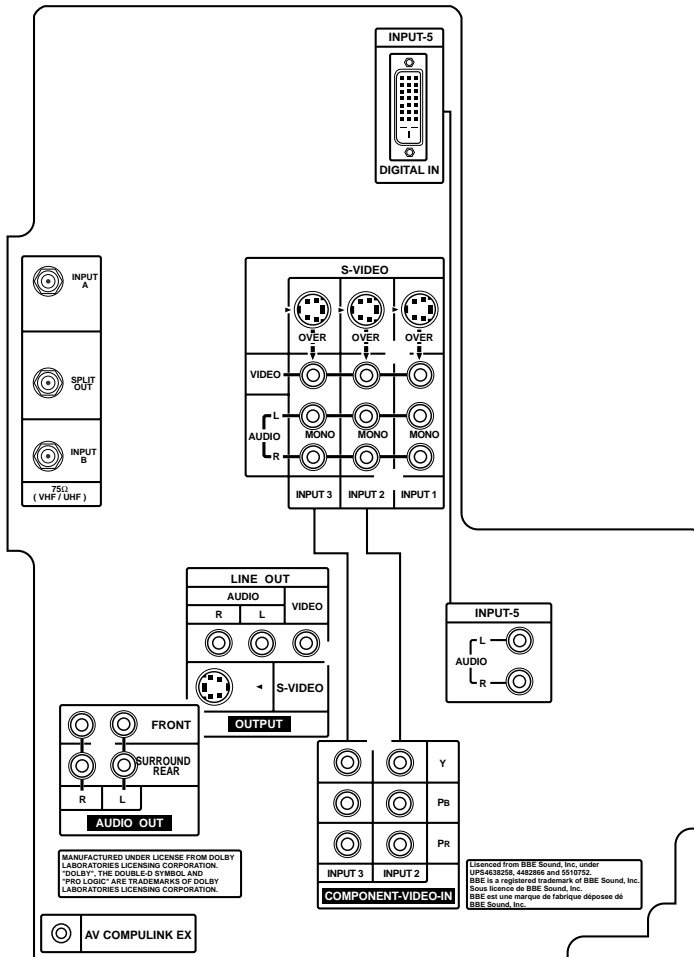

Connections



Connections

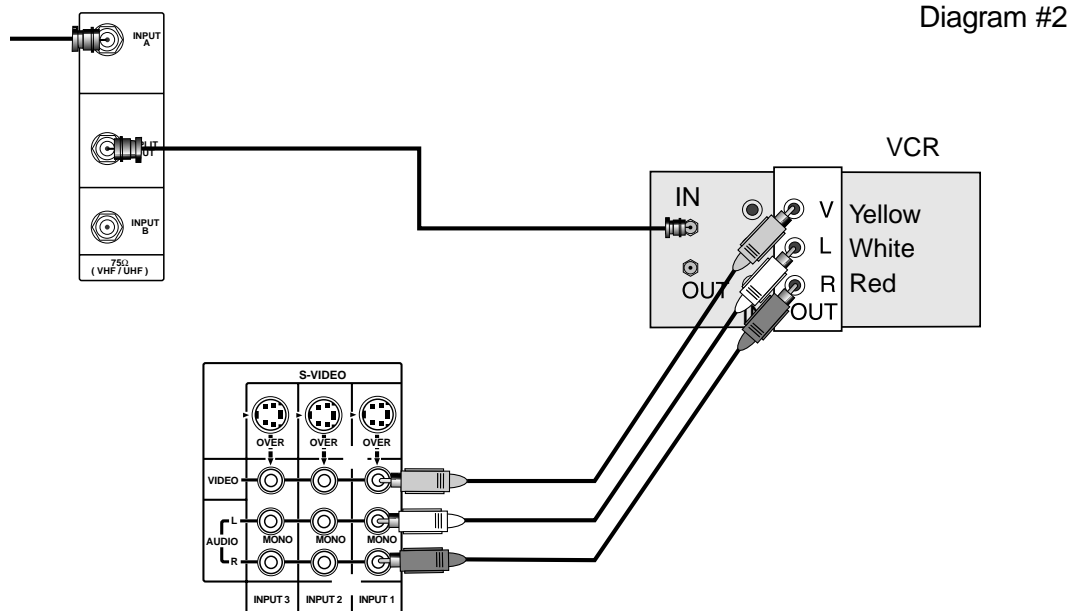

- 1) Connect a coaxial cable out from the cable TV wall outlet or external antenna into the RF Input A.
 - 2) Connect a coaxial cable out from the Cable Split Out RF jack into the RF input on the VCR.
 - 3) Connect the yellow video cable from the VCR's Video Output jack to the TV's Video Input 1 jack.
 - 4) Connect the white audio cable from the VCR's Left Audio Output jack to the TV's Left Audio Input 1 jack.
 - 5) Connect the red audio cable from the VCR's Right Audio Output jack to the TV's Right Audio Input 1 jack.
- If you are connecting a mono sound VCR it will have only one audio out jack. Connect it to the TV's left audio input jack.
 - The VCR signal will be available on Input 1 on the Input Menu (see page 54) if the connection shown above is used.
 - Coaxial cables are not included with the television.
 - Please consult your VCR's owners manual for more information on its operation.

S-Video Connection

You may also choose to connect video devices (VCR, Camcorders, etc) by using an S-Video Cable. S-Video may be substituted in any of the connections diagrams included here. To use S-Video:

- 1) Plug an S-Video cable out from the video device and in to the TV's S-Video Input.

Keep the audio connections the same as shown in the diagrams. Make sure that the S-Video cable and audio cables are plugged into the same input (for example, S-Video and audio cables into the Input 1 set of jacks).

Connections

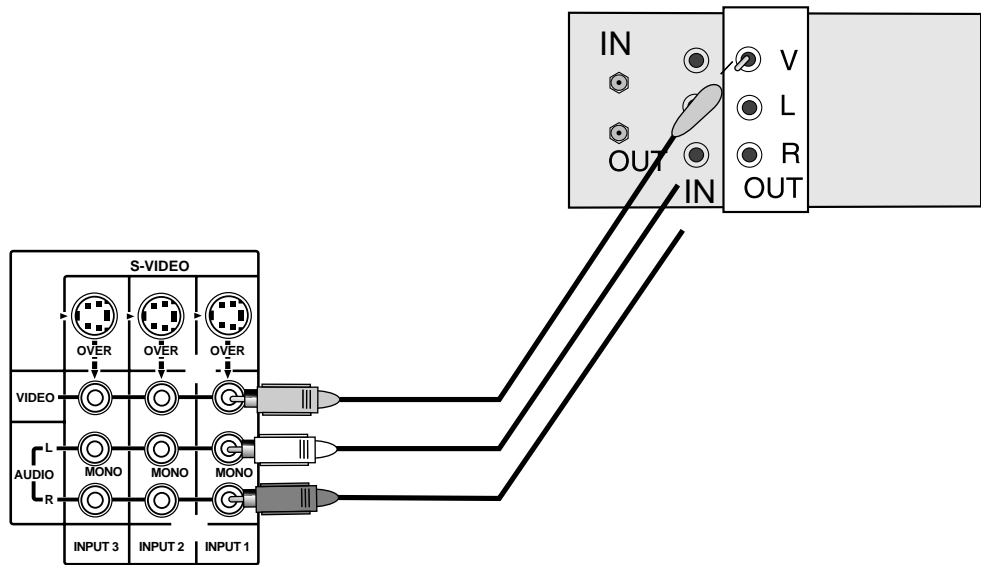
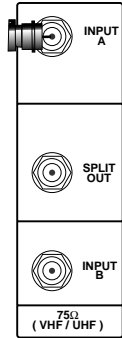

Connections

DTV Decoder Connection

Your AV-61S902 television is HDTV and SDTV-Ready. This means it can display High Definition television images when connected to a digital television receiver*. DTV Decoders are available separately. For best image quality, we recommend using a DTV Decoder which uses Component Video (Y, P_B, P_R) Output to connect to the television. The diagram below shows how to connect a DTV Decoder with using the television's Component Video-in jacks.

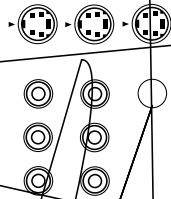

Connections

DTV Decoder Connection

<When connecting a DTV decoder which has a copy-protect Digital-Out terminal>

By inputting a High-band with Digital Content Protection high-definition picture source to the Digital-In terminal of this television, high-definition pictures can be displayed on the screen in their digital form. (This terminal is for use in the future when High-band with Digital Content Protection DTV decoders and DVD players and D-VHS are put on the market.)

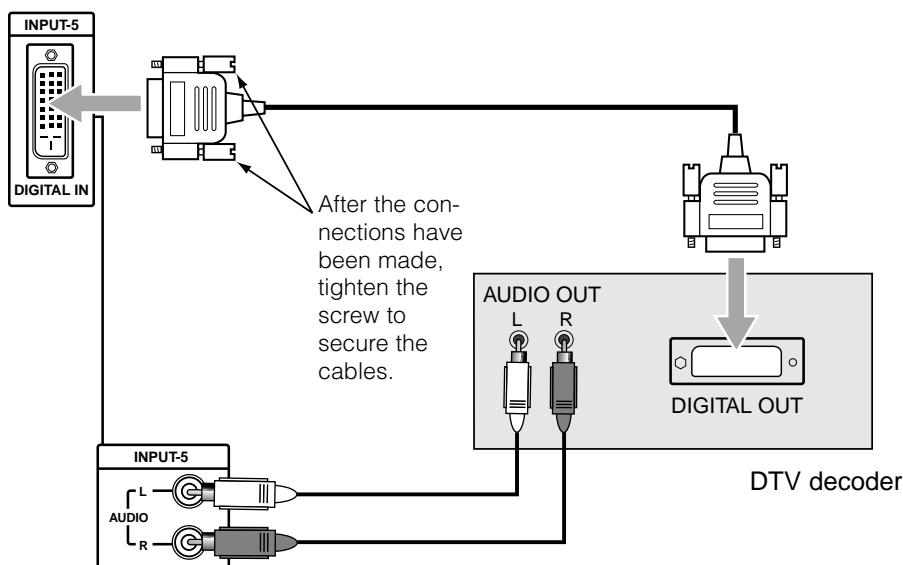

- 1) Connect the DTV digital RGB output terminal to the INPUT-5 digital input terminal of the television, and then tighten the 2 screws.
 - 2) Connect the DTV decoder left audio output to the INPUT-5 left audio input.
 - 3) Connect the DTV decoder right audio output to the INPUT-5 right audio input.
- The Digital-In terminal can only be used with 1080i and 480p picture signals. Set the DTV decode Digital-Out terminal output setting to 1080i or 480p. For detailed information, refer to the DTV decoder instruction manual. If you can not display the picture because your DTV decoder does not have a Digital-Out terminal output setting, use the component Video Input (or the S-Video Input or Video Input). (Refer to page 15) In this case the picture will be displayed as an analog signal.
 - The Digital-In terminal is not compatible with the picture signal of a personal computer.
 - Use a DVI 25-pin cable (commercially available) in order to digitally connect the television with a DTV decoder.
 - If the connection shown above is used, the DTV signal will be available on Digital-In on the INPUT MENU. (refer to page 54).

If 480p signals (640x480 or 720x480) are displayed on the screen, the horizontal balance may be slightly shifted. In cases such as this, the horizontal balance can be adjusted by accessing "DIGITAL-IN" in the INITIAL SETUP Menu. (Refer to page 37.)

DVD Player Connection

You can use the Component Video input jacks to connect a DVD player to your television. To connect a DVD player, please follow the steps listed below.

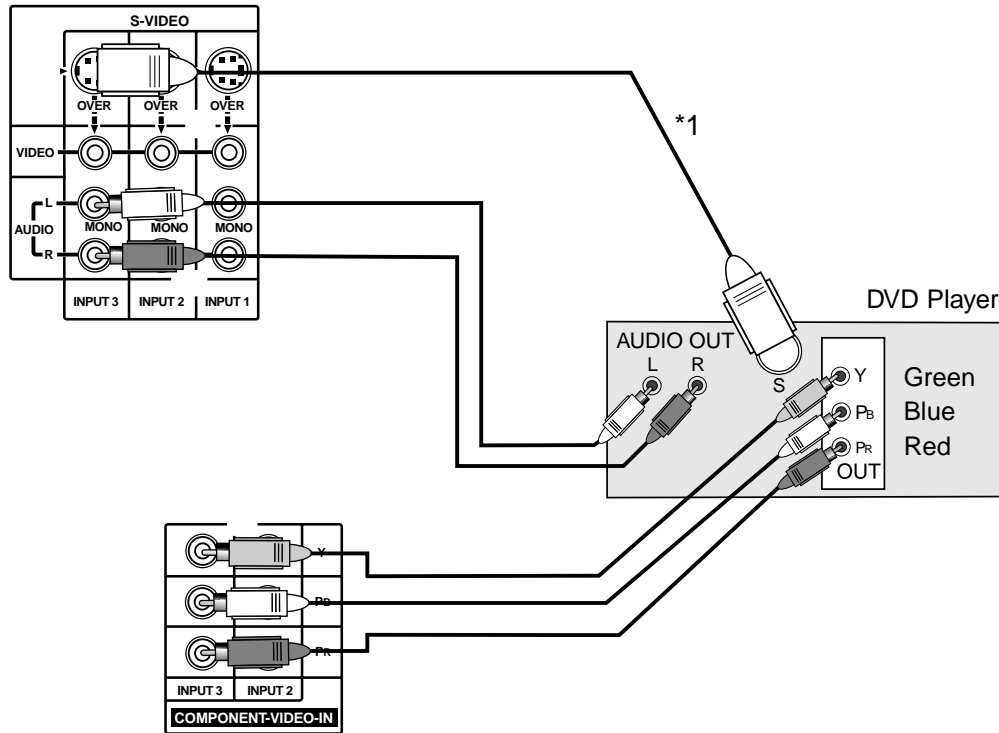

- 1) Connect Green cable out from the DVD Player "Y" Video Output, in to TV "Y" Component Input.
- 2) Connect Blue cable out from the DVD Player "Pb" Video Output, in to TV "Pb" Component Input.
- 3) Connect Red cable out from the DVD Player "Pr" Video Output, in to TV "Pr" Component Input.
- 4) Connect White Audio cable out the DVD Player Left Audio Output, in to TV Left Audio Input.
- 5) Connect Red Audio cable out the DVD Player Right Audio Output, in to TV Right Audio Input.

Make sure you use the same numbered input for both the Component Input and Audio Input. For instance, if you use Component Input 3, also use Audio Input 3.

- Green, blue and red are the most common colors for Component Video cables. Some models may vary colors, please consult the user's manual for your DVD Player for more information.
- Be careful not to confuse the red Component Video cable with the red audio cable. It is best to complete one set of connections (Audio or Video) before starting the other to avoid accidentally switching the cables.
- If your DVD player does not have a Component Video output, you may connect it using an S-Video cable. See your DVD player's owners manual for more information on making an S-Video connection.

Note:

*1: The picture signal input from the component input terminal of the television can not be used for split screens. If you want to display the picture from the DVD player when using split screens, also connect the S-Video cable.

Connections

AV Compu-Link

JVC's AV Compu Link feature makes playing video tapes totally automatic. Simply insert a pre-recorded tape* into your JVC-brand VCR and the VCR will automatically turn on and begin playback. At the same time, using the AV Compu Link, the VCR sends a signal to the television telling it to turn on and switch to the proper video input to watch a video tape.

- The AV Compu Link cable may be included with the JVC AV Compu Link accessory you wish to connect. If it is not, contact an authorized JVC Service Center for part # EWP 805-012.
- AV Compu Link can only be used with JVC-brand products.

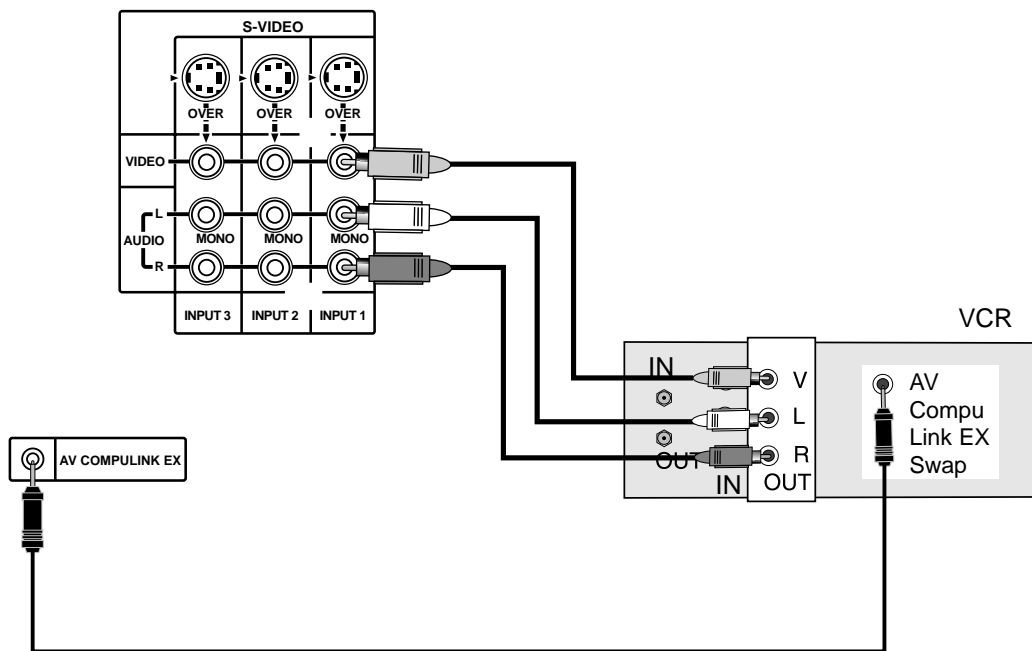

To Connect: Plug one end of the AV Compu Link cable into the AV Compu Link input on your VCR or other Compu Link device. Plug the other end of the AV Compu Link cable into the AV Compu Link input at the rear of the television.

Notes:

- * In order for the VCR playback to begin automatically, the recording tabs must be removed from the VHS tape. If the tab is in place, automatic switching will occur when you push the VCR's PLAY button.
- The AV Compu Link cable has a male 3.5 mm (mono) plug on each end.
- When the television is in cool down mode, it will not accept signals from an AV Compu Link device.
- If your JVC-brand VCR has "A Code/B Code Remote Control Switching" (see your VCR's instruction book), using VCR A Code will switch the TV to input 1. If you use Input 1 for video input from your cable box, use VCR B Code to select the TV Video Input 2.
- To connect a JVC HiFi receiver or amplifier for a completely automated home theater, see the HiFi's connection instructions for detailed connection information.
- AV COMPULINK EX is compatible with the following receivers: RX-664V, RX-665V, RX-668VBK, RX-774V, RX-778VBK, RX-884V, RX-888VBK, RX-1024V, RX-1028VBK, and later receiver models.
- The AV-61S902 can also receive Compu-Link signals from a DVD player. For details on operating a DVD player with AV Compu Link, please see your DVD player's owners manual.

Front Panel Inputs

A set of inputs (Input-4) are provided for your convenience on the front panel of the AV-61S902. The inputs are located behind the door at the center of the front panel below the indicator lights. These inputs are designed for the easy connection of devices like camcorders or game consoles which are not permanent parts of your home entertainment center.

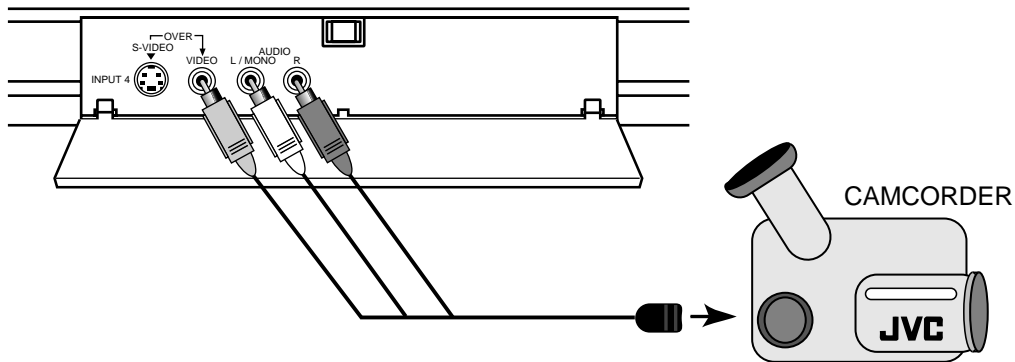

To access the front panel jacks, press lightly on the top center of the front panel door to open it. To connect a device like a camcorder:

- 1) Connect the yellow video cable from the device's Video Output jack to the TV's Video Input jack.
 - 2) Connect the white (or black) audio cable from the device's Left Audio Output jack to the TV's Left Audio Input jack.
 - 3) Connect the red audio cable from the device's Right Audio Output jack to the TV's Right Audio Input jack.
- If you are connecting a mono sound device it will have only one audio out jack. Connect it to the TV's left audio input jack.
 - The device will be available on Input 4 on the Input Menu (see page 54) if the connection shown above is used.
 - Please consult your camcorder or other device's owners manual for more information on its operation.

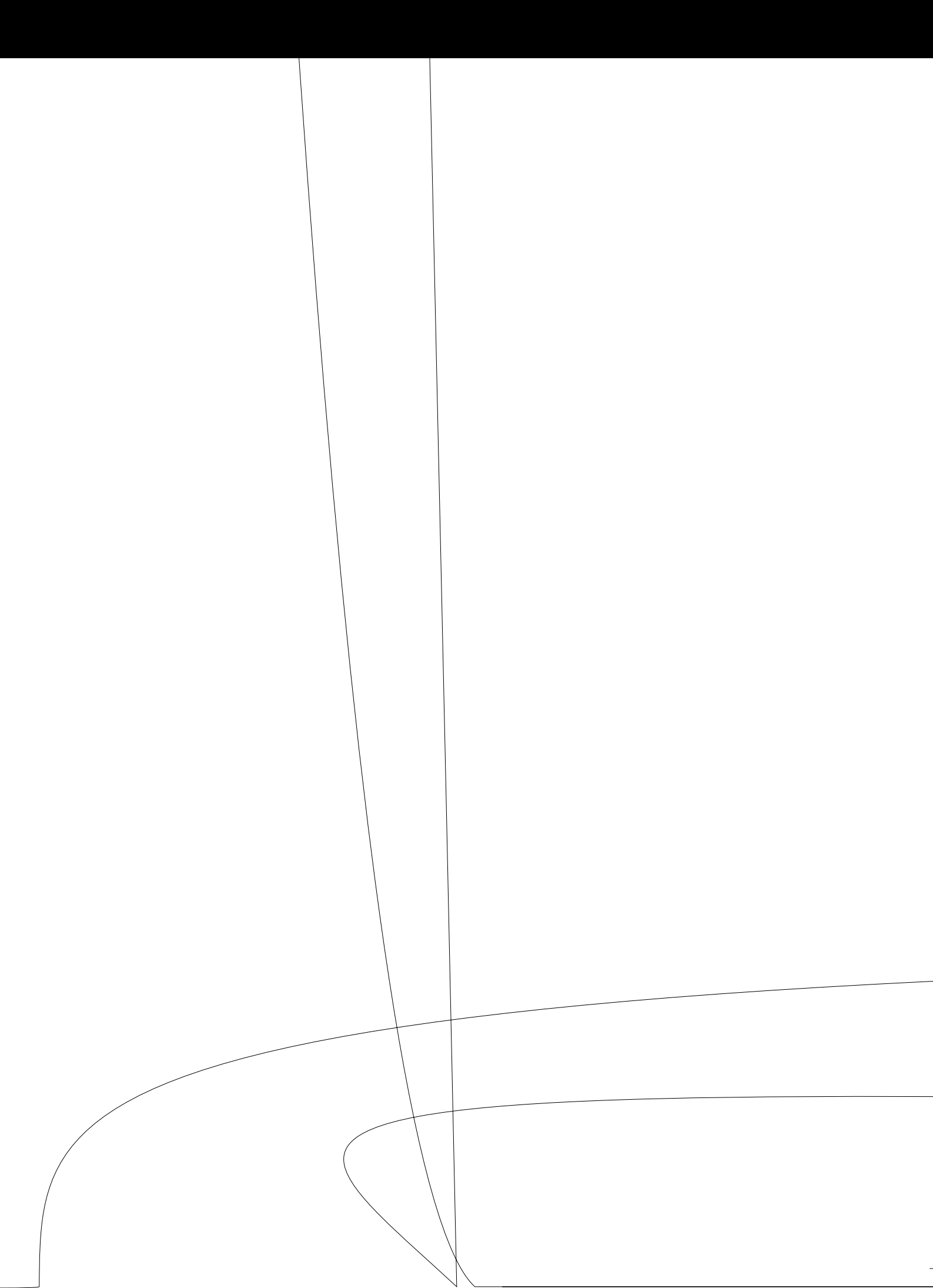

Remote Control

Install the Batteries

- Before you can operate the remote control, you must first install the batteries (included). Push down on the remote's back cover and slide towards the bottom to remove it. Insert two AA batteries (supplied), carefully noting the "+" and "-" markings on the batteries and on the remote control. To avoid a potential short circuit, insert the "-" end first. Be sure to use only size AA batteries. When batteries are installed, slide the cover back into place (until it clicks into position).
- If the remote control acts erratically, replace the batteries. Typical battery life is six months to one year. We recommend using alkaline batteries for longer battery life. When you change the batteries, try to complete the task within three minutes. If you take longer than three minutes, the remote control codes for your VCR, DVD, and/or Cable Box may have to be reset (pages 22-25).

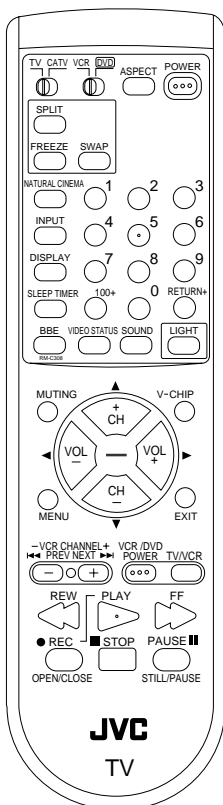
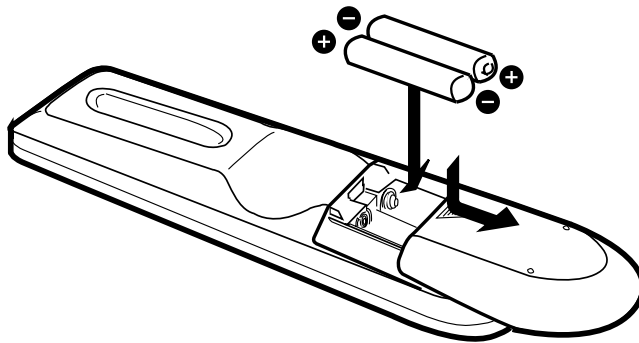

Remote Control Basics

- Press the POWER button to turn the television on or off.
- **Make sure the TV/CATV switch** is set to TV. Move the switch to CATV only if you need to operate a cable box.
- **Slide the VCR/DVD selector switch** to VCR to control a VCR, slide to DVD to control a DVD player. Please see pages 22 to 25 for instructions on programming your remote control to operate a Cable box, VCR or DVD player.
- Press the CH+ and CH- buttons to scan through the channels. Tap the CH+ or CH- button to move through the channels one channel at a time.
- To move rapidly through the channels using JVC's **Hyperscan** feature, press and hold CH+ or CH-. The channels will zip by at a rate of five channels per second.
- Press VOL+ or VOL- to raise or lower the volume. An indicator bar will appear onscreen to show you the television volume level.
- The CH+/- and VOL+/- buttons are also used to navigate JVC's onscreen menu system.
- You can directly access specific channels using the 10-key pad.
- For more information on remote control button features, see pages 50 to 55. For information on using the onscreen menus, see page 26.

Remote Programming

Setting the CATV, VCR and DVD Codes

You can program your remote to operate your cable box, satellite receiver, VCR or DVD player by using the instructions and codes listed below. If the equipment does not respond to any of the codes listed below or to the code search function, use the remote control supplied by the manufacturer.

Cable Box or Satellite setup

The remote control is programmed with CATV and/or Satellite codes for power on, power off, channel up, channel down, and 10 key operation.

- 1) Find the CATV/Satellite brand from the list of codes shown below.
 - 2) Slide the 2-way selector switch to "CATV".
 - 3) Press and hold down the DISPLAY button.
 - 4) With the DISPLAY button held down, enter the first code number listed using the 10 key pad.
 - 5) Release the DISPLAY button.
 - 6) Confirm the operation of the Cable Box/Satellite receiver.
- If your CATV or Satellite box does not respond to the first code, try the others listed. If it does not respond to any code, try the Search Codes Function, on page 25.

Cable Box	CODES	Cable Box	CODES	Digital Satellite Systems	CODES
ABC	024	Puser	032		
Archer	032, 025	RCA	061, 070	Echostar	100, 113, 114
Cableview	051, 032	Realistic	032	Express VU	100, 113
Citizen	022, 051	Regal	058, 064, 040, 041, 042, 045, 068	G.E.	106
Curtis	058, 059	Regency	034	G.I.	108
Diamond	024, 032, 025	Rembrandt	037, 032, 051, 038	Gradiente	112
Eagle	029	Samsung	051	Hitachi	104, 111
Eastern	034	Scientific Atlanta	057, 058, 059	HNS (Hughes)	104
GC Brand	032, 051	SLMark	051, 047	Panasonic	105
Gemini	022, 043	Sprucer	051, 056	Philips	102, 103
General Instrument	065, 024, 025, 026, 027, 020, 021, 022, 057, 023	Stargate	032, 051	Primestar	108
Hamlin	040, 041, 042, 045, 058, 064	Telecaption	067	Proscan	106, 109, 110
Hitachi	049, 024	Teleview	047, 051	RCA	106, 109, 110
Jerrold	065, 024, 025, 026, 027, 020, 021, 022, 057, 023	Texscan	044	Sony	107
Macom	049, 050, 051, 054	Tocom	035, 036, 066	Star Choice	104, 108
Magnavox	033	Toshiba	050	Toshiba	101
Memorex	030	Unika	032, 025	Uniden	102, 103
Movietime	032, 051	Universal	022, 032		
Oak	039, 037, 048	Videoway	052		
Panasonic	055, 056, 060, 071	Viewstar	029, 030		
Paragon	063	Zenith	063, 046		
Philips	028, 029, 030, 052, 053, 031, 069	Zenith/Drake Satellite	046		
Pioneer	047, 062				
Pulsar	051, 032				

Remote Programming

VCR setup

The remote control is programmed with VCR codes for power on, power off, play, stop, fast-forward, rewind, pause, record, channel up, and channel down operation.

- 1) Find the VCR brand from the list of codes shown below.
 - 2) Slide the first 2-way selector switch to "TV" and the other 2-way selector switch to "VCR".
 - 3) Press and hold down the DISPLAY button.
 - 4) With the DISPLAY button held down, enter the first code number listed with the 10 key pad.
 - 5) Release the DISPLAY button.
 - 6) Confirm the operation of the VCR.
- If your VCR does not respond to the first code, try the others listed. If it does not respond to any code, try the Search Codes Function, on page 25.
 - Some manufacturer's VCR's may not respond to the Tv/VCR button, even if other buttons work properly.
 - To record, hold down the REC button on the remote and press PLAY.

VCRs	CODES	VCRs	CODES	VCRs	CODES
Admiral	035	Marantz	003, 004, 005	Samsung	037, 060, 062, 033, 089
Aiwa	027, 032, 095	Marta	064	Samtron	089
Akai	029, 072, 073, 074	Memorex	024, 067	Sansui	003, 026, 020, 052
Audio Dynamic	003, 005	MGA	038, 040, 047, 048, 041, 042	Sanyo	063, 067, 091, 071
Bell & Howell	063, 071	Minolta	058, 045, 093	Scott	059, 060, 062, 067, 038, 040, 047, 048, 026, 020
Broksonic	020, 026, 094	Mitsubishi	038, 040, 047, 048, 041, 042, 078, 090	Sears	063, 064, 065, 066, 058, 000, 001
Canon	023, 025	Multitech	047, 027, 062	Shintom	075
CCE	043	NEC	003, 004, 005, 000	Sharp	035, 036, 080, 088
Citizen	064	Olympic	024, 023	Signature 2000	027, 035
Craig	063, 029, 064	Optimus	028, 021, 035, 064	Singer	075
Curtis Mathes	045, 024, 027, 093	Orion	026, 020	Sony	028, 029, 030, 053, 054, 055
Daewoo	043, 059, 024, 092	Panasonic	023, 024, 021, 022	SV 2000	027
DBX	003, 004, 005	Penney	024, 058, 045, 063, 003, 004, 005, 093	Sylvania	031, 023, 024, 027
Dimensia	045, 093	Pentax	058, 005, 045, 093	Symphonic	027, 081
Emerson	043, 026, 077, 061, 025, 042, 020, 076	Philco	031, 024, 027, 023, 026, 020, 043	Tashiro	064
Fisher	063, 066, 067, 065, 071, 091	Philips	031, 023, 024, 086	Tatung	003, 004, 005
Funai	027, 026, 020, 000	Pioneer	023	Teac	003, 004, 027, 005
G.E.	033, 045, 024	Proscan	045, 058, 023, 024, 031, 046, 059, 060, 033, 087, 093	Technics	021, 022, 023, 024
Go Video	037, 051, 049, 050, 089	Quasar	021, 022, 023, 024	Teknika	024, 027, 070
Goldstar	064	Radio Shack	033, 024, 063, 036, 067, 040, 027	Toshiba	059, 046, 079
Gradiente	083, 084, 081, 000, 001	RCA	033, 045, 058, 023, 024, 031, 046, 059, 060, 083, 084, 085, 087, 093	Vector Research	005
Hitachi	023, 045, 058, 027, 081, 093	Realistic	024, 063, 036, 067, 040, 027	Wards	035, 036, 067, 044, 064
Instant Replay	024, 023			Yamaha	063, 003, 004, 005
Jensen	003			Zenith	044, 082, 064, 094
JVC	000, 001, 002, 003, 004, 005				
Kenwood	003, 004, 064, 005				
LXI	027, 064, 058, 065, 066, 063, 067				
Magnavox	031, 023, 024, 086				

Remote Programming

DVD setup

The remote control is programmed with DVD codes for power on, power off, play, stop, fast-forward, rewind, previous chapter, next chapter, tray open/close, and still/pause operation.

- 1) Find the DVD player brand from the list of codes shown below.
 - 2) Slide the first 2-way selector switch to "TV" and the other 2-way selector switch to "DVD".
 - 3) Press and hold down the DISPLAY button.
 - 4) With the DISPLAY button held down, enter the first code number listed with the 10 key pad.
 - 5) Release the DISPLAY button.
 - 6) Confirm the operation of the DVD player.
- If your DVD player does not respond to the first code, try the others listed. If it does not respond to any code, try the Search Codes Function, on page 25.
 - After you program your remote, some DVD buttons may not work properly. If some buttons do not work properly, use the remote control which came with your DVD player.

DVD Player	CODES	DVD Player	CODES
Aiwa	043	Raite	033
Apex	040	RCA	021, 026
Denon	020, 037	Sampo	034
Hitachi	030, 031	Samsung	030
JVC	000	Sharp	028
Kenwood	035	Sylvania	038
Konka	039	Sony	024, 045, 046, 047
Mitsubishi	025		
Onkyo	041	Technics	020
Oritron	044	Toshiba	023
Panasonic	020	Wave	042
Philips	023, 036	Yamaha	020
Pioneer	022	Zenith	027, 032

Remote Programming

Search Codes

Cable/Satellite Search Codes Function:

- 1) Slide the 2-Way Mode Selector switch to CATV.
- 2) Press the TV POWER and RETURN+ buttons. Hold for at least three seconds and release.
- 3) Press TV POWER, see if the CATV or Satellite box responds.
- 4) If there was a response, press RETURN+. The operating codes are now set. If there was no response, repeat Step 3. If you repeat Step 3 a total of 52 times without a response, use the remote control which came with the equipment.
- 5) Press RETURN+ to exit.

VCR Search Codes Function:

- 1) Slide the first 2-way selector switch to "TV" and the other 2-way selector switch to "VCR".
- 2) Press the VCR POWER and RETURN+ buttons. Hold for at least three seconds and release.
- 3) Press VCR POWER, see if the VCR responds.
- 4) If there was a response, press RETURN+. The operating codes are now set. If there was no response, repeat Step 3. If you repeat Step 3 a total of 80 times without a response, use the manufacturers remote control which came with the VCR.
- 5) Press RETURN+ to exit.

DVD Player Search Codes Function:

- 1) Slide the first 2-way selector switch to "TV" and the other 2-way selector switch to "DVD".
- 2) Press the DVD POWER and RETURN+ buttons. Hold for at least three seconds and release.
- 3) Press DVD POWER, see if the DVD player responds.
- 4) If there was a response, press RETURN+. The operating codes are now set. If there was no response, repeat Step 3. If you repeat Step 3 a total of 30 times without a response, use the manufacturers remote control which came with the DVD player.
- 5) Press RETURN+ to exit.

Onscreen Menus

The Onscreen Menu System

The AV-61S902 comes with JVC's Onscreen Menu System. The Onscreen Menus let you make adjustments to your television's operation simply and quickly. Examples of the Onscreen Menus are shown below and on the next page. Detailed explanations on using each menu follow later in this guide.

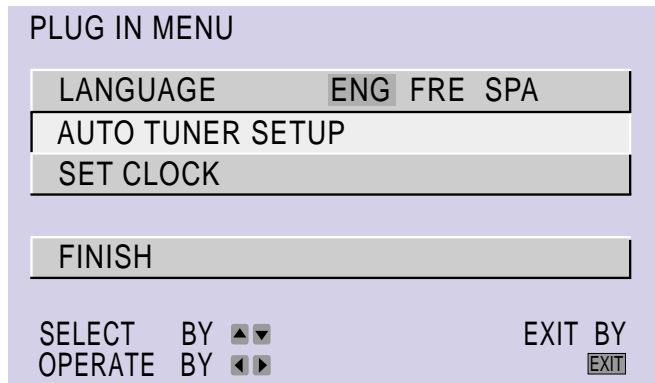

PLUG IN MENU

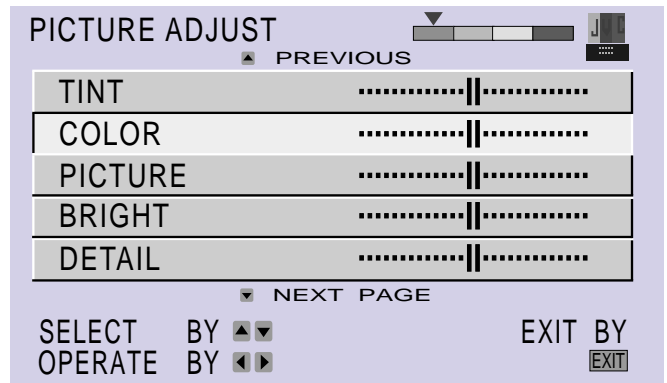

PICTURE ADJUST 1

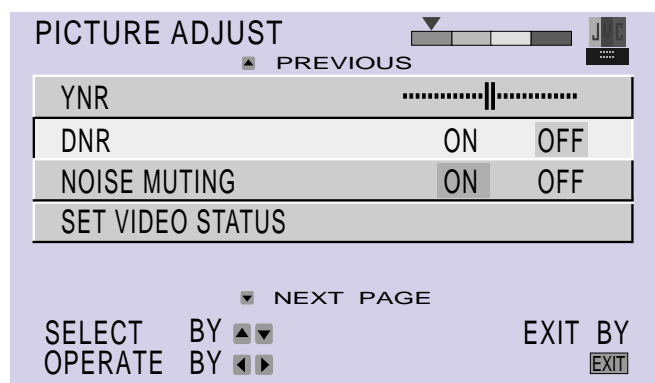

PICTURE ADJUST 2

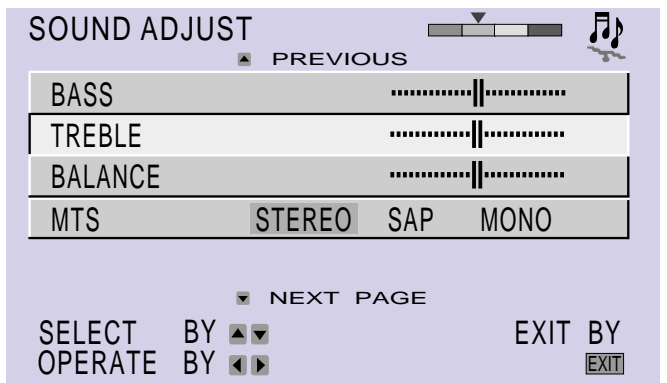

SOUND ADJUST

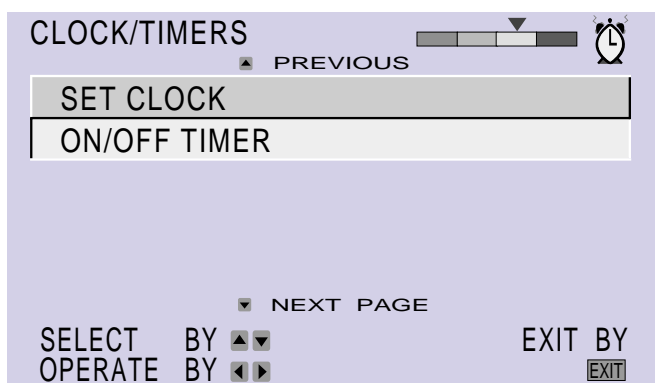

CLOCK/TIMERS

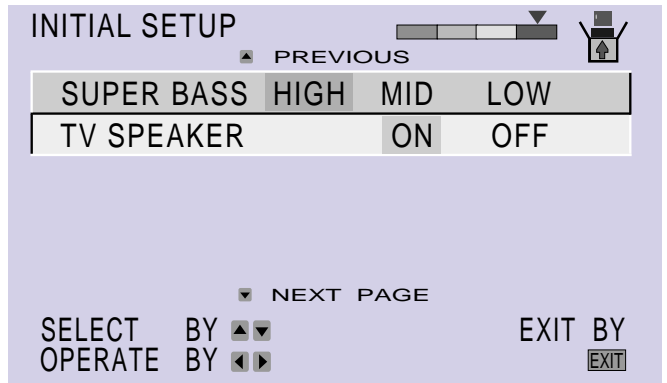

INITIAL SETUP

Onscreen Menus

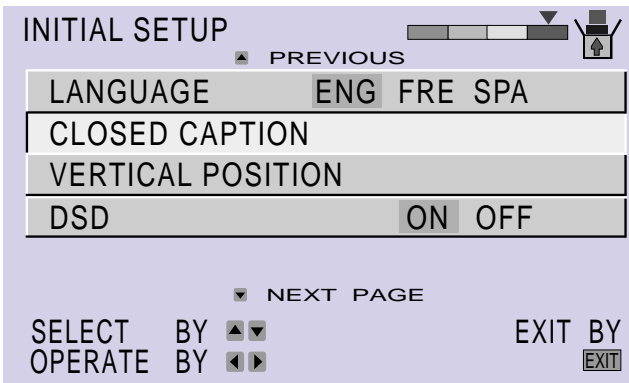

INITIAL SETUP

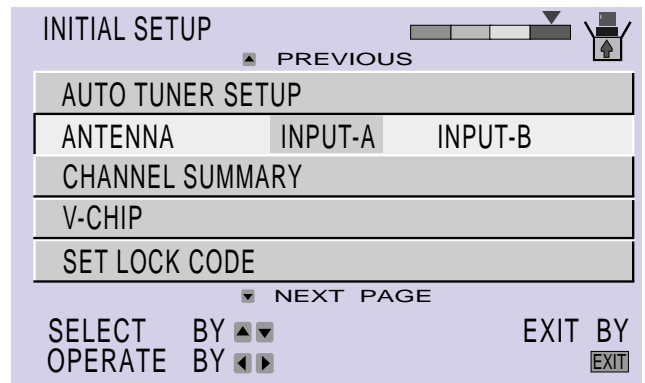

INITIAL SETUP

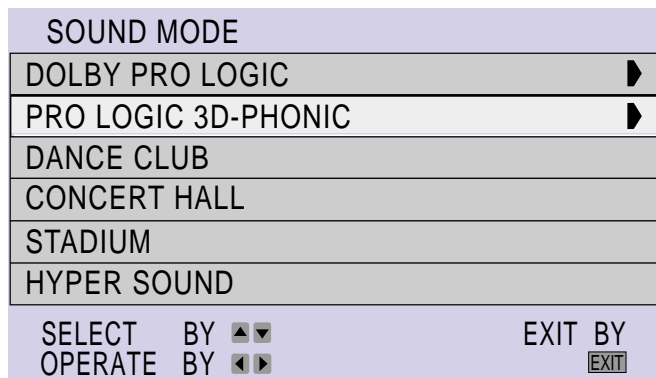

SOUND MODE

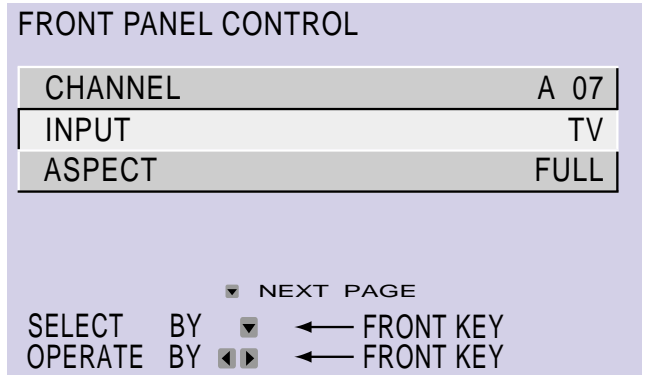

FRONT PANEL CONTROL

(Will appear only when MENU button on TV Front Panel is pressed.)

Using the Onscreen Menus

To open the Onscreen Menu system, press the MENU button on the remote control. You navigate within the Onscreen menus by using the four directional arrow buttons on the remote control. (These buttons are also the CH +/- and VOL +/- buttons - Channel and Volume functions will not operate when the Onscreen Menu is active).

The selected feature and option on a menu screen are highlighted in a different color.

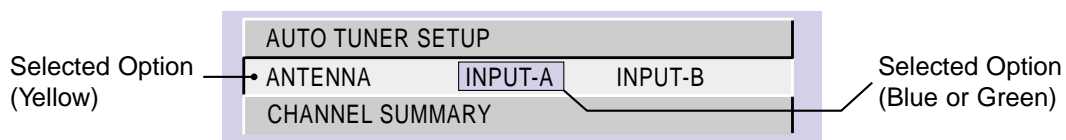

To move to a different feature use the ▲ ▼ arrows to move up or down the list. When you press the up arrow at the top of the list or the down arrow at the bottom, the next menu screen will appear. Use the ◀ ▶ arrows to select an option from the highlighted feature. Pressing EXIT on the remote control will close the Onscreen Menu system and return you to normal television viewing.

Each menu and its features will be discussed in the following pages of this guide.

Notes: You may also move to the next menu screen by pressing MENU again.

- If you do not press any buttons for a few seconds, the Onscreen menu will automatically shut off.
- Button names in this guide are shown in SMALL CAPITAL LETTERS.
- Menus may appear in different sizes onscreen depending on the aspect ratio selected.
- Some menu items may not appear in menu screens when certain aspect ratios or inputs are selected.

Plug In Menu

Plug In Menu

The first time you turn on your television, you will see the PLUG IN MENU. This menu is designed to help you get your television ready to watch right away. This menu includes some of the most important settings for the operation of your television, including onscreen display language, AUTO TUNER SETUP and setting the internal clock. It is important these preferences be set before you begin to use your new television. Detailed descriptions of each setting will follow.

- You may change these settings at any time by using the onscreen menu system.

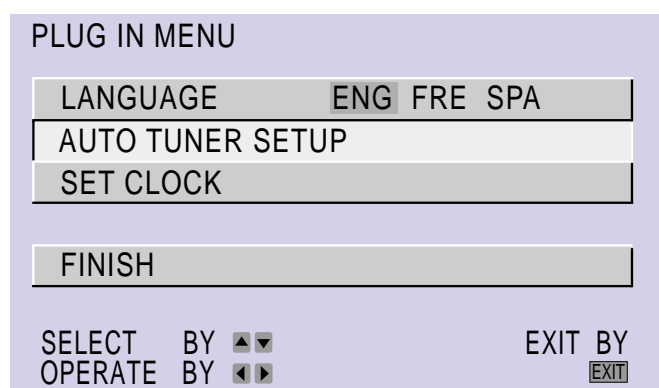

PLUG IN MENU

Use the up and down arrows ▲▼ to scroll to the first menu item. Use the ◀▶ arrows to move to the select the item. You can make adjustments to any or all of the settings.

LANGUAGE ENG FRE SPA

You can view the onscreen menu displays in one of three languages - English, French, or Spanish. When shipped from the factory, all menus will display in English. You can use the language setting to change the menus to one of the other two languages if you wish.

To change the language, use the ▲▼ arrows to move to LANGUAGE. With the Language option selected, use the ◀▶ arrows to move to the language you wish to select, English, French or Spanish. As you highlight a language, the menu will display in that language. Your selection will be entered when you move to a different option using the ▲▼ arrows or press EXIT to leave the menu system.

AUTO TUNER SETUP

The AUTO TUNER SETUP feature automatically scans through all the channels your television can receive and memorizes only the channels with clear, active signals. This means when you scan through the channels, you will receive only channels with good signals, no more annoying static or dead air.

The AV-61S902 has two RF signal inputs which can be setup independent of each other. For example, you can set one input up to receive signals from an antenna and the other to receive signals from a satellite dish.

To run AUTO TUNER SETUP, use the ▲▼ arrows to move to the AUTO TUNER SETUP option in the PLUG IN MENU. Select the option by pressing ◀ or ▶.

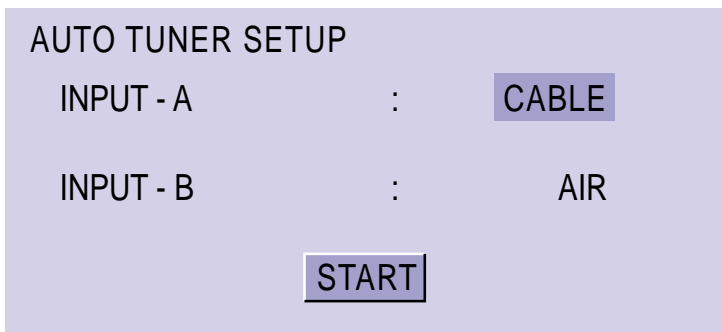

AUTO TUNER SETUP

The AUTO TUNER SETUP menu will now appear. Use the ◀ ▶ arrows to select antenna or cable as the signal source for INPUT-A (see pages 12 to 14 for information on connecting to an antenna or cable). Use the ▲ ▼ arrows to move to INPUT-B if you wish to set up INPUT-B as well, or to START to begin AUTO TUNER SETUP. If you select INPUT-B, use the ◀ ▶ arrows to select antenna or cable as the signal source and then move to START. Press ◀ or ▶ to begin AUTO TUNER SETUP.

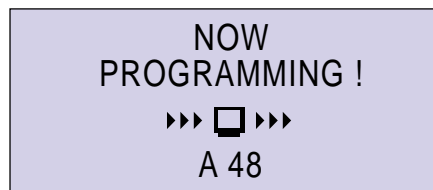

The television will now scan through all the channels it can receive, memorizing those with clear, active signals. AUTO TUNER SETUP will program INPUT-A and then INPUT-B if you have selected it also. Programming will take several minutes. When it is finished the following message will appear:

PROGRAMMING OVER!

You may add or delete channels from the Auto Tuner scan. If there are channels you do not wish to receive or if the Auto Tuner missed a channel which may have not been broadcasting or had a weak signal, you can modify the scan using the CHANNEL SUMMARY feature. For information on CHANNEL SUMMARY, see page 32.

Plug In Menu

SET CLOCK

The AV-61S902 is equipped with its own internal clock. The clock is used to run the television's timer features. The clock MUST be set before you can use any of the timer features. Your television features the XDS AUTO CLOCK set feature which makes setting the correct time simple.

To set the clock, use the ▲▼ arrows to move to SET CLOCK on the PLUG IN MENU. Select the option by pressing ◀ or ▶.

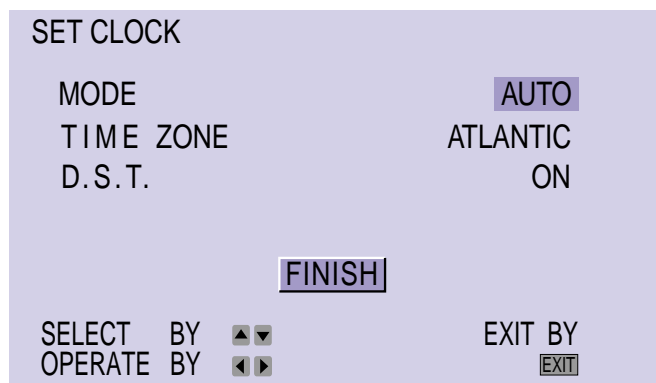

SET CLOCK (AUTO)

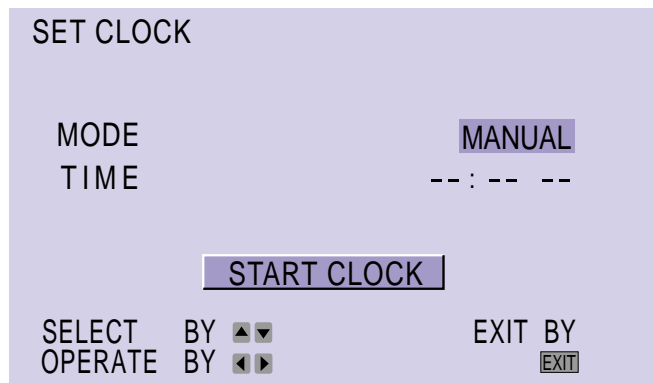

SET CLOCK (MANUAL)

The SET CLOCK menu will now appear. If you have a Public Television System station broadcasting in your local area you can select the AUTO option (PBS stations carry the XDS time signal). The television will automatically collect the time information. The only information you will need to provide is what time zone you are located in and if Daylight Savings Time is currently in effect.

Once the AUTO mode has been selected, use the ▼ arrow to move to TIME ZONE. Select the time zone using the ◀ or ▶ arrows. Once your time zone is set, use the ▼ arrow to move to D.S.T. Select D.S.T., by pressing ◀ or ▶. Choose ON or OFF with the ◀ or ▶ arrows. To finish, use the ▼ arrow to select ON or OFF. Now use the ▼ arrow to move to FINISH. Finish by pressing ◀ or ▶.

If you do not have a PBS station in your local area, or if the AUTO option does not give you the correct time for your area, you will have to set the time manually. Select the MANUAL option. To set the clock manually, use the ▼ arrow to move to the Time. Use the ◀ or ▶ arrows to set the hours. Press the ▼ arrow to move to minutes. Set the minutes with the ◀ or ▶ arrows. When the correct time is set, use the ▼ arrow to move to START CLOCK. Press ◀ or ▶ to start the clock and exit.

• **Special Note for residents of Newfoundland in Canada.** The Newfoundland time zone is not included in the time zones listed in AUTO CLOCK SETUP. If you live in the Newfoundland time zone, you must set your clock using the manual clock set option.

FINISH

Once you have completed setting the options in the PLUG IN MENU, choose FINISH to leave the menu and begin watching your television. Use the ▲▼ arrows to move to FINISH at the bottom of the PLUG IN MENU. Select FINISH by pressing ◀ or ▶.

Your PLUG IN MENU settings are now complete. You may now begin watching your television. If you wish to further customize your television to your viewing preferences, please continue reading.

Note: You can change your PLUG IN MENU settings at any time. You can access LANGUAGE, AUTO TUNER SETUP and SET CLOCK from the onscreen menu system.

Initial Setup Menu

While the PLUG IN MENU will help you get your television ready to watch right away, the INITIAL SETUP menu gives you access to many built-in functions to help you customize your television to meet your personal viewing tastes. This manual will describe how each function works in the order they appear in the onscreen menu system. Some of these items will also appear in the PLUG IN MENU. If you wish to change the settings of these menu items from the settings you entered while using the PLUG IN MENU, you may do so from the INITIAL SETUP menus.

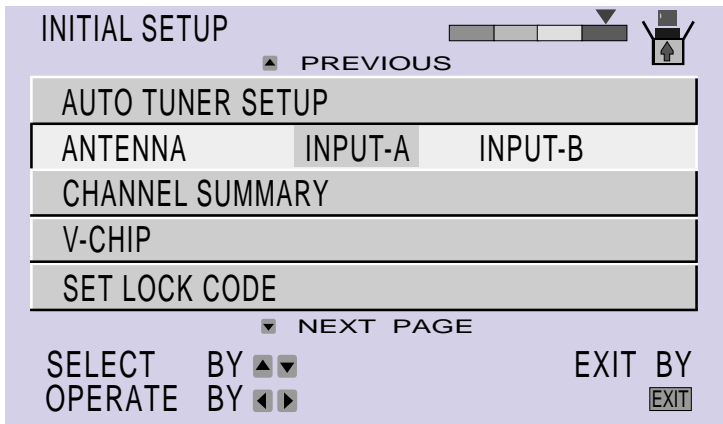

INITIAL SETUP Menu

AUTO TUNER SETUP

The AUTO TUNER SETUP function is described on page 29. If you need to run AUTO TUNER SETUP again, select the option from the INITIAL SETUP menu by using the ▲▼ arrows to move to the AUTO TUNER SETUP option in the INITIAL SETUP menu. Select the option by pressing ◀ or ▶. Please see page 29 for instructions on running the AUTO TUNER SETUP feature.

ANTENNA INPUT-A INPUT-B

Select the antenna input you wish to use. The signal from the input you select will be displayed as the ANTENNA signal in the list of inputs (see Button Functions - Input, page 54). Select the Input from the INITIAL SETUP menu by using the ▲▼ arrows to move to the ANTENNA option in the INITIAL SETUP menu. Select the option by pressing ◀ or ▶. Use the ◀ or ▶ arrows to select INPUT-A or INPUT-B.

Initial Setup

CHANNEL SUMMARY

CHANNEL SUMMARY lets you customize the list of channels set after you run AUTO TUNER SETUP. You may delete unwanted channels or add channels that are new, or were not picked up by AUTO TUNER SETUP because of weak signals.

To access the CHANNEL SUMMARY, use the ▲▼ arrows to move to the CHANNEL SUMMARY option in the INITIAL SETUP menu. Select the option by pressing ◀ or ▶.

The CHANNEL SUMMARY screen will now be displayed with the channels set to scan marked with a "✓". You can delete channels from the scan by removing the "✓". If any channels were missed during AUTO TUNER SETUP and you wish to add them, you may by placing a "✓" next to the channel number.

To add or delete channels, use the ▲▼ arrows to move to the SCAN column. Use the ▲▼ arrows to move through the list of channels.

Press ◀ or ▶ to include or delete channels from scanning. When you have added or deleted all the channels you wish, you can leave the CHANNEL SUMMARY screen by pressing EXIT on the remote control.

CHNO.	SCAN	🔒	CHNO.	SCAN	🔒
01			06	✓	
02	✓		07		
03	✓		08		
04	✓		09	✓	
05	✓		10	✓	

Channel Summary - Lock

You can also use the CHANNEL SUMMARY screen to lock certain channels. When a channel is locked, a code must be entered before the channel can be viewed.

CHNO.	SCAN	🔒
01	✓	
02		
03		
04		
05		

To lock or unlock channels, use the ▲▼ arrows to move to the Lock column (marked with the 🔒 icon). use the ▲▼ arrows to move through the list of channels. Press the ZERO button on the remote control to lock or unlock a specific channel. A channel is locked when the 🔒 icon appears next to it. When you are finished, you can leave the CHANNEL SUMMARY screen by pressing EXIT on the remote control.

Channel Guard Message

When a viewer attempts to watch a guarded channel, this message appears:

For a channel that you have locked, enter the Lock Code using the 10 key "Set Lock Code" - page 35). If the wrong code is entered, the message "WRONG LOCK CODE!" will flash on the screen. The channel cannot be accessed until the correct code is entered.

When the channel has been unlocked, it will remain unlocked until the TV is turned off.

THIS CHANNEL IS LOCKED BY
CHANNEL GUARD.
PLEASE ENTER LOCK CODE BY
10 KEY PAD TO UNLOCK IT.

NO. - - - -

V-Chip

Your TV is equipped with V-Chip technology which enables TV Parental Guideline and Movie (MPAA) Guideline controls. V-Chip technology allows you to program your TV to receive, or not to receive, programs based on content according to the guidelines. Programs which exceed the ratings limits you set will be blocked from viewing.

U.S. Parental Rating Systems

Programs with the following Ratings are appropriate for Children.

TV-Y is Appropriate for All Children. Programs are created for very young viewers and should be suitable for all ages, including children ages 2 - 6.

TV-Y7 is for Older Children. Most parents would find such programs suitable for children 7 and above. They may contain some mild fantasy violence or comedic violence, which children should be able to discern from reality.

Programs with the following Ratings are designed for the entire audience.

TV-G stands for General Audience. Most parents would find these programs suitable for all age groups. They contain little or no violence, no strong language, and little or no sexual dialog or situations.

TV-PG Parental Guidance Suggested. May contain some, but not much, strong language, limited violence, and some suggestive sexual dialog or situations. It is recommended that parents watch these programs first, or with their children.

TV-14 Parents Strongly Cautioned. Programs contain some material that may be unsuitable for children under the age of 14 including possible intense violence, sexual situations, strong coarse language, or intensely suggestive dialog. Parents are cautioned against unattended viewing by children under 14.

TV-MA Mature Audiences Only. These programs are specifically for adults and may be unsuitable for anyone under 17 years of age. TV-MA programs may have extensive V, S, L, or D.

Viewing Guidelines

In addition to general ratings, programs may include specific information on content. The following codes are used:

- V/FV is for VIOLENCE/FANTASY VIOLENCE
- S stands for SEXUAL CONTENT
- L stands for strong LANGUAGE
- D stands for suggestive DIALOG

MPAA (Motion Picture Assoc. of America) Ratings

NR - Not Rated.

This is a film which has no rating. In many cases these films were imported from countries which do not use the MPAA ratings system. Other NR films may be from amateur producers who didn't intend to have their film widely released.

"NR" Programming may contain all types of programming including children's programming, foreign programs, or adult material.

G - General Audience. In the opinion of the review board, these films contain nothing in the way of sexual content, violence, or language that would be unsuitable for audiences of any age.

PG - Parental Guidance. Parental Guidance means the movie may contain some contents such as mild violence, some brief nudity, and strong language. The contents are not deemed intense.

PG-13 - Parents Strongly Cautioned. Parents with children under 13 are cautioned that the content of movies with this rating may include more explicit sexual, language, and violence content than movies rated PG.

R - Restricted. These films contain material that is explicit in nature and is not recommended for unsupervised children under the age of 17.

NC-17 - No One Under 17. These movies contain content which most parents would feel is too adult for their children to view. Content can consist of strong language, nudity, violence, and suggestive or explicit subject matter.

X - No One under 18. Inappropriate material for anyone under 18.

Special Note about Ratings

Some programs are broadcast without a ratings signal. Therefore, even if you setup V-CHIP ratings limits, these programs will not be blocked. Parents are cautioned to preview the contents of these programs or movies.

Note (for Canadian viewers): *The V-CHIP function is based on specifications designed for the United States and therefore may not work properly in Canada.*

V-Chip

Set Ratings Guidelines

You can set your V-Chip to automatically block programming above a certain level using either the television or motion picture ratings systems, or both. If a program contains a rating above the levels you set, it will automatically be blocked from viewing unless the four-digit lock code is entered.

To access the ratings set-up screens, press the Menu button. Use the ▲▼ arrows to move to the V-Chip option. Select the V-Chip option by pressing ◀ or ▶. The Padlock icon  will appear. Press Zero on the remote's 10-key pad to access the V-CHIP setup menu. The menu shown below will appear.

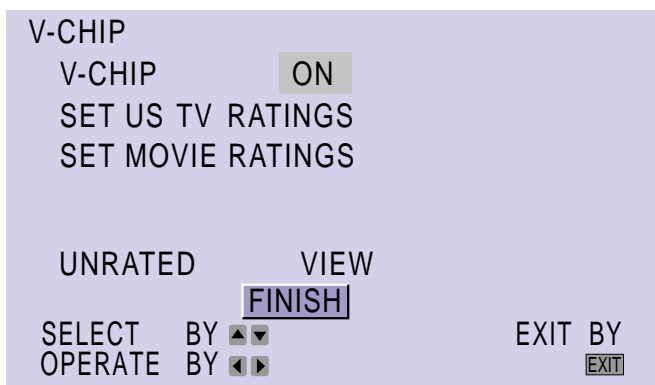

V-CHIP Settings Menu

To Set TV Ratings Levels

Use the ▲▼ arrows to move to SET US TV RATINGS. Select this option by pressing ◀ or ▶. The screen on the right will appear. Use the ▲▼ arrows to move up and down the columns. Press ◀ or ▶ to turn the locking feature on or off. You may block an entire rating category like TV-14, or you may block individual items, like TV-14 shows with V (violence).

To block an entire category, move the cursor to the top of a row, for example TV-14. Press ◀ or ▶. Lock icons will appear down the entire TV-14 column. All programs with a rating of TV-14 will be blocked.

To block an individual item, use the ▲▼ arrows to move to the mark for the item you wish to block, for example TV-14 with Violence. Press ◀ or ▶. The lock icon will appear in the TV-14 V space. All programs with a TV-14 V rating will be blocked.

When you have finished setting your rating limits, press ▼ to move to FINISH. Press ◀ or ▶ to save your settings and exit.

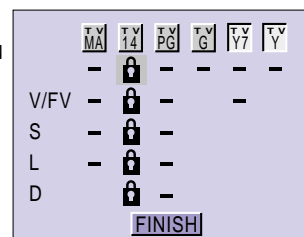
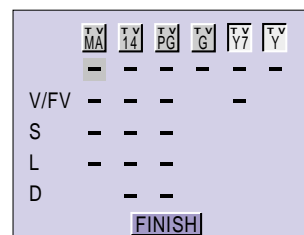

To Set Movie (MPAA) Ratings Levels

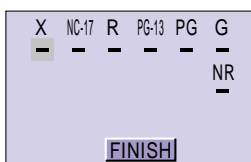

Use the ▲▼ arrows to move to SET MOVIE RATINGS. Select this option by pressing ◀ or ▶. The screen on the left will appear. Use the ▲▼ arrows to move to a movie rating, such as X. Press ◀ or ▶ to turn the ratings block on or off.

When you have set your movie ratings levels, press ▼ to move to FINISH. Press ◀ or ▶ to save your settings and exit.

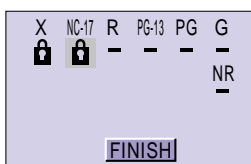

Unrated Programs

You have the choice of allowing programs without a rating signal to be shown or to have unrated programs blocked. To set this option, use the ▲▼ arrows to move to UNRATED in the V-CHIP menu. Use the ◀ or ▶ arrows to select VIEW to show unrated programs, or BLOCK to keep them from being shown. When you have made your selection, press EXIT to return to normal television viewing.

Notes About Unrated Programs:

Unrated programming refers to any programming which does not contain a rating signal. Programming on television stations which do not broadcast rating signals will be placed in the "Unrated Programming" category.

Examples of Unrated programs:

Emergency Bulletins	Religious Programs
Locally Originated Programming	Sports
News	Weather
Political Programs	Some Commercials
Public Service Announcements	

- TV programs or movies that do not have rating signals will be blocked if the Unrated Category is set to LOCK.

Warning Message

When a viewer attempts to watch a program which exceeds the set ratings limits, the following warning message will appear:

THIS PROGRAMMING EXCEEDS
YOUR RATINGS LIMITS.
PLEASE ENTER LOCK CODE BY
10 KEY PAD TO UNLOCK IT.
NO. - - -

To watch a blocked program, enter the four-digit access code to unlock that channel. Once the correct code is entered, the channel will be unlocked and the program shown.

If an incorrect code is entered the message INVALID LOCK CODE! will flash onscreen. The channel will remain locked until the correct code is entered.

Set Lock Code

Channel Guard and V-Chip settings are protected by a four-digit Lock Code. Your TV comes pre-set with a Lock Code of "0000". You may change the code to any four-digit number you wish. To change the Lock Code, follow the steps below.

Access the onscreen menus by pressing MENU on your remote control. You may then either use the up and down arrows ▲▼ to scroll to the INITIAL SETUP menu, or press MENU until the INITIAL SETUP screen appears. Use the ▲▼ arrows to move to the Set Lock Code. Press the ◀ or ▶ arrows to select.

The Padlock icon  will appear. Press Zero on the remote's 10-key pad to access the LOCK CODE.

LOCK CODE 0000
FINISH

Use the ◀ or ▶ arrow to change the first digit. When you have selected the first number, move to the second digit by pressing the ▼ arrow. You can change this digit using the ◀ ▶ arrows. Repeat this process until all four digits are set. When you have entered your LOCK CODE, press ▼ to move to FINISH. Press ◀ or ▶ to exit.

Notes: In order for V-Chip settings to take effect, **V-Chip settings must be turned ON in the V-CHIP menu (page 34).**

You can automatically unblock all of your restrictions by turning V-Chip settings OFF in the V-CHIP menu (page 34).

You can always unblock a restriction by re-entering the V-CHIP menu and removing the lock icon.

Initial Setup

Initial Setup 2

This menu lets you set up some of the functions of the television to meet your personal tastes and needs. You may select one of three languages for onscreen displays, turn closed captioning ON or OFF, adjust an image's vertical position, automatically enhance the picture quality of certain broadcasts, or adjust the size of the 480p picture signal which is input from the Digital-In terminal.

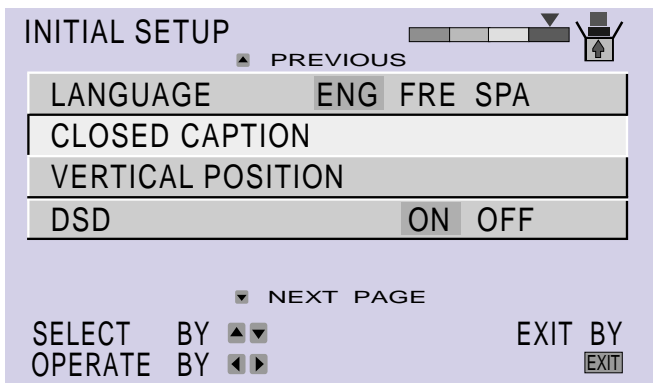

INITIAL SETUP Menu

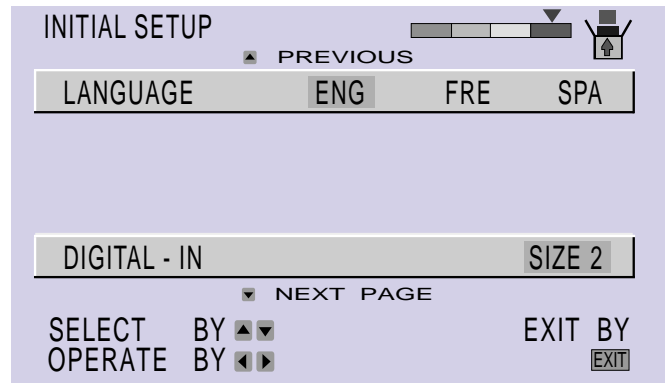

INITIAL SETUP Menu *1

Access the onscreen menus by pressing MENU on your remote control. You may then either use the up and down arrows ▲▼ to scroll to the INITIAL SETUP menu, or press MENU until the INITIAL SETUP screen appears. Use the ◀ or ▶ arrows to move to the setting you wish to change. You can make adjustments to any or all of the settings.

LANGUAGE ENG FRE SPA

You can view the onscreen menu displays in one of three languages - English, French, or Spanish. (See page 28).

CLOSED CAPTION

Many programs now include additional CLOSED CAPTION information as part of their broadcast. CLOSED CAPTIONS often are a text summary of onscreen dialog. Closed Captioning can also include additional information about a program's subject, presented in text form. Your television can be set to display closed captions if you wish.

To display CLOSED CAPTIONS, use the ▲▼ arrows to move to CLOSED CAPTION. Select the option by pressing the ◀ or ▶ arrows.

Continued at top of next page.

Note:

*1: The DIGITAL-IN menu can only be displayed when a 480p picture signal is input to the Digital-In terminal and the picture is being displayed on the screen.

Closed Caption - Continued

A new CLOSED CAPTION menu will now appear. The **Mode option** will be highlighted. This lets you set the operating mode for the CLOSED CAPTION feature. You can set it to: **CLOSED CAPTION** - to display onscreen dialog in a text format, **TEXT** - to display additional information included in a broadcast, or **OFF** - to turn the captioning feature off.

If you select CAPTION or TEXT, the next step is to choose a CLOSED CAPTION channel. Your television can receive four channels of CAPTION information and four channels of TEXT, though only one will be displayed at a time. Using the ▼ arrow, move to either CAPTION or TEXT, depending on the selection you made in MODE. Select the channel you wish to use.

Note: Most CAPTION information can be found on CC1, most TEXT can be found on T1. The others are available for future use.

Once your Caption preferences are set use the ▼ arrow to move to FINISH. Press ◀ or ▶ to save your settings and exit the menu.

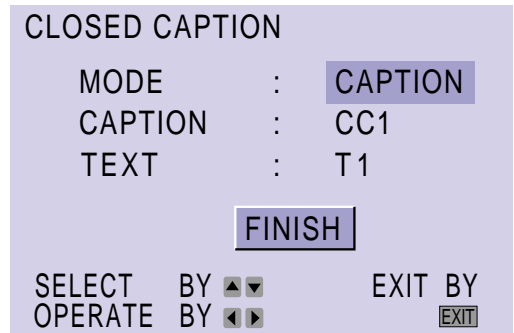

CLOSED CAPTION Menu

VERTICAL POSITION

If you select the regular size with ASPECT, VERTICAL POSITION option is not viewed.

This option allows you to adjust the vertical position of the picture on the screen. You can raise or lower the orientation of the picture by pressing the ▲ or ▼ arrows to move the picture up or down. When the picture is positioned the way you would like, press EXIT to save your settings and leave this option.

DSD ON OFF

Digital Super Detail - Available only when using the "Theater" setting with a 1080i signal.

DSD automatically emphasizes detail and corrects distortions at picture edges. This feature digitally processes the 1080i signal, giving you the clearest picture possible. Select DSD using the ▲▼ arrows. Use the ◀ or ▶ arrows to turn DSD ON to digitally process the signal, or OFF to view the signal in its natural form. Once you have made your selection, press EXIT to save your settings and leave this option.

- You can access the "Theater" setting by pressing the VIDEO STATUS button on the remote control. For more information on VIDEO STATUS, see page 52.

DIGITAL-IN SIZE 1

The DIGITAL-IN option can only be displayed in the INITIAL SETUP menu when a 480p picture signal is being input to the DIGITAL-IN terminal. Refer to the screen illustration at the top-right of page 36.

This option adjusts the position when a 480p picture signal is being displayed on the screen.

There are two types of 480p picture signals: 640x480 and 720x480. If the displayed picture is slightly shifted, the position can be adjusted by selecting either SIZE1 or SIZE2.

Select DIGITAL-IN using the ▲ and ▼ arrows. Use the ◀ or ▶ arrow to select SIZE1 or SIZE2.

Note: CLOSED CAPTION subtitles are programmed by the broadcast channel. Any misspellings are the fault of the broadcaster and not a malfunction of the television. Closed Captioning may not work correctly if the signal being received is weak or if you are playing a video tape. Not every broadcast will include a Closed Caption signal. Most programs containing CLOSED CAPTION information will display a notice at the start of the broadcast.

1080i signals are available only when using a Digital TV decoder (see page 15 for DTV decoder connections).

Picture Adjust

Picture Adjust

The PICTURE ADJUST menu lets make precise adjustments to the television's picture. You can make adjustments to the picture's tint, color, contrast, brightness, and level of detail. By adjusting these levels individually, the overall picture quality can be changed.

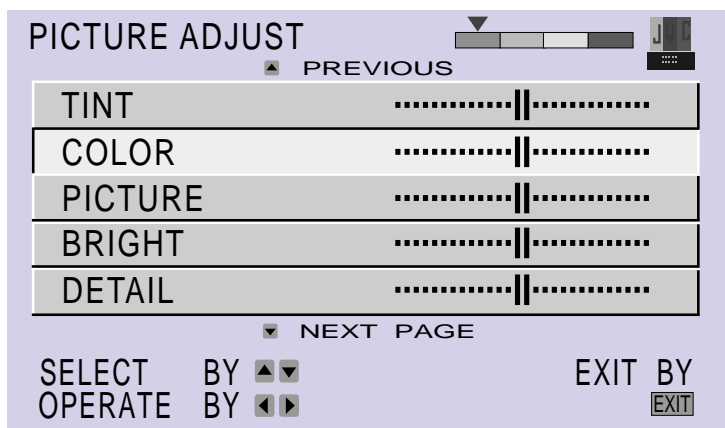

PICTURE ADJUST Menu

Access the onscreen menus by pressing MENU on your remote control. You may then either use the up and down arrows ▲▼ to scroll to the PICTURE ADJUST menu, or press MENU until the PICTURE ADJUST screen appears. Use the ▲▼ arrows to move to the setting you wish to change. You can make adjustments to any or all of the settings. When you select an item, the PICTURE ADJUST menu will disappear, leaving only the selected item onscreen. Use the ◀▶ arrows to make adjustments to the item. To make adjustments to a different item, press the ▲ or ▼ arrows to move to the next menu item, or press EXIT to return to normal television viewing.

TINT||.....

The TINT level lets you adjust the levels of red and green in the picture. Press ◀ to increase the amount of red. Press ▶ to increase the amount of green. Use the ▲▼ arrows to move to the next setting or press EXIT to leave the menu. Your changes will be saved when you move to another setting or press EXIT.

COLOR||.....

COLOR lets you make the overall color of the picture more subtle or more vivid. Press ◀ to make the colors more subtle. Press ▶ to make the colors more vivid. Use the ▲▼ to move to the next setting or press EXIT to leave the menu. Your changes will be saved when you move to another setting or press EXIT.

Note: You may leave the PICTURE ADJUST menu at any time by pressing EXIT. Any changes you have made will be saved.

Picture Adjust

Picture Adjust - Continued

PICTURE||.....

The PICTURE level adjusts the contrast, or range between black and white in the picture. Press ◀ to decrease the range between the blacks and whites in the picture. Press ▶ to increase the range. Use the ▲▼ arrows to move to the next setting or press EXIT to leave the menu. Your changes will be saved when you move to another setting or press EXIT.

BRIGHT||.....

The BRIGHT level lets you adjust the degree of light and darkness in the picture. Press ◀ to decrease the bright level. Press ▶ to increase the bright level. Use the ▲▼ arrows to move to the next setting or press EXIT to leave the menu. Your changes will be saved when you move to another setting or press EXIT.

DETAIL||.....

DETAIL lets you adjust the sharpness of the picture. Press ◀ to decrease the level of detail. This will give you images with softer edges and make the picture seem “softer” overall. Press ▶ to increase the level of detail. This will give you sharper images with harder edges. Use the ▲▼ arrows to move to the next setting or press EXIT to leave the menu. Your changes will be saved when you move to another setting or press EXIT.

Note: You may leave the PICTURE ADJUST menu at any time by pressing EXIT. Any changes you have made will be saved.

Picture Adjust

Picture Adjust 2

The second PICTURE ADJUST menu lets make further adjustments to the television's picture and display qualities. The YNR and DNR noise filters will help improve image quality, noise muting will eliminate static from channels with weak signals or that are not broadcasting, and SET VIDEO STATUS will allow you to program a set of image adjustments that meet your own personal tastes.

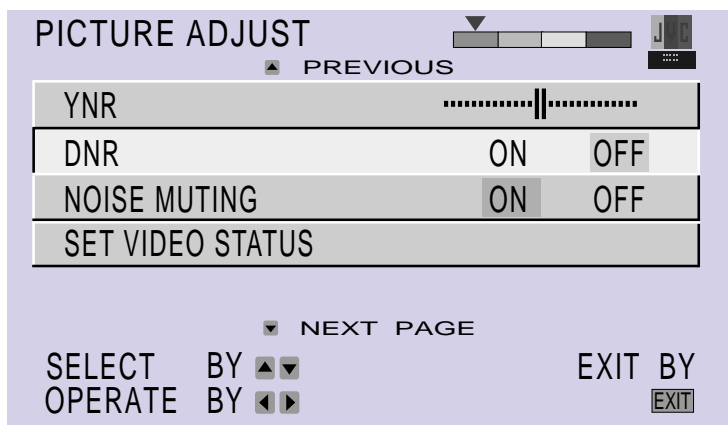

PICTURE ADJUST Menu

The second PICTURE ADJUST menu can be accessed by either pressing the ▼ button while at the last option of the first PICTURE ADJUST menu or by pressing MENU again.

YNR||.....

The YNR filter can help to eliminate “noise” (static) from your television pictures. Before using the YNR filter, first try the DNR filter (see below). If your picture still contains too much noise, try adjusting the YNR filter. Use the ▲▼ arrows to select YNR. Use the ◀ or ▶ arrows to adjust the amount of noise reduction. Press ◀ to decrease the noise reduction, press ▶ to increase the noise reduction.

- If you reduce the level of noise reduction too much, the picture may become soft and weak. Adjust the YNR filter to find a balance between picture sharpness and noise that you like.

DNR ON OFF

Use the DNR (Digital Noise Reducer) filter when receiving a weak signal to help increase the overall signal quality. Use the ▲▼ arrows to select DNR. Use the ◀ or ▶ arrows to turn DNR ON to reduce noise, or OFF to shut the DNR filter off.

- The DNR filter will reduce noise without affecting the overall image quality, unlike the YNR filter. That is why we suggest you try using the DNR filter first. DNR runs a frame-by-frame comparison of the incoming signal to detect and reduce areas of noise.

Picture Adjust

NOISE MUTING **ON** OFF

The NOISE MUTING setting inserts a blue screen over any channels that are not broadcasting or have signals too weak to have clear signals. Press the ◀ or ▶ arrows to turn NOISE MUTING on or OFF.

SET VIDEO STATUS

SET VIDEO STATUS lets you save a customized set of screen display settings. You can access your personal settings at any time by pressing the VIDEO STATUS button on the remote control and selecting the “Choice” option.

To enter your customized settings, use the ▲▼ arrows to select SET VIDEO STATUS. The following menu will appear:

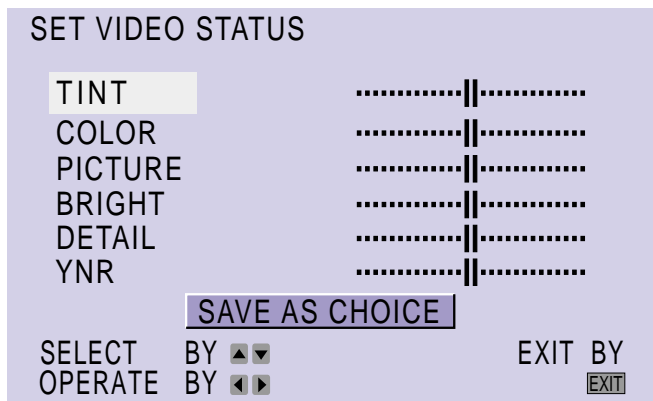

SET VIDEO STATUS Menu

The five settings options on the SET VIDEO STATUS menu are the same as the ones shown on pages 38 and 39. Use the ▲▼ arrows to move to a setting. Use the ◀ or ▶ arrows to adjust the selected setting. Once you have each setting adjusted as you like it, use the ▼ arrow to move to SAVE AS CHOICE. Press ◀ or ▶ to exit.

Your personal settings will now be available as the “Choice” option whenever you press the VIDEO STATUS button on the remote control. You may change your “Choice” settings anytime you wish.

- You must use SAVE AS CHOICE to exit the SET VIDEO STATUS menu.
- For descriptions of the SET VIDEO STATUS settings and how to adjust them, see pages 34 and 35.

Sound Adjust

Sound Adjust

The SOUND ADJUST menu lets you tailor the television's sound to suit your personal taste. You can adjust the television's bass and treble output, as well as the speaker balance. You can also choose to receive broadcasts either stereo or mono sound, or listen to a Second Audio Program (SAP), if one is broadcast.

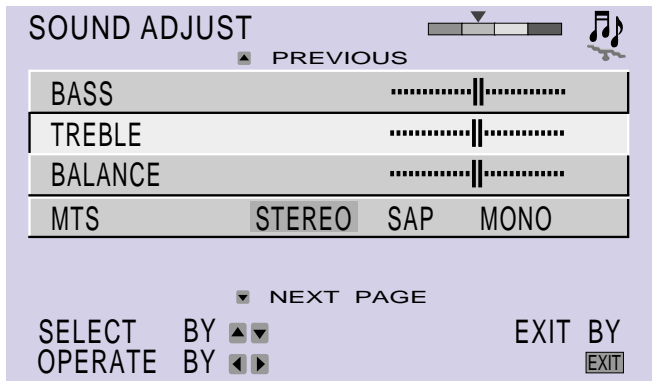

SOUND ADJUST Menu

Access the onscreen menus by pressing MENU on your remote control. You may then either use the up and down arrows ▲▼ to scroll to the SOUND ADJUST menu, or press MENU until the SOUND ADJUST screen appears. Use the ▲▼ arrows to move to the setting you wish to change. You can make adjustments to any or all of the settings.

BASS



The BASS level lets you adjust the level of low-frequency sounds. Press ◀ to decrease the bass level. Press ▶ to increase the level of bass. Use the ▲▼ to move to the next setting or press EXIT to leave the menu.

TREBLE



The TREBLE level lets you adjust the level of high-frequency sounds. Press ◀ to decrease the treble. Press ▶ to increase the treble. Use the ▲▼ to move to the next setting or press EXIT to leave the menu.

BALANCE



You can adjust the balance of sound output between the television's RIGHT and LEFT speakers with the balance control. Press ◀ to shift the balance to the left. Press ▶ to shift the balance to the right. Use the ▲▼ to move to the next setting or press EXIT to leave the menu.

Notes: The BALANCE option can not be operated from the menu screen when DOLBY PRO LOGIC is selected from the SOUND MODE menu.

Sound Adjust - Continued

MTS STEREO SAP MONO

Many broadcasts today contain more than one audio signal. In addition to stereo and mono soundtracks, some broadcasts also contain a second soundtrack in a different language. Use MTS to select the audio signal you wish to listen to.

- Select **STEREO** for your normal listening needs. With this setting programs broadcast in stereo will be played by the TV in stereo. Programs broadcast in mono sound only will be played in mono sound.
- Select **MONO** if you are receiving a weak signal. Mono sound will usually give clearer sound from weak signals than will stereo. With this setting all broadcasts, mono and stereo, will be played in mono sound only by the television.
- Select **SAP** (Second Audio Program) to listen to an alternate soundtrack (if one is being broadcast). Alternate soundtracks may be the dialog of a program in a different language or additional information about a program topic. A logo will appear at the beginning of a program with SAP to inform you that an alternate soundtrack is available.

Some Sound Advice

You can tell if a program is broadcast in stereo by the position of the ON AIR arrow in the MTS menu. Unfortunately, some cable companies may “squash” the transmission of stereo programs because they have only monaural equipment. If you are connected to a cable system, the sound is at the mercy of that cable company. If they broadcast only monaural signals, your television will only receive a mono signal even if the program was originally broadcast in stereo.

Fortunately, most programs that are broadcast in stereo are aired on the major television networks. If you connect your TV to an antenna instead of cable, and set the tuner mode in the AUTO TUNER SETUP to “AIR” instead of “CABLE” you will be able to pick up stereo broadcasts in stereo.

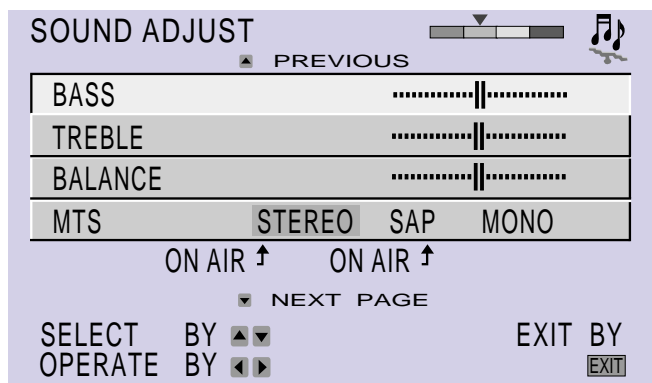

Initial Setup

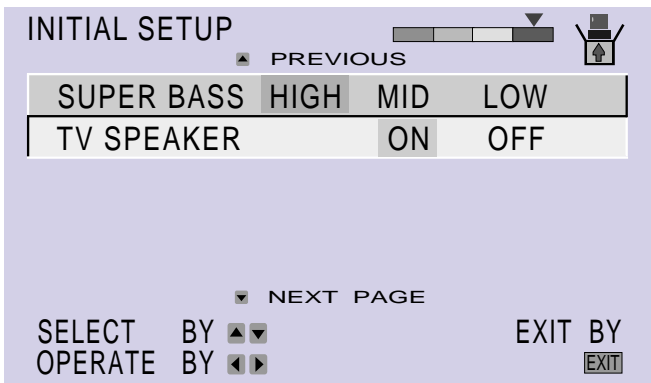

INITIAL SETUP Menu

Access the onscreen menus by pressing MENU on your remote control. You may then either use the up and down arrows ▲▼ to scroll to the INITIAL SETUP menu, or press MENU until the INITIAL SETUP screen appears. Use the ▲▼ arrows to move to the setting you wish to change. You can make adjustments to any or all of the settings.

SUPER BASS HIGH MID LOW

The SUPER BASS function dramatically adjust the bass sound of the television. SUPER BASS has three settings:

HIGH - The bass is emphasized to give a heavy, booming sound

MID - The bass is treated normally, bass levels are in the same range as high and mid frequencies

LOW - The bass is softened, low end sounds are made weaker

Use the ▲▼ arrows to select the SUPER BASS function. Use the ◀ or ▶ arrows to select HIGH, MID, or LOW. Once you have made your selection, press EXIT to return to normal television viewing.

TV SPEAKER ON OFF

The TV SPEAKER option turns the television's internal speakers on or off. The television comes from the factory with the internal speakers turned on. If you connect your television to a home stereo system, use this option to turn the TV's speakers off. To turn the speakers off press ◀ or ▶ to highlight OFF. Press ▲▼ to enter your selection. If you later disconnect from the home stereo, use this option to turn the TV's speakers back on.

- Before you turn the TV SPEAKER setting from OFF to ON, **make sure that the TV volume is set very low!** If the TV volume is set too high when the speakers are turned on, the sound level may be extremely loud and could damage the speakers.
- The TV SPEAKER option can not be operated from the menu screen when DOLBY PRO LOGIC is selected on the SOUND MODE menu.

Note: When using external speakers, make sure you shut off the television's speakers by using the TV SPEAKER option shown above.

Audio Settings

Sound Mode

The sound system of the AV-61S902 lets you customize the audio output of the television for optimal performance with your home theater system. All AV-61S902 feature Dolby Surround and Dolby Pro Logic technology for unparalleled sound quality.

You can access the sound settings by pressing SOUND on the remote control. The SOUND MODE menu will appear.

SOUND MODE	
DOLBY PRO LOGIC	▶
PRO LOGIC 3D-PHONIC	▶
DANCE CLUB	
CONCERT HALL	
STADIUM	
HYPER SOUND	
SELECT BY ▲▼	EXIT BY
OPERATE BY ◀▶	EXIT

SOUND MODE Menu

* Manufactured under license from Dolby Laboratories.
“DOLBY”, “Pro Logic”, and the double-D symbol are trademarks of Dolby Laboratories.

Dolby Pro Logic

You can enjoy Dolby* Surround sound with additional speakers.

The following settings must be performed before you can enjoy Dolby Surround sound.

Settings for when 4 additional speakers are used to enjoy Dolby Surround sound

Use the ▲ and ▼ arrows in the sound mode menu to select Dolby Pro Logic. Press the ▶ arrow to display the Dolby Pro Logic second menu.

Use the ◀ or ▶ arrows to set the MODE to NORMAL.

When the MODE is set to NORMAL, the internal speakers are used as the center sound speakers. When using the following options, the TV SPEAKERS are set to CENTER.

In order to test the balance of sound coming from each speaker, use the ▲ and ▼ arrows to select the TEST MODE. Use the ▶ arrow to turn the TEST MODE ON.

A test sound signal is output from each speaker. Use the ▲ and ▼ arrows to select the option (LEFT, CENTER, RIGHT or SURROUND) you want to adjust and use the ◀ and ▶ arrows to adjust the volume of each speaker.

Sit where you normally watch television and adjust the sound so that the balance of sound from each speaker is as you want it to be.

When you have finished testing the balance of sound coming from each speaker, use the ▲ and ▼ arrows to select the TEST MODE and use the ▶ arrow to turn the TEST MODE OFF.

Press the EXIT button to return to the normal television screen.

Note: When using 4 speakers (2 front speakers and 2 surround speakers) in the NORMAL mode to enjoy Dolby Surround sound, you may feel that there is a difference in the sound quality from the front L/R speakers and the internal speakers. In cases such as this, where the sound quality is not as you would like, changing the SOUND MODE to PHANTOM and turning the TV SPEAKER function OFF will solve the problem.

Audio Settings

Settings for when 2 additional speakers are used to enjoy Dolby Surround sound (Only the surround speakers are connected)

Use the ▲ and ▼ arrows in the sound mode menu to select Dolby Pro Logic. Press the ► arrow to display the Dolby Pro Logic second menu.

Use the ◀ and ▶ arrows to set the MODE to PHANTOM.

When the PHANTOM mode is selected, you can choose whether to use the internal speakers as the L/R sound speakers or to turn them off.

Use the ▲ and ▼ arrows to select TV SPEAKER and the ► arrow to select L/R or OFF.

As a rule, select L/R.

In order to test the balance of sound coming from each speaker, use the ▲ and ▼ arrows to select the TEST MODE. Use the ► arrow to turn the TEST MODE ON.

A test sound signal is output from each speaker. Use the ▲ and ▼ arrows to select the option (LEFT, RIGHT or SURROUND) you want to adjust and use the ◀ and ▶ arrows to adjust the volume of each speaker.

Sit where you normally watch television and adjust the sound so that the balance of sound from each speaker is as you want it to be.

When you have finished testing the balance of sound coming from each speaker, use the ▲ and ▼ arrows to select the TEST MODE and use the ► arrow to turn the TEST MODE OFF.

Press the EXIT button to return to the normal television screen.

In order to enjoy Dolby Surround sound

Preparation

- Connect the speakers and amplifiers (Refer to page 20.)
- Adjust the amplifier sound levels. (Refer to the instruction manuals of the connected devices.)
- Perform the sound mode settings. (See above.)

Enjoy Dolby Surround sound

- 1) Press the SOUND button to turn the SURROUND function ON. (Refer to page 47.)
- 2) Press the EXIT button to return to the normal television screen from the SOUND menu.
- 3) Input a Dolby Surround encoded program from a DTV decoder or DVD etc.

Notes:

- *This function is only available for Dolby Surround encoded programs.*
- *You cannot enjoy Dolby Surround sound with headphones.*
- *An amplifier is necessary in order to connect additional speakers. Refer to page 20 for information about connecting speakers.*

Audio Settings

Pro Logic 3D-Phonic

You can enjoy the atmosphere of Dolby Surround programs without external speakers.

Use the ▲ and ▼ arrows in the sound mode menu to select PRO LOGIC 3D-PHONIC. Press the ► arrow to display the Pro Logic 3D-Phonic second menu.

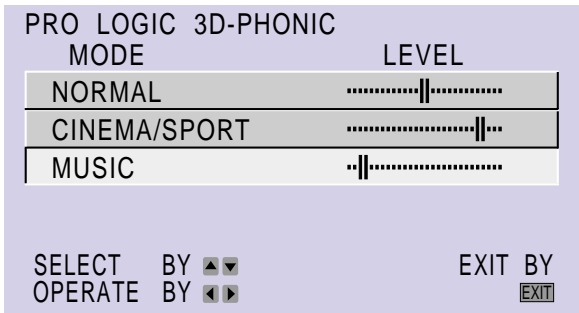

Use the ▲ and ▼ arrows to select one of the following three Pro Logic 3D-Phonic modes and use the ◀ or ▶ arrows to adjust the effect level.

NORMAL: For normal programs

CINEMA/SPORT: For cinema and sports programs

MUSIC: For music programs

Note: This function is only available for Dolby Surround encoded programs.

Other Sound Modes

You can enjoy enhanced sound by choosing one of four Digital Surround modes.

Dance Club

This setting adjusts the sound levels to give you the feeling of being at a dance.

Use the ▲ and ▼ arrows in the sound mode menu to select DANCE CLUB. Once selected, the DANCE CLUB mode is entered.

Concert Hall

This setting adjusts the sound levels to give you the feeling of being at a Concert Hall.

Use the ▲ and ▼ arrows in the sound mode menu to select CONCERT HALL. Once selected, the CONCERT HALL mode is entered.

Stadium

This setting adjusts the sound levels to give you the feeling of being at a Stadium.

Use the ▲ and ▼ arrows in the sound mode menu to select STADIUM. Once selected, the STADIUM mode is entered.

Hyper Sound

Hyper Sound takes the monaural sound information in a program and expands it to give the impression of full stereo sound. Hyper Sound is designed to work with monaural signals. It will not work with programs which are broadcast in stereo.

Use the ▲ and ▼ arrows in the sound mode menu to select Hyper Sound. Once selected, the Hyper Sound mode is entered.

Note: Sound Modes other than Hyper Sound do not work well for monaural programs.

Switching the surround function on/off

The surround function can be switched on or off by pressing the SOUND button on the remote control.

Pressing it once displays "Sound mode menu" on the screen and turns the surround function on. Pressing the SOUND button again while "Sound mode menu" is displayed on the screen turns the surround function off.

CLOCK/TIMERS

CLOCK/TIMERS

This CLOCK/TIMERS menu can be used to set the time of the built-in clock and set the ON/OFF TIMER function.

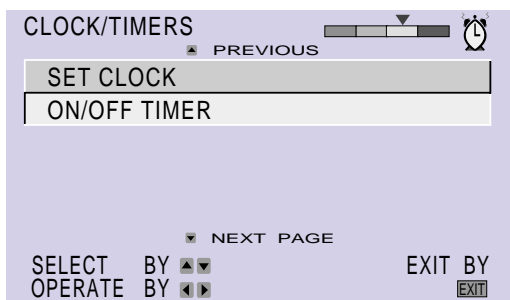

Access the on-screen menus by pressing the MENU button on your remote control. You may then either use the ▲ and ▼ arrows to select the CLOCK/TIMERS menu, or press the MENU button until the CLOCK/TIMERS screen appears.

Use the ◀ or ▶ arrows to move to the setting you wish to change.

You can make the setting or program.

SET CLOCK

The SET CLOCK function is described on page 30. If you need to set the SET CLOCK again, select the option from the CLOCK/TIMER menu by using the ▲ or ▼ arrows to move to the SET CLOCK option in the CLOCK/TIMER Menu. Select the option by pressing the ◀ or ▶ arrows. Please refer to page 30 for instructions on using the CLOCK/TIMER feature.

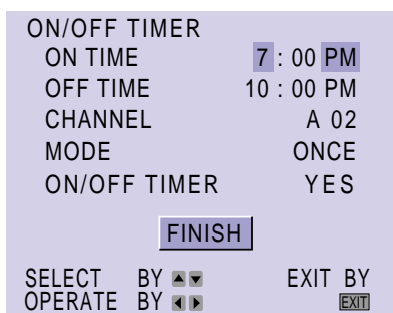

ON/OFF TIMER

The ON/OFF TIMER lets you program your television to turn itself on or off. You can use it as an alarm to wake up, to help you remember important programs, or as a security device to make the house seem occupied when you're not at home.

You can select the ON/OFF TIMER option from the CLOCK/TIMERS menu by using the ▲ or ▼ arrows to move to the ON/OFF TIMER option in the ON/OFF TIMER Menu. Select the option by pressing the ◀ or ▶ arrows.

Setting the ON/OFF TIMER

Use the ◀ or ▶ arrows to set the time you want the television turn on. Press the arrow to move to the minutes. Use the ◀ or ▶ arrows to set the minutes.

Use the ▼ arrow to move to the OFF TIME setting. Use the ▲ or ▼ arrows and the ◀ or ▶ arrows to set the OFF TIME hour and minutes in the same way as with the ON TIME.

Next, press the ▼ button. The channel which is displayed when the television turns on can be selected. Use the ◀ or ▶ arrows to select the channel you want.

Press the ▼ arrow to move to MODE. Use the ◀ or ▶ arrows to select either "ONCE" or "EVERY DAY".

Press the ▼ arrow to move to ON/OFF TIMER. Use the ◀ or ▶ arrows to select whether or not the ON/OFF TIMER is used. Select "YES" if the timer is to be used and select "NO" if the timer is not to be used.

Press the ▼ arrow to move to FINISH. Use the ◀ or ▶ arrows to select confirm the program.

In order to return to the normal screen, press the EXIT button on the remote control.

When the ON/OFF TIMER has been programmed to operate, the On Timer LED on the front panel of the television lights.

Note: The ON/OFF TIMER cannot be set to locked or guarded channels. In order for the ON/OFF TIMER to work, the clock must be set. In the event of the electric power being interrupted, the timer must be set again.

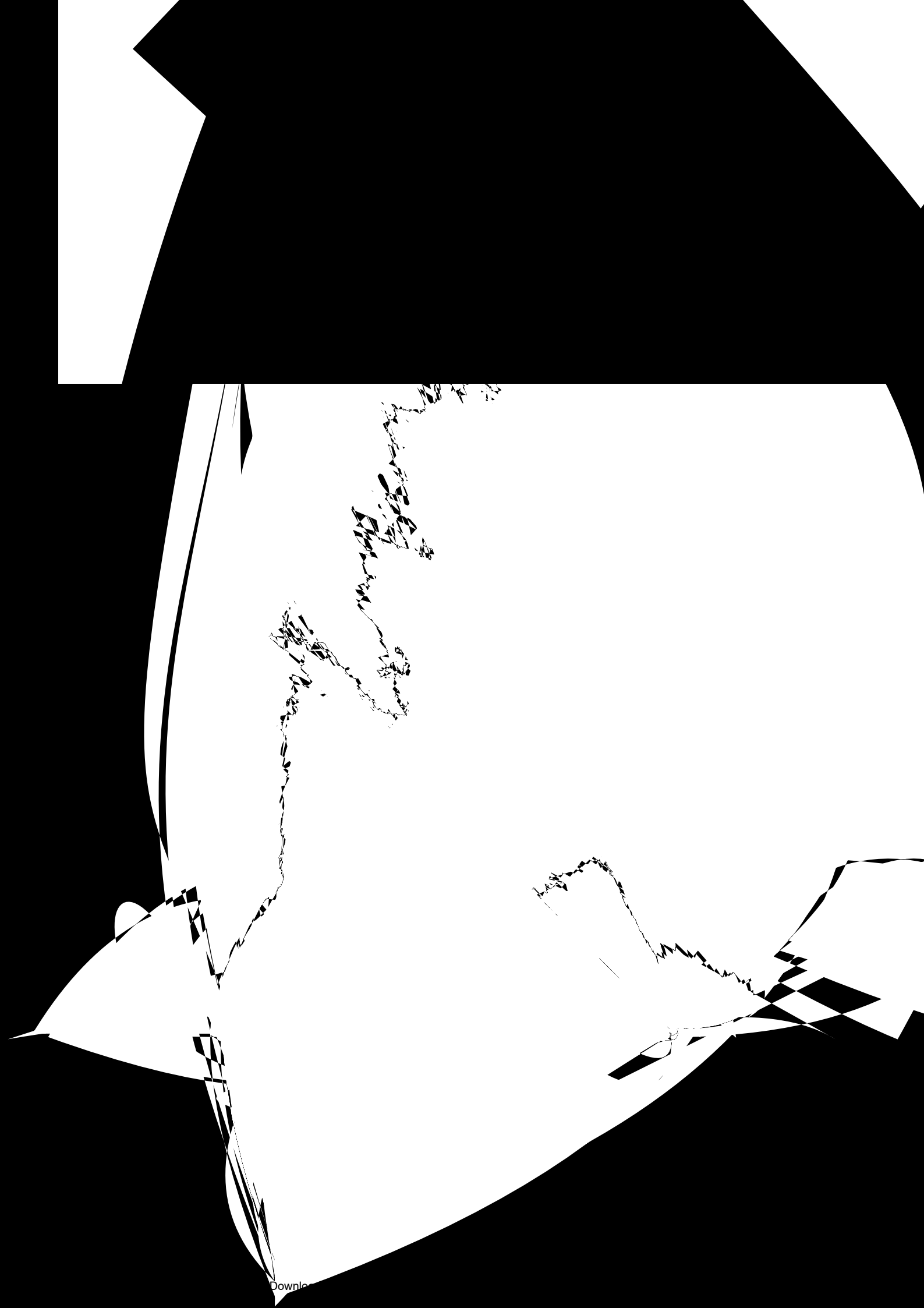

Button Functions

Split

Activate the Split-Screen option by pressing SPLIT on the remote control.

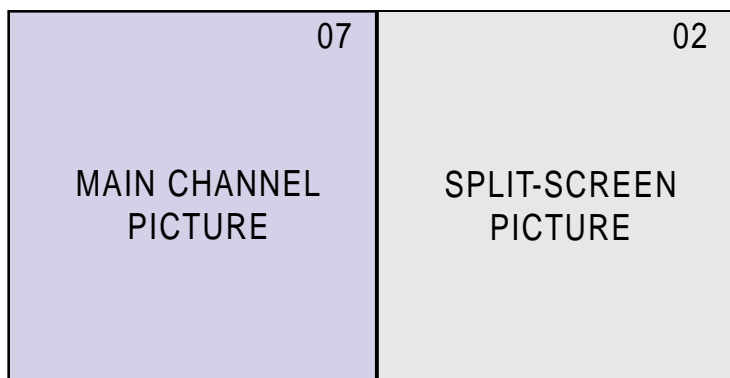

SPLIT-SCREEN Mode

Two channels (or input) will now appear onscreen. The channel (or input) you were watching before pressing SPLIT will appear on the left, the new channel will appear on the right. The sound will continue to come from the main screen channel (or input). To turn Split-Screen off and return to normal television viewing, press SPLIT again.

Swap

You can exchange the channel (or input) displayed in the Split screen window for the main screen image by pressing SWAP button.

Freeze

Pressing the FREEZE button causes the screen to change to the split-screen display with the still picture displayed on the right. In order to return to the normal display, press the FREEZE button once again.

Notes:

- The picture signal input from the component input terminal of the television can not be displayed when watching the split-screen display. If the connected device has an S-Video terminal, connecting this will enable the picture to be displayed when watching the split-screen display.
- Split-Screen functions will not work with locked channels or channels blocked by V-Chip ratings limits. A blue screen will display instead.
- The picture from the RF INPUT-B can not be displayed on the split screen.

Button Functions

Menu

The MENU button allows you to access JVC's onscreen menu system. Press MENU to activate the onscreen menu system.

- See individual topics (like "Picture Adjust") for specific information on using those menu screens.

Exit

Press the EXIT button to leave a menu screen.

Display

The DISPLAY screen shows the current status of timers and inputs.



Press the DISPLAY button to activate.

A 07	
NOW	12 : 20 PM
SLEEP TIMER	OFF
ON/OFF TIMER	EVERYDAY
ON TIME	7 : 00 PM
OFF TIME	10 : 00 PM

The screen on the left shows the following information:

- The channel or AV input (RF-input A, 07)
- The current time (12:20 pm)
- SLEEP TIMER status/minutes remaining (The SLEEP TIMER is off)
- ON/OFF TIMER status (Set to turn on everyday at 7:00 pm, off at 10:00 pm)

Each press of the DISPLAY button moves to a different display mode:

Display - Full screen shown above

Time - Shows the current time only

Channel - Shows the current channel only

Off - Turns all displays off

Sleep Timer

The SLEEP TIMER can turn the TV off for you after you fall asleep. Program it to work in intervals of 15 minutes, for a total time of up to 180 minutes.

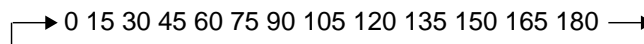

Press the SLEEP TIMER button to activate.

Sleep Timer Message

20 seconds before the automatic timer shutoff occurs, this message will appear onscreen:

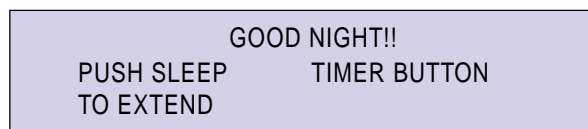

You have 20 seconds to press the SLEEP TIMER button to delay the shutoff for another 15 minutes. If you do not press the button, the television will automatically shut off.

Button Functions

BBE

BBE high definition audio adds natural, clear, extraordinary sound quality to any program. Use the BBE button to turn the BBE high definition audio filter ON or OFF.

Sound

Press the SOUND button to access the Dolby Sound settings menu. For more information on the Dolby sound feature and its settings, see page 45.

Muting

The MUTING button instantly turns the volume down completely when you press it.



MUTING

The volume level will instantly go to zero.

- To restore the volume to its previous level, press MUTING again.

Video Status

The VIDEO STATUS button gives you a choice of three TV picture display settings, including display of your own setting preferences.

Standard - Resets the picture display to the original factory settings

Choice - Displays the setting levels you specified on the "SET VIDEO STATUS" menu (page 41)

Theater - Gives a rich, film-like look to video.



Press the VIDEO STATUS button to choose a setting.



Natural Cinema

Natural Cinema corrects the problem of blurred edges which may occur when viewing a program originally shot on film (such as motion pictures) or animation. If you notice blurring at the edges of these programs, press NATURAL CINEMA and set it to ON. Natural Cinema helps correct conversion errors that occur when film, which is shot at 24 frames-per-second, is broadcast at the television rate of 30 frames-per-second.

Natural Cinema should not be used when viewing regular television programs or video tapes. When viewing such programs, set Natural Cinema to OFF.

- Natural Cinema is automatically turned off when you turn the television off or use one of the Multi-Screen functions.

Aspect

Press the ASPECT button to access ASPECT ratio settings menu. You can choose one of four display ratios for your television picture. For more information on the ASPECT ratio feature and its settings, see page 49.

Notes: BBE is a registered trademark of BBE Sound, Inc. For U.S., licensed from BBE Sound, Inc. under USP 4638258, 4482866 and 5510572. For Canada, licensed from BBE Sound, Inc. BBE is a registered trademark of BBE Sound, Inc.

Button Functions

Number Buttons - 10 Key Pad

Use the number buttons on the remote control to move directly to a specific channel. For example, to move to channel 7:

 0 (Zero)

 7 (Seven)

100+ Button

Use the 100+ button to directly access channels above Channel 99. For example, to move to channel 124:

 100+

 2 (Two)

 4 (Four)

Return+

The RETURN+ button has two functions:

Return - Returns to the channel viewed just before the channel currently onscreen.

Return+ - Lets you program a specific channel to return to while scanning through the channels. To program:

 RETURN+ and hold for three seconds.

RETURN CHANNEL
PROGRAMMED !

You can now scan through the channels using the CH+/- buttons.

 RETURN+

You will return to your programmed channel.

- To cancel your RETURN+ channel, press and hold the RETURN+ button for three seconds. The message "RETURN CHANNEL CANCELLED!" will appear.
- RETURN+ works only with CHANNEL+/. Pressing any number key will cancel RETURN+.

V-chip

By pressing the remote control V-CHIP button, the V-chip rating information for the program which is being received is displayed on the screen.

If the V-chip rating information is not being sent, "UNRATED" is displayed on the screen.

If the zero ("0") button is pressed while the V-chip rating is displayed on the screen, all categories with the same or a higher V-chip rating will be blocked.

For example, if you block movies rated NC-17, movies rated X will also be blocked.

- V-chip blocks can be manually set one at a time by using the V-chip option in the INITIAL SETUP menu. For detailed information about V-chip ratings and V-chip manual settings, refer to pages 33 to 35.

Button Functions

Input

The AV-61S902 can receive signals from a variety of sources. Use the INPUT button to select the signal source: Antenna (for signals from the RF coaxial cable) or VIDEO 1 through VIDEO 4 (for signals from an audio/video device like a DVD player or VCR) or DIGITAL-IN.

The INPUT menu will appear when you press INPUT. To select a signal source, press INPUT, each press will move to the next item in the menu. If no device is connected to an input, a blue screen will appear. When you have selected a signal source, either press EXIT to leave the menu or wait a few seconds for the menu to disappear automatically.

- You cannot use the ▲▼ arrows to access items from the menu.
- Pressing CH+/- will automatically select the antenna (A 01) as the source.

INPUT
A 01
VIDEO-1
VIDEO-2
VIDEO-3
VIDEO-4
DIGITAL-IN

INPUT Menu

Menu (on TV's front panel)

You can also access the onscreen menu system by pressing the MENU button on the television's front panel. When you press this button, an additional onscreen menu will appear.

FRONT PANEL CONTROL	
CHANNEL	A 07
INPUT	TV
ASPECT	FULL

▼ NEXT PAGE

SELECT BY ▼ ← FRONT KEY
OPERATE BY ◀▶ ← FRONT KEY

FRONT PANEL Menu

This menu will show the current channel (07 on the menu shown above), the current signal input in use (TV antenna) and the current aspect ratio (FULL). You can move to the other onscreen menus by pressing the ▲▼ arrows.

Light

The remote control includes illuminated buttons for key features like CH+/- and VOL+/. Press the LIGHT button to turn the illumination on. The illumination will shut off automatically after a few seconds.

Button Functions

VCR Buttons

You can use this remote control to operate the basic functions of your VCR. These functions include: play, record, rewind, fast-forward, stop, pause, channel scan, TV /VCR, power on, and power off.

Move the selector switch to VCR to operate.

- The remote is preset with the code 000 to control JVC-brand VCR's. For any other manufacturer's brand VCR, please see the code chart and instructions on page 23.

DVD Buttons

You can also use this remote control to operate the basic functions of your DVD player. These functions include: play, rewind, fast-forward, stop, still/pause, previous/next, tray open/close, power on, and power off.

Move the selector switch to DVD to operate.

- The remote is preset with the code 000 to control JVC-brand DVD players. For any other manufacturer's brand DVD player, please see the code chart and instructions on page 24.

TV/CATV Switch

Use either the television's own tuner or a cable box to select channels. Set this switch to TV to operate the television's built-in tuner. Move the switch to CATV to operate a cable box.

- See page 22 for information on programming your remote for cable box operation.

VCR/DVD Switch

You can control a VCR or DVD player with the buttons on the lower part of the remote control. Use the VCR/DVD selector switch to choose either VCR or DVD operation.

- See pages 23 and 24 for information on programming your remote with VCR and DVD operating codes.

Troubleshooting

PROBLEMS	CHECK
There is no power	<ul style="list-style-type: none"> - See if the power cord became unplugged. - Check for a blown fuse or circuit breaker or a power outage. - Are the POWER LED and/or the ON TIMER LED on the front panel of the television blinking? If these LED indicators are blinking, there is a problem with the television. Refer to the table on the next page and take the appropriate measures. - Are the 10 LED indicators on the front panel blinking while moving clockwise? When the LED indicators on the front panel are blinking while moving clockwise, the television is in the cooling mode. The television can not be operated while the cooling is being performed. Press the POWER button when the cooling has been completed. (Refer to page 9.) - After pressing the power button, if you see all 10 LEDs on the front panel light up, but the unit goes into cooling mode and you cannot then turn the television on, the filter inside the air duct may not be properly installed or the lamp may be dead.
There is no picture or sound	<ul style="list-style-type: none"> - The antenna could be disconnected. - The input mode (TV/Video) could be set improperly. See page 8. - The tuner (AUTO TUNER SETUP) could be set improperly. See page 29. - The TV station may be having difficulties. Check to see if other stations are working.
Remote control is not operating properly or at all	<ul style="list-style-type: none"> - Check to see that the batteries are still working and properly installed. - Make sure the remote has a clear sight path to the TV. - Check that the TV/CATV switch is in the proper position. - You may be too far from the TV. You must be within 23 feet (7 meters). - Use the remote control while pointing it at the screen.
You cannot select a certain channel	<ul style="list-style-type: none"> - Make sure the channels have been programmed. See "Channel Summary" page 32. - Check to see if the channel is locked. See "Channel Summary - Lock" page 32.
The power turns off by itself	<ul style="list-style-type: none"> - Make sure the set did not become unplugged. - Perhaps the ON/OFF TIMER is set. See page 48. - Check to see if the Sleep Timer was set. See page 51. - Are the POWER LED and the ON TIMER LED on the front panel of the television blinking alternately? If you have just replaced the lamp, it is possible that the lamp has not been installed correctly. Try installing the lamp again. (Refer to the table on the next page.)
It does not operate correctly	<p>This television is operated by a microprocessor. It is possible that external noise or interference is causing the problem. If the television does not function correctly, remove the electric plug from the wall outlet and wait a while before inserting it into the wall outlet again and operating the television.</p>
The clock is wrong	<p>The power was interrupted and the clock was not reset. See page 30.</p>
The color quality is poor	<ul style="list-style-type: none"> - Tint and Color may be improperly adjusted. See page 38. - The VIDEO STATUS mode may be turned to the wrong setting. See page 41.
There are lines across the picture	<p>There could be interference from another electrical appliance, such as a computer, another TV or VCR. Move any such appliances further away from the TV.</p>
The picture is spotted	<p>There could be interference from a high-wattage appliance, like a hairdryer or vacuum, operating nearby. Move the antenna away from the appliance or change to a coaxial cable connection which is less prone to interference.</p>
There are double pictures (ghosts)	<p>A building or passing airplane can reflect the original signal and produce a second, slightly delayed one. Adjust your antenna position.</p>
Picture is snowy (image noise)	<p>Your antenna may be damaged, disconnected or turned. Check the antenna connection page 6 and in your Quick Setup Guide. If the antenna is damaged, replace it.</p>

Troubleshooting

PROBLEMS	CHECK
Screen is 80% black	The Closed Caption Text mode is on. Turn it off in the CLOSED CAPTION Menu, see page 36.
Stereo or bilingual programs cannot be heard	Make sure the MTS settings are correct. See "MTS" on page 43.
There is no sound from the TV's speakers	The TV Speaker option may be turned off. See page 44.
Static electricity	It is normal to feel static electricity if you brush or touch the screen.
You hear occasional crackling sounds	It is normal for the TV to make crackling sounds when first turned on or off. Unless the sound or picture

The following are not malfunctions.

- The television may make a creaking sound if the temperature of the room or the temperature of the inside of the television changes. If there is no problem with the screen or sound, then there is no need to worry.
- There lamp may make a noise when it blows, but this is not dangerous.
- The lamp may make a noise when the power is turned on and a picture is displayed on the screen. This noise is caused when the mercury which is inside the lamp is heated and is not a malfunction.
- The still parts of the picture may remain on the screen. This is a characteristic of ILA elements and not a malfunction. The picture will disappear over time.
- The operation of this television is not guaranteed below 0°C. If the power is turned on when the temperature is below 0°C, the picture may be disturbed. Use the television when the temperature is 0°C or higher.
- Although the D-ILA hologram element is manufactured with high-precision technology, please understand that some pixels may be lost or permanently displayed.
- There is a cooling fan built-in to the television. Please understand that this fan will make some noise when the television is being used and while cooling.
- Although the picture may be temporarily disturbed and noise may be seen on the screen if the power is turned on immediately after it has been turned off, this is not a malfunction.

If the POWER LED and/or the ON TIMER LED on the front panel of the television are blinking, there is a problem with the television.

Refer to the table below to check the condition. If you think that there is a problem, contact the JVC Service Center where you purchased the television.

How the LED indicators are blinking	Trouble
The ON TIMER LED and POWER LED are blinking alternately.	It is possible that the lamp has not been installed correctly, or it may be a malfunction.
The ON TIMER LED and POWER LED are lit at the same time.	It may be a malfunction.
The ON TIMER LED is blinking.	It may be a malfunction.
The POWER LED is blinking.	It may be a malfunction.
When you try to turn the power on, the cooling mode is entered and the power does not turn on.	The lamp may be blown. Replace it with a new lamp. The filter unit may not be installed correctly. The filter unit may be broken. Replace with a new filter unit.

Appendix A

Cleaning the Filters

The lamp and internal circuits of the AV-61S902 are cooled by a fan which draws in cool air through a pair of intakes. The air intakes are located behind the speaker covers on the front of the television and contain air filters which need periodic cleaning. **It is very important the filters be kept clean!** If the filters become clogged, cooling air may not reach the lamp or internal circuits. This could cause the lamp or internal circuits to overheat and stop functioning. It is recommended the filters be cleaned at least once every three months. If the television is located in an area where it is exposed to higher levels of dust or other particles in the air, more frequent cleaning may be necessary.

Follow the steps below to clean the filters. To clean the filters you will need a Phillips head screwdriver and a vacuum with a hose attachment. Please read all the steps before you begin.

1) Turn the television off.

Press the Power button on the remote control or television's front panel to turn the television off. Wait until the picture has closed and the 10 LED lights on the front panel have stopped blinking.

2) Unplug the television.

Disconnect the television's power cord from the AC outlet. Make sure the 10 LED lights have stopped blinking before you unplug the television.

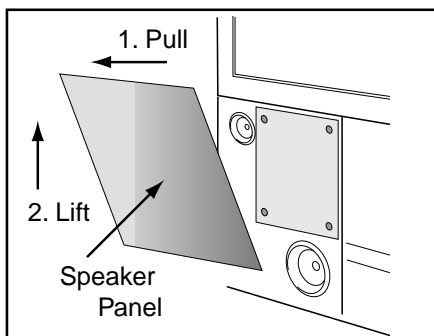

3) Remove the speaker panels.

The next step is to remove the speaker panels located at the bottom of the front of the television cabinet. The top of the speaker panels are held with Velcro. **Make sure the television is unplugged** (see steps 1 and 2) before removing the speaker panels.

To remove the panels - Grab the panel from the side near the top. Gently pull the top away from the television. When the top part of the speaker panel is fully away from the television, lift up. The panel will come away from the bottom of the television. Set the panel aside. Repeat this step for the other panel.

4) Remove the filter cover.

Each air filter is covered by a filter cover. To remove this filter cover you will need a Phillips head screwdriver. First loosen the screws located at the four corners of the filter cover. Once the screws have been loosened, gently push the filter cover up until the large holes are aligned with the screw heads, then pull away from the television and set aside. Repeat this step for the other filter cover.

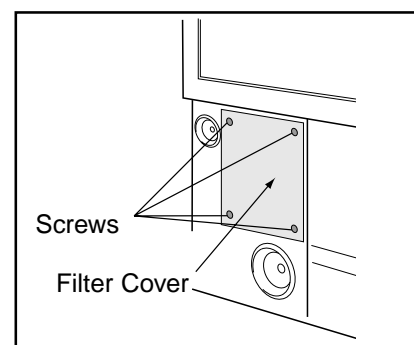

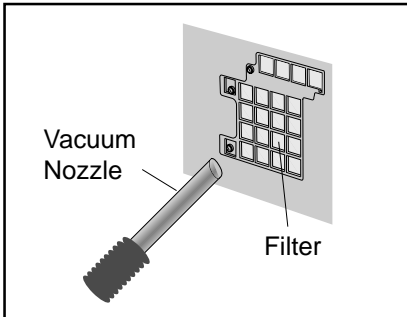

5) Cleaning the filter.

The air filters are now exposed. You may use a vacuum cleaner hose to remove dirt and dust from the surface of the filter. Do not remove the filters from the television.

Using a vacuum hose, gently work the nozzle close to the surface of the filter. Continue vacuuming until the dust and dirt has been removed from the filter surface. Do not touch the vacuum hose directly to the filter or try to pick dust off the surface by hand. This could cause the filter surface to tear.

6) Reinstall the filter cover.

Place the filter cover over the filter, aligning the large holes over the screw heads. Slide the filter cover down and tighten the four screws using the screwdriver. Repeat for the other filter cover.

7) Reinstall the speaker covers.

Replace the bottom of the speaker covers first. Insert the two pegs located at the bottom of the cover into the holes at the bottom lip of the television cabinet. When the pegs are in place, gently press the top part of the speaker cover against the television to reinstall. Once both speaker covers are back in place you may plug the television back into the AC power supply and return to normal television viewing.

Caution:

Do not remove the filter. Removing the filter could allow dust to get inside the television and stain the lenses inside the unit. Remove the left side filter unit only to replace the projection lamp (see Appendix B for instructions on changing the lamp). Do not use water to clean the filters. Water should not be allowed to get inside of the television, this will cause a malfunction of the unit.

Should the filters become damaged, call a trained service technician to have them replaced.

Caring for the Cabinet

Normally, light dusting with a soft, non-scratching duster will keep your TV clean.

If you wish to wipe down the television, first unplug it. Then wipe gently with a soft cloth, *slightly moistened* with water. You can add a few drops of mild liquid detergent to the water to help remove spots of oily dirt.

DO NOT allow liquid to enter the TV through the ventilation slots.

DO NOT use strong or abrasive cleaners on the TV.

DO NOT spray liquids or cleaners directly on the TV's surface.

DO NOT rub or scrub the TV harshly. Wipe the set gently with a soft cloth.

Caring for the Screen

The screen of the AV-61S902 is treated with an electrostatic-proof coating. When it gets dirty, wipe it gently with a soft cloth. If the screen is very dirty, wipe it down with a cloth dipped in a diluted kitchen cleaner and thoroughly wrung-out. Then wipe immediately after with a clean, dry cloth.

Do not apply alcohol, organic solvents (like acetone), acidic or alkaline cleansers to the screen. These will remove the coating layer and cause discolorations.

Do not push or hit the screen. This could cause scratches on the screen surface and image distortions.

Appendix B

Changing the Lamp

WARNING!

It is very important you **DO NOT TOUCH THE GLASS SURFACE OF THE NEW LAMP**. Touching the glass surface will deposit oils from your hand onto the lamp surface. When the lamp heats up to operating temperature, the oil will cause a difference in temperature on the lamp surface. This will likely cause the lamp to break.

Replace the lamp with **part number PK-CL200U only!** The television is designed to work specifically with this lamp. Using a different lamp, or a third-party manufacturer's lamp could cause a malfunction and/or damage to the television.

The AV-61S902 uses a 200 Watt high-pressure mercury lamp to project images onto the television screen. When the lamp nears the end of its operating life, you may notice the picture becoming dark. When the picture begins to darken, the lamp burns out, it is time to replace the lamp. The following instructions will tell you how to safely replace the projection lamp.

WARNING!

Under operating conditions THE LAMP WILL GET EXTREMELY HOT AND WILL CAUSE SEVERE BURNS IF TOUCHED.

Before attempting to replace the lamp, make sure the television has run through its cooling cycle (indicated by the front panel 10 LED lights) and that the television is unplugged. If you feel any warmth coming from the lamp DO NOT TOUCH IT. Wait until the lamp has fully cooled before attempting to replace it.

NEVER attempt to replace the lamp with the television plugged into a wall outlet. Attempting to replace a lamp with the television plugged in could lead to a severe electrical shock.

Please read these instructions fully before attempting to replace the lamp. If you feel unsure about replacing the lamp, call a service technician.

Replacement Lamp Kit

Before replacing the lamp you will need to purchase a replacement kit, part number PK-CL200U. Call 1-800-882-2345 to order the JVC replacement kit. The replacement kit will include:

1 High-Pressure Mercury Lamp
1 Hex wrench

1 Instruction Manual

The kit will also include instructions on recycling the lamp. ***Because the lamp contains a small amount of mercury, it cannot be disposed of with normal trash.*** Packaging, with a pre-paid shipping label for returning the lamp to a JVC-authorized recycling center for recycling, is included with the replacement lamp. See page 63 for recycling information.

Replacing the Lamp

Please read these instructions fully before attempting to replace the lamp. Please observe all safety warnings.

1) Turn the television off.

Press the Power button on the remote control or television's front panel to turn the television off. Wait until the picture has closed and the 10 LED lights on the front panel have stopped blinking indicating the lamp cool-down cycle is complete.

Warning: The cool-down cycle cools the lamp from its normal operating temperatures. This does not mean the lamp will now be cool enough to handle safely. Wait at least one hour before proceeding.

2) Unplug the television.

Disconnect the television's power cord from the AC outlet. Make sure the 10 LED lights have stopped blinking before you unplug the television. Never attempt to replace the lamp with the television plugged in.

3) Remove the left speaker panel.

The next step is to remove the left speaker panel located at the bottom of the front of the television cabinet. The top of the speaker panels are held with Velcro. **Make sure the television is unplugged** (see steps 1 and 2) before removing the speaker panel.

To remove the panel - Grab the panel from the side near the top. Gently pull the top away from the television. When the top part of the speaker panel is fully away from the television, lift up. The panel will come away from the bottom of the television. Set the panel aside.

4) Remove the filter cover.

The lamp is located behind the air filter unit. To access the lamp you will need to remove this filter unit and the filter cover. To remove this filter cover you will need a Phillips head screwdriver. First loosen the screws located at the four corners of the panel. Once the screws have been loosened, slide the cover up until the large holes align with the screw heads. Gently pull the panel away from the television and set aside. (Please see Appendix A for illustrations for removing the speaker panel and filter covers).

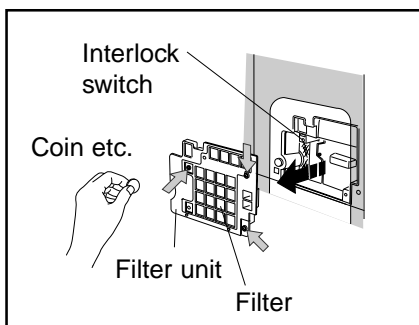

5) Removing the filter unit.

Next you will need to remove the filter unit. To remove the filter unit, use a something like a coin to loosen the three large-slotted screws fastening the filter unit. When the screws have been loosened, slide the filter unit out to remove it.

- Do not touch the surface of the filter or try to remove it from the filter unit. These actions could damage the filter. If the filter is damaged, call a service technician to replace the filter.

WARNING: DO NOT attempt to remove the assembly until the lamp has fully cooled down. If you feel any heat near the lamp unit, STOP the removal and wait until the lamp has FULLY COOLED.

NEVER attempt to remove the lamp unit with the television plugged into a wall outlet.

DO NOT DROP the used lamp. The inside of the lamp is under pressure. Dropping or other hard shock could cause the lamp to shatter.

ALWAYS recycle the used lamp. Because the lamp contains a small amount of mercury it cannot be thrown out with regular trash. Follow the recycling instructions included with the replacement lamp.

Appendix B

Replacing the Lamp - continued

Please read these instructions fully before attempting to replace the lamp. Please observe all safety warnings.

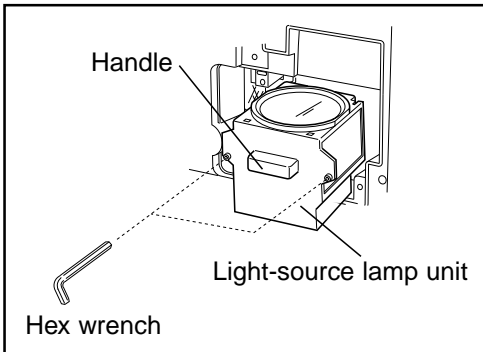

6) Removing the lamp unit.

Using the hex wrench included with the replacement lamp, loosen the two hex screws fastening the lamp unit. Remove the screws and set aside. When the screws have been removed, remove the lamp by grabbing the handle and sliding the unit towards you.

7) Install the new lamp unit

Slide the new lamp unit into the television by holding the handle attached to the unit. When the new lamp unit is securely installed inside the television, replace the hex screws using the hex wrench. To ensure the new lamp unit sits properly inside the television, secure the right

hex screw first, then the left. If the lamp unit does not sit securely inside the television, the television will not turn on.

WARNING!

Remember, it is very important you **DO NOT TOUCH THE GLASS SURFACE OF THE NEW LAMP**. Please re-read the warnings on page 61 regarding the new lamp unit.

Replace the lamp with **part number PK-CL200U only!** The television is designed to work specifically with this lamp. Lamps other than the PK-CL200U unit may cause malfunctions and/or damage to the television.



The lamp assembly in this product contains mercury. Disposal of the lamp assembly may be regulated due to environmental considerations. For information on replacement, disposal or recycling procedures, please contact JVC Customer Relations at 1-800-882-2345.

THE USED LAMP MUST BE RECYCLED. See page 63 for recycling instructions. To purchase a replacement kit, please call 1-800-882-2345.

8) Install the filter unit.

Position the filter unit back into its place, being careful not to touch the surface of the filter. Position the three screws and tighten using an correct-sized coin.

9) Reinstall the filter cover.

Place the filter cover over the filter. Insert the four screws and tighten them using the screwdriver.

10) Reinstall the speaker panel.

Replace the bottom of the speaker panel first. Insert the two pegs located at the bottom of the panel into the holes at the bottom lip of the television cabinet. When the pegs are in place, gently press the top part of the speaker panel against the television to reinstall. Once the speaker panel is back in place you may plug the television back into the AC power supply and return to normal television viewing.

If you have read the installation instructions and do not feel comfortable changing the lamp yourself, please call for a service technician.

Warning Messages

If the lamp replacement was successful, the television will operate normally. If there was a problem with the installation, one of several messages may display on the front panel LED lights.

Lamp installed on a slant or not fully inside the television.

If the lamp unit has been installed into the unit slanted (not flat) or is not fully inserted into the lamp housing inside the television, when the television is turned on the ON TIMER and POWER light will be flash. The 10 LEDs will light, then turn off one each five seconds. When all LEDs are off, the television still will not display a picture.

To correct: Reinstall the new lamp unit. Repeat the lamp installation steps, taking care to observe all warnings. Make sure when the lamp unit is reinstalled, it is inserted into the unit so it sits **FLAT** inside the unit.

If the ON TIMER light or POWER light is flashing you need to reset the television. Reset the television by unplugging the power cord from the AC outlet and then plugging the cord back into the outlet.

Filter not properly reinstalled.

If the filter unit has not been correctly reinstalled or if the filter has been damaged, the television will not turn on. When the Power button is pressed the 10 LEDs will turn on, then one will turn off every five seconds. When three have turned off the television will then enter a cool-down mode and the power will turn off.

To correct: Check to see that the filter has been installed properly. Repeat steps 1 to 5 and 8 to 10. You do not need to remove and reinstall the lamp. If the television still does not turn on, the filter may have been damaged. Call a service technician for repair.

If the television does not work properly, or displays a message not listed here, call a technician for service.

Recycling Information

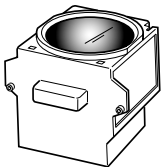

Save the box and packaging from your replacement lamp. You can use this packaging to return your used projection lamp for recycling. **Please do not throw the used lamp out with normal trash.** A pre-paid label is provided for this purpose. To package your used lamp for shipment, follow the simple steps below.

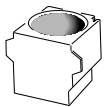

- 1) Collect the box and packaging from the replacement lamp. Make sure the used projection lamp has fully cooled before packaging.
- 2) Carefully wrap the used lamp in the bag which contained the new projection lamp. Close and secure the bag.
- 3) Place the bag with the lamp inside the box with the original packaging material. Close and seal the box with packing tape.
- 4) Remove the old shipping label. Place the new pre-paid shipping label on the outside of the box. You may give the box to any mail carrier or drop it off at your local post office for shipping.



The lamp assembly in this product contains mercury. Disposal of the lamp assembly may be regulated due to environmental considerations. For information on replacement, disposal or recycling procedures, please contact JVC Customer Relations at 1-800-252-5722.

Appendix C

LED Display

The front panel of the AV-61S902 features ten LED lights located under the television screen. These lights are used to display information about the operation of your television.

Starting Up

The projection lamp of the AV-61S902 requires time to warm up to its proper operating temperature. This warm up period should take about one minute. The warm up time remaining will be displayed on the front panel lights.

When the power is turned on, all ten lights will be lit. As the television warms up, lights will begin to go out about one every five seconds.

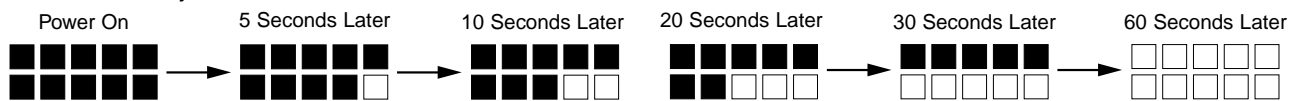

Shutting Down

When the television is shut off, a fan will continue to run for a period of time to cool the projection lamp. It is important that the fan be allowed to run and the television not unplugged or restarted during this cool down time. The front panel lights will display the following pattern:

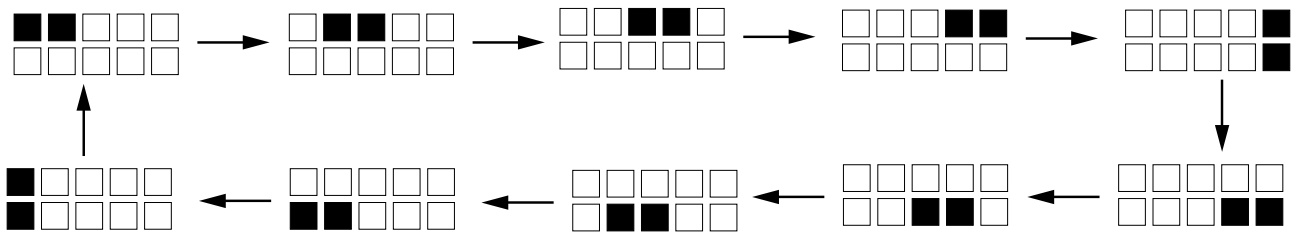

The lights will continue displaying this pattern until the projection lamp has sufficiently cooled. Cool-down time should be about one minute.

Lamp Usage

The front panel lights can also be used to show how many hours the projection lamp has been in use. It is important to keep track of the lamp usage hours so you can order a replacement before the life cycle of the current lamp ends. To check the projection lamp usage time, press and hold the MENU and VOLUME+ buttons on the remote control. With these buttons held, press the POWER button. The LED lights will begin to flash. These flashes will display the time the lamp has been used. For example:

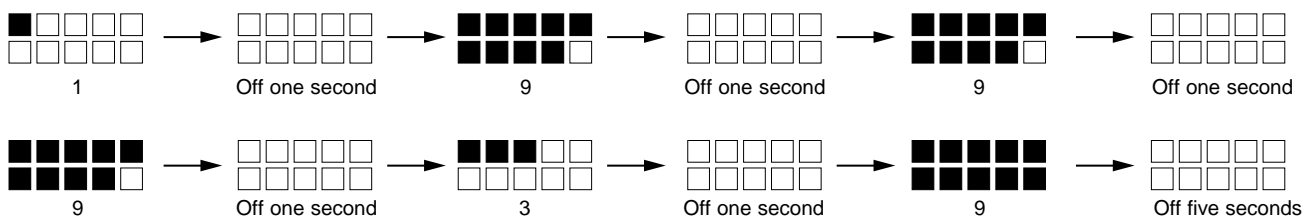

This display means the lamp has been used for 1999 hours and 30 minutes (1+9+9+9+3+0).



Limited Warranty

JVC COMPANY OF AMERICA warrants this product and all parts thereof, except as set forth below ONLY TO THE ORIGINAL PURCHASER AT RETAIL to be FREE FROM DEFECTIVE MATERIALS AND WORKMANSHIP from the date of original retail purchase for the period shown below. ("The Warranty Period")

PARTS 1 YEAR	LABOR 1 YEAR	LAMP 6 Months or 2000 Hours*
---------------------	---------------------	-------------------------------------

* whichever comes first.

THIS LIMITED WARRANTY IS VALID ONLY IN THE FIFTY (50) UNITED STATES, THE DISTRICT OF COLUMBIA AND COMMONWEALTH OF PUERTO RICO.

WHAT WE WILL DO:

If this product is found to be defective within the warranty period, JVC will repair or replace defective parts at no charge to the original owner. Such repair and replacement services shall be rendered during regular business hours by JVC authorized service centers. Parts used for replacement are warranted only for the remainder of this Warranty Period. Televisions with a screen size of 25 inches and larger are covered on an in-home basis.

WHAT YOU MUST DO FOR WARRANTY SERVICE:

Either contact the selling dealer (retailer) or call 1-800-252-5722 to arrange In-home service. In-home service will require clear access to the Television by the service technician.

WHAT IS NOT COVERED:

This limited warranty provided by JVC does not cover:

1. Products which have been subject to abuse, accident, alteration, modification, tampering, negligence, misuse, faulty installation, lack of reasonable care, or if repaired or serviced by anyone other than a service facility authorized by JVC to render such service, or if affixed to any attachment not provided with the products, or if the model or serial number has been altered, tampered with, defaced or removed.
2. Initial installation, installation and removal from "built-in" entertainment centers and other mounting systems.
3. Operational adjustments covered in the Owner's Manual, normal maintenance, including head cleaning.
4. Damage that occurs in shipment, due to an act of God, and cosmetic damage.
5. Signal reception problems and failures due to line power surge.
6. Products used for commercial purposes (including but not limited to rental).
- *7. Lamp is covered for 6 months or 2000 hours from date of purchase (whichever comes first). Labor to replace lamp is not included upon expiration of the lamp warranty period.
8. Accessories.
9. Batteries (except that Rechargeable Batteries are covered for 90 days from date of purchase).

There are no express warranties except as listed above.

THE DURATION OF ANY IMPLIED WARRANTIES, INCLUDING THE IMPLIED WARRANTY OF MERCHANTABILITY, IS LIMITED TO THE DURATION OF THE EXPRESS WARRANTY HEREIN.

JVC SHALL NOT BE LIABLE FOR THE LOSS OF USE OF THE PRODUCT, INCONVENIENCE, OR ANY OTHER DAMAGES, WHETHER DIRECT, INCIDENTAL OR CONSEQUENTIAL (INCLUDING, WITHOUT LIMITATION, DAMAGE TO TAPES, RECORDS OR DISCS) RESULTING FROM THE USE OF THIS PRODUCT, OR ARISING OUT OF ANY BREACH OF THIS WARRANTY, ALL EXPRESS AND IMPLIED WARRANTIES, INCLUDING THE WARRANTIES OF MERCHANTABILITY AND FITNESS FOR PARTICULAR PURPOSE, ARE LIMITED TO THE WARRANTY PERIOD SET FORTH ABOVE.

Some states do not allow the exclusion of incidental or consequential damages or limitations on how long the warranty lasts, so these exclusions or limitations may not apply to you. This warranty gives you specific legal rights and you may also have other rights which vary state to state.

JVC COMPANY OF AMERICA
DIVISION OF JVC AMERICAS CORP.

1700 Valley Road
Wayne, New Jersey 07470

<http://www.jvc.com>

REFURBISHED PRODUCTS CARRY A SEPARATE WARRANTY. THIS WARRANTY DOES NOT APPLY. FOR DETAILS OF REFURBISHED PRODUCT WARRANTY, PLEASE REFER TO THE REFURBISHED PRODUCT WARRANTY INFORMATION PACKAGED WITH EACH REFURBISHED PRODUCT.

For customer use:

Enter below the Model No. and Serial No. which is located either on the rear, bottom or side of the cabinet. Retain this information for future reference.

Model No.: _____ Serial No.: _____
Purchase Date: _____ Name Of Dealer: _____

Authorized Service Centers

QUALITY **JVC** SERVICE
HOW TO LOCATE YOUR JVC SERVICE CENTER
TOLL FREE: 1 (800) 252-5722
<http://www.jvc.com>

Dear Customer,

In order to receive the most satisfaction from your purchase, please read the instruction booklet before operating the unit. In the event that repairs are necessary, call our Customer Relations Department at 1-800-252-5722 or visit our website at **www.JVC.com**

Remember to retain your Bill of Sale for Warranty Service.

Don't service the television yourself

Caution

To prevent electrical shock, do not open the cabinet. There are no user serviceable parts inside. Please refer to qualified service personnel for repairs.

Accessories

To purchase accessories for your JVC product, please call toll free: 1 (800)882-2345 or on the web at **www.JVC.com**

For service in Canada

To locate your local JVC service center or dealer in Canada please call:

In Eastern Canada:
1 (416)293-1311

In Western Canada:
1 (604)270-1311

En Français (Montréal):
1 (514)871-1311

Or visit us on the web at **www.JVC.ca**

Specifications

MODEL	AV-61S902
Type	D-ILA Hologram Device Projection Television
Reception Format	NTSC, BTSC System (Multi-Channel Sound) 1080i DTV digital broadcast ready
Reception Range	VHF 2 to 13, UHF 14 to 69 Sub Mid, Super, Hyper and Ultra bands (181 channel frequency synthesizer system)
Power Source	AC 120V, 60 Hz
Power Consumption	430W
Projection Source	200W Ultra High-Pressure Mercury Lamp
Screen Size	61 inch / 155 cm measured diagonally, 16:9 ratio
Sound	Dolby Pro Logic Surround, Dolby 3-D Phonic and DAP
Speakers	10 cm round x 2 Full Range + 16 cm round x 2 Subwoofers
Audio Output	Full Range - 10W x 2 • Subwoofers - 15W x 2 (50W total)
Antenna Terminal	75 ohms (VHF/UHF) (F-type connector)
External Input Jacks	Video: 1 Vp-p, 75 ohms Audio: 500mVrms (-4dBs) high impedance
Component Input Jacks	Y: 1Vp-p positive, 75 ohms (negative sync provided) PB/PR: 0.7 Vp-p, 75 ohms
S-Video Input Jacks	Y: 1Vp-p positive, 75 ohms (negative sync provided) C: 0.286 Vp-p (burst signal), 75 ohms
AV Compu Link EX Jack	3.5 mm mini jack x 1
Digital-In	DVI 25 pin • The Digital-In terminal is not compatible with the picture signal of a personal computer.
Dimensions (In) WxHxD (cm)	57 ¹ / ₄ x 59 ³ / ₈ x 24 ⁷ / ₈ (145.1 x 150.8 x 62.9)
Weight (lbs / kg)	258 (lbs) / 117 (kg)
Accessories	Illuminated remote control unit / AA batteries x 2

Specifications subject to change without notice.

JVC COMPANY OF AMERICA
Division of JVC Americas Corp.
1700 Valley Road
Wayne, New Jersey, 07470



JVC CANADA, INC.
21 Finchdene Square
Scarborough, Ontario
Canada, M1X 1A7



LCT0942-001A
0101-TN-CR-IWAI

Free Manuals Download Website

<http://myh66.com>

<http://usermanuals.us>

<http://www.somanuals.com>

<http://www.4manuals.cc>

<http://www.manual-lib.com>

<http://www.404manual.com>

<http://www.luxmanual.com>

<http://aubethermostatmanual.com>

Golf course search by state

<http://golfingnear.com>

Email search by domain

<http://emailbydomain.com>

Auto manuals search

<http://auto.somanuals.com>

TV manuals search

<http://tv.somanuals.com>