

# JVC

## INSTRUCTIONS MANUEL D'INSTRUCTIONS MANUAL DE INSTRUCCIONES

### D-ILA PROJECTOR PROJECTEUR D-ILA PROYECTOR D-ILA **DLA-HD750**



**D-ILA**<sup>®</sup>  
**HDMI**<sup>™</sup>  
HIGH-DEFINITION MULTIMEDIA INTERFACE  
**THX**<sup>®</sup>

**For Customer use :**

Enter below the serial No. which is located on the side of the cabinet. Retain this information for future reference.

Model No. DLA-HD750

Serial No. \_\_\_\_\_

**Pour utilisation par le client :**

Entrer ci-dessous le N° de série qui est situé sous le boîtier. Garder cette information comme référence pour le futur.

N° de modèle DLA-HD750

N° de série \_\_\_\_\_

**Instrucción para el cliente :**

Introduzca a continuación el n° de serie que aparece en la parte inferior lateral de la caja. Conserve esta información como referencia para uso ulterior.

Modelo N° DLA-HD750

N° de serie \_\_\_\_\_

DLA-HD750

DLA-HD750

D-ILA PROJECTOR  
PROJECTEUR D-ILA  
PROYECTOR D-ILA

# JVC

# Safety Precautions

## IMPORTANT INFORMATION

This product has a High Intensity Discharge (HID) lamp that contains mercury.

Disposal of these materials may be regulated in your community due to environmental considerations. For disposal or recycling information, please contact your local authorities or for USA, the Electronic Industries Alliance: <http://www.eiae.org>.

**WARNING:**

TO PREVENT FIRE OR SHOCK HAZARDS, DO NOT EXPOSE THIS APPLIANCE TO RAIN OR MOISTURE.

**WARNING:**

THIS APPARATUS MUST BE EARTHED.

**CAUTION:**

To reduce the risk of electric shock, do not remove cover. Refer servicing to qualified service personnel.

This projector is equipped with a 3-blade grounding type plug to satisfy FCC rule. If you are unable to insert the plug into the outlet, contact your electrician.

**FCC INFORMATION (U.S.A. only)**

**CAUTION:**

Changes or modification not approved by JVC could void the user's authority to operate the equipment.

**NOTE:**

This equipment has been tested and found to comply with the limits for Class B digital devices, pursuant to Part 15 of the FCC Rules. These limits are designed to provide reasonable protection against harmful interference in a residential installation. This equipment generates, uses, and can radiate radio frequency energy and, if not installed and used in accordance with the instructions, may cause harmful interference to radio communications. However, there is no guarantee that interference will not occur in a particular installation. If this equipment does cause harmful interference to radio or television reception, which can be determined by turning the equipment off and on, the user is encourage to try to correct the interference by one or more of the following measures:

- Reorient or relocate the receiving antenna.
- Increase the separation between the equipment and receiver.
- Connect the equipment into an outlet on a circuit different from that to which the receiver is connected.
- Consult the dealer or an experienced radio/TV technician for help.

**MACHINE NOISE INFORMATION (Germany only)**

Changes Machine Noise Information Ordinance 3. GSGV, January 18, 1991: The sound pressure level at the operator position is equal or less than 19 dB (A) according to ISO 7779.

**About the installation place**

Do not install the projector in a place that cannot support its weight securely.

If the installation place is not sturdy enough, the projector could fall or overturn, possibly causing personal injury.

## IMPORTANT SAFEGUARDS

Electrical energy can perform many useful functions. This unit has been engineered and manufactured to assure your personal safety. But IMPROPER USE CAN RESULT IN POTENTIAL ELECTRICAL SHOCK OR FIRE HAZARD. In order not to defeat the safeguards incorporated into this product, observe the following basic rules for its installation, use and service. Please read these Important Safeguards carefully before use.

- All the safety and operating instructions should be read before the product is operated.
- The safety and operating instructions should be retained for future reference.
- All warnings on the product and in the operating instructions should be adhered to.
- All operating instructions should be followed.
- Place the projector near a wall outlet where the plug can be easily unplugged.
- Unplug this product from the wall outlet before cleaning. Do not use liquid cleaners or aerosol cleaners. Use a damp cloth for cleaning.
- Do not use attachments not recommended by the product manufacturer as they may be hazardous.
- Do not use this product near water. Do not use immediately after moving from a low temperature to high temperature, as this causes condensation, which may result in fire, electric shock, or other hazards.
- Do not place this product on an unstable cart, stand, or table. The product may fall, causing serious injury to a child or adult, and serious damage to the product. The product should be mounted according to the manufacturer's instructions, and should use a mount recommended by the manufacturer.
- When the product is used on a cart, care should be taken to avoid quick stops, excessive force, and uneven surfaces which may cause the product and cart to overturn, damaging equipment or causing possible injury to the operator.
- Slots and openings in the cabinet are provided for ventilation. These ensure reliable operation of the product and protect it from overheating. These openings must not be blocked or covered. (The openings should never be blocked by placing the product on bed, sofa, rug, or similar surface. It should not be placed in a built-in installation such as a bookcase or rack unless proper ventilation is provided and the manufacturer's instructions have been adhered to.)

PORTABLE CART WARNING  
(symbol provided by RETAC)



S3126A

- To allow better heat dissipation, keep a clearance between this unit and its surrounding as shown below. When this unit is enclosed in a space of dimensions as shown below, use an air-conditioner so that the internal and external temperatures are the same.

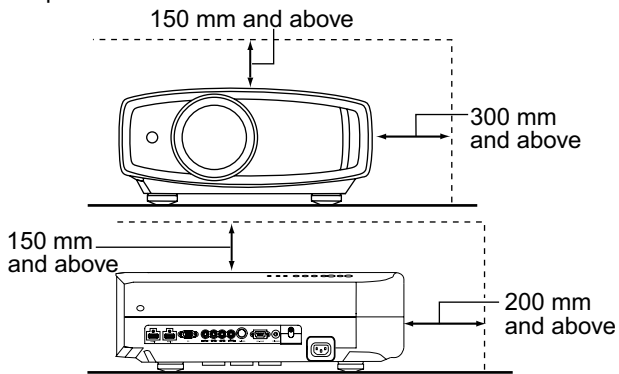

- power source indicated on the label. If you are not sure of the type of power supply to your home, consult your product dealer or local power company.
- This product is equipped with a three-wire plug. This plug will fit only into a grounded power outlet. If you are unable to insert the plug into the outlet, contact your electrician to install the proper outlet. Do not defeat the safety purpose of the grounded plug.
- Power-supply cords should be routed so that they are not likely to be walked on or pinched by items placed upon or against them. Pay particular attention to cords at doors, plugs, receptacles, and the point where they exit from the product.
- For added protection of this product during a lightning storm, or when it is left unattended and unused for long periods of time, unplug it from the wall outlet and disconnect the cable system. This will prevent damage to the product due to lightning and power line surges.
- Do not overload wall outlets, extension cords, or convenience receptacles on other equipment as this can result in a risk of fire or electric shock.
- Never push objects of any kind into this product through openings as they may touch dangerous voltage points or short out parts that could result in a fire or electric shock. Never spill liquid of any kind on the product.
- Do not attempt to service this product yourself as opening or removing covers may expose you to dangerous voltages and other hazards. Refer all service to qualified service personnel.
- Unplug this product from the wall outlet and refer service to qualified service personnel under the following conditions:
  - a) When the power supply cord or plug is damaged.
  - b) If liquid has been spilled, or objects have fallen on the product.
  - c) If the product has been exposed to rain or water.
  - d) If the product does not operate normally by following the operating instructions. Adjust only those controls that are covered by the Operation Manual, as an improper adjustment of controls may result in damage and will often require extensive work by a qualified technician to restore the product to normal operation.
  - e) If the product has been dropped or damaged in any way.
  - f) When the product exhibits a distinct change in performance - this indicates a need for service.
- When replacement parts are required, be sure the service technician has used replacement parts specified by the manufacturer or with same characteristics as the original part. Unauthorized substitutions may result in fire, electric shock, or other hazards.

- Upon completion of any service or repairs to this product, ask the service technician to perform safety checks to determine that the product is in proper operating condition.
- The product should be placed more than one foot away from heat sources such as radiators, heat registers, stoves, and other products (including amplifiers) that produce heat.
- When connecting other products such as VCR's, and DVD players, you should turn off the power of this product for protection against electric shock.
- Do not place combustibles behind the cooling fan. For example, cloth, paper, matches, aerosol cans or gas lighters that present special hazards when over heated.
- Do not look into the projection lens while the illumination lamp is turned on. Exposure of your eyes to the strong light can result in impaired eyesight.
- Do not look into the inside of this unit through vents (ventilation holes), etc. Do not look at the illumination lamp directly by opening the cabinet while the illumination lamp is turned on. The illumination lamp also contains ultraviolet rays and the light is so powerful that your eyesight can be impaired.
- Do not drop, hit, or damage the light-source lamp (lamp unit) in any way. It may cause the light-source lamp to break and lead to injuries. Do not use a damaged light source lamp. If the light-source lamp is broken, ask your dealer to repair it. Fragments from a broken light-source lamp may cause injuries.
- The light-source lamp used in this projector is a high pressure mercury lamp. Be careful when disposing of the light-source lamp. If anything is unclear, please consult your dealer.
- Do not ceiling-mount the projector to a place which tends to vibrate; otherwise, the attaching fixture of the projector could be broken by the vibration, possibly causing it to fall or overturn, which could lead to personal injury.
- Use only the accessory cord designed for this product to prevent shock.

**\*DO NOT allow any unqualified person to install the unit.**

Be sure to ask your dealer to install the unit (e.g. attaching it to the ceiling) since special technical knowledge and skills are required for installation. If installation is performed by an unqualified person, it may cause personal injury or electrical shock.

# Safety Precautions (Continued)

## POWER CONNECTION

For USA and Canada only  
Use only the following power cord.

Power cord



The power supply voltage rating of this product is AC110V – AC240V. Use only the power cord designated by our dealer to ensure Safety and EMC.

Ensure that the power cable used for the projector is the correct type for the AC outlet in your country. Consult your product dealer.

Power cord

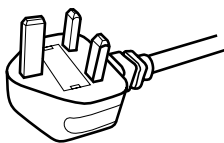

For United Kingdom

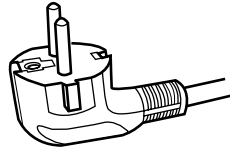

For European continent countries

**WARNING:**

**Do not cut off the main plug from this equipment.**

If the plug fitted is not suitable for the power points in your home or the cable is too short to reach a power point, then obtain an appropriate safety approved extension lead or adapter or consult your dealer.

If nonetheless the mains plug is cut off, dispose of the plug immediately, to avoid a possible shock hazard by inadvertent connection to the main supply. If a new main plug has to be fitted, then follow the instruction given below.

**WARNING:**

**THIS APPARATUS MUST BE EARTHED.**

**IMPORTANT (Europe only):**

The wires in the mains lead on this product are colored in accordance with the following cord:

- Green-and-yellow : Earth
- Blue : Neutral
- Brown : Live

As these colors may not correspond with the colored making identifying the terminals in your plug, proceed as follows:

The wire which is colored green-and-yellow must be connected to the terminal which is marked M with the letter E or the safety earth or colored green or green-and-yellow.

The wire which is colored blue must be connected to the terminal which is marked with the letter N or colored black.

The wire which is colored brown must be connected to the terminal which is marked with the letter L or colored red.

## POWER CONNECTION (United Kingdom only)

**HOW TO REPLACE THE FUSE:**

When replacing the fuse, be sure to use only a correctly rated approved type, re-fit the fuse cover.

**IF IN DOUBT — CONSULT A COMPETENT ELECTRICIAN.**

Open the fuse compartment with the blade screwdriver, and replace the fuse.

(\* An example is shown in the illustration below.)

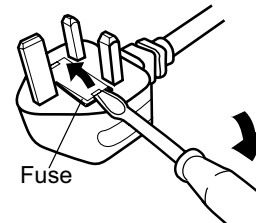

Dear Customer,

This apparatus is in conformance with the valid European directives and standards regarding electromagnetic compatibility and electrical safety.

European representative of Victor Company of Japan, Limited is:

JVC Technical Services Europe GmbH

Postfach 10 05 04

61145 Friedberg

Germany

**Information for Users on Disposal of Old Equipment and Batteries****Products****Battery****[European Union only]**

These symbols indicate that equipment with these symbols should not be disposed of as general household waste. If you want to dispose of the product or battery, please consider the collection systems or facilities for appropriate recycling.

**Notice:** The sign Pb below the symbol for batteries indicates that this battery contains lead.

**Benutzerinformationen zur Entsorgung alter Geräte und Batterien****Produkte****Batterie****[Nur Europäische Union]**

Diese Symbole zeigen an, dass derartig gekennzeichnete Geräte nicht als normaler Haushaltsabfall entsorgt werden dürfen. Wenden Sie sich zur Entsorgung des Produkts oder der Batterie an die hierfür vorgesehenen Sammelstellen oder Einrichtungen, damit eine fachgerechte Wiederverwertung möglich ist.

**Hinweis:** Das Zeichen Pb unterhalb des Batteriesymbols gibt an, dass diese Batterie Blei enthält.

**Informations relatives à l'élimination des appareils et des piles usagés, à l'intention des utilisateurs****Produits****Pile****[Union européenne seulement]**

Si ces symboles figurent sur les produits, cela signifie qu'ils ne doivent pas être jetés comme déchets ménagers. Si vous voulez jeter ce produit ou cette pile, veuillez considérer le système de collection de déchets ou les centres de recyclage appropriés.

**Notification:** La marque Pb en dessous du symbole des piles indique que cette pile contient du plomb.

**Informatie voor gebruikers over het verwijderen van oude apparatuur en batterijen****Producten****Batterij****[Alleen Europese Unie]**

Deze symbolen geven aan dat apparatuur met dit symbool niet mag worden weggegooid als algemeen huishoudelijk afval. Als u het product of de batterij wilt weggoien, kunt u inzamelsystemen of faciliteiten voor een geschikte recycling gebruiken.

**Opmerking:** Het teken Pb onder het batterijsymbool geeft aan dat deze batterij lood bevat.

### Información para los usuarios sobre la eliminación de baterías/pilas usadas



Productos



Baterías/pilas

#### [Sólo Unión Europea]

Estos símbolos indican que el equipo con estos símbolos no debe desecharse con la basura doméstica. Si desea desechar el producto o batería/pila, acuda a los sistemas o centros de recogida para que los reciclen debidamente.

**Atención:** La indicación Pb debajo del símbolo de batería/pila indica que ésta contiene plomo.

### Informazioni per gli utenti sullo smaltimento delle apparecchiature e batterie obsolete



Prodotti



Batteria

#### [Solo per l'Unione Europea]

Questi simboli indicano che le apparecchiature a cui sono relativi non devono essere smaltite tra i rifiuti domestici generici. Se si desidera smaltire questo prodotto o questa batteria, prendere in considerazione i sistemi o le strutture di raccolta appropriati per il riciclaggio corretto.

**Nota:** Il simbolo Pb sotto il simbolo delle batterie indica che questa batteria contiene piombo.

### Informação para os utilizadores acerca da eliminação de equipamento usado e pilhas



Produtos



Pilha

#### [Apenas União Europeia]

Estes símbolos indicam que o equipamento com estes símbolos não deve ser eliminado juntamente com o restante lixo doméstico. Se pretende eliminar o produto ou a pilha, utilize os sistemas de recolha ou instalações para uma reciclagem apropriada.

**Aviso:** O sinal Pb abaixo do símbolo para pilhas indica que esta pilha contém chumbo.

### Πληροφορίες για την απόρριψη παλαιού εξοπλισμού και μπαταριών



Προϊόντα



Μπαταρία

#### [Ευρωπαϊκή Ένωση μόνο]

Αυτά τα σύμβολα υποδηλώνουν ότι ο εξοπλισμός που τα φέρει δεν θα πρέπει να απορριφθεί ως κοινό οικιακό απόρριμμα. Εάν επιθυμείτε την απόρριψη αυτού του προϊόντος ή αυτής της μπαταρίας, χρησιμοποιήστε το σύστημα περισυλλογής ή εγκαταστάσεις για ανάλογη ανακύκλωση.

**Σημείωση:** Το σύμβολο Pb κάτω από το σύμβολο μπαταρίας υποδηλώνει ότι η μπαταρία περιέχει μόλυβδο.

## DANSK

## Brugerinformation om bortskaffelse af gammelt udstyr og batterier



Produkter



Batteri

**[Kun EU]**

Disse symboler angiver, at udstyr med disse symboler ikke må bortskaffes som almindeligt husholdningsaffald. Hvis du ønsker at smide dette produkt eller batteri ud, bedes du overveje at bruge indsamlingssystemet eller steder, hvor der kan ske korrekt genbrug.

**Bemærk:** Tegnet Pb under symbolet for batterierne angiver, at dette batteri indeholder bly.

## SUOMI

## Tietoja vanhojen laitteiden ja akkujen hävittämisestä



Tuotteet



Akku

**[Vain Euroopan unioni]**

Nämä symbolit ilmaisevat, että symboleilla merkittyä laitetta ei tulisi hävittää tavallisen kotitalousjätteen mukana. Jos haluat hävittää tuotteen tai sen akun, tee se hyödyntämällä akkujen keräyspisteitä tai muita kierrätyspaikkoja.

**Huomautus:** Akkusymbolin alapuolella oleva Pb-merkintä tarkoittaa, että akku sisältää lyijyä.

## SVENSKA

## Information för användare gällande bortskaffning av gammal utrustning och batterier

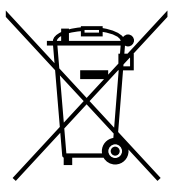

Produkter



Batteri

**[Endast den Europeiska unionen]**

Dessa symboler indikerar att utrustning med dessa symboler inte ska hanteras som vanligt hushållsavfall. Om du vill bortskaffa produkten eller batteriet ska du använda uppsamlingssystem eller inrättningar för lämplig återvinning.

**Observera!** Märkningen Pb under symbolen för batterier indikerar att detta batteri innehåller bly.

## NORSK

## Opplysninger til brukere om kassering av gammelt utstyr og batterier

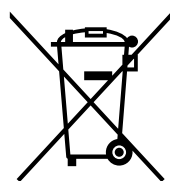

Produkter



Batteri

**[Bare EU]**

Disse symbolene viser at utstyr med dette symbolet, ikke skal kastes sammen med vanlig husholdningsavfall. Hvis du vil kassere dette produktet eller batteriet, skal du vurdere å bruke innsamlingssystemene eller andre muligheter for riktig gjenbruk.

**Merk:** Tegnet Pb under symbolet for batterier, viser at batteriet inneholder bly.

### Сведения для пользователей по утилизации старого оборудования и батарей



Изделия



Батарея

#### [только для Европейского союза]

Данные символы указывают на то, что оборудование, на которое они нанесены, не должны утилизироваться, как обычные бытовые отходы. При необходимости утилизировать такое изделие или батарею обратитесь в специальный пункт сбора для их надлежащей переработки.

**Уведомление:** Надпись Pb под символом батарей указывает на то, что данная батарея содержит свинец.

### Informace pro uživatele k likvidaci starého zařízení a baterií



Produkty



Baterie

#### [Pouze Evropská unie]

Tyto symboly označují, že produkty s těmito symboly se nesmí likvidovat jako běžný odpad. Pokud chcete produkt nebo baterii zlikvidovat, využijte sběrný systém nebo jiné zařízení, které zajistí řádnou recyklaci.

**Upozornění:** Značka Pb pod symbolem pro baterie znamená, že tato baterie obsahuje olovo.

### Informacje dla użytkowników dotyczące pozbywania się zużytego sprzętu i baterii



Produkty



Bateria

#### [Tylko kraje Unii Europejskiej]

Te symbole oznaczają, że sprzętu nie należy wyrzucać razem z odpadami gospodarczymi. Jeśli trzeba pozbyć się tego produktu lub baterii, proszę skorzystać z systemu odbioru lub urządzeń do zbiórki odpadów elektronicznych, w celu odpowiedniego ponownego ich przetworzenia.

**Uwaga:** Oznaczenie Pb, znajdujące się pod symbolem baterii wskazuje, że ta bateria zawiera ołów.

### Felhasználói információ az elhasznált berendezések és akkumulátorok elhelyezéséről



Termékek



Akkumulátor

#### [Csak az Európai Unióban]

Ez a szimbólum azt jelzi, hogy a berendezés nem helyezhető az általános háztartási hulladék közé. Ha meg szeretne szabadulni a terméktől vagy az akkumulátortól, akkor legyen tekintettel az gyűjtő rendszerre vagy intézményekre a megfelelő hasznosítás érdekében.

**Megjegyzés:** Az alábbi Pb szimbólum - ha az akkumulátoron megtalálható - azt jelzi, hogy az akkumulátor ólmot tartalmaz.



# THX Certification



## THX Certification

THX Ltd. was founded by filmmaker George Lucas to improve the cinema and home entertainment experience through strict engineering standards and breakthrough technologies. THX has leveraged more than 25 years of filmmaking, cinema design and post-production expertise to partner with JVC to engineer a best-in-class home theater projector.

With a strict focus on image quality and signal processing performance, THX certification promises that this JVC projector is capable of presenting a wide range of video content at maximum resolutions with the correct color and luminance levels. In addition, THX has created a battery of signal processing tests that challenge the projector's scaling, motion conversion and de-interlacing capabilities. This type of in-depth analysis predicts how the projector will present a variety of high definition and standard definition content.

The JVC projector also features THX Movie Mode, a pre-calibrated video setting for watching movies on DVD, Blu-ray HD or broadcast television. This playback feature is designed to recreate the cinema experience at home by setting the display's gamma, luminance, color temperature and other settings to mirror those used by filmmakers in post-production. THX Movie Mode also ensures projector brightness is optimal for large screen viewing.



**RECOMMENDED USE**

All Home Theaters or Living Rooms

**THX CERTIFICATION FEATURES**

**THX Movie Mode:**

- Correct Gamma and Color Temperature
- No Overscan or Scaling
- Correct High Def Color Gamut

**THX PERFORMANCE**

**Best in Class Parameters include:**

- ANSI and Sequential Contrast
- Luminance and Color Uniformity
- Color Tracking with Gray Scale
- Optimum Brightness
- Deinterlacing Performance
- Jaggies and Contouring

Visit [www.thx.com](http://www.thx.com) for further technical details.

# Main Features



## Supports Multiple Digital Devices

- Comes with 2 independent HDMI terminals that allows digital transmission of high definition signals. (  P18)



## Beautiful Images on Big Screen

- Enjoy smooth and high resolution video images with no visible grid, brought about by full high definition resolution of 1920 x 1080 pixels. (📖P26)

## Perfect for Any Location

- Comes with an 80% vertical and 34% horizontal lens shift function. (📖P23)

# Contents

## Getting started

- Safety Precautions.....2**
- THX Certification.....9**
- Main Features.....10**
- Contents.....12**
- How to Read this Manual/Accessories/**
- Optional Accessories.....13**
  - About this Manual.....13
  - Check the Accessories.....13
  - Optional Accessories.....13
- Controls and features.....14**
- How to Use the Remote control.....17**
  - Loading Batteries.....17
  - Effective Range of Remote Control Unit.....17

## Preparation

- Selecting Connecting Devices.....18**
- Connecting.....19**
  - Connecting via Video Cable and S-Video Cable.....19
  - Connecting via Component Video Cable.....19
  - Connecting via HDMI Cable.....20
  - Connecting via HDMI-DVI Conversion Cable...20
  - Connecting via SCART-RCA Cable.....21
  - Connecting via RGB Video Cable.....21
  - Connecting via PC Cable.....22
  - Connecting via Trigger Cable.....22
- Installing the Projector and Screen.....23**
  - Set Angle.....23
  - Shift Adjustment.....23
  - Screen Size and Projection Distance.....25

## Basic Operation

- Projecting Image.....26**

- Convenient Features during Projection.....28**
  - Setting the Screen Size.....28
  - Masking the Surrounding Area of an Image...28

## Settings

- Setting Menu.....30**
  - Procedures for Menu Operation.....30
  - Setting Menu.....31
- Customizing Projected Images.....42**
  - Changing the Initial Setting of Picture Mode 42
  - Registering User-defined Picture Mode.....43
  - Registering User-defined Picture Mode from the Menu.....43

## Troubleshooting

- Troubleshooting.....44**
- What to Do When these Messages Are Displayed.....46**
- About Warning Indicators.....47**
  - Actions to Be Taken for Warning Mode.....47
- Replacing the Lamp.....48**
  - Procedure for Lamp Replacement.....48
  - Resetting Lamp Time.....50
- Cleaning and Replacing the Filter.....51**

## Others

- RS-232C Interface.....52**
  - RS-232C Specifications.....52
  - Command Format.....52
  - RS-232C Communication Examples.....55
- Copyright and Caution.....56**
  - About Trademarks and Copyright.....56
  - Caution.....56
  - Mounting this Unit.....57
- Specifications.....58**
  - Dimensions.....60

# How to Read this Manual/ Accessories/Optional Accessories

## About this Manual

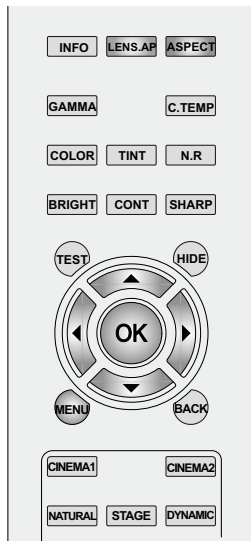

Buttons to be used are colored in a darker shade.

This manual mainly describes the operating method using the remote control.

- Buttons on the remote control are described as [Button Name].
- Items on the menu are described as "Selection Item".

### ■ Conventions in this manual



Describes the limitations of the functions or usage.



Indicates good-to-know information.



Describes operational precautions.



P13 Indicates relevant pages for reference.

## Check the Accessories

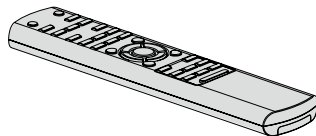

Remote Control

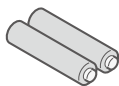

AAA size Batteries  
(for operation confirmation)

The power cord supplied varies depending on the destination.

For the US market (X1):

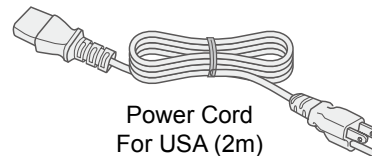

Power Cord  
For USA (2m)

For the EU market (X2):

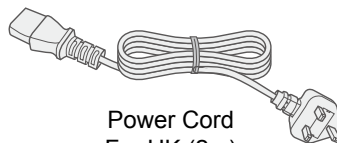

Power Cord  
For UK (2m)

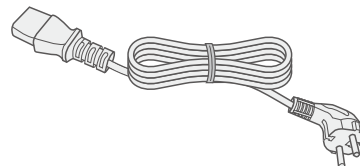

Power Cord  
For European continent countries (2m)

- Instruction manual, warranty card and other printed material are also included.

## Optional Accessories

Please check with your authorized dealer for details.

- Replacement Lamp: BHL5010-S (Lamp Unit)
- Replacement Filter (black in appearance): PB006560999 (Inner Filter)

# Controls and features

## ■ Front Side/Left Side



### CAUTION

- Do not place your fingers in the gap at the lens during lens shift adjustment. This may cause injuries if your fingers are caught in between the gap.  
(P23)
- Do not let your fingers or other objects get caught in between the lens cover while closing the cover. This can cause injuries or malfunction.

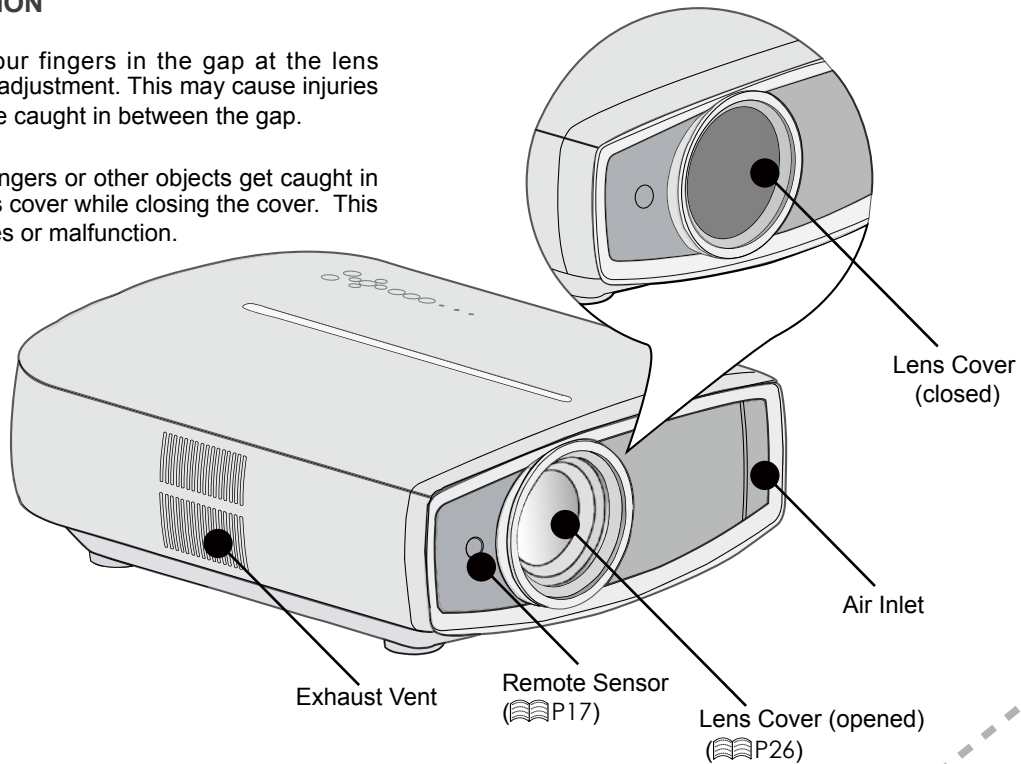

## ■ Rear Side/Top Side/Right Side

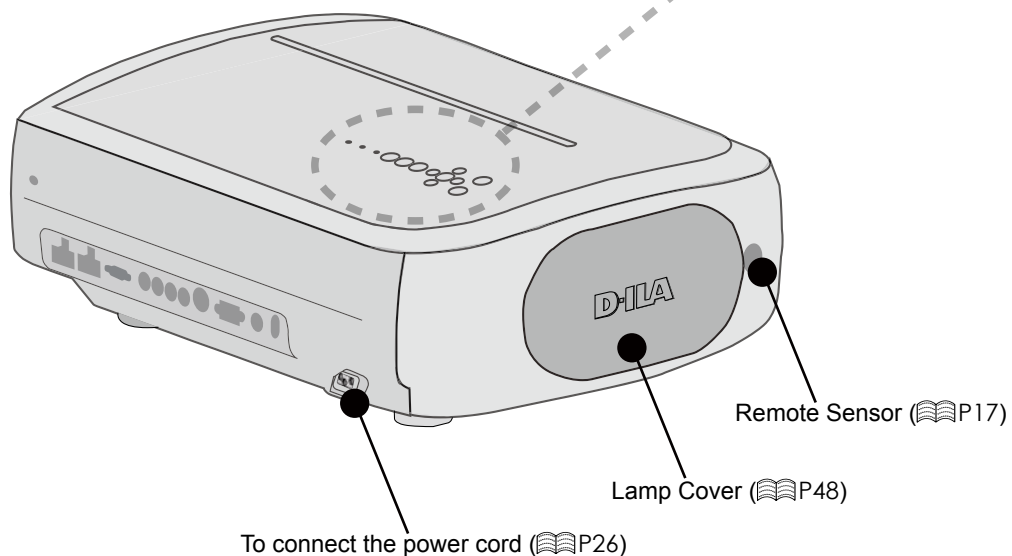

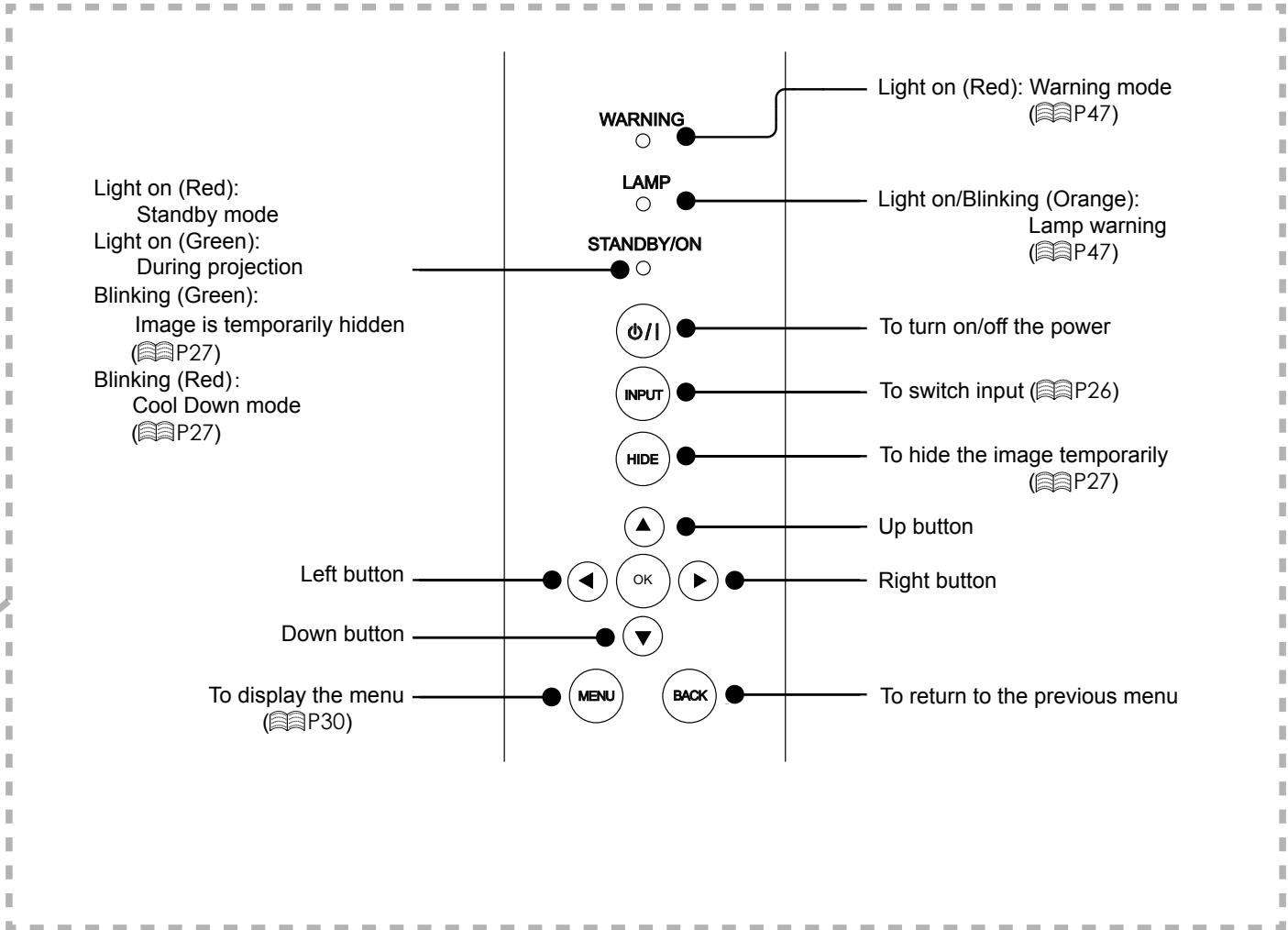

■ Bottom Surface

Feet: The height (0 to 5 mm) can be adjusted by turning the foot.

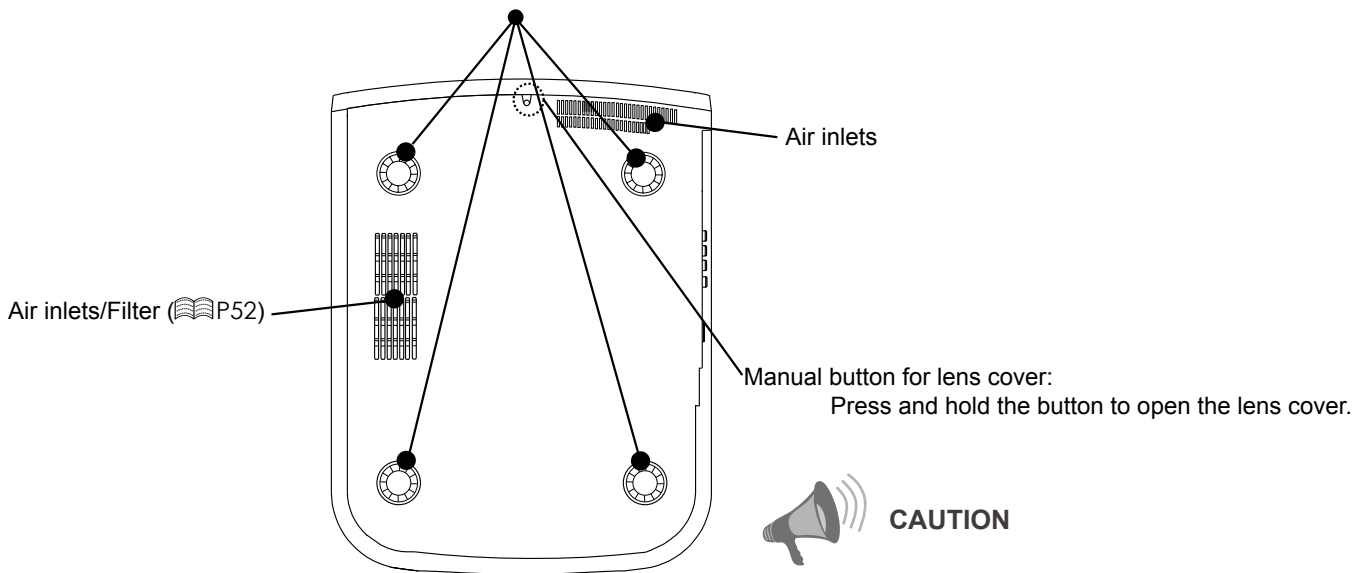

● Do not close lens cover when projecting. Otherwise it will cause malfunction, heat and fire.

# Controls and features (continued)

## ■ Remote Control

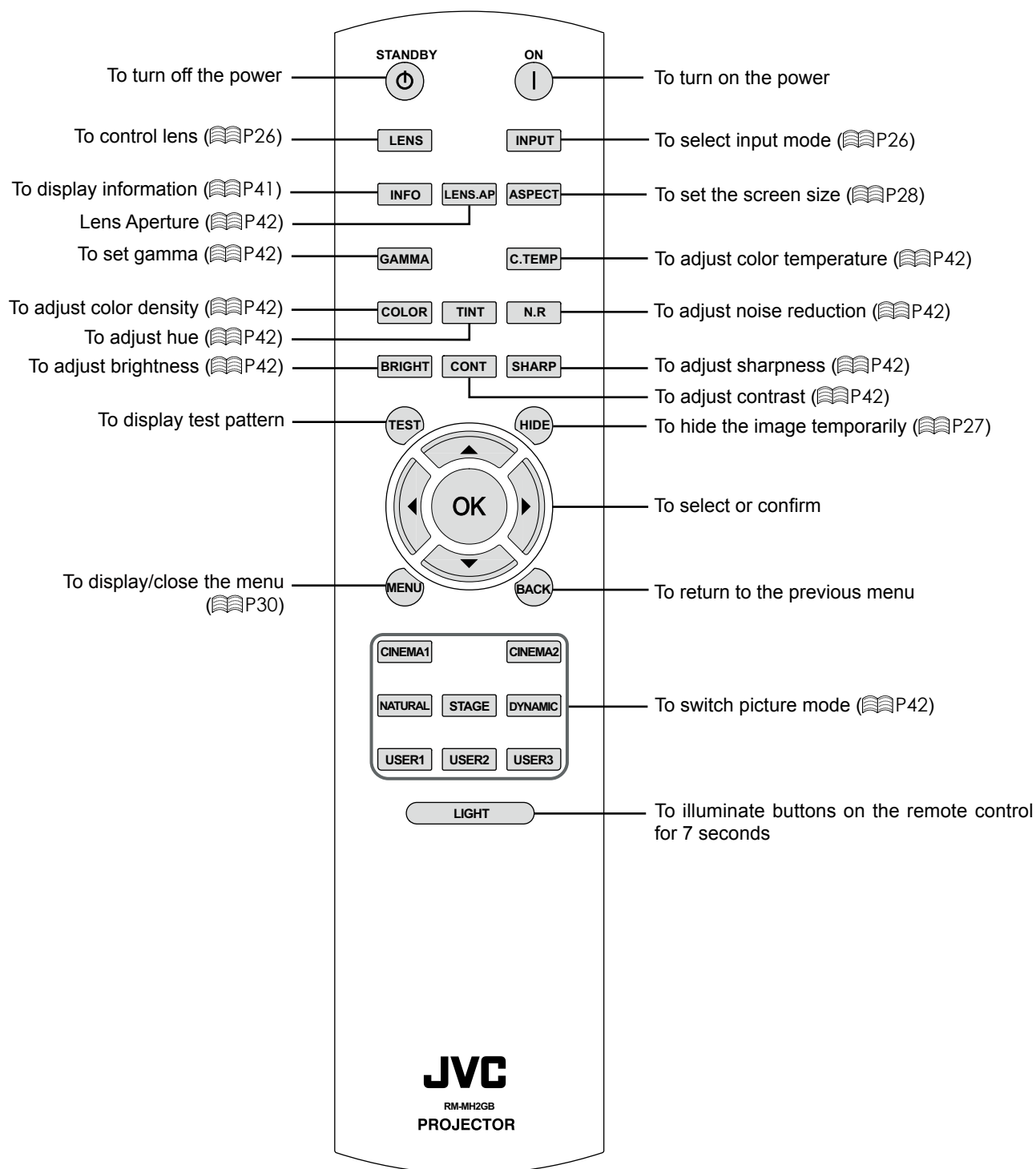



# How to Use the Remote control

## Loading Batteries

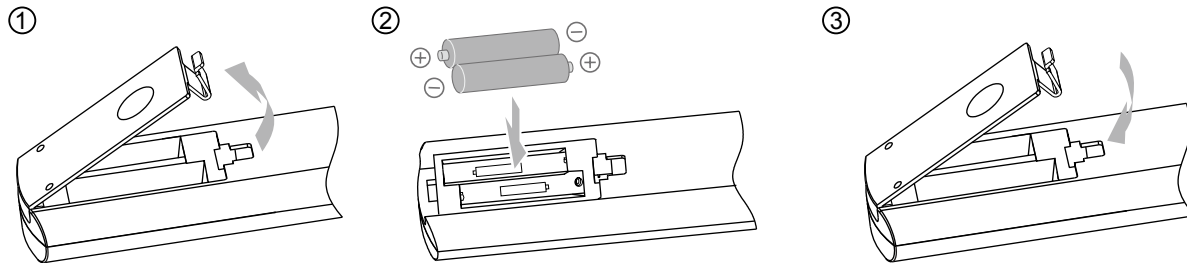

- If the remote control has to be brought closer to the projector to operate, it means that the batteries are wearing out. When this happens, replace the batteries. Insert the batteries according to the  $\oplus$   $\ominus$  marks.
- Be sure to insert the  $\ominus$  end first.
- If an error occurs when using the remote control, remove the batteries and wait for 5 minutes. Load the batteries again and operate the remote control.

## Effective Range of Remote Control Unit

### ■ When directing the remote control toward this unit

- When aiming the remote control towards the remote sensor on this unit, ensure that the distance to the sensor in front or at the rear of this unit is within 7 m.
- If the remote control fails to work properly, move closer to this unit.

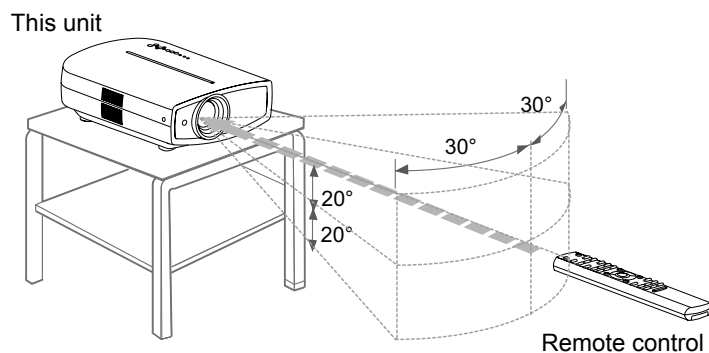

### ■ When reflecting off a screen

- Ensure that the total of distance A between this unit and screen and distance B between remote control and screen is within 7 m.
- As the efficiency of signals reflected from the remote control unit differ with the type of screen used, operable distance may decrease.

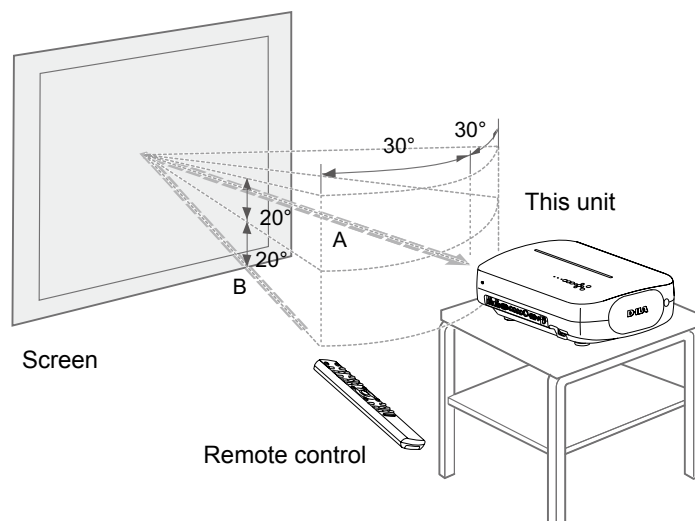

# Selecting Connecting Devices

- Do not turn on the power until connection is complete.
- The connection procedures differ according to the device used. For details, refer to the instruction manual of the device to be connected.
- For audio output, connect the device to an amplifier.
- **The images may not be displayed depending on the devices and cables to be connected.**  
Use an HDMI compliant cable (sold separately) with the HDMI logo.
- It may not be possible to connect to this unit depending on the dimension of the connector cover of the cables to be connected.

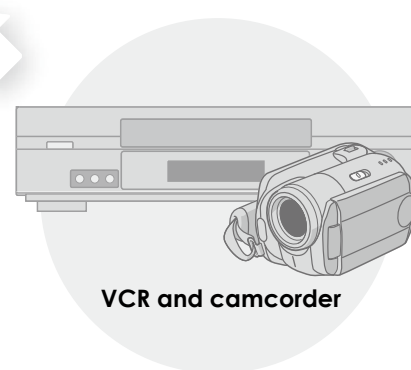
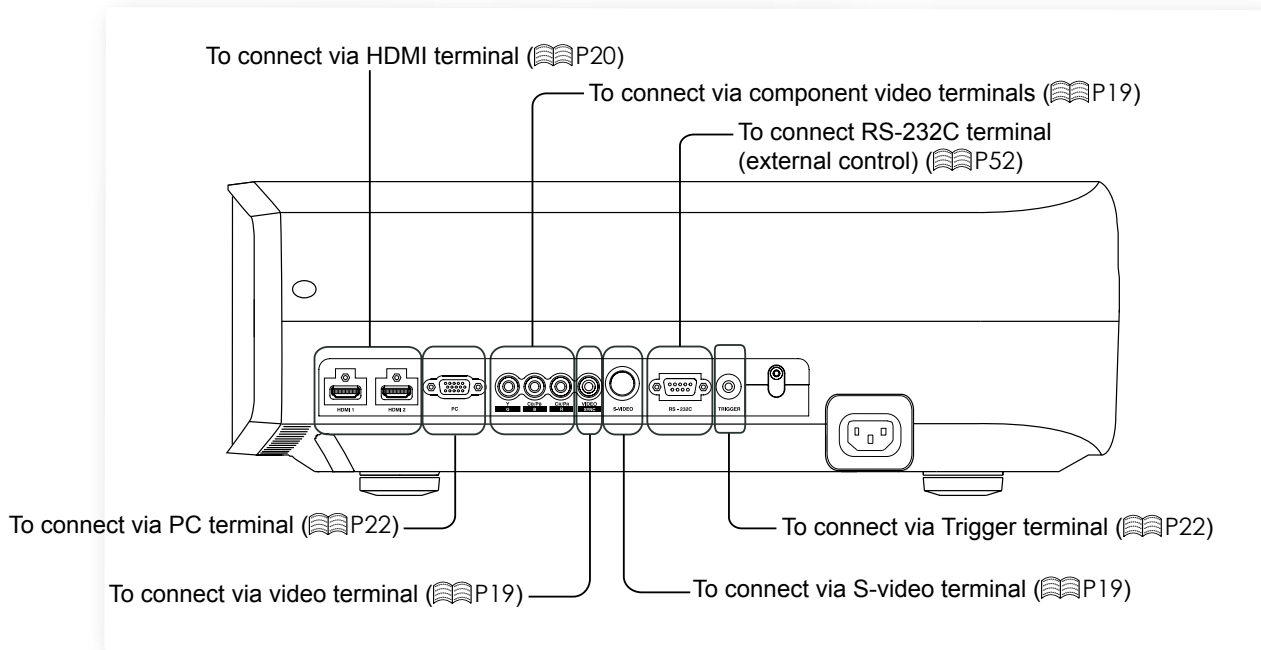

# Connecting

## Connecting via Video Cable and S-Video Cable

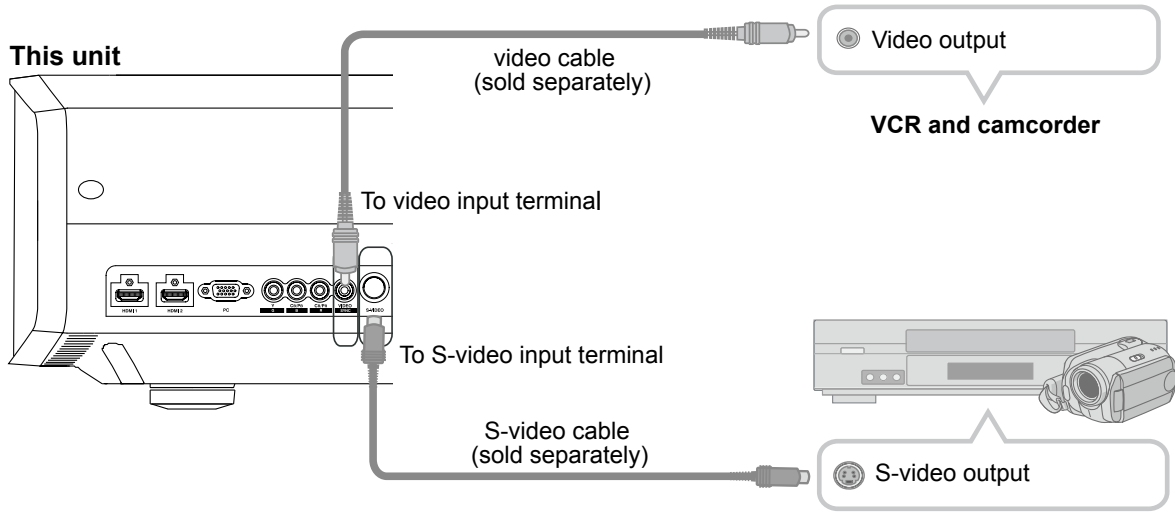

## Connecting via Component Video Cable

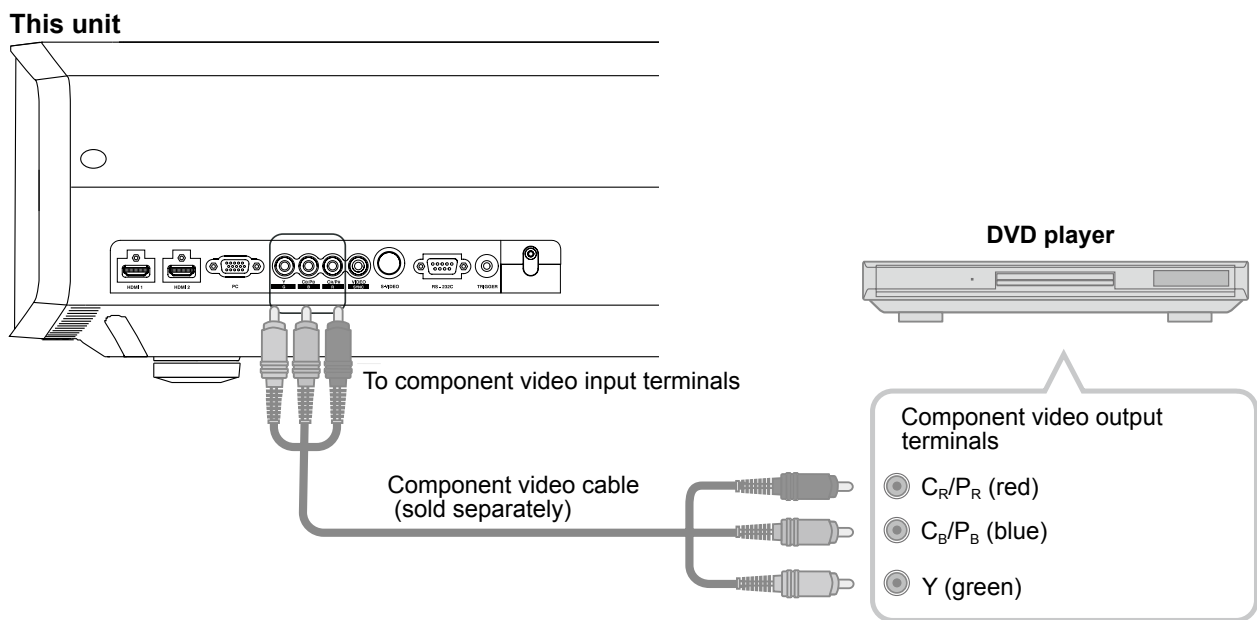

- Set "COMP." in the setting menu to "Y Pb/Cb Pr/Cr". (P35 - 12)

# Connecting(Continued)

## Connecting via HDMI Cable

This unit

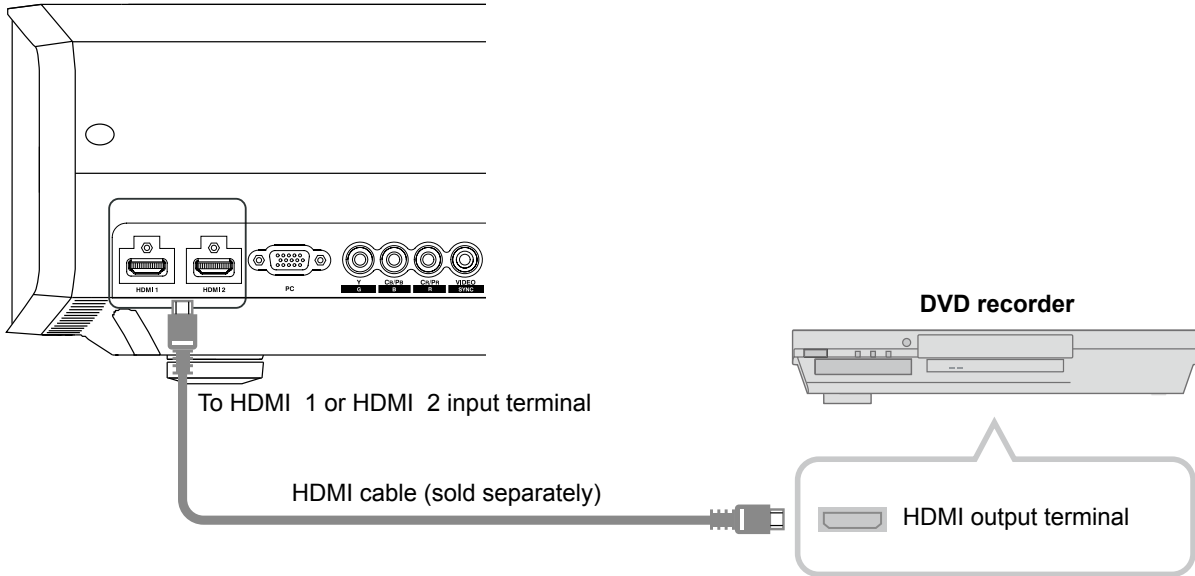

## Connecting via HDMI-DVI Conversion Cable

This unit

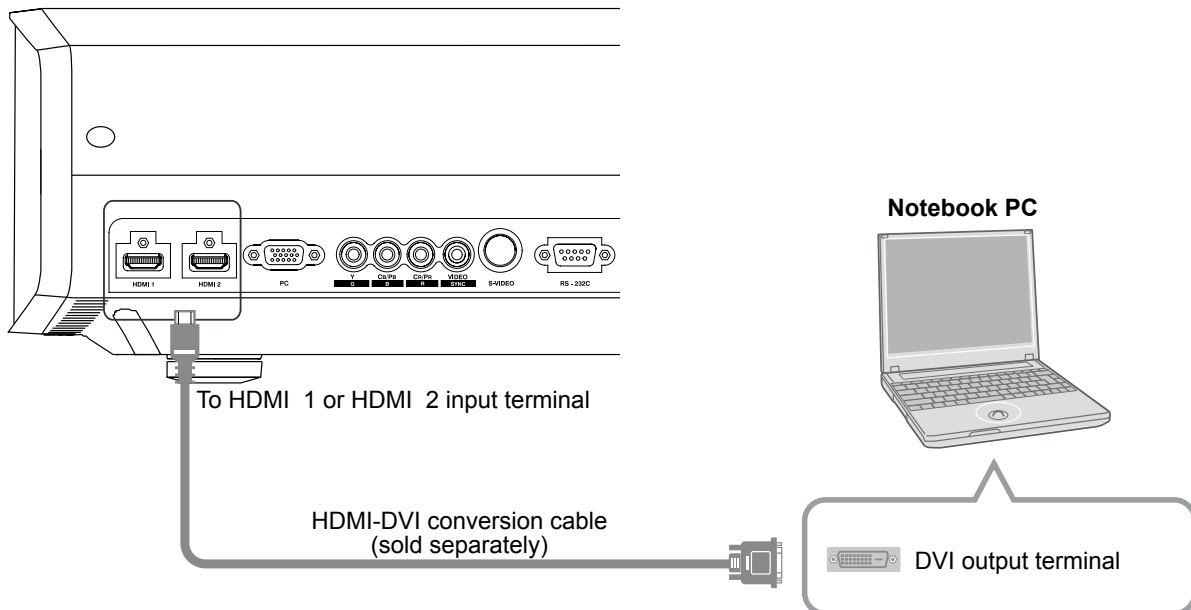

- If noise is produced, take PCs (including notepads) away from this unit.

## Connecting via SCART-RCA Cable

This unit

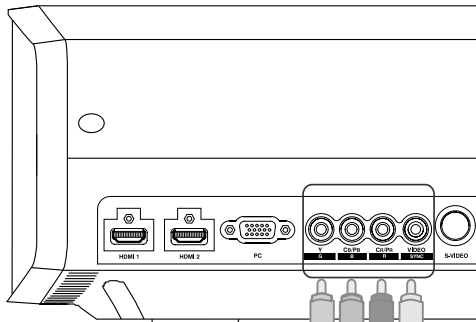

To RGB video and sync signal input terminals

SCART-RCA cable (sold separately)

DVD player for European market



SCART terminal

- Set "COMP." in the setting menu to "SCART". (P35 - 12 )

## Connecting via RGB Video Cable

This unit

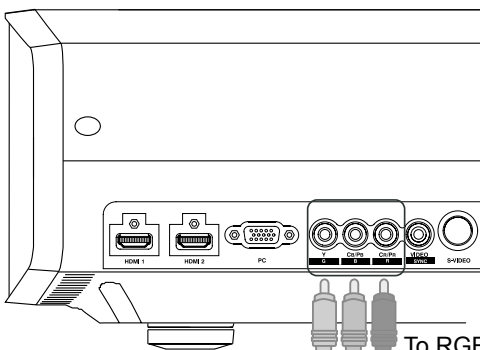

To RGB video input terminals

RGB video cable (sold separately)

Device equipped with RGB output

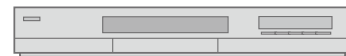

RGB video output terminals

- R(Red)
- B(Blue)
- G(Green) (Includes sync signals)

- Set "COMP." in the setting menu to "RGB". (P35 - 12 )
- For information on compatible input signals, see "Specifications". (P58)

# Connecting(Continued)

## Connecting via PC Cable

This unit

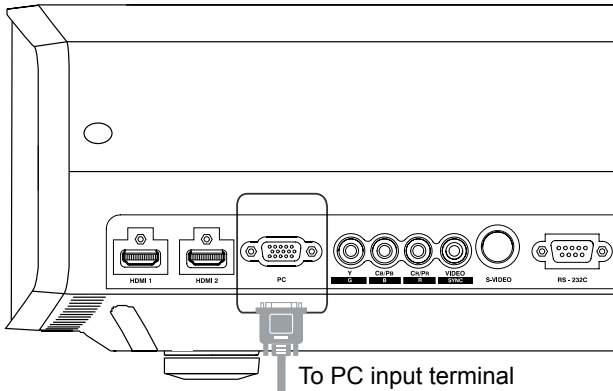

To PC input terminal

PC cable (sold separately)

Notebook PC

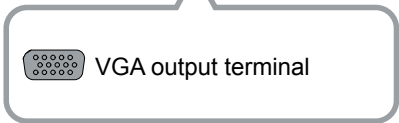

## Connecting via Trigger Cable

This unit

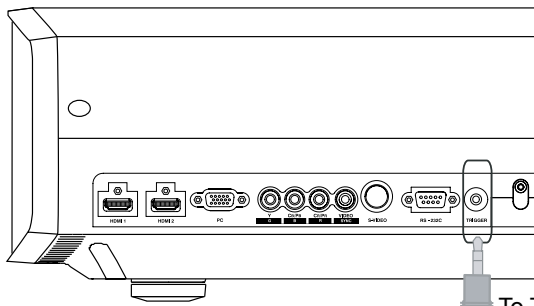

To Trigger output terminal

Trigger cable (sold separately)

Screen

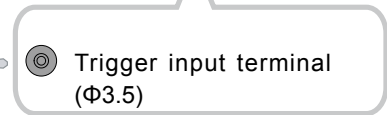
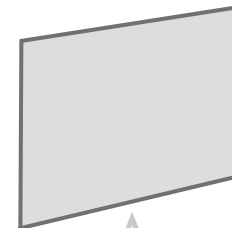

**CAUTION**

- Do not supply the power to the other devices.
- Do not connect audio terminals of the other devices such as headphones etc. Otherwise, this may cause a malfunction of the other devices or injury.
- Using beyond the rated value will cause malfunction.
- Exercise adequate caution to prevent short circuit as the trigger terminal outputs a voltage of 12V.

# Installing the Projector and Screen

While installing, please place this unit and the screen perpendicular to each other. Failing to do so may increase trapezoidal distortion. Please refer to "Keystone". (P38 - 25)

## Set Angle

- The angle range which can be set for this unit is  $\pm 10^\circ$ .

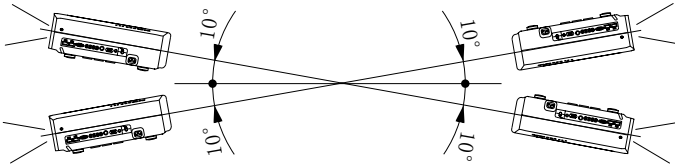

- Malfunctions may occur if the angle is not set within the above-mentioned range.

## Shift Adjustment

### 1 Installing the projector and screen

#### ■ Left/Right position

- \* 0% up/down position (center)

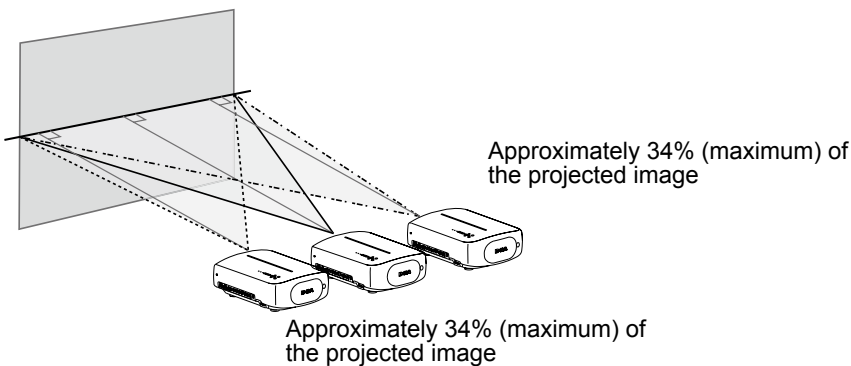

#### ■ Up/Down position

- \* 0% left/right position (center)

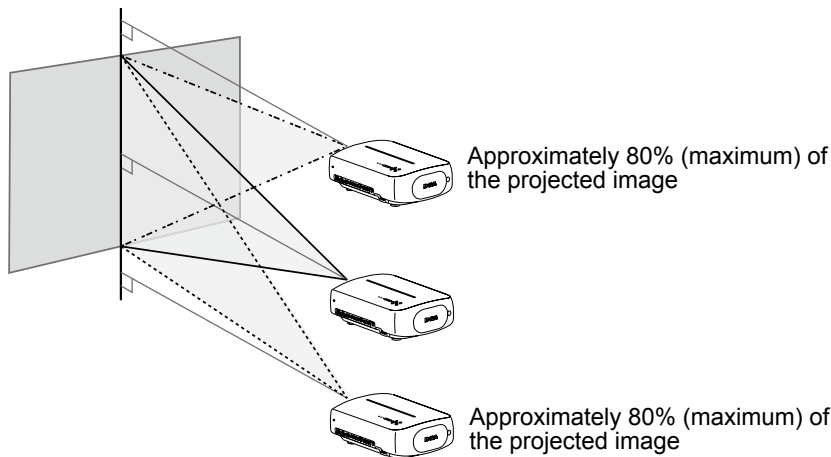

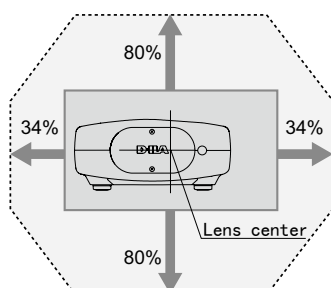

#### ■ Shifting range of projected image

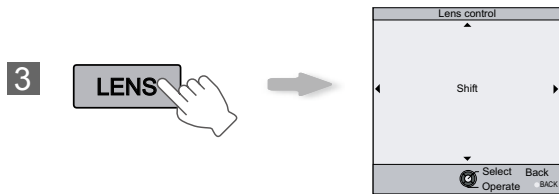
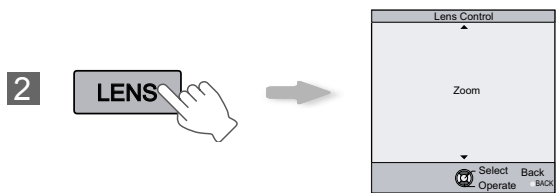
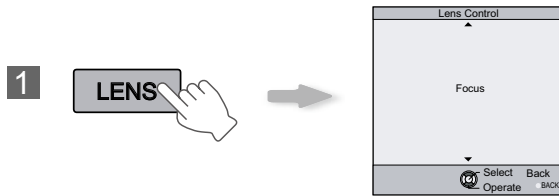

# Installing the Projector and Screen(Continued)

## 2 Adjust such that the projected image is in the center of the screen



4 Adjust the image position to the center of the screen by pressing  (the up, down, left and right buttons).

- It may be necessary to set "Pixel Adjust" in the setting menu after adjusting the image position. (P38 - 23 )



## Screen Size and Projection Distance

Determine the distance from the lens to the screen to achieve your desired screen size. This unit uses a 2.0x power zoom lens for projection.

### ■ Relationship Between Projection Screen Size and Projection Distance

Projection Screen Size (Diagonal Length) Aspect Ratio 16:9	Approximate Projection Distance W (Wide) to T (Tele)	Projection Screen Size (Diagonal Length) Aspect Ratio 16:9	Approximate Projection Distance W (Wide) to T (Tele)
60" (Approx. 1.52m)	Approx. 1.78m to Approx. 3.66m	140" (Approx. 3.56m)	Approx. 4.23m to Approx. 8.60m
70" (Approx. 1.78m)	Approx. 2.09m to Approx. 4.28m	150" (Approx. 3.81m)	Approx. 4.53m to Approx. 9.22m
80" (Approx. 2.03m)	Approx. 2.40m to Approx. 4.89m	160" (Approx. 4.06m)	Approx. 4.84m to Approx. 9.84m
90" (Approx. 2.29m)	Approx. 2.70m to Approx. 5.51m	170" (Approx. 4.32m)	Approx. 5.14m to Approx. 10.45m
100" (Approx. 2.54m)	Approx. 3.01m to Approx. 6.13m	180" (Approx. 4.57m)	Approx. 5.45m to Approx. 11.07m
110" (Approx. 2.79m)	Approx. 3.31m to Approx. 6.75m	190" (Approx. 4.83m)	Approx. 5.75m to Approx. 11.68m
120" (Approx. 3.05m)	Approx. 3.62m to Approx. 7.36m	200" (Approx. 5.08m)	Approx. 6.06m to Approx. 12.30m
130" (Approx. 3.30m)	Approx. 3.92m to Approx. 7.98m		

- The projection distances in the table are provided only as a guide. Use them as a reference during installation.
- To adjust the installation, use a projected image of aspect ratio 16:9.

# Projecting Image

This section describes the basic operations to project input images on the screen.

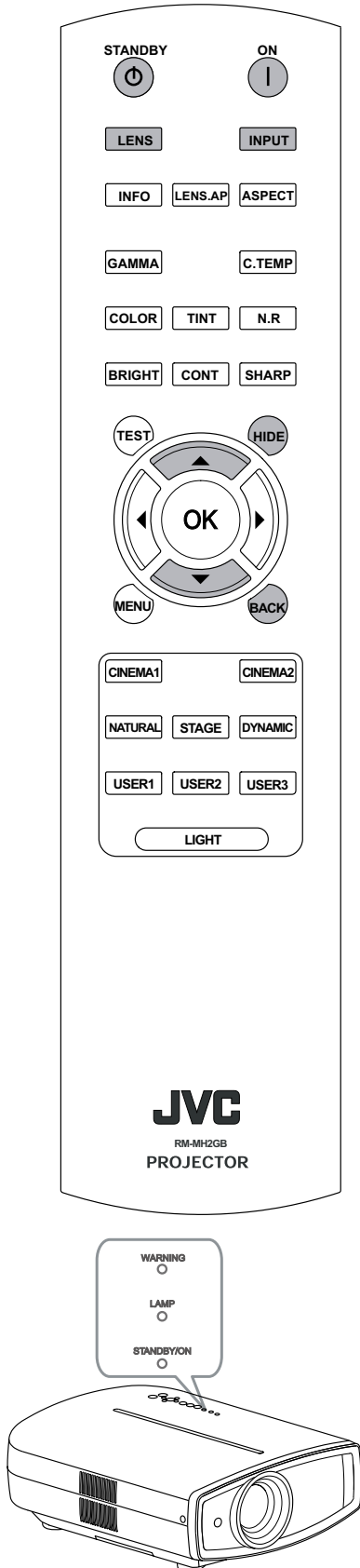

## Preparation

### 1 Insert the power plug to the power outlet

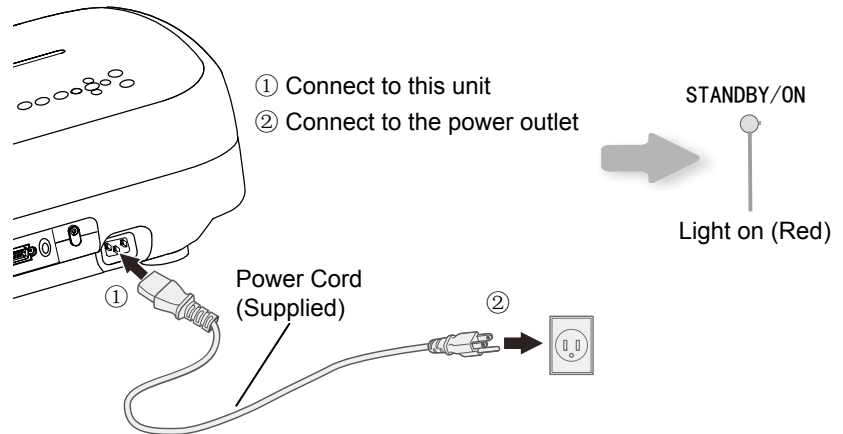

### 2 Turn on the power



- You can also press the button on the unit to turn on the power. (P15)
- The lens cover will be opened.

### 3 Project the image

#### 1 Select input mode

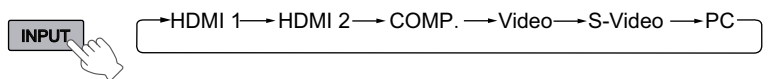

- You can also select the input mode by pressing the button on the unit. (P15)

#### 2 Play back the selected device

### 4 Adjust the position of the projection screen

- See "Installing the Projector and Screen" (P23) and "Lens Control" (P38 - 22) for the adjustment method.

### 5 Adjust the image size (zoom) and the focus

#### 1 Adjust the focus

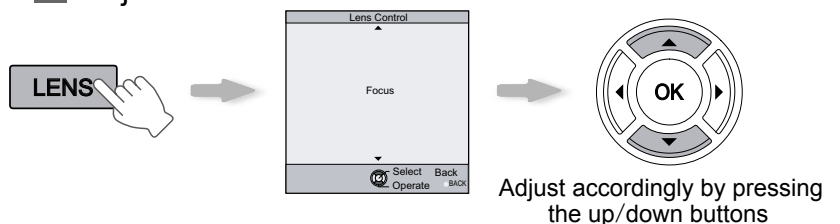

## 2 Adjust the image size (zoom)

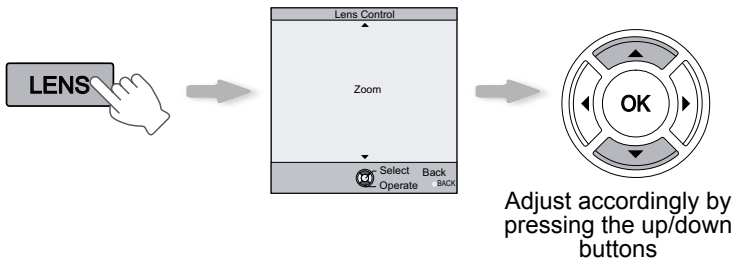

- Every time the **LENS** button is pressed, the adjustment item will be switched among "Focus", "Zoom" and "Shift".

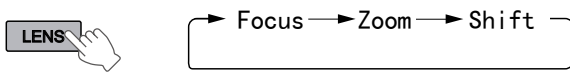

## 3 To end



## 6 Turn off the power

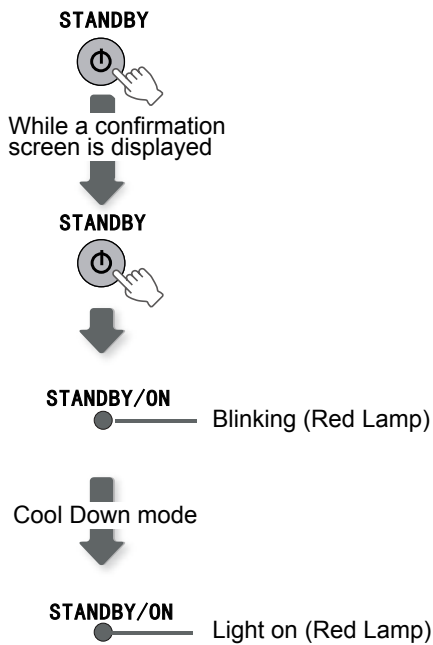

- When power off, the lens cover will be closed.
- The power cannot be turned off within approximately 90 seconds after it has been turned on. Start operation only after 90 seconds time.
- You can also press the button on the unit to turn off the power. (P15)
- Pull out the power plug when the unit will not be used for a prolonged time.



### TIPS

#### You can hide the image temporarily

You can hide the image temporarily.



**STANDBY/ON**

Green light blinks when the image is hidden.

- Press the **HIDE** button again to display image.
- The power cannot be turned off when the image is temporarily hidden.



### MEMO

#### About Cool Down mode

- The Cool Down mode is a function to cool down the lamp for approximately 60 seconds after projection is complete. This function prevents the internal parts of the unit from deformation or damage due to overheating of the lamp. It also prevents lamp blowout and premature shortening of lamp life.
- During Cool Down mode, the [STANDBY/ON] indicator blinks in red.
- After the Cool Down mode is complete, the unit automatically returns to standby mode.
- Do not pull out the power plug during Cool Down mode. This may shorten the lamp life and cause a malfunction.

# Convenient Features during Projection

You can change the screen size of the projected image or hide the surrounding area of an image for which quality at the outer area has deteriorated.

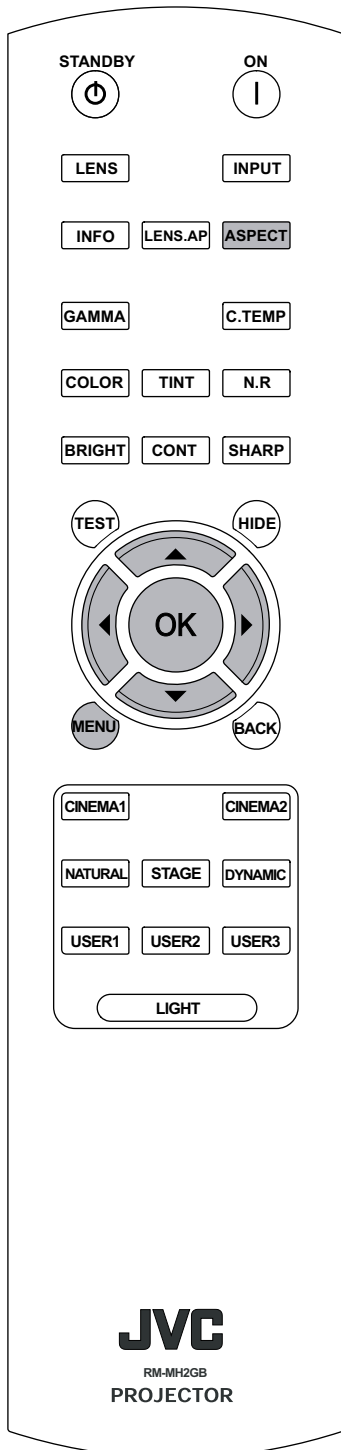

## Setting the Screen Size

The projected image can be set to a most appropriate screen size (aspect ratio).

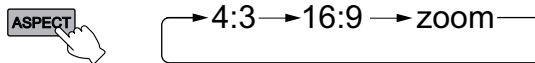

- The screen size can also be set from “Aspect(Video)” of the setting menu. (P36 - 16)
- When PC signals are input, the “Aspect(Computer)” setting will be available instead. (P37 - 17)

### Input Image and Projected Image by Different Screen Size Settings

Input Image	Screen Size		
	4:3	16:9	Zoom
SDTV(4:3)	Aspect Ratio: Same Most appropriate screen size	Aspect Ratio: Landscape Image is stretched horizontally	Aspect Ratio: Same Top and bottom of the image are missing
SDTV(4:3) Image recorded in landscape (black bands on top and bottom) of DVD software	Aspect Ratio: Same Small image is projected	Aspect Ratio: Landscape Image is stretched horizontally	Aspect Ratio: Same Most appropriate screen size

- Depending on the input image, selecting “4:3” may result in a vertically stretched image, while selecting “16:9” provides you with the most appropriate screen size.

## Masking the Surrounding Area of an Image

Images for which quality at the outer area has deteriorated can be projected by masking (hiding) the surrounding area of the projected image.

### 1 Project the image



← Image for which quality at the outer area has deteriorated.

## 2 Mask the image

1 Display the setting menu

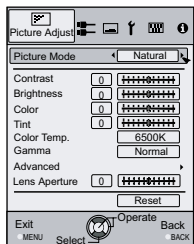

2 Select "Input Signal" → "Mask"

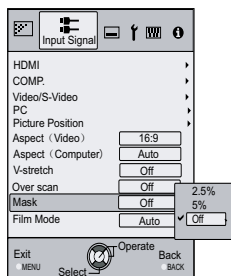
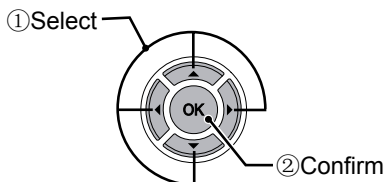

3 Set a mask value

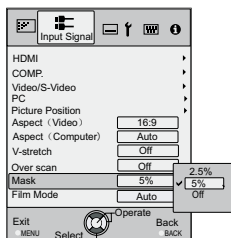
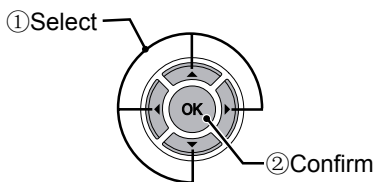

Example:

When the "Mask" value is changed from "Off" → "5%"



3 To end



### MEMO

- Masking is available only when high definition images are input.

# Setting Menu

Projected images can be adjusted to a desired view by changing the initial settings.

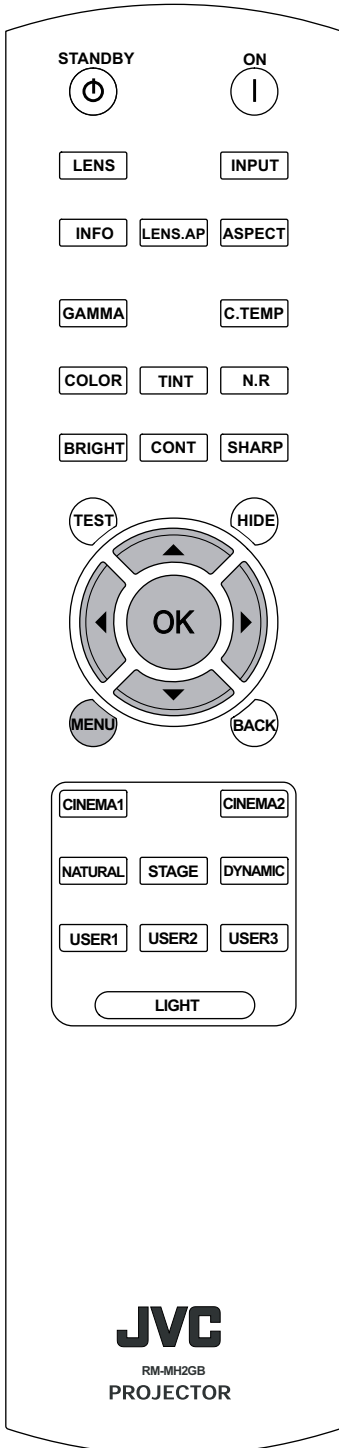

## Procedures for Menu Operation

Example:

When changing "Aspect(Video)" from "4:3" to "16:9"

### 1 Display the setting menu

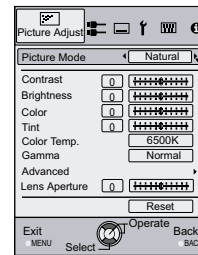

### 2 Select "Input Signal" → "Aspect(Video)"

① Select

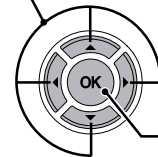

② Confirm

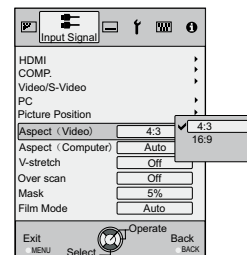

### 3 Set to "16:9"

① Select

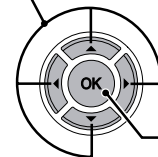

② Confirm

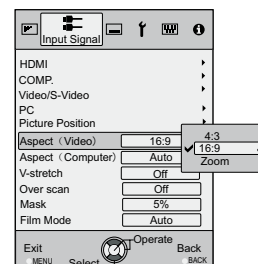

### 4 To end



## Setting Menu

Item values shown in  are factory settings.

- Items that can be configured differ according to the input signals.

Picture Adjust	
<b>01</b>	<b>Picture Mode</b>
Adjusts the pattern of the projected image.	
<input type="text"/>	Cinema 1, Cinema 2, Natural, Stage, Dynamic, User 1, User 2, User 3 and THX.
<b>02</b>	<b>Contrast</b>
Adjusts the contrast of the projected image.	
<input type="text"/>	(Black) -50 to 50 (White)
<b>03</b>	<b>Brightness</b>
Adjusts the brightness of the projected image.	
<input type="text"/>	(Darken) -50 to 50 (Brighten)
<b>04</b>	<b>Color</b>
Adjusts the color density of the projected image.	
<input type="text"/>	(Lighten) -50 to 50 (Darken)
<b>05</b>	<b>Tint</b>
Adjusts the hue of the projected image.	
<input type="text"/>	(Red) -50 to 50 (Green)

- “Contrast”, “Brightness”, “Color” and “Tint” can also be configured from the remote control. (📖P16)

# Setting Menu (Continued)

Picture Adjust > Color Temp.			
06 Color Temp.			
Sets the color temperature of the projected image.			
<b>5800K</b>	Select this to give a reddish tinge to the image.		Only offset can be set.
<b>6500K</b>	Select this to have a balanced image.		
<b>7500K</b>	Select this to give a bluish tinge to the image.		
<b>9300K</b>	Select this to give a greater bluish tinge than 7500K.		
<b>High Bright</b>	Select this to get the brightest image.		
<b>Custom 1</b>	<b>Gain</b> (Bright part)	<b>Red</b>	(Less red) -255 to 0 (More red)
		<b>Green</b>	(Less green) -255 to 0 (More green)
		<b>Blue</b>	(Less blue) -255 to 0 (More blue)
	<b>Offset</b> (Dark part)	<b>Red</b>	(Less red) -50 to 50 (More red)
		<b>Green</b>	(Less green) -50 to 50 (More green)
		<b>Blue</b>	(Less blue) -50 to 50 (More blue)
<b>Custom 2</b>	<b>Gain</b> (Bright part)	<b>Red</b>	(Less red) -255 to 0 (More red)
		<b>Green</b>	(Less green) -255 to 0 (More green)
		<b>Blue</b>	(Less blue) -255 to 0 (More blue)
	<b>Offset</b> (Dark part)	<b>Red</b>	(Less red) -50 to 50 (More red)
		<b>Green</b>	(Less green) -50 to 50 (More green)
		<b>Blue</b>	(Less blue) -50 to 50 (More blue)
<b>Custom 3</b>	<b>Gain</b> (Bright part)	<b>Red</b>	(Less red) -255 to 0 (More red)
		<b>Green</b>	(Less green) -255 to 0 (More green)
		<b>Blue</b>	(Less blue) -255 to 0 (More blue)
	<b>Offset</b> (Dark part)	<b>Red</b>	(Less red) -50 to 50 (More red)
		<b>Green</b>	(Less green) -50 to 50 (More green)
		<b>Blue</b>	(Less blue) -50 to 50 (More blue)

- The red, green and blue colors can be adjusted and registered respectively.
- This setting can also be configured from the remote control. (📖P16)
- Cannot set when the "Picture Mode" in "THX".



**Picture Adjust > Gamma**

**07 Gamma**

Sets the gradation characteristics of the projected image.

<b>Normal</b>	For normal circumstances, select this setting.		Gamma adjustment cannot be performed, and only copy is valid.	
	<b>A</b>	Set gamma to "A".		
	<b>B</b>	Set gamma to "B".		
	<b>C</b>	Set gamma to "C".		
	<b>Custom 1 Custom 2 Custom 3 (Gamma Setup)</b>	Three different kinds of gamma can be set according to your preferences.		
		<b>Correction Value</b>		The coefficient (1.8 to 2.6) of the gamma curve can be selected.
<b>Gamma Adjustment*</b>		The gamma curve for the colors (Red, Green, Blue) can be adjusted separately. Adjusting "White" will adjust for all "Red, Green, Blue" values. The gamma curve displays the value for "Green".		
<b>Copy</b>		Copy the adjusted gamma data.		
<b>Paste</b>		Paste the copied gamma data.		
<b>Reset</b>		Return the gamma coefficients to the values 2.2 set by "Correction Value".		

- "Normal" is suitable for normal circumstances but other settings can be selected according to your preferences.
- This setting can also be configured from the remote control. (📖P16)
- Cannot set when the "Picture Mode" in "THX".
- \* "Gamma Adjustment"
  - ① Select the reference gamma curve coefficient (1.8 ~ 2.6) in "Correction Value".
  - ② Select the color to be adjusted in the gamma adjustment screen.

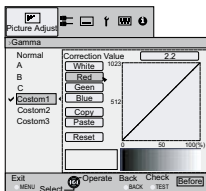

- ③ Adjust the gamma curve in the gamma curve adjustment screen.

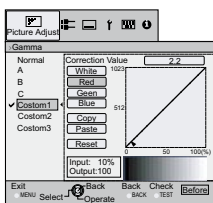

Select the point where the gradation (brightness) is to be adjusted with the ◀ / ▶ buttons.

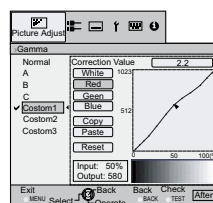

Adjust the gradation (brightness) with the ▲ / ▼ buttons.

- You can switch between "Before" and "After" using the [TEST] button of the remote control.

- ④ To end



- If gamma curve is adjusted repeatedly, calculation errors will be accumulated and the gamma curve may not be able to revert back to its original form. In that case, select "Reset".

# Setting Menu (Continued)

Picture Adjust			
<b>08 Advanced</b>			
Adjusts the contours of the image, detailed composition of the image and image color. (Cannot set when the "Picture Mode" in "THX".)			
Sharpness	Sharpness	(Soft) 0 to 100 (Sharp)	Adjusts the outline of image.
	Detail Enhancement	(Soft) -50 to 50 (Strong)	Emphasizes the details of image.
NR*	RNR	(Soft) 0 to 16 (Strong)	Adjusts the intensity of removing image noise.
	MNR	(Soft) 0 to 16 (Strong)	Adjusts the intensity of removing mosquito noise.
	BNR	On	Reduces block noise.
Off		Input signal remains unchanged.	
CTI*	Off	Input signal remains unchanged.	
	Low	Reduces color smear.	
	Middle		
	High		
* In case of HD signals or PC signals, NR and CTI cannot be set.			
● Abbreviations NR: Noise Reduction    RNR: Random Noise Reduction    MNR: Mosquito Noise Reduction BNR: Block Noise Reduction    CTI: Color Transient Improvement			
Color Management	Off	The image color cannot be adjusted.	
	Custom 1 Custom 2 Custom 3	Pause	Off    Video mode On    Still mode
		Color Management Adjustment*	Values of each color can be adjusted ("Red, Yellow, Green, Cyan, Blue and Magenta").
	All Reset	Return to the factory settings.	
<b>09 Lens Aperture</b>			
(Dark) -15 to 0 (Bright)			
<b>10 Reset</b>			
Reset the setting.			

\* About "Color Management Adjustment"

- ① Set the picture mode of the color management.
- ② Select the color to be adjusted by color management.

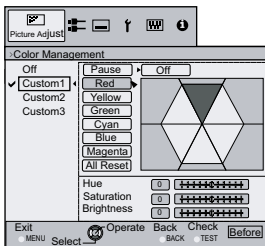

- ③ Select color adjustment.

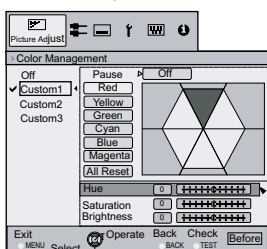

- ④ Select the "Hue", "Saturation" or "Brightness" using the ▲ / ▼ button.
- ⑤ Use the ◀ / ▶ button to adjust.

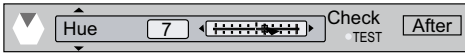

- You can switch between "Before" and "After" using the [TEST] button of the remote control.

- ⑥ To end

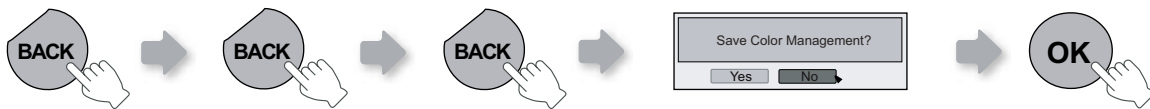

**Input Signal > HDMI**

**11 HDMI**

Configures HDMI input signal.

<b>Input</b>	<b>Auto</b>	Automatically configures the input signals.
	<b>Standard</b>	Select this when the dynamic range of the input images is 16-235.
	<b>Enhanced</b>	Select this when the dynamic range of the input images is 0-255.
<b>Color Space</b>	<b>Auto</b>	Automatically configures the input signals.
	<b>YCbCr(4:4:4)</b>	Select this when the Y Cb Cr(4:4:4) video signals are input.
	<b>YCbCr(4:2:2)</b>	Select this when the Y Cb Cr(4:2:2) video signals are input.
	<b>RGB</b>	Select this when the RGB video signals are input.
<b>Control with HDMI</b>	<b>On</b>	Enables CEC communications.
	<b>Off</b>	Disables CEC communications.

- The setting is available only if the HDMI terminal is selected.
- Abbreviation  
CEC: Consumer Electronics Control

**Input Signal > COMP.**

**12 COMP.**

Configures the input signal for the component video input terminals.

<b>Color Space</b>	<b>Y Pb/Cb Pr/Cr</b>	Select this when the component video signals are input.
	<b>RGB</b>	Select this when the RGB video signals are input.
	<b>SCART</b>	Select this when RGB video signals and sync signals are input via the SCART interface for European markets.

- The setting is available only if the component video terminals are selected.

# Setting Menu (Continued)

Input Signal > Video/S-Video		
<b>13 Video/S-Video</b>		
Configures the Video/S-Video input signals.		
NTSC Setup Level	0IRE	Adjusts the gradation for signals without the 7.5 IRE setup.
	7.5IRE	Adjusts the gradation for signals with the 7.5 IRE setup.
<ul style="list-style-type: none"> <li>Adjust this only when NTSC signals are input via Video or S-Video terminal.</li> </ul>		
Color System	Auto	Configures the color system automatically.
	NTSC	Select this when the color system is NTSC.
	NTSC4.43	Select this when the color system is NTSC4.43.
	PAL	Select this when the color system is PAL.
	PAL-M	Select this when the color system is PAL-M.
	PAL-N	Select this when the color system is PAL-N.
	SECAM	Select this when the color system is SECAM.

- The setting is available only when the Video or S-Video input image is projected.

Input Signal > PC	
<b>14 PC</b>	
Configures PC input.	
Auto Alignment	Automatically adjusts "Tracking", "Phase" and "Picture Position".
Tracking	Adjust the horizontal size and display area of the image. (This may vary depending on the signal, but does not usually require adjustment.)
Phase	Adjust flickering and blurred images. (This may vary depending on the signal, but does not usually require adjustment.)
Picture Position	Adjust the display position of the image.

- This can be set only when selecting PC input terminal.

Input Signal > Picture Position	
<b>15 Picture Position</b>	
Adjusts the horizontal/vertical position of the projected image.	

- The position of the image varies depending on the input signals. The image of some signals may not be fully displayed. Adjust the position of image using this menu to display the image properly.

Input Signal > Aspect (Video)	
<b>16 Aspect (Video)</b>	
Configures the screen size of the projected image.	
4:3	Sets the screen size of the projected image as 4:3.
16:9	Sets the screen size of the projected image as 16:9.
Zoom	Zooms the images. (This item cannot be selected in the case of HD signals.)

- This setting can also be configured from the remote control. (📖P16)
- The items cannot be set in the case of PC signals.

**Input Signal > Aspect (Computer)**

**17 Aspect (Computer)**

Configures the screen size of the projected image.

<b>Auto</b>	Enlarges the PC signal horizontally/vertically until it fits the panel height, and displays it in the original aspect ratio.
<b>1:1</b>	Displays the PC signal corresponding to the panel at one dot per pixel ratio. The PC screen can be shown in the original size.
<b>Full</b>	Enlarges the PC signal horizontally/vertically.

- This setting can also be configured from the remote control. (📖P16)
- This setting cannot be set in the case of SD or HD signals.

**Input Signal > V-Stretch (when HD or SD video signals are input)**

**18 V-Stretch**

When set to "On", the projected 2.35:1 image will be stretched vertically to the panel resolution.

<b>On</b>	The projected 2.35:1 image will be stretched vertically to the panel resolution.
<b>Off</b>	Projects the 2.35:1 image as-is. (Black bands will be displayed on the top and bottom.)

- This setting cannot be set in the case of PC signals.

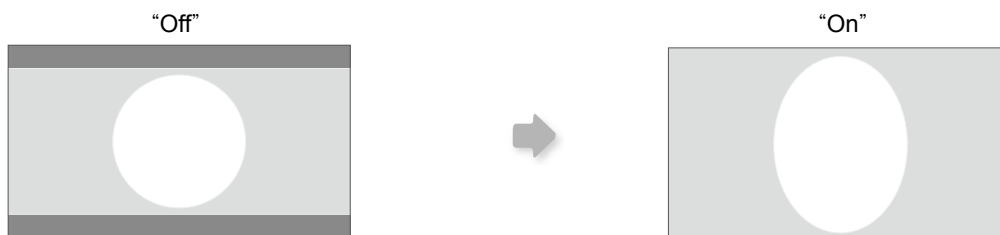

**Input Signal > Over Scan**

**19 Over Scan**

Selects whether or not to set over scan for the SD video signal.

<b>On</b>	Over scan the top, left, bottom and right at 2.5% each.
<b>Off</b>	Do not over scan.

- This setting is not available when HD signal or PC signal is input.

**Input Signal > Mask**

**20 Mask**

Masks (Hides) the outer area of the projected image.

<b>2.5%</b>	Mask 2.5% of the screen.
<b>5%</b>	Mask 5% of the screen.
<b>Off</b>	No masking.

- Masking is available only when high definition images are input.

**Input Signal > Film Mode**

**21 Film Mode**

Selects this to view movies shot on film.

<b>Auto</b>	For normal circumstances, select this setting.
<b>Off</b>	Select this when you are not watching movies shot on film.

- This setting is not available when a progressive signal is input.

# Setting Menu (Continued)

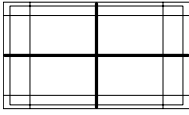
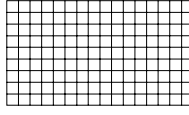
Installation > Lens Control	
<b>22 Lens Control</b>	
Controls the individual motorized function of the lens when setting up the projector	
<b>Focus</b>	Function for adjusting the lens focus.
<b>Zoom</b>	Function for adjusting the lens zoom.
<b>Shift</b>	Function for adjusting lens shift. (Press the up/down/left/right button to shift the screen).
<b>Image Pattern</b>	
<b>On</b>	Displays the image pattern in conjunction with the above setting items. Display for "Zoom" and "Shift":  Display for "Focus":  (Picture of big green grids) (Picture of small green grids)
<b>Off</b>	Do not display the image pattern.
<b>Lock</b>	
<b>On</b>	Disables lens adjustment. A warning message appears when the [LENS] button on the remote control is pressed.
<b>Off</b>	Enables lens adjustment.

Installation > Pixel Adjust	
<b>23 Pixel Adjust</b>	
Makes fine adjustments of 1 pixel unit for each minor color shift in the horizontal/vertical direction of the image.	
<b>Horiz. Red</b>	(Move red to left) 1 to 7 (Move red to right)
<b>Horiz. Green</b>	(Move green to left) 1 to 7 (Move green to right)
<b>Horiz. Blue</b>	(Move blue to left) 1 to 7 (Move blue to right)
<b>Vert. Red</b>	(Move red down) 1 to 5 (Move red up)
<b>Vert. Green</b>	(Move green down) 1 to 5 (Moves green up)
<b>Vert. Blue</b>	(Move blue down) 1 to 5 (Move blue up)

- The horizontal and vertical directions are reversed when the image is flipped to the left or right, or flipped up or down.
- To adjust, use still images with distinct outlines.
- As the adjustments are minor, the effect may be difficult to see for some images.

Installation > Installation Style	
<b>24 Installation Style</b>	
Flips the image to the left or right, up or down according to the projection state of the projector.	
<b>Front</b>	Select this for tabletop front projection.
<b>Ceiling Mount (F)</b>	Select this for ceiling front projection.
<b>Rear</b>	Select this for tabletop rear projection.
<b>Ceiling Mount (R)</b>	Select this for ceiling rear projection.

Installation > Keystone	
<b>25 Keystone</b>	
Compensates for trapezoidal distortion caused by installation.	

- Refer to "Installing the Projector and Screen". (P23)

**Display Setup > Back Color**

**26 Back Color**

Configures the screen color displayed when there is no input signal.

<b>Blue</b>	Sets screen color to "Blue" .
<b>Black</b>	Sets screen color to "Black" .

**Display Setup > Menu Position**

**27 Menu Position**

Sets the display position of the menu. The possible positions for displaying the menu are at the four corners or at center of the screen.

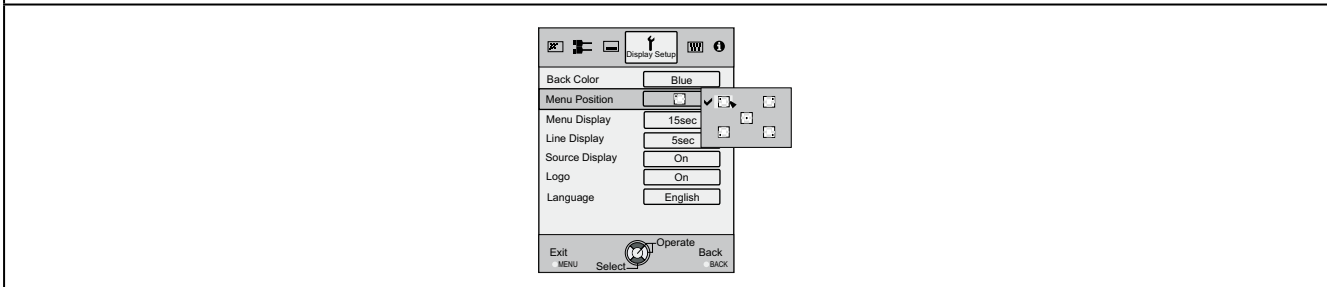

**Display Setup > Menu Display**

**28 Menu Display**

Sets the duration for displaying the menu.

<b>15 sec</b>	Display for 15 seconds.
<b>On</b>	Always display.

**Display Setup > Line Display**

**29 Line Display**

Sets whether to display the input setting when switching the input.

<b>5 sec</b>	Display for 5 seconds.
<b>Off</b>	Do not display.

**Display Setup > Source Display**

**30 Source Display**

Sets whether to display the source of input signals when changing the input.

<b>On</b>	Display the source of input signals.
<b>Off</b>	Do not display.

**Display Setup > Logo**

**31 Logo**

Sets whether to display "Logo" during startup.

<b>On</b>	Display for 5 seconds.
<b>Off</b>	Do not display.

# Setting Menu (Continued)

Display Setup > Language	
<b>32 Language</b>	
Sets the language of the menu display.	
日本語	Japanese
English	English
Deutsch	German
Español	Spanish
Italiano	Italian
Français	French
Português	Portuguese
Nederlands	Dutch
Svenska	Swedish
Norsk	Norwegian
Русский	Russian
中文	Chinese

Function > Lamp Power	
<b>33 Lamp Power</b>	
Configures the output of the light-source lamp.	
Normal	For normal circumstances, select this setting. (150W)
High	Select this when it is difficult to see the image in a bright room. (200W)

- The setting cannot be changed within approximately 90 seconds after this unit has been turned on.
- Settings cannot be changed within approximately 60 seconds after they are made.

Function > Trigger	
<b>34 Trigger</b>	
Configures the output of Trigger terminal.	
Off	Do not activate.
On(Power)	Move the screen UP/DOWN in conjunction with the power.
On(V-Stretch)	Operate the anamorphic lens in conjunction with the "V-Stretch".

Function > Test Pattern	
<b>35 Test Pattern</b>	
Display 6 types of test patterns.	

- This can also be displayed by the remote control. (📖P16)



**Function > Off Timer****36 Off Timer**

Automatically powers off when there is no operation for a certain duration.

<b>Off</b>	Disables the off timer.
<b>1 hour</b>	Auto power off after 1 hour.
<b>2 hours</b>	Auto power off after 2 hours.
<b>3 hours</b>	Auto power off after 3 hours.
<b>4 hours</b>	Auto power off after 4 hours.

**Function > High Altitude Mode****37 High Altitude Mode**

Selects this when using the projector in a location of low atmospheric pressure (higher than 900 meters above sea level).

<b>On</b>	Enable.
<b>Off</b>	Disable.

**Information**

<b>Input</b>	Displays the currently selected video input.
<b>Source</b>	Displays the type of the current video input signal. (If PC signal is input, this item cannot be displayed)
<b>Resolution</b>	In the case of PC signal, the resolution is displayed.
<b>H Frequency</b>	In the case of PC signal, the horizontal frequency is displayed.
<b>V Frequency</b>	In the case of PC signal, the vertical frequency is displayed.
<b>Deep Color</b>	Displays the bit depth (color depth) of the video signals input from the HDMI terminals. [Deep Color is not displayed when Y Cb Cr (4:2:2) is input.]
<b>Lamp Time</b>	Displays the accumulated hours of usage of the light-source lamp.

# Customizing Projected Images

You can adjust the projected image to a desired image quality and register the adjusted value. (Picture Mode) Besides the five default “Cinema 1”, “Cinema 2”, “Natural”, “Stage”, “Dynamic” and “THX” settings, there are 3 more types of user-defined settings for Picture Mode.

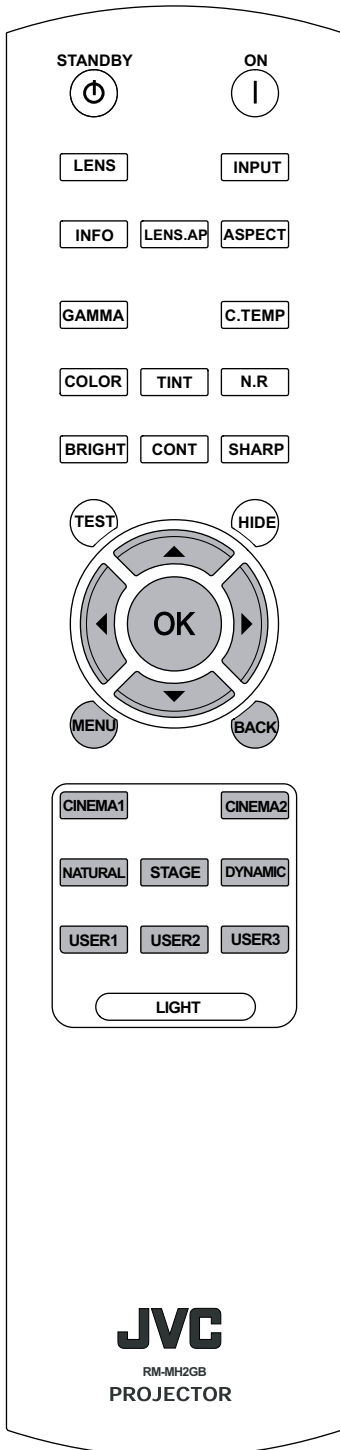

## Changing the Initial Setting of Picture Mode

“Contrast”, “Brightness”, “Color”, “Tint”, “Color Temp.”, “Gamma”, “Sharpness”, “NR”, “CTI” and “Lens aperture” are registered in the Picture Mode.

### 1 Select picture mode



### 2 Adjust picture quality

Example: To adjust “Contrast”

#### 1 Display the setting menu



#### 2 Select “Picture Adjust” → “Contrast”

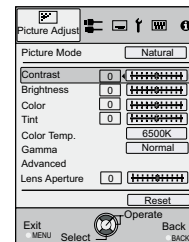
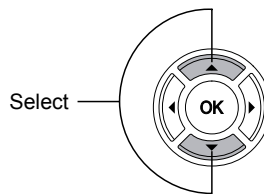

#### 3 Adjust the setting

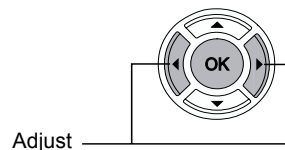

#### 4 To end the adjustments



### 3 Other items can also be adjusted

### 4 To end



- “Contrast”, “Brightness”, “Color”, “Tint”, “Color Temp.”, “Gamma”, “Sharpness”, “NR” and “Lens aperture” can also be adjusted from the remote control. (P16)

## Registering User-defined Picture Mode

### 1 Select the picture mode



### 2 Adjust picture quality

- See “Changing the initial setting of picture Mode” for procedures on adjusting the picture quality. (P42)

### 3 To end



## Registering User-defined Picture Mode from the Menu

### 1 Adjust picture quality

- See “Changing the Initial Setting of Picture Mode” for procedures on adjusting the picture quality. (P42)

### 2 Display the setting menu



### 3 Select “Picture Adjust” → “Picture Mode” → “Natural”

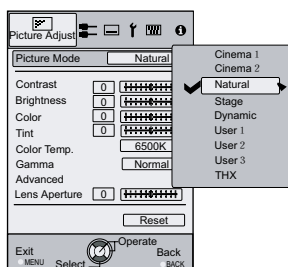
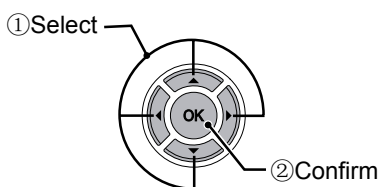

### 4 Register the setting



#### CAUTION

- Adjustment settings of image quality will not be registered if other picture mode is selected before registering these settings.

# Troubleshooting

Before sending the unit to your authorized dealer for repair, please check the following points.

The following situations are not malfunctions.

■ **You do not need to worry about the following situations if there is no abnormality on the screen.**

- Part of the top surface or front of the unit is hot.
- A creaking sound is heard from the unit.
- An operating sound is heard from the inside of the unit.
- Color smear occurs on some screens.

■ **Perform the following operations when the unit is unable to operate normally due to external static or noise.**

- ① When the unit is in standby mode, please pull out the power plug, then insert again.
- ② Press the power button on the unit to turn on the power again.

■ **A sound may be heard when the lamp is off but there is no danger.**

■ **D-ILA device is manufactured using high-precision technology but there may be some missing pixels or pixels that remain permanently lit up.**

Power is not supplied		
Is the power cord disconnected?	Insert the power cord (plug) firmly.	P26
Is the lamp cover properly shut?	Remove the power plug when the unit is in standby mode and close the lamp cover properly. After that, insert the plug again.	P49
Is the lamp in Cool Down mode?	After the Cool Down mode is complete, turn on the power again.	P27

Projected image is dark		
Is the lamp near exhaustion?	Check the lamp time on the information menu. Prepare a new lamp unit or replace as soon as possible when the lamp is near exhaustion.	P48 to 50

The unit works when power is turned on but stops abruptly after a few minutes		
Are the air inlets and exhaust vent blocked?	Remove the power plug when the unit is in standby mode and remove any blocking object. After that, insert the plug again.	P14 to 15
Is the filter dirty?	Clean the filter.	P51

Video image does not appear		
Is the correct external input selected?	Select the correct external input.	P26
Is the AV device properly connected?	Connect the AV device properly.	P18 to 21
Is the power of the AV device turned on?	Turn on the power of the AV device and play the video.	P26
Are the correct signals being output from the AV device?	Set the AV device properly.	P18 to 21
Is the setting of the input terminal correct?	Set "COMP." and "HDMI" in the setting menu according to the input signal.	P35 - <b>11 12</b>
Is the video image temporarily hidden?	Press the [HIDE] button to display the video image again.	P27

**The image cannot output by HDMI terminal**

Is the setup of "Control with HDMI" function "Off"?	Set up the "Control with HDMI" function to "Off".	P35 - <b>11</b>
---	---	-----------------

- Even if the "Control with HDMI" function is "On", there are still some devices cannot reveal image normally.

**Color does not appear or looks strange**

Is the image correctly adjusted?	Adjust "Color" and "Tint" in the setting menu.	P31 - <b>04 05</b>
----------------------------------	--	--------------------

**Video image is fuzzy**

Is the focus correctly adjusted?	Adjust the focus.	P26
Is the unit placed too near or too far away from the screen?	Set the unit at a correct distance from the screen.	P23 to 25

**Video images are missing**

Has setting been performed for screen mask?	Set "Mask" in the setting menu to "Off".	P29, 37 - <b>20</b>
Is the display out of position?	Alter the "Picture Position" value in the setting menu to ensure that images are not missing.	P36 - <b>15</b>

**Remote control does not work**

Are batteries installed correctly?	Match the polarities (⊕ or ⊖) correctly when inserting the batteries.	P17
Are batteries exhausted?	Replace with new batteries.	P17
Is there an obstructive object between the remote control and remote sensor?	Remove any obstructive objects.	P17
Is the remote control held too far away from the unit?	Hold the remote control closer to the sensor when using.	P17

**Power is cut off suddenly**

Has setting been performed for off timer?	Set "Off Timer" in the setting menu to "Off".	P41 - <b>36</b>
---	---	-----------------

# What to Do When these Messages Are Displayed

Message	Cause (Details)
<div style="border: 1px solid gray; padding: 5px; margin-bottom: 5px; text-align: center;">COMP.</div> <div style="border: 1px solid gray; padding: 5px; text-align: center;">No Input</div>	<p>No device is connected to the input terminal. The input terminal is connected but there is no signal.</p> <p>➔ Input the video signals.</p>
<div style="border: 1px solid gray; padding: 5px; text-align: center;">COMP.</div>	<p>A video signal that cannot be used in this unit has been input.</p> <p>➔ Input video signals that can be used.</p> <p>* The names of input terminals such as COMP. will be displayed in yellow.</p>
<div style="border: 1px solid gray; padding: 5px; margin-bottom: 5px; text-align: center;">Lamp replacement</div> <div style="border: 1px solid gray; padding: 5px; text-align: right; font-size: small;">             Back              BACK           </div>	<p>This message is displayed when the accumulated lamp time has exceeded 1900 hours. To clear the message, press the [Back] button.</p> <p>➔ Get ready a new lamp unit and replace as soon as possible. Reset the lamp time after replacing the lamp. (P48 to 50)</p>

# About Warning Indicators

The accumulated lamp time or warning mode of this unit is displayed by the indicators.  
For information on indicator display during normal operation, see "Controls and Features". (P14)

No.	Indicator			Blinking Time	Blinking Frequency	Interval between Blinks	Content	
	WARNING	LAMP	STANDBY/ON					
1	-	-	Light on (Red)	-	-	-	During standby	Indicator display in normal conditions.
2	-	-	Light on (Green)	-	-	-	When the power on (Hide Off)	
3	-	-	Blinking (Green)	0.5 second	continuous	-	When the power on (Hide On)	
4	-	-	Blinking (Red)	0.5 second	continuous	-	During cool down	
5	-	Light on (orange)	-	-	-	-	Lamp replacement is near (P48 to 50) (When accumulated lamp time has exceeded 1900 hours)	
6	-	Light on (orange)	-	-	-	-	Lamp has reached the end of life (P48 to 50) (When accumulated lamp time has exceeded 2000 hours)	
7	Light on (Red)	Blinking (orange)	-	0.25 second	1 time	0.75 second	Lamp does not light up and unit is unable to project	
8				0.25 second	2 times	0.75 second	Lamp is turned off during projection	
9				0.25 second	3 times	0.75 second	Lamp cover is removed	
10	Blinking (Red)	Blinking (orange)	-	0.25 second	1 time	0.75 second	Abnormalities in the power supply	
11				0.25 second	2 times	0.75 second	Cooling fan stops (cooling fan gets caught)	
12				0.25 second	3 times	0.75 second	Internal temperature is too high (abnormal internal temperature)	
13				0.25 second	4 times	0.75 second	External temperature is too high (abnormal external temperature)	
14				0.25 second	1 time	0.75 second	Abnormal electrical circuit (abnormal startup of drive circuit)	
15				0.25 second	2 times	0.75 second	Abnormal electrical circuit (abnormal communication of the drive circuit)	
16				0.25 second	3 times	0.75 second	Abnormal electrical circuit (abnormal drive circuit of image)	
17	0.25 second	4 times	0.75 second	Abnormalities in the automatic lens cover				

## Actions to Be Taken for Warning Mode

When the unit enters into warning mode (No. 7 to 17), it will automatically stop projection, and run the cooling fan for about 60 seconds.

After the cooling fan has stopped, pull out the power plug from the power outlet.

Then, follow the procedures below.

No.	Check	Action
7	<ul style="list-style-type: none"> <li>● Check that an impact shock has not occurred during operation.</li> <li>● Check that the lamp unit and lamp cover are correctly installed.</li> <li>● Check that nothing is blocking the auto lens cover.</li> </ul>	Turn on the power again.
8		
9		
17		
10	<ul style="list-style-type: none"> <li>● Check that nothing is blocking the air inlets.</li> <li>● Check that the external temperature is normal.</li> </ul>	Leave the unit until it cools down. After that, turn on the power again.
11		
12		
13		
14		
15		
16		

If the warning indication is displayed again, please wait for the cooling fan stopped, then pull out the power plug from the power outlet. Then call your authorized dealer for repair.

# Replacing the Lamp

The lamp is a consumable item. If the image is dark or the lamp is turned off, replace the lamp unit.

- When the lamp replacement time approaches, a message is displayed on the screen and the condition is indicated by the indicator. (P47)



## CAUTION

- Pull the power plug from the power outlet. Failure to do so may cause injuries or electric shocks.
- Do not replace the lamp immediately after the unit has been used, and allow a cooling period of 1 hour or more before replacement. The temperature of the lamp is still high and this may cause a burn.
- Do not apply shock to the lamp unit. It may cause lamp blowout.
- Do not use flammable air duster to clean the internal parts of the unit. This may cause fire.



## MEMO

### Usable Lamp Life

- The usable lamp life for this unit is approximately 2000 hours. The usable lamp life of 2000 hours is merely the average usable life of lamps and we do not provide any guarantee for this figure.
- The lamp life may not reach 2000 hours depending on the operating conditions.
- When the lamp has reached the end of its usable life, deterioration progresses rapidly.
- If the image is dark or the color tone is abnormal, replace the lamp unit as soon as possible.
- Setting "Lamp Power" to "Standard" will help to prolong the lamp life.

### Purchasing the Lamp Unit

Please consult your authorized dealer.

#### ■ Lamp Unit

Part No.: BHL5010-S

## Procedure for Lamp Replacement

### 1 Remove the lamp cover

- Remove the screws with a ⊕ screwdriver.

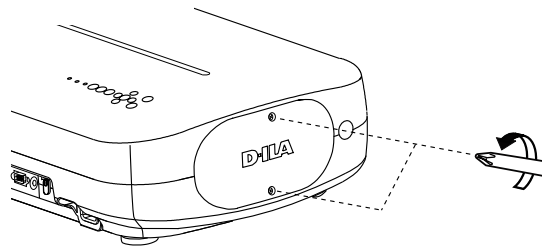

### 2 Loosen the screws on the lamp unit

- Loosen the screws with a ⊕ screwdriver.

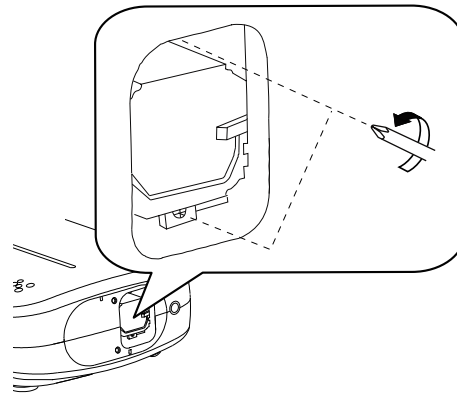

### 3 Pull out the lamp unit

- Grasp the handle and pull out the lamp unit.

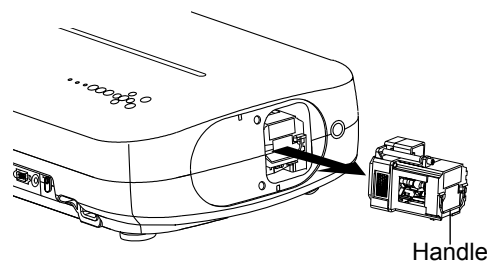



## 4 Install the new lamp unit

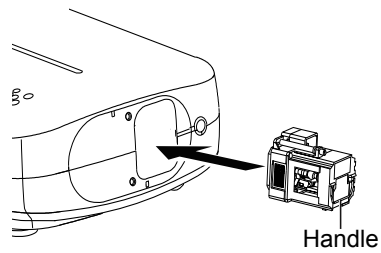

## 5 Tighten the screws of the new lamp unit

- Tighten the screws with a ⊕ screwdriver.

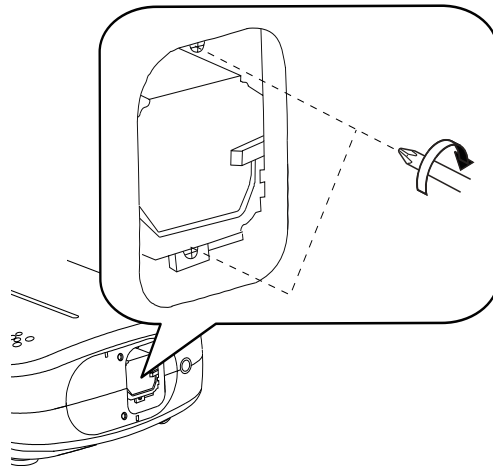

## 6 Attach the lamp cover

- Insert the top part (with 2 claws) of the lamp cover into the unit.
- Fasten the screws with a ⊕ screwdriver.

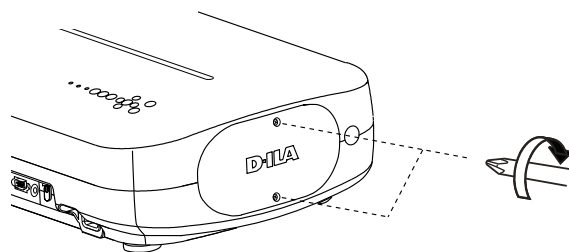

### CAUTION

- Use only genuine replacement parts for the lamp unit. Also, never attempt to reuse an old lamp unit. This may cause a malfunction.
- Do not touch the surface of a new lamp. This may shorten the lamp life and cause lamp blowout.



### MEMO

#### After Replacing the Lamp

- Do not place the removed lamp unit at locations that is reachable by children or near combustible items.
- Dispose used lamp units in the same way as fluorescent lamps. Follow your local community rules for disposal.

# Replacing the Lamp (Continued)

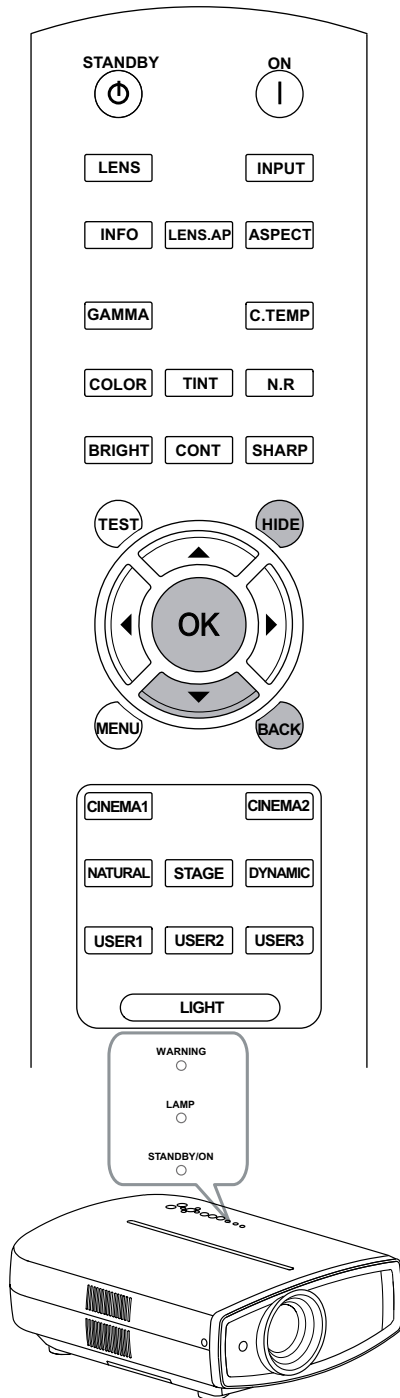

## Resetting Lamp Time

After replacing the lamp, reset the lamp time.

### 1 Insert the power plug to the power outlet

STANDBY/ON  Light on (Red)

### 2 Must operate with the remote control in the standby mode (the projector is powered, but is not turned on).

- Press in the order as shown.
- Press each button within 2-second intervals and press the last button for 2 seconds or more.

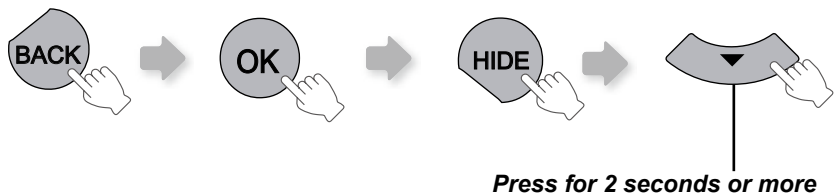

- [STANDBY/ON] indicator and [LAMP] indicator blink alternately for 3 seconds. After that, the unit switches to standby mode.



### CAUTION

- Reset the lamp time only when you have replaced the lamp.
- Never reset the service time when the lamp is still in use. Otherwise, the approximate standard for gauging replacement time may be inaccurate and lamp blowout may occur.

# Cleaning and Replacing the Filter

Clean the filter regularly or air intake efficiency may deteriorate and malfunction may occur.

## 1 Remove the inner filter

Lift up while pushing the claw

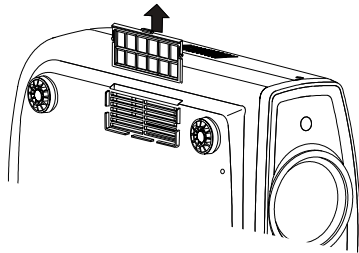

## 2 Clean the filter

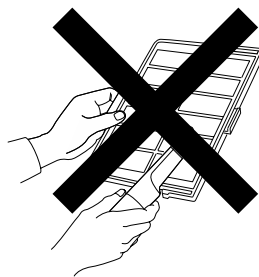
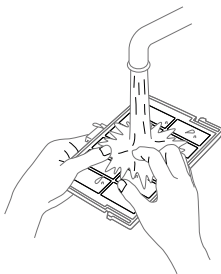

- Wash the filter with water and dry it in a shaded area.
- In extremely soiled cases, using a neutral detergent is recommended. Put on rubber gloves when using a neutral detergent.
- After washing the filter with water, make sure that it is completely dry before reinstalling. Otherwise electric shock or malfunctions may occur.
- Do not clean the filter with a vacuum cleaner or air duster. The filter is soft and may be damaged.

## 3 Reinstall the inner filter

Check that the left and right claws are locked onto the unit

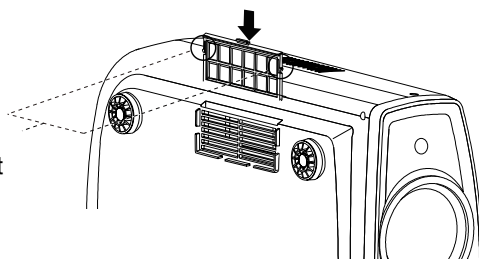

### CAUTION

- Pull the power plug from the power outlet.



### MEMO

If the filter is damaged or too dirty to be cleaned

.....

- Replace with a new filter. A dirty filter will dirty the internal parts of the unit and cause shadows on the video image.
- To purchase a new filter or when it is dirty in the internal parts, consult your authorized dealer.
- **Inner Filter Part No.:**  
**Replacement Filter:**  
the appearance is black  
PB006560999 (Inner Filter)

# RS-232C Interface

Control of this unit via a computer is possible by connecting the computer to this unit with a RS-232C cross cable (D-Sub 9 pin).

## RS-232C Specifications

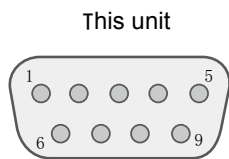

Pin No.	Signal	Function	Signal Direction
2	RxD	Receive data	PC→This unit
3	TxD	Transmit data	This unit→PC
5	GND	Signal ground	-
1,4,6 - 9	N/C	-	-

- PC refers to the controller such as a personal computer.

Mode	Non-synchronous
Character Length	8 bit
Parity	None
Start Bit	1
Stop Bit	1
Data rate	19200 bps
Data format	Binary

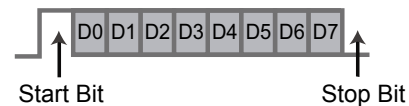

## Command Format

The command between this unit and the computer consists of "Header", "Unit ID", "Command", "Data" and "End".

- Header (1 byte), Unit ID (2 bytes), Command (2 bytes), Data (n bytes), End (1 byte)

### ■ Header

This binary code indicates the start of communication.

Binary code	Type	Description
21	Operating command	PC→This unit
3F	Reference command	PC→This unit
40	Response command	This unit→PC
06	ACK	This unit→PC (When the command is accepted without error, it returns to PC)

### ■ Unit ID

This code specifies the unit. The binary code is fixed at "8901".

## ■ Command and data

Operating command and data (Binary code)

Command	Type	Data description
0000	Connection check	Check whether communication is available between this unit and the PC during standby.
5057	Power supply	During standby 31: Turn on the power. During power on 30: Turn off the power. (Standby mode)
4950	Input	During power on 30: S-VIDEO 31: VIDEO 32: COMP. 33: VGA 36: HDMI 1 37: HDMI 2
5243	Remote Control	Sends the same code as the supplied remote control. ● "Remote control code" (P54)

Reference command and data (Binary code)

Command	Type	Data description
5057	Power supply	During standby or power on 30: Standby mode 31: Power-on mode 32: During Cool Down mode 34: Warning mode
4950	Input	During power on 30: S-VIDEO 31: VIDEO 32: COMP. 36: HDMI 1 37: HDMI 2

## ■ End

This code indicates the end of communication. The binary code is fixed at "0A".

# RS-232C Interface (Continued)

## ■ Remote control code

- Binary code is sent during communication.

Remote control button name	Binary code
▲	37 33 30 31
▼	37 33 30 32
BACK	37 33 30 33
ON	37 33 30 35
STAND BY	37 33 30 36
INPUT	37 33 30 38
BRIGHT	37 33 30 39
CONT	37 33 30 41
SHARP	37 33 31 34
COLOR	37 33 31 35
TINT	37 33 31 36
N.R	37 33 31 38
HIDE	37 33 31 44
LENS.AP	37 33 32 30
MENU	37 33 32 45
OK	37 33 32 46
LENS	37 33 33 30

Remote control button name	Binary code
▶	37 33 33 34
◀	37 33 33 36
TEST	37 33 35 39
STAGE	37 33 36 37
CINEMA2	37 33 36 38
CINEMA1	37 33 36 39
NATURAL	37 33 36 41
DYNAMIC	37 33 36 42
USER1	37 33 36 43
USER2	37 33 36 44
USER3	37 33 36 45
INFO	37 33 37 34
GAMMA	37 33 37 35
C.TEMP	37 33 37 36
ASPECT	37 33 37 37

## RS-232C Communication Examples

This section shows the communication examples of RS-232C.

### ■ Operating command

Type	Command	Description
Connection check	PC→This unit: 21 89 01 00 00 0A This unit→PC: 06 89 01 00 00 0A	Connection check
Power (On)	PC→This unit: 21 89 01 50 57 31 0A This unit→PC: 06 89 01 50 57 0A	When power is turned on from standby mode
Power (Off)	PC→This unit: 21 89 01 50 57 30 0A This unit→PC: 06 89 01 50 57 0A	When power is turned off (standby mode) from power-on mode
Input (COMP.)	PC→This unit: 21 89 01 49 50 32 0A This unit→PC: 06 89 01 49 50 0A	When video input is set to component
Remote Control (MENU)	PC→This unit: 21 89 01 52 43 37 33 32 45 0A This unit→PC: 06 89 01 52 43 0A	When the same operation as pressing the [MENU] button on the remote control is made

### ■ Reference command

Type	Command	Description
Power (On)	PC→This unit: 3F 89 01 50 57 0A This unit→PC: 06 89 01 50 57 0A This unit→PC: 40 89 01 50 57 31 0A	When information of power-on mode is acquired
Input (S-VIDEO)	PC→This unit: 3F 89 01 49 50 0A This unit→PC: 06 89 01 49 50 0A This unit→PC: 40 89 01 49 50 30 0A	When information of S-VIDEO input is acquired

# Copyright and Caution

## About Trademarks and Copyright

- HDMI, HDMI logo and high definition multimedia interface are trademarks or registered trademarks of HDMI Licensing LLC.

## Caution

### **D-ILA Device Characteristics**

Do not project still pictures or pictures that have still segments for a long period of time. The still parts of the picture may remain on the screen.

Take special notice of images on the screens of video games and computer programs. There is no problem when playing normal video images such as movies.

### **When Unit is Unused for a Long Time**

Prolonged disuse of the unit may effect an error on the functions. Turn on the power occasionally and operate the unit.

### **Usage Environment**

- Avoid direct exposure of screen to direct sunlight and illumination. Block light using a curtain. Images can be well projected by darkening the brightness of the room.
- Do not use this unit in rooms with cigarette smoke or oily smoke. This may cause the unit to malfunction.

### **Parts Replacement**

This unit contains parts (optical part, cooling fan, etc.) that require replacement to maintain its functioning. The estimated time for parts replacement varies greatly depending on the usage and environment. Please consult your authorized dealer for replacement.

### **Maintenance Procedures**

#### Dirt on the cabinet

- Gently clean dirt on the cabinet with a soft cloth. In the case of heavy soiling, soak a cloth in water, wring dry and wipe, followed by wiping again with a dry cloth. Pay attention to the following as the cabinet may deteriorate in condition or paint may come off.
  - Do not wipe with thinner or benzene.
  - Do not spray with volatile chemicals like insecticide.
  - Do not allow prolonged contact with rubber or plastic products.

#### Dirt in the air inlets

- Use a vacuum cleaner to suck up the dirt. Otherwise, use a cloth to wipe off the dirt. If dirt is allowed to accumulate in the air inlets, the internal temperature cannot be adjusted and this may cause a malfunction.

#### Dirt on the lens

- Clean the dirt using commercial blowers or lens cleaning papers for cleaning glasses and cameras. Do not use fluid-type cleaning agents. This may lead to peeling of the surface coating film.



## Mounting this Unit

Measures to prevent the unit from toppling or dropping should be taken for safety reasons and accident prevention during emergencies including earthquakes.

When mounting this unit on a pedestal or ceiling, remove the 4 feet on the bottom surface and use all the 4 screw holes (M5 screws) to mount.

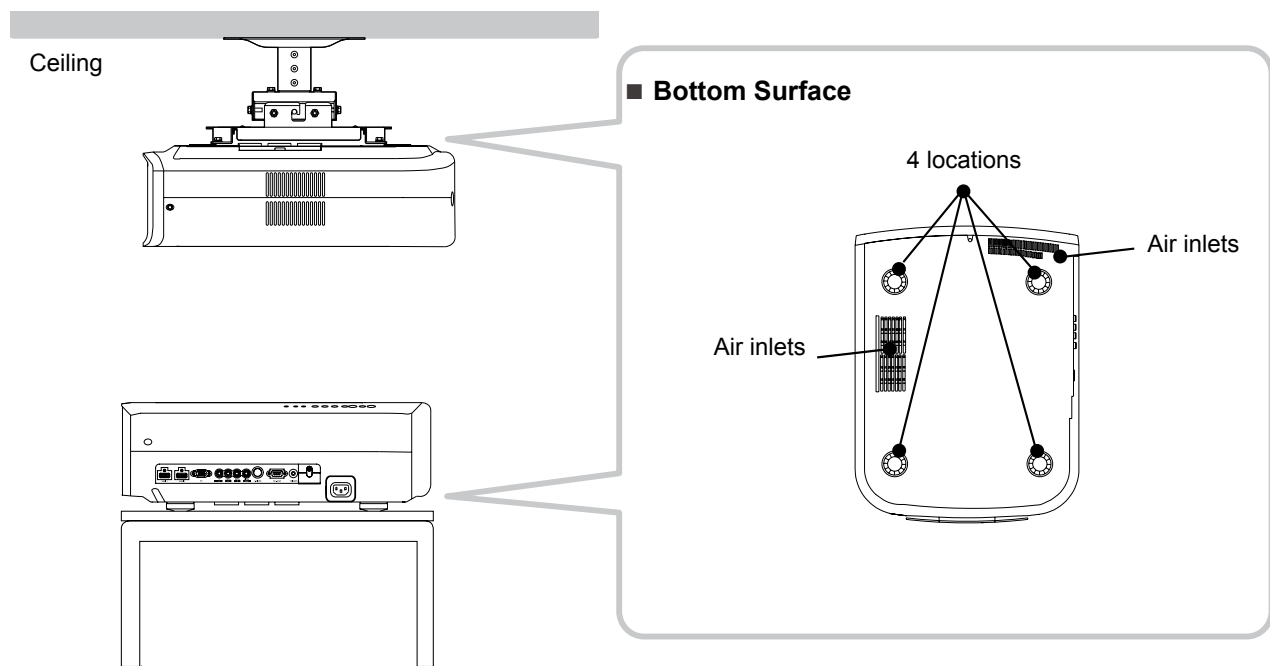

### Precautions for Mounting

- Special expertise and techniques are required for mounting this unit. Be sure to ask your dealer or a specialist to perform mounting.
- Depth of the screw holes (screw length) is 23 mm. Use screws shorter than 23 mm but longer than 13 mm.  
**Using other screws will result in malfunctioning or cause the unit to drop.**
- When mounting to a pedestal, ensure sufficient space (foot height of 10 mm or higher) around the unit so that the air inlets are not blocked.
- Do not tilt this unit more than  $\pm 5$  degrees from side to side when using.
- Regardless whether the unit is still under guarantee, JVC is not liable for any product damage caused by mounting the unit with non-JVC ceiling fittings or when the environment is not suitable for ceiling-mount.
- When using the unit hanging from a ceiling, pay attention to the surrounding temperature. When a heater is in use, temperature around the ceiling is higher than expected.

# Specifications

Product Name	D-ILA Projector
Model Name	DLA-HD750
Display Panel/Size	D-ILA device <sup>*1*</sup> / 0.7" (1920pixels x 1080pixels) x 3 (Total no. of pixels: Approx. 6.22million)
Projection Lens	2.0 x power zoom lens (1.4:1 to 2.8:1)(Zoom/Focus: Power)
Light-source Lamp	200 W Ultra-high pressure mercury lamp [Part No. : BHL5010-S]
Screen Size	Approx. 60" to 200" (Aspect ratio: 16:9)
Projection Distance	Approx. 1.8m to 12m
Color System	NTSC, NTSC4.43, PAL, PAL-M, PAL-N, SECAM (Auto/Manual switch)
Analog Video Input Format	480i, 480p, 576i, 576p, 720p/50Hz, 720p/60Hz, 1080i/50Hz, 1080i/60Hz
Digital Video Input Format	480i, 480p, 576i, 576p, 720p/50Hz, 720p/60Hz, 1080i/50Hz, 1080i/60Hz, 1080p/24Hz, 1080p/50Hz, 1080p/60Hz, PC compatible signals (P59)
Resolution	1920 dots x 1080 dots
Color Management	Featured
Terminals	
Video Input (VIDEO)	1-line, RCA pin jack x 1 1.0V(p-p), 75Ω
S-video Input (S-VIDEO)	1-line, mini DIN 4 pin x 1 Y: 1.0V(p-p), 75Ω C: 0.286V(p-p), 75Ω(NTSC); 0.3V(p-p), 75Ω(PAL)
Component Video Input (COMPONENT)	1-line, RCA pin jack x 3 Y: 1.0V(p-p), 75Ω C <sub>B</sub> /P <sub>B</sub> , C <sub>R</sub> /P <sub>R</sub> : 0.7V(p-p), 75Ω
HDMI Input (HDMI 1, HDMI 2)	2-line, HDMI 19 pin x 2(HDCP compliant) <sup>*3</sup>
PC Input	1-line, D-Sub 15 pin VGA
Trigger Output	12V 100mA
Power Requirements	AC 110V-240V 50/60 Hz
Power Consumption	280W (Standby mode: 1W)
Operation Environment	Temperature: 5°C to 35°C Humidity: 20% to 80% (No condensation) (Storage Temperature: -10°C to 60°C)
Installation Height	Below 1524m
Dimensions (Width x Height x Depth)	365mm X 167mm X 477.5mm
Mass	11.0Kg
Accessories	(See P13)

\*1 D-ILA is the abbreviation for Direct drive Image Light Amplifier.

\*2 D-ILA devices are manufactured using extremely high-precision technology. Pixel effectiveness is 99.99%. Only 0.01% or less of the pixels are either missing or would remain permanently lit up.

\*3 HDCP is the abbreviation for High-bandwidth Digital Content Protection system.

The image of HDMI input terminal may not be displayed due to HDCP specification change.

- Design and specifications are subject to change without prior notice.
- Please note that some of the pictures and illustrations may have been abridged, enlarged or contextualized in order to aid comprehension. Images may differ from the actual product.

## ■ PC compatible signals

### ● HDMI

No.	Designation	Resolution	fh [kHz]	fv [Hz]	Dot CLK [MHz]	Polarity		Total No. of dots [dot]	Total No. of lines [line]	No. of effective dots [dot]	No. of effective lines [line]
						H	V				
1	VGA 60	640 X 480	31.500	60.000	25.200	-	-	800	525	640	480
2	VGA 59.94	640 X 480	31.469	59.940	25.175	-	-	800	525	640	480
3	SVGA 60	800 X 600	37.879	60.317	40.000	+	+	1,056	628	800	600
4	XGA 60	1024 X 768	48.363	60.004	65.000	-	-	1,344	806	1,024	768
5	WXGA 60	1280X 768	47.760	60.000	79.998	-	+	1,675	796	1,280	768
6	WXGA +60	1440 X 900	55.919	59.999	106.470	-	+	1,904	932	1,440	900
7	SXGA 60	1280 X 1024	63.981	60.020	108.000	+	+	1,688	1,066	1,280	1,024
8	WSXGA +60	1680 X 1050	65.222	60.002	147.140	-	+	2,256	1,087	1,680	1,050
9	WUXGA 60	1920 X 1200	74.038	59.95	154.000	+	-	2,080	1,235	1,920	1,200

Images may not be displayed if the above timings are not met.

### ● PC (D-sub 3-lines 15 pins)

No.	Designation	Resolution	fh [kHz]	fv [Hz]	Dot CLK [MHz]	Polarity		Total No. of dots [dot]	Total No. of lines [line]	No. of effective dots [dot]	No. of effective lines [line]
						H	V				
1	VGA 60	640 X 480	31.500	60.000	25.175	-	-	800	525	640	480
2	VGA 72	640 X 480	37.900	72.000	31.500	-	-	832	520	640	480
3	VGA 75	640 X 480	37.500	75.000	31.500	-	-	840	500	640	480
4	VGA 85	640 X480	43.300	85.000	36.000	-	-	832	509	640	480
5	SVGA 56	800X 600	35.200	56.000	36.000	+	+	1024	625	800	600
6	SVGA 60	800 X 600	37.900	60.000	40.000	+	+	1056	628	800	600
7	SVGA 72	800 X 600	48.100	72.000	50.000	+	+	1040	666	800	600
8	SVGA 75	800 X 600	46.900	75.000	49.500	+	+	1056	625	800	600
9	SVGA 85	800 X 600	53.700	85.000	56.250	+	+	1048	631	800	600
10	XGA 60	1024 X 768	48.400	60.000	65.000	-	-	1344	806	1024	768
11	XGA 70	1024 X 768	56.500	70.000	75.000	-	-	1328	806	1024	768
12	XGA 75	1024 X 768	60.023	75.029	78.750	+	+	1312	800	1024	768
13	XGA 85	1024 X 768	68.700	85.000	94.500	+	+	1376	808	1024	768
14	WXGA 60	1280 X 768	47.760	60.000	79.998	-	+	1675	796	1280	768
15	WXGA+ 60	1440 X 900	55.919	59.999	106.470	-	-	1904	932	1440	900
16	SXGA 60	1280 X 1024	63.981	60.020	108.000	+	+	1688	1066	1280	1024
17	SXGA+ 60	1400 X 1050	64.740	59.950	101.000	+	+	1560	1080	1400	1050
18	WSXGA+ 60	1680 X 1050	65.222	60.002	147.140	-	-	2256	1087	1680	1050
19	1920x1080 60	1920 X 1080	67.500	60.00	148.500	+	+	2200	1125	1920	1080
20	MAC13"	640 X 480	35.000	66.667	30.240	-	-	864	525	640	480
21	MAC16"	832 X 624	49.107	75.087	55.000	-	-	1120	654	832	624
22	MAC19"	1024 X 768	60.241	74.927	80.000	-	-	1328	804	1024	768

Images may not be displayed if the above timings are not met.

# Specifications(Continued)

## Dimensions

■ Top Surface

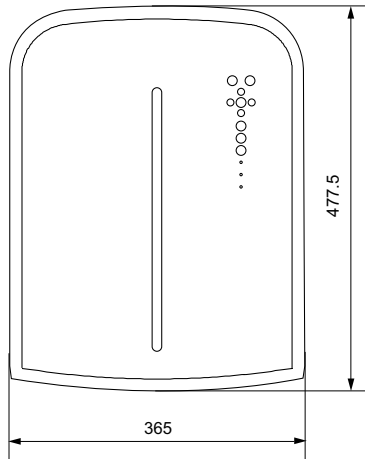

■ Bottom Surface

(Unit: mm)

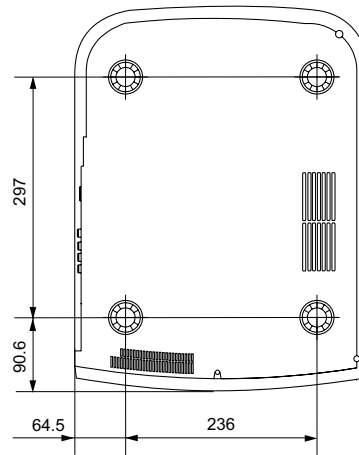

■ Front

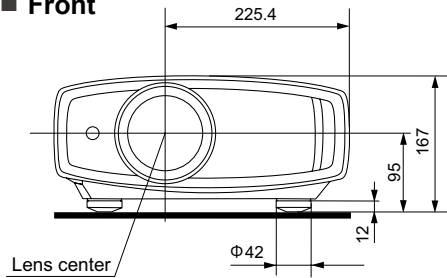

■ Back Surface

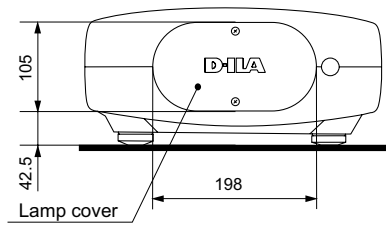

## Free Manuals Download Website

<http://myh66.com>

<http://usermanuals.us>

<http://www.somanuals.com>

<http://www.4manuals.cc>

<http://www.manual-lib.com>

<http://www.404manual.com>

<http://www.luxmanual.com>

<http://aubethermostatmanual.com>

Golf course search by state

<http://golfingnear.com>

Email search by domain

<http://emailbydomain.com>

Auto manuals search

<http://auto.somanuals.com>

TV manuals search

<http://tv.somanuals.com>