

JVC



COMPACT COMPONENT SYSTEM

HX-C6

—Consists of CA-HXC6 and SP-HXC6

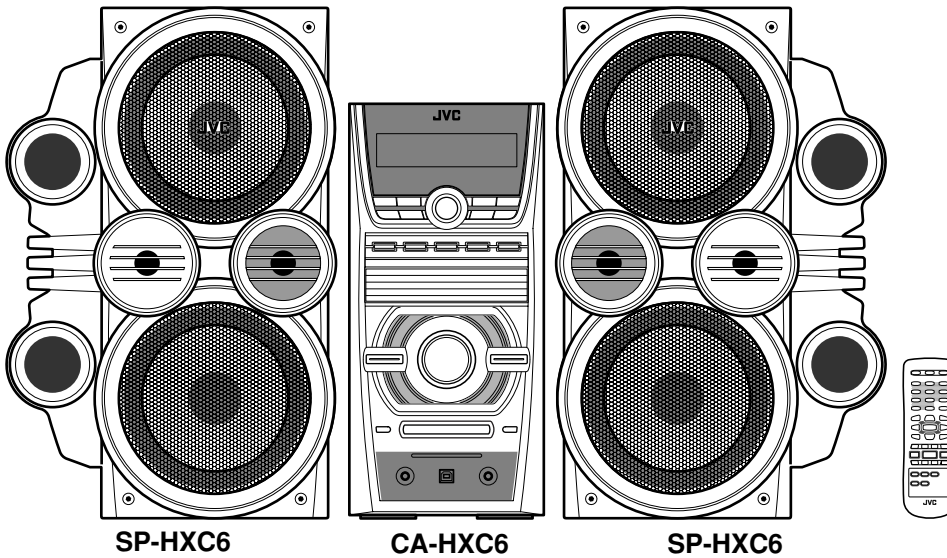

COMPACT
disc
DIGITAL AUDIO

MP3
PLAYBACK

INSTRUCTIONS

For Customer Use:

Enter below the Model No. and Serial No. which are located either on the rear, bottom or side of the cabinet. Retain this information for future reference.

Model No. _____

Serial No. _____

Warnings, Cautions and Others

Mises en garde, précautions et indications diverses

	CAUTION RISK OF ELECTRIC SHOCK DO NOT OPEN	
CAUTION: TO REDUCE THE RISK OF ELECTRIC SHOCK, DO NOT REMOVE COVER (OR BACK). NO USER SERVICEABLE PARTS INSIDE. REFER SERVICING TO QUALIFIED SERVICE PERSONNEL.		

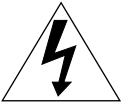

The lightning flash with arrowhead symbol, within an equilateral triangle is intended to alert the user to the presence of uninsulated "dangerous voltage" within the product's enclosure that may be of sufficient magnitude to constitute a risk of electric shock to persons.



The exclamation point within an equilateral triangle is intended to alert the user to the presence of important operating and maintenance (servicing) instructions in the literature accompanying the appliance.

WARNING: TO REDUCE THE RISK OF FIRE OR ELECTRIC SHOCK, DO NOT EXPOSE THIS APPLIANCE TO RAIN OR MOISTURE.

CAUTION

To reduce the risk of electrical shocks, fire, etc.:

- 1 Do not remove screws, covers or cabinet.
- 2 Do not expose this appliance to rain or moisture.

ATTENTION

Afin d'éviter tout risque d'électrocution, d'incendie, etc.:

- 1 Ne pas enlever les vis ni les panneaux et ne pas ouvrir le coffret de l'appareil.
- 2 Ne pas exposer l'appareil à la pluie ni à l'humidité.

Caution—STANDBY/ON button!

Disconnect the mains plug to shut the power off completely. The STANDBY/ON  button in any position does not disconnect the mains line. The power can be remote controlled.

Attention—STANDBY/ON Commutateur!

Déconnecter la fiche de secteur pour couper complètement le courant. Le commutateur STANDBY/ON  (attente/sous tension) ne coupe jamais complètement la ligne de secteur, quelle que soit sa position. Le courant peut être télécommandé.

For U.S.A.

This equipment has been tested and found to comply with the limits for a Class B digital device, pursuant to part 15 of the FCC Rules. These limits are designed to provide reasonable protection against harmful interference in a residential installation.

This equipment generates, uses and can radiate radio frequency energy and, if not installed and used in accordance with the instructions, may cause harmful interference to radio communications. However, there is no guarantee that interference will not occur in a particular installation. If this equipment does cause harmful interference to radio or television reception, which can be determined by turning the equipment off and on, the user is encouraged to try to correct the interference by one or more of the following measures:

Reorient or relocate the receiving antenna.

Increase the separation between the equipment and receiver.

Connect the equipment into an outlet on a circuit different from that to which the receiver is connected.

Consult the dealer or an experienced radio/TV technician for help.

CAUTION

Changes or modifications not approved by JVC could void the user's authority to operate the equipment.

For the main unit:

Declaration of Conformity

Model Number: HX-C6

Trade Name: JVC

Responsible Party: JVC Americas Corp.

Address: 1700 Valley Road, Wayne
New Jersey 07470

Telephone Number: 973-317-5000

This device complies with Part 15 of FCC Rules. Operation is subject to the following two conditions: (1) This device may not cause harmful interference, and (2) this device must accept any interference received, including interference that may cause undesired operation.

Note to CATV system installer:

This reminder is provided to call the CATV system installer's attention to Section 820-40 of the NEC which provides guidelines for proper grounding and, in particular, specifies that the cable ground shall be connected to the grounding system of the building, as close to the point of cable entry as practical.



30 kg / 67 lbs.

CAUTION!

To avoid personal injury or accidentally dropping the unit, have two persons unpack, carry, and install the unit.

ATTENTION!

Pour éviter toute blessure personnelle ou chute accidentelle de l'appareil, faites déballer, transporter et installer l'appareil par deux personnes.

For Canada/pour le Canada

CAUTION: TO PREVENT ELECTRIC SHOCK, MATCH WIDE BLADE OF PLUG TO WIDE SLOT, FULLY INSERT.

ATTENTION: POUR EVITER LES CHOCS ELECTRIQUES, INTRODUIRE LA LAME LA PLUS LARGE DE LA FICHE DANS LA BORNE CORRESPONDANTE DE LA PRISE ET POUSSER JUSQU'AU FOND.

For Canada/pour le Canada

THIS DIGITAL APPARATUS DOES NOT EXCEED THE CLASS B LIMITS FOR RADIO NOISE EMISSIONS FROM DIGITAL APPARATUS AS SET OUT IN THE INTERFERENCE-CAUSING EQUIPMENT STANDARD ENTITLED "DIGITAL APPARATUS," ICES-003 OF THE DEPARTMENT OF COMMUNICATIONS.

CET APPAREIL NUMERIQUE RESPECTE LES LIMITES DE BRUITS RADIOELECTRIQUES APPLICABLES AUX APPAREILS NUMIRIQUES DE CLASSE B PRESCRITES DANS LA NORME SUR LE MATERIEL BROUILLEUR: "APPAREILS NUMERIQUES", NMB-003 EDICTEE PAR LE MINISTRE DES COMMUNICATIONS.

IMPORTANT FOR LASER PRODUCTS

- 1 CLASS 1 LASER PRODUCT
- 2 **CAUTION:** Do not open the top cover. There are no user serviceable parts inside the Unit; leave all servicing to qualified service personnel.
- 3 **CAUTION:** Visible and invisible laser radiation when open and interlock failed or defeated. Avoid direct exposure to beam.
- 4 REPRODUCTION OF LABEL: CAUTION LABEL, PLACED INSIDE UNIT.

IMPORTANT POUR PRODUITS LASER

- 1 PRODUIT LASER CLASSE 1
- 2 **ATTENTION:** N'ouvrez pas le couvercle supérieur. Il n'y a aucune pièce réparable par l'utilisateur à l'intérieur de l'appareil; confiez toute réparation à un personnel qualifié.
- 3 **ATTENTION:** Risque de radiations laser visible et invisible quand l'appareil est ouvert ou que le système de verrouillage ne fonctionne pas ou a été mis hors service. Évitez toute exposition directe au rayon.
- 4 REPRODUCTION DE L'ÉTIQUETTE: ÉTIQUETTE DE PRÉCAUTION PLACÉE À L'INTERIEUR DE L'APPAREIL.

CAUTION : INVISIBLE LASER RADIATION WHEN OPEN AND INTERLOCKS DEFEATED AVOID EXPOSURE TO BEAM

ADVARSEL : USYNLIG LASERSTRÅLING VED ÅBNING NÅR SIKKERHEDSAFBRYDERE ER UDE AF FUNKTION UNDGÅ UDSÆTTELSE FOR STRÅLING

VARO : AVATTAESSA JA SUOJALUKITUS OHITETTAESSA OLET ALLTIMA NAKYMATTO MALLELASERISATEILYLLÄ ÄLÄ KATSO SATEESEEN!

VARNING : OSYNLIG LASERSTRÅLNING NÅR DENNA DEL ÄR ÖPPNAD OCH SPÄRREN ÄR URKOPPLAD BETRÄKTA EJ STRÅLEN!

Introduction

Precautions

Installation

- Install in a place which is level, dry and neither too hot nor too cold—between 5°C and 35°C.
- Install the System in a location with adequate ventilation to prevent internal heat buildup in the System.



DO NOT install the System in a location near heat sources, or in a place subject to direct sunlight, excessive dust or vibration.

- Leave sufficient distance between the System and the TV.
- Keep the speakers away from the TV to avoid interference with TV.

Power sources

- When unplugging the System from the wall outlet, always pull on the plug, not the AC power cord.



DO NOT handle the AC power cord with wet hands.

Moisture condensation

Moisture may condense on the lenses inside the System in the following cases:

- After starting to heat the room
- In a damp room
- If the System is brought directly from a cold to a warm place.

Should this occur, the System may malfunction. In this case, leave the System turned on for a few hours until the moisture evaporates, unplug the AC power cord, then plug it in again.

Internal heat

- A cooling fan is mounted on the rear panel to prevent heat buildup inside the unit.



For safety, observe the following carefully:

- Make sure there is good ventilation around the unit. Poor ventilation could overheat and damage the unit.
- DO NOT block the cooling fan and the ventilation openings or holes. If they are blocked by a newspaper or cloth, etc., the heat may not be able to get out.

Others

- Should any metallic object or liquid fall into the System, unplug the AC power cord and consult your dealer before operating any further.



DO NOT disassemble the System since there are no user serviceable parts inside.

- If you are not going to operate the System for an extended period of time, unplug the AC power cord from the wall outlet.

If anything goes wrong, unplug the AC power cord and consult your dealer.

How to Read This Manual

To make the explanations in this manual as simple and easy-to-understand as possible, we have adapted the following methods:

- Button and control operations are explained as listed in the table below.
- **Some related tips and notes are explained later in the sections “Learning More about This System” and “Troubleshooting,” but not in the same section explaining the operations.** If you want to know more about the functions, or if you have a doubt about the functions, go to these sections and you will find the answers.

	Indicates that you press the button briefly .
	Indicates that you press the button briefly and repeatedly until an option you want is selected.
	Indicates that you press one of the buttons.
	Indicate that you press and hold the button for an specified periods. <ul style="list-style-type: none"> • The number inside the arrow indicates the period of press (in this example, 2 seconds). • If no number is inside the arrow, press and hold until the entire procedure is complete or until you get a result you want.
	Indicate that you turn the control toward the specified direction(s).
	Indicates that this operation is only possible using the remote control.
	Indicates that this operation is only possible using the buttons and controls on the main unit.

Contents

Introduction.....	1
Precautions	1
How to Read This Manual	1
Getting Started	3
Step 1: Unpack.....	3
Step 2: Prepare the Remote Control.....	3
Step 3: Hook Up.....	4
Before Operating the System	6
Parts Index	6
Daily Operations—Playback.....	8
Listening to the Radio.....	9
Playing Back a Disc	10
Playing Back from the PC.....	12
Daily Operations—Sound and Other Adjustments.....	13
Adjusting the Volume	13
Reinforcing the Bass Sound.....	13
Selecting the Sound Modes.....	14
Selecting the Surround Modes	14
Turning On or Off the Key-Touch Tone.....	14
Setting the Clock.....	14
Advanced Disc Operations	15
Programming the Playing Order—Program Play	15
Playing at Random—Random Play	16
Repeating Playback—Repeat Play	17
Prohibiting Disc Ejection—Tray Lock	17
Timer Operations.....	18
Turning Off the Power Automatically	18
Setting the Daily Timer.....	18
Additional Information.....	20
Learning More about This System.....	20
Maintenance	21
Troubleshooting	21
Specifications	22

Getting Started

Step 1: Unpack the package and check the accessories.

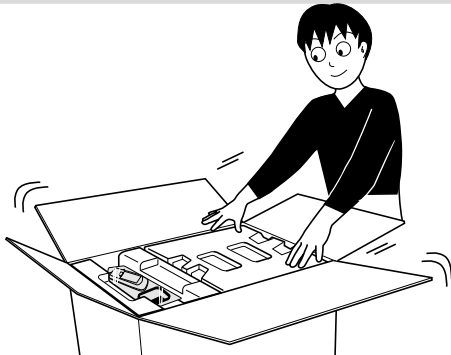

Step 1: Unpack

After unpacking, check to be sure that you have all the following items. The number in parentheses indicates the quantity of each piece supplied.

- FM antenna (1)
- AM loop antenna (1)
- Remote control (1)
- Batteries (2)

If any item is missing, consult your dealer immediately.

Step 2: Prepare the Remote Control

Insert the batteries into the remote control by matching the polarity (+ and -) correctly.

Step 2: Prepare the remote control.

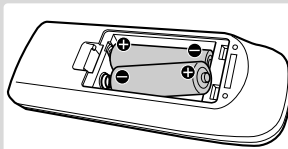

1

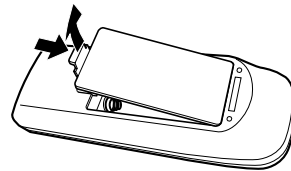

2

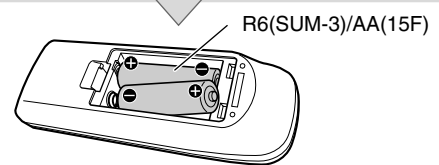

3

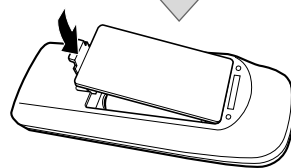

Step 3: Hook up the components such as AM/FM antennas, the speakers, etc.

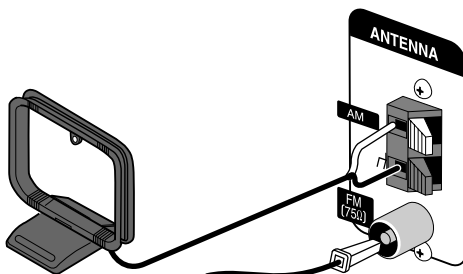

Finally plug the AC power cord.
Now you can operate this System.

- DO NOT use an old battery together with a new one.
- DO NOT use different types of batteries together.
- DO NOT expose batteries to heat or flame.
- DO NOT leave the batteries in the battery compartment when you are not going to use the remote control for an extended period of time. Otherwise, the remote control will be damaged from battery leakage.



Do not connect the power cord until all other connections have been made.

Step 3: Hook Up

If you need more detailed information, see page 5.

Illustrations of the input/output terminals below are typical examples. When you connect other components, refer also to their manuals since the terminal names actually printed on the rear vary among the components.

Turn the power off to all components before connections.

To assemble the AM loop antenna

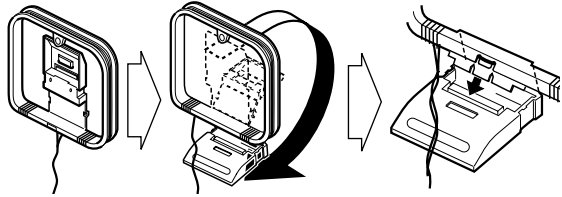

FM antenna (supplied)

Extend it so that you can obtain the best reception.

AM loop antenna (supplied)
Turn it until the best reception is obtained.

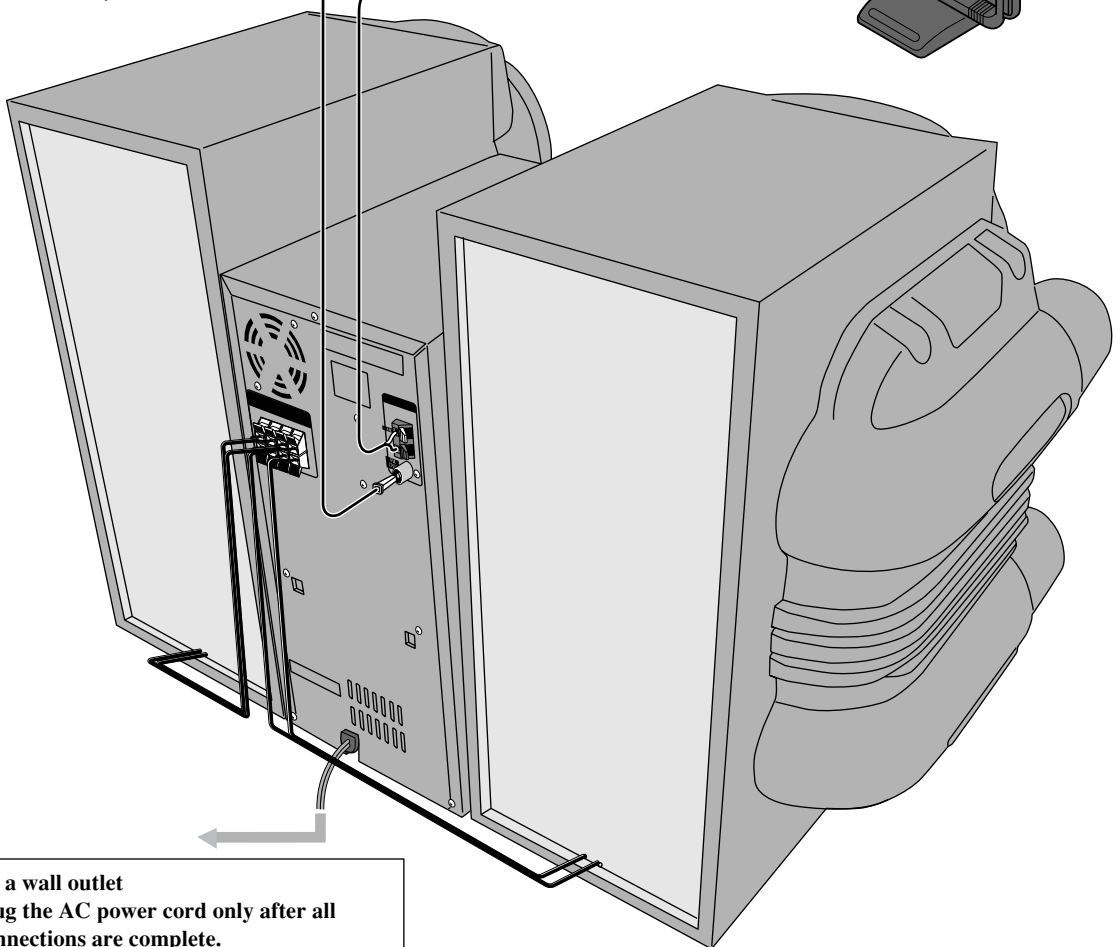
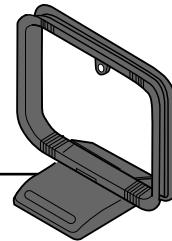

To a wall outlet
Plug the AC power cord only after all connections are complete.

- Demonstration will start automatically. To cancel it, see page 8.

Do not connect the power cord until all other connections have been made.

To connect the AM loop antenna cords

- Connect black cord to the $\overline{\text{H}}$ terminal, and the white cord to the other terminal.

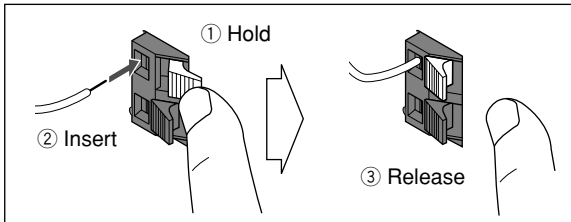

- If the AM loop antenna wire or speaker cords are covered with vinyl, remove the vinyl to expose the tip of the antenna by twisting the vinyl.
- Make sure the antenna conductors do not touch any other terminals, connecting cords and power cord. Also, keep the antennas away from metallic parts of the System, connecting cords, and the AC power cord. This could cause poor condition.

For better FM/AM reception

Outdoor FM antenna (not supplied)

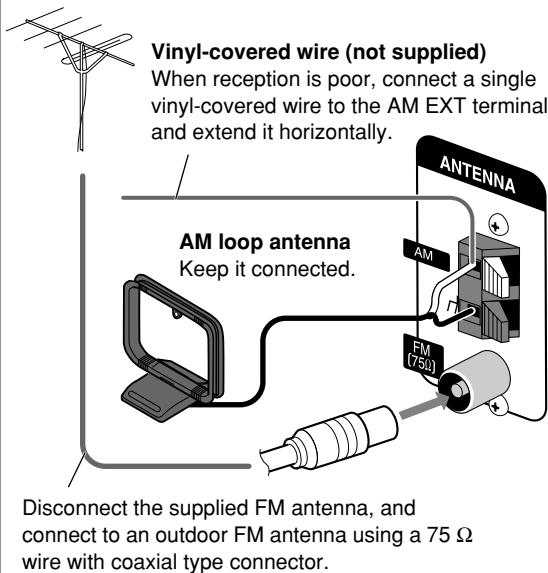

To connect the speaker cords

- The supplied speakers do not conform to magnetically shielded design. Place the speakers enough distance from a TV so that they do not cause color irregularity on the TV.
- When connecting the speaker cords, match their polarity with that of the speaker terminals: red/blue to (+) and black to (-).
- Use only speakers with the same speaker impedance as indicated by the speaker terminals on the rear of the unit.



- DO NOT connect more than one speaker to each terminal.
- DO NOT push or pull the speakers as this will damage the foot spacers at the bottom of the speakers.

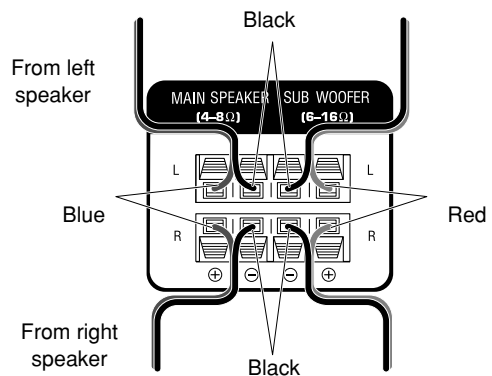
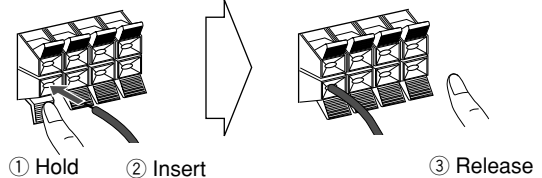

To connect other equipment

By using a stereo mini plug cord (not supplied), you can connect equipment with analog audio output jacks such as an MD player, a TV, etc.

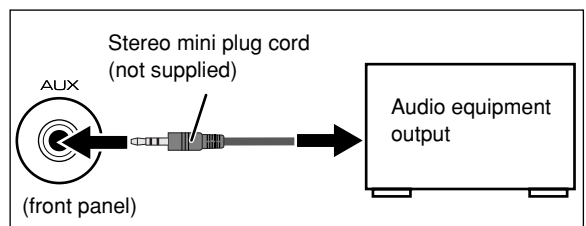

If the audio output on the other equipment is not stereo mini plug type, use a plug adapter to convert the stereo mini plug to the corresponding plug of the audio output.

IMPORTANT

- Always set volume to VOL MIN when connecting or disconnecting the other equipment.



DO NOT plug in any equipment until all connections are complete.

Before Operating the System

Parts Index

Refer to the pages to see how to use the buttons and controls.

Remote control

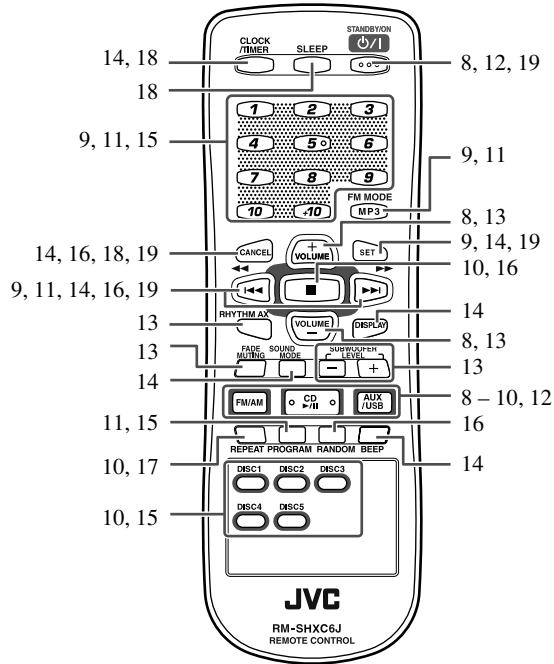

Main unit

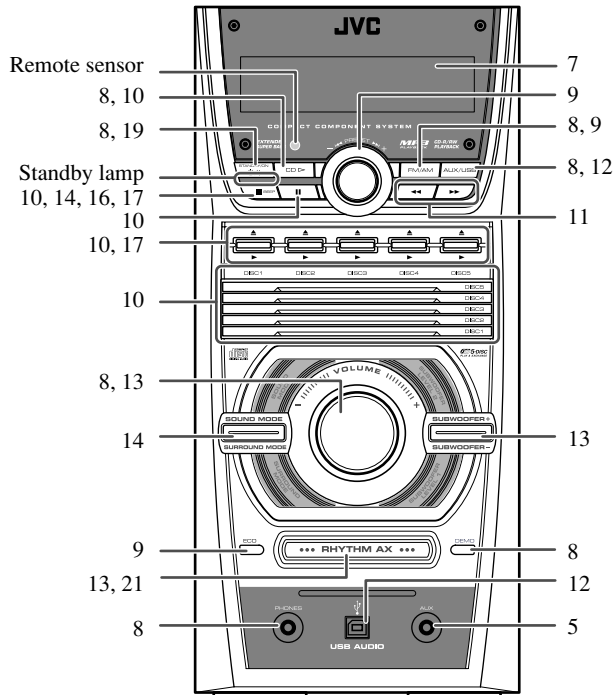

The indications on the display teach you a lot of things while you are operating the System.
Before operating the System, be familiar with when and how the indicator illuminates on the display.

Display Window

Indications on the main display

- While listening to radio:
 - Band
 - Frequency
 - Reception mode (FM only)
- While playing a disc:
 - CD:**
 - Track number
 - Elapsed playing time
 - TRACK indicator
 - MP3*1:**
 - Track number*2
 - Elapsed playing time
 - TRACK indicator
- While disc play is stopped:
 - CD:**
 - Total track number
 - Total playing time
 - TRACK indicator
 - MP3:**
 - Total track number
- While selecting "AUX" or "USB":
 - Source name

- 1 BEEP ON indicator
 - Lights when key-touch tone is activated.
- 2 Timer indicators
 - DAILY: lights when the Daily Timer stands by or is working; flashes while the Daily Timer is being set.
 - SLEEP: lights when the Sleep Timer is activated.
 - : lights when Daily Timer stands by or being set; flashes while the Daily Timer is working.
- 3 RESUME indicator
 - Lights when Resume Play for MP3 disc is activated.
- 4 Main display
- 5 Disc operation indicators
 - PROGRAM: lights when Program Play mode is activated.
 - RANDOM: lights when Random Play is activated.
 - REPEAT: lights when Repeat Play mode is activated.
 - ALL, 1, DISC:
 - ALL DISC: lights when All Disc Play/Repeat is activated.
 - 1: lights when One Track Repeat is activated.
 - 1 DISC: lights when One Disc Play/Repeat is activated.
- 6 Audio level indicator
- 7 GROUP indicator
 - Lights when the ALBUM mode is selected for MP3 playback.
- 8 CD PLAY indicator
 - Lights when "CD" is selected as the source.
- 9 Disc indicators
 - Each indicator shows the status of a disc placed on the corresponding disc tray (DISC1 – DISC5).
 - Lights up when a disc is detected.
 - Flashes when the tray is currently selected.
 - Goes off when the unit detects there is no disc loaded on the disc tray.
- 10 TRACK indicator
 - Lights when a CD is loaded.
 - Lights when the TRACK mode is selected for MP3 playback.
- 11 S.MODE indicator
 - Lights when the Sound mode is activated.
- 12 SURR. indicator
 - Lights when the Surround mode is activated.
- 13 FM reception indicators
 - ST: lights while an FM stereo station with sufficient signal strength is tuned in.
 - MONO: lights when monaural reception mode is selected.

*1 At the playback beginning, the file name will be shown for a while after the track number and elapsed playing time.

*2 In the TRACK mode: Track number on the disc.
In the ALBUM mode: Track number in the current group (see page 11).

Daily Operations—Playback

In this manual, the operation using the remote control is mainly explained; however, you can use the buttons and controls on the main unit if they have the same (or similar) name and marks.

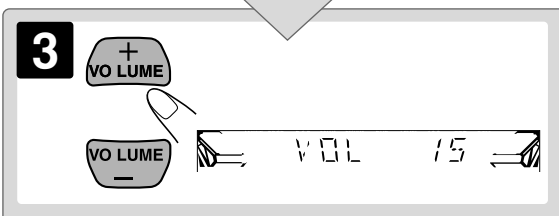
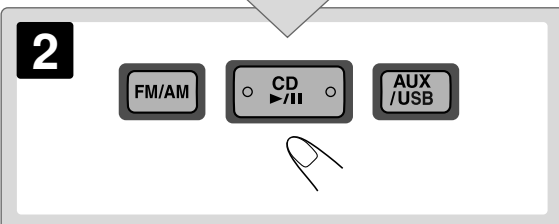
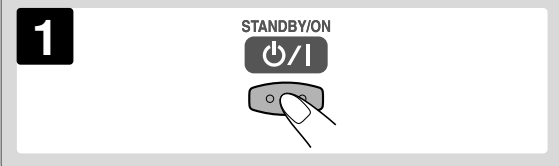
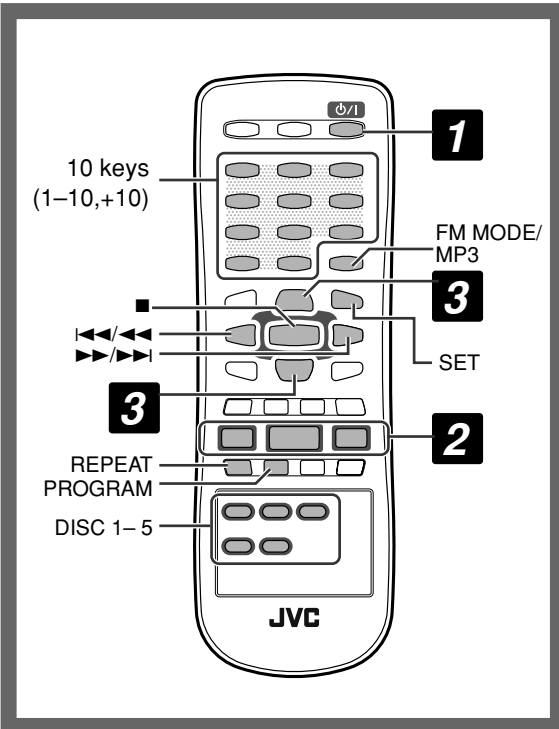

1 Turn on the power.

The standby lamp on the main unit goes off.

- Without pressing STANDBY/ON $\phi/1$, the System also turns on by pressing one of the source select button in step 2.

2 Select the source.

Playback automatically starts if the selected source is ready to start.

- If you press AUX/USB, start playback source on the external audio component or the PC.

3 Adjust the volume.

4 Operate the target source as explained later.

To turn off (stand by) the System

STANDBY/ON

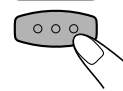

The standby lamp on the unit lights in red.

- A small amount of power is always consumed even while on standby.

For private listening

Connect a pair of headphones to the PHONES jack on the main unit. The sound will no longer come out of the speakers. Be sure to turn down the volume before connecting or putting the headphones.

- Disconnecting the headphones will activate the speakers again.



DO NOT turn off (stand by) the System with the volume set to an extremely high level; Otherwise, the sudden blast of sound can damage your hearing, speakers and/or headphones when you turn on the System or start playback.

To cancel the demonstration

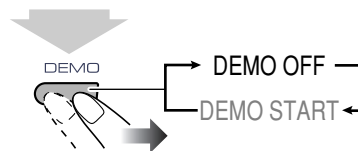

Press and hold until "DEMO OFF" appears on the display.

To save the power consumption while on standby—Eco mode

While on standby...

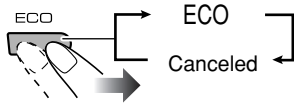

The display illumination (including the display demonstration) disappears.



Listening to the Radio

To select the band (FM/AM)

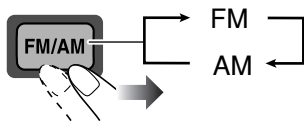

To tune in to a station

While FM or AM is selected...

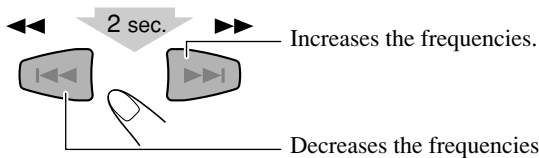

When a station (frequency) with sufficient signal strength is tuned in, the frequency search stops.

To stop searching manually, press either button.

If the received FM station is hard to listen

FM MODE



The MONO indicator lights on the display. Reception will improve though stereo effect is lost—monaural reception mode.

To restore the stereo effect, press the button again (the MONO indicator goes off).



To preset stations



You can preset 30 FM and 15 AM stations.

- 1 Tune in to a station you want to preset.
- 2 Enter into the presetting mode.

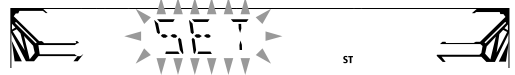
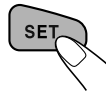

- 3 Select a preset number for the station you store.

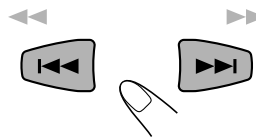

- 4 Store the station.

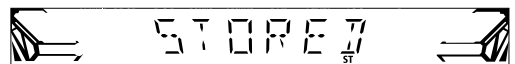
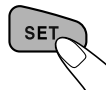

To tune in to a preset station

- 1 Select the band (FM or AM).

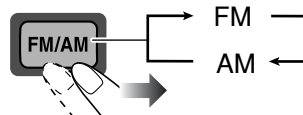

- 2 Select a preset number for the station you store.

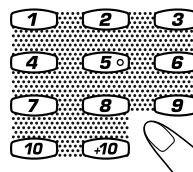

Examples:

To select preset number 5, press 5.

To select preset number 15, press +10, then 5.

To select preset number 30, press +10, +10, then 10.

- You can also use the PRESET +/- control on the unit.

Playing Back a Disc

This System can play back the following discs—regular CD and CD-R/RW (recorded in the audio CD format and in the ISO 9660 format for MP3 files).

To insert discs

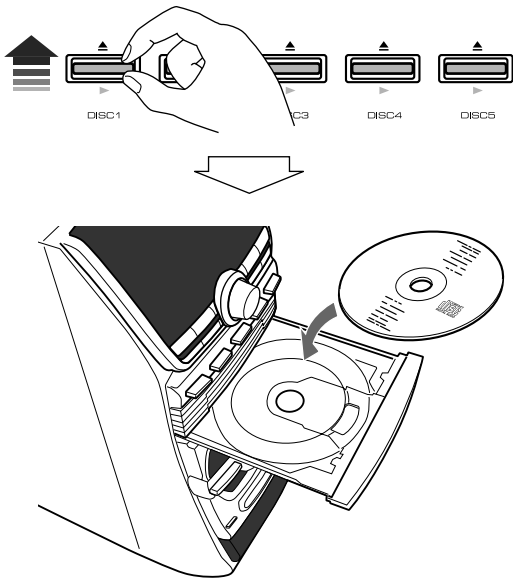

- When using an 8 cm disc, place it on the inner circle of the disc tray.

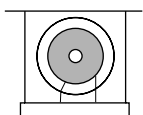

To close the disc tray, push up the same control (▲) again. If you push down the same control (▶), the disc tray closes automatically and playback starts.

- When you push up the control (▲) for the next tray you want to place another disc onto, the first disc tray automatically closes and then next tray comes out.
- When you load an MP3 disc, you can select playback mode. See “To select MP3 playback mode” on page 11.

To start:	To stop:

To pause playback

Remote control:	Main unit:
To release it, press the button again.	To release it, press CD ▷.

To select a playback disc

Remote control:
Main unit:
Ex.: To select DISC 1

Playback of the selected disc starts.

- You can play all loaded discs continuously—All Disc Play, or one selected disc—One Disc Play. Before playback or while playing...

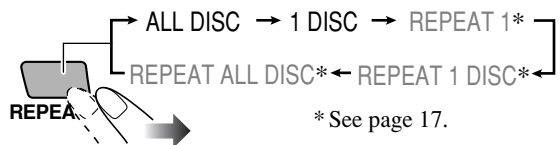

* See page 17.

ALL DISC indicator



Ex.: When All Disc play is selected.

ALL DISC	All the loaded discs are played in sequence. Ex.: When playback starts from DISC 2: DISC 2⇒DISC 3⇒DISC 4⇒DISC 5⇒DISC 1⇒(then stops)
1 DISC	Playback stops when all tracks on the selected disc are played once.

To select a track

• See the right column for an MP3 disc.

While playing a disc...

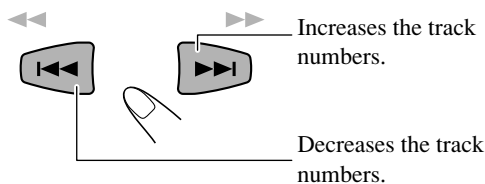

To locate a particular portion

While playing a disc, press and hold the button until the portion you want is reached.

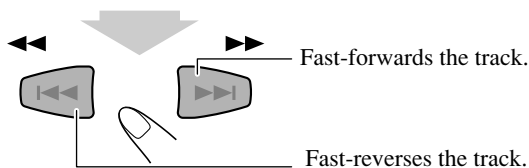

To select a track directly

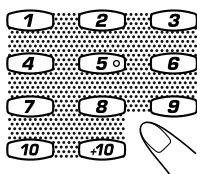

Examples:

To select track 5, press 5.

To select track 15, press +10, then 5.

To select track 30, press +10, +10, then 10.

To skip MP3 tracks



To select an MP3 track directly

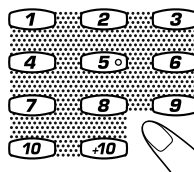

In the TRACK mode:

Selects a track number on the current MP3 disc.

In the ALBUM mode:

Selects a track number in the current group.

To select a group on an MP3 disc



Selected group number

Track number in the selected group

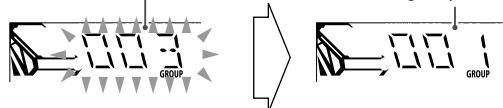

The first track of the selected group starts playing.

To select MP3 playback mode

Before playback or while playing an MP3 disc...

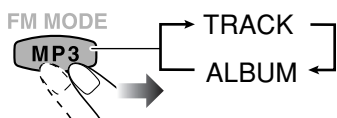

TRACK mode	The System recognizes only tracks (files). You can play an MP3 disc like an Audio CD.
ALBUM mode	The System recognizes tracks (files) and albums (groups) on an MP3 disc. You can play the MP3 disc according to the way how they are grouped. (The GROUP indicator lights up on the display.)

Resume Play for MP3 discs

While playing an MP3 disc, this System can store the number of the track that you have stopped playback. By pressing CD ►/||, you can start playback again from the beginning of the same track—Resume Play.

To activate/deactivate Resume Play

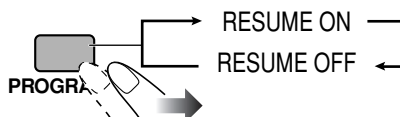

Playing Back from the PC

This System is equipped with a USB terminal on the front panel. You can connect your PC to this terminal and enjoy sound reproduced through your PC.

When you connect your PC for the first time, follow the procedure below.

- Remember you cannot send any signal or data to your PC from this System.

IMPORTANT

- Always set volume to VOL MIN when connecting or disconnecting the other equipment.



DO NOT turn off the System and disconnect the USB cable while installing drivers and playing back, and for several seconds after your PC recognizes the System.

How to install the USB drivers

The following procedure is described using the English version of Windows® XP. If your PC is running on a different version of Windows, the screens shown on your PC's monitor will differ from the ones used in the following procedure.

1 Turn on your PC and start running Windows® 98SE, Windows® Me, Windows® 2000 or Windows® XP.

- If the PC has been turned on, quit all the applications now running.

2 Turn on the System and select USB for the source.

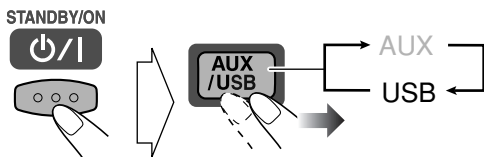

3 Connect the unit to the PC using a USB cable (not supplied).

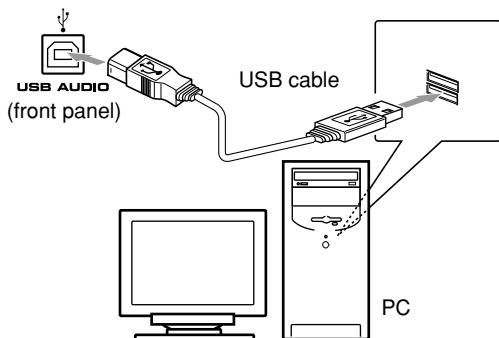

- Use “USB series A plug to B plug” cable when connecting.

4 The USB drivers are installed automatically.

- If the USB drivers are not installed automatically, install the USB drivers following the instructions on the PC's monitor.

5 Check if the drivers are correctly installed.

- 1 Open the Control Panel on your PC: Select [Start] → [Settings] → [Control Panel]
 - 2 Click [System] → [Hardware] → [Device Manager] → [Sound, video and game controllers] and [Universal Serial Bus controllers]
- The following window appears, and you can check whether the drivers are installed.

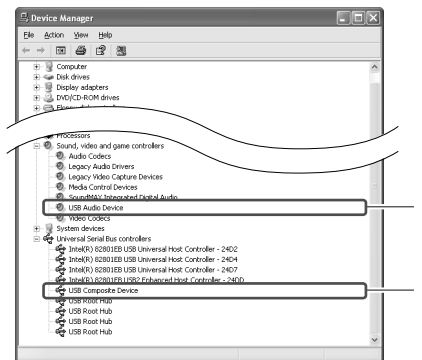

- * The installed drivers can be shown only when the System is connected to the PC.

To play back sounds on the PC

Refer to the manuals supplied with the sound reproduction application installed in the PC.

- Noise and static electricity may stop the sound through the USB connection. In this case, do the following operations:
 - Disconnect and connect the USB cable again.
 - Restart the music software on your PC.
 - Turn off and on the System.

- Microsoft®, Windows® 98SE, Windows® Me, Windows® 2000 and Windows® XP are registered trademarks of Microsoft corporation.

Daily Operations—Sound and Other Adjustments

Remote Control

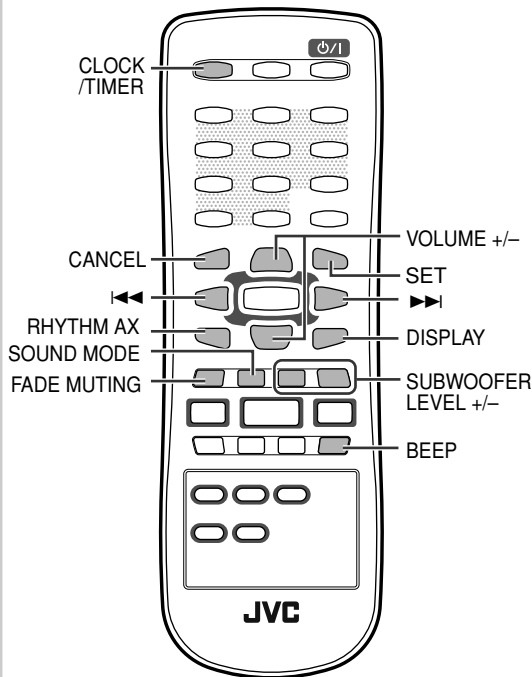

Main unit

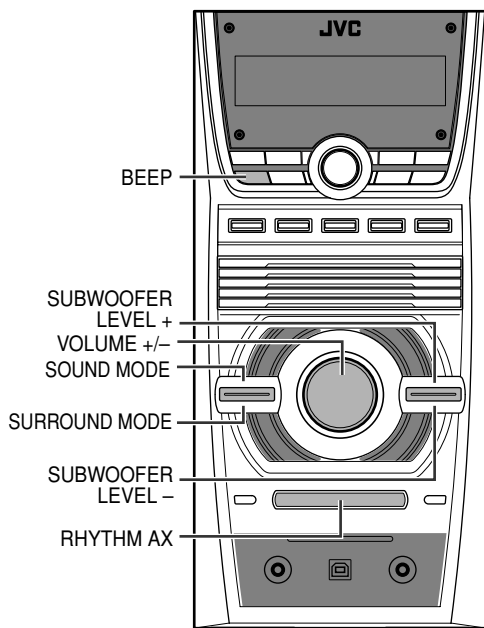

Adjusting the Volume

The volume level can be adjusted in 32 steps (VOL MIN, VOL 1 – VOL 30, and VOL MAX).

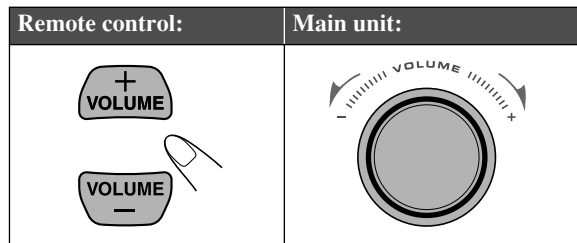

To drop the volume in a moment



To restore the volume, press the button again, or adjust the volume level.

Reinforcing the Bass Sound

To adjust the subwoofer level gradually

You can select the subwoofer level from level 0 (minimum) to level 2 (maximum).

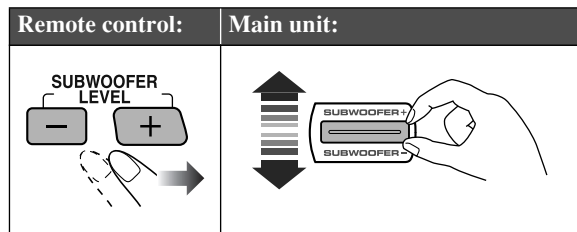

To emphasize rhythm feeling—RHYTHM AX

This function emphasizes bass attack feeling, and also changes the subwoofer level.

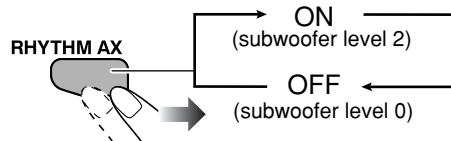

Selecting the Sound Modes

You can select one of the preset Sound Modes.

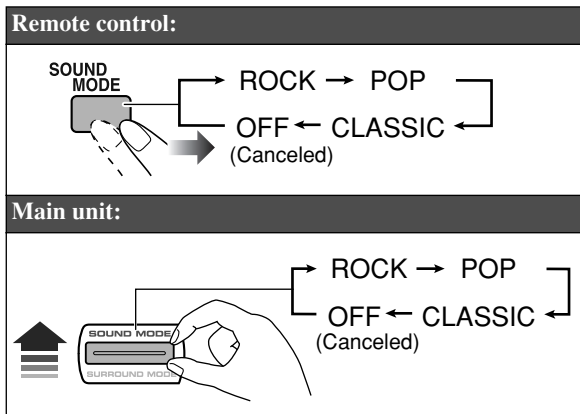

ROCK	Boosts low and high frequency.
POP	Good for vocal music.
CLASSIC	Good for classical music.

Selecting the Surround Modes



You can select one of the Surround Modes to create being-there feeling in your room.

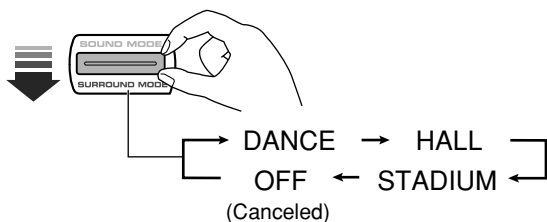

DANCE	Increases resonance and bass.
HALL	Adds depth and brilliance to the sound.
STADIUM	Adds clarity and spreads the sound, as in an outdoor stadium.

Turning On or Off the Key-Touch Tone

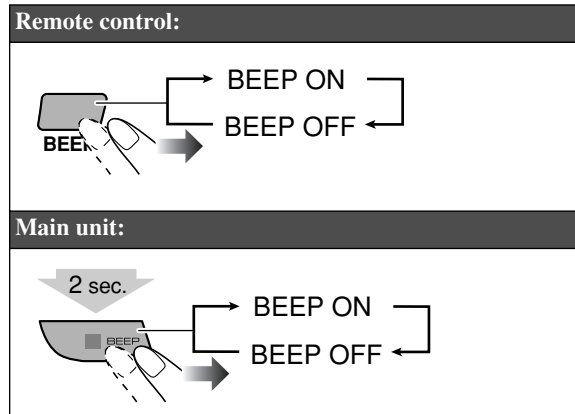

Setting the Clock



Without setting the built-in clock, you cannot use Daily Timer (see page 18).

- To exit from the clock setting, press **CLOCK/TIMER** as required.
- To go back to the previous step, press **CANCEL**.
- If you have already adjusted the clock before, press **CLOCK/TIMER** repeatedly in step 1, until the clock setting mode is selected.

1 Enter into clock setting mode.

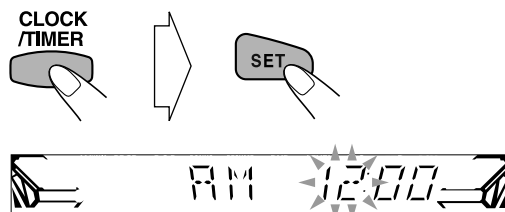

2 Adjust the hour, then minute.

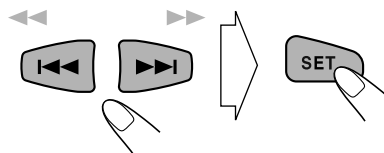

Now the built-in clock starts working.

To check the current time during play

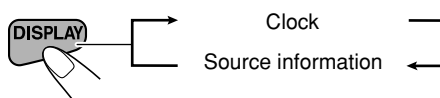

Advanced Disc Operations

Remote Control

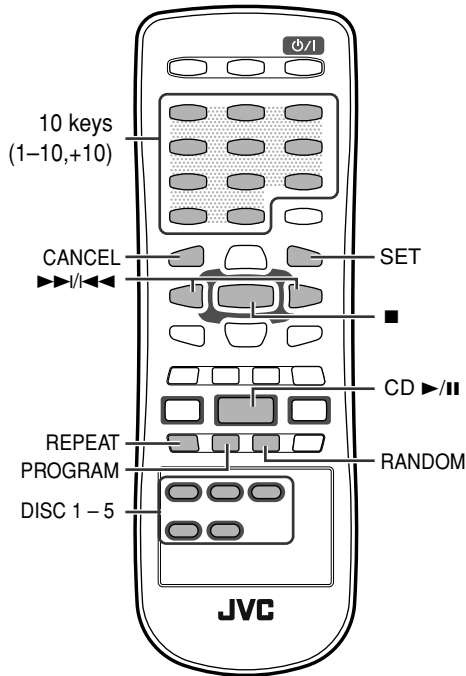

Main unit

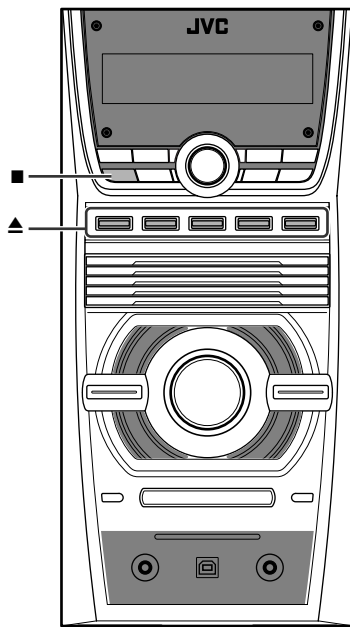

Programming the Playing Order



—Program Play

You can arrange the playing order of the tracks (up to 32 tracks) before you start playback.

- Program Play cannot be used for MP3 discs.

1 Before starting playback, activate Program Play.

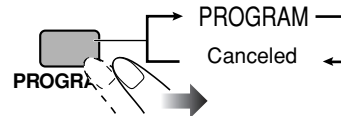

PROGRAM indicator



2 Select a disc.

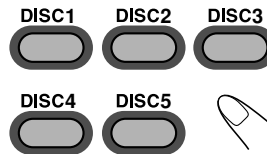

3 Select tracks you want for Program Play.

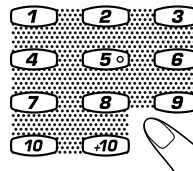

Examples:

- To select track 5, press 5.
- To select track 15, press +10, then 5.
- To select track 30, press +10, +10, then 10.

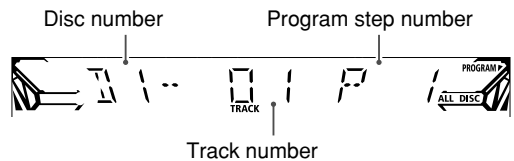

4 Repeat steps 2 and 3 until you program all tracks you want.

5 Start playback.

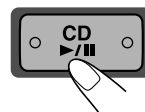

The tracks you have selected are played back in the order you have programmed.

- When all the programmed tracks played, the System exits from Program Play.

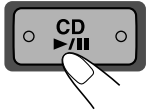
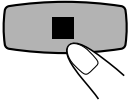
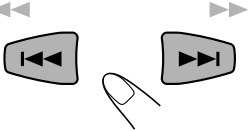
To pause:	To stop:
 <p>To release it, press the button again.</p>	 <p>The System exits from Program Play.</p>
To skip:	
	

Playing at Random—Random Play Remote ONLY >>>

You can play the contents of the current disc at random. Before playback or while playing...

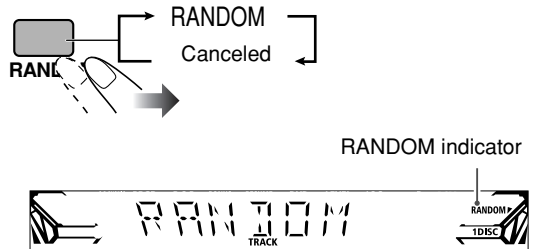

Random Playback starts. Random Play ends when all the contents of the disc are played.

To check the programmed contents Remote ONLY >>>

While the PROGRAM indicator lights on the display and before playback...

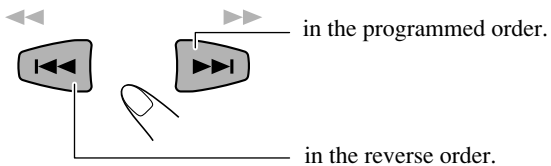

To modify the program

While the PROGRAM indicator lights on the display and before playback...

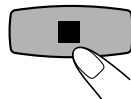
To erase the last step:	To erase the entire program:
	
To add steps in the program	
Repeat steps 2 and 3 on page 15.	

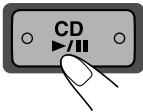
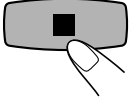
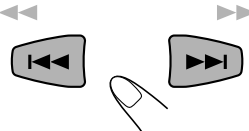
To pause:	To stop:
 <p>To release it, press the button again.</p>	 <p>The System exits from Random Play.</p>
To skip:	
 <p>Playback skips to the next track selected randomly.</p>	

To exit from Random Play while playback...

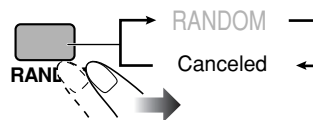

Repeating Playback—Repeat Play

You can repeat playback.

- Repeat Play and Random Play cannot be used at the same time.

Before playback or while playing...



* See page 10.

Repeat mode indicators



Ex.: When One Disc Repeat ("REPEAT 1 DISC") is selected.

REPEAT 1	Repeats the current track.
REPEAT 1 DISC	Repeats all tracks on the current disc.
REPEAT ALL DISC	Repeats all tracks on all the loaded discs.

- "REPEAT 1 DISC" cannot be selected for Program Play. It is also canceled when you select Program Play.

To exit from Repeat Play while playback...

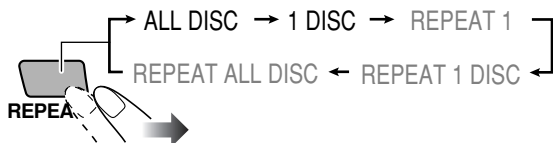



Prohibiting Disc Ejection—Tray Lock

You can prohibit disc ejection from the System and lock discs.

- This operation is possible only when the source is the CD player.

While the disc tray is closed...

- 1 Push up and hold  for any disc tray while holding .

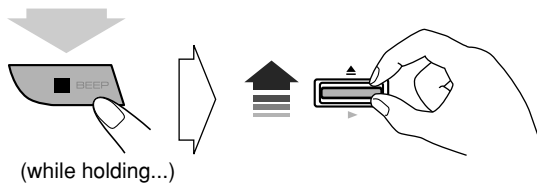

- 2 Release , then .

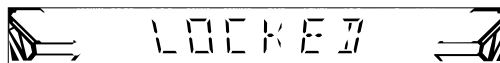

- If you try to eject discs while Tray Lock is in use, "LOCKED" appears to inform you that the disc trays are locked.

To cancel the prohibition, repeat the same procedure. "UN LOCKED" appears on the display.

Timer Operations

Remote Control

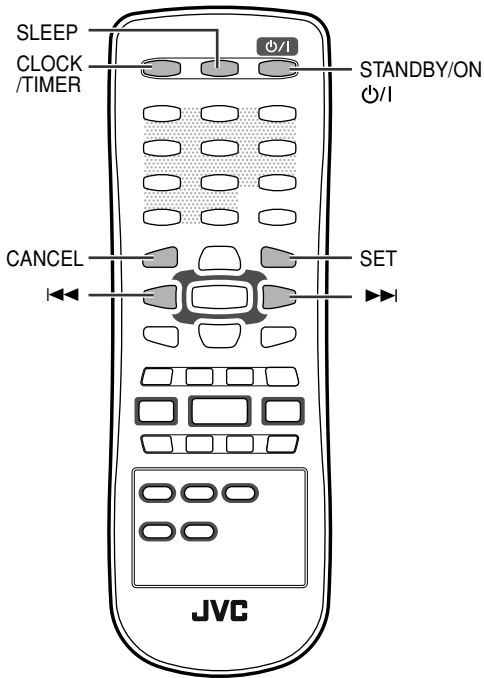

Main unit

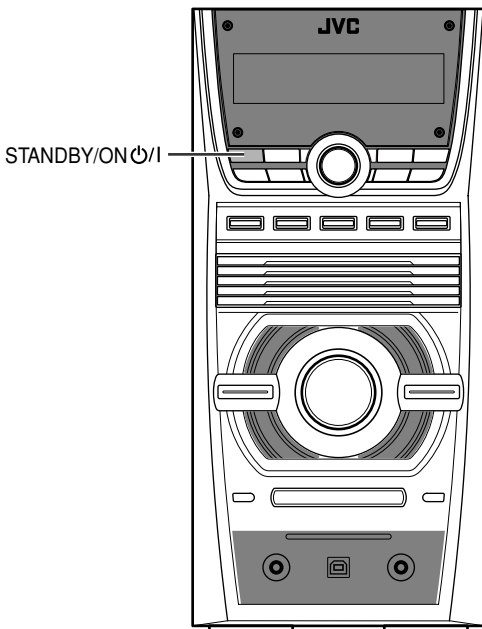

Turning Off the Power Automatically

With Sleep Timer, you can fall asleep to music.

While the System is turned on...

SLEEP

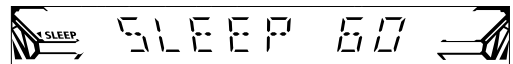
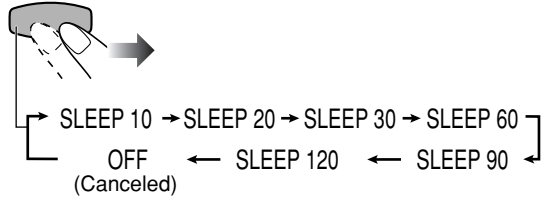

To check the time remaining until the shut-off time

SLEEP

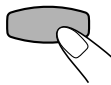

- If you press the button repeatedly, you can change the shut-off time.

Setting the Daily Timer

Using Daily Timer, you can wake up with your favorite song.

- To correct a misentry during the process, press CANCEL. You can return to the previous step.

1 Select the timer setting mode for Daily Timer—“TIMER ON.”

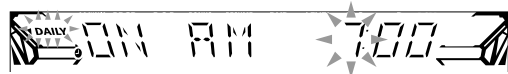
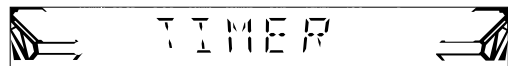
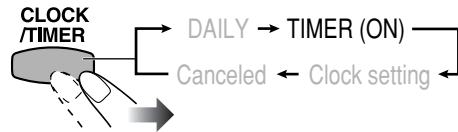

2 Set the hour then minute for on-time.

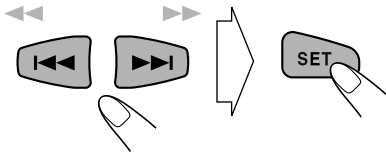

3 Set the hour then minute for off-time.

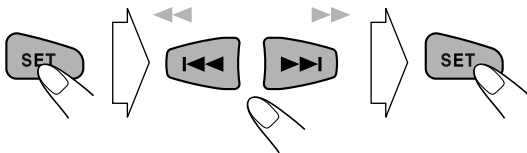

4 Select the playback source—“TUNER FM,” “TUNER AM,” “CD,” “AUX,” or “USB.”

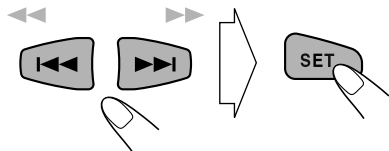

Ex.: When “TUNER FM” is selected.

- ① Select a preset station for “TUNER FM” and “TUNER AM.”
- ② Select the volume level.

5 Turn off the System (on standby) if you have set the timer with the System turned on.

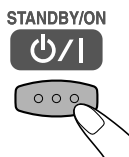

To turn off the Daily Timer

Since Daily Timer is activated at the same time everyday, you may need to cancel it on some particular days.

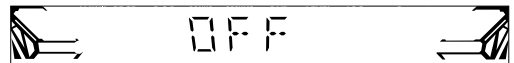
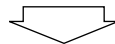
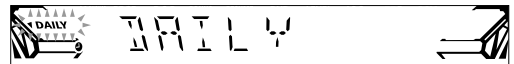
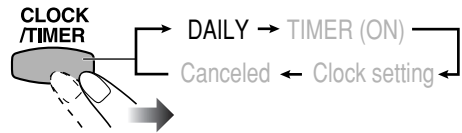

- The timer () indicator goes off.

To turn on the timer again...

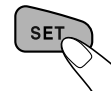
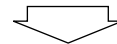
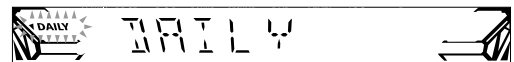
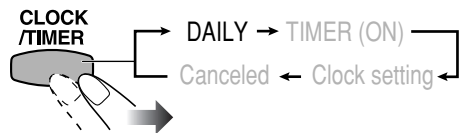

How Daily Timer actually works

Once the Daily Timer has been set, the timer () indicator and DAILY indicator are lit on the display. Daily Timer is activated at the same time everyday until the timer is turned off manually (see the next column).

When the on-time comes

The System turns on, tunes in to the specified station or start playing the specified source, and sets the volume level to the preset level.

When the off-time comes

The System stops playback, and turns off (stands by).

- The timer setting remains in memory until you change it.

Additional Information

Learning More about This System ● ● ●

Daily Operations—Playback (see pages 8 to 12)

Listening to the Radio:

- When you repeatedly press ►►/◄◄, the frequency changes step by step.
- If you store a new station into an occupied preset number, the previously stored station in that number will be erased.
- When you unplug the AC power cord or if a power failure occurs, the preset stations will be erased in a few days. If this happens, preset the station again.

Playing Back a Disc:

- The Non-DVD side of a “DualDisc” does not comply with the “Compact Disc Digital Audio” standard. Therefore, the use of Non-DVD side of a DualDisc on this product may not be recommended.
- This System cannot play “packet write” discs.
- For MP3 playback...
 - MP3 discs require a longer readout time than regular CDs. (It depends on the complexity of the group/file configuration.)
 - Some MP3 files cannot be played back and will be skipped. This result from their recording processes and conditions.
 - When making MP3 discs, use ISO 9660 Level 1 or level 2 for disc format.
 - This System can play back MP3 files with the extension code <.mp3> (regardless of the letter case—upper or lower).
 - It is recommended that you make each MP3 files at a sampling rate of 44.1 kHz and at bit rate of less than 64 kbps.
 - This System manages files and folders as “tracks” and “groups.”
 - This System can recognize up to 90 groups per disc (up to 750 tracks).
- You can exchange discs while playing or selecting another disc.
- One Disc Play is also canceled when you change the source or turn off the System.
- If the MP3 file has ID3 Tags (Version 1.0 or 1.1), the track title (“<TITLE>”) and performer name (“<ARTIST>”) will be shown after the file name appears.
- Your entry will be ignored if you have tried to enter a track number that does not exist on the disc or in the group (for example, selecting track 14 in the group that only has 12 tracks).
- The memory of the track number for Resume Play will be erased when you eject the disc or you change the disc to play.
- If you unplug the AC power cord, Resume Play is back to on.

Daily Operations—Sound and Other Adjustments (see pages 13 and 14)

Adjusting the Volume:

- Be sure to turn down the volume before connecting or putting the headphones.
- When you turn off the System with the volume level set to “VOL 16” or higher, the volume level is reset to “VOL 15” next time you turn on the System.

Adjusting the Sound:

- This function also affects the sound through the headphones.
- The subwoofer lamp(s) indicates the current subwoofer level—1 or 2. (If the level is “0,” the lamp(s) turns off.)

Selecting the Sound Modes:

- The sound mode lamp lights when one of the sound mode is activated.

Selecting the Surround Modes:

- The Surround mode lamp lights when one of the Surround mode is activated.

Setting the Clock:

- “- :- -” will flash on the display until you set the clock.

Advanced Disc Operations (see pages 15 to 17)

Programming the Playing Order—Program Play:

- While programming steps...
 - If you try to program a disc number which the System has not read, “NO READ” appears on the display.
 - If you try to program a disc number on which no disc is loaded, “NO DISC” appears on the display.
 - Your entry will be ignored if you have tried to program an item number that does not exist on the disc (for example, selecting track 14 on a disc that only has 12 tracks). Such entries are ignored.
- If you try to add a 33rd track, “FULL” appears on the display.
- The program contents will be erased when...
 - You unplug the AC power cord.
 - You open the disc tray currently selected (regardless of the play mode).

Playing at Random—Random Play:

- Activating Random Play cancels Repeat Play or All Disc Play. (One Disc Play is automatically selected.)
- Activating Random Play for an MP3 disc changes the ALBUM mode to the TRACK mode.
- Random Play is also canceled when you eject the disc or change the disc to play.

Repeating Playback—Repeat Play:

- Repeat Play is also canceled when you change the source or turn off the System.

Timer Operations (see pages 18 and 19)

Turning Off the Power Automatically:

- If you turn off the System, Sleep Timer is canceled.

Setting the Daily Timer:

- When you unplug the AC power cord or if a power failure occurs, the timer will be canceled. You need to set the clock first, then the timer again.

Maintenance

To get the best performance of the System, keep your discs clean.

Handling discs

- Remove the disc from its case by holding it at the edge while pressing the center hole lightly.
- Do not touch the shiny surface of the disc, or bend the disc.
- Put the disc back in its case after use to prevent warping.
- Be careful not to scratch the surface of the disc when placing it back in its case.
- Avoid exposure to direct sunlight, temperature extremes, and moisture.

To clean the disc:

Wipe the disc with a soft cloth in a straight line from center to edge.

Cleaning the System

- Stains should be wiped off with a soft cloth. If the System is heavily stained, wipe it with a cloth soaked in water-diluted neutral detergent and wrung well, then wipe clean with a dry cloth.
- Since the System may deteriorate in quality, it become damaged or get its paint peeled off, be careful about the following:
 - DO NOT wipe it with a hard cloth.
 - DO NOT wipe it strong.
 - DO NOT wipe it with thinner or benzine.
 - DO NOT apply any volatile substance such as insecticides to it.

DO NOT allow any rubber or plastic to remain in contact with it for a long time.

Troubleshooting

If you are having a problem with your System, check this list for a possible solution before calling for service.

General:

Adjustments or settings are suddenly canceled before you finish.

⇒ There is a time limit. Repeat the procedure again.

Operations are disabled.

⇒ The built-in microprocessor may malfunction due to external electrical interference. Unplug the AC power cord and then plug it back in.

Unable to operate the System from the remote control.

⇒ The path between the remote control and the remote sensor on the System is blocked. Remove the obstruction.

⇒ The batteries are exhausted.

No sound is heard.

⇒ Speaker connections are incorrect or loose (see pages 4 and 5).

⇒ Headphones are connected. Disconnect the headphones.

Radio Operations:

Hard to listen to broadcasts because of noise.

⇒ Antenna connections are incorrect or loose (see pages 4 and 5).

⇒ The AM loop antenna is too close to the System.

⇒ The FM antenna is not properly extended and positioned.

Disc Operations:

The disc does not play.

⇒ The disc is placed upside down. Place the disc with the label side up.

The disc sound is discontinuous.

⇒ The disc is scratched or dirty.

The disc tray does not open or close.

⇒ The AC power cord is not plugged in.

⇒ Tray Lock is in use (see page 17).

⇒ Program Play is in use. Exit from Program Play (see page 16).

USB Operations:

Unable to play back through the USB connection.

⇒ USB connection and setting is incorrect (see page 12).

The sound through the USB connection stops.

⇒ Noise and static electricity may stop the sound through the USB connection. In this case, do the following operations:

- Disconnect and connect the USB cable again
- Restart the music software on your PC
- Turn off and on the system

Timer operations:

Daily Timer does not work.

⇒ The System has been turned on when the on-time comes. Timer starts working only when the System is turned off.

If you still have a problem, reset the System.

While in standby...



Press and hold until the display flashes.

The factory default settings are restored and all the settings you have made are erased.

Specifications

Amplifier section—CA-HXC6

Output Power:

- SUB WOOFER:** 170 W per channel, min. RMS, driven into 6 Ω at 63 Hz with no more than 10% total harmonic distortion.
- MAIN SPEAKER:** 80 W per channel, min. RMS, driven into 4 Ω at 1 kHz with no more than 10% total harmonic distortion.

Audio input sensitivity/impedance:

- AUX:** 400 mV/47 k Ω
- USB:** USB Version 1.1

Speakers/impedance:

- SUB WOOFER:** 6 Ω – 16 Ω
- MAIN SPEAKER:** 4 Ω – 8 Ω

Tuner

- FM tuning range:** 87.5 MHz – 108.0 MHz
- AM tuning range:** 530 kHz – 1 710 kHz

CD player

- CD capacity:** 5 discs
- Dynamic range:** 87 dB
- Signal-to-noise ratio:** 90 dB
- Wow and flutter:** Immeasurable
- MP3 recording format:** MPEG 1/2 Audio Layer 3
- Max. Bit rate:** 320 kbps

General

- Power requirement:** AC 120 V \sim , 60 Hz
- Power consumption:** 90 W/110 VA (at operation)
11 W (on standby; with power saving off—Normal mode)
1.2 W (on standby; with power saving on—Eco mode)
- Dimensions (W/H/D) (approx.):**
175 mm x 373 mm x 389 mm
(6 ¹⁵/₁₆ in. x 14 ¹¹/₁₆ in. x 15 ³/₈ in.)
- Mass (approx.):** 9.8 kg (21.6 lbs)

Supplied accessories

See page 3.

Speaker section—SP-HXC6

Type: 4-Way Front Twin Woofer

Speaker Systems:

- Subwoofer:** 16 cm (6 ⁵/₁₆ in.) cone x 1
- Woofer:** 16 cm (6 ⁵/₁₆ in.) cone x 1
- Mid range:** 7 cm (2 ¹³/₁₆ in.) cone x 1
- Tweeter:** 2 cm (¹³/₁₆ in.) piezo x 1

Power handling capacity:

- Subwoofer:** 340 (170 + 170) W
- Main speaker:** 160 (80 + 80) W

Impedance:

- Subwoofer:** 6 Ω
- Main speaker:** 4 Ω

Frequency range:

- Subwoofer:** 25 Hz – 1 000 Hz
- Main speaker:** 50 Hz – 20 000 Hz

Sound pressure level:

- Subwoofer:** 73 dB/W•m
- Main speaker:** 82 dB/W•m

Dimensions (W/H/D) (approx.):

295 mm x 452 mm x 387 mm
(11 ⁵/₈ in. x 17 ¹³/₁₆ in. x 15 ¹/₄ in.)

Mass (approx.): 8.6 kg (19.0 lbs) each

Design and specifications are subject to change without notice.



LIMITED WARRANTY

AUDIO-1

JVC COMPANY OF AMERICA (JVC) warrants this product and all parts thereof, except as set forth below ONLY TO THE ORIGINAL RETAIL PURCHASER to be FREE FROM DEFECTIVE MATERIALS AND WORKMANSHIP from the date of original purchase for the period shown below. ("The Warranty Period")

PARTS	1 YR	LABOR	1 YR
-------	-------------	-------	-------------

THIS LIMITED WARRANTY IS VALID ONLY IN THE FIFTY (50) UNITED STATES, THE DISTRICT OF COLUMBIA AND IN THE COMMONWEALTH OF PUERTO RICO.

WHAT WE WILL DO:

If this product is found to be defective within the warranty period, JVC will repair or replace defective parts with new or rebuilt equivalents at no charge to the original owner. Such repair and replacement services shall be rendered by JVC during normal business hours at JVC authorized service centers. Parts used for replacement are warranted only for the remainder of the Warranty Period. All products may be brought to a JVC authorized service center on a carry-in basis. Color televisions with a screen size of 27" or greater qualify for in-home service. In such cases, a technician will come to your home and either repair the TV there or remove and return it if it cannot be repaired in your home.

WHAT YOU MUST DO FOR WARRANTY SERVICE:

Please do not return your product to the retailer
Instead, return your product to the JVC authorized service center nearest you. If shipping the product to the service center, please be sure to package it carefully, preferably in the original packaging, and include a brief description of the problem(s). Please call 1-800-252-5722 to locate the nearest JVC authorized service center. Service locations can also be obtained from our website <http://www.jvc.com>. If your product qualifies for in-home service, the service representative will require clear access to the product.

If you have any questions concerning your JVC Product, please contact our Customer Relations Department at 800-252-5722

WHAT IS NOT COVERED:

This limited warranty provided by JVC does not cover:

1. Products which have been subject to abuse, accident, alteration, modification, tampering, negligence, misuse, faulty installation, lack of reasonable care, or if repaired or serviced by anyone other than a service facility authorized by JVC to render such service, or if affixed to any attachment not provided with the products, or if the model or serial number has been altered, tampered with, defaced or removed;
2. Initial installation, installation and removal from cabinets or mounting systems.
3. Operational adjustments covered in the Owner's Manual, normal maintenance, video and audio head cleaning;
4. Damage that occurs in shipment, due to act of God, and cosmetic damage;
5. Signal reception problems and failures due to line power surge;
6. Video Pick-up Tubes/CCD Image Sensors are covered for 90 days from the date of purchase;
7. Accessories;
8. Batteries (except that Rechargeable Batteries are covered for 90 days from the date of purchase);
9. Products used for commercial purposes, including, but not limited to rental.

There are no express warranties except as listed above.

THE DURATION OF ANY IMPLIED WARRANTIES, INCLUDING THE IMPLIED WARRANTY OF MERCHANTABILITY, IS LIMITED TO THE DURATION OF THE EXPRESS WARRANTY HEREIN.

JVC SHALL NOT BE LIABLE FOR ANY LOSS OF USE OF THE PRODUCT, INCONVIENCE, OR ANY OTHER DAMAGES, WHETHER DIRECT, INCIDENTAL OR CONSEQUENTIAL (INCLUDING, WITHOUT LIMITATION, DAMAGE TO TAPES, RECORDS OR DISCS) RESULTING FROM THE USE OF THIS PRODUCT, OR ARISING OUT OF ANY BREACH OF THIS WARRANTY. ALL EXPRESS AND IMPLIED WARRANTIES, INCLUDING THE WARRANTIES OF MERCHANTABILITY AND FITNESS FOR PARTICULAR PURPOSE, ARE LIMITED TO THE WARRANTY PERIOD SET FORTH ABOVE.

Some states do not allow the exclusion of incidental or consequential damages or limitations on how long an implied warranty lasts, so these limitations or exclusions may not apply to you. This warranty gives you specific legal rights and you may also have other rights which vary from state to state.

JVC COMPANY OF AMERICA
DIVISION OF JVC AMERICAS CORP.

1700 Valley Road
Wayne, NJ 07470

<http://www.jvc.com>

REFURBISHED PRODUCTS CARRY A SEPARATE WARRANTY, THIS WARRANTY DOES NOT APPLY. FOR DETAIL OF REFURBISHED PRODUCT WARRANTY, PLEASE REFER TO THE REFURBISHED PRODUCT WARRANTY INFORMATION PACKAGED WITH EACH REFURBISHED PRODUCT.

For customer use:

Enter below the Model No. and Serial No. which is located either on the rear, bottom or side of the cabinet. Retain this information for future reference.

Model No. : _____

Serial No. : _____

Purchase date : _____

Name of dealer : _____

TO OUR VALUED CUSTOMER ———

THANK YOU FOR PURCHASING THIS JVC PRODUCT.
WE WANT TO HELP YOU ACHIEVE A PERFECT EXPERIENCE.

**NEED HELP ON HOW TO HOOK UP?
NEED ASSISTANCE ON HOW TO OPERATE?
NEED TO LOCATE A JVC SERVICE CENTER?
LIKE TO PURCHASE ACCESSORIES?**

JVC[®] IS HERE TO HELP!
TOLL FREE: 1(800)252-5722
<http://www.jvc.com>

Remember to retain your Bill of Sale for Warranty Service.

————— **Do not attempt to service the product yourself** —————

Caution

To prevent electrical shock, do not open the cabinet.
There are no user serviceable parts inside.
Please refer to qualified service personnel for repairs.

JVC



Free Manuals Download Website

<http://myh66.com>

<http://usermanuals.us>

<http://www.somanuals.com>

<http://www.4manuals.cc>

<http://www.manual-lib.com>

<http://www.404manual.com>

<http://www.luxmanual.com>

<http://aubethermostatmanual.com>

Golf course search by state

<http://golfingnear.com>

Email search by domain

<http://emailbydomain.com>

Auto manuals search

<http://auto.somanuals.com>

TV manuals search

<http://tv.somanuals.com>