

JVC



COMPACT COMPONENT SYSTEM

小型組和系統

نظام اجهزة صوتية مركبة

CA-MXJ770V/CA-MXJ880V

CA-MXJ770V

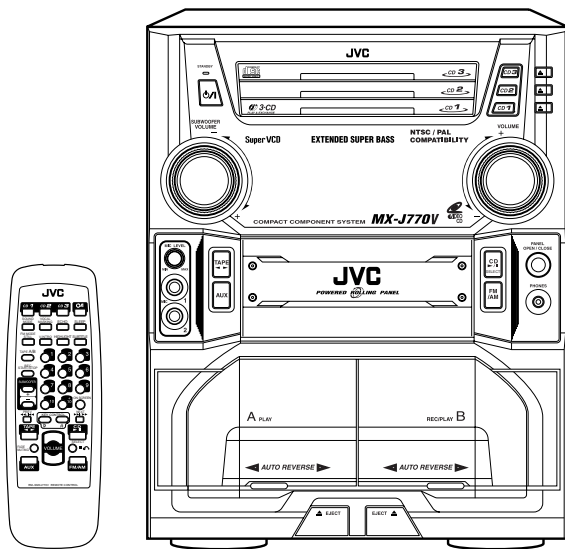

CA-MXJ880V

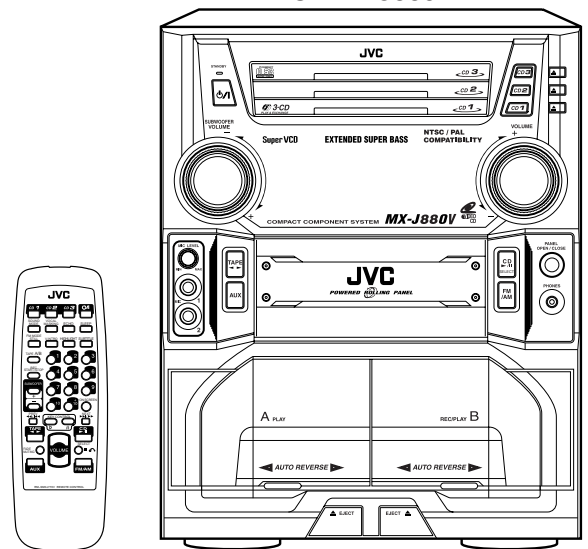

INSTRUCTIONS

使用説明書

كتيب تعليمات التشغيل

For Customer Use:

Enter below the Model No. and Serial No. which are located either on the rear, bottom or side of the cabinet. Retain this information for future reference.

Model No. _____

Serial No. _____

GVT0046-001A
[US, UT, UX]

Introduction

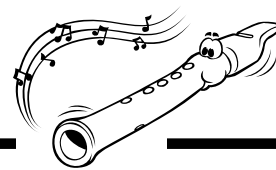

We would like to thank you for purchasing one of our JVC products. Before operating this unit, read this manual carefully and thoroughly to obtain the best possible performance from your unit, and retain this manual for future reference.

About This Manual

This manual is organized as follows:

- The manual mainly explains operations using the buttons and controls on the unit. You can also use the buttons on the remote control if they have the same or similar names (or marks) as those on the unit. If operation using the remote control is different from that using the unit, it is then explained.
- Basic and common information that is the same for many functions is grouped in one place, and is not repeated in each procedure. For instance, we do not repeat the information about turning on/off the unit, setting the volume, changing the sound effects, and others, which are explained in the section "Common Operations" on pages 9 to 11.
- The following marks are used in this manual:



Gives you warnings and cautions to prevent damage or risk of fire/electric shock. Also warns you against actions preventing you from obtaining the best possible performance from the unit.



Gives you information and hints you should know.

Precautions

Installation

- Install in a place which is level, dry and neither too hot nor too cold — between 5°C (41°F) and 35°C (95°F).
- Install the unit in a location with adequate ventilation to prevent internal heat from building up in the unit.
- Leave sufficient distance between the unit and the TV.
- Keep the speakers away from the TV to avoid interference with the TV.



DO NOT install the unit in a location near heat sources, or in a place subject to direct sunlight, excessive dust or vibration.

Power sources

- When unplugging from the wall outlet, always pull the plug, not the AC power cord.



DO NOT handle the AC power cord with wet hands.

Moisture condensation

Moisture may condense on the lens inside the unit in the following cases:

- After starting heating in the room
 - In a damp room
 - If the unit is brought directly from a cold to a warm place
- Should this occur, the unit may malfunction. In this case, leave the unit turned on for a few hours until the moisture evaporates, unplug the AC power cord, and then plug it in again.

Others

- Should any metallic object or liquid fall into the unit, unplug the unit and consult your dealer before operating any further.
- If you are not going to operate the unit for an extended period of time, unplug the AC power cord from the wall outlet.



DO NOT disassemble the unit since there are no user serviceable parts inside.

If anything goes wrong, unplug the AC power cord and consult your dealer.

Which compact discs can be used?

Many types of compact discs are sold for a variety of uses. The player can play the following compact discs:

Super VCD (SVCD) discs

- Better video resolution using MPEG2 and VBR (Variable Bit Rate) technologies.
- Up to four languages can be included as subtitles or song lyrics.
- Up to four languages can be included as audio.



Video CD discs both with and without PBC.



Audio CD discs



Discs you cannot play back

Any other discs than listed above (such as CD-ROM, DVD, CD-G or CD-I Discs) cannot be played. Playing back such discs may generate noise and damage your speakers. Even though a logo listed above is printed on the disc, it may not be played if it is a non-standard disc.

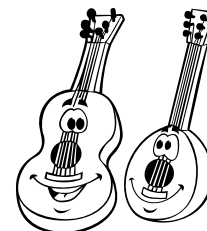

| | |
|---|-----------|
| Location of the Buttons and Controls | 3 |
| Front Panel | 3 |
| Remote Control | 5 |
| Getting Started | 6 |
| Unpacking | 6 |
| Putting the Batteries into the Remote Control | 6 |
| Connecting Antennas | 6 |
| Connecting Speakers | 7 |
| Connecting Other Equipment | 8 |
| Adjusting the Voltage Selector | 8 |
| Common Operations | 9 |
| Turning On and Off the Power | 9 |
| Setting the Clock | 9 |
| Setting the AM Tuner Interval Spacing | 9 |
| Selecting the Sources | 9 |
| Adjusting the Volume | 10 |
| Reinforcing the Bass Sound | 10 |
| Selecting the Sound Modes | 10 |
| Creating Your Own Sound Mode — Manual Mode | 11 |
| Listening to FM and AM Broadcasts | 12 |
| Tuning in a Station | 12 |
| Presetting Stations | 12 |
| Tuning in a Preset Station | 12 |
| Playing Back Audio CDs | 13 |
| Loading CDs | 13 |
| Playing Back Several Discs — Continuous Play | 13 |
| Basic CD Operations | 13 |
| Programming the Playing Order of the Tracks — Program Play | 14 |
| Playing at Random — Random Play | 15 |
| Repeating Tracks or CDs — Repeat Play | 15 |
| Prohibiting Disc Ejection — Tray Lock | 15 |
| Playing Back Video CDs/SVCDs | 16 |
| Selecting Video Output (PAL, MULTI, NTSC) | 16 |
| Loading CDs | 16 |
| Playing a Video CD | 16 |
| Playing Video CDs/SVCDs with PBC Function — Menu Play .. | 17 |
| Basic Concept of the PBC function | 17 |
| Playing Video CDs/SVCDs without PBC — Continuous Play ... | 18 |
| Resuming Play | 18 |
| Special Plays for a Video CD | 18 |
| Playing a Multiplex Sound CD | 19 |
| Using SUBTITLES | 19 |
| Playing Back Tapes | 20 |
| Playing Back a Tape | 20 |
| Locating the Beginning of a Song — Music Scan | 20 |
| Recording | 21 |
| Recording a Tape on Deck B | 21 |
| Dubbing Tapes | 22 |
| CD Direct Recording | 22 |
| Auto Edit Recording | 23 |
| Using the Microphones | 24 |
| Singing Along | 24 |
| To apply an echo to your voice | 24 |
| Singing Along with Multiplex Karaoke Discs (MPX) | 24 |
| Recording Your Singing | 25 |
| Adjust the Music Key Control (for CD play only) | 25 |
| Microphone mixing | 25 |
| Using the Timers | 26 |
| Using Daily Timer | 26 |
| Using Recording Timer | 27 |
| Using Sleep Timer | 28 |
| Timer Priority | 28 |
| Maintenance | 29 |
| Troubleshooting | 30 |
| Specifications | 31 |

Location of the Buttons and Controls

Become familiar with the buttons and controls on your unit.

Front Panel

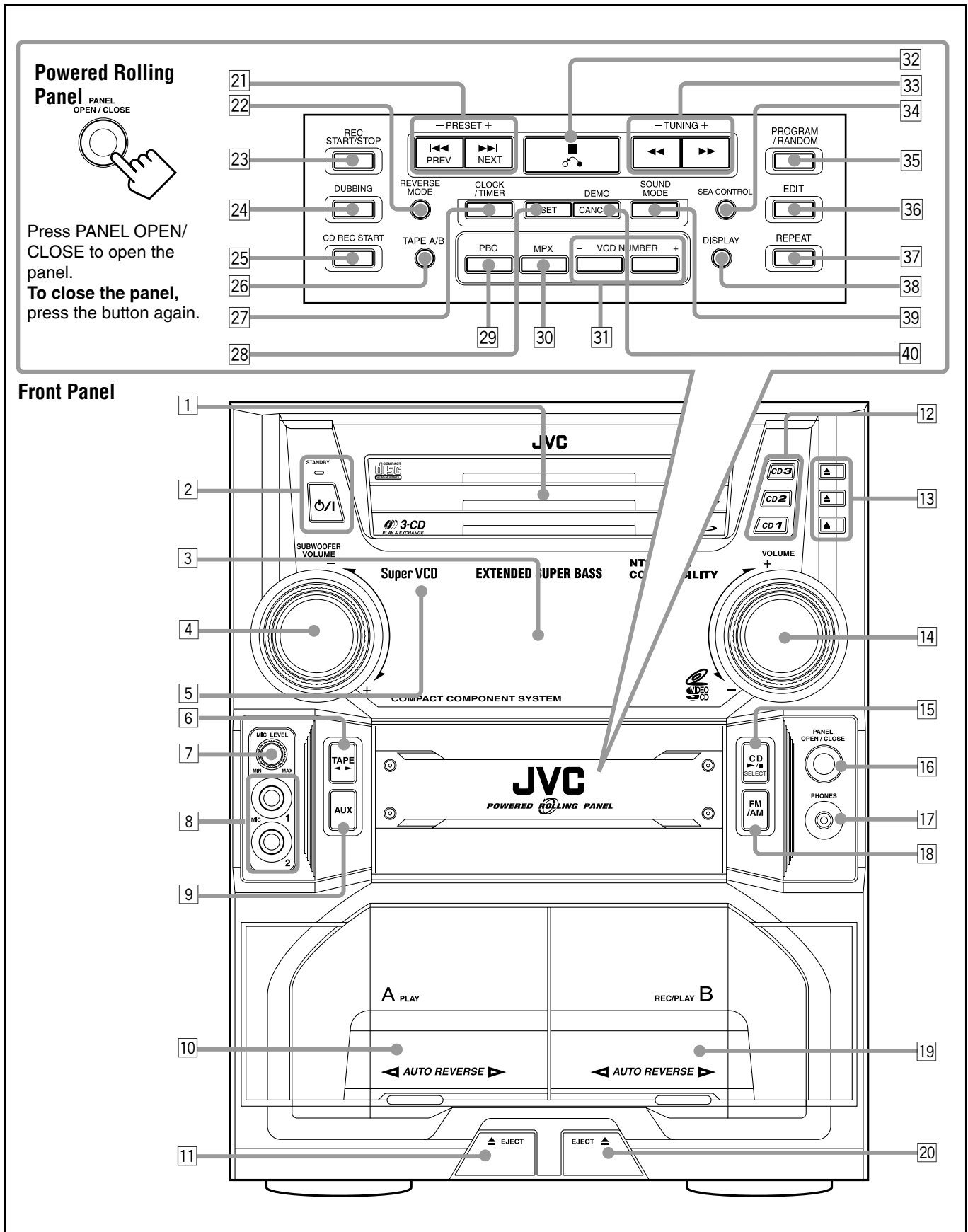

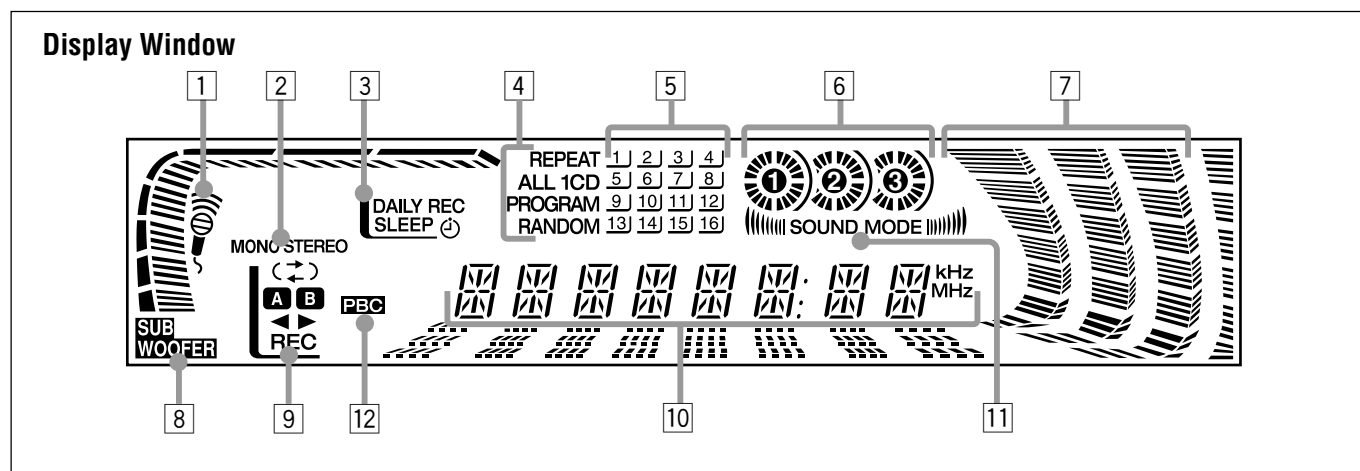

See pages in the parentheses for details.

Front Panel

- 1 Disc trays
- 2 ⏻/⏻ (On/Standby) button and STANDBY lamp (9)
- 3 Display window
- 4 SUBWOOFER VOLUME control (10)
- 5 Remote sensor
- 6 TAPE ◀▶ button and lamp (9, 20)
Pressing this button also turns on the unit.
- 7 MIC LEVEL control (24 – 25)
- 8 MIC 1 and MIC 2 jacks (24 – 25)
- 9 AUX button and lamp (9)
Pressing this button also turns on the unit.
- 10 Deck A cassette holder (20)
- 11 ▲ EJECT button for deck A (20)
- 12 Disc number buttons (CD1, CD2, and CD3) (13)
Pressing one of these buttons also turns on the unit.
- 13 ▲ (CD tray open/close) buttons (13)
Pressing one of these buttons also turns on the unit.
- 14 VOLUME control (10)
- 15 CD ▶/|| (play/pause) button and lamp (9, 13)
Pressing one of these buttons also turns on the unit.
- 16 PANEL OPEN/CLOSE button (9)
Pressing one of these buttons also turns on the unit.
- 17 PHONES jack (10)
- 18 FM/AM button and lamp (9, 12)
Pressing one of these buttons also turns on the unit.
- 19 Deck B cassette holder (20, 21)
- 20 EJECT ▲ button for deck B (20, 21)

Powered Rolling Panel

- 21 PRESET – / + buttons (12)
◀◀ / ▶▶ (reverse search/forward search) buttons (9, 11, 14, 23, 26 – 28)
- 22 REVERSE MODE button (20 – 23)
- 23 REC START/STOP button (21, 23)
- 24 DUBBING button (22)
- 25 CD REC START button (22, 23)
- 26 TAPE A/B button (20)
- 27 CLOCK/TIMER button (9, 26 – 28)
- 28 SET button (9, 12, 26 – 28)
- 29 Play Back Control (PBC) button (18)

- 30 MPX button (19)
- 31 VCD NUMBER –/+ BUTTONS (17)
- 32 ■ ⏻ (stop) button (13 – 23)
- 33 TUNING – / + buttons (12)
◀◀ / ▶▶ (fast left/fast right) buttons (11, 14, 20)
- 34 SEA CONTROL button (11)
- 35 PROGRAM/RANDOM button (14, 15, 22)
- 36 EDIT button (23)
- 37 REPEAT button (15)
- 38 DISPLAY button (9)
- 39 SOUND MODE button (10)
- 40 CANCEL button (9, 15)
DEMO button (8)

Display window

- 1 Karaoke (🎤) and echo (🔊) indicators
- 2 Tuner (FM) operation indicators
 - MONO and STEREO indicators
- 3 Timer indicators
 - DAILY (Daily Timer), REC (Recording Timer), SLEEP, and ⏻ (Timer) indicators
- 4 CD play mode indicators
 - REPEAT (ALL/1CD/1), PROGRAM, and RANDOM indicators
- 5 CD track number indicators
- 6 Disc indicators
- 7 Audio Level indicator
- 8 SUBWOOFER indicator (10)
- 9 Tape operation indicators
 - ⏮ (reverse mode), A/B (operating deck), ▶▶ (tape direction), and REC (recording) indicators
- 10 Main display
 - Shows the source name, frequency, etc.
- 11 SOUND MODE indicator
- 12 PBC indicator (16 – 19)



Remote Control

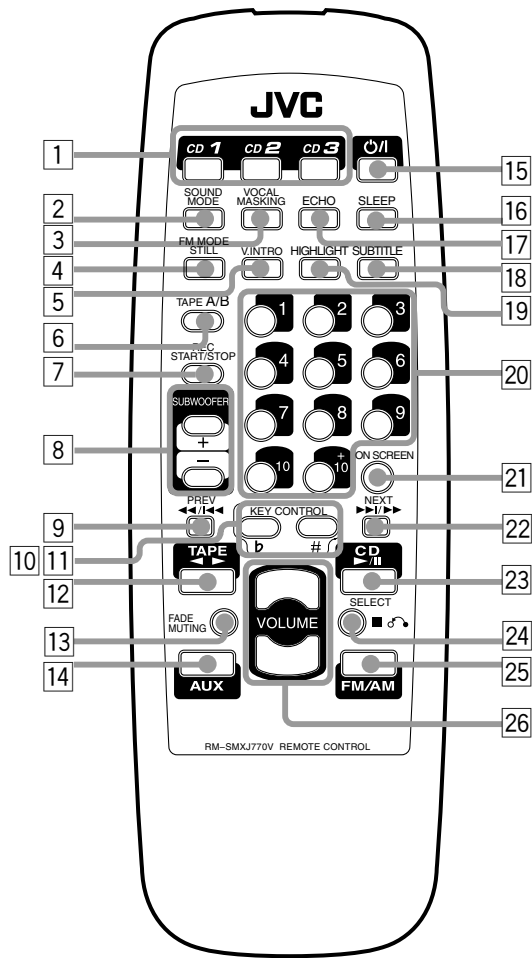

Remote Control

- 1 Disc number buttons (CD1, CD2, and CD3) (13)
Pressing one of these buttons also turns on the unit.
- 2 SOUND MODE button (10)
- 3 VOCAL MASKING button (20)
- 4 STILL button (18)
FM MODE button (12)
- 5 V.INTRO button (19)
- 6 TAPE A/B button (20)
- 7 REC START/STOP button (21)
- 8 SUBWOOFER +/- button (10)
- 9 PREV ◀◀/▶▶ button (14-20)
- 10 KEY CONTROL **b** button (25)
- 11 KEY CONTROL # button (25)
- 12 TAPE ◀▶ button (9, 20)
- 13 FADE MUTING button (10)
- 14 AUX button (9)
- 15 ⏻/⏻ (On/Standby) button (9)
- 16 SLEEP button (28)
- 17 ECHO button (24)
- 18 SUBTITLE button (19)
- 19 HIGHLIGHT button (19)
- 20 Number buttons (12, 14, 19)
- 21 ON SCREEN buttons (18)
- 22 NEXT ▶▶/▶▶▶▶ buttons (14-20)
- 23 CD ▶▶/|| buttons (9, 13)
- 24 SELECT ■ ⚙ buttons (13 – 19)
- 25 FM/AM buttons (9, 12)
- 26 VOLUME +/- buttons (10)

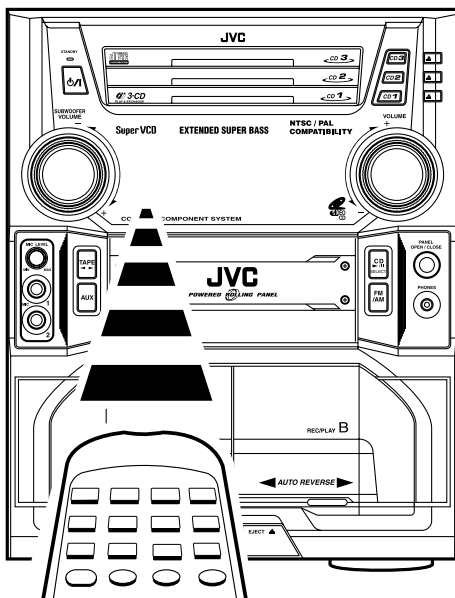

When using the remote control, point it at the remote sensor on the front panel.

Unpacking

After unpacking, check to be sure that you have all the following items.

The numbers in the parentheses indicate the quantity of the pieces supplied.

- AM loop antenna (1)
- FM antenna (1)
- Remote control (1)
- Batteries (2)
- AC plug adaptor (1)
- Video cord (1)

If any is missing, consult your dealer immediately.

Putting the Batteries into the Remote Control

Insert the batteries — R6(SUM-3)/AA(15F) — into the remote control, by matching the polarity (+ and –) on the batteries with the + and – markings on the battery compartment.

When the remote control can no longer operate the unit, replace both batteries at the same time.

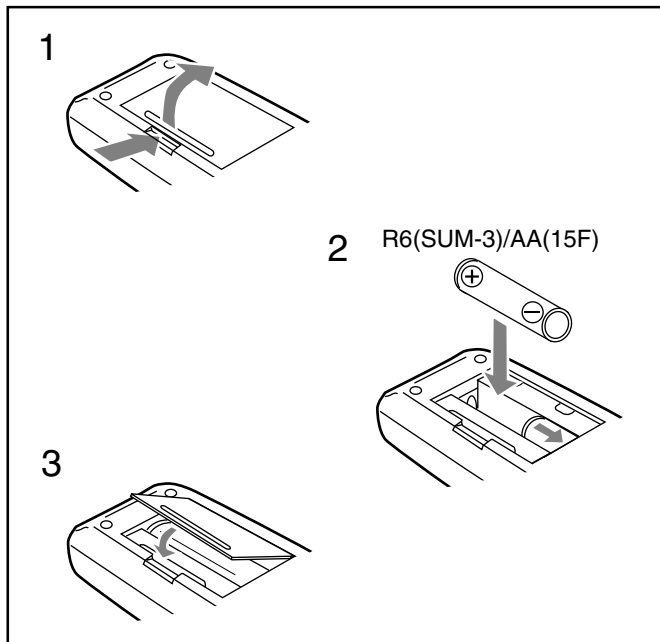

- DO NOT use an old battery together with a new one.
- DO NOT use different types of batteries together.
- DO NOT expose batteries to heat or flame.
- DO NOT leave the batteries in the battery compartment when you are not going to use the remote control for an extended period of time. Otherwise, it will be damaged from battery leakage.

Connecting Antennas

FM antenna

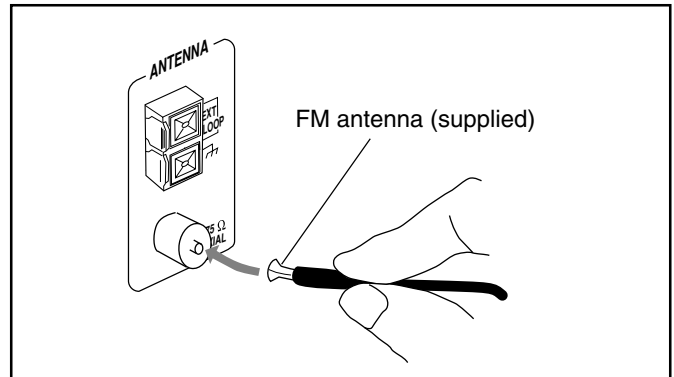

- 1 Attach the FM antenna to the FM 75 Ω COAXIAL terminal.
- 2 Extend the FM antenna.
- 3 Fasten it in the position which gives you the best reception, then fix it on the wall, etc.



About the supplied FM antenna

The FM antenna supplied with this unit can be used as temporary measure. If reception is poor, you can connect an outdoor FM antenna.

To connect an outdoor FM antenna

Before connecting it, disconnect the supplied FM antenna.

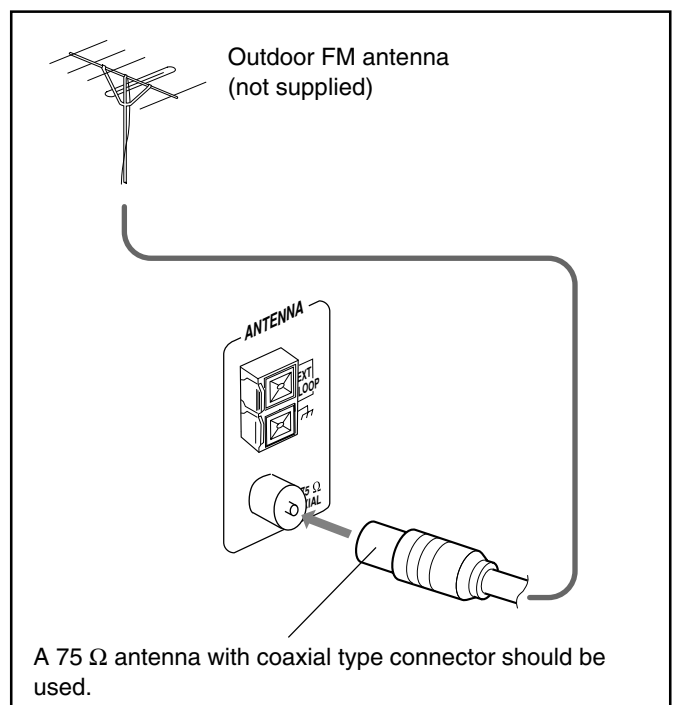

AM antenna

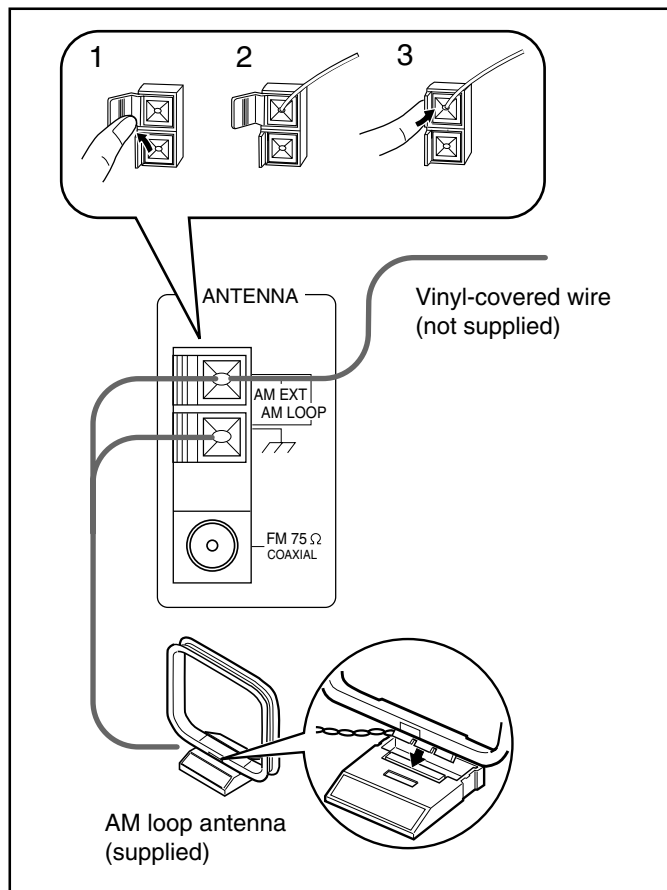

- 1** Connect the AM loop antenna to the AM LOOP terminals as illustrated.
- 2** Turn the AM loop antenna until you have the best reception.

To connect an outdoor AM antenna

When reception is poor, connect a single vinyl-covered wire to the AM EXT terminal and extend it horizontally. (The AM loop antenna must remain connected.)



For better reception of both FM and AM

- Make sure the antenna conductors do not touch any other terminals and connecting cords.
- Keep the antennas away from metallic parts of the unit, connecting cords, and the AC power cord.

Connecting Speakers

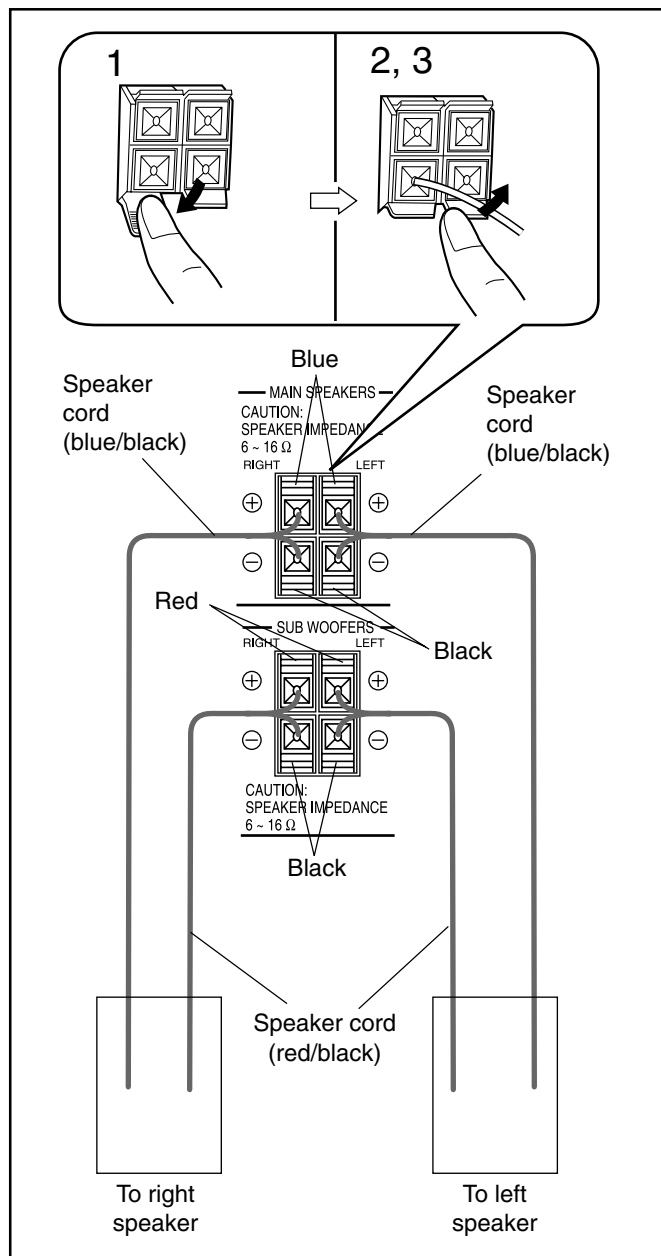

- 1** Press and hold the clamp of the speaker terminal on the rear of the unit.
- 2** Insert the end of the speaker cord into the terminal.
Match the polarity (color) of the speaker terminals: ⊕ to ⊕ and ⊖ to ⊖.
- 3** Release the finger from the clamp.

IMPORTANT: Use only speakers with the same speaker impedance as indicated by the speaker terminals on the rear of the unit.



Connecting Other Equipment

You can connect both analog and digital equipment.



- DO NOT connect any equipment while the power is on.
- DO NOT plug in any equipment until all connections are complete.

To connect an analog component

Be sure that the plugs of the audio cords are color coded: White plugs and jacks are for left audio signals, and red ones for right audio signals.

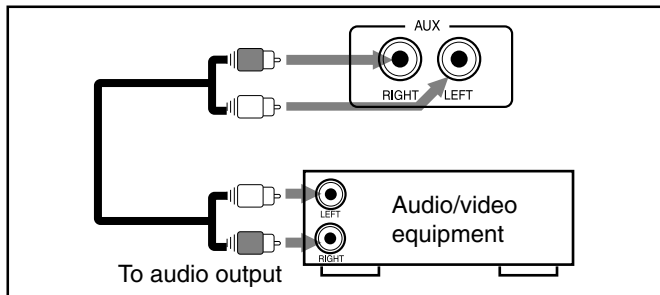

For playing the other equipment through this unit, connect between the audio output jacks on the other equipment and AUX jacks by using audio cords (not supplied). To listen to this source, press AUX.

To connect audio equipment with an optical digital input terminal

You can record CD sound onto the connected digital equipment.

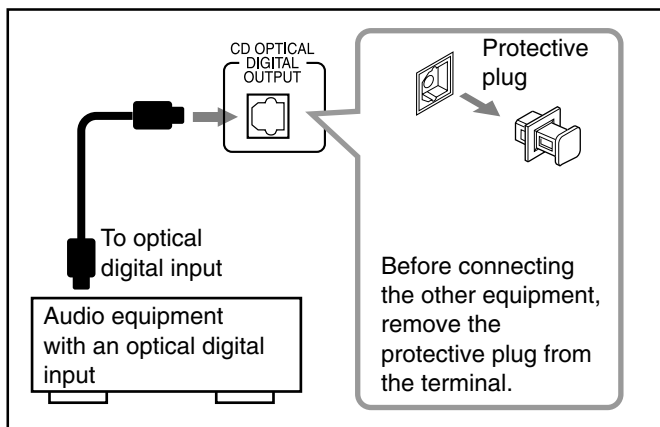

Connect an optical digital cord (not supplied) between the optical digital input terminal on the other equipment and the CD OPTICAL DIGITAL OUTPUT terminal.

To connect a TV set

You can connect a TV with a video input jack: used as a monitor for video CD playback.

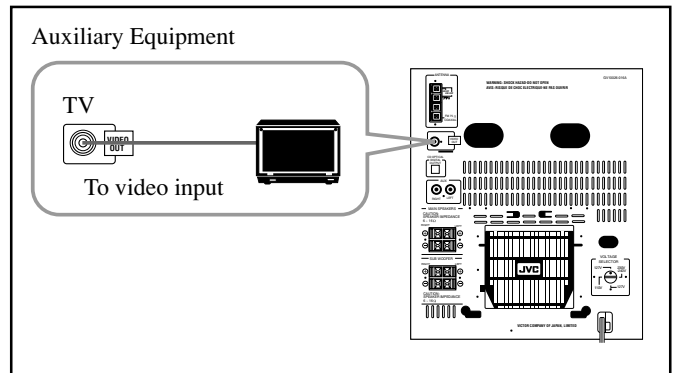

Adjusting the Voltage Selector

Before plugging in the unit, set the correct voltage for your area with the voltage selector on the rear of the unit.

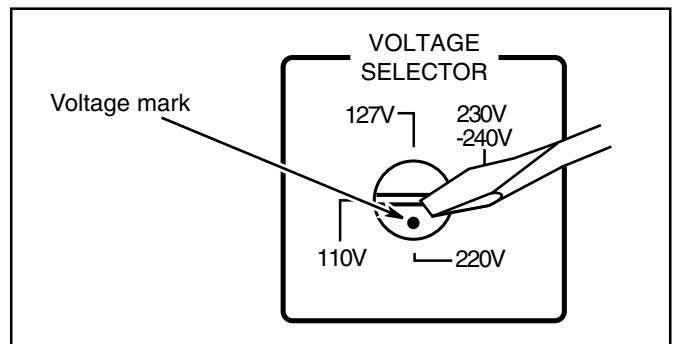

Use a screwdriver to rotate the voltage selector so the voltage number the voltage mark is pointing at is the same as the voltage where you are plugging in the unit.



- DO NOT plug in before setting the voltage selector on the rear of the unit and all connection procedures are complete.

NOW, you can plug in the unit and other connected equipment FINALLY!

When connecting the AC power cord into a wall outlet, the unit automatically starts display demonstration.

- If the wall outlet does not match the AC plug, use the supplied AC plug adaptor (except for Argentine).

To stop the display demonstration, press any button on the unit or on the remote control.

To start the display demonstration manually

Press and hold DEMO for more than 2 seconds.



To stop the demonstration, press any button.

Common Operations

Turning On and Off the Power

To turn on the unit, press so that the STANDBY lamp goes off.

WELCOME

The Powered Rolling Panel opens automatically.



To turn off the unit (on standby), press again so that the STANDBY lamp lights up

GOOD BYE

The Powered Rolling Panel also closes.

A little power is always consumed even while the unit is on standby.

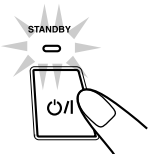

To switch off the unit completely, unplug the AC power cord from the AC outlet.



notes When you unplug the AC power cord or if a power failure occurs

The clock is reset to "0:00" right away, while the tuner preset stations (see page 12) will be erased in a few days.

Setting the Clock

Before operating the unit any further, first set the built-in clock.

On the unit ONLY:

1 Press PANEL OPEN/CLOSE.

The unit is turned on and the Powered Rolling Panel opens automatically.



2 Press CLOCK/TIMER.

0:00

The hour digits start flashing on the display.



3 Press or to adjust the hour, then press SET.

19:00

- If you want to correct the hour after pressing SET, press CANCEL. The hour digits start flashing again.

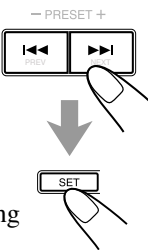

4 Press or to adjust the minute, then press SET.

CLOCK OK

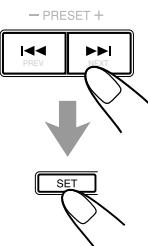

To check the clock time

Press DISPLAY while playing any source.

- Each time you press the button, the source indication and the clock time alternate on the display.

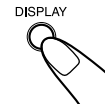

To adjust the clock again

If you have adjusted the clock before, you need to press CLOCK/TIMER repeatedly until the clock setting mode is selected.

- Each time you press the button, the clock/timer setting modes change as follows:

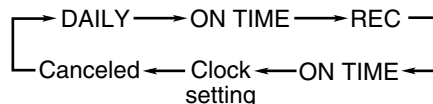

(The hour digits start flashing.)



If there is a power failure

The clock loses the setting and is reset to "0:00." You need to set the clock again.

Setting the AM Tuner Interval Spacing

Some countries space AM stations 9 kHz apart, and some countries use 10 kHz spacing.

On the unit ONLY:

You can only change the AM tuner interval spacing while tuning into an AM station.

Press while holding down .

- Each time you press the button, the AM tuner interval spacing alternates between 9 kHz and 10 kHz.

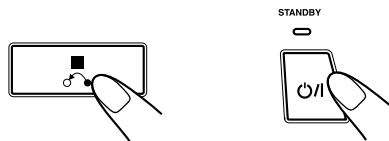

Selecting the Sources

To listen to the FM/AM broadcasts, press FM/AM. (See page 12.)

To play back CDs, press CD /II. (See pages 13 – 15.)

To play back tapes, press TAPE .

To select the external equipment as the source, press AUX.

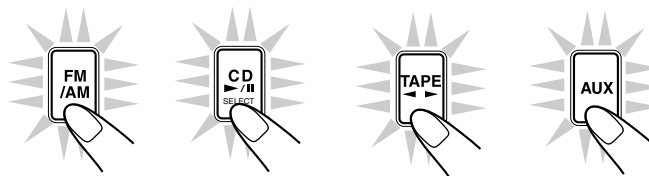

When you press the play button for a particular source (FM/AM, CD /II, AUX, and TAPE), the unit turns on, and the Powered Rolling Panel opens automatically (and the unit starts playing the source if it is ready — COMPU PLAY CONTROL).

Adjusting the Volume

You can adjust the volume level only while the unit is turned on.

Turn the VOLUME control clockwise to increase the volume or counterclockwise to decrease it.

- The volume level can be adjusted in 32 steps (MIN, VOL 1 — VOL 30, and MAX).

VOL 15

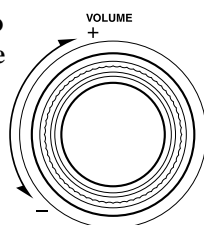

When using the remote control, press VOLUME + to increase the volume or press VOLUME - to decrease it.



For private listening

Connect a pair of headphones to the PHONES jack. No sound comes out of the speakers. Be sure to turn down the volume before connecting or putting on headphones.



DO NOT turn off (put on standby) the unit with the volume set to an extremely high level; otherwise, a sudden blast of sound can damage your hearing, speakers and/or headphones when you turn on the unit or start playing any source next time. **REMEMBER** you cannot adjust the volume level while the unit is on standby.

To turn down the volume level temporarily

Press FADE MUTING on the remote control. The volume level gradually decreases to "MIN."
To restore the sound, press the button again.



Reinforcing the Bass Sound

The SUBWOOFER VOLUME control provided for this unit can enhance the subwoofer sound if subwoofers are connected to the rear of this unit (see page 7).

This function only affects the playback sound, but does not affect your recording.

Turn the SUBWOOFER VOLUME control clockwise to increase the subwoofer sound or counterclockwise to decrease it.

- The subwoofer level can be adjusted in 6 steps (WOOFER 1 — WOOFER 5, and MAX).

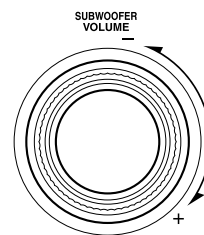

WOOFER 3

SUBWOOFER indicator always lights up when the unit is on.



When using the remote control, press SUBWOOFER + to increase the bass sound level or press SUBWOOFER - to decrease it.

Selecting the Sound Modes

You can select one of the 6 preset sound modes (3 surround modes and 3 SEA — Sound Effect Amplifier — modes). This function only affects the playback sound, but does not affect your recording.

To select the sound modes, press SOUND MODE until the sound mode you want appears on the display. The SOUND MODE indicator also lights up on the display.

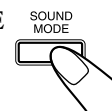

D, CLUB, HALL, STADIUM, ROCK, POP, CLASSIC, MANUAL 3, MANUAL 2, MANUAL 1

- Each time you press the button, the sound modes change as follows:

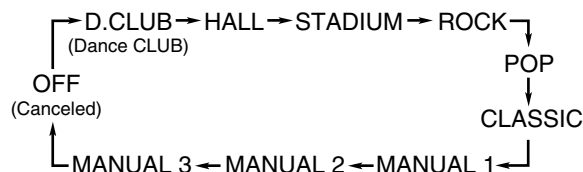

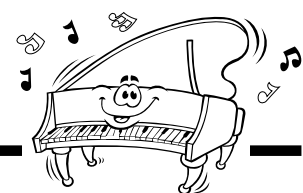

Surround modes *:

- D.CLUB:** Increases resonance and bass.
- HALL:** Adds depth and brilliance to the sound.
- STADIUM:** Adds clarity and spreads the sound, like in an outdoor stadium.

SEA (Sound Effect Amplifier) modes:



- ROCK:** Boosts low and high frequency. Good for acoustic music.
- POP:** Good for vocal music.
- CLASSIC:** Good for classical music.

Manual modes:

MANUAL 1/2/3: Your individual mode stored in memory. See “Creating Your Own Sound Mode — Manual Mode.”

OFF: Cancels the sound mode.

* Surround elements are added to the SEA elements to create a being-there feeling in your room.

When one of these modes is selected, the SOUND MODE indicator lights up as —  SOUND MODE 

When one of the SEA modes including manual modes (SEA elements without surround elements) is selected, it lights up as — **SOUND MODE**

Creating Your Own Sound Mode — Manual Mode

You can change SEA patterns to suit your preference. These changed settings can be stored in the MANUAL 1, 2, and 3 modes.

- There is a time limit for performing the following steps. If the setting is canceled before you finish, start from step 1 again.
- **If you want to add the surround elements to your SEA pattern,** select one of the surround modes (D.CLUB, HALL, or STADIUM) before starting the procedure below.

On the unit ONLY:

1 Press and hold SEA CONTROL until “SEA CONT” appears on the display. 

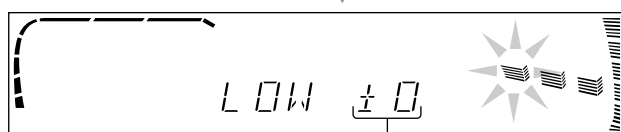

Current level appears.

2 Adjust the SEA pattern.

- 1) Press |◀◀ or ▶▶| to select the frequency range to adjust (LOW, MID, HIGH).
- 2) Press ◀◀ or ▶▶ to adjust the level (–3 to +3) of the selected frequency range.
- 3) Repeat steps 1) and 2) to adjust the level of the other frequency ranges.

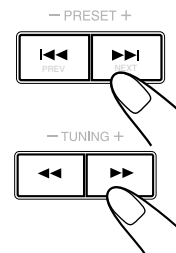

3 Press SEA CONTROL again. 



4 Press |◀◀ or ▶▶| to select one of the MANUAL 1, 2, and 3 modes into which you want to store the SEA pattern.

5 Press SEA CONTROL again. 



The SOUND MODE indicator also lights up. The SEA pattern you have created is stored into the MANUAL mode selected in the above step.

To use your own sound mode

Select MANUAL 1, 2, or 3 mode when using the sound modes. See “Selecting the Sound Modes.”



Listening to FM and AM Broadcasts

Tuning in a Station

1 Press FM/AM.

The unit automatically turns on and tunes in the previously tuned station (either FM or AM). The Powered Rolling Panel automatically opens.

- Each time you press the button, the band alternates between FM and AM.



2 Start searching for stations.

On the unit:

Press and hold TUNING - / + for more than 1 second.

On the remote control:

Press and hold ◀◀ / |◀◀ or ▶▶ / |▶▶ for more than 1 second.

The unit starts searching for stations and stops when a station of sufficient signal strength is tuned in. If a program is broadcast in stereo, the STEREO indicator lights up.

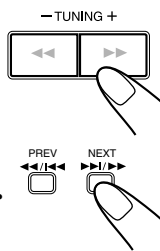

On the unit ONLY:

1 Tune in the station you want to preset.

- See "Tuning in a Station."

FM 87.50 MHz

2 Press SET.

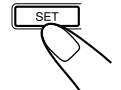

3 Press PRESET - / + to select a preset number.

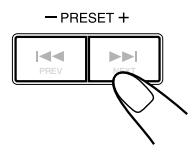

4 Press SET again.

STORE 1

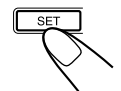

The tuned station in step 1 is stored in the preset number selected in step 3.

- Storing a new station on a used number erases the previously stored one.

To stop during searching, press TUNING - / + (or ◀◀ / |◀◀, ▶▶ / |▶▶).



When you press TUNING - / + (or ◀◀ / |◀◀, ▶▶ / |▶▶) briefly and repeatedly

The frequency changes step by step.



When you unplug the AC power cord or if a power failure occurs

The preset stations will be erased in a few days. If this happens, preset the stations again.

To change the FM reception mode

When an FM stereo broadcast is hard to receive or noisy, press FM MODE (STILL) on the remote control so that the MONO indicator lights up on the display. Reception improves.

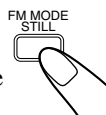

To restore the stereo effect, press FM MODE (STILL) again so that the MONO indicator goes off.

In this stereo mode, you can hear stereo sounds when a program is broadcast in stereo.

Presetting Stations

You can preset 30 FM and 15 AM stations.

In some cases, test frequencies have been already memorized for the tuner since the factory examined the tuner preset function before shipment. This is not a malfunction. You can preset the stations you want into memory by following the presetting method.

- There is a time limit for performing the following steps. If the setting is canceled before you finish, start from step 1 again.

Tuning in a Preset Station

1 Press FM/AM.

The unit automatically turns on and tunes in the previously tuned station (either FM or AM). The Powered Rolling Panel automatically opens.

- Each time you press the button, the band alternates between FM and AM.



2 Select a preset number.

On the unit:

Press PRESET - / +.

On the remote control:

Press the number buttons.

For preset number 5, press 5.

For preset number 15, press +10 then 5.

For preset number 20, press +10, then 10.

For preset number 25, press +10, +10, then 5.

For preset number 30, press +10, +10, then 10.

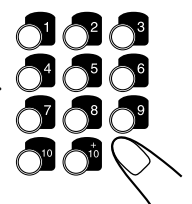
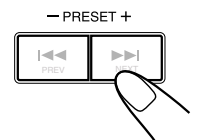

Playing Back Audio CDs

Loading CDs

On the unit ONLY:

1 Press \blacktriangle for the disc tray (CD1 to 3) you want to load a CD onto.

The unit automatically turns on and the disc tray slides out. The Powered Rolling Panel also opens automatically.

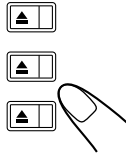

2 Place a disc correctly in the circle of the disc tray, with its label side up.

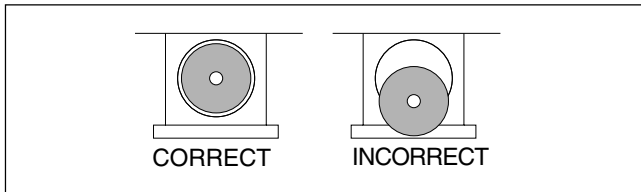

- When using a CD single (8 cm), place it in the inner circle of the disc tray.

3 Press the same \blacktriangle you have pressed in step 1.

The disc tray closes, and the corresponding disc indicator (CD1 to CD3) lights up on the display.

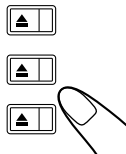

4 Repeat steps 1 to 3 to place other CDs.



When loading one CD after another

When you press \blacktriangle for the next tray you want to place another CD onto, the first disc tray automatically closes and the next tray slides out.



About the disc indicators

Each disc indicator corresponds to the disc tray of the same number.

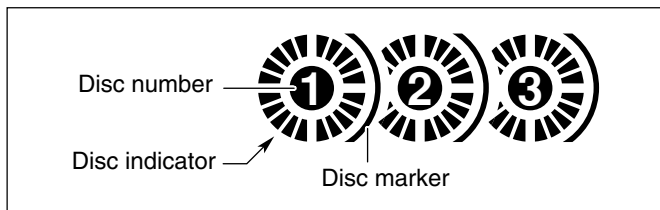

- The disc marker lights up for the disc number you have selected.
- The disc indicator flashes while the corresponding CD is being played.
- The disc indicator goes off when the unit has detected that there is no CD on the corresponding disc tray.

Playing Back Several Discs — Continuous Play

You can play CDs continuously.

1 Load the CDs.

2 Press one of the disc number buttons (CD1, CD2, and CD3) for the disc you want to start play from.

CD play starts from the first track of the selected disc.

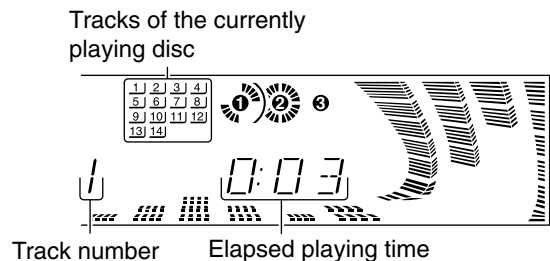
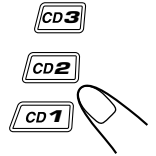

- Pressing CD \blacktriangleright /|| instead of the disc number buttons starts play back if a CD is on one of the trays.

To stop during play, press \blacksquare \odot .

To remove a disc, press \blacktriangle for the corresponding disc tray.



CD playback sequence

When 3 CDs are loaded on the disc trays, they are played in one of the following sequences.

- When CD1 is pressed : CD1 \Rightarrow CD2 \Rightarrow CD3 (then stops)
- When CD2 is pressed : CD2 \Rightarrow CD3 \Rightarrow CD1 (then stops)
- When CD3 is pressed : CD3 \Rightarrow CD1 \Rightarrow CD2 (then stops)

* When only 2 CDs are loaded, they are played in the same order, but the disc tray without a CD is skipped.

Basic CD Operations

While playing a CD, you can perform the following operations.

To exchange CDs during playback of another disc

Press \blacktriangle corresponding to a CD, not playing or selected currently, to eject and exchange the CD.

If you exchange CDs during play, the current play will not stop until all CDs you have exchanged are played.

To stop play for a moment

Press CD \blacktriangleright /||.

While pausing, the elapsed playing time flashes on the display.

To resume play, press CD \blacktriangleright /|| again.



To locate a particular point in a track

During play, press and hold ◀◀ or ▶▶.

- ◀◀: Fast reverses the disc.
- ▶▶: Fast forwards the disc.

When using the remote control, press and hold ◀◀ / ◀◀ or ▶▶ / ▶▶.

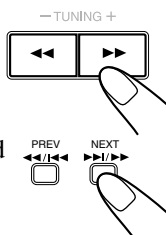

To go to another track

Press ◀◀ or ▶▶ repeatedly before or during playback.

- ◀◀: Goes back to the beginning of the current or previous tracks.
- ▶▶: Skips to the beginning of the next or succeeding tracks.

When using the remote control, press ◀◀ / ◀◀ or ▶▶ / ▶▶.

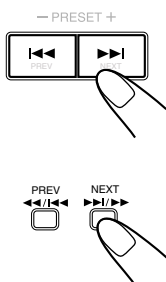

If you press and hold ◀◀ / ▶▶ (or ◀◀ / ◀◀ or ▶▶ / ▶▶) before playing)

You can change the tracks continuously.

On the remote control:

To go to another track directly using the number buttons

Pressing the number button(s) before or during play allows you to start playing the track number you want.

Ex.: For track number 5, press 5.

For track number 15, press +10, then 5.

For track number 20, press +10, then 10.

For track number 32, press +10, +10, +10, then 2.

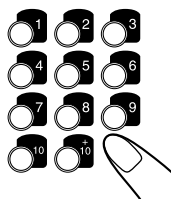

Programming the Playing Order of the Tracks — Program Play

You can program the order in which the tracks play before you start playing. **You can program up to 32 tracks.**

- To use Repeat play (see page 15) for Program play, press REPEAT after starting Program play.

1 Load the CDs.

- If the current playing source is not the CD player, press CD ▶/⏸, then ■ ⏸ before going to the next step.

2 Press PROGRAM/RANDOM repeatedly until “PROGRAM” appears on the display.

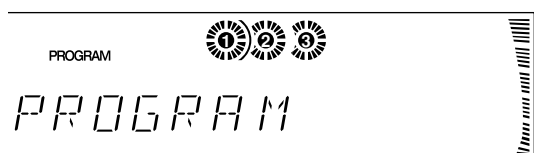

- If a program has been stored in memory, the program is called up.

- Each time you press the button, CD play mode changes as follows:

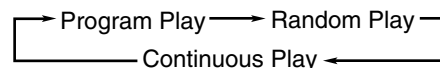

3 Press one of the disc number buttons (CD1, CD2, and CD3) to select the disc number you want to play.

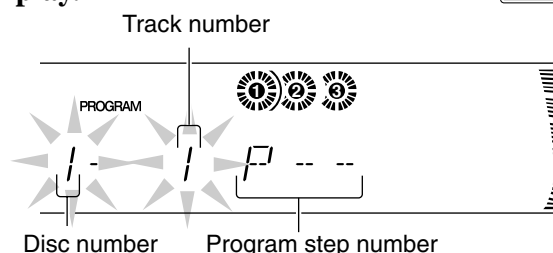

4 Select a track from the CD selected in the above step.

On the unit:

Press ◀◀ or ▶▶ to select the track number, then press SET.

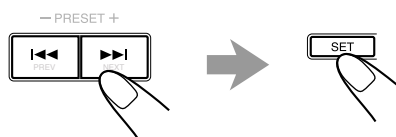

On the remote control:

Press the number buttons.

- For how to use the number buttons, see “To go to another track directly using the number buttons” described to the left.

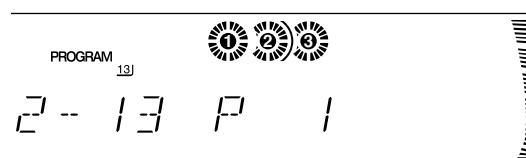
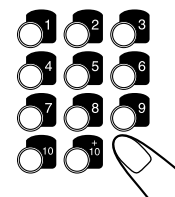

5 Program other tracks you want.

- To program tracks from the same disc, repeat step 4.
- To program tracks from a different disc, repeat steps 3 and 4.

6 Press CD ▶/⏸.

The tracks are played in the order you have programmed.

To stop during play, press ■ ⏸.

To exit from Program play mode, press PROGRAM/RANDOM repeatedly again before or after play so that the unit enters another play mode. (The program you have made is stored in memory until you turn off the unit for a few days or erase the program.)



To check the program contents

Before playing, you can check the program contents by pressing ◀◀/|◀◀ or ▶▶|/▶▶ on the remote control.

- ▶▶|/▶▶: Shows the programmed tracks in the programmed order.
- ◀◀/|◀◀: Shows them in the reverse order.

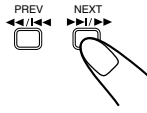

To modify the program

Before playing, you can erase the programmed tracks shown on the display by pressing CANCEL.

- Each time you press the button, the programmed track shown on the display is erased from the program.



To add tracks in the program before play, simply select the track numbers you want to add by following step 4 of the programming procedure on page 14.

To erase the entire program before or after play, press ■ Ⓞ. "PROGRAM" appears on the display.

- Ejecting a CD will also erase the track numbers programmed from the ejected CD.



If you try to program a 33rd track "FULL" will appear on the display.



If your entry is ignored

You have tried to program a track from an empty tray, or a track number that does not exist on the CD (for example, selecting track 14 on a CD that only has 12 tracks). Such entries are ignored.

Playing at Random — Random Play

The tracks of all loaded CDs will play at random.

- To use Repeat play for Random play, press REPEAT after starting Random play.

1 Load CDs.

- If the current playing source is not the CD player, press CD ►/||, then ■ Ⓞ before going to the next step.

2 Press PROGRAM/RANDOM repeatedly until "RANDOM" appears on the display.

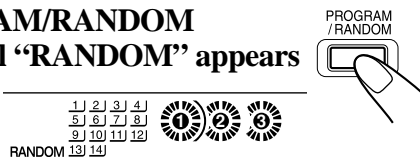

- Each time you press the button, CD play mode changes as follows:

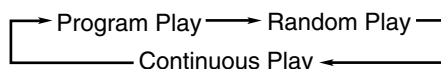

3 Press CD ►/||.

The tracks are played at random. Random play ends when all the tracks are played once.

To skip the currently playing track, press ▶▶| (or ▶▶|/▶▶ on the remote control).



To stop during play, press ■ Ⓞ.

- Random play also stops when one of the disc trays is opened.

To exit from Random play mode, press PROGRAM/RANDOM repeatedly again before or after play so that the unit enters another play mode.



Even if you press |◀◀ (or ◀◀/|◀◀ on the remote control)

You cannot go back to the previous tracks during Random play.

- If you press ▶▶| (or ▶▶|/▶▶| on the remote control), you can go to next random tracks.
- RANDOM PLAY starts playing from the current tray and then subsequently to the next tray when all the tracks from the current tray are finished.

Repeating Tracks or CDs — Repeat Play

You can have all the CDs, the program or the individual track currently playing repeat as many times as you like.

To repeat play, press REPEAT during or before playing. To use Repeat play for Program play and Random play, press the button after starting playback.

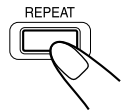

- Each time you press the button, Repeat play mode changes as follows, and the following indicator lights up on the display:

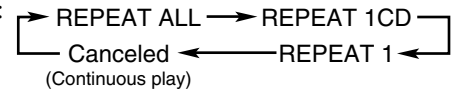

REPEAT ALL: Repeats all the tracks on all the CDs (continuously or at random), or all the tracks in the program.

REPEAT 1CD*: Repeats all the tracks on one CD.

REPEAT 1: Repeats one track on one CD.

* REPEAT 1CD is not used for Program play and Random play.

To cancel Repeat play, press REPEAT repeatedly until the REPEAT indicator (REPEAT ALL, REPEAT 1CD, or REPEAT 1) goes off from the display.

- Repeat play is also canceled when you select Program play or Random play.

Prohibiting Disc Ejection — Tray Lock

You can prohibit CD ejection from the unit and can lock CDs.

- This operation is possible only using the buttons on the unit.

To prohibit disc ejection, press ▲ for any disc tray while holding ■ Ⓞ. (If there is any disc tray opened, close it first.) "LOCKED" appears for a while, and the loaded CDs are locked.

To cancel the prohibition and unlock the CDs, press ▲ for any disc tray while holding ■ Ⓞ.

"UNLOCKED" appears for a while, and the loaded CDs are unlocked.



If you try to eject CDs

"LOCKED" appears to inform you that the Tray Lock is in use.

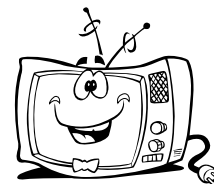

Playing Back Video CDs/SVCDs

Selecting Video Output (PAL, MULTI, NTSC)

Video output is preset for PAL.

To playback images correctly on your TV, select the video output according to your TV system, select the proper video output using the buttons on the Unit before you play a disc.

1 At standby mode.

2 Press a disc number button for more than 2 sec.

CD3 for NTSC exclusive TV.

CD2 for Multisystem TV.

Multi detects the formula of the disc (NTSC/PAL) automatically and displays the image on the screen correctly.

CD1 for PAL exclusive TV.

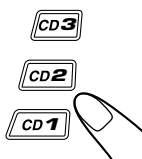

Selection of video output mode

- Select the video output mode before you play the disc.
- When you play an NTSC disc in MULTI mode on a PAL exclusive TV, the image may be distorted. If this happens, change the mode to PAL.
- When you play an NTSC disc in MULTI mode on a Multisystem TV, the image may blink for a moment. This symptom is caused by the Unit detecting the formula of the disc, not by a malfunction of the unit.
- Selection of video output mode works only in standby mode.

Loading CDs

1 Press \blacktriangle on the CD Player corresponding to the tray you want to insert the disc into.

“CD OPEN” appears on the display and the disc tray slides out.

CD OPEN

Compu Play

When \blacktriangle is pressed while the power is on standby, the power is automatically turned on.

2 Place a CD, with its label side up, onto the tray.

ATTENTION: To avoid malfunctions when you play a CD, set the CD in the right place at the center of the tray.

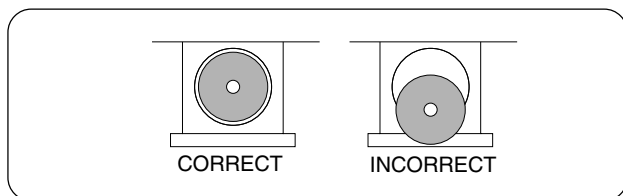

3 Press \blacktriangle to close the tray.

“CD CLOSE” appears on the display.

CD CLOSE

4 Repeat steps 1 to 3 to place other discs onto the other trays.

To continue putting discs onto other trays, even if a tray is open, by pressing the \blacktriangle button of another disc tray, the open tray will close automatically, and the new tray will slide out.

When you place a CD onto the currently selected tray, whose disc number shown on the CD indicator, reading of the CD starts. After the reading is completed, the total number of tracks and total playing time will appear, then the playing time of the first track.

CD 1 → 14 67:44 → 1 5:40
 READING NOW Total number of tracks and playing time Playing time of the 1st track

If you place a video CD, “VIDEO CD” will appear before the playing time of the first track. If the video CD has the Playback Control function, when you press STOP followed by PBC, “VCD PBC” will appear.

To put an 8 cm CD onto a tray, insert it so that it is aligned with the groove in the tray's center.

If a tray is open when the System switches to the standby mode, the tray will close automatically.

Playing a Video CD

You can play video CDs either with or without the PBC function.

1 Turn on the TV and select the video input so that you can view the pictures from the CD player.

Refer to the manual supplied for your TV.

2 Prepare a CD.

Refer to “Loading CDs” on this page.

3 Start playback of the CD.

Press CD \blacktriangleright /|| to start playback of the currently selected CD, or press CD 1-3 to select the disc and start play.

When you play a Video CD, “VIDEO CD” appears on the display.

When you play a Super VCD, “SVCD” appears on the display.

VIDEO CD

Compu Play

When CD \blacktriangleright /|| or CD 1-3 is pressed while the system is on standby, the power is automatically turned on.

To stop during play, press \blacksquare \odot .

To stop play and remove the disc, press \blacktriangle for the disc being played.

Playing Video CDs/SVCDs with PBC Function- Menu Play

This System provides Playback Control (PBC) which utilizes a procedure (menu selection) programmed in a video CD. The playback operation procedure may differ depending on the disc you use.

For Menu Play, use the following buttons:

On the unit:

- NEXT (▶▶) for viewing the unshown portion of the menu
- PREV (◀◀) for viewing the previously shown portion of the menu
- VCD NUMBER +, - for selecting an item
- SELECT (CD ▶/||) ... for starting playback of the selected item
- ⏪ for going back to the previous menu

On the remote control:

- NEXT (▶▶/▶▶▶) for viewing the unshown portion of the menu
- PREV (◀◀/◀◀◀) for viewing the previously shown portion of the menu
- NUMBER BUTTONS .. for selecting and starting playback of an item
- SELECT (CD ▶/||) ... for starting playback of the selected item
- ⏪ for going back to the previous menu

Basic Concept of the PBC function

PBC (Playback Control) allows you to enjoy menu -driven operation and high resolution still images having a resolution four times greater than video pictures.

Menu-driven playback

You can interact with the screen using a menu display to select and play an entry.

1 Turn on the TV and select the video input so that you can view the pictures from the CD Player.

Refer to the manual supplied for your TV.

2 Prepare a CD.

Refer to "Loading CDs" on page 16.

3 Press PBC on the unit after allowing a few seconds for the disc to be read.

Allow several seconds for the disc's table of contents (TOC) to be read before pressing PBC. "VCD PBC" appears on the display.

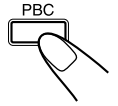

VCD PBC

4 Start playback of the CD.

Press CD ▶/|| to start play of the currently selected CD, or press CD 1-3 to select the disc and start play.

5 Select the item you want to view.

On the unit:

Press VCD NUMBER + to select larger item numbers, or press VCD NUMBER - to select smaller item number. Then press CD ▶/|| to start the disc.

On the remote control:

Press the number buttons to select and play the item you want.

To stop the track being played and return to the menu, press ■ ⏪ button.

To stop Menu Play, press and hold ■ ⏪ for more than 2 seconds. A blue screen appears on the TV.

NOTE: You can only select PBC in CD STOP position.

High -resolution still image display

You can display high-quality images four times clearer than video pictures.

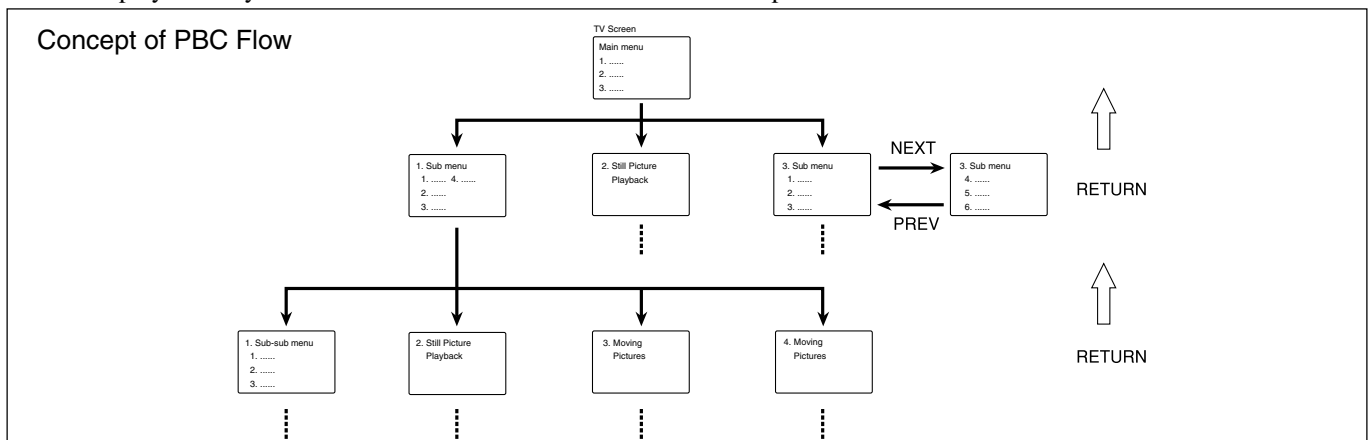

Basic flow of Menu Play Operation

A selection menu is shown when you start playing a video CD with PBC. The menu shows a list of items to select.

Some discs may show moving pictures or a divided screen.

- When a list of items appears, you can select the number of the item you want to play back.
- When moving pictures appear, you can select a moving picture by pressing ◀◀/▶▶/▶▶▶ or number buttons while the moving picture you want to view is being played back.

- When the menu appears after the item you have selected finishes playing, you can select another item that you want to view next.
- After playback, press ■ ⏪ to go back to the previous screen. Each time you press the button, you will go back by one screen.
- If you want to stop Menu Play, press and hold ■ ⏪ for more than 2 seconds. Some discs may return you to the menu screen shown before playback.



Screen-saver

- When a menu screen of karaoke disc is display for about a few minutes without any selection being made, it automatically starts from a first song.
- If a Video CD/Super Video CD is paused for about 10 minutes, the screen background automatically fades out to prevent screen burn in while the setting is suspended.

Playing Video CDs/SVCDs without PBC – Continuous Play

Even if a video CD has PBC, you can cancel PBC and play the disc without using the menu screen.

1 Turn on the TV and select the video input so that you can view the pictures from the CD Player.

Refer to the manual supplied for your TV.

2 Prepare a CD.

Refer to “Loading CDs” on page 16.

3 Start playback of the CD.

On the unit:

Press CD ►/|| or CD 1-3 of the tray you want to play from. The selected video CD starts playback from the first track.

On the remote control:

Press the number button of the track you want to start playing. The playback starts from the selected track of the currently selected disc.

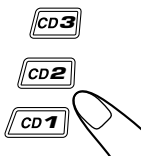

To stop during play, press ■ Ⓞ.

To restore PBC, press the PBC button again.

Then press current CD1, CD2 or CD3 to play VCD with PBC.



Cancelling PBC

- After cancelling PBC, you can Continuously Play more than one video CD without PBC.
- When PBC is cancelled, some images such as still play pictures may not be played back.
- You cannot change from PBC OFF to PBC ON while CD is playing.

Reminder!

Disconnect your CD OPTICAL DIGITAL OUTPUT when playing or recording a Video CD or SVCD.

Resuming Play

If you stop a video CD or Super Video CD (SVCD) directly, you can continue viewing from the scene where you last stopped.

1 During playing a VCD or SVCD, press ■ Ⓞ button to stop playing. (refer to page 16)

2 Press CD ►/|| button to continue playback from the last scene that you stopped at.

NOTE:

- 1 Resume play will not work when the CD tray has been opened.
- 2 It is advisable to turn off PBC to use resuming play if not it will resume at PBC menu.

Special Plays for a Video CD

You can use the following special play modes for video CDs both with and without PBC. The following functions can only be executed with the buttons on the remote control.

Frame-by-Frame Playback

Press CD ►/|| then the STILL key during playback.

When you press the button first, play pauses and you see a still picture on the TV screen. Then each time you press the button, still pictures advance by one frame. During frame-by-frame playback, no sound is emitted.

To resume normal playback, press CD ►/||.

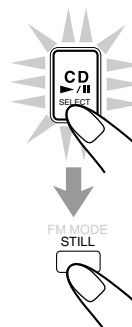

Viewing Operating Status

Usually, the following information of the track being played is shown on the TV screen during playback: the disc number, the track number, and the playing time.

Press ON SCREEN.

This button toggles the display of operation status. When the display of operation status turns on, the following information of the track being played appear on the TV screen briefly: MPX mode and key control.

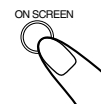

The TV screen will show the following:

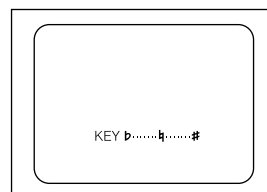

To cancel the display of operation status, press ON SCREEN “DISP. OFF” appears on the TV screen briefly and all the information about the track being played disappears.

Viewing the Video Intro of the Video CD

You can view the contents of a video CD, watching first 5 seconds of each track on the video CD. Video intro does not work with PBC. For a video CD with PBC, cancel the PBC function referring to “Playing CDs/SVCDs without PBC” above.

1 Press CD 1-3 to select the disc you want to view the video intro of.

Playback starts.

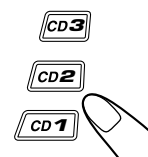

2 Press V.INTRO on the remote after a picture appears on the TV screen.

The video intro play starts and shows in sequence, the first 5 seconds of nine tracks on the TV screen. If the CD consists of more than 9 tracks, tracks above 9 will be shown after the first 9 tracks.



The TV screen will show the following:

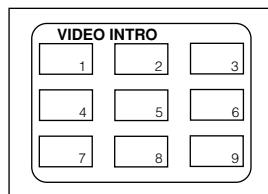

3 Press the number button for the video intro you want to select.

Playback starts from the selected track.

To stop and cancel the video intro play, press ■ ⏻.

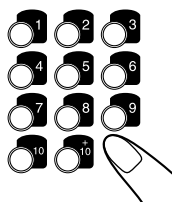

Viewing the Highlights of a Video CD

You can view highlight scenes of the selected track on a video CD only when PBC is off. These highlight scenes are created by dividing the track equally into 9 portions and the beginning scenes (5 seconds each) of those 9 portions are shown on the display.

1 Press CD 1-3 and the number button for the track you want to view the highlights of.

Playback starts.

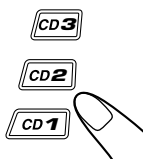

2 Press HIGHLIGHT on the remote after a picture appears on the TV screen.

The highlight play starts and shows in sequence, the first 5 seconds of nine track divisions on the TV screen for 1 minute. If a highlight scene is not selected, it will automatically stop after a few minutes.



TV screen will show the following:

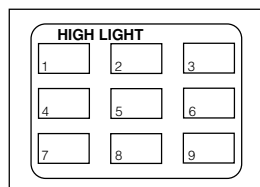

3 Press the number button for the highlight you want to select.

Playback starts from the selected scene.

To stop and cancel the highlight play, press ■ ⏻ button.

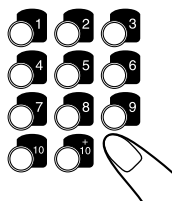

Viewing highlights

- If a highlight scene is not selected while 9 scenes are shown on the TV, highlight scenes of the next track will appear on the display.
- When a highlight scene is selected, playback starts from the beginning of the highlight scene, but not from the still image shown on the display (the part shown is the last part of the highlight scene, not its beginning)
- During the video intro or highlight play, images shown on the display may be partially distorted, resulting from noise or incorrect manufacturing of the disc.

Playing a Multiplex Sound CD

This function is used for multiplex sound discs. See manuals attached to discs for detailed information.

Operation

By pressing the MPX button consecutively, channel multiplexing modes are cycled as shown below.

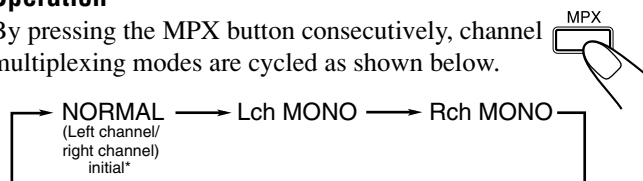

When Lch MONO or Rch MONO is selected, display indicates Lch MONO or Rch MONO respectively.

Lch MONO: Only the left channel (instrumental parts) is played back through both right and left speakers.

Rch MONO: Only the right channel (vocal parts) is played back through both right and left speakers.

NORMAL: Used for conventional stereo sources.

When playing back a SVCD (Super Video CD):

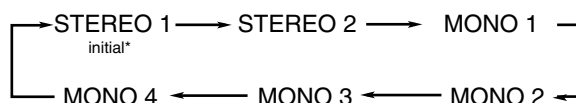

MPX sound modes

Note that you can hear no audible sound in the STEREO 2, MONO 3 and MONO 4 positions if no audio is recorded on STEREO 2.

Initial*: Whenever you change a CD or when you select another CD tray, MPX will be reset to the initial mode.

Using SUBTITLES

Effective only when playing back all SVCD (Super Video CD). SVCD discs may have up to four subtitles which you can select to view on the TV screen (as an optional feature). Pressing the SUBTITLE button (on the remote) cycles the subtitle as shown below:

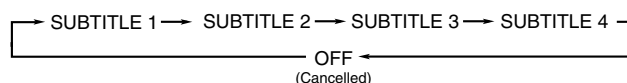

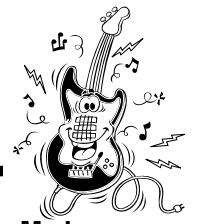

Playing Back Tapes

You can play back type I, type II, and type IV tapes without changing any settings.

Playing Back a Tape

- 1 Press EJECT (▲) for the deck you want to use.**

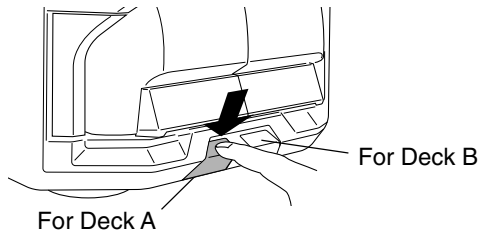

- 2 Put a cassette in, with the exposed part of the tape down.**

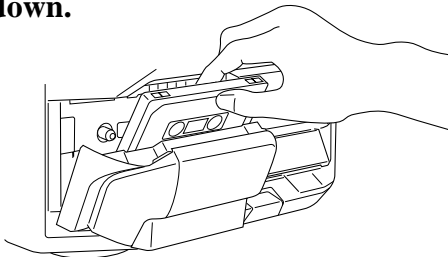

- 3 Close the cassette holder gently.**

If you put cassettes in both decks A and B, the last deck you have put a cassette into is selected.

To operate the other deck, press TAPE A/B.

- 4 Press TAPE ◀▶.**

The tape play starts and the tape direction indicator (◀▶) starts flashing slowly to indicate the tape running direction.

- Each time you press the button, the tape direction changes.

- ▶ : plays the front side.
- ◀ : plays the reverse side.



When the tape plays to the end, the deck automatically stops if the Reverse Mode is not on. (See “To play both sides repeatedly — Reverse Mode.”)

To stop during play, press ■ ●.

To operate the other deck, press TAPE A/B, then TAPE ◀▶.

To fast wind to the left or to the right, press ◀◀ / ▶▶ (◀◀ / |◀◀ or ▶▶ / ▶▶ on the remote control) while the tape is not running.

The tape direction indicator (◀▶) starts flashing quickly on the display.

To remove the cassette, press ▲ EJECT for deck A or EJECT ▲ for deck B.

To play both sides repeatedly — Reverse Mode

Reverse Mode works for both decks at the same time.

When it is in use, the tape automatically reverses at the end of a side and the unit starts playing the other side of the tape, and repeats the same process.

To use Reverse Mode, press REVERSE MODE so that the Reverse Mode indicator on the display lights up like — (↻)

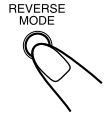

To cancel Reverse Mode, press the button again so that the Reverse Mode indicator on the display lights up like — → ←



When Reverse Mode is on with cassettes in both decks A and B

After the reverse (◀) side of the tape finishes playing, the tape in the other deck starts playing.

Locating the Beginning of a Song — Music Scan

You can use Music Scan to locate the beginning of a song. Music Scan searches for blank portions that usually separate recorded songs, then plays the next song.

To find the beginning of the current song

During play, press ◀◀ / ▶▶ (◀◀ / |◀◀ or ▶▶ / ▶▶ on the remote control) in the opposite direction to the tape play.

The tape direction indicator of the opposite direction to the tape play starts flashing slowly.

Searching stops automatically at the beginning of the current song, and the current song starts automatically.

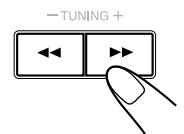

To find the beginning of the next song

During play, press ◀◀ / ▶▶ (◀◀ / |◀◀ or ▶▶ / ▶▶ on the remote control) in the same direction as the tape play.

The tape direction indicator of the same direction as the tape play starts flashing slowly and quickly alternately.

Searching stops automatically at the beginning of the next song, and the next song starts automatically.

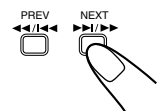

Music Scan works by detecting a 4-second long blank between each song, so it will not work well in the following cases

- No blank at the beginning of a song.
- Noise (often caused by much use or poor quality dubbing) which fills the blank.
- Long, very soft passages or pauses in a song.



The use of the C-120 or thinner tape is not recommended, since characteristic deterioration may occur and this tape easily jams in the pinch-rollers and the capstans.

Recording

IMPORTANT:

- It may be unlawful to record or play back copyrighted material without the consent of the copyright owner.
- The recording level is automatically set correctly, so it is not affected by the VOLUME control and the SUBWOOFER VOLUME control. Thus, during recording you can adjust the sound you are actually listening to without affecting the recording level.
- While recording, you can hear sound modes through the speakers or headphones. However, the sound is recorded without these effects (see page 10).
- If recordings you have made have excessive noise or static, the unit may be too close to a TV. Increase the distance between the TV and the unit.
- You can use type I and II tapes for recording.

To protect your recording

Cassettes have two small tabs on the back to prevent accidental erasure or re-recording.

To protect your recording, remove these tabs.

To re-record on a protected tape, cover the holes with adhesive tape.

When using type II tape, be careful not to cover the holes used to detect the tape type.



To keep the best recording and playback sound quality

If the heads, capstans, and pinch rollers of the cassette decks become dirty, the following will occur:

- Impaired sound quality
- Discontinuous sound
- Fading
- Incomplete erasure
- Difficulty in recording

To clean the heads, capstans, and pinch rollers

Use a cotton swab moistened with alcohol.

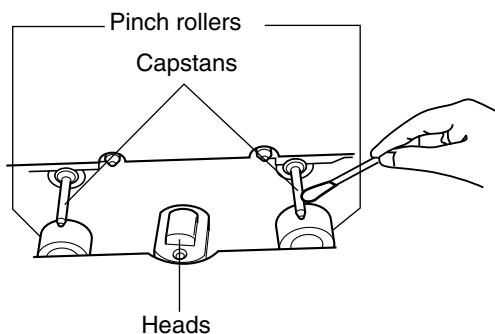

To demagnetize the heads

Turn off the unit, and use a head demagnetizer (available at electronics and record shops).

Recording a Tape on Deck B

1 Press EJECT ▲ for deck B.

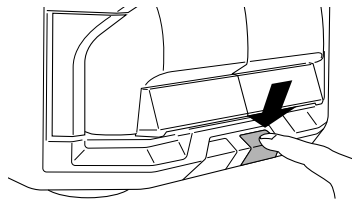

2 Put in a recordable cassette, with the exposed part of the tape down.

3 Close the cassette holder gently.

4 Check the tape direction of deck B.

- If the tape direction is not correct, press TAPE ◀▶ twice then ■ ⚙ to change the tape direction.

5 Start playing the source — FM, AM*, CD player, deck A, or auxiliary equipment connected to AUX jacks.

- When the source is CD, you can also use CD Direct Recording (see page 22) and Auto Edit Recording (see page 23).
- When the source is deck A, you can also use the dubbing method. (See “Dubbing Tapes” on page 22.)

* See “To record an AM station — Beat Cut” on page 22.

6 Start recording.

On the unit:

Press REC START/STOP.

On the remote control:

Press and hold REC START/STOP for more than 1 second.

The REC (recording) indicator lights up on the display and recording starts.

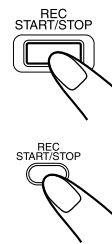

To stop during recording, press REC START/STOP again or ■ ⚙.

To remove the cassette, press EJECT ▲ for deck B.

To record on both sides — Reverse Mode

Press REVERSE MODE so that the Reverse Mode indicator lights up as — (↔)

- When using the Reverse Mode for recording, start recording in the forward (▶) direction first. Otherwise, recording will only be done on one side (reverse) of the tape.

To cancel Reverse Mode, press the button again so that the Reverse Mode indicator lights up as — →



To record an AM station — Beat Cut

While recording an AM broadcast, beats may be heard (which are not heard when listening to the broadcast without recording it).

If this occurs, press PROGRAM/RANDOM repeatedly, while recording, until the beats are reduced.

- Each time you press the button, the display changes to show the following:



Dubbing Tapes

It is preferable that the tape type (type I or II) you record from be the same as the tape type you record onto when dubbing tapes.

- 1 Press TAPE ◀▶, then ■ ⏸.

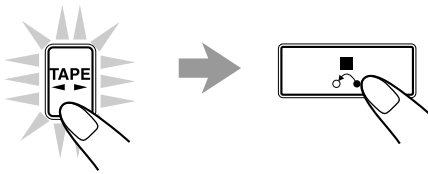

- 2 Put the source cassette in deck A, and a recordable cassette into deck B.

- Put the cassettes in both decks so that the tapes will run in the forward (▶) direction.

- 3 Press DUBBING.

Dubbing starts.

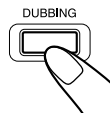

To stop during dubbing, press ■ ⏸.

To record on both sides — Reverse Mode

Press REVERSE MODE so that the Reverse Mode indicator lights up as — (↔)

To cancel Reverse Mode, press the button again so that the Reverse Mode indicator lights up as — → ←



CD Direct Recording

Everything on the CD goes onto the tape in the same order as it is on the CD, or according to the order you have specified for Program play.

- 1 Put a recordable cassette into deck B.
- 2 Place a disc correctly in the circle of the disc tray, with its label side up.
- 3 Press one of the disc number buttons (CD1 to CD3) to select the disc, then ■ ⏸.

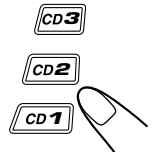

- 4 Press CD REC START.

“CD REC” appears, and the REC (recording) indicator lights up on the display.

Deck B starts recording and the CD player starts playing. When the recording is done, “CD REC FINISHED” appears on the display, and the CD player and deck B stop.

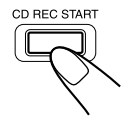

To stop during CD Direct Recording, press ■ ⏸ or REC START/STOP.

To record on both sides — Reverse Mode

Press REVERSE MODE so that the Reverse Mode indicator lights up as — (↔)

- When using the Reverse Mode for CD Direct Recording, start recording in the forward (▶) direction first. When the tape reaches its end while recording a song in the forward direction (▶), the last song will be recorded at the beginning of the reverse side (◀). If you start recording on the reverse side (◀), recording will be done only on one side (reverse) of the tape.

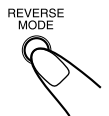

To cancel Reverse Mode, press the button again so that the Reverse Mode indicator lights up as — → ←



Auto Edit Recording

By using Auto Edit Recording, you can record the CD tracks to fit the tape. Auto Edit Recording makes a program by selecting the CD tracks in numerical order. However, to prevent the end of the last track on the front side from being cut off, the last track is selected so as to fit on the remaining tape length.

On the unit ONLY:

1 Load CDs.

- If the current playing source is not the CD player, press CD ►/II, then ■ ⏸ before going to the next step.

2 Press EDIT.

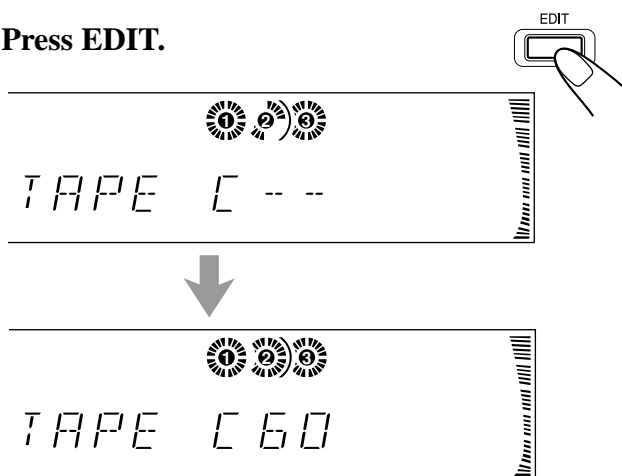

The optimum tape length for the disc appears.

NOTE:

Auto edit can only be applied for current playing CD.

To change the tape length manually

If the tape length selected is not satisfactory, you can change the tape length by pressing ◀◀ or ▶▶.

You can select the tape length among the following — 40, 46, 50, 54, 60, 64, 70, 74, 80, 84, and 90.

3 Press SET.

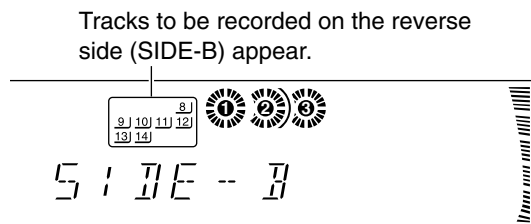

- Pressing the button alternates between, the tracks to be recorded on the front side (SIDE-A) and on the reverse side (SIDE-B).

4 Put a recordable cassette of appropriate length into deck B.

5 Press REVERSE MODE so that the Reverse Mode indicator lights up as (↻).

- Without turning on the Reverse Mode (↻), recording will stop when the front side of the tape is recorded.

6 Press CD REC START.

The REC (recording) indicator lights up on the display.

Deck B starts recording then, about 10 seconds later, the CD player starts playing.

When the recording is done, “CD REC FINISHED” appears on the display, and the CD player and deck B stop.

- If a tape has not been rewound, deck B will rewind the tape before it starts recording.
- A 10-second blank portion is automatically created at the beginning of each side of the tape.

To stop during Auto Edit Recording

Press ■ ⏸ or REC START/STOP so that a 4-second blank portion is created on the recorded tape. (Remember a 4-second blank is important when using Music Scan — see page 20.)

To cancel Auto Edit Recording

Press CANCEL before or after play.

- Pressing one of the following buttons will also cancel Auto Edit Recording — ■ ⏸ and REC START/STOP.



Using the Microphones

You can enjoy singing along (Karaoke) and microphone mixing using two microphones.

- The MIC LEVEL control adjustment is valid for both microphones connected to the MIC 1 and MIC 2 jacks.

IMPORTANT:

- Always set the MIC LEVEL to MIN when connecting or disconnecting the microphone.
- When you are not using the microphones, disconnect them.

Singing Along

Vocal Masking

Vocal Masking reduces the lead vocal of the playing source, and allows you to replace it by singing into the microphones as the music plays.

On the unit ONLY:

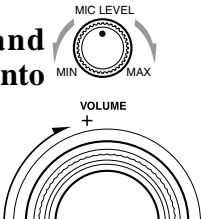
- 1 Rotate the MIC LEVEL to MIN. 
- 2 Connect the microphone(s) (not supplied) by plugging it into the MIC 1 and/or MIC 2 jack.
- 3 Press VOCAL MASKING on the remote control.  The karaoke indicator (🎤) lights up on the display.
- 4 Start playing the source — CD, tape, or other connected component.
- 5 Rotate the MIC LEVEL and VOLUME controls as you sing into the microphone(s). 
 - By pressing REC START/STOP, you can record your singing along if you want. (For more details, see page 21.)

To apply an echo to your voice

Press ECHO on the remote control so that the echo (🔊) indicator lights up on the display.

Each time you press the button, the echo level changes as follows:

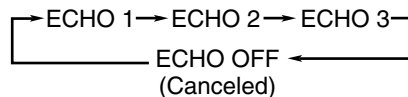

As the number increases, a stronger echo effect is applied to your voice.

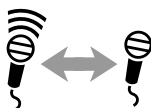

notes If howling or squealing (feedback) occurs while using the microphone(s)

Take the following actions to prevent these noises.

- Adjust the MIC LEVEL and VOLUME control.
- Avoid pointing the microphone(s) towards the speakers.
- When two microphones are connected, turn off the On/Off switch on the unused microphone.

notes If you use the following sources as the playing source for Vocal Masking, you cannot get satisfactory results

- Radio programs — a radio signal is not as reliable as the signals coming from a tape or CD.
- Monaural sources.
- Poorly dubbed tapes.
- Sources recorded with duets, strong echo, a chorus, or only a few instruments.
- Poorly prerecorded tape or CD.

Singing Along with Multiplex Karaoke Discs (MPX)

If the source you are going to play is a multiplex karaoke disc, you can use the Multiplex sound function (MPX) via the button on the unit.

What is Multiplex Sound?

On a multiplex karaoke disc, the instrumental parts are recorded on the left channel. With this system, you can replace the vocal part with your voice through the microphone.

On the unit ONLY:

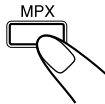
- 1 Rotate the MIC and Volume level to MIN. 
- 2 Connect the microphone (not supplied) into the MIC 1 and/or MIC 2 jack on the front panel.
- 3 Play the source - CD.
- 4 Press MPX to select the output sound.  Please refer to page 19.

5 Turn **MIC LEVEL** and **VOLUME** to adjust the microphone level and the speaker output level.

6 Sing into the microphone.

To apply echo to your voice, see “To apply an echo to your voice” on this page.

To adjust the music key, see “Adjusting the Music Key Control” on this page.

To record your singing along, see “Microphone Mixing” on this page.



When finished singing

Restore the stereo effect by pressing **MPX** until “**NORMAL**” appears on the display.

Recording Your Singing

You can adjust the music key using the remote control.

1 Follow the steps in “Singing Along with the Multiplex Karaoke Discs” in page 24.

2 Follow the steps in “Recording Tapes on Deck B” On page 21 to record your singing.

Adjust the Music Key Control (for CD play only)

1 Press **KEY CONTROL** **b/ #** to adjust the music key.

To lower the key, press **KEY CONTROL** **b**.

To raise the key, press **KEY CONTROL** **#**.

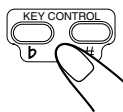

To cancel the key adjustment, press **KEY CONTROL** **b** or **#** until “**KEY 0**” appears on the display



Adjust the music key each time you sing along to a song

Once the music key is adjusted, the key level will not return to the previous level automatically after playing a song.

The music key cannot be changed while recording.

Once the source is changed, the key level returns to 0.

The Sound Mode will be cancelled if the Multiplex sound is selected.

Microphone mixing

When you sing along with multiplex tapes or CDs, follow the procedure below:

On the unit ONLY:

1 Rotate the **MIC LEVEL** to **MIN**.



2 Connect the microphone(s) (not supplied) by plugging it into the **MIC 1** and/or **MIC 2** jack.

3 Start playing the source — **CD, tape or other** connected component.

4 Rotate the **MIC LEVEL** and **VOLUME** controls as you sing into the microphone(s).



- By pressing **REC START/STOP**, you can record your singing along if you want. (For more details, see page 21.)

To use microphone only

You can record using the microphone(s) without any accompaniment.

1 Rotate the **MIC LEVEL** to **MIN**.

2 Connect the microphone(s) (not supplied) by plugging it into the **MIC 1** and/or **MIC 2** jack.

3 Press **CD** **▶/||**, then **■** **⊗**.
No background sound will be heard.

4 Rotate the **MIC LEVEL** and **VOLUME** controls as you sing or speak into the microphone(s).

- By pressing **REC START/STOP**, you can record your singing. (For more details, see page 21.)

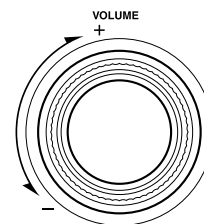

Using the Timers

There are three timers available — Recording Timer, Daily Timer, and Sleep Timer.

Before using the timers, you need to set the unit's built-in clock. (See page 9.)

Using Daily Timer

With Daily Timer, you can wake up to your favorite music or radio program.

How Daily Timer works

The unit automatically turns on, sets the volume level to the preset level, and starts playing the specified source at the turn-on time (the ☺ indicator flashes just before the turn-on time, and continues flashing while the timer is operating). Then, at the turn-off time ("OFF" flashes just before the turn-off time), the unit automatically turns off (stands by).

The timer setting remains in memory until you change it.

- There is a time limit for performing the following steps. If the setting is canceled before you finish, start from step 1 again.
- If you have made a mistake while setting timer, press CANCEL. (However, this does not always work. If CANCEL does not work, press CLOCK/TIMER repeatedly and start from step 1 again.)

Before you start...

- When using a CD as the source to play, make sure there is a CD in the selected tray.
- When using a tape as the source to play —
 - Make sure that a tape is in the deck whose deck indicator (A or B) is lit on the display.
 - Make sure that the tape direction is correct.
- When using an external component as the source to play, set the timer of the external component at the same time.

On the unit ONLY:

1 Press CLOCK/TIMER until "DAILY" appears on the display.

The DAILY (Daily Timer) indicator also starts flashing on the display.

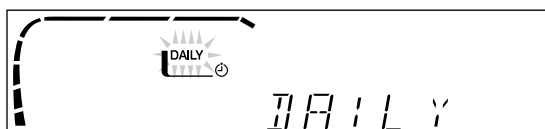

- Each time you press the button, the timer setting modes change as follows:

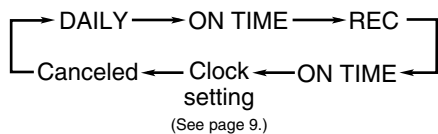

2 Press CLOCK/TIMER again.

"ON TIME" appears for 2 seconds, then the unit enters turn-on-time setting mode.

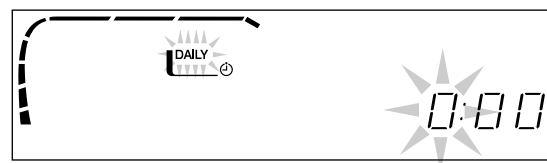

3 Set the turn-on-time.

- 1) Press ◀◀ or ▶▶ to set the hour, then press SET.
 - 2) Press ◀◀ or ▶▶ to set the minute, then press SET.
- "OFF TIME" appears for 2 seconds, then the unit enters turn-off-time setting mode.

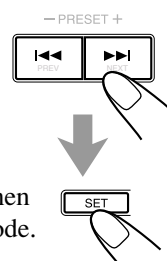

4 Set the turn-off-time.

- 1) Press ◀◀ or ▶▶ to set the hour, then press SET.
 - 2) Press ◀◀ or ▶▶ to set the minute, then press SET.
- The unit enters source selecting mode.

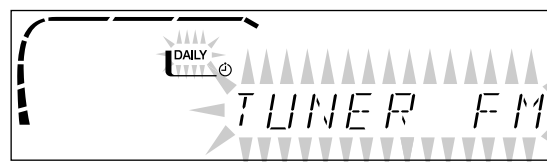

5 Press ◀◀ or ▶▶ to select the source to play, then press SET.

- Each time you press ◀◀ or ▶▶, the source changes as follows:

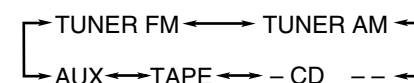

TUNER FM: tunes into a specified preset FM station. → go to step 6.

TUNER AM: tunes into a specified preset AM station. → go to step 6.

– CD –: plays a track of a specified disc. → go to step 6.

TAPE: plays a tape in deck A or B. → go to step 7.

AUX: plays an external source. → go to step 7.

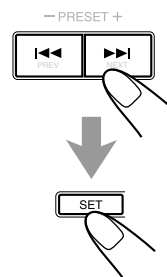

6 When selecting “- CD - -”.

- 1) Press ◀◀ or ▶▶ to select the disc number, then press SET.
- 2) Press ◀◀ or ▶▶ to set the track number, then press SET.

The unit enters volume setting mode.

When selecting “TUNER FM” or “TUNER AM”.

Press ◀◀ or ▶▶ to select the preset station number, then press SET.

The unit enters volume setting mode.

7 Press ◀◀ or ▶▶ to set the volume level.

- You can select the volume level from among the following — “VOL - -”, “VOL 05”, “VOL 10” and “VOL 15”

If you select “VOL - -” the volume is set to the last level before the unit was turned off.

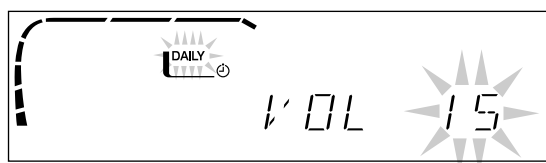

8 Press SET to complete the Daily Timer setting.

The DAILY (Daily Timer) indicator stops flashing and remains lit. The settings you have entered are shown on the display in sequence.

9 Press ⏻ to turn off the unit (on standby) if you have set the Daily Timer with the unit turned on.

To turn on or off Daily Timer after its setting is done

- 1 Press CLOCK/TIMER repeatedly until “DAILY” appears on the display.
- 2 To turn off the Daily Timer, press CANCEL.

The DAILY (Daily Timer) indicator goes off from the display (“OFF” appears for a while). The Daily Timer is canceled, but the setting for the Daily Timer remains in memory.

To turn on the Daily Timer, press SET.

The DAILY (Daily Timer) indicator lights up on the display. The settings you have entered are shown on the display in sequence for your confirmation.



If the unit is turned on when the timer-on time comes Daily Timer does not work.

Using Recording Timer

With Recording Timer, you can make a tape of a radio broadcast automatically.

How Recording Timer works

The unit automatically turns on, tunes into the specified station, sets the volume level to “MIN,” and starts recording when the turn-on-time comes (the ☺ indicator flashes just before the turn-on-time, and continues flashing while the timer is operating). Then, when the turn-off-time comes (“OFF” appears just before the turn-off-time), the unit automatically turns off (stands by).

The timer setting remains in memory until you change it.

- There is a time limit for performing the following steps. If the setting is canceled before you finish, start from step 1 again.
- If you have made a mistake while setting the timer, press CANCEL. (However, this does not always work. If CANCEL does not work, press CLOCK/TIMER repeatedly and start from step 1 again.)

On the unit ONLY:

1 Put a recordable cassette into deck B.

2 Press CLOCK/TIMER until “REC” appears on the display.

The REC (Recording Timer) indicator also starts flashing on the display.

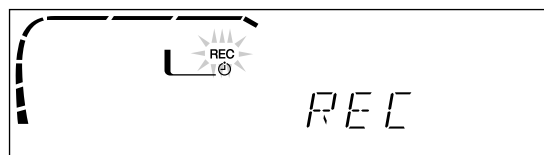

- Each time you press the button, the timer setting modes change as follows:

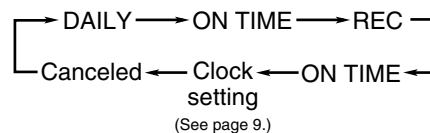

3 Press CLOCK/TIMER again.

“ON TIME” appears for 2 seconds, then the unit enters turn-on-time setting mode.

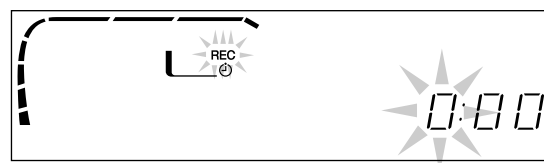



4 Set the turn-on-time.

- 1) Press ◀◀ or ▶▶ to set the hour, then press SET.
- 2) Press ◀◀ or ▶▶ to set the minute, then press SET.
“OFF TIME” appears for 2 seconds, then the unit enters turn-off-time setting mode.

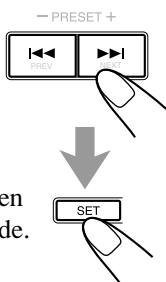

5 Set the turn-off-time.

- 1) Press ◀◀ or ▶▶ to set the hour, then press SET.
- 2) Press ◀◀ or ▶▶ to set the minute, then press SET.
The unit enters preset station selecting mode.

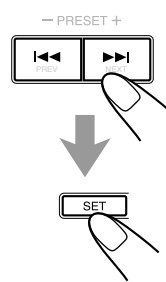

6 Select the preset station.

- 1) Press ◀◀ or ▶▶ to select the band (“TUNER FM” or “TUNER AM”), then press SET.
- 2) Press ◀◀ or ▶▶ to select a preset channel number, then press SET.
The REC (Recording Timer) indicator stops flashing and remains lit. The settings you have entered are shown on the display in sequence.

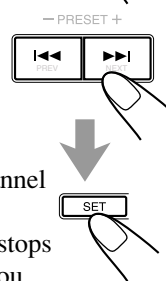

7 Press ⏻ to turn off the unit (on standby) if necessary.

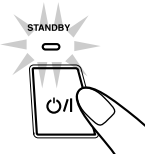

If you want to listen to another source while recording

Press REC START/STOP to stop recording. Without stopping it, you cannot change the source.

To turn on or off Recording Timer after it is set

- 1 Press CLOCK/TIMER repeatedly until “REC” appears on the display.

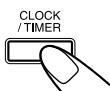

- 2 To turn off the Recording Timer, press CANCEL.



The REC (Recording Timer) indicator goes off from the display.

The Recording Timer is canceled, but the setting for the Recording Timer remains in memory.

To turn on the Recording Timer, press SET.

The REC (Recording Timer) indicator lights up on the display. The settings you have entered are shown on the display in sequence for your confirmation.

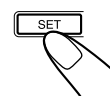

Using Sleep Timer

With Sleep Timer, you can fall asleep to music. You can set Sleep Timer when the unit is turned on.

How Sleep Timer works

The unit automatically turns off after the specified time length elapses.

On the remote control ONLY:

1 Press SLEEP.

The time length until shut-off appears and the SLEEP indicator starts flashing on the display.

- Each time you press the button, the time length changes as follows:

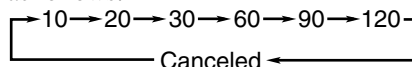

2 Wait for about 5 seconds after specifying the time length.

The SLEEP indicator stops flashing and remains lit.

To check the remaining time until shut-off, press SLEEP once so that the remaining time until shut-off appears for about 5 seconds.

To change the shut-off time, press SLEEP repeatedly until the desired time length appears on the display.

To cancel the setting, press SLEEP repeatedly so that the SLEEP indicator goes off.

- Sleep Timer is also canceled when you turn off the unit.

Timer Priority

Since each timer can be set separately, you may wonder what happens if the setting for these timers overlaps. Here are examples.

- Recording Timer has priority over Daily Timer and Sleep Timer.

If Daily Timer is set to come on while Recording Timer is operating, Daily Timer will not come on at all.

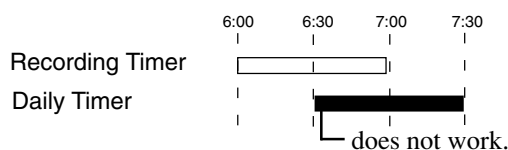

If Recording Timer is set to come on while Sleep Timer is operating, Sleep Timer will not work (the SLEEP indicator does not go off).

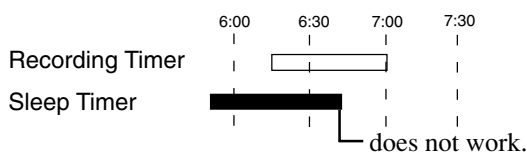

Maintenance



To get the best performance from the unit, keep your discs, tapes, and mechanism clean.

Handling discs



- Remove the disc from its case by holding it at the edge while pressing in the center hole lightly.
- Do not touch the shiny surface of the disc, or bend the disc.
- Put the disc back in its case after use to prevent warping.

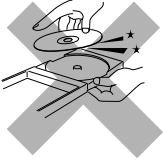

- Be careful not to scratch the surface of the disc when placing it back in its case.
- Avoid exposure to direct sunlight, temperature extremes, and moisture.



To clean the disc

Wipe the disc with a soft cloth in a straight line from center to edge.



DO NOT use any solvent — such as conventional record cleaner, spray, thinner, or benzine — to clean the disc.

Handling cassette tapes

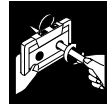

- If the tape is loose in its cassette, take up the slack by inserting a pencil in one of the reels and rotating.
- If the tape is loose, it may get stretched, cut, or caught in the cassette.



- Be careful not to touch the tape surface.



- Avoid storing tapes in the following places:
 - In dusty places
 - In direct sunlight or heat
 - In moist areas
 - Near a magnet

Troubleshooting

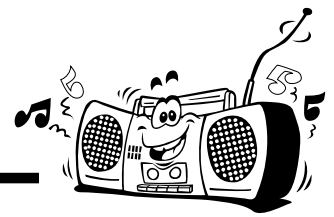

If you are having problems with your unit, check this list for a possible solution before calling for service.

If you cannot solve the problem from the hints given here, or the unit has been physically damaged, call a qualified person, such as your dealer, for service.

| Symptom | Cause | Action |
|---|--|--|
| No sound is heard. | Connections are incorrect or loose. | Check all connections and make corrections. (See pages 6 to 8.) |
| Hard to listen to broadcasts because of noise. | <ul style="list-style-type: none"> • Antennas are disconnected. • The AM loop antenna is too close to the unit. • The FM antenna is not properly extended and positioned. | <ul style="list-style-type: none"> • Reconnect the antennas correctly and securely. • Change the position and direction of the AM loop antenna. • Extend the FM antenna in the best position. |
| The disc sound is discontinuous. | The disc is scratched or dirty. | Clean or replace the disc. (See page 29.) |
| The disc tray does not open or close. | <ul style="list-style-type: none"> • The AC power cord is not plugged in. • Trays are locked. | <ul style="list-style-type: none"> • Plug in the AC power cord. • Unlock the trays. (See page 15.) |
| The disc does not play. | The disc is placed upside down. | Place the disc with the label side up. |
| The cassette holders cannot be opened. | Power supply from the AC power cord has been cut off while the tape was running. | Turn on the unit. |
| Impossible to record. | Small tabs on the back of the cassette are removed. | Cover the holes with adhesive tape. |
| Stereo effect is lost. | Vocal masking is activated. | Cancel the vocal masking (see page 24). |
| Operations are disabled. | The built-in microprocessor may be malfunctioning due to external electrical interference. | Unplug the AC power cord and then plug it back in. |
| Unable to operate the unit from the remote control. | <ul style="list-style-type: none"> • The path between the remote control and the remote sensor on the unit is blocked. • The batteries are exhausted. | <ul style="list-style-type: none"> • Remove the obstruction. • Replace the batteries. |

Specifications

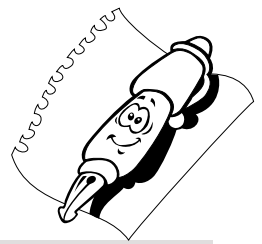

Amplifier section

Output Power (IEC 268-3/DIN)

SUBWOOFERS: 60 W per channel, min. RMS, both channels driven into 6Ω at 63 Hz with no more than 0.9% total harmonic distortion.

MAIN SPEAKERS: 20 W per channel, min. RMS, both channels driven into 6Ω at 1 kHz with no more than 0.9% total harmonic distortion.

Audio input sensitivity/Impedance

(at 1 kHz, measured at MAIN SPEAKERS)

AUX: 340 mV/50 k Ω

MIC 1/2: 3.2 mV/5 k Ω

Digital output: CD OPTICAL DIGITAL OUTPUT

Signal wave length: 660 nm

Output level: -15 dBm to -12 dBm

Speakers/Impedance: $6 \Omega - 16 \Omega$

Tuner

FM tuning range: 87.50 MHz – 108.00 MHz

AM tuning range:

For Saudi Arabia:

At 9 kHz intervals : 531 kHz – 1,602 kHz

At 10 kHz intervals : 530 kHz – 1,600 kHz

For other countries:

At 9 kHz intervals : 531 kHz – 1,710 kHz

At 10 kHz intervals : 530 kHz – 1,710 kHz

CD player

CD Capacity: 3 CDs

Dynamic range: 85 dB

Signal-to-noise ratio: 90 dB

Wow and flutter: Immeasurable

Cassette deck

Frequency response

Normal (type I): 50 Hz — 14,000 Hz

CrO₂ (type II): 50 Hz — 14,000 Hz

Metal (type IV): 50 Hz — 14,000 Hz (only for playback)

Wow and flutter

0.15% (WRMS)

General

Power requirement: AC 110/127/220/230 — 240 V \sim
(adjustable with the voltage selector),
50 Hz / 60 Hz

Power consumption: 135 W (at operation)
17 W (on standby)

Maximum power consumption (for Taiwan only): 435 W

Dimensions (approx.): 265 mm x 335 mm x 368 mm (W/H/D)
(10⁷/₁₆ in. x 13¹/₄ in. x 14¹/₂ in.)

Mass (approx.): 10 kg (22 lbs)

Supplied accessories

See page 6.

Design and specifications are subject to change without notice.

Mains (AC) Line Instruction (not applicable for Europe, U.S.A., Canada, Australia, and U.K.)

主 (AC) 電源線路說明 (不適用於歐洲、美國、加拿大、澳洲及英國型號)

تعليمات خط التيار الكهربائي الرئيسي (التردد) (لا تنطبق على اوروبا والولايات المتحدة الامريكية وكندا واستراليا والمملكة المتحدة)

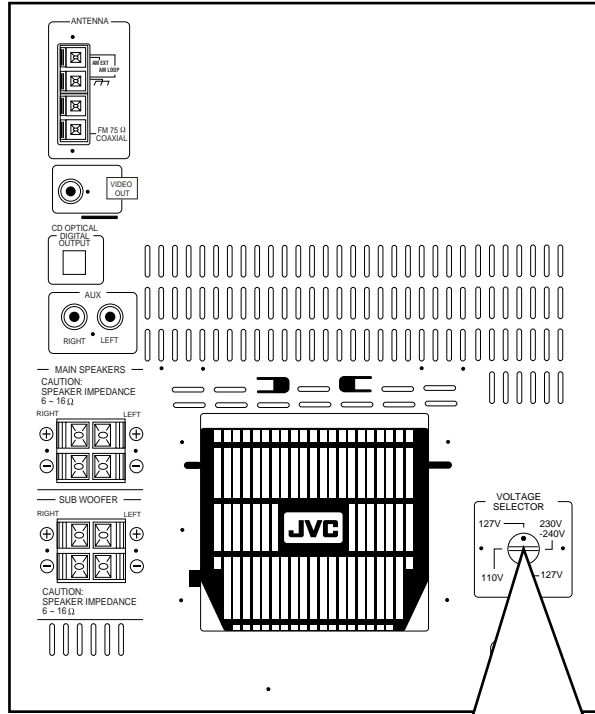

IMPORTANT for mains (AC) line

BEFORE PLUGGING IN, do check that your mains (AC) line voltage corresponds to the position of the voltage selector switch provided on the outside of this equipment and, if different, reset the voltage selector switch, to prevent damage or risk of fire/electric shock.

有關主 (AC) 電源線路的重要事項

接插電源以前，務請檢查當地的主 (AC) 電源線路電壓是否和位於本機外面的電壓選擇開關設定的位置一致。如果不一致，即重新設定電壓選擇開關使符合當地電壓，以免損壞機器或引起火災／觸電的危險。

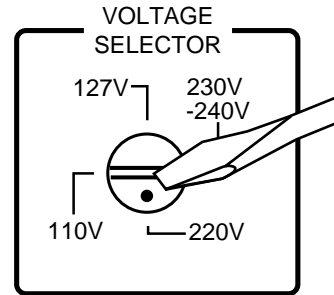

هام من اجل خط التيار الكهربائي الرئيسي (التردد) قبل ادخال قابس الطاقة الكهربائية، تأكد من تطابق منتخب فولطية التيار الكهربائي الرئيسي (التردد) الموجود على خلفية الجهاز مع فولطية التيار الكهربائي في بلدك. في حالة عدم التطابق، اعد ضبط مفتاح منتخب الفولطية على فولطية التيار الكهربائي المتردد في بلدك. عدم عمل ذلك، يمكن يؤدي الى حصول ضرر أو حريق أو صدمة كهربائية.

Free Manuals Download Website

<http://myh66.com>

<http://usermanuals.us>

<http://www.somanuals.com>

<http://www.4manuals.cc>

<http://www.manual-lib.com>

<http://www.404manual.com>

<http://www.luxmanual.com>

<http://aubethermostatmanual.com>

Golf course search by state

<http://golfingnear.com>

Email search by domain

<http://emailbydomain.com>

Auto manuals search

<http://auto.somanuals.com>

TV manuals search

<http://tv.somanuals.com>