

JVC



MICRO COMPONENT SYSTEM

UX-NB7DAB

—Consists of CA-UXNB7DAB and SP-UXNB7DAB

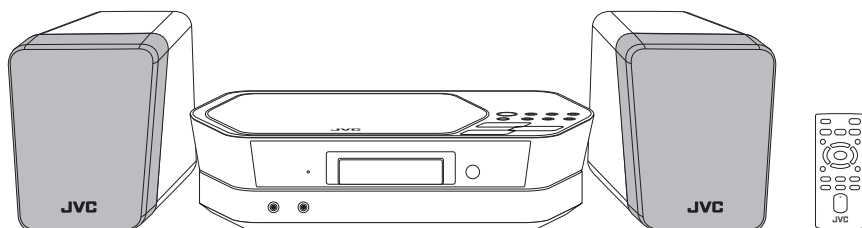

COMPACT
disc
DIGITAL AUDIO

MP3
PLAYBACK

Radio Data System

DAB

Digital Audio Broadcasting

INSTRUCTIONS

GNT0065-025A

[B]

Warnings, Cautions and Others

CAUTION — button!

Disconnect the mains plug to shut the power off completely. When installing the apparatus, ensure that the plug is easily accessible.

The  button in any position does not disconnect the mains line. The power can be remote controlled.

- When the unit is on standby, the STANDBY lamp lights red.
- When the unit is turned on, the STANDBY lamp goes off.

CAUTION

To reduce the risk of electrical shocks, fire, etc.:

1. Do not remove screws, covers or cabinet.
2. Do not expose this appliance to rain or moisture.

CAUTION:

- Do not block the ventilation openings or holes. (If the ventilation openings or holes are blocked by a newspaper or cloth, etc., the heat may not be able to get out.)
- Do not place any naked flame sources, such as lighted candles, on the apparatus.
- When discarding batteries, environmental problems must be considered and local rules or laws governing the disposal of these batteries must be followed strictly.
- Do not expose this apparatus to rain, moisture, dripping or splashing and that no objects filled with liquids, such as vases, shall be placed on the apparatus.

IMPORTANT FOR LASER PRODUCTS

1. CLASS 1 LASER PRODUCT

2. **CAUTION:** Do not open the top cover. There are no user serviceable parts inside the unit; leave all servicing to qualified service personnel.

3. **CAUTION:** Visible and/or invisible class 1M laser radiation when open. Do not view directly with optical instruments.

4. REPRODUCTION OF LABEL: CAUTION LABEL, PLACED INSIDE THE UNIT.

CAUTION VISIBLE AND/OR INVISIBLE CLASS 1M LASER RADIATION WHEN OPEN. DO NOT VIEW DIRECTLY WITH OPTICAL INSTRUMENTS. E608022-12001 (ENG)	ATTENTION RAYONNEMENT LASER VISIBLE ET/OU INVISIBLE DE CLASSE 1M UNE FOIS OUVERT. NE PAS REGARDER DIRECTEMENT AVEC DES INSTRUMENTS OPTIQUES. (FRN)	AVISO RADIACION LASER DE CLASE 1M VISIBLE Y/O INVISIBLE CUANDO ESTA ABIERTO. NO MIRAR DIRECTAMENTE CON INSTRUMENTAL OPTICA. (ESP)	WARNING RYNLIG OCH/ELLER DOYVLIG LASERSTRÅLNING, KLASS 1M, NÄR DENNA DEL ÄR ÖPPNAD. BETRÄKTA EJ STRÅLEN MED OPTISKA INSTRUMENT. (SWE)	注意 レーザー光と可視 及び/または不可視 のクラス1M レーザー放射 がある時、 直接に 光学器具で 見ないでください。 (JPN)	CAUTION VISIBLE AND/OR INVISIBLE CLASS II LASER RADIATION WHEN OPEN. DO NOT STARE INTO BEAM. FDA 21 CFR (EN6) L144603-002A
---	---	--	--	--	--

Dear Customer,

This apparatus is in conformance with the valid European directives and standards regarding electromagnetic compatibility and electrical safety.

European representative of Victor Company of Japan, Limited is:

JVC Technology Centre Europe GmbH

Postfach 10 05 52

61145 Friedberg

Germany

IMPORTANT for the U.K.

DO NOT cut off the mains plug from this equipment. If the plug fitted is not suitable for the power points in your home or the cable is too short to reach a power point, then obtain an appropriate safety approved extension lead or consult your dealer.

BE SURE to replace the fuse only with an identical approved type, as originally fitted.

If nonetheless the mains plug is cut off ensure to remove the fuse and dispose of the plug immediately, to avoid a possible shock hazard by inadvertent connection to the mains supply.

If this product is not supplied fitted with a mains plug then follow the instructions given below:

IMPORTANT:

DO NOT make any connection to the terminal which is marked with the letter E or by the safety earth symbol or coloured green or green-and-yellow.

The wires in the mains lead on this product are coloured in accordance with the following code:

Blue: Neutral
Brown: Live

As these colours may not correspond with the coloured markings identifying the terminals in your plug proceed as follows:

The wire which is coloured blue must be connected to the terminal which is marked with the letter N or coloured black.

The wire which is coloured brown must be connected to the terminal which is marked with the letter L or coloured red.

IF IN DOUBT - CONSULT A COMPETENT ELECTRICIAN.

CAUTION: Proper Ventilation

To avoid risk of electric shock and fire, and to prevent damage, locate the apparatus as follows:

1. Front: No obstructions and open spacing.
2. Sides/ Top/ Back: No obstructions should be placed in the areas shown by the dimensions below.
3. Bottom: Place on the level surface. Maintain an adequate air path for ventilation by placing on a stand with a height of 10 cm or more.

Front view

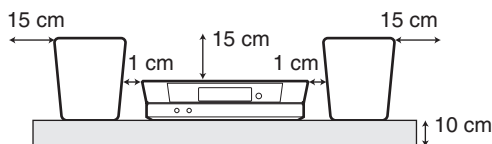

SP-UXNB7DAB CA-UXNB7DAB SP-UXNB7DAB

Side view

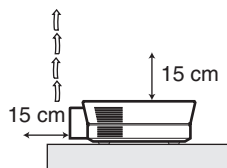

CA-UXNB7DAB

About the cooling fan

A cooling fan is mounted on the rear panel of the unit to prevent abnormal temperature inside the unit, thus assuring normal operation of the unit.

Information for Users on Disposal of Old Equipment

[European Union]



This symbol indicates that the electrical and electronic equipment should not be disposed as general household waste at its end-of-life. Instead, the product should be handed over to the applicable collection point for the recycling of electrical and electronic equipment for proper treatment, recovery and recycling in accordance with your national legislation.

Attention:

This symbol is only valid in the European Union.

By disposing of this product correctly, you will help to conserve natural resources and will help prevent potential negative effects on the environment and human health which could otherwise be caused by inappropriate waste handling of this product. For more information about collection point and recycling of this product, please contact your local municipal office, your household waste disposal service or the shop where you purchased the product.

Penalties may be applicable for incorrect disposal of this waste, in accordance with national legislation.

(Business users)

If you wish to dispose of this product, please visit our web page www.jvc-europe.com to obtain information about the take-back of the product.

[Other Countries outside the European Union]

If you wish to dispose of this product, please do so in accordance with applicable national legislation or other rules in your country for the treatment of old electrical and electronic equipment.

The model information is located on the bottom.

Contents

Precautions	2
Getting Started	2
Supplied Accessories	2
Prepare the Remote Control	2
Connections	3
Basic and Common Operations	5
Operating on the System	5
Display Information	5
Operating on the Remote Control	6
Playing Back Discs	7
To Set a Disc	7
Basic Disc Operations	7
Playing at Random—Random Play	8
Playing Repeatedly—Repeat Play	8
Programming the Playing Order—Program Play (except for MP3)	8
Listening to the Radio	9
Basic Tuner Operations	9
What is DAB system?	10
Changing the DAB Information	10
Improving the DAB reception	10
Scanning ensembles	10
Receiving FM stations with Radio Data System	11
Changing the Radio Data System Information	11
Searching for Programs by PTY Codes (PTY Search)	11
Switching Temporarily to a Program of Your Choice Automatically	12
Presetting Stations and Services	12
Connecting a Portable Audio Device	13
Playing back a portable audio device	13
Recording to a portable audio device	14
Setting the Clock and Daily Timer	15
Setting the Clock	15
Setting the Daily Timer	15
Learning More about This System	16
Troubleshooting	17
Maintenance	18
Specifications	18
Description of the PTY codes for Radio Data System and DAB	19

Precautions

Notes on the power cord

- When you are away on travel or otherwise for an extended period of time, remove the plug from the wall outlet. A small amount of power (2.5 W) is always consumed while the power cord is connected to the wall outlet.
- When unplugging the System from the wall outlet, always pull the plug, not the power cord.
- Do not handle the power cord with wet hands.
- Disconnect the power cord before cleaning the System or moving the System.
- Do not alter, twist or pull the power cord, or put anything heavy on it, which may cause fire, electric shock, or other accidents.
- If the cord is damaged, consult a dealer and have the power cord replaced with a new one.

Avoid moisture, water, dust, and high temperatures

- Do not place the System in moist or dusty places.
- If water gets inside the System, turn off the power and remove the plug from the wall outlet, then consult your dealer. Using the System in this state may cause a fire or electrical shock.
- Do not expose the System to direct sunlight or place it near a heating device.

Notes on installation

- Select a place which is level, dry and neither too hot nor too cold between 5°C and 35°C.
- Do not install the System in a place subject to vibrations.
- Do not put heavy objects on the System.

To prevent malfunction or damage of the System

- Do not insert any metallic objects, such as wires, hairpins, coins, etc. into the System.
- Do not block the vents.

To clean the cabinet

- Use a soft cloth. Follow the relevant instructions on the use of chemically-coated cloths.
- Do not use benzene, thinner or other organic solvents and disinfectants. These may cause deformation or discoloring.

There are no user-serviceable parts inside. If anything goes wrong, unplug the power cord and consult your dealer.

Getting Started

Supplied Accessories

After unpacking, check to be sure that you have all the following items. The number in parentheses indicates the quantity of each piece supplied.

- Remote control (x 1)
- Lithium coin battery CR2025 (x 1) (The battery has been installed when shipped from the factory.)
- AM loop antenna (x 1)
- FM antenna (x 1)
- DAB antenna (x 1)

If anything is missing, consult your dealer immediately.

Prepare the Remote Control

When you use the remote control for the first time, pull out the insulation sheet.

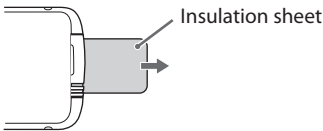

Replacing the Battery in the Remote Control

Insert the battery into the remote control by matching the polarity (+ and -) correctly.

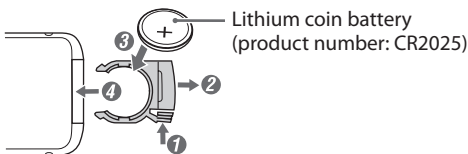

NOTES

- Store the battery in a place where children cannot reach. If a child accidentally swallows the battery, consult a doctor immediately.
- Do not recharge, short, disassemble or heat the battery or dispose of it in a fire. Doing any of these things may cause the battery to give off heat, crack, or start a fire.
- Do not leave the battery with other metallic materials. Doing this may cause the battery to give off heat, crack, or start a fire.
- When throwing away or saving the battery, wrap it in tape and insulate; otherwise, the battery may start to give off heat, crack, or start a fire.
- Do not poke the battery with tweezers or similar tools. Doing this may cause the battery to give off heat, crack, or start a fire.
- Dispose of battery in the proper manner, according to federal, state, and local regulations.

CAUTION:

Danger of explosion if battery is incorrectly replaced. Replace only with the same or equivalent type.

● Connections

Do not connect the AC power cord until all other connections have been made.

NOTES

- Make sure the antenna conductors do not touch any other terminals, connecting cords and power cord. Also, keep the antennas away from metallic parts of the System, connecting cords, and the AC power cord. This could cause poor reception.
- If the cords are covered with vinyl, remove the vinyl to expose the tip of the cord by twisting the vinyl.

DAB antenna (supplied)

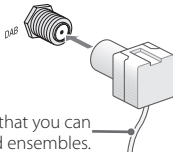

Extend the wire so that you can receive your desired ensembles.

For better DAB reception

Disconnect the supplied DAB antenna, and connect an active antenna. (See "Improving the DAB reception" on page 10.)

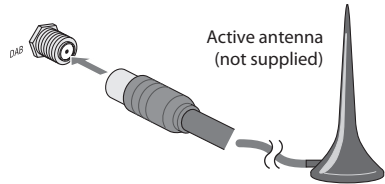

Active antenna
(not supplied)

FM antenna (supplied)

Extend it so that you can obtain the best reception.

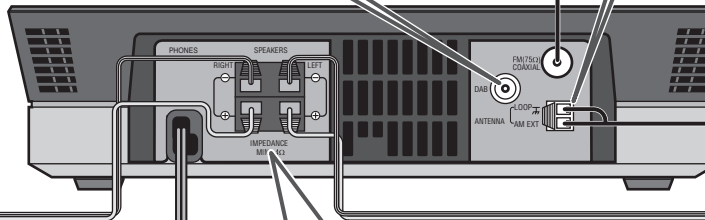
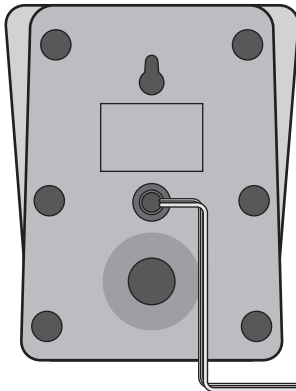

To a wall outlet

Plug the AC power cord only after all connections are complete.

To connect the speaker cords

Make sure the both speakers are connected correctly and firmly. When connecting the speaker cords, match the polarity of the speaker terminals: white cord to (+) and white cord with black stripe to (-).

To connect the AM loop antenna

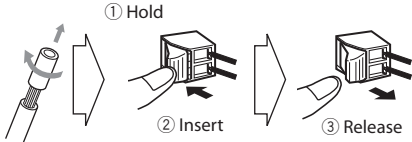

AM loop antenna (supplied)

Turn it until the best reception is obtained.

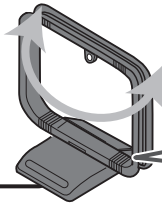

To assemble the AM loop antenna

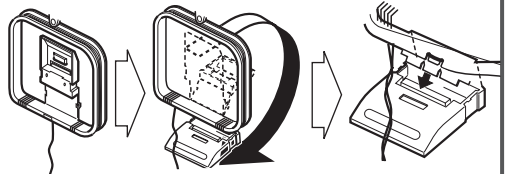

For better FM/AM reception

Disconnect the supplied FM antenna, and connect to an outdoor FM antenna using a 75 Ω wire with coaxial type connector (IEC or DIN45325).

Outdoor FM antenna
(not supplied)

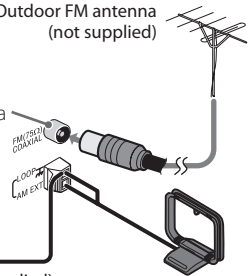

Vinyl-covered wire (not supplied)
Extend it horizontally.

AM loop antenna
Keep it connected.

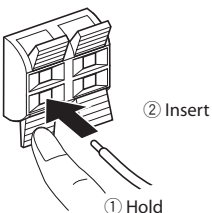





NOTES

- DO NOT connect more than one speaker to each terminal.
- DO NOT allow the conductor of the speaker cords to be in touch with the metallic parts of the System.

Basic and Common Operations

● Operating on the System

To	Press
Turn on or off (standby) the power	 The standby lamp on the System turns off/on.
Select a source*	 See "Playing Back Discs" on page 7.
	 See "Listening to the Radio" on page 9.
	 See "Connecting a Portable Audio Device" on page 13.
Adjust the volume	 You can adjust the volume level from level 0 (VOL MIN) to level 31 (VOL MAX).

* You can operate the source select buttons on the System only touch lightly, because these buttons are "touch sensor panel."
If you touch any one of these buttons, they lights in orange briefly.

NOTE

DO NOT turn off (standby) the System with the volume set to an extremely high level; Otherwise, the sudden blast of sound can damage your hearing, speakers and/or headphones when you turn on the System or start playback.

Using Headphones

Be sure to turn down the volume before connecting or wearing the headphones.
• Connecting the headphones will deactivate the speakers.

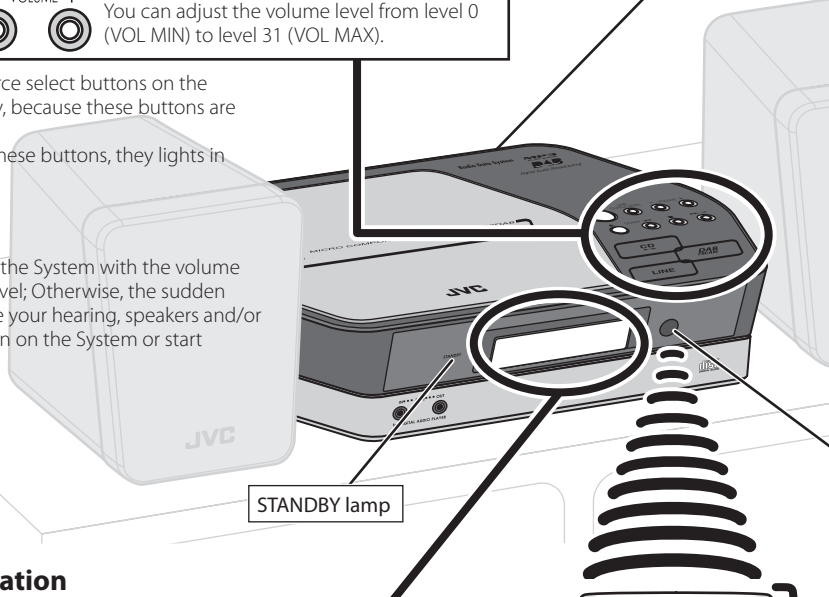

● Display Information

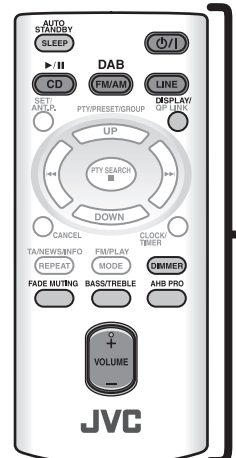
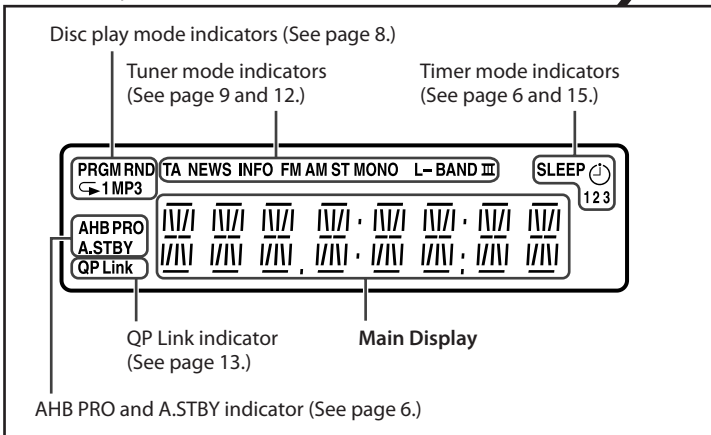

● Operating on the Remote Control

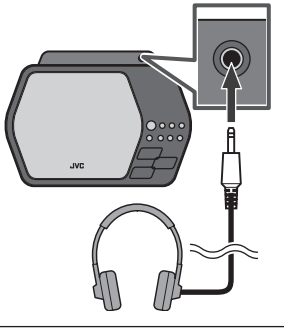

Point to the remote sensor on the front panel. (The operating range is approx. 7 m.)





To	Press
Turn on or off (standby) the power	The standby lamp on the System turns off/on.
Select a source	See "Playing Back Discs" on page 7.
	See "Listening to the Radio" on page 9.
	See "Connecting a Portable Audio Device" on page 13.
Adjust the volume	You can adjust the volume level from level 0 (VOL MIN) to level 31 (VOL MAX).
Drop the volume in a moment	FADE MUTING To restore the volume , press again, or adjust the volume level.
Reinforce the bass sound	AHB PRO AHB PRO indicator appears on the display. To cancel this function , press again.
Adjust the tone (Bass/Treble)	BASS/TREBLE ↓ Press once to adjust the bass level or press twice to adjust the treble level. Then press VOLUME + to increase the level or press VOLUME - to decrease it. • You can adjust the bass and treble level from -3 to +3.
Changing the display brightness	Press when the System is turned on. To cancel this function , press again.
Set the Save mode	Press and hold for more than 2 seconds when the System is on standby. To cancel this function , press and hold for more than 2 seconds again. • Setting the Save mode allows you to reduce power consumption by turning the display off while on standby.
Changing the display information (Clock and Source)	DISPLAY/ QP LINK Press briefly (except for FM and DAB mode). For setting the clock, see page 15.
Turn off the System automatically after CD playback is over (AUTO STANDBY function)	AUTO STANDBY SLEEP Press and hold until A.STBY indicator appears on the display. To cancel this function , press and hold again. • If no operation is done for about 3 minutes after CD playback stops, the System turns off.
Turn off the System by using the sleep timer	AUTO STANDBY SLEEP Press briefly and repeatedly to specify the time (in minutes) as follows: • To check the time remaining until the shut-off time after setting the sleep timer, press SLEEP once.

Playing Back Discs













This System can play back the following discs—regular CD and CD-R/CD-RW (recorded either in the audio CD or MP3 format).

- When playing back the MP3 track, MP3 indicator appears on the display.

To Set a Disc

1 On the System  The disc cover on the System opens.		2  Place a disc correctly with its label side up, then press down on the portions around the disc's center hole until you hear a click. <ul style="list-style-type: none"> • When removing the disc, take out the disc by holding it at the edge with pressing the System's pivot lightly. 		3 On the System  The disc cover on the System closes. <ul style="list-style-type: none"> • Do not close forcibly the disc cover with the hand.
---	---	---	---	--



Basic Disc Operations

To	Press		
	On the System	On the remote	
Playback the disc			Current track number and elapsed playing time appear on the main display. <ul style="list-style-type: none"> • During playback, press again to stop playing for a moment.
Stop playback			<ul style="list-style-type: none"> • While playback is stopped, total track number and total playing time (for MP3 disc, group number and track number) appear on the main display.
Select a track			Increases the track numbers.
			Decreases the track numbers.
Select a group (MP3 only)	—		Increases the group numbers while playback is stopped.
	—		Decreases the group numbers while playback is stopped.
Forward search / Reverse search	—		Fast-forwards the track by pressing briefly. To stop searching, press ►/II.
	—		Fast-reverses the track by pressing briefly. To stop searching, press ►/II.



NOTES

- If the disc cannot be read correctly (because it is scratched, for example) or an unreadable CD-R or CD-RW is loaded, playback will not start.
- If no disc is inserted, "NO DISC" appears on the main display.





● Playing at Random—Random Play

- 1**  Press until the RND (random) indicator appears on the display before you start playback.
- 2**  Playback starts in random order. Random Play ends when all tracks are played.





Operations on the Random Play Mode

To	Press
To skip a track	 •  does not work.
To exit from random play	 Press once while playback is stopped to exit from the random play.

● Programming the Playing Order—Program Play (except for MP3)





- 1**  Press repeatedly until the PRGM (program) indicator appears on the display before you start playback.
- 2**  or  Select the track number to program.
- 3**  Press to program the selected track.
- 4** Repeat step **2** and **3** to program other tracks you want.
 - If you try to program a 33rd track, "FULL" will appear on the display.
- 5**  The tracks are played in the order you have programmed.





Operations on the Program Play Mode

To	Press
Check the programmed contents	 or  Press while playback is stopped.
To erase the last step	 CANCEL
To erase the entire program	 Press while playback is stopped.
To exit from program play	 Press twice while playback is stopped to exit from the program play. <ul style="list-style-type: none"> • The stored program is erased.

● Playing Repeatedly—Repeat Play

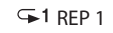
- Press repeatedly before you start playback to specify the repeat mode as follows:
- 1** 





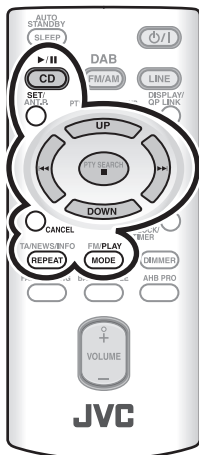

 -  Repeats the current (or specified) track.
 -  Repeats all tracks in the current group. (MP3 only)
 -  Repeats all tracks.
 -  Normal playback
 - 2** 





Listening to the Radio



Basic Tuner Operations

To	Press		
	On the System	On the remote	
Select a band			<p>Each time you press the button, the band changes as follows:</p>  <p>The selected band and frequency appear on the main display.</p> <ul style="list-style-type: none"> When an FM stereo broadcast with sufficient signal strength is tuned in, the ST (stereo) indicator lights on the display. <p>When you change the source to DAB for the first time after plugging in the AC power cord, the System automatically scans the DAB bands for available ensembles. (See page 10.)</p> <ul style="list-style-type: none"> For general information of DAB, see "What is DAB system?" on page 10.
Change the FM reception mode (When a stereo broadcast is hard to receive or noisy)	—		<p>Press to improve reception.</p> <p>The MONO indicator lights up on the display. Reception will improve though the stereo effect is lost.</p> <p>To restore the stereo effect, press again.</p>

For FM/AM

Select a frequency			<p>Press and hold for more than 2 seconds. The System starts searching for stations and stops when a station of sufficient signal strength is tuned in.</p> <ul style="list-style-type: none"> Press during searching to stop. Press repeatedly to change the frequency step by step.
Tune in to a preset station	—		<p>Press to select a preset number for the preset station.</p> <ul style="list-style-type: none"> For presetting stations, see page 12.

For DAB

Select an ensemble			<p>Press and hold for more than 2 seconds.</p> <ul style="list-style-type: none"> You can select from the ensembles scanned by the ensemble scanning.
Select a service (either primary or secondary)			<p>Press briefly while tuning in to an ensemble.</p>
Tune in to a preset service			<p>Press briefly to select a preset number for the preset service.</p> <ul style="list-style-type: none"> For presetting services, see page 12.
Tune in to all ensembles	—		<p>Press and hold for more than 2 seconds. The frequency changes every second through all ensembles regardless of the signal status.</p> <ul style="list-style-type: none"> Press and hold the button until the desired ensemble is reached.

What is DAB system?

DAB

DAB (Digital Audio Broadcasting) is one of the digital radio broadcasting systems available today. It can deliver digital quality sound without any annoying interference or signal distortion. Furthermore, it can carry text, pictures and data. In contrast to FM broadcast, where each program is transmitted on its own frequency, DAB combines several programs (called "services") to form one "ensemble." "Primary services" (main radio stations) are sometimes accompanied by "secondary services" to broadcast additional programs.

CAUTION:

Electrostatic discharge from your body may cause noise from the speakers and you cannot hear the broadcast. If this happens, turn off the System (on standby), then turn it on again.

Changing the DAB Information

DAB

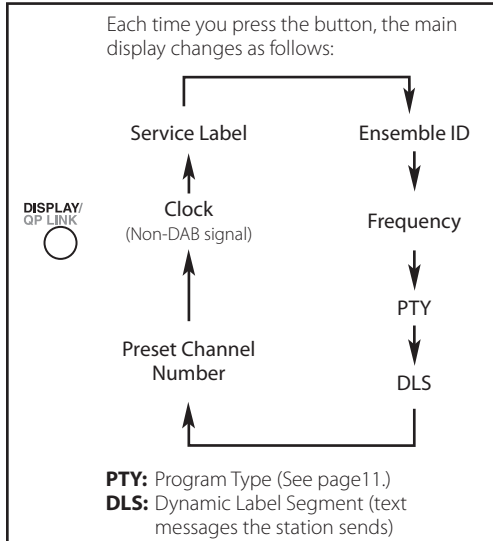

NOTE

If no signals are sent, "NOSIGNAL" (instead of Service Label), "NONE" (instead of PTY) or "NO TEXT" (instead of DLS) appears on the display.

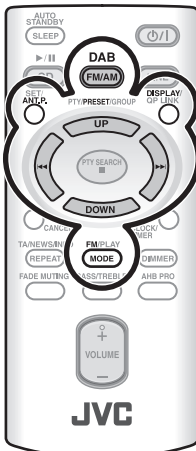

Improving the DAB reception

DAB

With the supplied DAB antenna, you may not be able to receive L-Band ensembles depending on your reception condition. You can improve the reception of both L-Band and Band III ensembles by connecting an active antenna (see page 3) and supplying electricity to the antenna.

While the System is on standby (Display ON)

After connecting an active antenna, press and hold for more than 2 seconds. The active antenna is powered on and "ANT.P ON" appears on the display.

To power off the active antenna, press and hold the button again. Then "ANT.P OFF" appears on the display.

Scanning ensembles

DAB

With the ensemble scanning function, the System scans the DAB bands to pick out available ensembles under your receiving condition.

- When you change the source to DAB for the first time after plugging in the AC power cord, the System automatically performs the scanning.
- When you moved your System or adjusted the antenna position, perform the scanning manually.

SET/ANT.P.



Press and hold for more than 2 seconds while tuning in to DAB.

When the scanning is complete, the System starts playing the first service of the ensemble found first.

● Receiving FM Stations with Radio Data System

Radio Data System allows FM stations to send an additional signal along with their regular program signals. With the System, you can receive the following types of Radio Data System signals.

- PS (Program Service):** Shows commonly known station names.
- PTY (Program Type):** Shows types of broadcast programs.
- RT (Radio Text):** Shows text messages the station sends.
- Enhanced Other Networks:** Provides the information about the types of the programs broadcast by the Radio Data System stations of the different networks.

NOTE

If you want to know more about Radio Data System, visit <<http://www.rds.org.uk>>.

● Changing the Radio Data System Information

Radio Data System

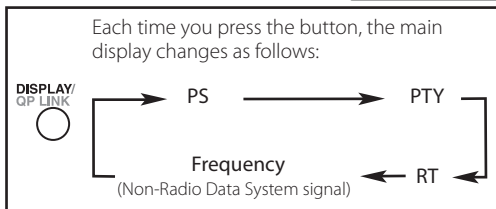

NOTE

If no Radio Data System signals are sent by a station, "NO PS," "NO PTY," or "NO RT" appears on the main display.

● Searching for Programs by PTY Codes (PTY Search)

DAB Radio Data System

While listening to an FM station:

You can locate a particular kind of program from the 30 preset stations (see page 12) by specifying PTY codes.

While listening to a DAB service:

You can locate a particular kind of program from among all the services you can receive by specifying PTY codes.

For details about PTY codes, see page 19.

1		Press to enter the PTY code setting mode. "PTY" and "SELECT" appear on the main display.
2		Select a PTY code.
3		The System starts searching, stops when it finds the program of the selected PTY code ("FOUND" appears on the display), and tunes in to it.

NOTES

- To stop searching any time during search for FM stations, press PTY SEARCH.
- To stop searching any time during search for DAB services, press CANCEL or PTY SEARCH.
- To continue searching after it stops on an unwanted program/service, press PTY SEARCH again while the PTY code is flashing on the display.
- If no program/service is found, "NOTFOUND" appears on the display.

Switching Temporarily to a Program of Your Choice Automatically

Radio Data System

The Enhanced Other Networks function allows the System to switch temporarily to a preset FM station broadcasting a program of your choice (TA, NEWS, or INFO).

- This function works while listening to an FM program providing the required signals.

Press repeatedly to select the program type as follows:

TA	Traffic announcement in your area
NEWS	News
INFO	Program the purpose of which is impart advice in the widest sense.

How the Enhanced Other Networks function actually works:

When a station starts broadcasting the program of your choice, the System automatically switches to the station. The PTY code indicator starts flashing.

After the program is over, the System goes back to the previously tuned station, but the function still remains active (the indicator stops flashing and remains lit).

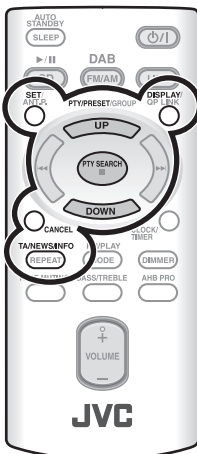

Presetting Stations and Services

You can preset 30 FM stations, 15 AM stations and 30 DAB services manually.

- 1** Tune in to a station/service you want to preset.
 - You can also store the monaural reception mode for FM preset station if selected.
- 2** Press to activate the preset number entry mode.
 - Finish the following process while the indication on the display is flashing.
- 3** Press to select a preset number for the station/service you store.
- 4** Press to store the station/service.

NOTES

- If you store a new station/service into an occupied preset number, the previously stored one in that number will be erased.
- When you preset DAB services, you can only preset primary services. If you select a secondary service to store, its primary service is stored instead.
- When you unplug the AC power cord or if a power failure occurs, the preset stations/services will be erased in two days.

Connecting a Portable Audio Device

This System has LINE IN/OUT jacks to connect a portable audio device.

Connect between the device and the System by using the stereo mini plug cord (not supplied).

IMPORTANT:

It should be noted that it may be unlawful to re-record pre-recorded tapes, records, or discs without the consent of the owner of copyright in the sound or video recording, broadcast or cable programme and in any literary, dramatic, musical, or artistic embodied therein.

● Playing back a portable audio device

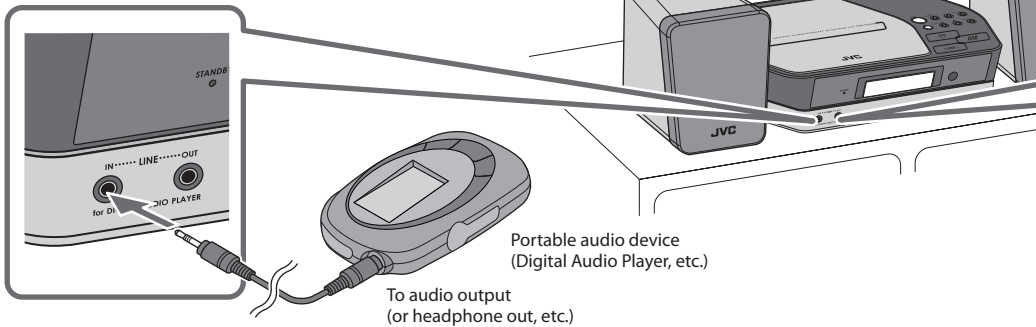

1  "LINE" appears on the main display.

2 Start playing the device connected.

3  Adjust the volume level to the level you want to listen to.

To Adjust the Audio Input Level

If the sound from the device connected to the LINE IN jack is too loud or too quiet, you can change the audio input level through the LINE IN jack (without changing the volume level).

On the remote  Press and hold for more than 2 seconds while "LINE" is selected as a source. You can select one of three levels alternately.

To Play Back a Portable Audio Device Easily

By using QP Link (Quick Portable Link), you can easily start playing back a portable audio device connected to the LINE IN jack.

On the remote  Press and hold for more than 2 seconds to activate QP Link. QP Link indicator appears on the display. **To cancel this function**, press and hold for more than 2 seconds again.

When QP Link is activated, connecting a portable device to the LINE IN jack and starting playback performs the following:

- While listening to another source...
Changes the source to "LINE" automatically. (If you change from "LINE" to another source, QP Link will be canceled.)
- While the System is on standby...
Turns on the System and changes the source to "LINE" automatically (except when the Save mode is on).

NOTE



See "Learning More about This System" on page 16.

NOTE

If an external device is not equipped with a stereo mini plug audio output, use a plug adaptor to convert the stereo mini plug to the corresponding plug of the audio output.

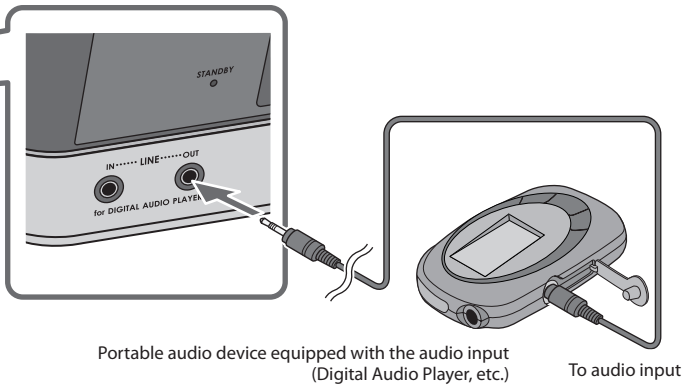
● **Recording to a portable audio device**



- 1** Start recording or standby recording on the device.
- 2**  or  Start playing the CD or tune into the station you want to recording.

To Select the Audio Output Level

If the recorded sound on the device connected to the LINE OUT jack is too loud or too quiet, you can change the audio output level through the LINE OUT jack (without changing the volume level).

On the System	Press to change the audio output level.
	You can select one of two levels alternately as follows:
	OUT_LVL1 ↔ OUT_LVL2

Setting the Clock and Daily Timer

● Setting the Clock

Without setting the built-in clock, you cannot use Daily Timer and Sleep Timer.

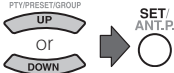
1		<p>Press to activate the clock setting mode.</p> <ul style="list-style-type: none"> If you have already adjusted the clock before, press the button repeatedly until the clock setting mode is selected.
2		<p>Adjust the hour, then the minute.</p>

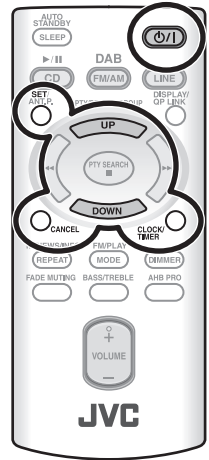

- To exit from the clock setting, press CLOCK/TIMER as required.
- To go back to the previous step, press CANCEL.



● Setting the Daily Timer

Using Daily Timer, you can wake up with your favorite music.

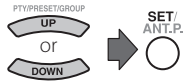
- You can store three Daily Timer settings; however, you can activate only one of Daily Timers at the same time.

1		<p>Press repeatedly to select one of the timer setting modes you want to set—DAILY 1 ON time, DAILY 2 ON time, or DAILY 3 ON time—as follows:</p> <pre> Daily 1 Timer Daily 2 Timer DAILY 1 → ON (Time) → DAILY 2 → ON (Time) Canceled ← Clock setting ← ON (Time) ← DAILY 3 (See above.) Daily 3 Timer </pre>
2		<ol style="list-style-type: none"> ① Adjust the hour then the minute for on-time. ② Adjust the hour then the minute for off-time. ③ Select the playback source—"DAB/FM/AM," "CD," or "LINE." ④ For "DAB/FM/AM": Select a preset channel. ⑤ For "LINE": Make the external device ready for playback. ⑤ Select the volume level. <ul style="list-style-type: none"> You can select the volume level ("VOLUME 0" to "VOLUME 31" and "VOLUME --"). If you select "VOLUME --," the volume is set to the last level when the System is turned off.
3		<p>Turn off the System (on standby).</p>

- To exit from the timer setting, press CLOCK/TIMER as required.
- To correct a misentry during the process, press CANCEL. You can return to the previous step.

To turn off the Daily Timer

1		<p>Press repeatedly to select "DAILY 1," "DAILY 2," or "DAILY 3."</p>
2		

To turn on the Daily Timer again, select one of the timer settings by pressing CLOCK/TIMER, then press SET.

Learning More about This System

Basic and Common Operations (see page 5)

- Sound adjustments also affect the sound through the headphones.
- Sound adjustments do not affect recording to the external device.
- You can set the clock and daily timer while the Save mode is turned on. While setting the clock or daily timer, the display is turning on.

Playing Back Discs (see pages 7)

- This System cannot play "packet write" discs.
- For MP3 playback...
 - MP3 discs are required a longer readout time than regular CDs. (It depends on the complexity of the group/file configuration.)
 - Some MP3 files cannot be played back and will be skipped. This result from their recording processes and conditions.
 - When making MP3 discs, use ISO 9660 Level 1 or Level 2 for the disc format.
 - This System can play back MP3 files with the extension code <.mp3> (regardless of the letter case—upper/lower).
 - It is recommended that you make each MP3 file at a sampling rate of 44.1 kHz and at bit rate of 128 kbps. This System cannot play back files made at bit rate of less than 64 kbps.
 - Playback order of MP3 tracks may be different from the one you have intended while recording. If a folder does not include MP3 tracks, they are ignored.
- This System can recognize up to 511 tracks in a disc. Also, the System can recognize up to 150 tracks per group and up to 99 groups in a disc. (for MP3)
 - If there are any unplayable files in a folder, those files are also counted in the total file number.
 - Playable files which do not belong to any groups are handled as Group 1.

Listening to the Radio (see page 9)

- The time shown on the display by changing the DAB information is based on the built-in clock of the system, not on the information sent through DAB.
- The Enhanced Other Networks function is available only when tuning in to FM.

Connecting a Portable Audio Device (see page 13)

Playing back a portable audio device:

- If a component connected to the LINE IN jack is not loud enough, QP Link may not work properly. In such cases, adjust the volume level of the component louder so that the System can detect the sound signal properly.
- Changing from "LINE" to another source while QP Link works will deactivate QP Link temporarily. In this case, the following reactivates QP Link:
 - Pressing QP LINK on the remote control
 - When no sound signal comes from the LINE IN jack for about 30 seconds after the System is turned off
- If you press O/N button to turn the System off or if preset Timer turns the System off while QP Link works, the System deactivates QP Link temporarily. In such cases, the following reactivates QP Link:
 - When no sound signal comes from the LINE IN jack for about 30 seconds after the System is turned off
 - When you turn on the power again

Setting the Clock and Daily Timer (see page 15)

- "0:00" will flash on the display until you set the clock.
- The clock may gain or lose 1 to 2 minutes per month. If this happens, readjust the clock.
- When you unplug the AC power cord or if a power failure occurs, the clock and the timer will be canceled. You need to set the clock first, then the timer again.
- When the on-time of the daily timer comes, the System sets the volume level gradually to the preset level after about 10 seconds.

Timer Priority:

- If you set the Sleep Timer after Daily Timer starts playing the selected source, Daily Timer is canceled.

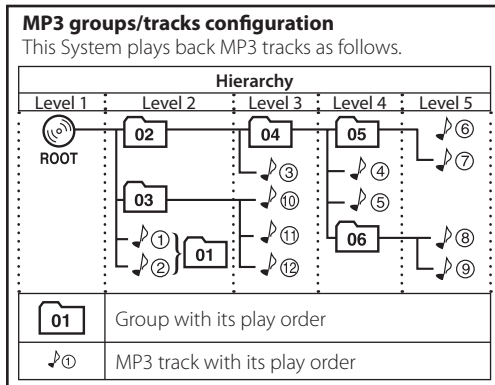

Troubleshooting

If you are having a problem with your System, check this list for a possible solution before calling for service.

General

Power does not come on.

- ➔ Power plug is not inserted securely. Plug in securely.

Adjustments or settings are suddenly canceled before you finish.

- ➔ There is a time limit. Repeat the procedure again.

Operations are disabled.

- ➔ The built-in microprocessor may malfunction due to external electrical interference. Unplug the AC power cord and then plug it back in.

Unable to operate the System from the remote control.

- ➔ The path between the remote control and the remote sensor on the System is blocked.
- ➔ The batteries are exhausted.

No sound is heard.

- ➔ Speaker connections are incorrect or loose.
- ➔ Headphones are connected.

Radio Operations

Hard to listen to broadcasts because of noise.

- ➔ Antennas connections are incorrect or loose.
- ➔ The AM loop antenna is too close to the System.
- ➔ The FM antenna is not properly extended and positioned.

Cannot receive an ensemble.

- ➔ Your area is not covered by the ensemble.
- ➔ The DAB antenna is not properly extended or positioned. Adjust the antenna and try the ensemble scanning again.
- ➔ Connect an active antenna (not supplied).

Disc Operations

The disc does not play.

- ➔ The disc is placed upside down. Place the disc with the label side up.
- ➔ MP3 disc is recorded with the "packet writing (UDF file)." It cannot be played. Check the files you want to play back.

ID3 Tag on an MP3 disc cannot be shown.

- ➔ There are two types of ID3 Tag—Version 1 and Version 2. This System can only show ID3 Tag Version 1.

MP3 groups and tracks are not played back as you expect.

- ➔ The playing order is determined when the disc was recorded. It depends on the writing application.

The disc sound is discontinuous.

- ➔ The disc is scratched or dirty.

The disc tray does not open or close.

- ➔ The AC power cord is not plugged in.

Timer Operations

Daily Timer does not work.

- ➔ The System has been turned on when the on-time comes. Timer starts working only when the System is turned off.

Maintenance

To get the best performance of the System, keep your discs and mechanism clean.

Handling discs

- Remove the disc from its case by holding it at the edge while pressing the center hole lightly.
- Do not touch the shiny surface of the disc, or bend the disc.
- Put the disc back in its case after use.
- Be careful not to scratch the surface of the disc when placing it back in its case.
- Avoid exposure to direct sunlight, temperature extremes, and moisture.

To clean the disc:

Wipe the disc with a soft cloth in a straight line from center to edge.

Cleaning the System

- Stains should be wiped off with a soft cloth. If the System is heavily stained, wipe it with a cloth soaked in water-diluted neutral detergent and wrung well, then wipe clean with a dry cloth.
- Since the System may deteriorate in quality, become damaged or get its paint peeled off, be careful about the following:
 - DO NOT wipe it with a hard cloth.
 - DO NOT wipe it strong.
 - DO NOT wipe it with thinner or benzine.
 - DO NOT apply any volatile substance such as insecticides to it.
 - DO NOT allow any rubber or plastic to remain in contact for a long time.

Specifications *Specifications and appearance are subject to change without prior notice.*

Amplifier section

OUTPUT POWER:

10 W (5 W + 5 W) at 4 Ω (10% THD)

Speakers/Impedance: 4 Ω – 16 Ω

Audio Input **LINE IN:**

500 mV/47 k Ω (at "LINE IN LVL1")

250 mV/47 k Ω (at "LINE IN LVL2")

125 mV/47 k Ω (at "LINE IN LVL3")

Audio Output **LINE OUT:**

1.0 Vrms (47 k Ω) (at "LINE OUT LVL1")

2.0 Vrms (47 k Ω) (at "LINE OUT LVL2")

Tuner section

FM Tuning range: 87.50 MHz - 108.00 MHz

AM (MW) Tuning range: 522 kHz - 1 629 kHz

DAB tuning range:

BAND III: 174.928 MHz - 239.200 MHz

L-BAND: 1 452.960 MHz - 1 490.624 MHz

CD player section

Dynamic range: 88 dB

Signal-to-noise ratio: 93 dB

Wow and flutter: Immeasurable

Speakers

Speaker units: 8 cm cone x 1

Impedance: 4 Ω

Dimensions (approx.):

130 mm x 171 mm x 136 mm (W/H/D)

Mass (approx.): 0.75 kg each

Supplied Accessories

See page 2.

General

Power requirements: AC 230 V \sim , 50 Hz

Power consumption:

20.0 W (Power on), 2.5 W (Standby mode)

2.0 W or less (Save mode)

Mass: 1.8 kg

Dimensions (W x H x D): 270 mm x 68.5 mm x 203 mm

Description of the PTY codes for Radio Data System and DAB

NEWS:	News.	WEATHER:	Weather reports and forecasts.
AFFAIRS:	Topical program expanding or enlarging upon the news—debate, or analysis.	FINANCE:	Stock Market reports, commerce, trading etc.
INFO:	Programs the purpose of which is to impart advice in the widest sense.	CHILDREN:	Programs targeted at a young audience.
SPORT:	Programs concerned with any aspect of sports.	SOCIAL/FACTUAL* ¹ :	Programs about sociology, history, geography, psychology and society.
EDUCATE:	Educational programs.	RELIGION:	Religious programs.
DRAMA:	All radio plays and serials.	PHONE IN:	Involving members of the public expressing their views either by phone or at a public forum.
CULTURE/ARTS* ¹ :	Programs concerning any aspect of national or regional culture, including language, theater, etc.	TRAVEL:	Travel information.
SCIENCE:	Programs about natural sciences and technology.	LEISURE:	Programs about recreational activities.
VARIED/TALK* ¹ :	Used for mainly speech-based programs such as quizzes, panel games and personality interviews.	JAZZ:	Jazz music.
POP M:	Commercial music of current popular appeal.	COUNTRY:	Songs which originate from, or continue the musical tradition of the American Southern States.
ROCK M:	Rock music.	NATION M:	Current popular music of the nation or region in that country's language.
EASY M:	Current contemporary music considered to be "easy-listening".	OLDIES:	Music from the so-called "golden age" of popular music.
LIGHT M/CLASSICL* ¹ :	Instrumental music, and vocal or choral works.	FOLK M:	Music which has its roots in the musical culture of a particular nation.
CLASSICS/CLASSICM* ¹ :	Performances of major orchestral works, symphonies, chamber music, etc.	DOCUMENT:	Programs concerning factual matters, presented in an investigative style.
OTHER M:	Music not fitting into any of the other categories.	TEST* ² :	Broadcasts for testing emergency broadcast equipment or unit.
		ALARM* ² :	Emergency announcement.
		NONE* ² :	No program type, undefined program, or difficult to categorize into particular types.

*¹ The PTY codes are different between Radio Data System and DAB. The former is for Radio Data System, and the latter is for DAB.

*² Only Radio Data System has this PTY code.

NOTE

Classification of the PTY codes for some FM stations may be different from the above list.

SAFETY INSTRUCTIONS

“SOME DOS AND DON'TS ON THE SAFE USE OF EQUIPMENT”

This equipment has been designed and manufactured to meet international safety standards but, like any electrical equipment, care must be taken if you are to obtain the best results and safety is to be assured.

☆☆

Do read the operating instructions before you attempt to use the equipment.

Do ensure that all electrical connections (including the mains plug, extension leads and interconnections between pieces of equipment) are properly made and in accordance with the manufacturer's instructions. Switch off and withdraw the mains plug when making or changing connections.

Do consult your dealer if you are ever in doubt about the installation, operation or safety of your equipment.

Do be careful with glass panels or doors on equipment.

☆☆

DON'T continue to operate the equipment if you are in any doubt about it working normally, or if it is damaged in any way—switch off, withdraw the mains plug and consult your dealer.

DON'T remove any fixed cover as this may expose dangerous voltages.

DON'T leave equipment switched on when it is unattended unless it is specifically stated that it is designed for unattended operation or has a standby mode.

Switch off using the switch on the equipment and make sure that your family know how to do this.

Special arrangements may need to be made for infirm or handicapped people.

DON'T use equipment such as personal stereos or radios so that you are distracted from the requirements of traffic safety. It is illegal to watch television whilst driving.

DON'T listen to headphones at high volume as such use can permanently damage your hearing.

DON'T obstruct the ventilation of the equipment, for example with curtains or soft furnishings.

Overheating will cause damage and shorten the life of the equipment.

DON'T use makeshift stands and NEVER fix legs with wood screws—to ensure complete safety always fit the manufacturer's approved stand or legs with the fixings provided according to the instructions.

DON'T allow electrical equipment to be exposed to rain or moisture.

ABOVE ALL

- NEVER let anyone, especially children, push anything into holes, slots or any other opening in the case—this could result in a fatal electrical shock.;
- NEVER guess or take chances with electrical equipment of any kind—it is better to be safe than sorry!

JVC



Free Manuals Download Website

<http://myh66.com>

<http://usermanuals.us>

<http://www.somanuals.com>

<http://www.4manuals.cc>

<http://www.manual-lib.com>

<http://www.404manual.com>

<http://www.luxmanual.com>

<http://aubethermostatmanual.com>

Golf course search by state

<http://golfingnear.com>

Email search by domain

<http://emailbydomain.com>

Auto manuals search

<http://auto.somanuals.com>

TV manuals search

<http://tv.somanuals.com>