

JVC



MICRO COMPONENT SYSTEM

UX-P400

—Consists of CA-UXP400 and SP-UXP400

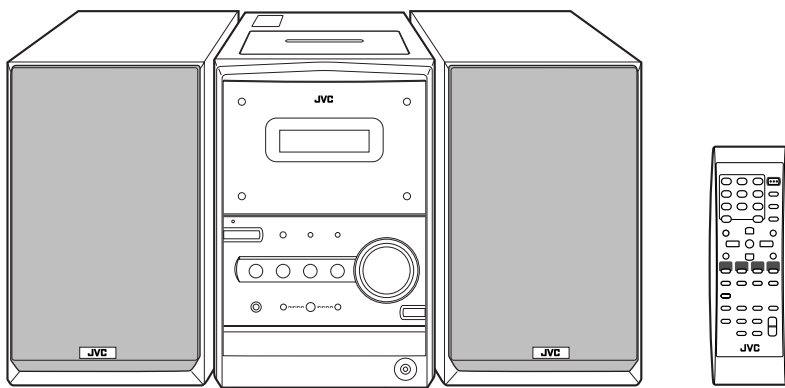

COMPACT
disc
DIGITAL AUDIO

MP3
PLAYBACK

R-D-S

INSTRUCTIONS

Warnings, Cautions and Others

IMPORTANT for the U.K.

DO NOT cut off the mains plug from this equipment. If the plug fitted is not suitable for the power points in your home or the cable is too short to reach a power point, then obtain an appropriate safety approved extension lead or consult your dealer.

BE SURE to replace the fuse only with an identical approved type, as originally fitted.

If nonetheless the mains plug is cut off ensure to remove the fuse and dispose of the plug immediately, to avoid a possible shock hazard by inadvertent connection to the mains supply.

If this product is not supplied fitted with a mains plug then follow the instructions given below:

IMPORTANT:

DO NOT make any connection to the terminal which is marked with the letter E or by the safety earth symbol or coloured green or green-and-yellow.

The wires in the mains lead on this product are coloured in accordance with the following code:

Blue: Neutral
Brown: Live

As these colours may not correspond with the coloured markings identifying the terminals in your plug proceed as follows:

The wire which is coloured blue must be connected to the terminal which is marked with the letter N or coloured black.

The wire which is coloured brown must be connected to the terminal which is marked with the letter L or coloured red.

IF IN DOUBT - CONSULT A COMPETENT ELECTRICIAN.

IMPORTANT FOR LASER PRODUCTS

1. CLASS 1 LASER PRODUCT
2. **CAUTION:** Do not open the top cover. There are no user serviceable parts inside the unit; leave all servicing to qualified service personnel.
3. **CAUTION:** Visible and invisible laser radiation when open and interlock failed or defeated. Avoid direct exposure to beam.
4. REPRODUCTION OF LABEL: CAUTION LABEL, PLACED INSIDE THE UNIT.

CAUTION - Visible and invisible laser radiation when open and interlock failed or defeated. AVOID DIRECT EXPOSURE TO BEAM.	ADVARSEL - Synlig og usynlig laserstråling når maskinen er åben eller interlocken fejler. Undgå direkte eksponering til strålingen.	VARNING - Synlig och osynlig laserstråling när den öppnas och spårren är urkopplad. Beträkta ej strålen.	VARO - Arvattessa ja suojelukitus ohjattuna tai valittuna olet alitina näkyvälle ja näkymättömälle lasersäteilylle. Vältä säteen kohdistamista suoraan iksesi. (f)
---	--	---	---

CAUTION

- Do not block the ventilation openings or holes. (If the ventilation openings or holes are blocked by a newspaper or cloth, etc., the heat may not be able to get out.)
- Do not place any naked flame sources, such as lighted candles, on the apparatus.
- When discarding batteries, environmental problems must be considered and local rules or laws governing the disposal of these batteries must be followed strictly.
- Do not expose this apparatus to rain, moisture, dripping or splashing and that no objects filled with liquids, such as vases, shall be placed on the apparatus.

CAUTION—STANDBY/ON \odot /I button!

Disconnect the mains plug to shut the power off completely (all lamps and indications go off). The STANDBY/ON \odot /I button in any position does not disconnect the mains line.

- When the unit is on standby, the STANDBY/ON lamp lights in red.
- When the unit is turned on, the STANDBY/ON lamp lights in green.

The power can be remote controlled.

CAUTION

To reduce the risk of electrical shocks, fire, etc.:

1. Do not remove screws, covers or cabinet.
2. Do not expose this appliance to rain or moisture.

Caution: Proper Ventilation

To avoid risk of electric shock and fire, and to prevent damage, locate the apparatus as follows:

1. Front: No obstructions and open spacing.
2. Sides/ Top/ Back: No obstructions should be placed in the areas shown by the dimensions below.
3. Bottom: Place on the level surface. Maintain an adequate air path for ventilation by placing on a stand with a height of 10 cm or more.

Front view

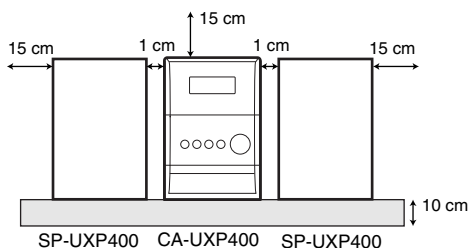

Side view

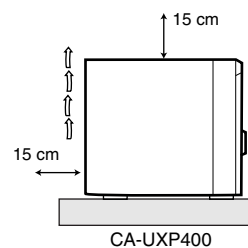

Contents

Introduction.....	2
Precautions.....	2
How to Read This Manual.....	2
Getting Started.....	3
Step 1: Unpack.....	3
Step 2: Prepare the Remote Control	3
Step 3: Hook Up	4
Before Operating the System	7
Daily Operations—Playback.....	8
Listening to the Radio.....	8
Playing Back a Disc	9
Playing Back a Tape	10
Daily Operations—Sound&Other Adjustments	11
Adjusting the Volume.....	11
Adjusting the Sound	11
Changing the Display Brightness	12
Setting the Clock.....	12
Turning Off the Power Automatically	12
Advanced Radio Operations	13
Receiving FM Stations with RDS.....	13
Searching for a Program by PTY Codes.....	13
Switching Temporarily to a Program of Your Choice Automatically	14
Advanced Disc Operations	16
Programming the Playing Order—Program Play	16
Playing at Random—Random Play	17
Playing Repeatedly—Repeat Play	18
Prohibiting Disc Ejection—Child Lock.....	18
Advanced Tape Operations.....	19
Recording on a Tape	19
Synchronized Disc Recording	20
Timer Operations.....	21
Setting the Timer	21
Additional Information	24
Learning More about This System	24
Troubleshooting	25
Maintenance.....	25
Specifications.....	26
Parts Index	26

Introduction

Precautions

Installation

- Install in a place which is level, dry and neither too hot nor too cold—between 5°C and 35°C.
- Install the System in a location with adequate ventilation to prevent internal heat buildup inside the System.



DO NOT install the System in a location near heat sources, or in a place subject to direct sunlight, excessive dust or vibration.

- Leave sufficient distance between the System and the TV.
- Keep the speakers away from the TV to avoid interference with TV.

Power sources

- When unplugging the System from the wall outlet, always pull on the plug, not the AC power cord.



DO NOT handle the AC power cord with wet hands.

Moisture condensation

Moisture may condense on the lenses inside the System in the following cases:

- After starting to heat the room
- In a damp room
- If the System is brought directly from a cold to a warm place

Should this occur, the System may malfunction. In this case, leave the System turned on for a few hours until the moisture evaporates, unplug the AC power cord, then plug it in again.

Others

- Should any metallic object or liquid fall into the System, unplug the AC power cord and consult your dealer before operating any further.



DO NOT disassemble the System since there are no user serviceable parts inside.

- If you are not going to operate the System for an extended period of time, unplug the AC power cord from the wall outlet.

If anything goes wrong, unplug the AC power cord and consult your dealer.

How to Read This Manual

To make this manual as simple and easy-to-understand as possible, we have adapted the following methods:

- Button and control operations are explained as listed in the table below. In this manual, the operations using the remote control is mainly explained; however, you can use the buttons and controls on the main unit if they have the same (or similar) name and marks.
- **Some related tips and notes are explained later in the sections “Learning More about This System” and “Troubleshooting,” but not in the same section explaining the operations.** If you want to know more about the functions, or if you have a doubt about the functions, go to these sections and you will find the answers.

	Indicates that you press the button briefly .
	Indicates that you press the button briefly and repeatedly until an option you want is selected.
	Indicates that you press one of the buttons.
	Indicate that you press and hold the button for specified seconds. <ul style="list-style-type: none"> • The number inside the arrow indicates the period of press (in this example, 2 seconds). • If no number is inside the arrow, press and hold until the entire procedure is complete or until you get a result you want.
	Indicate that you turn the control toward the specified direction(s).

	Indicates that this operation is only possible using the remote control.
	Indicates that this operation is only possible using the buttons and controls on the main unit.

Getting Started

Step 1: Unpack the package and check the accessories.



Step 1: Unpack

After unpacking, check to be sure that you have all the following items. The number in parentheses indicates the quantity of each piece supplied.

- FM antenna (1)
- AM loop antenna (1)
- Remote control (1)
- Batteries (2)

If any item is missing, consult your dealer immediately.

Step 2: Prepare the Remote Control

Insert the batteries into the remote control by matching the polarity (+ and -) correctly.

Step 2: Prepare the remote control.

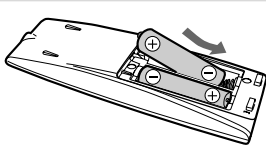

1

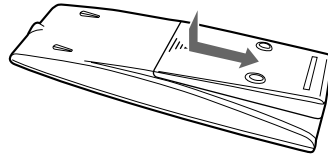

2

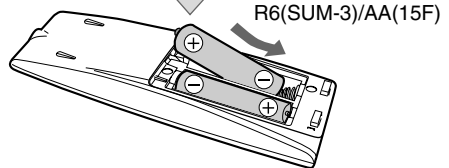

3

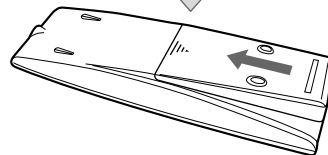

Step 3: Hook up the components such as AM/FM antennas, speakers, etc. (see pages 4 to 6).

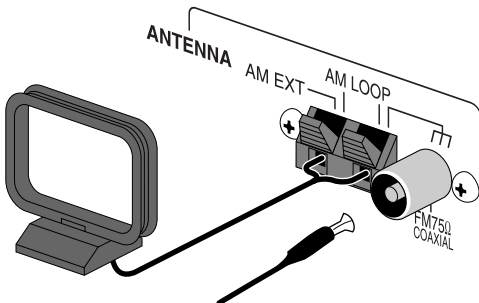

Finally plug the AC power cord.
Now you can operate the System.



- DO NOT use an old battery together with a new one.
- DO NOT use different types of batteries together.
- DO NOT expose batteries to heat or flame.
- DO NOT leave the batteries in the battery compartment when you are not going to use the remote control for an extended period of time. Otherwise, the remote control will be damaged from battery leakage.

Step 3: Hook Up

If you need more detailed information, see page 6.

Illustrations of the input/output terminals below are typical examples.
When you connect other components, refer also to their manuals since the terminal names actually printed on the rear may vary.

Turn the power off to all components before connections.

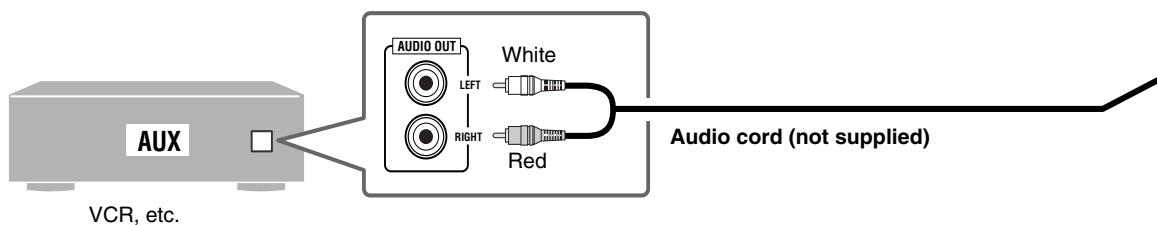
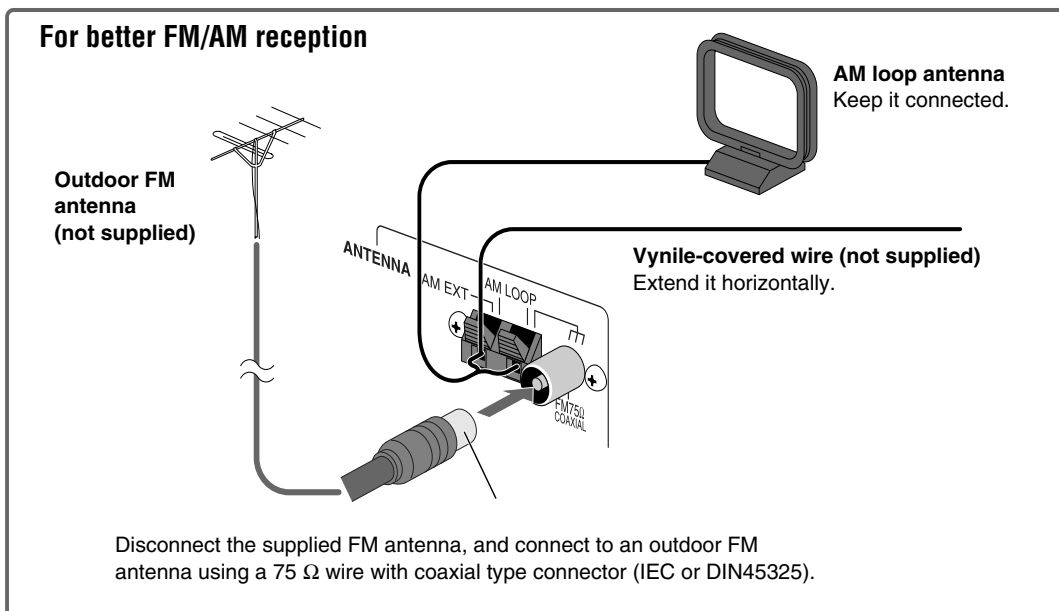

To a wall outlet
Plug the AC power cord only after all connections are complete.

FM antenna (supplied)

Extend it so that you can obtain the best reception.

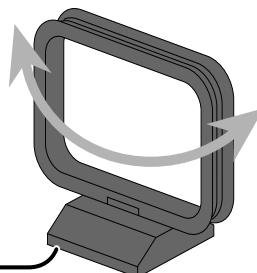

AM loop antenna (supplied)
Turn it until the best reception is obtained.

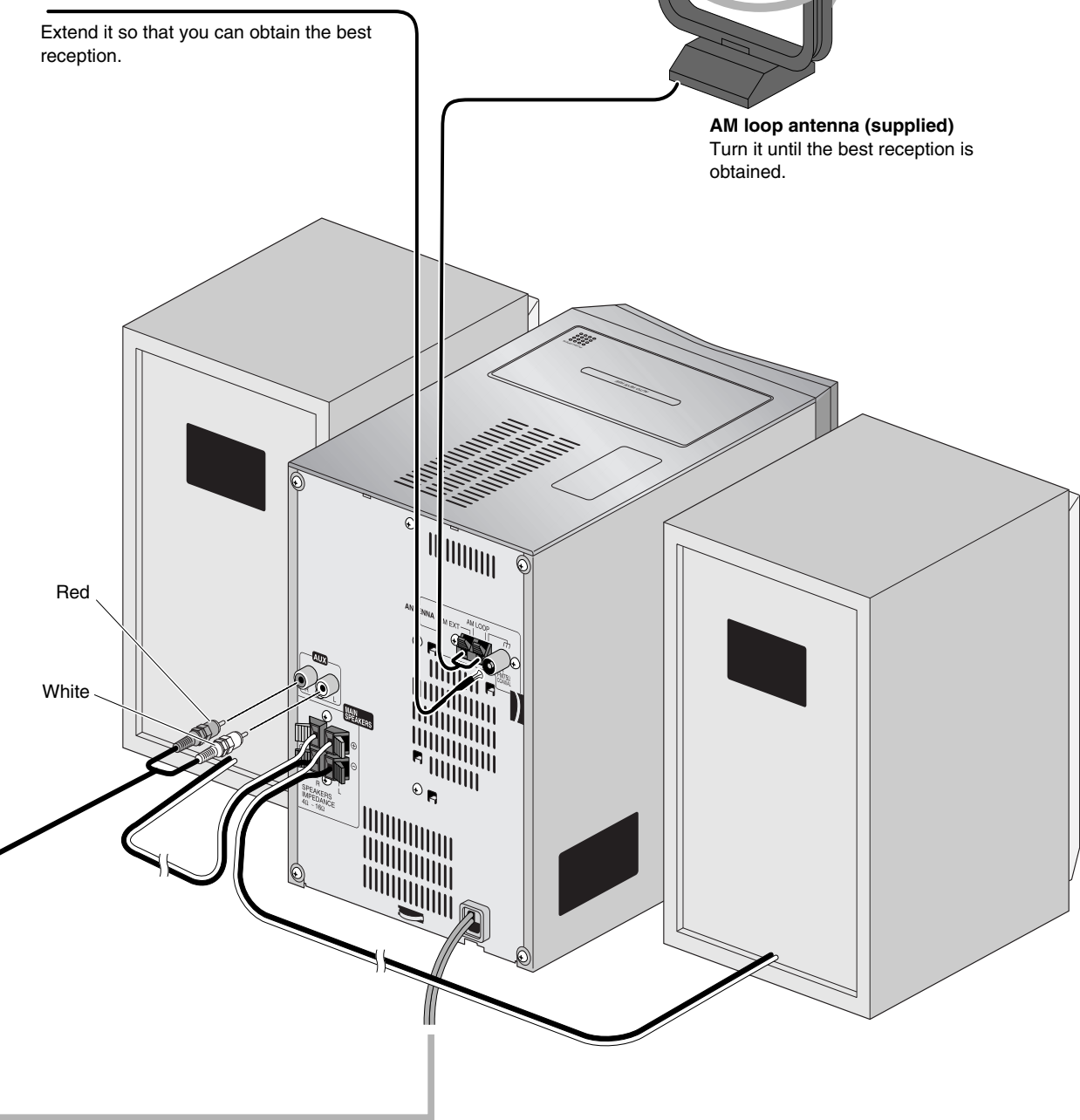

Red
White

To assemble and connect the AM loop antenna

To assemble the AM loop antenna

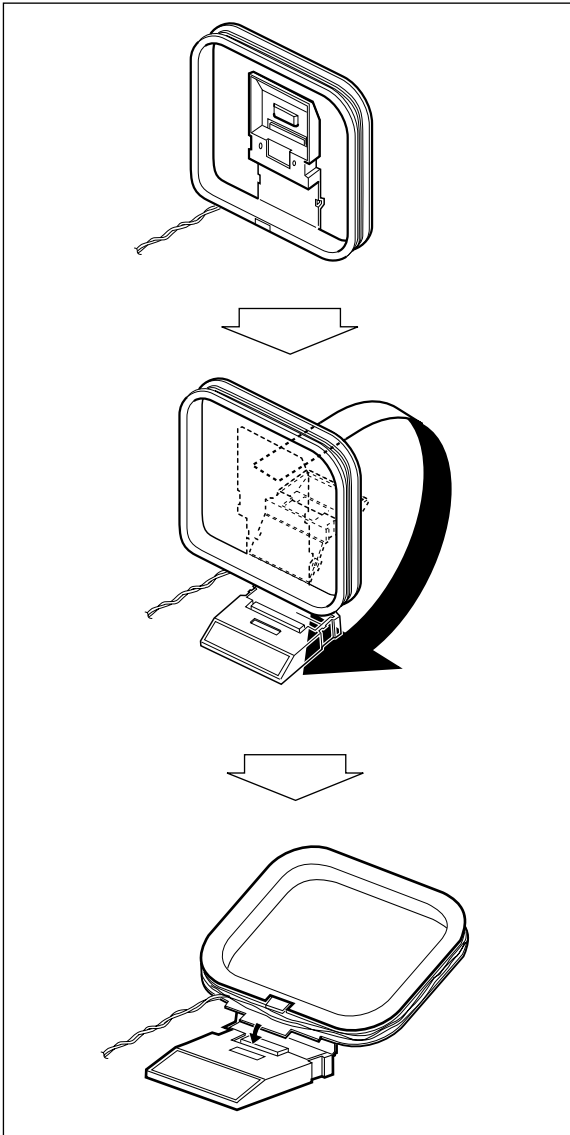

To connect the AM loop antenna

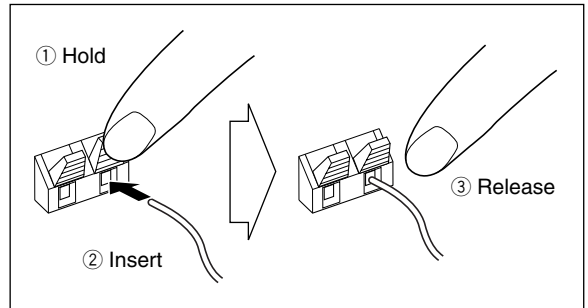

- If the AM loop antenna wire or speaker cords are covered with vinyl, remove the vinyl to expose the tip of the antenna by twisting the vinyl.
- Make sure the antenna conductors do not touch any other terminals, connecting cords and power cord. Also, keep the antennas away from metallic parts of the System, connecting cords, and the AC power cord. This could cause poor reception.

To connect the speaker cords

Make sure the both speakers are connected correctly and firmly.

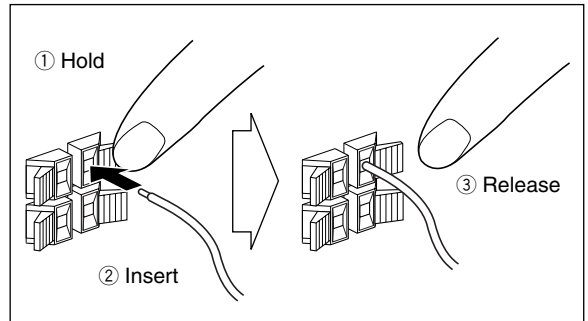

When connecting the speaker cords, match the polarity of the speaker terminals: Red cord to (+) and black cord to (-).



- DO NOT connect more than one speaker to each terminal.
- DO NOT allow the conductor of the speaker cords to be in touch with the metallic parts of the System.

Before Operating the System

The indications on the display teach you a lot of things while you are operating the System. Before operating the System, be familiar with when and how the indicator illuminates on the display.

Indications on the main display

- While listening to radio:
 - While selecting "TAPE" or "AUX":
- While playing a CD/MP3*:
- While disc play is stopped:

CD:

MP3:

* When you start playing an MP3 disc, the group number, track number, track name, (and ID3 Tag) will be shown before the elapsed playing time appears.

- 3 FM reception indicators
 - MONO: lights while receiving an FM stereo station in monaural.
 - ST (stereo): lights while an FM stereo station with sufficient signal strength is tuned in.
- 4 MP3 indicator
 - Lights when an MP3 track is detected.
- 5 REC indicator
 - Lights while recording.
- 6 Tape operation indicators
 - ◀▶ (tape direction):
 - Lights to indicate the current tape running direction.
 - Flashes slowly during playback and recording.
 - Flashes quickly while rewinding a tape.
 - ⏮ (reverse mode):
 - ⏮: tape play continues endlessly.
 - ⏮: tape automatically reverses once.
 - ⏮: tape play stops at the end of one side.
- 7 Disc operation indicators
 - RANDOM: lights when Random Play mode is activated.
 - PRGM (program): lights when Program Play mode is activated.
 - ⏮ (repeat)/ALL:
 - ⏮: lights when One Track Repeat is activated.
 - ⏮ ALL: lights when All Track Repeat is activated.
- 8 Main display
- 9 Radio Data System (RDS) indicators
 - RDS: lights when an FM station sending RDS signals is tuned in.
 - TA/News/Info—Program type (PTY) indicator:
 - Lights to indicate the currently selected program type for PTY Standby Reception.
 - Flashes when a program is automatically tuned in with PTY Standby Reception.
- 10 A(auto). STANDBY indicator
 - Lights when Auto Standby is activated.
 - Flashes when disc or tape playback stops with Auto Standby activated.

- 1 Rhythm Ax indicator
 - Lights when Rhythm Ax is activated.
- 2 Timer indicators
 - ⌚: lights when Daily Timer or Recording Timer stands by; flashes while setting or is working.
 - 1/2/3: lights when a Daily Timer (1, 2, or 3) stands by; flashes while setting or is working.
 - REC: lights when the Recording Timer stands by; flashes while setting or is working.
 - SLEEP: lights when the Sleep Timer is activated.

Daily Operations—Playback

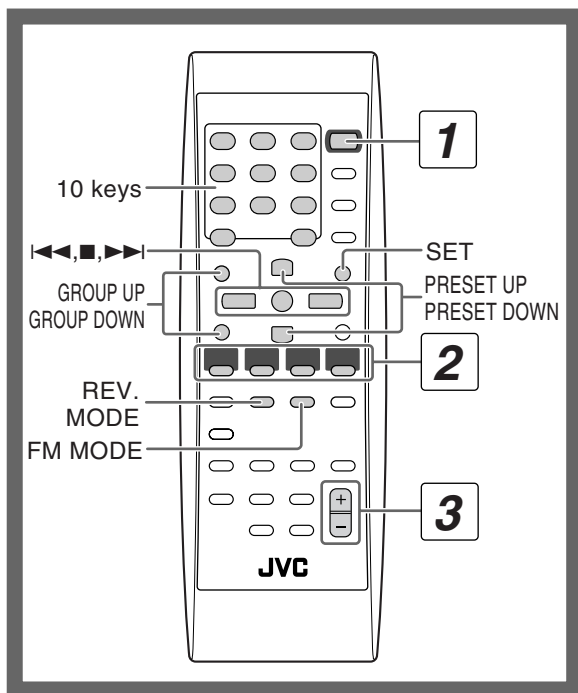

1 Turn on the power.

The STANDBY/ON lamp on the main unit lights in green.

- Without pressing STANDBY/ON , the System turns on by pressing one of the source selecting buttons in the next step.

2 Select the source.

Playback automatically starts if the selected source is ready to start.

- If you press AUX, start playback source on the external component.

3 Adjust the volume.

4 Operate the target source as explained later.

To turn off (stand by) the unit

STANDBY/ON

The STANDBY/ON lamp on the main unit lights in red.

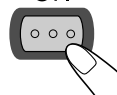

- A small amount of power is always consumed even while on standby.

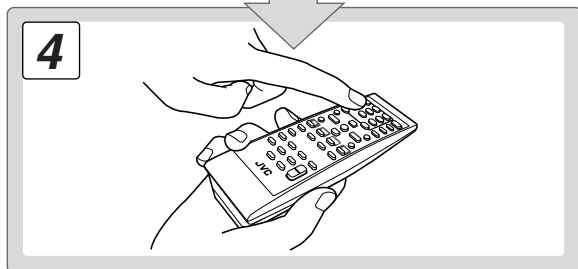
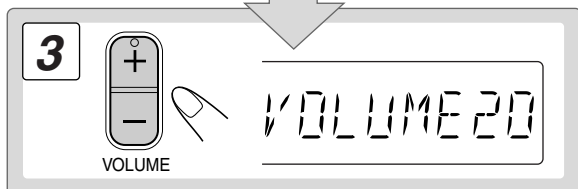
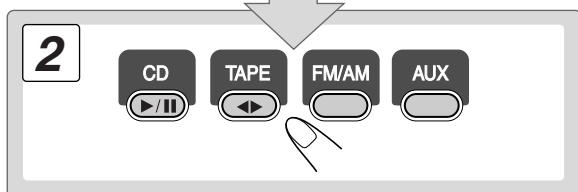
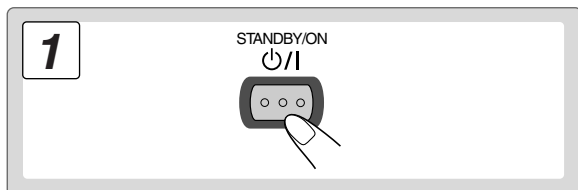

For private listening

Connect a pair of headphones to the PHONES jack on the main unit. The sound will no longer come out of the speakers. Be sure to turn down the volume before connecting or putting the headphones.

- Disconnecting the headphones will activate the speakers again.



DO NOT turn off (stand by) the System with the volume set to an extremely high level; Otherwise, the sudden blast of sound can damage your hearing, speakers and/or headphones when you turn on the System or start playback.

Listening to the Radio

To select the band (FM or AM)

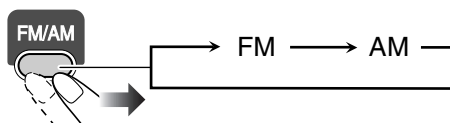

To tune in to a station

While FM or AM is selected...

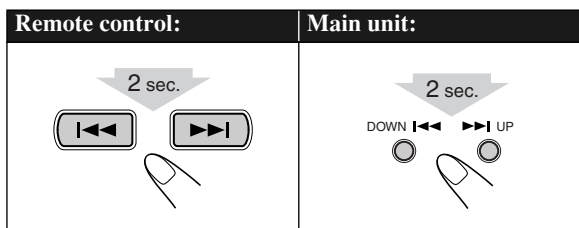

Frequency starts changing on the display.

When a station (frequency) with sufficient signal strength is tuned in, the frequency stops changing.

- When you repeatedly press the button, the frequency changes step by step.

To stop searching manually, press either button.

If the received FM station is hard to listen

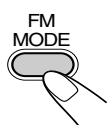

The MONO indicator lights on the display. Reception will improve though stereo effect is lost—Monaural reception mode.

To restore the stereo effect, press the button again (the MONO indicator goes off).

To preset the stations



You can preset 30 FM and 15 AM stations.

1 Tune in to a station you want to preset.

- You can also store the monaural reception mode for FM preset stations if selected (see above).

2 Activate the preset number entry mode.



- Finish the following process while the indication on the display is flashing.

3 Select a preset number for the station you store.

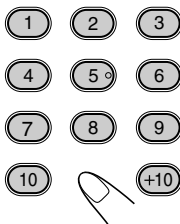

Examples:

To select preset number 5, press 5.

To select preset number 15, press +10, then 5.

To select preset number 30, press +10, +10, then 10.

- You can also use the PRESET UP/PRESET DOWN buttons.

4 Store the station.

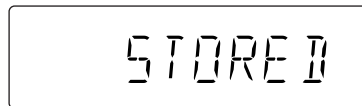

To tune in to a preset station



1 Select the band (FM or AM).

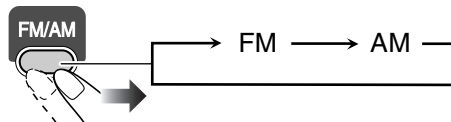

2 Select a preset number for the station you store.

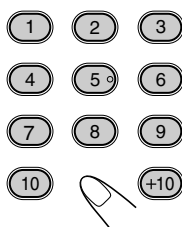

- You can also use the PRESET UP/PRESET DOWN buttons.

Playing Back a Disc



This System can play back the following discs—regular CD and CD-R/CD-RW (recorded either in the audio CD or MP3 format).

To insert a disc

You can insert a disc while playing another source.

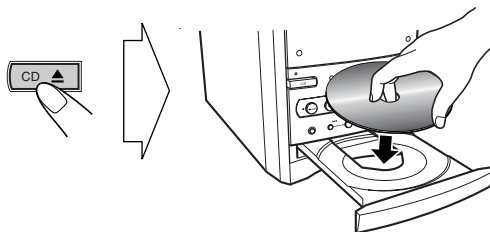

To close the disc tray, press ▲ again.

- If you press ►, disc tray closes automatically and playback starts.



To start:	To pause:	To stop:
	To release, press again.	

To select a track

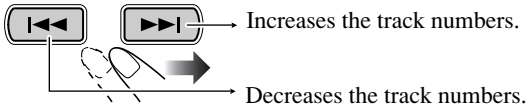

To select a group (MP3 only)



Before starting playback...

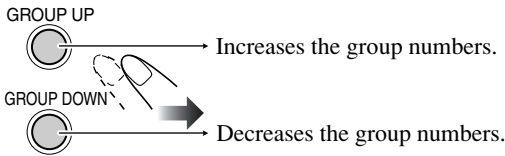

Group number and group name appear.

To locate a particular portion

While playing a disc, press and hold until the portion you want is reached.

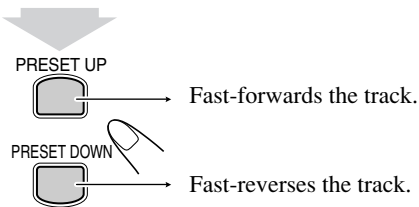

To locate a track directly and start play

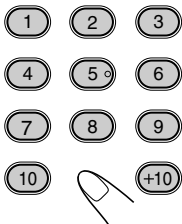

Examples:

- To select track number 5, press 5.
- To select track number 15, press +10, then 5.
- To select track number 30, press +10, +10, then 10.

Playing Back a Tape

To insert a tape

You can play back tapes of types I, II, and IV.

Push Insert Close

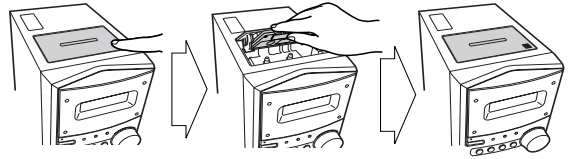

With the tape side facing outside

To start:	To stop:
To rewind tape:	
Before or after play...	
Rewind the tape to the right.	Rewind the tape to the left.

To change the tape running direction

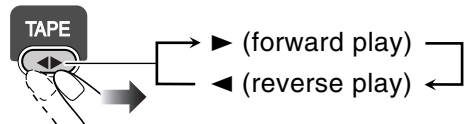

To reverse the tape automatically

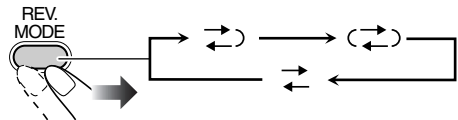

	Tape is played from the forward side to the reverse side. When the reverse side is played back, playback stops.
	Tape is automatically reversed, and playback repeats until you stop it.
	Tape will not be reversed. When the current side of the tape reaches its end, playback stops.

Changing the Display Brightness

You can dim the display window.

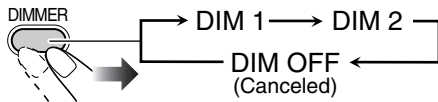

DIM 1	Dims the display.
DIM 2	Erases the display illumination.

Setting the Clock

Without setting the built-in clock, you cannot use Daily/Recording Timers (see page 21) and Sleep Timer.

- To exit from the clock setting, press CLOCK/TIMER as required.
- To go back to the previous step, press CANCEL.

1 Activate the clock setting mode.



- If you have already adjusted the clock before, press the button repeatedly until the clock setting mode is selected.

2 Adjust the hour.

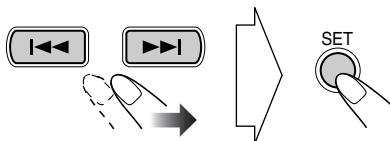

3 Adjust the minute.

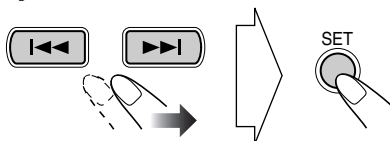

Now the built-in clock starts working.

To check the current time during play

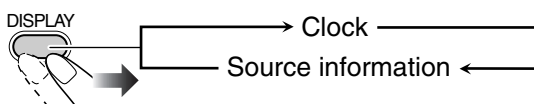

Turning Off the Power Automatically

To turn off the unit after playback is over—Auto Standby

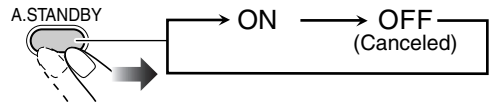

When Auto Standby is in use, the A.STANDBY indicator lights on the display.

When the tape or disc play stops, the A.STANDBY indicator starts flashing. If no operation is done for about 3 minutes while the indicator is flashing, the System turns off (stands by) automatically.

- Auto Standby does not work while you are listening to radio and the external component (AUX).

To turn off the unit after a certain period of time—Sleep Timer

1 Specify the time (in minutes).

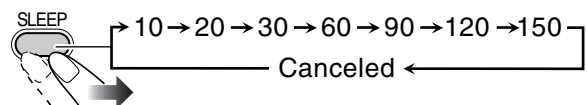

2 Wait until the set time goes off.

To check the time remaining until the shut-off time



- If you press the button repeatedly, you can change the shut-off time.

Advanced Radio Operations

Remote control

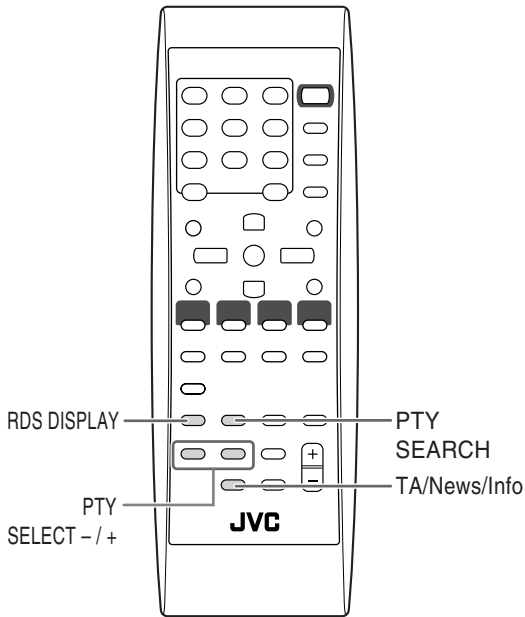

To show the RDS information

While listening to an FM station...



PS	Station names is displayed. "NO PS" will appear if no signal is sent.
PTY	The broadcast program type is displayed. "NO PTY" will appear if no signal is sent.
RT	Text messages the station sends is displayed. "NO RT" will appear if no signal is sent.

Searching for a Program by

PTY Codes



You can locate a particular kind of program from the preset channels (see page 9) by specifying the PTY codes.

To search for a program using the PTY codes

1 While listening to an FM station...



2 Select a PTY code.

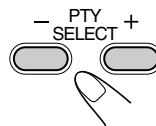

• For details about each PTY code, see page 15.

Receiving FM Stations with RDS



Radio Data System (RDS) allows FM stations to send an additional signal along with their regular program signals.

- When tuned to an FM station which provides the RDS service, the RDS indicator lights on the display.

This System can receive the following types of RDS signals.

PS (Program Service)	Shows commonly known station names.
PTY (Program Type)	Shows types of broadcast programs.
RT (Radio Text)	Shows text messages the station sends.
Enhanced Other Networks	Provides the information about the types of the programs broadcast by the RDS stations of the different networks.

3 Start searching.

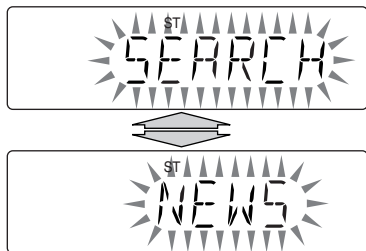

Ex. When "NEWS" is selected

The receiver searches 30 preset FM stations, stops when it finds the one you have selected, and tunes in to that station.

- If no program is found, "NOTFOUND" appears on the display.
- To stop searching any time during search, press PTY SEARCH.

To continue searching after it stops on an unwanted station

While the indications on the display are flashing...



Switching Temporarily to a Program of Your Choice Automatically



The Enhanced Other Networks function allows the System to switch temporarily to a preset FM station broadcasting a program of your choice (TA, NEWS, or INFO).

- This function works while listening to an FM station providing the required signals.

While listening to an FM station, select the program type.

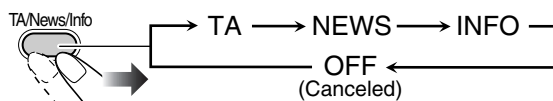

TA	Traffic announcement in your area
NEWS	News
INFO	Program the purpose of which is to impart advice in the widest sense

How the Enhanced Other Networks function actually works:

CASE 1

If a station is not broadcasting the program of your choice

The System continues tuning in to the current station.



When a station broadcasting the program of your choice, the System automatically switches to the station. The PTY code indicator starts flashing.



When the program is over, the System goes back to the previously tuned station, but the function still remains active (the indicator stops flashing and remains lit).

CASE 2

If a station is broadcasting the program of your choice

The System automatically switches to the station. The PTY code indicator starts flashing.



When the program is over, the System goes back to the previously tuned station, but the function still remains active (the indicator stops flashing and remains lit).

CASE 3

If the station currently tuned in is broadcasting the program of your choice

The PTY code indicator starts flashing.



When the program is over, the indicator stops flashing (the function still remains active).



Description of the PTY codes

NEWS	News.
AFFAIRS	Topical program expanding or enlarging upon the news—debate, or analysis.
INFO	Programs the purpose of which is to impart advice in the widest sense.
SPORT	Programs concerned with any aspect of sports.
EDUCATE	Educational programs.
DRAMA	All radio plays and serials.
CULTURE	Programs concerning any aspect of national or regional culture, including language, theater, etc.
SCIENCE	Programs about natural sciences and technology.
VARIED	Used for mainly speech-based programs such as quizzes, panel games, and personality interviews.
POP M	Commercial music of current popular appeal.
ROCK M	Rock music.
EASY M	Current contemporary music considered to be “easy-listening.”
LIGHT M	Instrumental music, and vocal or choral works.
CLASSICS	Performances of major orchestral works, symphonies, chamber music, etc.
OTHER M	Music which is not fitting into any of the other categories.
WEATHER	Weather reports and forecasts.
FINANCE	Stock Market reports, commerce, trading etc.
CHILDREN	Programs targeted at a young audience.
SOCIAL	Programs about sociology, history, geography, psychology, and society.
RELIGION	Religious programs.

PHONE IN	Involving members of the public expressing their views either by phone or at a public forum.
TRAVEL	Travel information.
LEISURE	Programs about recreational activities.
JAZZ	Jazz music.
COUNTRY	Songs which originate from, or continue the musical tradition of the American Southern States.
NATION M	Current popular music of the nation or region in that country’s language.
OLDIES	Music from the so-called “golden age” of popular music.
FOLK M	Music which has its roots in the musical culture of a particular nation.
DOCUMENT	Programs concerning factual matters, presented in an investigative style.
TEST	Broadcasts for testing emergency broadcast equipment or unit.
ALARM	Emergency announcement.
NONE	No program type, undefined program, or difficult to categorize into particular types.

Classification of the PTY codes for some FM stations may be different from the above list.

Advanced Disc Operations

Remote control

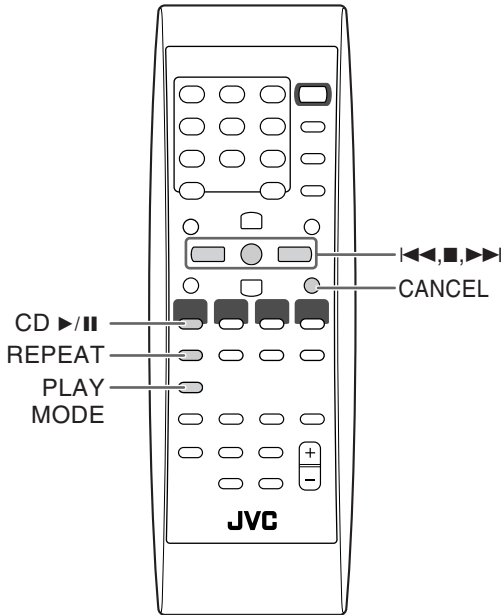

Main unit

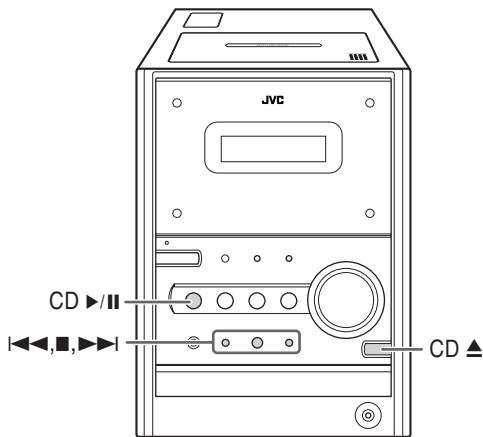

Programming the Playing Order—

Program Play

You can arrange the playing order of the tracks (up to 50) before you start playback.

1 Before starting playback, activate Program Play.

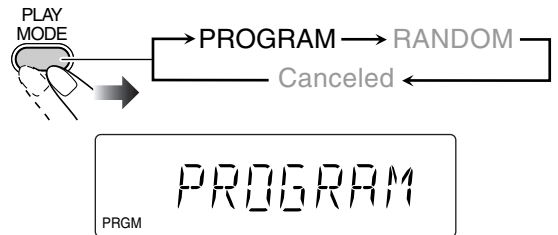

2 Select tracks you want for Program Play.

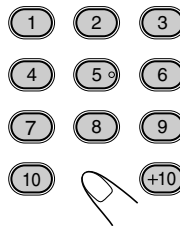



Examples:

- To select track number 5, press 5.
- To select track number 15, press +10, then 5.
- To select track number 30, press +10, +10, then 10.

3 Start playback.

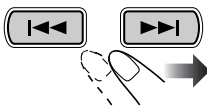

The tracks you have selected are played back in the order you have programmed.

To skip a track:	To pause:	To stop:
	 To release, press again.	

To check the programmed contents

Before or after playback...

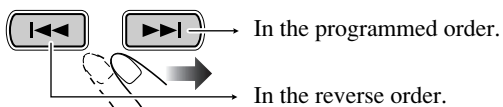

To modify the program

Before or after playback...

To erase the last step:	To erase the entire program:
To add steps in the program:	
Repeat step 2.	

To exit from Program Play

Before or after playback...



- Exiting from Program Play erases the stored program.

Playing at Random—Random Play

You can play all tracks at random.

1 Before starting playback, activate Random Play.

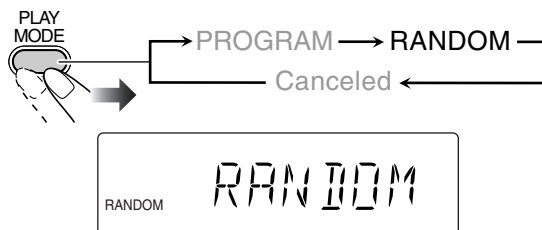

2 Start playback.



Playback starts in random order. Random Play ends when all tracks are played.

To skip a track:	To pause:	To stop:
◀ does not work.	To release, press again.	

To exit from Random Play

Before or after playback...



Playing Repeatedly—Repeat Play

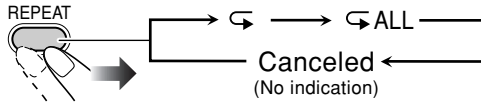

You can repeat playback.

Before starting playback...

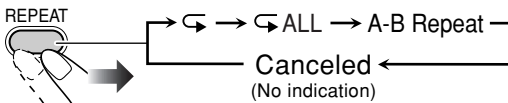

While playing...



	Repeats the current (or specified) track—One Track Repeat.
	Repeats all tracks—All Track Repeat.
A-B Repeat	See below for details. “A” starts flashing in the main display.

To repeat a particular portion—A-B Repeat

You can repeat a particular portion while playing back a CD.

1 During playback, activate A-B Repeat.

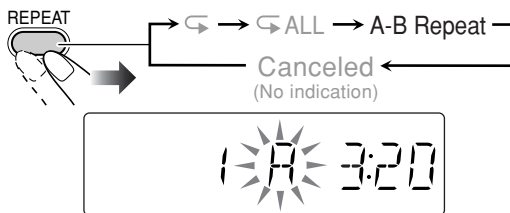

2 Select the start point (A).



3 Select the end point (B).



A-B Repeat starts. The selected portion plays repeatedly.

To cancel A-B Repeat



• A-B Repeat will also be canceled when you stop playback.

Prohibiting Disc Ejection—Child Lock

You can lock the disc tray so that no one can eject the loaded disc.

• This is possible while the System is on standby.

While the disc tray is closed...

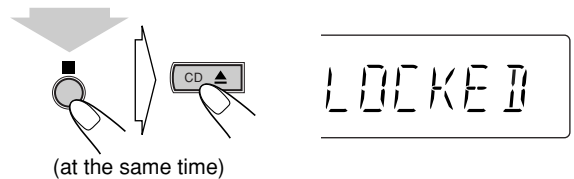

To cancel the prohibition, repeat the same procedure. “UNLOCKED” appears on the display.

Advanced Tape Operations

Remote control

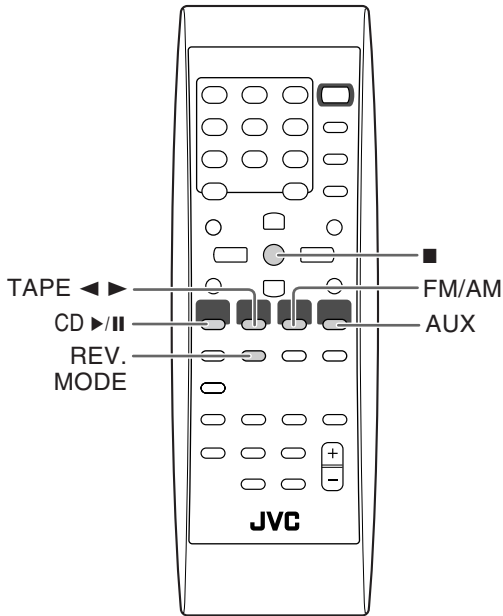

Main unit

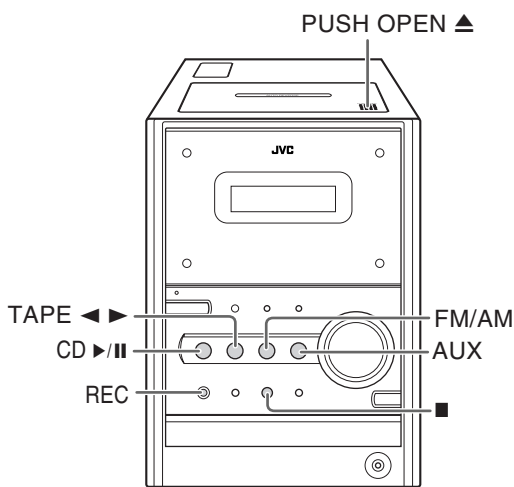

IMPORTANT

It should be noted that it may be unlawful to re-record pre-recorded tapes, records, or discs without the consent of the owner of copyright in the sound or video recording, broadcast or cable programme and in any literary, dramatic, musical, or artistic embodied therein.

Recording on a Tape

You can use type I tapes for recording.

- To play a tape, see page 10.

1 Insert a recordable cassette.

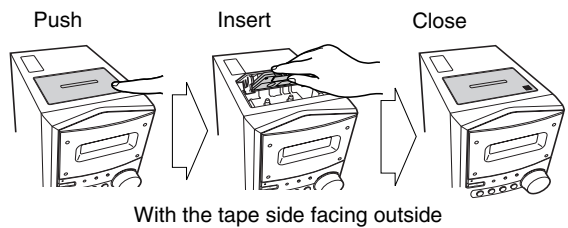

2 Check the tape running direction and Reverse Mode settings on the display.

Reverse mode indicator



Tape direction indicator

Current source

To change the direction

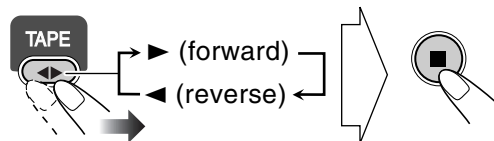

To change the Reverse mode if necessary

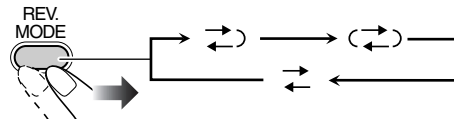

	To record on both sides.
	<ul style="list-style-type: none"> When using Reverse Mode, start recording in the forward (▶) direction.
	To record on only one side.

- 3 Select and start playing the source**—“FM,” “AM,” “CD,” or “AUX.”
- When recording a disc, you can also use “Synchronized Disc Recording” (see below).

4 Start recording.

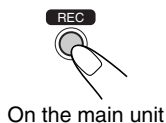

To stop recording:



Synchronized Disc Recording

You can start and stop both disc play and tape recording at the same time.

To record the entire disc

- 1 Load a disc and insert a recordable cassette.**
 - If the current playing source is not the CD player, press CD ►/||, then ■.
- 2 Check the tape running direction and Reverse Mode settings on the display.**
 - See step 2 of “Recording on a Tape” on page 19.

3 Start recording.

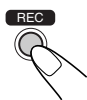

On the main unit

The System automatically creates 4-second blanks between the tunes recorded on the tapes.

- When either CD play or recording ends, both CD player and the cassette deck stop at the same time.

To record a “Live” disc

It will not be desirable to put 4-second blank portions between the tunes recorded on the tape. To record the entire disc without any interruption recorded, pause the disc play (press CD ►/|| twice) before pressing REC.

To record Program Play or Random Play

- 1 Select Program Play (and make a program) or Random Play, but do not start playback.
 - 2 Press REC to start recording.
- When CD play stops, recording continues. It is required that recording be stopped manually.

To record only your favorite track

You can specify tracks to be recorded on the tape while listening to a disc.

1 Start playing a disc.



2 While a track you want to record on the tape is playing...



On the main unit

The CD player returns to the beginning of that track and the track is recorded on the tape. After recording the track, the CD player and cassette deck automatically stop.

3 Repeat steps 2 and 3 to record other tracks you want.

- You can exchange the discs if necessary.

To protect your recording

Cassettes have two small tabs on the back to protect from unexpected erasure or re-recording.

To protect your recording, remove these tabs.



To re-record on a protected tape, cover the holes with adhesive tape.

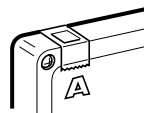

Timer Operations

Remote control

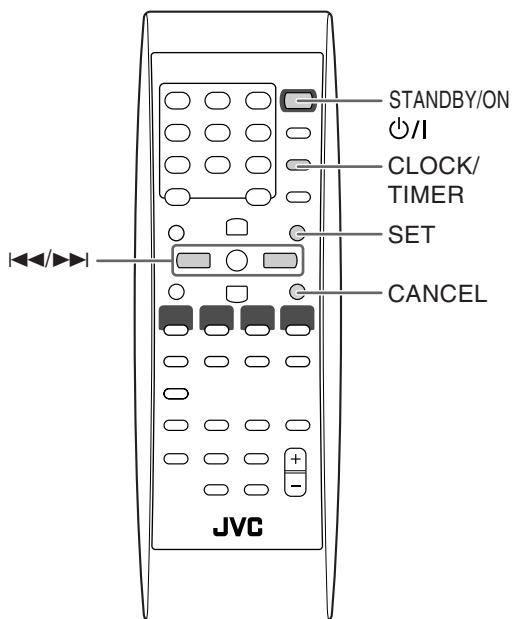

Setting the Timer



Using Daily Timer, you can wake up with your favorite song. On the other hand, with Recording Timer, you can make a tape of a radio broadcast automatically.

- You can store three Daily Timer settings and one Recording Timer setting; however, you can activate only one of Daily Timers and Recording Timer at the same time.
- To exit from the timer setting, press CLOCK/TIMER as required.
- To correct a misentry during the process, press CANCEL. You can return to the previous step.

1 Select one of the timer setting modes you want to set—**Daily 1 ON time, Daily 2 ON time, Daily 3 ON time, or Recording Timer ON time.**

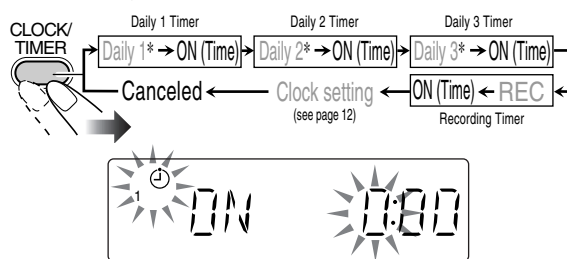

Ex. When Daily Timer 1 setting mode is selected

2 Make the timer setting as you want.

For Daily Timers:

- ① Set the hour then the minute for on-time.

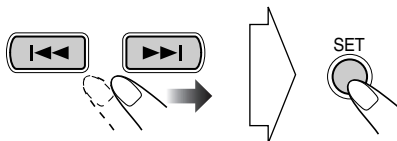

- ② Select the playback source—"TUNER," "CD," or "TAPE."

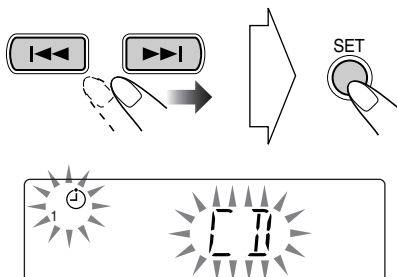

*Daily Timer initial settings when shipped from the factory

- Daily 1: ON Time (6:00)/Source (TUNER)/ Volume level (8)
- Daily 2: ON Time (7:00)/Source (TUNER)/ Volume level (8)
- Daily 3: ON Time (10:00)/Source (TUNER)/ Volume level (8)

③ Select the volume level.

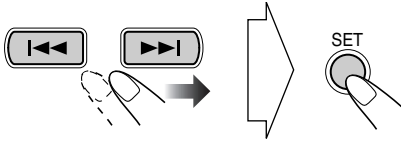

- You can select the volume level (“VOLUME 0” to “VOLUME 40” and “VOLUME --”). If you select “VOLUME --,” the volume is set to the last level when the unit has been turned off.

④ Select the volume level.

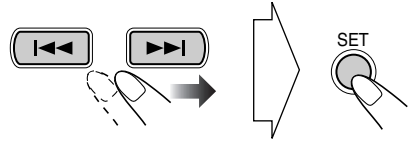

- You can select the volume level (“VOLUME 0” to “VOLUME 40” and “VOLUME --”). If you select “VOLUME --,” the volume is set to the last level when the unit has been turned off.

For Recording Timer:

① Set the hour then the minute for on-time.

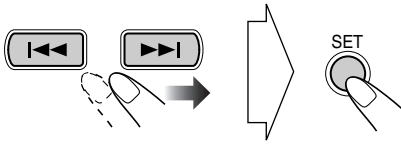

② Set the hour then the minute for off-time.

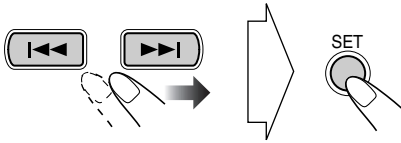

③ Select a preset station number.

- Select “FM” or “AM,” then a preset number.

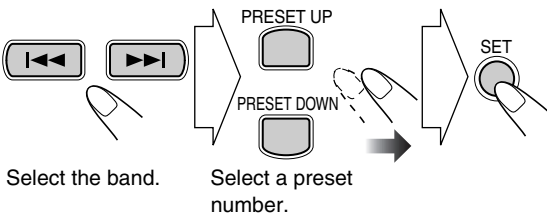

3 Turn off the unit (on standby) if you have set the timer with the System turned on.

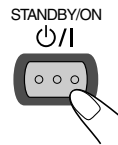

How Daily Timer actually works

Once the Daily Timer has been set, the timer (⊕) indicator and timer number indicator (1/2/3) are lit on the display. Daily Timer is activated at the same time everyday until the timer is turned off manually (see the next column) or another Daily Timer is activated.

When the on-time comes

The System turns on, tunes in to the last received station or start playing the loaded disc, and sets the volume level to the preset level.

About one hour after the playback starts, the System stops it, and turns off (stands by) automatically.

- The timer setting remains in memory until you change it.
- Without canceling the Daily Timer, you can change the source or adjust the volume after Daily Timer starts playback.

How Recording Timer actually works

When Recording Timer has been set, Timer (⊕) indicator and the REC indicator are lit on the display. Recording Timer works only once.

When the on-time comes

The System turns on, tunes in to the specified station, sets the volume level to the preset level, and starts recording.

When the off-time comes

The System stops recording, and turns off (stands by).

- The timer setting remains in memory until you change it.

To turn off the Timer after its setting is done

Since Daily Timer is activated at the same time everyday, you may need to cancel it on some particular days.

- Recording Timer can also be canceled temporarily.

1 Select the Timer you want to cancel.

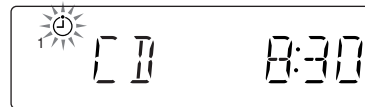
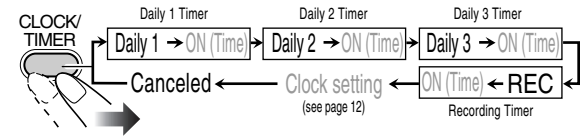

Ex. When Daily Timer 1

The current set source and on time appears.

2 Turn off the selected Timer.



To turn on the Timer again, repeat the above steps and press in step 2...



Additional Information

Learning More about This System ● ● ●

Daily Operations—Playback (see pages 8 to 10)

Listening to the Radio:

- If you store a new station into an occupied preset number, the previously stored station in that number will be erased.
- When you unplug the AC power cord or if a power failure occurs, the preset stations will be erased in a few days. If this happens, preset the stations again.

Playing Back a Disc:

- When using an 8 cm disc, place it on the inner circle of the disc tray.
- This System cannot play “packet write” discs.
- For MP3 playback...
 - MP3 discs are required a longer readout time than regular CDs. (It depends on the complexity of the group/file configuration.)
 - Some MP3 files cannot be played back and will be skipped. This result from their recording processes and conditions.
 - When making MP3 discs, use ISO 9660 Level 1 or Level 2 for the disc format.
 - This system can play back MP3 files with the extension code <.mp3> (regardless of the letter case—upper/lower).
 - It is recommended that you make each MP3 file at a sampling rate of 44.1 kHz and at bit rate of 128 kbps. This System cannot play back files made at bit rate of less than 64 kbps.
 - This System can recognize the total of 255 tracks and of 64 groups. Those exceeding the maximum number cannot be recognized.
 - Playback order of MP3 tracks may be different from the one you have intended while recording (see page 26). If a folder does not include MP3 tracks, they are ignored.

Playing Back a Tape:

- It is not recommended to use the C-120 or longer tapes. These tapes easily jams in the pinch rollers and the capstans, and may cause characteristic deterioration.

Daily Operations—Sound & Other Adjustments (see pages 11 to 12)

Adjusting the Volume:

- Be sure to turn down the volume before connecting or putting the headphones.

Adjusting the Sound:

- This function also affects the sound through the headphones.
- This function does not affect recording.

Setting the clock:

- “0:00” will flash on the display until you set the clock.
- The clock may gain or lose 1 to 2 minutes per month. If this happens, reset the clock.

Advanced Radio Operations (see pages 13 to 15)

- If the System takes time to show the RDS information—PS, PTY, RT signals, “PS,” “PTY” or “RT” will appear while searching.

Advanced Disc Operations (see pages 16 to 18)

Programming the Playing Order—Program Play:

- You cannot specify a group number of an MP3 disc for Program Play.
- If you try to program a 51st track, “FULL” appears on the display.
- While programming steps...
 - Your entry will be ignored if you have tried to program an item number that does not exist on the disc (for example, selecting track 14 on a disc that only has 12 tracks).

Advanced Tape Operations (see pages 19 to 20)

Recording on a Tape:

- The recording level is automatically set correctly. Thus, you can adjust the sound you are actually listening to without affecting the recording level.
- There is leader tape which cannot be recorded onto at the start and end of cassette tapes. Thus, when recording CDs or radio broadcasts, wind the leader tape first to ensure that the recording will be made without any music part lost.
- If you start recording with no cassette inserted, “NO TAPE” appears on the display. If a protected tape has been inserted, “NO REC” appears.
- When using Reverse Mode for recording, start recording in the forward (▶) direction first; otherwise, recording will stop when only one side (reverse) of the tape is recorded.
- You can also change Reverse Mode setting (↔) and (↔) after starting recording.
- You cannot open or close the disc tray while recording.

Synchronized Disc Recording:

- When the tape reaches its end in the forward direction (▶) during recording with Reverse Mode set to (↔), the last tune will be re-recorded at the beginning of the reverse side.
- You cannot open the cassette holder during Synchronized Disc Recording.

Timer Operations (see pages 21 to 23)

- When you unplug the AC power cord or if a power failure occurs, the timer will be canceled. You need to set the clock first, then the timer again.
- Without stopping the recording, you cannot change the source after Recording Timer start recording.
- If you set the Sleep Timer after Daily Timer starts playing the selected source, Daily Timer is canceled.
- If you set the Sleep Timer after Recording Timer starts recording, Recording Timer is canceled, but recording continues until Sleep Timer shuts off the power.

Troubleshooting

If you are having a problem with your System, check this list for a possible solution before calling for service.

General:

Adjustments or settings are suddenly canceled before you finish.

⇒ There is a time limit. Repeat the procedure again.

Operations are disabled.

⇒ The built-in microprocessor may malfunction due to external electrical interference. Unplug the AC power cord and then plug it back in.

Unable to operate the System from the remote control.

⇒ The path between the remote control and the remote sensor on the System is blocked.

⇒ The batteries are exhausted.

No sound is heard.

⇒ Speaker connections are incorrect or loose.

⇒ Headphones are connected.

Radio Operations:

Hard to listen to broadcasts because of noise.

⇒ Antennas connections are incorrect or loose.

⇒ The AM loop antenna is too close to the System.

⇒ The FM antenna is not properly extended and positioned.

Disc Operations:

The disc does not play.

⇒ The disc is placed upside down. Place the disc with the label side up.

ID3 Tag on an MP3 disc cannot be shown.

⇒ There are two types of ID3 Tag—Version 1 and Version 2.

This System can only show ID3 Tag Version 1.

MP3 groups and tracks are not played back as you expect.

⇒ The playing order is determined when the disc was recorded. It depends on the writing application.

The disc sound is discontinuous.

⇒ The disc is scratched or dirty.

The disc tray does not open or close.

⇒ The AC power cord is not plugged in.

⇒ Child Lock is in use (see page 18).

Tape Operations:

The cassette holder cannot be opened.

⇒ Power supply from the AC power cord has been cut off while the tape was running. Turn on the System.

Recordings:

Impossible to record.

⇒ Small tabs on the back of the cassette are removed. Cover the holes with adhesive tape.

Timer Operations:

Daily Timer and Recording Timer do not work.

⇒ The System has been turned on when the on-time comes. Timer starts working only when the System is turned off.

Maintenance

To get the best performance of the System, keep your discs, tapes, and mechanism clean.

Handling discs

- When removing the disc from its case, hold it at the edge while pressing the center hole lightly.
- Do not touch the shiny surface of the disc, or bend the disc.
- Put the disc back in its case after use to prevent warping.
- Be careful not to scratch the surface of the disc.
- Avoid exposure to direct sunlight, temperature extremes, and moisture.

To clean the disc:

Wipe the disc with a soft cloth in a straight line from center to edge.

Handling cassette tapes

- If the tape is loose in its cassette, take up the slack by inserting a pencil in one of the reels and rotate it.
 - If the tape is loose, it may get stretched, cut, or caught in the cassette.
- Be careful not to touch the tape surface.
- Avoid the following places to store the tape—in dusty places, in direct sunlight or heat, in moist areas, on a TV or speaker, or near a magnet.

To keep the best recording and playback sound quality

- Use a cotton swab moistened with alcohol to clean the heads, capstans, and pinch rollers.
- Use a head demagnetizer (available at electronics and audio shops) to demagnetize the heads (when the System turned off).

Cleaning the System

- Stains should be wiped off with a soft cloth. If the System is heavily stained, wipe it with a cloth soaked in water-diluted neutral detergent and wrung well, then wipe clean with a dry cloth.
- Since the System may deteriorate in quality, it become damaged or get its paint peeled off, be careful about the following:
 - DO NOT wipe it with a hard cloth.
 - DO NOT wipe it strongly.
 - DO NOT wipe it with thinner or benzine.
 - DO NOT apply any volatile substance such as insecticides to it.
 - DO NOT allow any rubber or plastic to remain in contact for a long time.

Specifications

Amplifier section

Output Power:

40 W (20 W + 20 W) at 4 Ω (10% THD)

Speakers/Impedance: 4 Ω – 16 Ω

Audio Input AUX: 400 mV/50 kΩ

Tuner section

FM tuning range: 87.50 MHz – 108.00 MHz

AM (MW) tuning range: 522 kHz – 1 629 kHz

CD player section

Dynamic range: 88 dB

Signal-to-noise ratio: 93 dB

Wow and flutter: Immeasurable

Cassette deck section

Frequency response

Normal (type I): 50 Hz – 14 000 Hz

Wow and flutter: 0.15% (WRMS)

Speakers

Speaker units: 10 cm cone x 1

Impedance: 4 Ω

Dimensions (approx.): 145 mm x 230 mm x 191 mm
(W/H/D)

Mass (approx.): 1.8 kg each

Supplied Accessories

See page 3.

General

Power requirement: AC 230 V ~ , 50 Hz

Power consumption: 50 W (at operation)

1.4 W (on standby)

Dimensions (approx.): 170 mm x 230 mm x 311 mm
(W/H/D)

Mass (approx.): 4.5 kg

MP3 groups/tracks configuration

This System plays back MP3 tracks as follows.

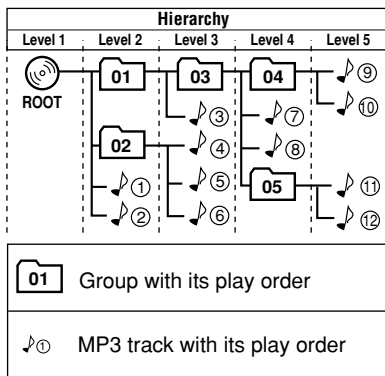

Parts Index

Refer to the pages to see how to use the buttons and controls.

Remote control

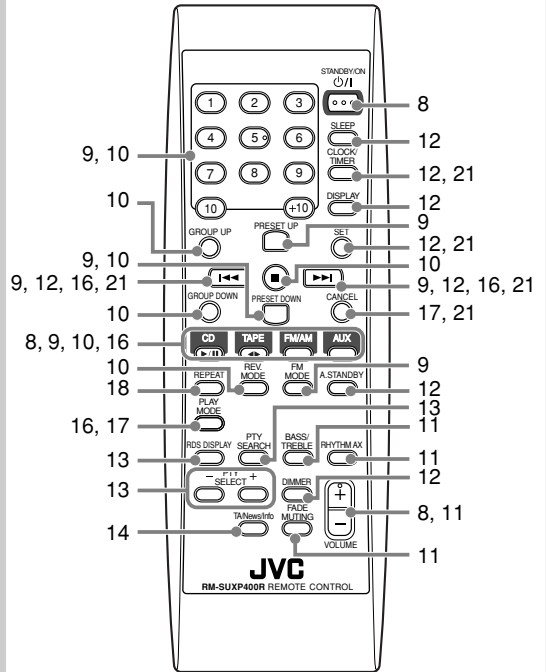

Main unit

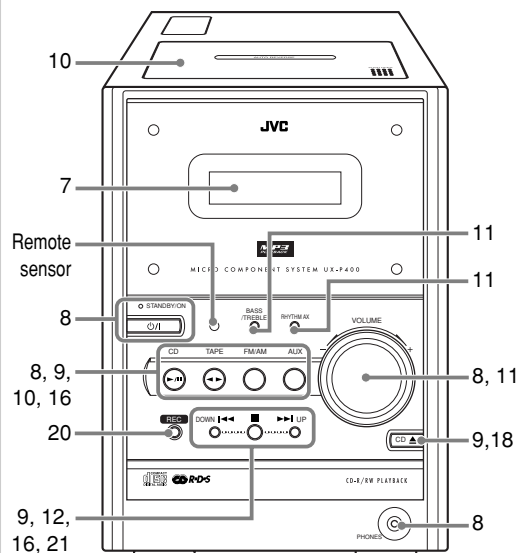

SAFETY INSTRUCTIONS

“SOME DOS AND DON'TS ON THE SAFE USE OF EQUIPMENT”

This equipment has been designed and manufactured to meet international safety standards but, like any electrical equipment, care must be taken if you are to obtain the best results and safety is to be assured.

☆☆

Do read the operating instructions before you attempt to use the equipment.

Do ensure that all electrical connections (including the mains plug, extension leads and interconnections between pieces of equipment) are properly made and in accordance with the manufacturer's instructions. Switch off and withdraw the mains plug when making or changing connections.

Do consult your dealer if you are ever in doubt about the installation, operation or safety of your equipment.

Do be careful with glass panels or doors on equipment.

☆☆

DON'T continue to operate the equipment if you are in any doubt about it working normally, or if it is damaged in any way—switch off, withdraw the mains plug and consult your dealer.

DON'T remove any fixed cover as this may expose dangerous voltages.

DON'T leave equipment switched on when it is unattended unless it is specifically stated that it is designed for unattended operation or has a standby mode.

Switch off using the switch on the equipment and make sure that your family know how to do this. Special arrangements may need to be made for infirm or handicapped people.

DON'T use equipment such as personal stereos or radios so that you are distracted from the requirements of traffic safety. It is illegal to watch television whilst driving.

DON'T listen to headphones at high volume as such use can permanently damage your hearing.

DON'T obstruct the ventilation of the equipment, for example with curtains or soft furnishings. Overheating will cause damage and shorten the life of the equipment.

DON'T use makeshift stands and NEVER fix legs with wood screws—to ensure complete safety always fit the manufacturer's approved stand or legs with the fixings provided according to the instructions.

DON'T allow electrical equipment to be exposed to rain or moisture.

ABOVE ALL

- NEVER let anyone, especially children, push anything into holes, slots or any other opening in the case—this could result in a fatal electrical shock.;

- NEVER guess or take chances with electrical equipment of any kind—it is better to be safe than sorry!

MEMO



A series of horizontal dashed lines providing a template for writing the memo content.

MEMO



A series of horizontal dashed lines for writing.



Free Manuals Download Website

<http://myh66.com>

<http://usermanuals.us>

<http://www.somanuals.com>

<http://www.4manuals.cc>

<http://www.manual-lib.com>

<http://www.404manual.com>

<http://www.luxmanual.com>

<http://aubethermostatmanual.com>

Golf course search by state

<http://golfingnear.com>

Email search by domain

<http://emailbydomain.com>

Auto manuals search

<http://auto.somanuals.com>

TV manuals search

<http://tv.somanuals.com>