

# JVC

## COMPACT COMPONENT SYSTEM

小型組和系統

نظام اجهزة صوتية مركبة

# MX-J333V/MX-J383V

CA-MXJ333V

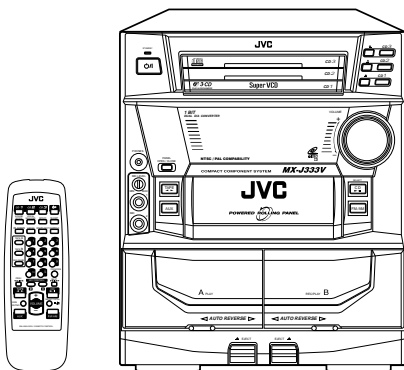

CA-MXJ383V

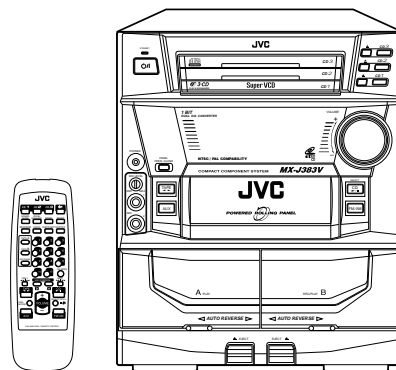

SP-MXJ333

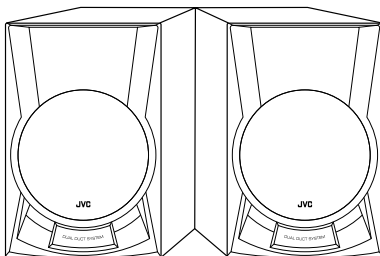

SP-MXJ383

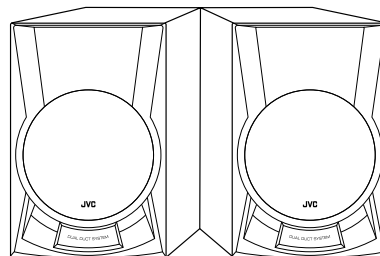

### INSTRUCTIONS

使用説明書

كتيب تعليمات التشغيل

**For Customer Use:**

Enter below the Model No. and Serial No. which are located either on the rear, bottom or side of the cabinet. Retain this information for future reference.

Model No. \_\_\_\_\_

Serial No. \_\_\_\_\_

GVT0017-001A  
[ UB, U, US, UT ]

**Warnings, Cautions and Others**  
**Avisos, precauciones y otras notas**  
**Advertências, precauções e outras notas**  
**警告，注意及其他須知事項**  
**تحذيرات، تنبيهات وأشياء اخرى**

---

**Caution —  switch!**

Disconnect the mains plug to shut the power off completely. The  switch in any position does not disconnect the mains line. The power can be remote controlled.

**注意— 開關！**

無論開關在任何位置，電源線的電源還是沒有被切斷，若要將電源完全關閉，應把電源插頭拔離插座。電源開關可用遙控器控制。

**Precaución — Interruptor **

Desconectar el cable de alimentación para desactivar la alimentación totalmente. Cualquier que sea la posición de ajuste del interruptor , la alimentación no es cortada completamente. La alimentación puede ser controlada remotamente.

**تحذير -  الطاقة**

انزع قابس الطاقة الكهربائية من اجل فصل الطاقة الكهربائية عن الجهاز كلياً. لا يفصل مفتاح الطاقة الكهربائية عندما يكون باي وضع  الطاقة الكهربائية عن الجهاز. يمكن التحكم عن بعد بالطاقة الكهربائية.

**Precaução — Interruptor **

Desconectar o cabo de alimentação para desligar a alimentação por completo. Qualquer que seja a posição de ajuste do interruptor , a alimentação não é completamente cortada. A alimentação pode ser controlada remotamente.

---

### **CAUTION**

To reduce the risk of electrical shocks, fire, etc.:

1. Do not remove screws, covers or cabinet.
2. Do not expose this appliance to rain or moisture.

### **PRECAUCIÓN**

Para reducir riesgos de choques eléctricos, incendio, etc.:

1. No extraiga los tornillos, los cubiertas ni la caja.
2. No exponga este aparato a la lluvia o a la humedad.

### **PRECAUÇÃO**

Para reduzir riscos de choques elétricos, incêndio, etc.:

1. Não remova parafusos e tampas ou desmonte a caixa.
2. Não exponha este aparelho à chuva nem à umidade.

### **警告**

為了減低觸電，火災等危險：

1. 請勿擅自卸下螺絲釘，蓋子或機殼。
2. 切勿讓本機受雨淋或置潮濕環境中。

### **تحذير**

لتجنب خطر الحريق، الصدمات الكهربائية، الخ.:

١. لا تفك البراغي او الاغطية او الخزانه.
٢. لا تعرض هذا الجهاز للمطر او للرطوبة.

### Caution: Proper Ventilation

To avoid risk of electric shock and fire, and to prevent damage, locate the apparatus as follows:

- 1 Front: No obstructions and open spacing.
- 2 Sides/ Top/ Back: No obstructions should be placed in the areas shown by the dimensions below.
- 3 Bottom: Place on the level surface. Maintain an adequate air path for ventilation by placing on a stand with a height of 10 cm or more.

### Precaución: el aparato debe estar bien ventilado

Para evitar posibles riesgos de descargas eléctricas e incendios y prevenir cualquier posible daño, coloque el aparato del modo siguiente:

- 1 Parte delantera: No ponga nada delante, deje el espacio libre.
- 2 Laterales/ parte superior/ parte trasera: No se debería colocar nada en las áreas y las distancias que se detallan a continuación.
- 3 Parte inferior: Coloque el aparato sobre una superficie recta. Debe haber buena circulación de aire; para ello, coloque el aparato sobre una base a una altura mínima de 10 cm.

### Precaução: Ventilação adequada

Para evitar riscos de choques elétricos e incêndios, e prevenir avarias, instale o aparelho como segue:

- 1 Parte frontal: Sem obstruções e espaços abertos.
- 2 Partes laterais/Tampa/Posterior: Nenhuma obstrução deverá ser colocada entre as áreas cujas dimensões são indicadas abaixo.
- 3 Parte inferior: Instale-o sobre uma superfície plana. Deverá ser mantido espaço suficiente para a ventilação se este for instalado numa posição que tenha uma altura de 10 cm ou mais.

### 告誡：正確通風

為免發生觸電和火警的危險，及防止本機受損，請將本機如下放置：

- 1 前面： 沒有障礙物及地方開闊。
- 2 側面／頂面／背面： 在圖中所示範圍中，不應放置任何障礙物。
- 3 底部： 放置在水平面上。放置在一個高 10 厘米或以上的臺上，以保持足夠的通風道。

### تحذير: التهوية الصحيحة

لتجنب حصول صدمات كهربائية واطار الحريق ومنع حصول تلف وضرر للجهاز، ركب الجهاز كما يلي:  
١ الجهة الامامية: يجب ان لا يكون هنالك عوائق ويجب ان تكون المنطقة مفتوحة امام الجهاز.  
٢ الجهات الجانبية / العلوية / الخلفية: يجب عدم وضع عوائق في المناطق المبينة بالابعاد في الاسفل.  
٣ القاعدة: يجب وضع الجهاز على سطح منبسط. اترك مسافة كافية من اجل التهوية بواسطة وضع الجهاز على حامل بارتفاع ١٠ سم او اكثر.

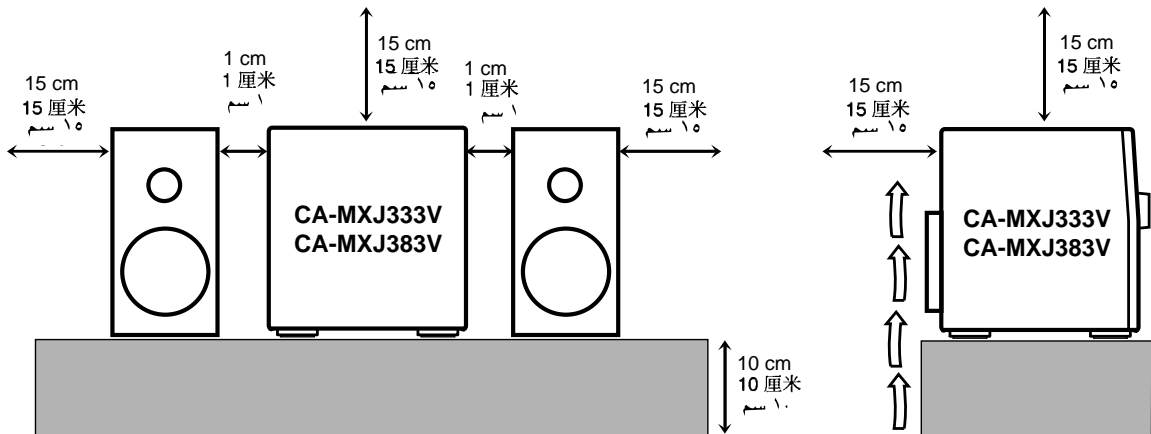

**IMPORTANT FOR LASER PRODUCTS / IMPORTANTE PARA PRODUCTOS LÁSER / IMPOTANTE PARA PRODUTOS LASER / 雷射產品的重要說明 / مهم للمنتجات الليزرية**

**REPRODUCTION OF LABELS / REPRODUCCIÓN DE ETIQUETAS / REPRODUÇÃO DE ETIQUETAS**

標籤內容說明 / انتاج الملصقات

- |   |   |
|---|---|
| ① CLASSIFICATION LABEL, PLACED ON REAR ENCLOSURE                                | ② WARNING LABEL, PLACED INSIDE THE UNIT                           |
| ① ETIQUETA DE CLASIFICACIÓN, PEGADA EN LA PARTE POSTERIOR DE LA CAJA            | ② ETIQUETA DE ADVERTENCIA, PEGADA EN EL INTERIOR DE LA UNIDAD     |
| ① ETIQUETA DE CLASSIFICAÇÃO LOCALIZADA NA PARTE POSTERIOR DA CAIXA DO APARELHO. | ② ETIQUETA DE ADVERTÊNCIA LOCALIZADA NA PARTE INTERNA DA UNIDADE. |
| ① 分類標籤，貼在機殼背後。  | ② 警告標籤，貼於機內。  |

① ملصق التصنيف، موضوع على المرفق الخلفي

② ملصق التحذير، موضوع بداخل الجهاز

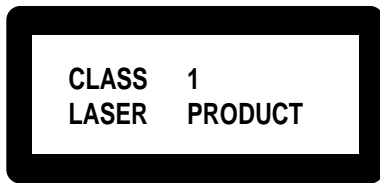

<b>DANGER:</b> Invisible laser radiation when open and interlock failed or defeated. AVOID DIRECT EXPOSURE TO BEAM. (e)	<b>WARNING:</b> Osynlig laserstrålning när denna del är öppnad och spärren är urkopplad. Betrakta ej strålen. (s)	<b>ADVARSEL:</b> Usynlig laserstrålning ved åbning, når sikkerhedsafbrydere er ude af funktion. Undgå udsættelse for stråling (d)	<b>VARO:</b> Avattaessa ja suojalukitus ohitettaessa olet alttiina näkymättömälle lasersäteilylle. Älä katso säteeseen. (f)
---	---	---	---

1. CLASS 1 LASER PRODUCT
2. **DANGER:** Invisible laser radiation when open and interlock failed or defeated. Avoid direct exposure to beam.
3. **CAUTION:** Do not open the top cover. There are no user serviceable parts inside the Unit; leave all servicing to qualified service personnel.

- 1 一級鐳射產品。
- 2 危險：當內部鎖定裝置失效或者損壞後，打開蓋板可能會產生不可見的雷射輻射。應避免受到光束直接照射。
- 3 注意：請勿打開頂蓋板。本機內部沒有用戶可自行維修的部件；所有維修工作應由有資格的人員完成。

1. PRODUCTO LÁSER CLASE 1
2. **PELIGRO:** En el interior hay radiación láser invisible. Evite el contacto directo con el haz.
3. **PRECAUCIÓN:** No abra la tapa superior. En el interior de la unidad no existen piezas reparables por el usuario; deje todo servicio técnico en manos de personal calificado.

1. PRODUTO LASER CLASSE 1
2. **PERIGO:** O laser emite uma radiação invisível que é perigosa, caso o aparelho esteja aberto e a trava inoperante ou danificada. Evite exposição direta ao feixe dos raios.
3. **CUIDADO:** Não abra a caixa do aparelho. Não existem peças reparáveis pelo usuário na parte interna da unidade. Solicite assistência técnica somente a pessoal técnico qualificado.

1. صنف ١ منتج ليزري
2. **خطر:** هنالك أشعة ليزرية غير مرئية عند الفتح والاطلاق غير الضروري أو غير الصحيح. تجنب التعرض المباشر للأشعة.
3. **تحذير:** ات فتتح الغطاء العلوي. لا يوجد اجزاء داخل الجهاز يستطيع المستخدم صيانتها. في حالة الحاجة للصيانة، اترك جميع اعمال الصيانة للأشخاص المختصين فقط.

# Introduction

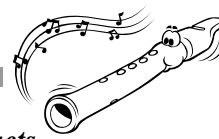

*We would like to thank you for purchasing one of our JVC products.  
Before operating this unit, read this manual carefully and thoroughly to obtain the best possible performance from your unit, and retain this manual for future reference.*

## About This Manual

This manual is organized as follows:

- The manual mainly explains operations using the buttons and controls on the unit. You can also use the buttons on the remote control if they have the same or similar names (or marks) as those on the unit.

If operation using the remote control is different from that using the unit, it is then explained.

- This manual explains by using number of location of buttons and controls.

Please refer to pages 26 to 28 "Location of the Buttons and Controls".

- Basic and common information that is the same for many functions is grouped in one place, and is not repeated in each procedure. For instance, we do not repeat the information about turning on/off the unit, setting the volume, changing the sound effects, and others, which are explained in the section "Common Operations" on pages 7 to 8.

- The following marks are used in this manual:



Gives you warnings and cautions to prevent from a damage or risk of fire/electric shock.

Also gives you information which is not good for obtaining the best possible performance from the unit.



Gives you information and hints you had better know.

## Precautions

### Installation

- Install in a place which is level, dry and neither too hot nor too cold — between 5°C (41°F) and 35°C (95°F).
- Install the unit in a location with adequate ventilation to prevent internal heat built-up in the unit.
- Leave sufficient distance between the unit and the TV to avoid interference.
- Keep the speakers away from the TV to avoid interference with TV.



*DO NOT install the unit in a location near heat sources, or in a place subject to direct sunlight, excessive dust or vibration.*

### Power sources

- When unplugging from the wall outlet, always pull the plug, not the AC power cord.



*DO NOT handle the AC power cord with wet hands.*

## Moisture condensation

Moisture may condense on the lens inside the unit in the following cases:

- After starting heating in the room
  - In a damp room
  - If the unit is brought directly from a cold to a warm place
- Should this occur, the unit may malfunction. In this case, leave the unit turned on for a few hours until the moisture evaporates, unplug the AC power cord, and then plug it in again.

## Others

- Should any metallic object or liquid fall into the unit, unplug the unit and consult your dealer before operating any further.
- If you are not going to operate the unit for an extended period of time, unplug the AC power cord from the wall outlet.



*DO NOT disassemble the unit since there are no user serviceable parts inside.*

If anything goes wrong, unplug the AC power cord and consult your dealer.

## Which compact discs can be used?

Many types of compact discs are sold for a variety of uses. The player can play the following compact discs:

### Super VCD (SVCD) discs

- Better video resolution using MPEG2 and VBR (Variable Bit Rate) technologies.
- Up to four languages can be included as subtitles or song lyrics.
- Up to four languages can be included as audio.



Video CD discs both with and without PBC function.



Audio CD discs



## Discs you cannot play back

Any other discs than listed above (such as CD-ROM, DVD, CD-I or CD-G Discs) cannot be played. Playing back such discs may generate noise and damage your speaker.

Even though a logo listed above is printed on the disc, it may not be played if it is a non-standard disc.

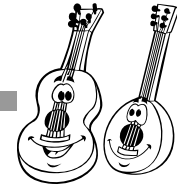

English

# Table of Contents

<b>Getting Started .....</b>	<b>3</b>	<b>Playing Back Tapes .....</b>	<b>17</b>
Unpacking .....	3	Playing Back a Tape .....	17
Putting the Batteries into the Remote Control .....	3	Locating the Beginning of a Song — Music Scan ...	17
Connecting Antennas .....	3	<b>Recording .....</b>	<b>18</b>
Connecting Speakers .....	4	Recording Tapes on Deck B .....	18
Connecting Auxiliary Equipment .....	5	Dubbing Tapes .....	19
Adjusting the Voltage Selector .....	6	CD Direct Recording .....	19
To know the locations of Buttons and controls .....	6	<b>Using the Microphones .....</b>	<b>20</b>
<b>Common Operations .....</b>	<b>7</b>	Singing Along .....	20
Setting the Clock .....	7	Singing Along with Multiplex Karaoke	
Setting the AM Tuner Interval Spacing .....	7	Discs (MPX) .....	20
Turning On the Power and Selecting the Sources .....	7	Recording Your Singing .....	21
Adjusting the Volume .....	8	To apply an echo to your voice .....	21
Reinforcing the Bass Sound .....	8	Adjust the Music Key Control (for CD play only) ..	21
Selecting the Sound Modes .....	8	Microphone mixing .....	21
<b>Playing Back Audio CDs .....</b>	<b>9</b>	<b>Using the Timers .....</b>	<b>22</b>
Placing CDs .....	9	Using Daily Timer .....	22
Playing Back the Entire Discs		Using Recording Timer .....	23
— Continuous Play .....	9	Using Sleep Timer .....	24
Basic CD Operations .....	9	Timer Priority .....	24
Programming the Playing Order of the Tracks		<b>Maintenance .....</b>	<b>25</b>
— Program Play .....	10	<b>Troubleshooting .....</b>	<b>25</b>
Playing at Random — Random Play .....	11	<b>Location of the Buttons and Controls .....</b>	<b>26</b>
Repeating Tracks or CDs — Repeat Play .....	11	Remote Control .....	26
Prohibiting Disc Ejection — Tray Lock .....	11	Remote Sensor .....	26
		Display Window .....	27
		Front Panel .....	27
<b>Playing Back Video CDs/SVCDs .....</b>	<b>12</b>	<b>Specifications .....</b>	<b>29</b>
Selecting Video Out .....	12		
Placing CDs .....	12		
Playing a Video CD .....	12		
Playing Video CDs/SVCDs with PBC function			
— Menu Play .....	13		
Basic Concept of the PBC function .....	13		
Playing Video CDs/SVCDs without the PBC function			
— Continuous Play .....	14		
Resuming play .....	14		
Special Plays for a Video CD .....	14		
Playing a multiplex sound CD .....	15		
Using SUBTITLE .....	15		
<b>Listening to FM and AM Broadcasts .....</b>	<b>16</b>		
Tuning in a Station .....	16		
Presetting Stations .....	16		
Tuning in a Preset Station .....	16		

# Getting Started



## Unpacking

After unpacking, check to be sure that you have all the following items.

The number in the parentheses indicates the quantity of the pieces supplied.

- AM loop antenna (1)
- FM antenna (1)
- Remote control (1)
- Batteries (2)
- AC plug adaptor (except for Vietnam, Hong Kong and The People's Republic of China: 1)
- Video cord (1)

If any is missing, consult your dealer immediately.

## Putting the Batteries into the Remote Control

Insert the batteries — R6P(SUM-3)/AA(15F) — into the remote control, by matching the polarity (+ and –) on the batteries with the + and – markings on the battery compartment.

When the remote control can no longer operate the unit, replace both batteries at the same time.

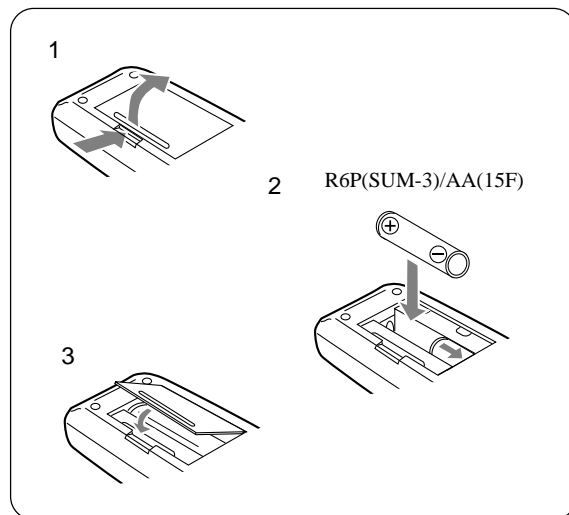

- **DO NOT** use an old battery together with a new one.
- **DO NOT** use different types of batteries together.
- **DO NOT** expose batteries to heat or flame.
- **DO NOT** leave the batteries in the battery compartment when you are not going to use the remote control for an extended period of time. Otherwise, it will be damaged from battery leakage.

## Connecting Antennas

### FM antenna

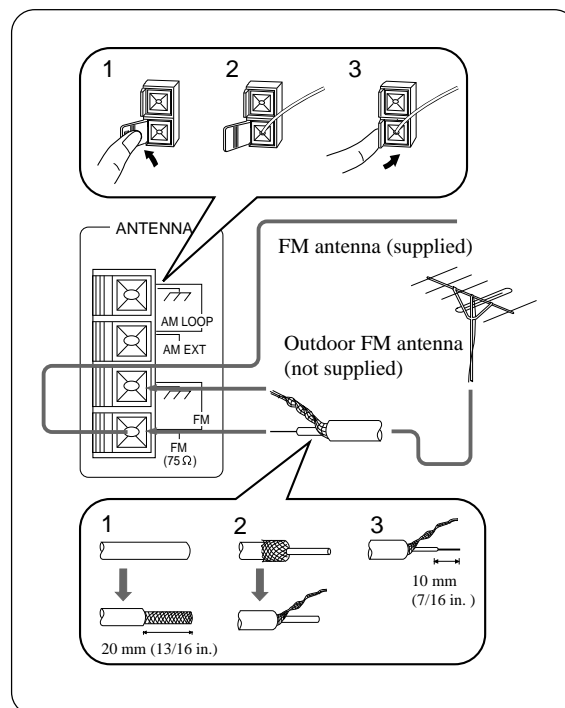

Extend the FM antenna (supplied) horizontally.



### If reception is poor

Connect the outdoor antenna.

Before attaching a 75-ohm coaxial cable (the kind with a round wire going to an outdoor antenna), disconnect the supplied FM antenna.

### How to strip the 75-ohm coaxial cable and connect it to the FM terminals

1. Strip off the outside covering of the 75-ohm coaxial cable to expose the braided metallic mesh about 20 mm (13/16 inches).
2. Pull the mesh back and twist it into a single connector as shown in the illustration above.
3. Strip the insulation about 10 mm (7/16 inches) back from the central wire.
4. Insert the twisted mesh and the central wire to the FM terminals, as shown in the illustration above.





### AM antenna

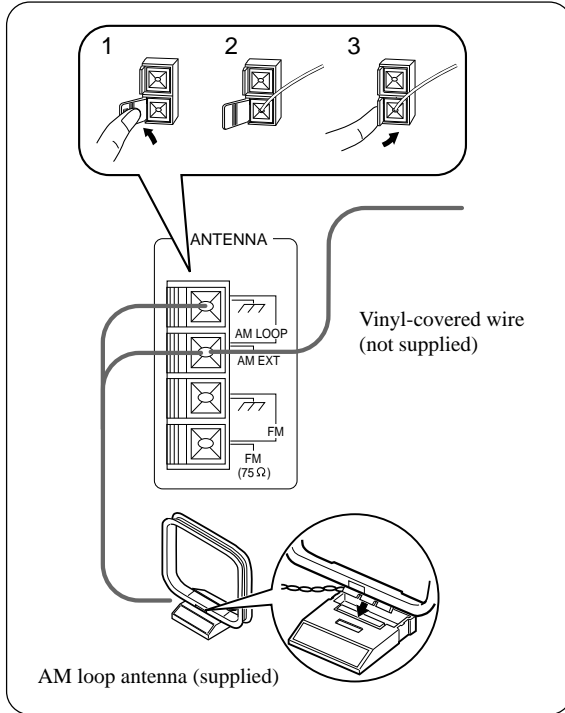

- 1 Connect the AM loop antenna to the AM LOOP terminals as illustrated.
- 2 Turn the AM loop antenna until you have the best reception.

#### To connect an outdoor AM antenna

When reception is poor, connect a single vinyl-covered wire to the AM EXT terminal and extend it horizontally. (The AM loop antenna must remain connected.)



#### **For better reception of both FM and AM**

- Make sure the antenna conductors do not touch any other terminals and connecting cords.
- Keep the antennas away from metallic parts of the unit, connecting cords, and the AC power cord.

### Connecting Speakers

You can connect a pair of front speakers.

#### To connect front speakers

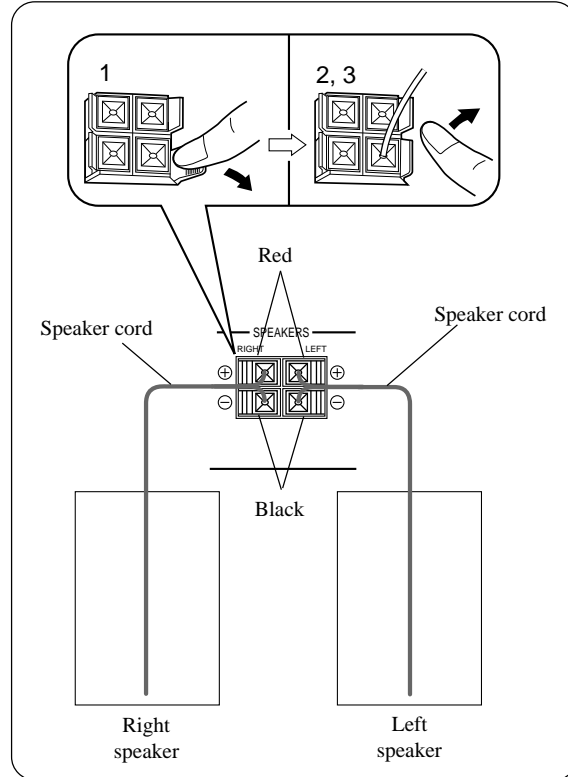

- 1 Press and hold the clamp of the speaker terminal on the rear of the unit.
- 2 Insert the end of the speaker cord into the terminal. Match the polarity of the speaker terminals: Red (+) to red (+) and black (-) to black (-).
- 3 Release the finger from the clamp.

**IMPORTANT:** Use only speakers with the same speaker impedance as indicated by the speaker terminals on the rear of the unit.



## Connecting Auxiliary Equipment

You can connect an audio equipment – used only as a playback device.

When you connect and use this equipment, refer also to its manual.

Be sure that the plugs of the audio cords are colour-coded:  
White plugs and jacks are for left audio signals, and red ones for right audio signals.



- **DO NOT** connect any equipment while the power is on.
- **DO NOT** plug in any equipment until all connections are complete.

### To connect audio equipment

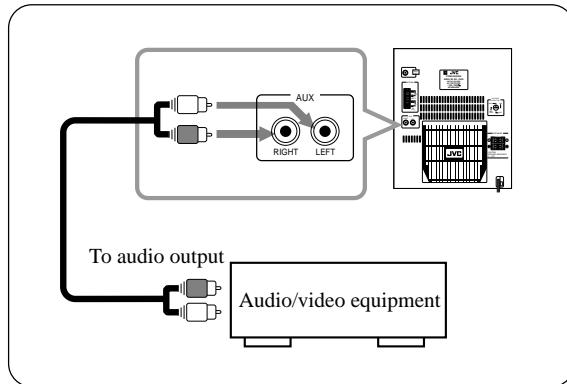

Connect the audio output jacks on the other equipment and the AUX jacks on the rear, using an audio cord (not supplied).

### VCR or other equipment

You can connect the following equipment to this system.

- **TV with a video input jack:** used as a monitor of video CD playback.
- **Audio/Video equipment.**

To listen to this source, press AUX **10**, **13**.

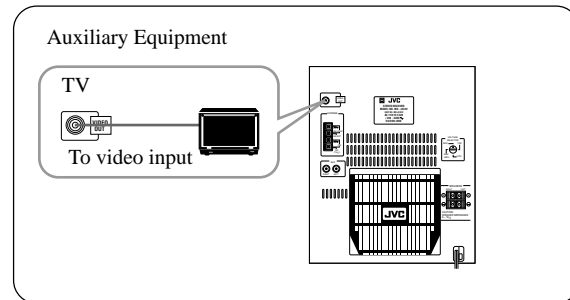

#### When connecting Auxiliary Equipment

- Connect the VIDEO OUT jack at the back panel of the System to the video input jack on the TV via the supplied video cord.
- Connect the AUX jacks to the output of Audio/Video equipment.
- No audio signal is produced at the AUX IN jacks.



## Adjusting the Voltage Selector

Before plugging in the unit, set the correct voltage for your area with the voltage selector on the rear of the unit.

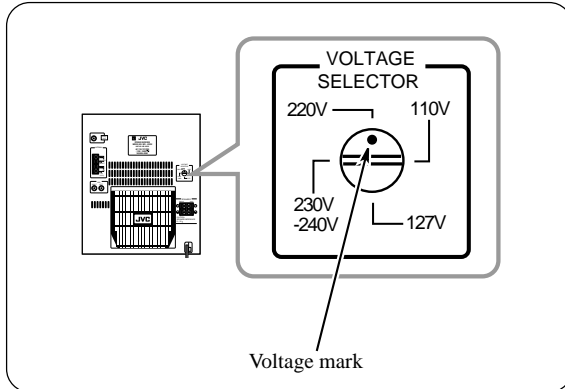

Use a screwdriver to rotate the voltage selector so the voltage number and the voltage mark is pointing at is the same as the voltage where you are plugging in the unit.



- **DO NOT** plug in before setting the voltage selector on the rear of the unit and all connection procedures are complete.

NOW, you can plug in the unit and other connected equipment FINALLY!

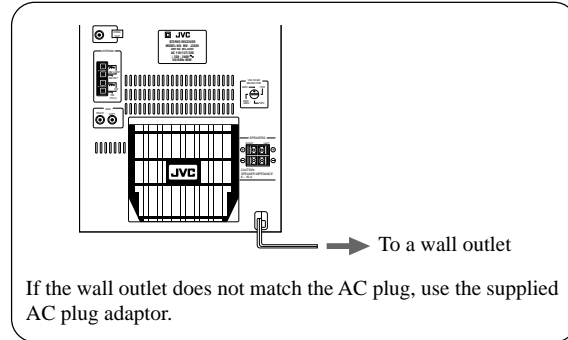

When connecting the AC power cord into a wall outlet, the unit automatically starts display demonstration.

To stop the display demonstration, press any button on the unit or the remote control.

**To start the display demonstration manually**  
 Press and hold DEMO  for more than 2 seconds.

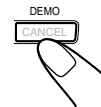

To stop the demonstration, press any button.

## To know the locations of Buttons and controls

Please refer to page 26, 27 and 28 for location of the buttons and controls on your unit. The buttons and controls mentioned in the steps in this manual have been inserted with numbers i.e 1, 2 (for unit) or ①, ② ( for remocon) for your easy reference.

# Common Operations

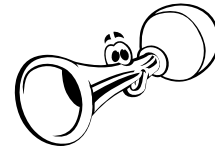

## Setting the Clock

Before operating the unit any further, first set the clock built in this unit.

### 1 Press PANEL OPEN/CLOSE [5].

The unit is turned on and the Powered Rolling Panel opens automatically.



### 2 Press TIMER/CLOCK [26].



The hour digits start flashing on the display.

### 3 Press ◀◀ [20] or ▶▶ [20] to adjust the hour, then press SET [28].



- If you want to correct the hour after pressing SET [28], press CANCEL [30]. The hour digits start flashing again.



### 4 Press ◀◀ [20] or ▶▶ [20] to adjust the minute, then press SET [28].

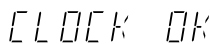

## To check the clock time

Press DISPLAY [33] while playing any source.

- Each time you press the button, the source indication and the clock time alternate on the display



## To adjust the clock again

If you have adjusted the clock before, you need to press TIMER/CLOCK [26] repeatedly until the clock setting mode is selected.

- Each time you press the button, the timer/clock setting modes change as follows:

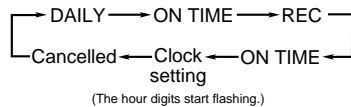

**When you unplug the AC power cord or if a power failure occurs**

The clock is reset to "0:00" right away, while the tuner preset stations (see page 16) will be erased in a few days.

## Setting the AM Tuner Interval Spacing

Some countries space AM stations 9 kHz apart, and some countries use 10 kHz spacing.

### On the unit **ONLY**:

You can only change the AM tuner interval spacing while tuning into an AM station.

Press FM/AM [17], [25] while holding down ■ [31], [24].

- Each time you press the button, the AM tuner interval spacing alternates between 9 kHz and 10 kHz.



NOTE: Preset memory lost when the interval spacing is changed.

## Turning On the Power and Selecting the Sources

When you press the play button for a particular source (FM/AM, CD ▶/||, AUX, and TAPE ◀▶), the unit turns on, and the Powered Rolling Panel opens automatically (and the unit starts playing the source if it is ready — COMPU PLAY CONTROL).

**To listen to the FM/AM broadcasts**, press FM/AM [17], [25]. (See page 16.)

**To play back CDs**, press CD ▶/|| [16], [23]. (See pages 9 – 11.)

**To play back tapes**, press TAPE ◀▶ [7], [11]. (See page 17.)

**To select the external equipment as the source**, press AUX [10], [13].



**To turn on the unit without playing**, press ⏻ [2], [14] so that the STANDBY lamp goes off.

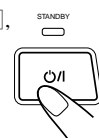

WELCOME

The Powered Rolling Panel opens automatically.

**To turn off the unit (on standby)**, press ⏻ [2], [14] again so that the STANDBY lamp lights up.

The Powered Rolling Panel also closes.

A little power is always consumed even while the unit is on standby.



To switch off the power supply completely, unplug the AC power cord from the AC outlet.

When select CD source, "LOADING" indicates on the display for a few seconds.

During the LOADING indication, the unit will initialize for preparing to play CD.



## Adjusting the Volume

You can adjust the volume level only while the unit is turned on.

Turn VOLUME [15] clockwise to increase the volume or counterclockwise to decrease it.

VOL - 16

When using the remote control, press VOLUME + [26] to increase the volume or press VOLUME - [26] to decrease it.

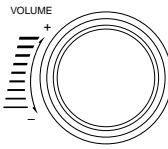

### For private listening

Connect a pair of headphones to the PHONES jack [6]. No sound comes out of the speakers. Be sure to turn down the volume before connecting or putting on headphones.



**DO NOT** turn off (on standby) the unit with the volume set to an extremely high level; otherwise, a sudden blast of sound can damage your hearing, speakers and/or headphones when you turn on the unit or start playing any source the next time. REMEMBER you cannot adjust the volume level while the unit is on standby.

## To turn down the volume level temporarily

Press FADE MUTING [12] on the remote control. The volume level gradually decreases to "0."



VOL - 16



VOL - 0

To restore the sound, press the button again.

## Reinforcing the Bass Sound

The richness and fullness of the bass sound is maintained regardless of how low you set the volume.

You can use this effect only for playback.

To get the effect, press ACTIVE BASS EX. [37] so that the ACTIVE BASS EX. lamp (the button itself) lights up on the unit.



The A. BASS EX indicator also lights up on the display.

To cancel the effect, press the button again so that the lamp goes off.

## Selecting the Sound Modes

You can select one of the 6 preset sound modes (3 surround modes and 3 SEA — Sound Effect Amplifier — modes). The sound modes can be applied only to playback sounds, and cannot be used for recording.

To select the sound modes, press SOUND MODE [38], [2] repeatedly until the sound mode you want appears on the display. The S. MODE indicator also lights up on the display.

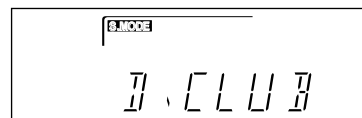

Each time you press the button, the sound modes change as follows:

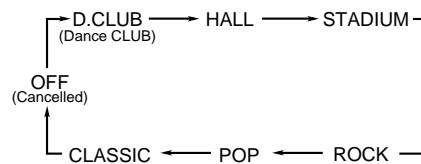

### Surround modes:

- D.CLUB:** Increases resonance and bass.
- HALL:** Adds depth and brilliance to the sound.
- STADIUM:** Adds clarity and spreads the sound, like in an outdoor stadium.

### SEA modes:

- ROCK:** Boosts low and high frequency. Good for acoustic music.
- POP:** Good for vocal music.
- CLASSIC:** Good for classical music.
- OFF:** Cancels the sound mode.



# Playing Back Audio CDs



## Placing CDs

### 1 Press $\blacktriangle$ [13] for the disc tray (CD 1 to 3) you want to load a CD onto.

The unit automatically turns on and the disc tray comes out. The Powered Rolling Panel also opens automatically.

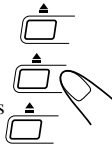

### 2 Place a disc correctly on the circle of the disc tray, with its label side up.

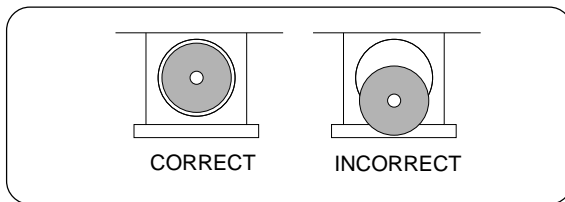

- When using a CD single (8 cm), place it on the inner circle of the disc tray.

### 3 Press the same $\blacktriangle$ [13] you have pressed in step 1.

The disc tray closes, and the corresponding disc number indicator (CD 1 to CD 3) lights up on the display.

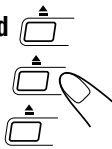

### 4 Repeat steps 1 to 3 to place other CDs.



#### When placing more than one CD continuously

When you press  $\blacktriangle$  [13] for the next tray you want to place another CD onto, the first disc tray automatically closes and then the next tray comes out.

NOTE: When placing another CD, wait until current CD playing or stop playing.

#### About the disc indicators

Each disc indicator corresponds to the disc tray of the same number.

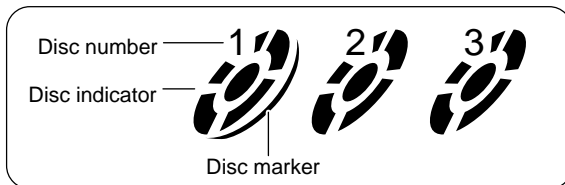

- The disc marker lights up for the disc number you have selected.
- The disc indicator flashes while the corresponding CD is being played.
- The disc indicator goes off when the unit has detected that there is no CD on the corresponding disc tray.

## Playing Back the Entire Discs — Continuous Play

You can play CDs continuously.

### 1 Place CDs.

### 2 Press one of the disc number buttons (CD 1, CD 2, and CD 3) [14], [1], [2] for the disc you want to play.

CD play starts from the first track of the selected disc.

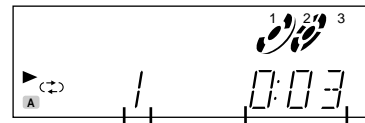
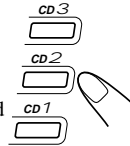

Track number

Elapsed playing time

- Pressing CD  $\blacktriangleright$ /|| [16], [23] instead of the disc number buttons starts playing back if a CD is in the trays.

To stop during play, press  $\blacksquare$  [31], [24].

To remove the disc, press  $\blacktriangle$  [13] for the corresponding disc tray.



#### CD playback sequence

When 3 CDs are loaded on the disc trays, they are played in one of the following sequences.

- When CD 1 is pressed : CD 1  $\Rightarrow$  CD 2  $\Rightarrow$  CD 3 (then stops)
- When CD 2 is pressed : CD 2  $\Rightarrow$  CD 3  $\Rightarrow$  CD 1 (then stops)
- When CD 3 is pressed : CD 3  $\Rightarrow$  CD 1  $\Rightarrow$  CD 2 (then stops)
- \* When only 2 CDs are loaded, they are played in the same order, but the disc tray without a CD is skipped.

## Basic CD Operations

While playing a CD, you can do the following operations.

### To exchange CDs during playback of another

Press  $\blacktriangle$  [13] corresponding to a CD, not playing or selected currently, to eject and exchange the CD.

If you exchange CDs during play, the current play will not stop until all CDs you have exchanged are played.

### To stop play for a moment

Press CD  $\blacktriangleright$ /|| [16], [23].

While pausing, the elapsed playing time flashes on the display.



To resume play from pausing, press CD  $\blacktriangleright$ /|| [16], [23] again.



### To locate a particular point in a track

During play, press and hold ◀◀ [32] or ▶▶ [32].

- ◀◀: Fast reverses the disc.
- ▶▶: Fast forwards the disc.

When using the remote control, press and hold

◀◀ / ◀ [9] or ▶▶ / ▶ [21].

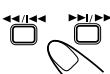
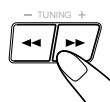

### To go to another track

Press ◀◀ [20] or ▶▶ [20] repeatedly before or during playback.

- ◀◀: Goes back to the beginning of the current or previous tracks.
- ▶▶: Skips to the beginning of the next or succeeding tracks.

When using the remote control, press ◀◀ / ◀ [9]

or ▶▶ / ▶ [21] during or before playing.

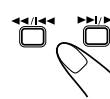

*If you press and hold ◀◀ / ▶▶ [20] (or ◀◀ / ▶▶ [9] or ▶▶ / ▶ [21] before playing)*

*You can change the tracks continuously.*

### To go to another track directly using the number buttons

Pressing the number button(s) [19] before or during play allows you to start playing the track number you want.

- Ex.:
- For track number 5, press 5.
  - For track number 15, press +10, then 5.
  - For track number 20, press +10, then 10.
  - For track number 32, press +10, +10, +10 then 2.

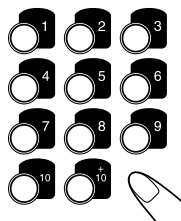

### 3 Press one of the disc number buttons (CD 1, CD 2 and CD 3) [14], [1] to select the disc number you want to play.

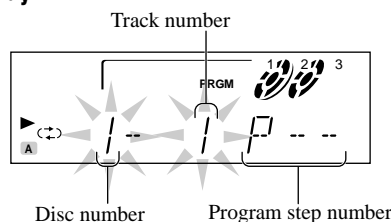
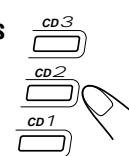

### 4 Select a track from the CD selected in the above step.

#### On the unit:

Press ◀◀ [20] or ▶▶ [20] to select the track number, then press SET [28].

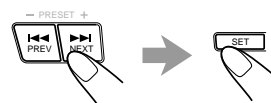

#### On the remote control:

Press the number buttons [19].

- For how to use the number buttons, see "To go to another track directly using the number buttons" described to the left.

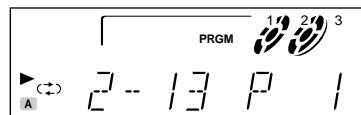
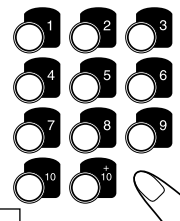

## Programming the Playing Order of the Tracks — Program Play

You can arrange the order in which the tracks play before you start playing. You can program up to 32 tracks.

- To use Repeat play (see page 11) for Program play, press REPEAT [36] after starting Program play.

### 1 Place discs.

- If the current playing source is not the CD player, press CD ▶/|| [16], [23], then ■ [31], [24] before going to the next step.

### 2 Press PROGRAM [34] button.



- If a program has been stored in memory, the program is called up.

### 5 Program other tracks you want.

- To program tracks from the same disc, repeat step 4.
- To program tracks from a different disc, repeat steps 3 and 4.

### 6 Press CD ▶/|| [16], [23].

The tracks are played in the order you have programmed.

To stop during play, press ■ [31], [24].

To exit from Program play mode, press PROGRAM [34] again before or after play so that the unit enters Continuous play mode. (The program you have made is stored in memory until you erase the program or turn off the unit.)



*If you select TAPE or AUX or FM/AM after you set programming or Program play and also program recording, you see sometimes the current CD's track number and total time on display.*

*In this case, press program button until disappear PRGM on display at CD function.*



### To check the program contents by remote control

Before playing, you can check the program contents by pressing ◀◀/▶▶ ⑨ or ▶▶/▶▶ ⑩ on the remote control.

- ▶▶/▶▶: Shows the programmed tracks in the programmed order.
- ◀◀/▶▶: Shows them in the reverse order.

### To modify the program

Before play, you can erase the programmed tracks shown on the display by pressing CANCEL ⑳.

- Each time you press the button, the programmed track shown on the display is erased from the program.



**To add tracks in the program before play**, simply select the track numbers you want to add by following step 4 of the programming procedure on page 10.

**To erase the entire program before or after play**, press ■ ♂ ⑳, ㉔.

“PROGRAM” appears on the display.

- Ejecting a CD will also erase the track numbers programmed from the ejected CD.



#### If you try to program a 33rd step

“FULL” will appear on the display.



#### If your entry is ignored

You have tried to program a track from an empty tray, or a track number that does not exist on the CD (for example, selecting track 14 on a CD that only has 12 tracks). Such entries are ignored.

## Playing at Random — Random Play

The tracks of all loaded CDs will play at random.

- To use Repeat play for Random play, press REPEAT ㉞ after starting Random play.

### 1 Prepare CDs.

- If the current playing source is not the CD player, press CD ▶/|| ⑮, ㉓, then ■ ♂ ⑳, ㉔ before going to the next step.

### 2 Press RANDOM ㉕ button.

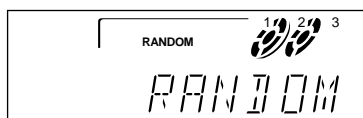

### 3 Press CD ▶/|| ⑮, ㉓.

The tracks are played at random.  
Random play ends when all the tracks are played once.



**To stop during play**, press ■ ♂ ⑳, ㉔.

- Random play also stops when the current disc tray is opened.

**To exit from Random play mode**, press RANDOM ㉕ again before or after play so that the unit enters Continuous play mode.



#### Even if you press ◀◀ ㉒ (or ◀◀/▶▶ ⑨) on the remote control

You cannot go back to the previous tracks during Random play.

- If you press ▶▶ ㉒ (or ▶▶/▶▶ ⑩) on the remote control, you can go to next random tracks.
- RANDOM PLAY starts playing from the current tray and then subsequently to the next tray when all the tracks from the current tray are finished.

## Repeating Tracks or CDs — Repeat Play

You can have all the CDs, the program or the individual track currently playing repeat as many times as you like.

**To repeat play**, press REPEAT ㉞ during or before playing. To use Repeat play for Program play and Random play, press the button after starting playback.



- Each time you press the button, Repeat play mode changes as follows, and the following indicator lights up on the display:

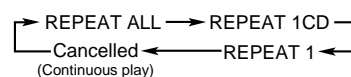

**REPEAT ALL:** Repeats all the tracks on all the CDs (continuously or at random), or all the tracks in the program.

**REPEAT 1CD\*:** Repeats all the tracks on one CD.

**REPEAT 1\*\*:** Repeats one track on one CD.

\* REPEAT 1CD is not used for Program play and Random play.

\*\*REPEAT 1 is not used for Random play.

**To cancel Repeat play**, press REPEAT ㉞ repeatedly until the REPEAT indicator (REPEAT ALL, REPEAT 1CD, or REPEAT 1) goes off from the display.

- Repeat play is also cancelled when you select Program play or Random play.

## Prohibiting Disc Ejection — Tray Lock

You can prohibit CD ejection from the unit and can lock discs.

- This operation is possible only using the buttons on the unit.

**To prohibit disc ejection**, press ▲ ⑬ for any disc tray while holding ■ ♂ ⑳. (If there is any disc tray opened, close it first.) “LOCKED” appears for a while, and the loaded CDs are locked.

**To cancel the prohibition and unlock the CDs**, press ▲ ⑬ for any disc tray while holding ■ ♂ ⑳.

“UNLOCKED” appears for a while, and the loaded CDs are unlocked.



#### If you try to eject CDs

“LOCKED” appears to inform you that the Tray Lock is in use.





# Playing Back Video CDs/SVCDs

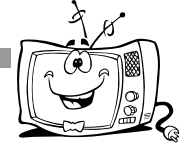

## Selecting Video Out

To playback images correctly on your TV, select the video out according to your TV system, select the proper video out using the buttons on the Unit before you play a disc.

### 1 At standby mode.

### 2 Press and hold one of the disc number [14] button for more than 2 sec.

CD3 ..... for NTSC exclusive TV.

CD2 ..... for Multisystem TV.

Multi detects the formula of the disc (NTSC/PAL) automatically and plays the image on the screen correctly.

CD1 ..... for PAL exclusive TV.

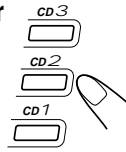

- Select the video output mode before you play the disc.
- When you play an NTSC disc in MULTI mode on a PAL exclusive TV, the image may be distorted. If this happens, change the mode to PAL.
- When you play an NTSC disc in MULTI mode on a Multisystem TV, the image may blink for a moment. This symptom is caused by the Unit detecting the formula of the disc, not by a malfunction of the unit.
- Only on standby mode.

## Placing CDs

### 1 Press ▲ [13] on the CD Player you want to insert the disc onto the tray.

"CD OPEN" appears on the display and the disc tray slides out.

CD OPEN

### Compu Play

When ▲ [13] is pressed while the power is on standby, the power is automatically turned on.

### 2 Place a CD, with its label side up, onto the tray.

ATTENTION: To avoid malfunctions when you play a CD, set the CD in the right place at the center of the tray.

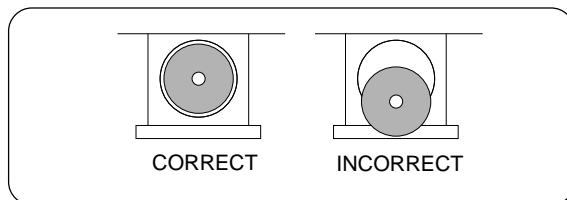

### 3 Press ▲ [13] to close the tray.

"CD CLOSE" appears on the display.

CD CLOSE

### 4 Repeat steps 1 to 3 to insert other discs onto the other trays.

To continue putting discs onto other trays, even if a tray is open, by pressing the ▲ [13] button of another disc tray, the open tray will close automatically, and the new disc will slide out.

When you place a CD onto the currently selected tray, whose disc number shown on the CD indicator, reading of the CD starts. After the reading is completed, the total number of tracks and total playing time will appear, then the playing time of the first track.

READING NOW → 14 67:44 → 1 5:40  
 Total number of tracks and playing time      Playing time of the 1st track

If you place a video CD, "VIDEO CD" will appear before the playing time of the first track. If the video CD has the Playback Control function, "VCD PBC" will appear.

To put an 8 cm CD onto a tray, insert it so that it is aligned with the groove in the tray's center.

If a tray is open when the System switches to the standby mode, the tray will close automatically.

## Playing a Video CD

You can play video CDs either with or without the PBC function.

### 1 Turn on the TV and select the video input so that you can view the pictures from the CD player.

Refer also to the manual supplied for your TV.

### 2 Prepare a CD.

Refer to "Placing CDs" in this page.

### 3 Start playback of the CD

Press CD ►/|| [16], [23] to start playback of the currently selected CD, or press CD 1-3 [14], [1] to select the disc and start play.

When you play a Video CD, "VIDEO CD" appears on the display.

When you play a Super VCD, "SVCD" appears on the display.

VIDEO CD

### Compu Play

When CD ►/|| [16], [23] or press CD 1-3 [14], [1] is pressed while the power is on standby, the power is automatically turned on.

To stop during play, pressed ■ [31], [24]. (playing with PBC function, please refer to page 13.)

To stop play and remove the disc, press ▲ [13] for the disc being played.



## Playing Video CDs/SVCDs with PBC Function- Menu Play

This System provides a Playback Control (PBC) function which utilizes a procedure (menu selection) programmed in a video CD. The playback operation procedure may differ depending on the disc you use.

For Menu Play, use the following buttons:

### On the unit:

NEXT (▶▶) ..... for viewing the unshown portion of the menu

PREV (◀◀) ..... for viewing the previously shown portion of the menu

VCD NUMBER +, - for selecting an item

SELECT (CD ▶/||) ... for starting playback of the selected item

■ ⏪ ..... for going back to the previous menu

### On the remote control:

NEXT (▶▶/▶▶) ..... for viewing the unshown portion of the menu

PREV (◀◀/◀◀) ..... for viewing the previously shown portion of the menu

Number buttons ..... for selecting and starting playback of an item

SELECT (▶) ..... for starting playback of the selected item

■ ⏪ ..... for going back to the previous menu



Some discs are made with PBC format without menu.

## Basic Concept of the PBC function

The PBC (Playback Control) function allows you to enjoy menu-driven operation and high resolution still images having a resolution four times greater than video pictures.

### Menu-driven playback

You can interact with the screen using a menu display to select and play an entry.

## 1 Turn on the TV and select the video input so that you can view the pictures from the CD Player.

Refer also to the manual supplied for your TV.

## 2 Prepare a CD

Refer to "Loading CDs" on page 12.

## 3 Start playback of the CD.

Press CD ▶/|| [16], [23] to start play of the currently selected CD, or press CD 1-3 [14], [1] to select the disc and start play. "VCD PBC" appears on the display.

VCD PBC

## 4 Select the item you want to view.

### On the unit:

Press VCD NUMBER + [39] to select larger item numbers, or press VCD NUMBER - [39] to select smaller item number. Then press CD ▶/|| [16], [23] to start the disc.

### On the remote control:

Press the number buttons [19] to select and play the item you want.

To stop the track being played and return to the menu, press ■ ⏪ [31], [24] button.

To stop Menu Play or to stop play directly, press and hold ■ ⏪ [31], [24] for more than 2 seconds. A blue screen appears on the TV.

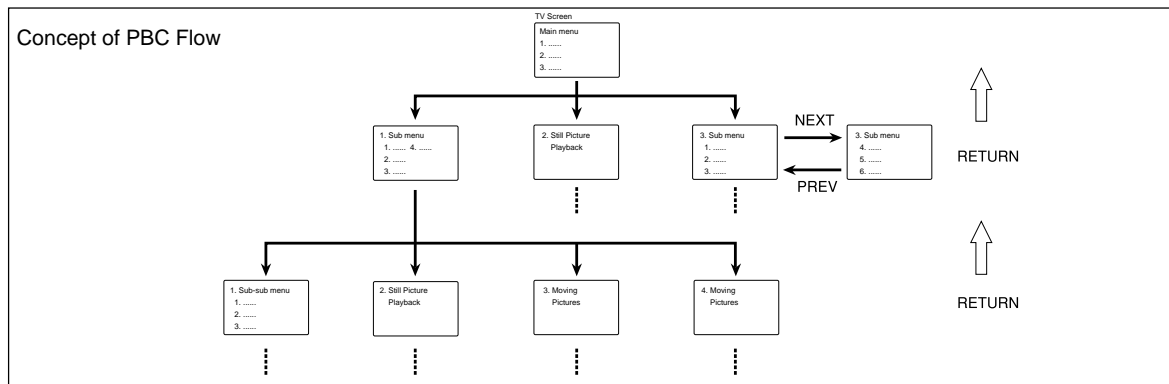

### Basic flow of Menu Play Operation

A selection menu is shown when you start playing a video CD with the PBC function. The menu shows a list of items to select. Some discs may show moving pictures or a divided screen.

- When a list of items appears, you can select a number of the item you want to play back.
- When moving pictures appear, you can select a moving picture by pressing ◀▶ [9], [21] or number buttons [19] while the moving picture you want to view is being played back.

### High-resolution still image display

You can display high-quality images four times clearer than video pictures.

- When the menu appears after the item you have selected finishes playing, you can select another number of the item you want to view next.
- After playback, press ■ ⏪ [31], [24] to go back to the previous screen. Each time you press the button, you can go back to the previous screen one by one.
- If you want to stop Menu Play, press and hold ■ ⏪ [31], [24] for more than 2 seconds. Some discs may return you to the menu screen before playback.



- When a menu is shown for about 10 minutes, the screen background automatically fades out to prevent screen burn-in while the setting is suspended.

## Playing Video CDs/SVCDs without the PBC function - Continuous Play

Even if a video CD has PBC function, you can cancel the PBC function and play the disc without using menu screen, as if it were without the PBC function.

### 1 Turn on the TV and select the video input so that you can view the pictures from the CD Player.

Refer also to the manual supplied for your TV.

### 2 Prepare a CD



Refer to "Loading CDs" on page 12.

### 3 Press REPEAT on the unit to select either "REPEAT 1", "REPEAT 1CD" or "REPEAT ALL".



### 4 Start playback of the CD.



On the unit:

Press CD  or CD 1-3  of the disc you want to play. The selected video CD starts playback from the first track.



OR

Press the number button  of the track you want to start playing with. The playback starts from the selected track of the currently selected disc.

To stop during play, press    .

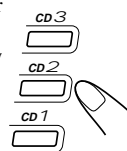
To restore the PBC function, stop the CD playback and press REPEAT  repeatedly until the REPEAT indicator goes out. Then press current CD1, CD2 or CD3   to play VCD with PBC function.



- After cancelling the PBC function, you can Continuously Play of more than one video CD with the PBC function.
- When the PBC function is cancelled, some images such as still play pictures may not be played back.
- After cancel PBC function, if press CD   PBC will still cancel.

## Resuming Play

If you stop a video CD or Super Video CD (SVCD) directly, you can continue to see the same scene that you have stop before.

### 1 During playing a VCD or SVCD, press button to stop playing. (refer page 13)

### 2 Press CD button to continue playback from the last scene that you have stop.





NOTE:

- 1 Resume play will not work when the CD tray has been opened.
- 2 It is advisable to turn off the PBC function to use resuming play if not it will resume at PBC menu.

## Special Plays for a Video CD

You can use the following special play modes for video CDs both with and without PBC function. The following functions can only be executed with the buttons on the remote control.

### Frame-by-Frame Playback

Press CD   then   during playback.

When you press the button first, play pauses and you see a still picture on the TV screen. Then each time you press the button, still pictures advance by one frame. During frame-by-frame playback, no sound comes out.

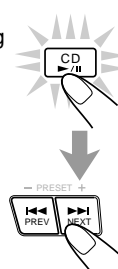

To resume normal playback, press CD  .

### Viewing Operating Status

Usually, the following information of the track being played are shown on the TV screen during playback: the disc number, the track number, and the playing time.

### Press ON SCREEN on remote control.

Each time you press the button, the display of operation status turns on and off. When the display of operation status turns on, the following information of the track being played appear on the TV screen briefly: MPX mode and key control.



The TV screen will show the below:

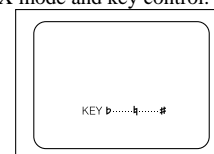

To cancel the display of operation status, press ON SCREEN  "DISP. OFF" appears on the TV screen briefly and all the information about the track being played disappear.

### Viewing the Video Intro of the Video CD

You can view the contents of a video CD, watching first 5 seconds of each track on the video CD. Video intro does not work with PBC. For a video CD with PBC, cancel the PBC function referring to above.

### 1 Press CD 1-3 for the disc you want to view the video intro of.

Playback starts.

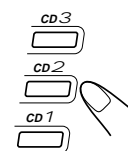

### 2 Press V.INTRO after a picture appears on the TV screen.

The video intro play starts and shows in sequence, the first 5 seconds of nine tracks on the TV screen. If the CD consists of more than 9 tracks, track above 9 will be shown after the first 9 tracks are shown.



The TV screen will show the below:

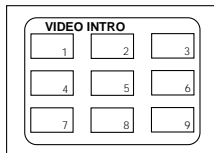

**3 Press the number button 19 for the video intro you want to select.**

Playback starts from the selected track.

To stop and cancel the video intro play, press ■ 31, 24.

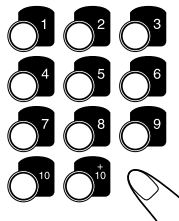

### Viewing the Highlights of a Video CD

You can view highlight scenes of the selected track on a video CD only when PBC is off. These highlights scenes are created by dividing the track equally into 9 portions and the beginning (5 seconds each) of those 9 scenes are shown on the display.

**1 Press CD 1-3 14, 1 and the number button 19 for the track you want to view the highlights of.**

Playback starts.

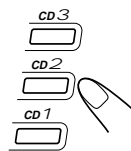

**2 Press HIGHLIGHT 18 after a picture appears on the TV screen.**

The highlight play starts and shows in sequence, the first 5 seconds of nine divided highlight scenes on the TV screen for 1 minute. If a highlight scene is not selected, it will automatically start and show highlight of the next track every one minute.



TV screen will show the below:

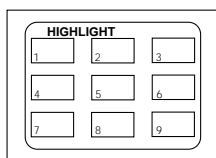

**3 Press the number button 19 for the highlight you want to select.**

Playback starts from the selected scene.

To stop and cancel the highlight play, press ■ 31, 24 button.

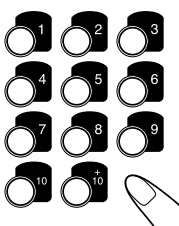

- If a highlight scene is not selected while 9 scenes are shown on the TV, highlight scenes of the next track will appear on the display.
- When a highlight scene is selected, playback starts from the beginning of the highlight scene, but not from the still image shown on the display (the part shown is the last part of the highlight scene, not its beginning)
- During the video intro or highlight play, image shown on the display may be partially distorted, resulting from noises or incorrect manufacturing of the disc.

### Playing a multiplex sound CD

This function is used for multiplex (MPX) sound discs. See manuals attached to discs for detail information.

#### Operation

By pressing the MPX 29 button consecutively, channel multiplexing modes are cycled as shown below.

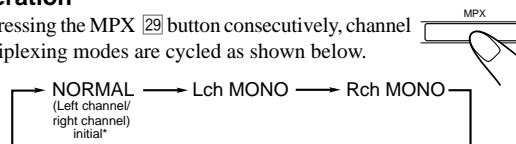

When Lch MONO or Rch MONO is selected, display indicates Lch MONO or Rch MONO respectively.

Lch MONO: Only the left channel (instrumental parts) is played back through both right and left speakers.

Rch MONO: Only the right channel (vocal parts) is played back through both right and left speakers.

NORMAL: Cancels the Vocal masking function. Used for conventional stereo sources.

When playing back an SVCD (Super Video CD):

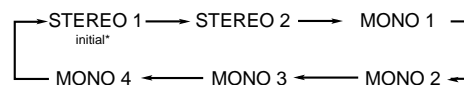

Note that you can hear no audible sound at the STEREO 2, MONO 3 and MONO 4 positions if no audio is recorded on STEREO 2. Initial\*: Whenever you change a CD or when you select another CD tray, MPX will reset to the initial mode.

### Using SUBTITLE

Effective only when playing back all SVCD (Super Video CD). SVCD discs may have up to four subtitles which you can select to see on the TV screen (as an optional feature). Pressing this button cycle the subtitle as shown below:

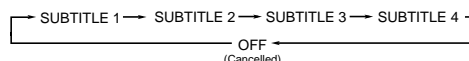



# Listening to FM and AM Broadcasts

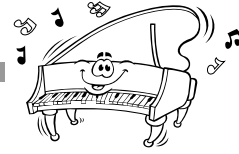

## Tuning in a Station

On the unit **ONLY**:

### 1 Press FM/AM [17].

The unit automatically turns on and tunes in the previously tuned station (either FM or AM). The Powered Rolling Panel automatically opens.

- Each time you press the button, the band alternates between FM and AM.



### 2 Press SET [28].



### 3 Press PRESET - / + [20] to select a preset number.



### 4 Press SET [28] again.

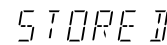

The tuned station in step 1 is stored in the preset number selected in step 3.

- Storing a new station on a used number erases the previously stored one.

### 2 Press and hold TUNING - / + [32] for more than 1 second.

The unit starts searching for stations and stops when a station of sufficient signal strength is tuned in. If a program is broadcast in stereo, the ST indicator lights up.

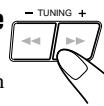

To stop during searching, press TUNING - / + [32].



*When you press TUNING - / + [32] briefly and repeatedly*

*The frequency changes step by step.*



*When you unplug the AC power cord or if a power failure occurs*

*The preset stations will be erased in a few days. If this happens, preset the stations again.*

### To change the FM reception mode

When an FM stereo broadcast is hard to receive or noisy, press FM MODE [20] on the remote control so that the MONO indicator lights up on the display. Reception improves.



To restore the stereo effect, press FM MODE [20] again so that the MONO indicator goes off.

In this stereo mode, you can hear stereo sounds when a program is broadcast in stereo.

## Tuning in a Preset Station

### 1 Press FM/AM [17], [25].

The unit automatically turns on and tunes in the previously tuned station (either FM or AM). The Powered Rolling Panel automatically opens.

- Each time you press the button, the band alternates between FM and AM.



### 2 Select a preset number.

On the unit:

Press PRESET - / + [20].

On the remote control:

Press the number buttons [9].

For preset number 5, press 5.

For preset number 15, press +10, then 5.

For preset number 20, press +10, then 10.

For preset number 25, press +10, +10, then 5.

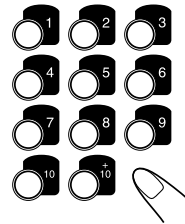

## Presetting Stations

You can preset 30 FM and 15 AM stations.

In some cases, test frequencies have been already memorized for the tuner since the factory examined the tuner preset function before shipment. This is not a malfunction. You can preset the stations you want into memory by following the presetting method.

- There is a time limit in doing the following steps. If the setting is cancelled before you finish, start from step 1 again.

### 1 Tune in the station you want to preset.

- See "Tuning in a Station" above.



## Playing Back Tapes

You can play back type I, type II and type IV tapes without changing any settings.

### Playing Back a Tape

- 1 Press EJECT (▲) [12]/[19] for the deck you want to use.**

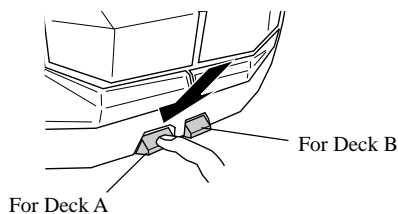

- 2 Put a cassette in, with the exposed part of the tape down.**

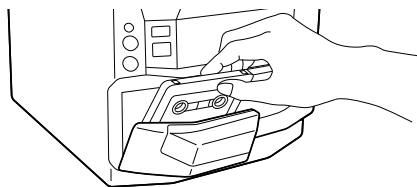

- 3 Close the cassette holder gently.**

If you put cassettes in both decks A and B, the last deck you have put a cassette into is selected.

**To operate the other deck,** press DECK A/B [25] (or TAPE A [6] or TAPE B [7] on the remote control).

- 4 Press TAPE ◀▶ [7], [11].**

The tape play starts and the tape direction indicator (▶) starts flashing slowly to indicate the tape running direction.

- Each time you press the button, the tape direction changes.
  - ▶ : plays the front side.
  - ◀ : plays the reverse side.



When the tape plays to the end, the deck automatically stops if the Reverse Mode is not on. (See "To play both sides repeatedly — Reverse Mode.")

**To stop during play,** press ■ [31], [24].

**To operate the other deck,** press DECK A/B [25] (or TAPE A [6] or TAPE B [7] on the remote control), then TAPE ◀▶ [7], [11].

**To fast wind to the left or to the right,** press ◀▶ [32] (◀◀/▶▶ [9] or ▶▶/▶▶ [2]) on the remote control) while the tape is not running.

The tape direction indicator (▶) starts flashing quickly on the display.

**To remove the cassette,** press ▲ EJECT [12] for deck A or EJECT ▲ [19] for deck B.

### To play both sides repeatedly — Reverse Mode

Reverse Mode works for both decks at the same time.

When it is in use, the tape automatically reverses at the end of a side and the unit starts playing the other side of the tape, and repeats the same process.

**To use Reverse Mode,** press REVERSE MODE [21] so <sup>REVERSE MODE</sup> that the Reverse Mode indicator on the display lights up like — (↻)



**To cancel Reverse Mode,** press the button again so that the Reverse Mode indicator on the display lights up like — → ←



**When Reverse Mode is on with cassettes in both decks A and B**

After the reverse (◀) side of the tape finishes playing, the tape in the other deck starts playing.

### Locating the Beginning of a Song — Music Scan

You can use Music Scan to locate the beginning of a song. Music Scan searches for blank portions that usually separate recorded songs, then plays the next song.

#### To find the beginning of the current song

During play, press ◀▶/▶▶ [32] (◀◀/▶▶ [9] or ▶▶/▶▶ [2]) on the remote control) in the opposite direction to the tape play.

The tape direction indicator of the opposite direction to the tape play starts flashing slowly and quickly alternately.

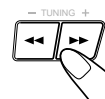

Searching stops automatically at the beginning of the current song, and the current song starts automatically.

#### To find the beginning of the next song

During play, press ◀▶/▶▶ [32] (◀◀/▶▶ [9] or ▶▶/▶▶ [2]) on the remote control) in the same direction as the tape play.

The tape direction indicator of the same direction as the tape play starts flashing slowly and quickly alternately.

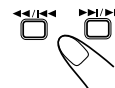

Searching stops automatically at the beginning of the next song, and the next song starts automatically.



**Music Scan works by detecting a 4-second long blank between each song, so it will not work well in the following cases**

- No blank at the beginning of a song.
- Noise (often caused by much use or poor quality dubbing) which fills the blank.
- Long, very soft passages or pauses in a song.



The use of the C-120 or thinner tape is not recommended, since characteristic deterioration may occur and this tape easily jams in the pinch-rollers and the capstans.





# Recording



## IMPORTANT:

- It may be unlawful to record or play back copyrighted material without the consent of the copyright owner.
- The recording level is automatically set correctly, so it is not affected by the VOLUME control. Thus, during recording you can adjust the sound you are actually listening to without affecting the recording level.
- While recording, you can hear sound modes and/or the Active Bass Extension effect through the speaker or headphones. However, the sound is recorded without these effect (see page 8).
- If recording you have made have excesssive noise or static, the unit may be too close to a TV. Increase the distance between the TV and the unit.
- You can use type I and II tapes for recording.

### To protect your recording

Cassettes have two small tabs on the back to protect unexpected erasure or re-recording.

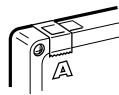

To protect your recording, remove these tabs.

To re-record on a protected tape, cover the holes with adhesive tape. When using type II tape, be careful not to cover the holes used to detect the tape type.

### To keep the best recording and playback sound quality

If the heads, capstans, and pinch rollers of the cassette decks become dirty, the following will occur:

- Impaired sound quality
- Discontinuous sound
- Fading
- Incomplete erasure
- Difficulty in recording

### To clean the heads, capstans and pinch rollers

Use a cotton swab moistened with alcohol.

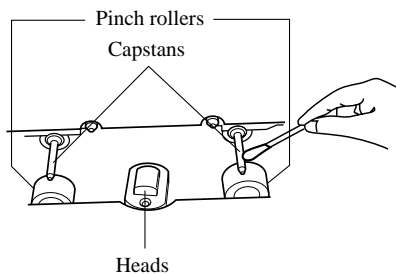

### To demagnetize the heads

Turn off the unit, and use a head demagnetizer (available at electronics and record shops).

## Recording Tapes on Deck B

1 Press EJECT [19] for the deck B.

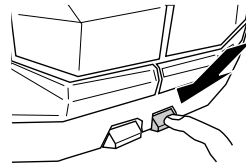

2 Put in a recordable cassette, with the exposed part of the tape down.

3 Close the cassette holder gently.

4 Check the tape direction of deck B.

- If the tape direction is not correct, press TAPE [7], [11] twice then [31], [24] to change the tape direction.

5 Start playing the source — FM, AM\*, CD player, deck A or auxiliary equipment connected to AUX jacks.

- When the source is CD, you can also use CD Direct Recording. (see page 19.)
- When the source is deck A, you can also use the dubbing method. (See “Dubbing Tapes” on page 19.)

\* See “To record an AM station — Beat Cut” on page 19.

6 Start recording.

On the unit:

Press REC START/STOP [22].

The **REC** indicator lights up on the display and recording starts.

On the remote control:

1) Press REC PAUSE [8].

The **REC** indicator starts flashing on the display.

2) Press TAPE [1].

The **REC** indicator stops flashing and remains lit, and recording starts.



To stop during recording, press REC START/STOP [22] again (or [24] on the remote control).

To stop recording temporarily (except when the playback source is deck A), press REC PAUSE [8] on the remote control.

To resume recording, press TAPE [7], [11].



To remove the cassette, press EJECT [19] for deck B.



**To record on both sides — Reverse Mode**

Press REVERSE MODE [21] so that the Reverse Mode indicator lights up as — 

- When using the Reverse Mode for recording, start recording in the forward (▶) direction first. Otherwise, recording will stop when recording is done only on one side (reverse) of the tape.

**To cancel Reverse Mode**, press the button again so that the Reverse Mode indicator lights up as — 

**To record an AM station — Beat Cut**

While recording an AM broadcast, beats may be heard (which are never heard when listening to the broadcast without recording it). If this occurs, press PROGRAM [34] repeatedly, while recording, until the beats are reduced.

- Each time you press the button, the display changes to show the following:

→ CUT1 → CUT2 → CUT3

**Dubbing Tapes**

It is preferable that the tape type (type I or II) you record from be the same as the tape type you record onto when dubbing tapes.

**1 Press TAPE** ◀▶ [7], (1), then ■ Ⓞ [31], (2).

**2 Put the source cassette in deck A, and a recordable cassette into deck B.**

- Put the cassettes in both decks so that the tapes will run in the forward (▶) direction.

**3 Press DUBBING** [23].

Dubbing starts.

**To stop during dubbing**, press ■ Ⓞ [31], (2).

**To remove the cassette**, press ▲ [12] EJECT for deck A and EJECT ▲ [19] for deck B.

**To record on both sides — Reverse Mode**

Press REVERSE MODE [21] so that the Reverse Mode indicator lights up as — 

**To cancel Reverse Mode**, press the button again so that the Reverse Mode indicator lights up as — 

**CD Direct Recording**

Everything on the CD goes onto the tape in the order it is on the CD, or according to the order you have made for Program play.

**1 Put a recordable cassette into deck B.**

**2 Place a disc correctly on the circle of the disc tray, with its label side up.**

**3 Press one of the disc number buttons (CD 1 to CD 3) [14], (1) to select the disc, then ■ Ⓞ [31], (2).**

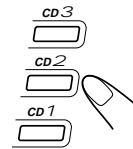

**4 Press CD REC START [24].**

“CD REC” appears, and the **REC** indicator lights up on the display.

Deck B starts recording and the CD player starts playing.

When the recording is done, “CD REC FINISHED” appears on the display, and the CD player and deck B stop.

**To stop during CD Direct Recording**, press ■ Ⓞ [31], (2).

**To remove the cassette**, press EJECT ▲ [19] for deck B.

**To record on both sides — Reverse Mode**

Press REVERSE MODE [21] so that the Reverse Mode indicator lights up as — 

- When using the Reverse Mode for CD Direct Recording, start recording in the forward (▶) direction first. When the tape reaches its end while recording a song in the forward direction (▶), the last song will be recorded at the beginning of the reverse side (◀).

If you start recording on the reverse side (◀), recording will stop when recording is done only on one side (reverse) of the tape.

**To cancel Reverse Mode**, press the button again so that the Reverse Mode indicator lights up as — 





# Using the Microphones

You can enjoy singing along and microphone mixing by using two microphones.

- The MIC LEVEL [8] control adjustment is valid for both microphone connected the MIC 1 [9] and MIC 2 [9] jacks.

### IMPORTANT:

- Always set the MIC LEVEL [8] to MIN when connecting or disconnecting the microphone.
- When you do not use the microphone, keep the microphones unconnected.



### If howling or squealing (feedback) occurs while using the microphone(s)

Take the following actions to prevent these noises.

- Adjust the MIC LEVEL [8] and VOLUME [15] controls.
- Avoid pointing the microphone(s) towards the speakers.
- When two microphones are connected, turn off the On/Off switch on the unused microphone.



### If you use the following sources as the playing source for Vocal Masking, you cannot get the satisfactory results

- Radio programs — a radio signal is not as reliable as the signals coming from a tape or CD.
- Monoaural sources.
- Poorly dubbed tapes.
- Sources recorded with duets, strong echo, a chorus, or only a few instruments.
- Poorly prerecorded tape or CD.

## Singing Along

### Vocal Masking

Vocal Masking reduces the lead vocal of the playing source, and allows you to replace it by singing into the microphones as the music plays.

On the unit **ONLY**:

**1** Rotate the MIC LEVEL [8] to MIN.



**2** Connect the microphone(s) (not supplied) by plugging it into the MIC 1 [9] and/or MIC 2 [9] jack.

**3** Press VOCAL MASKING [3] on the remote control.



The (Ⓜ) indicator also lights up on the display.

**4** Start playing the source — CD, tape, or other connected component.

**5** Rotate the MIC LEVEL [8] and VOLUME [15] controls as you sing into the microphone(s).



- By pressing REC START/STOP [22], you can record your singing along if you want. (For more details, see page 18.)

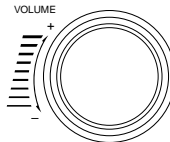

### To apply an echo to your voice

Press ECHO [16] on the remote control so that the echo (≡) indicator lights up on the display.

Each time you press the button, the echo indicator turns on (ECHO ON) and off (ECHO OFF).

- By pressing REC START/STOP [22], you can record your singing along if you want. (For more details, see page 18.)

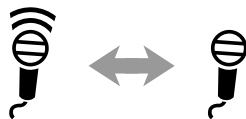

## Singing Along with Multiplex Karaoke Discs (MPX)

If the source you are going to play is a multiplex karaoke disc, you can use the following two functions by using the buttons on the unit - Multiplex sound.

### What is Multiplex Sound?

In a multiplex karaoke disc, the instrumental parts are recorded on the left channel. With this system, you can select the playback sound with your voice through the microphone.

On the unit **ONLY**:

**1** Turn down MIC LEVEL [8] and VOLUME [15] fully.



**2** Connect the microphone (not supplied) into the MIC 1 [9] and/or MIC 2 [9] jack on the front panel.

**3** Play the source - CD.

**4** Press MPX [29] to select the output sound.

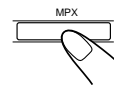

Please refer to page 15.



**5** Turn MIC LEVEL **8** and VOLUME **15** to adjust the microphone level and the speaker output level.

**6** Sing into the microphone.

To apply echo to your voice, see "To apply an echo to your voice" in this page.

To adjust the music key, see "Adjust the Music Key Control" in this page.

To record your singing along, see "Microphone Mixing" in this page.



**When finish singing**

restore the stereo effect by pressing MPX until "NORMAL" appears on the display.

### Recording Your Singing

You can adjust the music key by using the remote control.

**1** Follow the steps in "Singing Along with the Multiplex Karaoke Discs" in page 20.

**2** Follow the steps in "Recording Tapes on Deck B" On page 18 to record your singing.

### To apply an echo to your voice

You can add echo to your voice.

**1** Press ECHO **16** button on the remote control.



### Adjust the Music Key Control (for CD play only)

The Music key control is applicable for CD play only.

**1** Press KEY CONTROL **b** **10** /# **22** to adjust the music key.

To lower the key, press KEY CONTROL **b** **10**.

To raise the key, press KEY CONTROL **#** **22**.



To cancel the key adjustment, press KEY CONTROL **b** **10** or **#** **22** until "KEY 0" appears on the display



**Adjust the music key each time you sing along a song with playing CD**

- Once the CD play is stopped, the key level returns to key 0.
- When the next track is selected or the next tray is selected, the key level also returns to key 0.
- The music key cannot be changed while recording.
- Once the source is changed, the key level returns to key 0.
- The Sound Mode will be cancelled if the Multiplex sound is selected.

**21**

### Microphone mixing

When you sing along with CDs, follow the procedure below:

On the unit ONLY:

**1** Rotate the MIC LEVEL **8** to MIN.



**2** Connect the microphone(s) (not supplied) by plugging it into the MIC 1 **9** and/or MIC 2 **9** jack.

**3** Start playing the source — CD, tape or other connected component.

**4** Rotate the MIC LEVEL **8** and VOLUME **15** controls as you sing into the microphone(s).



- By pressing REC START/STOP **22**, you can record your singing along if you want. (For more details, see page 18.)

### To use microphone only

Without any background sound, you can use your microphone(s), and record it if you want.

**1** Rotate the MIC LEVEL **8** to MIN.

**2** Connect the microphone(s) (not supplied) by plugging it into the MIC 1 **9** and/or MIC 2 **9** jack.

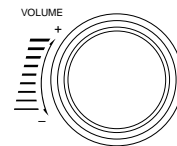

**3** Press CD **16**, **23**, then **31**, **24**.

No background sound will be heard.

**4** Rotate the MIC LEVEL **8** and VOLUME **15** controls as you sing or speak into the microphone(s).

- By pressing REC START/STOP **22**, you can record your singing along if you want. (For more details, see page 18.)



# Using the Timers

There are three timers available — Recording Timer, Daily Timer, and Sleep Timer.

Before using the timers, you need to set the clock built in the unit. (See page 7.)

## Using Daily Timer

With Daily Timer, you can wake up to your favorite music or radio program.

### How Daily Timer actually works

The unit automatically turns on, set the volume level to the preset level, and starts playing the specified source when the on-time comes (the ☺ indicator flashes just before the on-time, and continues flashing while the timer is operating). Then, when the off-time comes (“OFF” flashes just before the off-time), the unit automatically turns off (Standby).

The timer setting remains in memory until you change it.

- There is a time limit in doing the following steps. If the setting is cancelled before you finish, start from step 1 again.
- If you have made a mistake while setting timer, press CANCEL [30]. (However, this does not always work. If CANCEL does not work, press TIMER/CLOCK [26] repeatedly and start from step 1 again.)

On the unit **ONLY**:

**1 Press TIMER/CLOCK [26] until “DAILY” appears on the display.**

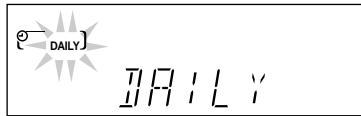

The DAILY indicator also starts flashing on the display.

- Each time you press the button, the timer setting modes change as follows:



**2 Press TIMER/CLOCK [26] again.**

“ON TIME” appears for 2 seconds, then the unit enters on-time setting mode.

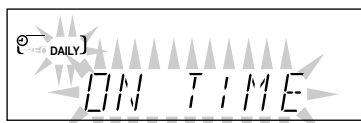

**3 Set the on-time you want the unit to turn on.**

- 1) Press ◀ [20] or ▶ [20] to set the hour, then press SET [28].
  - 2) Press ◀ [20] or ▶ [20] to set the minute, then press SET [28].
- “OFF TIME” appears for 2 seconds, then the unit enters off-time setting mode.



**4 Set the off-time you want the unit to turn off (on standby).**

- 1) Press ◀ [20] or ▶ [20] to set the hour, then press SET [28].
  - 2) Press ◀ [20] or ▶ [20] to set the minute, then press SET [28].
- The unit enters source selecting mode.



**5 Press ◀ [20] or ▶ [20] to select the source to play, then press SET [28].**

- Each time you press ◀ [20] or ▶ [20], the source changes as follows:

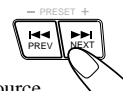
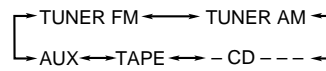

**TUNER FM:** tunes into a specified preset FM station. → go to step 6.

**TUNER AM:** tunes into a specified preset AM station. → go to step 6.

**- CD - - -:** plays a disc from a specified track of a specified disc. → go to step 6.

- Make sure there is a CD on the selected disc number tray.

**TAPE:** plays a tape in deck A or B. → go to step 7.

- Make sure that a tape is in the deck whose deck indicator (A or B) is lit on the display.
- Make sure that the tape direction is correct.

**AUX:** plays an external source. → go to step 7.

- To use this setting, the external component has to be equipped with the timer function.

**6 When selecting “- CD - - -”.**

- 1) Press ◀ [20] or ▶ [20] to select the disc number, then press SET [28].
  - 2) Press ◀ [20] or ▶ [20] to set the track number, then press SET [28].
- The unit enters volume setting mode.



**When selecting “TUNER FM” or “TUNER AM”**

Press ◀ [20] or ▶ [20] to select the preset station number, then press SET [28].

The unit enters volume setting mode.



## 7 Press ◀◀ 20 or ▶▶ 20 to set the volume level.

- You can select the volume level from among four levels. If you select "VOL---," the volume is set to the last level when the unit has been turned off.

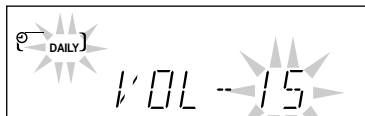

## 8 Press SET 28 to complete the Daily Timer setting.

- The DAILY indicator stops flashing and remains lit. The setting you have done are shown on the display in sequence.

## 9 Press ⏻/| 2, 14 to turn off the unit (on standby) if you have set the Daily Timer with the unit turned on.

### To turn on or off Daily Timer after its setting is done

- Press TIMER/CLOCK 26 repeatedly until "DAILY" appears on the display.
- To turn off the Daily Timer, press CANCEL 30. The DAILY indicator goes off from the display. The Daily Timer is cancelled, but the setting for the Daily Timer remains in memory.

### To turn on the Daily Timer, press SET 28.

- The DAILY indicator lights up on the display. The setting you have done are shown on the display in sequence for your confirmation.



**If the unit is turned on when the timer-on timer comes**

Daily Timer does not work.

## Using Recording Timer

With Recording Timer, you can make a tape of a radio broadcast automatically.

### How Recording Timer actually works

The unit automatically turns on, tunes into the specified station, sets the volume level to "0," and starts recording when the on-time comes (the Ⓢ indicator flashes just before the on-time, and continues flashing while the timer is operating). Then, when the off-time comes ("OFF" appears just before the off-time), the unit automatically turns off (stands by).

The timer setting remains in memory until you change it.

- There is a time limit in doing the following steps. If the setting is cancelled before you finish, start from step 1 again.
- If you have made a mistake while setting the timer, press CANCEL 30. (However, this does not always work. If CANCEL does not work, press TIMER/CLOCK 26 repeatedly and start from step 1 again.)

### On the unit **ONLY**:

## 1 Put a recordable cassette into deck B 18.

## 2 Press TIMER/CLOCK 26 until "REC" appears on the display.

The REC indicator also starts flashing on the display.



- Each time you press the button, the timer setting modes change as follows:



## 3 Press TIMER/CLOCK 26 again.

"ON TIME" appears for 2 seconds, then the unit enters on-time setting mode.

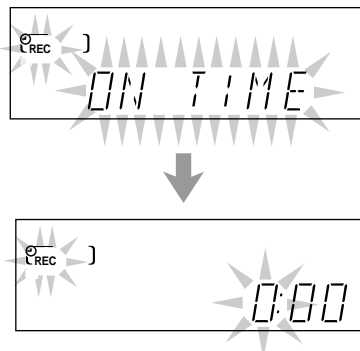



#### 4 Set the on-time you want the unit to turn on.

- 1) Press 20 or 20 to set the hour, then press SET .
  - 2) Press 20 or 20 to set the minute, then press SET .
- "OFF TIME" appears for 2 seconds, then the unit enters off-time setting mode.

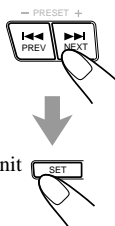

#### 5 Set the off-time you want the unit to turn off (on standby).

- 1) Press 20 or 20 to set the hour, then press SET .
  - 2) Press 20 or 20 to set the minute, then press SET .
- The unit enters preset station selecting mode.

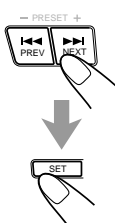

#### 6 Select the preset station.

- 1) Press 20 or 20 to select the band ("TUNER FM" or "TUNER AM"), then press SET .
  - 2) Press 20 or 20 to select a preset channel number, then press SET .
- The REC indicator stops flashing and remains lit. The settings you have done are shown on the display in sequence.

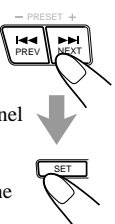

#### 7 Press 2, 14 to turn off the unit (on standby) if necessary.



**If you want to listen to another source while recording**

Press REC START/STOP 22 to stop recording. Without stopping it, you cannot change the source.

#### To turn on or off Recording Timer after its setting is done

- 1) Press TIMER/CLOCK 26 repeatedly until "REC" appears on the display.
- 2) To turn off the Recording Timer, press CANCEL 30. The REC indicator goes off from the display. The Recording Timer is cancelled, but the setting for the Recording Timer remains in memory.
- 3) To turn on the Recording Timer, press SET 28. The REC indicator lights up on the display. The settings you have done are shown on the display in sequence for your confirmation.



#### Using Sleep Timer

With Sleep Timer, you can fall asleep to music. You can set Sleep Timer when the unit is turned on.

#### How Sleep Timer actually works

The unit automatically turns off after the specified time length passes.

#### On the remote control **ONLY**:

##### 1 Press SLEEP 15.

The time length until the shut-off time appears and the SLEEP indicator starts flashing on the display.

- Each time you press the button, the time length changes as follows:

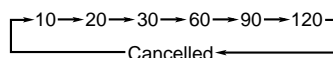

##### 2 Wait for about 5 seconds after specifying the time length.

The SLEEP indicator stops flashing and remains lit.

**To check the remaining time until the shut-off time,** press SLEEP 15 once so that the remaining time until the shut-off time appears for about 5 seconds.

**To change the shut-off time,** press SLEEP 15 repeatedly until the desired time length appears on the display.

**To cancel the setting,** press SLEEP 15 repeatedly so that the SLEEP indicator goes off.

- Sleep Timer is also cancelled when you turn off the unit.

#### Timer Priority

Since each timer can be set separately, you may wonder what happens if the setting for these timers overlaps.

Here are examples.

- **Recording Timer has priority over Daily Timer and Sleep Timer.**

If Daily Timer is set to come on while Recording Timer is operating, Daily Timer will not come on at all.

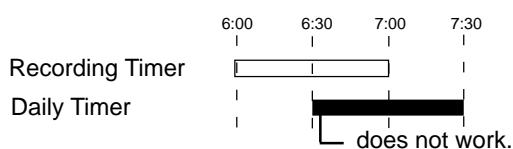

If Recording Timer is set to come on while Sleep Timer is operating, Sleep Timer will not work (the SLEEP indicator does not go off).

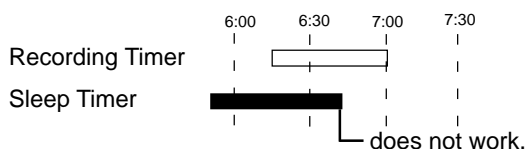

## Maintenance



To get the best performance of the unit, keep your discs, tapes, and mechanism clean.

### Handling discs



- Remove the disc from its case by holding it at the edge while pressing the center hole lightly.
- Do not touch the shiny surface of the disc, or bend the disc.
- Put the disc back in its case after use to prevent warping.

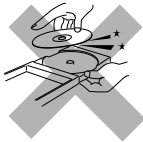

- Be careful not to scratch the surface of the disc when placing it back in its case.
- Avoid exposure to direct sunlight, temperature extremes, and moisture.



### To clean the disc

Wipe the disc with a soft cloth in a straight line from center to edge.

### Handling cassette tapes

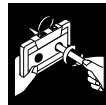

- If the tape is loose in its cassette, take up the slack by inserting a pencil in one of the reels and rotating.
- If the tape is loose, it may get stretched, cut, or caught in the cassette.



- Be careful not to touch the tape surface.



- Avoid the following places to store the tape:
  - In dusty places
  - In direct sunlight or heat
  - In moist areas
  - Near a magnet



**DO NOT** use any solvent — such as conventional record cleaner, spray, thinner, or benzine — to clean the disc.

## Troubleshooting



If you are having a problem with your unit, check this list for a possible solution before calling for service.

If you cannot solve the problem from the hints given here, or the unit has been physically damaged, call a qualified person, such as your dealer, for service.

Symptom	Cause	Action
No sound is heard.	Connections are incorrect or loose.	Check all connections and make corrections. (See pages 3 to 6.)
Hard to listen to broadcasts because of noise.	<ul style="list-style-type: none"> <li>• Antennas are disconnected.</li> <li>• The AM loop antenna is too close to the unit.</li> <li>• The FM antenna is not properly extended and positioned.</li> </ul>	<ul style="list-style-type: none"> <li>• Reconnect the antennas correctly and securely.</li> <li>• Change the position and direction of the AM loop antenna.</li> <li>• Extend the FM antenna at the best position.</li> </ul>
The disc sound is discontinuous.	The disc is scratched or dirty.	Clean or replace the disc. (See above.)
The disc tray does not open or close.	<ul style="list-style-type: none"> <li>• The AC power cord is not plugged in.</li> <li>• Trays are locked.</li> </ul>	<ul style="list-style-type: none"> <li>• Plug the AC power cord.</li> <li>• Unlock the trays. (See page 11.)</li> </ul>
The disc does not play.	The disc is placed upside down.	Place the disc with the label side up.
The cassette holders cannot be opened.	Power supply from the AC power cord has been cut off while the tape was running.	Turn on the unit.
Impossible to record.	Small tabs on the back of the cassette are removed.	Cover the holes with adhesive tape.
Operations are disabled.	The built-in microprocessor may malfunction due to external electrical interference.	Unplug the AC power cord and then plug it back in.
Unable to operate the unit from the remote control unit.	<ul style="list-style-type: none"> <li>• The path between the remote control unit and the remote sensor on the unit is blocked.</li> <li>• The batteries are exhausted.</li> </ul>	<ul style="list-style-type: none"> <li>• Remove the obstruction.</li> <li>• Replace the batteries.</li> </ul>



# Location of the Buttons and Controls



English

## Remote Control

- ① Disc number buttons (CD 1, CD 2, and CD 3) (9-10, 12-15, 19)  
*Pressing one of these buttons also turns on the unit.*
- ② SOUND MODE button (8)
- ③ VOCAL MASKING button (20)
- ④ ON SCREEN button (14)
- ⑤ V.INTRO button (14)
- ⑥ TAPE A button (17)
- ⑦ TAPE B button (17)
- ⑧ REC PAUSE button (18)
- ⑨ ◀◀ / ▶▶ (fast left/reverse search) button (10-11, 13, 17)
- ⑩ KEY CONTROL **b** button (21)  
*Pressing this button also turns on the unit.*
- ⑪ TAPE ◀▶ button (7, 17-19)  
*Pressing this button also turns on the unit.*
- ⑫ FADE MUTING button (8)
- ⑬ AUX button (5, 7)  
*Pressing this button also turns on the unit.*

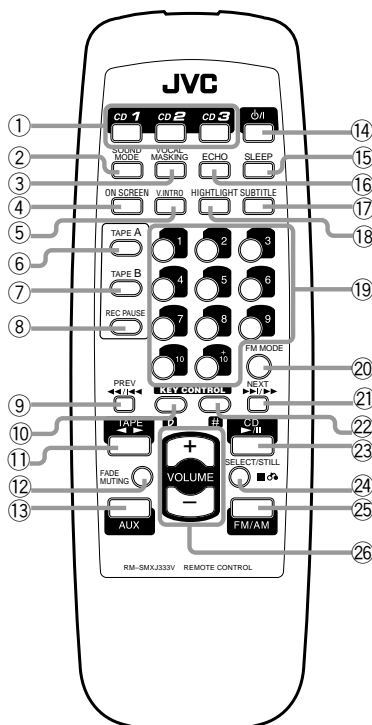

- ⑭ ⏻/⏿ (standby/on) button (7, 23-24)
- ⑮ SLEEP button (24)
- ⑯ ECHO button (20-21)
- ⑰ SUBTITLE button (15)
- ⑱ HIGHLIGHT button (15)
- ⑲ Number buttons (10, 13-16)
- ⑳ FM MODE button (16)
- ㉑ ▶▶1/▶▶ (forward search/fast right) button (10-11, 13, 17)
- ㉒ KEY CONTROL # button (21)
- ㉓ CD ▶/⏸ button (7, 9-14, 21)  
*Pressing this button also turns on the unit.*
- ㉔ ■ ⏹ (stop) button (7, 9-15, 17-19, 21)
- ㉕ FM/AM button (7, 16)  
*Pressing this button also turns on the unit.*
- ㉖ VOLUME + / - button (8)

## Remote Sensor

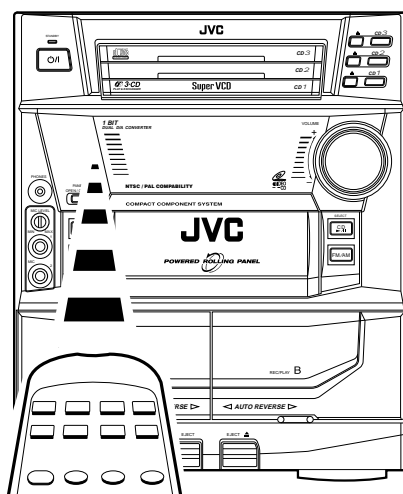

When using the remote control, point it at the remote sensor on the front panel.



## Display Window

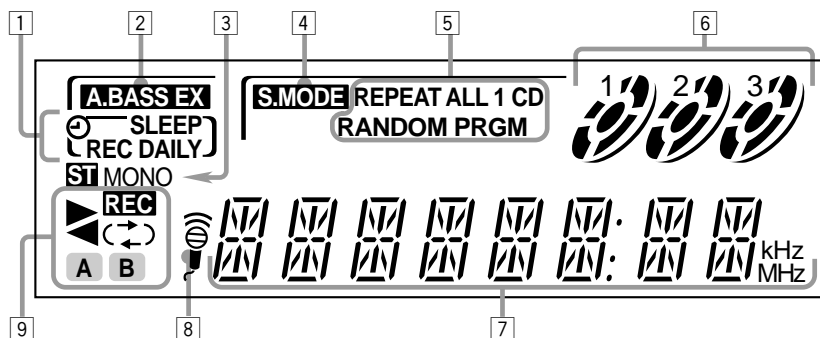

See pages in the parentheses for details.

## Front Panel

- |  |  |
|--|--|
| <p>1 Disc trays</p> <p>2 <math>\text{O/I}</math> (standby/on) button and STANDBY lamp (7, 23–24)</p> <p>3 Display window</p> <p>4 Remote sensor</p> <p>5 PANEL OPEN/CLOSE button (7)<br/><i>Pressing this button also turns on the unit.</i></p> <p>6 PHONES jack (8)</p> <p>7 TAPE <math>\blacktriangleleft/\blacktriangleright</math> button and lamp (7, 17–19)<br/><i>Pressing this button also turns on the unit.</i></p> <p>8 MIC LEVEL control (20–21)</p> <p>9 MIC 1 and MIC 2 jacks (20–21)</p> <p>10 AUX button and lamp (5, 7)<br/><i>Pressing this button also turns on the unit.</i></p> <p>11 Deck A cassette holder (17)</p> <p>12 <math>\blacktriangle</math> EJECT button for deck A (17, 19)</p> <p>13 <math>\blacktriangle</math> (CD tray open/close) buttons (9, 11–12)<br/><i>Pressing this button also turns on the unit.</i></p> <p>14 Disc number buttons (CD 1, CD 2, and CD 3) (9–10, 12–15, 19)<br/><i>Pressing this button also turns on the unit.</i></p> <p>15 VOLUME control (8, 20–21)</p> <p>16 CD <math>\blacktriangleright/\parallel</math> (play/pause) button and lamp (7, 9–14, 21)<br/><i>Pressing this button also turns on the unit.</i></p> <p>17 FM/AM button and lamp (7, 16)<br/><i>Pressing this button also turns on the unit.</i></p> <p>18 Deck B cassette holder (18)</p> <p>19 EJECT <math>\blacktriangle</math> button for deck B (17–19)</p> <p><b>Powered Rolling Panel</b></p> <p>20 PRESET <math>-/+</math> buttons (16)<br/><math>\blacktriangleleft/\blacktriangleright</math> (reverse search/forward search) buttons (7, 10–11, 14, 22–24)</p> <p>21 REVERSE MODE button (17, 19)</p> <p>22 REC START/STOP button (18, 20–21, 24)</p> <p>23 DUBBING button (19)</p> <p>24 CD REC START button (19)</p> <p>25 DECK A/B button (17)</p> | <p>26 TIMER/CLOCK button (7, 22–24)</p> <p>27 SUBTITLE button (15)</p> <p>28 SET button (7, 10, 16, 22–24)</p> <p>29 MPX button (15, 20)</p> <p>30 CANCEL button (7, 11, 21, 23–24)<br/>DEMO button (6)</p> <p>31 <math>\blacksquare</math> <math>\text{O}</math> (stop) button (7, 9–15, 17–19, 21)</p> <p>32 TUNING <math>-/+</math> buttons (16)<br/><math>\blacktriangleleft/\blacktriangleright</math> (fast left/fast right) buttons (10, 17)</p> <p>33 DISPLAY button (7)</p> <p>34 PROGRAM button (10, 19)</p> <p>35 RANDOM button (11)</p> <p>36 REPEAT button (10–11, 14)</p> <p>37 ACTIVE BASS EX. button and lamp (8)</p> <p>38 SOUND MODE button (8)</p> <p>39 <math>-</math> VCD NUMBER <math>+</math> button (13)</p> <p><b>Display window</b></p> <p>1 Timer indicators<br/>• <math>\text{O}</math> SLEEP, REC, and DAILY indicators</p> <p>2 A. BASS EX (Active Bass Extension) indicator</p> <p>3 Tuner operation indicators<br/>• ST (stereo) and MONO indicators</p> <p>4 S. MODE (sound mode) indicator</p> <p>5 CD play mode indicators<br/>• REPEAT (ALL/1CD/1), RANDOM and PRGM (program) indicators</p> <p>6 Disc indicators</p> <p>7 Main display<br/>• Show the source name, frequency, etc.</p> <p>8 Echo (<math>\text{O}</math>) indicators<br/>• Shows the source name, frequency, etc.</p> <p>9 Tape operation indicators<br/>• <math>\blacktriangleleft/\blacktriangleright</math> (tape direction), REC, <math>\text{O}</math> (reverse mode) and A/B (operating deck) indicators</p> |
|--|--|





Become familiar with the buttons and controls on your unit.

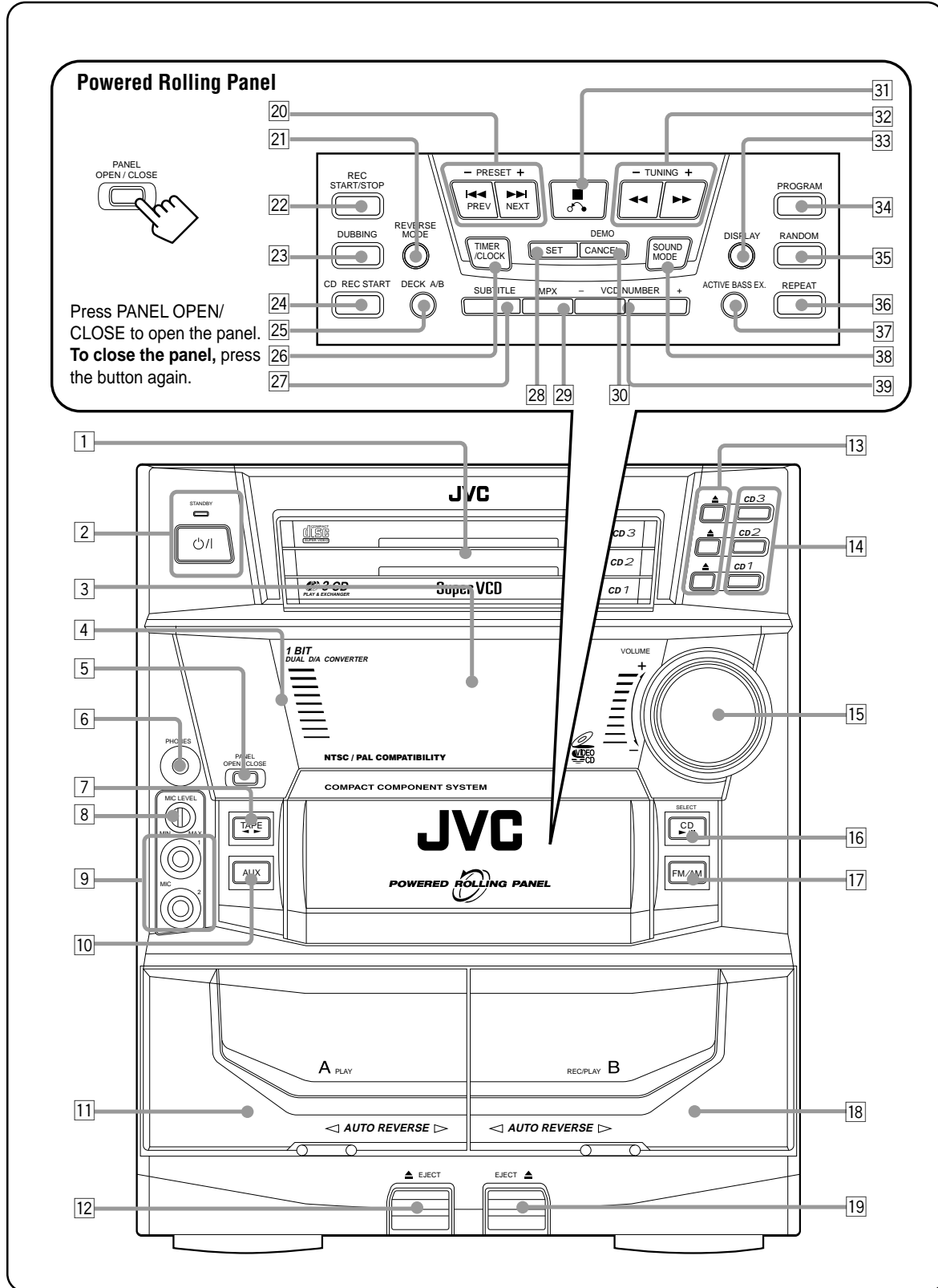

# Specifications

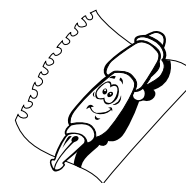

## Center unit section – CA-MXJ333V/CA-MXJ383V

### Amplifier

#### Output Power

53 watts per channel, min. RMS, both channels driven into 6 ohms at 1 kHz with no more than 0.9% total harmonic distortion.

#### Audio input sensitivity/Impedance (at 1 kHz)

AUX: 300 mV/50 kohms

MIC 1/2: 3 mV/5 kohms

Speakers/Impedance: 6 – 16 ohms

### Tuner

FM tuning range: 87.50 – 108.00 MHz

#### AM tuning range:

For Saudi Arabia:

At 9 kHz intervals : 531 – 1,602 kHz

At 10 kHz intervals : 530 – 1,600 kHz

For other countries:

At 9 kHz intervals : 531 – 1,710 kHz

At 10 kHz intervals : 530 – 1,710 kHz

### CD player

CD Capacity: 3 CDs

Dynamic range: 85 dB

Signal-to-noise ratio: 90 dB

Wow and flutter: Immeasurable

### Cassette deck

#### Frequency response

Normal (type I): 50 – 14,000 Hz

CrO<sub>2</sub> (type II): 50 – 14,000 Hz

Metal (type IV): 50 – 14,000 Hz (only for playback)

Wow and flutter: 0.15% (WRMS)

### General

Power requirement: AC 110/127/220/230-240 V ~  
(adjustable with the voltage selector),  
50 / 60 Hz

Power consumption: 90 watts (at operation)  
16watts (at standby mode)

Maximum power consumption (for Taiwan only): 300 watts

Dimensions (approx.): 265 x 315 x 341 mm (W/H/D)  
(10<sup>7</sup>/<sub>16</sub> x 12<sup>7</sup>/<sub>16</sub> x 13<sup>7</sup>/<sub>16</sub> in.)

Mass (approx.): 8.4 kg (18.5 lbs)

### Colour

MX-J333V Silver colour model

MX-J383V Gold colour model

### Supplied accessories

See page 3.

## Speaker section – SP-MXJ333/SP-MXJ383

Type: 3-way bass-reflex type

Speaker units: Woofer: 15cm (5<sup>15</sup>/<sub>16</sub>" ) cone x1

Midrange: 5cm (2" ) cone x1

Tweeter: 2cm (1<sup>3</sup>/<sub>16</sub>" ) dome x1

Power handling capacity: 100 watts

Impedance: 6 ohms

Frequency range: 45 Hz – 22,000 Hz

Sound pressure level: 88 dB/W•m

Dimension (approx): 215 X 315 X 230 mm (W/H/D)  
(8<sup>1</sup>/<sub>2</sub> X 12<sup>7</sup>/<sub>16</sub> X 9<sup>1</sup>/<sub>16</sub> in)

Mass (approx): 3.3 kg (7.3 lbs) each

*Design and specifications are subject to change without notice.*

**Mains (AC) Line Instruction (not applicable for Europe, U.S.A., Canada, Australia, and U.K.)**

**主 (AC) 電源線路說明 (不適用於歐洲、美國、加拿大、澳洲及英國型號)**

تعليمات خط التيار الكهربائي الرئيسي (التردد) (لا تنطبق على اوروبا والولايات المتحدة الامريكية وكندا واوربا والمملكة المتحدة)

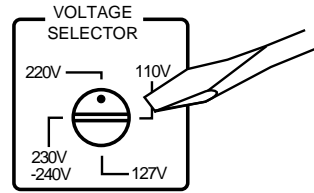
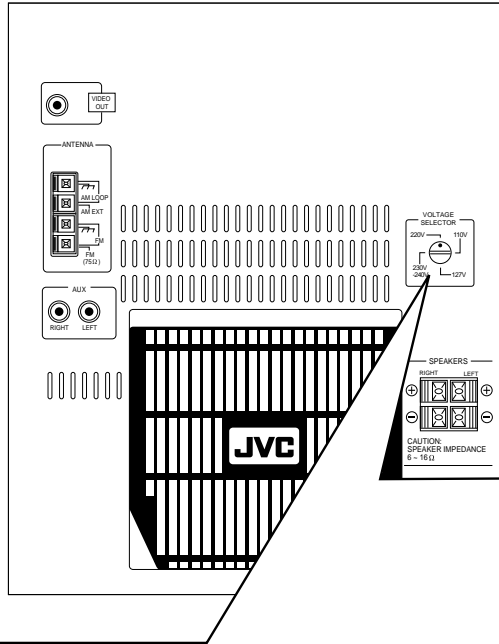

**IMPORTANT for mains (AC) line**

BEFORE PLUGGING IN, do check that your mains (AC) line voltage corresponds with the position of the voltage selector switch provided on the outside of this equipment and, if different, reset the voltage selector switch, to prevent from a damage or risk of fire/ electric shock.

**有關主 (AC) 電源線路的重要事項**

接插電源以前，務請檢查當地的主 (AC) 電源線路電壓是否和位於本機外面的電壓選擇開關設定的位置一致。如果不一致，即重新設定電壓選擇開關使符合當地電壓，以免損壞機器或引起火災／觸電的危險。

هام من اجل خط التيار الكهربائي الرئيسي (التردد) قبل ادخال قابس الطاقة الكهربائية، تأكد من تطابق منتخب فولطية التيار الكهربائي الرئيسي (التردد) الموجود على خلفية الجهاز مع فولطية التيار الكهربائي في بلدك. في حالة عدم التطابق، اعد ضبط مفتاح منتخب الفولطية على فولطية التيار الكهربائي المتردد في بلدك. عدم عمل ذلك، يمكن يؤدي الى حصول ضرر او حريق او صدمة كهربائية.

**JVC**

VICTOR COMPANY OF JAPAN, LIMITED

## Free Manuals Download Website

<http://myh66.com>

<http://usermanuals.us>

<http://www.somanuals.com>

<http://www.4manuals.cc>

<http://www.manual-lib.com>

<http://www.404manual.com>

<http://www.luxmanual.com>

<http://aubethermostatmanual.com>

Golf course search by state

<http://golfingnear.com>

Email search by domain

<http://emailbydomain.com>

Auto manuals search

<http://auto.somanuals.com>

TV manuals search

<http://tv.somanuals.com>