

JVC



Home Cinema DD Speaker System

Heimkino-DD-Lautsprechersystem
Système d'enceinte Home cinéma DD
DD-luidsprekersysteem voor uw huisbioscoop
Sistema de altavoces DD de cine en casa

Sistema di diffusione DD per Home Cinema
Hembio DD-högtalarsystem
Hjemmebiograf DD-højttalersystem
Kotiteatterin DD-kaiutinjärjestelmä

SX-XD33 — Consists of SX-XDS33 and SX-XDC33

Bestehend aus SX-XDS33 und SX-XDC33
Se compose de SX-XDS33 et SX-XDC33
Bestaat uit SX-XDS33 en SX-XDC33
Consta de SX-XDS33 y SX-XDC33

L'impianto è formato da SX-XDS33 e SX-XDC33
Består av SX-XDS33 och SX-XDC33
Består af SX-XDS33 og SX-XDC33
Sisältää seuraavat osat: SX-XDS33 ja SX-XDC33



INSTRUCTIONS

BEDIENUNGSANLEITUNG
MANUEL D'INSTRUCTIONS
GEBRUIKSAANWIJZING
MANUAL DE INSTRUCCIONES
ISTRUZIONI
RUKSANVISNING
VEJLEDNING
KÄYTTÖOHJE

For Customer Use:

Enter below the Model No. and Serial No. which are located either on the rear, bottom or side of the cabinet. Retain this information for future reference.

Model No. _____

Serial No. _____

LVT0953-001A

[E]

Thank you for purchasing a JVC speaker system. Before you begin using these speakers, please read the instructions carefully to be sure you get the best possible performance. If you have any questions, consult your JVC dealer.

Warnings, Cautions and Others

■ Precautions for installation

- Do not install the speakers on an uneven surface or in a place subject to vibration; otherwise, they may fall over, causing damage or injury.
 - Take the occurrence of earthquakes or other physical shocks into consideration when selecting the installation place, and secure the speakers thoroughly.
- To prevent deformation or discoloration of the cabinet, do not install the speakers where they are exposed to direct sunlight or high humidity, and avoid installation near air conditioning outlets.
- Speaker vibrations may cause howling. Place the speakers as far away from the player as possible.
- The speakers are magnetically shielded to avoid color distortions on TVs. However, if not installed properly, it may cause color distortions. So, pay attention to the following when installing the speakers.
 - When placing the speakers near a TV set, turn off the TV's main power switch or unplug it before installing the speakers. Then wait at least 30 minutes before turning on the TV's main power switch again. Some TVs may still be affected even though you have followed the above. If this happens, move the speakers further away from the TV.
- Tuner reception may become noisy or hissing if a speaker is installed near the tuner. In this case, leave more distance between the tuner and the speakers or use an outdoor antenna for better tuner reception without interference from the speakers.

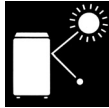

■ Precautions for Daily Use

- **To maintain the appearance of the speakers**

Wipe with a dry, soft cloth if the cabinet or control panel should become dirty. If very dirty, apply a small amount of water or neutral detergent to the cloth and wipe clean, then wipe with a dry cloth.
- **To improve the sound field**

If the speakers are facing a solid wall or glass door, etc., it is recommended to furnish the wall with materials that absorb sounds, for example by hanging up thick curtains, to prevent reflections and standing waves.
- **To use the speakers without any trouble**
 - Do not reproduce sounds at so high a volume that they are distorted; otherwise, the speakers may be damaged by internal heat buildup.
 - When moving the speakers, do not pull the speaker cords; otherwise, the speakers may fall over, causing damage or injury.
 - When holding a satellite speaker, do not grasp the speaker (upper) portion, but always grasp the leg (lower) portion of the satellite speaker.

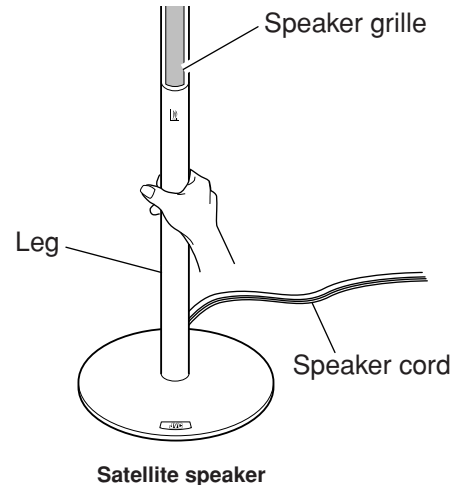
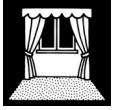

■ Checking the supplied Accessories

Check to be sure you have the following supplied accessories. The number in parenthesis indicates the quantity of the piece supplied.

• Speaker cords

Approx. 6 m (3: for satellite speakers placed in front position and a center speaker)

Approx. 15 m (2: for satellite speakers placed in rear position)



• Screws

 (M5 x 12 mm) (4)

 (M4 x 25 mm) (12)

• Washers

 (4)

If any of the items above are missing, contact your dealer immediately.

Speaker and Speaker cords— to improve the sound quality

About DD (Direct Drive) speaker

DD (Direct Drive) technology improves sound localization and transmits the powerful sounds.

About the OFC cord

The core wires of the supplied speaker cords are made of OFC (Oxygen Free Copper). This OFC cord enables high quality sound reproduction.

When connecting the speaker cords

Make sure to match the polarity (\oplus and \ominus); otherwise, the sound will lose the surround effect.

After connecting, check that the exposed cores are fully inserted into the terminal.

When using other speaker cords

Observe the following;

- Buy thick speaker cords rather than thin cords, and make them as short as possible for connection.
- Use speaker cords of the same length for both left and right speakers.
- Do not use long speaker cords; otherwise, the sound quality may deteriorate.

Contents	Warnings, Cautions and Others	2
	Assembly	4
	Additional information	7
	Specifications	8
Inhalt	Warnungen, Vorsichtshinweise usw.	9
	Zusammenbau	10
	Zusätzliche Informationen	13
	Technische Daten	14
Contenus	Avertissements, précautions et autres	15
	Montage	16
	Informations complémentaires	19
	Spécifications	20
Inhoud	Waarschuwingen en andere aandachtspunten	21
	Monteren	22
	Extra informatie	25
	Specificaties	26
Contenido	Advertencias, precauciones y notas	27
	Montaje	28
	Información adicional	31
	Especificaciones	32
Indice	Avvertenze, Precauzioni e Altro	33
	Collegamenti	34
	Ulteriori informazioni	37
	Dati caratteristici	38
Innehåll	Varningar, försiktighetsåtgärder m.m.	39
	Montering	40
	Ytterligare information	43
	Specifikation	44
Indhold	Advarsler, forsigtighedsregler og andet	45
	Samling	46
	Yderligere oplysninger	49
	Specifikation	50
Sisältö	Varoituksia, huomautuksia ym.	51
	Kokoaminen	52
	Lisätietoja	55
	Tekniset tiedot	56

English

Deutsch

Français

Nederlands

Español

Italiano

Svenska

Dansk

Suomi

Assembly

■ Assembling the satellite speakers

Each speaker (except the center speaker) has been divided into three parts for shipment. Before using this speaker system, assemble it first by following the procedure below.

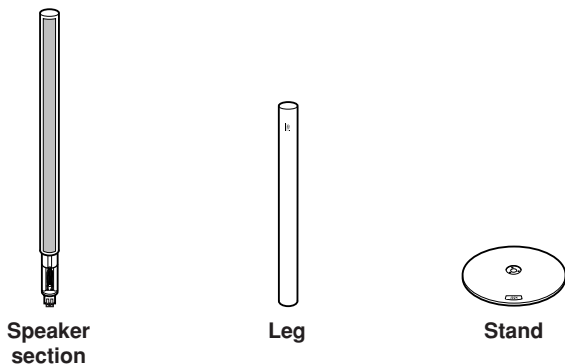

- Prepare a Phillips screw driver.

Before assembling—

- Take care not to drop the stand while assembling; otherwise, it may cause damage to the floor or injury.
- Ensure enough space for assembly and installation.
- Place a large, thick cloth on the floor where you assemble the speaker, so you can protect the floor and the speaker itself.
- Use the speaker only after assembly is fully and correctly done.

Attaching the leg and the stand

1 Remove the terminal cover from the leg.

First remove the screw on the terminal cover, then detach the cover by pulling it upward.

- You will need to use the removed screw in step 5 on page 5.

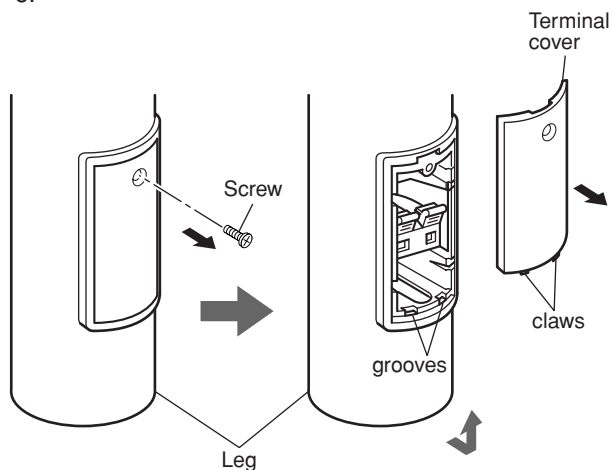

2 Join the leg to the stand.

- Rotate either the leg or stand so that the  mark on the leg and the **JVC** mark on the stand are facing the same direction.
- Make sure to match the screw holes on the leg with those on the stand so that they are aligned correctly.

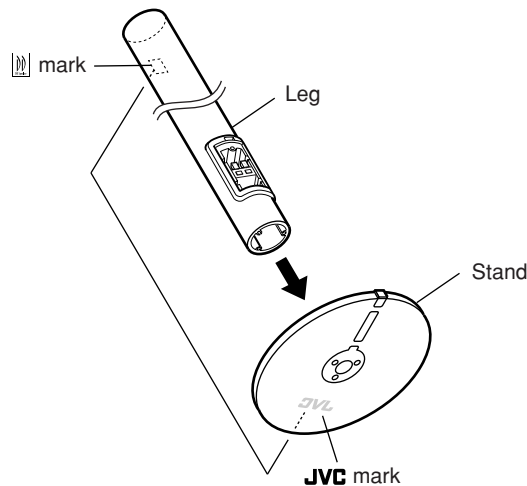

3 Fix the leg to the stand with three of the supplied screws (long: M4 x 25 mm).

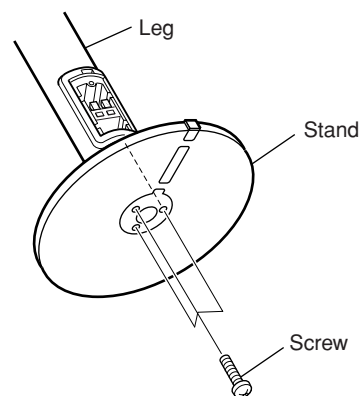

- Do not tighten each screw completely as you put them in place. First put all screws in, then tighten them evenly and firmly.



MEMO

It is recommended to place a cushion under the leg.

- You can tighten the screws easily by placing the leg horizontally.

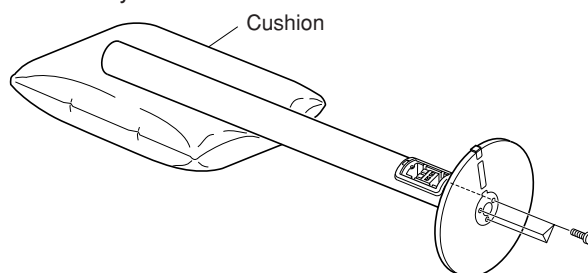

4 Connect the speaker cord to the speaker terminal of the leg

- Use the 6-meter speaker cords for front speakers and 15-meter speaker cord for rear speakers.
- Each speaker cord has its name tag attached to one end. Attach the end without the name tag to the speaker terminal.

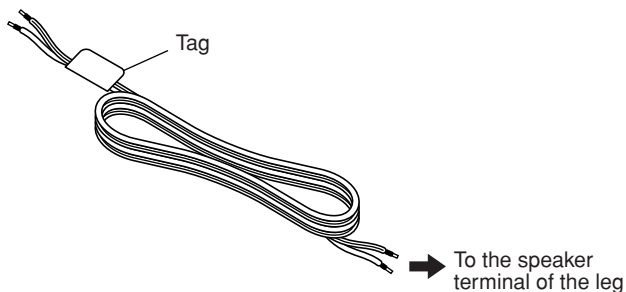

1) Insert the speaker cord inside the stand as illustrated below.

- Pull the speaker cord out of the center of the stand by about 50 cm.

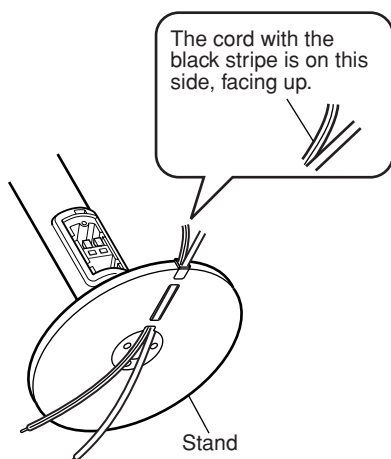

2) Insert the tips of the speaker cord into the leg and pull them out as illustrated below.

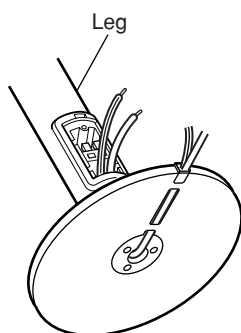

3) Insert the speaker cord into the speaker terminal inside the leg.

- ① Press and hold the clamp.
- ② Insert the exposed core of the speaker cord fully into the terminal.
 - Connect the cord with the black stripe to the \ominus terminal.
- ③ Release your finger.

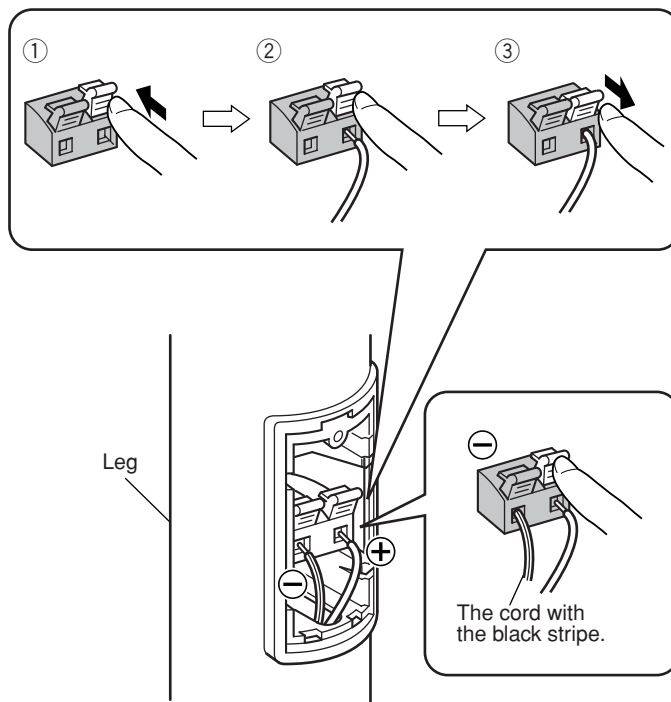

5 Attach the terminal cover to the leg.

Push cords fully inside the leg. Then fix the terminal cover using the screw you removed in step 1.

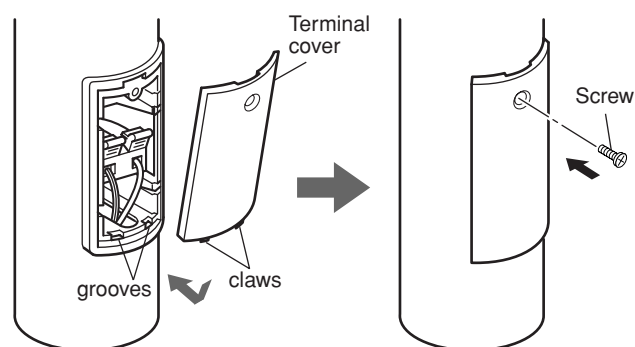

To be continued on the next page

Assembly (continued)

Joining the leg and the speaker unit

6 Insert the speaker cord into the speaker terminal inside the leg.

- 1 Press and hold the clamp.
- 2 Insert the exposed core of the speaker cord fully into the terminal.
 - Connect the cord with black stripe to the \ominus terminal.
- 3 Release your finger.

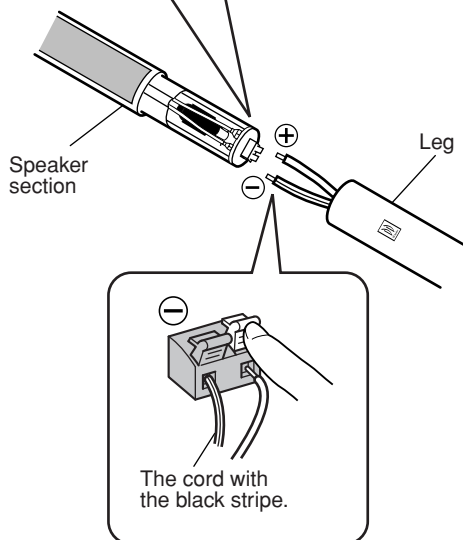
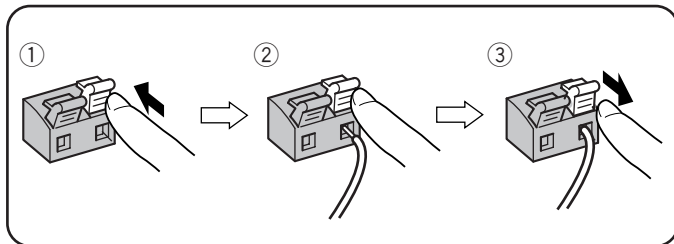

7 Join the speaker section and the leg.

Insert the speaker section to the leg, then fix the speaker section and the leg with one of the washers and one of the supplied screws (short: M5 x 12 mm).

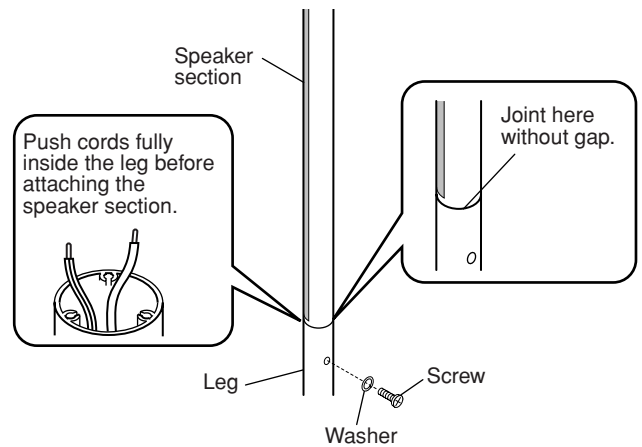

Repeat the procedure from step 1 to assemble the other satellite speakers.

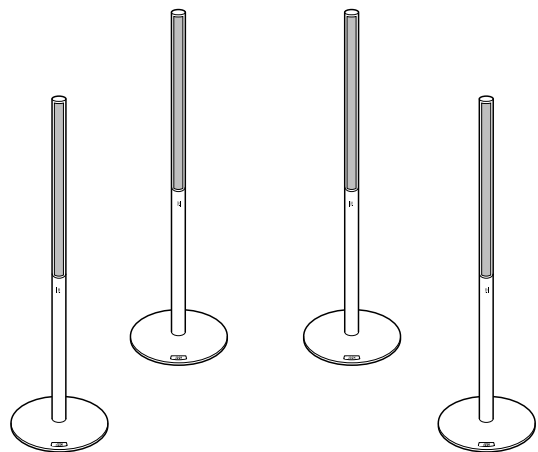

For disassembly:

Reverse Assembly procedure:

- 1) Remove the speaker section from the leg.
- 2) Remove the leg from the stand.

■ Connecting the Center speaker

- To connect the center speaker, use the same type of speaker cord (6 m; tagged with "FRONT SPEAKER") as used for connecting the front speakers.
- Each speaker cord has its name tag attached to one end. Attach the end without the name tag to the speaker terminal.

Insert the speaker cord into the speaker terminal.

- ① Press and hold the clamp.
- ② Insert the exposed core of the speaker cord fully into the terminal.
 - Connect the cord with the black stripe to the \ominus terminal.
- ③ Release your finger.

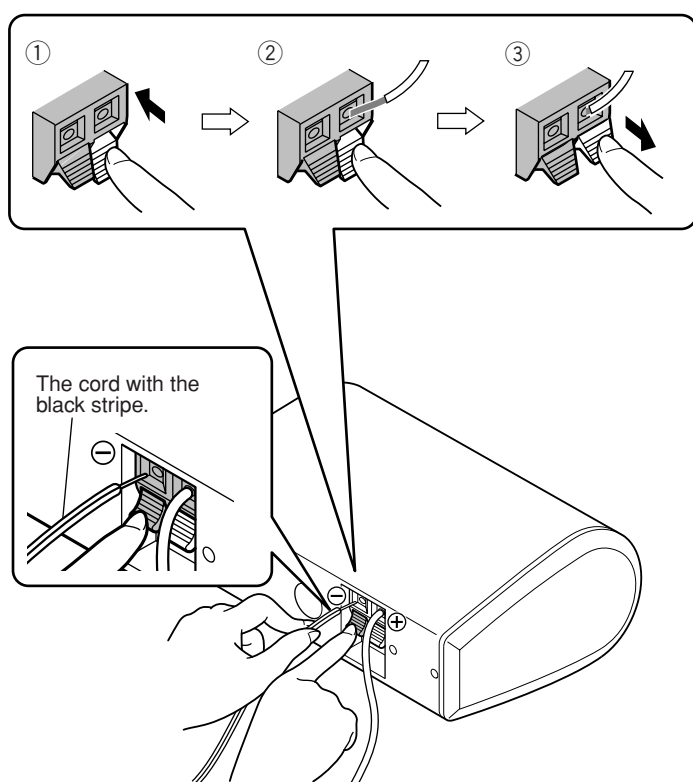

CAUTION

Make sure to match the polarity (\oplus and \ominus); otherwise, the sound will lose the surround effect. After connecting, check that the exposed cores are fully inserted into the terminal.

Additional Information

■ Connecting the speaker system to the amplifier

Before connecting—

- Turn off the power to the amplifier before connecting the speaker system; otherwise, the speakers may be damaged.
- The impedance of each speaker is 8 Ω . Before connecting them to your amplifier, check the speaker impedance range of your amplifier. If the impedance of this speaker is out of the speaker impedance range indicated on the amplifier, you cannot connect this system to the amplifier.
- The maximum power handling capacity of the SX-XD33 is 100 W. Excessive input will result in abnormal noise and possible damage.
- Be sure to turn down the volume level to prevent unwanted noise before performing following operations:
 - Turning on or off other components,
 - Operating the amplifier,
 - Tuning FM stations,
 - Fast-forwarding a tape,
 - Continuously reproducing high frequency oscillation or high pitch electronic sounds.
- When using a microphone, do not aim it at the speakers or use it near the speakers; otherwise, the howling which occurs may damage the speakers.
- Before replacing the cartridge, always turn off the power to the turntable; otherwise, the clicking noise may damage the speakers.

■ Typical connection method to an amplifier

Connect the speakers to a "SPEAKER" terminal of the amplifier with the speaker cords by referring to the diagram below.

- Make sure to match the polarity (\oplus and \ominus) when connecting the speaker cords.
- The diagram below is an example of a typical connection method.

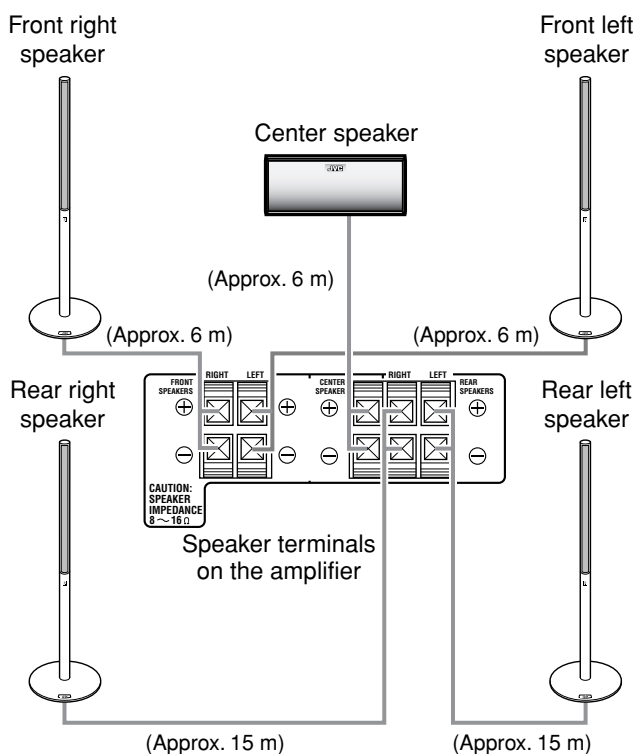

Additional Information (continued)

General layout of speakers

Place all speakers at the same distance from the listening position if possible.

- Usually place the center speaker close to the TV.
- When you place the center speaker on a TV, make sure the surface is level and stable.

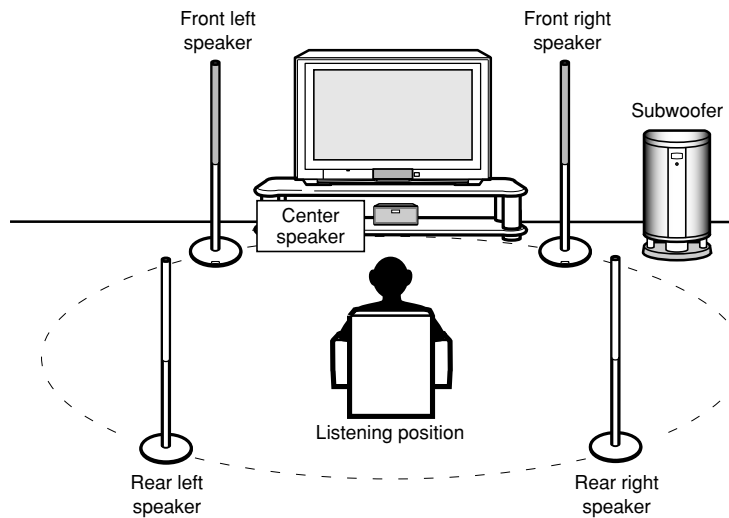

CAUTION

- For a subwoofer to be used with SX-XD33, it is recommended to use SX-DW303. This combination gives you the best possible high quality surround sounds.

Do not lean against the speakers, as the speakers could fall down or break, possibly causing an injury. Especially be careful that children do not lean against them.

Specification

SX-XDS33 (Satellite speaker)

Type :	1-way 2-speaker Bass reflex type, magnetically shielded type
Speaker unit :	Direct drive (9.5 cm × 1 cm) × 2
Frequency range :	120 Hz to 20 000 Hz
Input impedance :	8 Ω
Power handling Capacity :	100 W
Sound pressure level :	82 dB/W·m
Dimensions (approx.) :	282 mm (width) × 1108 mm (height) × 282 mm (depth)
Mass (approx.) :	3.0 kg each

SX-XDC33 (Center speaker)

Type :	1-way 2-speaker Bass reflex type, magnetically shielded type
Speaker unit :	5.5 cm cone × 2
Frequency range :	80 Hz to 20 000 Hz
Input impedance :	8 Ω
Power handling Capacity :	100 W
Sound pressure level :	81 dB/W·m
Dimensions (approx.) :	200 mm (width) × 78 mm (height) × 120 mm (depth)
Mass (approx.) :	0.85 kg

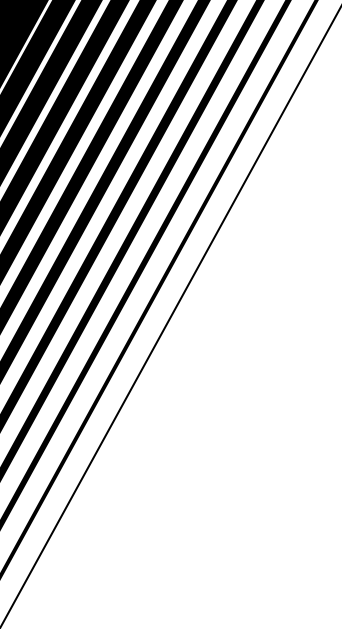

Free Manuals Download Website

<http://myh66.com>

<http://usermanuals.us>

<http://www.somanuals.com>

<http://www.4manuals.cc>

<http://www.manual-lib.com>

<http://www.404manual.com>

<http://www.luxmanual.com>

<http://aubethermostatmanual.com>

Golf course search by state

<http://golfingnear.com>

Email search by domain

<http://emailbydomain.com>

Auto manuals search

<http://auto.somanuals.com>

TV manuals search

<http://tv.somanuals.com>