

JVC



MICRO COMPONENT SYSTEM

UX-G60—Consists of CA-UXG60 and SP-UXG63

UX-G55—Consists of CA-UXG55 and SP-UXG55

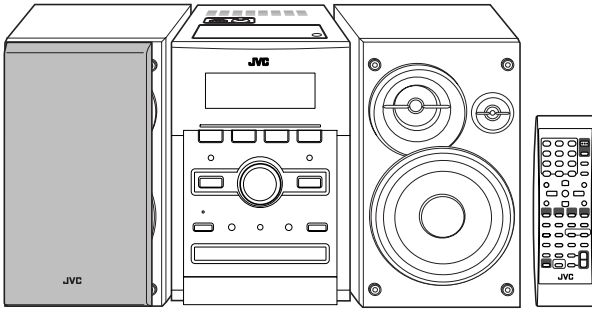

UX-G60

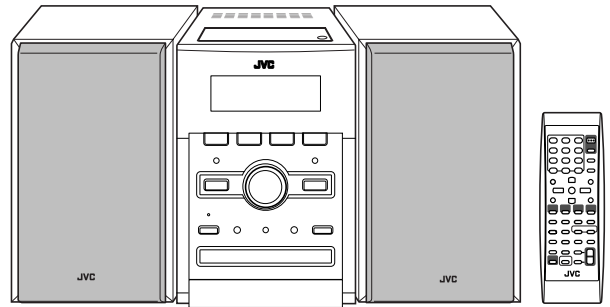

UX-G55



MPEG-4
ASF PLAYBACK

Digital Direct Progressive Scan

INSTRUCTIONS

GVT0169-006A

Download from www.Somanuals.com. All Manuals Search And Download [US, UN, UB, UG, UX, A, UW]

Warnings, Cautions and Others

CAUTION— (Standby/on) button!

Disconnect the mains plug to shut the power off completely (the STANDBY lamp goes off). When installing the apparatus, ensure that the plug is easily accessible. The  (Standby/on) button in any position does not disconnect the mains line.

- When the System is on standby, the STANDBY lamp lights red.
- When the System is turned on, the STANDBY lamp goes off.

The power can be remote controlled.

CAUTION

To reduce the risk of electrical shocks, fire, etc.:

1. Do not remove screws, covers or cabinet.
2. Do not expose this appliance to rain or moisture.

IMPORTANT FOR LASER PRODUCTS

1. CLASS 1 LASER PRODUCT
2. **CAUTION:** Do not open the top cover. There are no user serviceable parts inside the unit; leave all servicing to qualified service personnel.
3. **CAUTION:** Visible and/or invisible class 1M laser radiation when open. Do not view directly with optical instruments.

CAUTION

- Do not block the ventilation openings or holes.
(If the ventilation openings or holes are blocked by a newspaper or cloth, etc., the heat may not be able to get out.)
- Do not place any naked flame sources, such as lighted candles, on the apparatus.
- When discarding batteries, environmental problems must be considered and local rules or laws governing the disposal of these batteries must be followed strictly.
- Do not expose this apparatus to rain, moisture, dripping or splashing and that no objects filled with liquids, such as vases, shall be placed on the apparatus.

Caution: Proper Ventilation

To avoid risk of electric shock and fire, and to prevent damage, locate the apparatus as follows:

1. Front: No obstructions and open spacing.
2. Sides/ Top/ Back: No obstructions should be placed in the areas shown by the dimensions below.
3. Bottom: Place on the level surface. Maintain an adequate air path for ventilation by placing on a stand with a height of 10 cm or more.

Front view

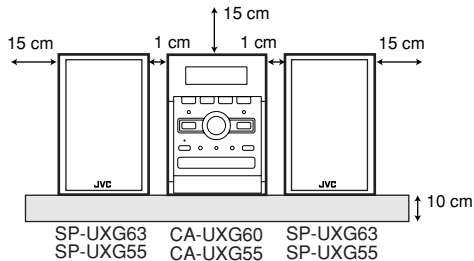

Side view

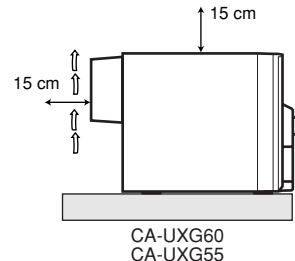

[European Union only]

Introduction

Precautions

Installation

- Install the System in a location with adequate ventilation to prevent internal heat build-up in the System.



DO NOT install the System in a location near heat sources, or in a place subject to direct sunlight, excessive dust or vibration.

- Install in a place which is level, dry and neither too hot nor too cold—between 5°C and 35°C.
- Leave sufficient distance between the System and the TV.
- Keep the speakers away from the TV to avoid interference with the TV.

Power sources

- When unplugging the System from the wall outlet, always pull on the plug, not the AC power cord.



DO NOT handle the AC power cord with wet hands.

Moisture condensation

Moisture may condense on the lenses inside the System in the following cases:

- After starting to heat the room
- In a damp room
- If the System is brought directly from a cold to a warm place.

Should this occur, the System may malfunction. In this case, leave the System turned on for a few hours until the moisture evaporates, unplug the AC power cord, then plug it in again.

Internal heat

- Make sure there is good ventilation around the unit. Poor ventilation could overheat and damage the unit.



DO NOT block the ventilation openings or holes. If they are blocked by a newspaper or cloth, etc., the heat may not be able to get out.

Others

- Should any metallic object or liquid fall into the System, unplug the AC power cord and consult your dealer before operating any further.



DO NOT disassemble the System since there are no user serviceable parts inside.

- If you are not going to operate the System for an extended period of time, unplug the AC power cord from the wall outlet.

If anything goes wrong, unplug the AC power cord and consult your dealer.

Contents

Introduction	1
Playable Disc/File Types	2
How to Read This Manual	2
Connections	3
Display Indicators	6
Daily Operations—Playback	7
Daily Operations—Sound & Other Adjustments	12
Adjusting the Volume	12
Adjusting the Sound.....	12
Creating 3-dimensional Sound Field—3D Phonic.....	13
Presetting Automatic DVD Video Sound	
Increase Level	13
Adjusting the Audio Input Level	13
Changing the Display Brightness.....	14
Changing the Scanning Mode	14
Changing the Picture Tone.....	14
Setting the Clock	15
Turning Off the Power Automatically	15
Unique DVD/VCD Operations	16
Selecting the Audio Track.....	16
Selecting the Subtitle Language.....	17
Selecting the View Angle	17
Selecting the Browsable Still Pictures	17
Playing Back Bonus Group.....	17
Making Dialogues Clear—Clear Voice	18
Special Effect Playback	18
Advanced Playback Operations	19
Programming the Playing Order—Program Play	19
Playing at Random—Random Play	20
Playing Repeatedly	21
Prohibiting Disc Ejection—Child Lock.....	21
On-screen Disc Operations	22
Audio/Video File Operations	26
Advanced Tape Operations	28
Recording on a Tape	28
Synchronized Recording	29
Enjoying Karaoke	30
Singing Along (Karaoke)	30
Microphone Mixing	31
Reserving Karaoke Songs—Karaoke Program Play.....	32
Timer Operations	33
Setup Menu Operations	35
Additional Information	37
Learning More about This System.....	37
Troubleshooting	41
Operating JVC's TVs Using the Remote Control.....	43
Specifications	44
Parts Index	45

Playable Disc/File Types

<ul style="list-style-type: none"> • CD-R/-RW: Recorded in the Audio CD, Video CD, and SVCD formats. MP3, WMA*, JPEG, MPEG-1, MPEG-2, ASF* and DivX files written in accordance with the "ISO 9660" format can also be played. • DVD-R/-RW, +R/+RW: Recorded in the DVD Video format. MP3, WMA*, JPEG, MPEG-1, MPEG-2, ASF* and DivX files written in the UDF format can also be played. • DVD-RW/-ROM: Recorded in the DVD Video Recording (VR) format. • USB mass storage class device*: MP3, WMA, JPEG, MPEG-1, MPEG-2, ASF and DivX files.

In addition to the above discs/files, this System can playback audio data recorded on CD-Extra.

- The following discs cannot be played back: DVD-RAM, CD-I (CD-I Ready), CD-ROM, Photo CD, CD-G (CD-Graphics) and DVD/CD Text. Playing back these discs will generate noise and damage the speakers.
- In this manual, "file" and "track" are interchangeably used for MP3/WMA*/JPEG/MPEG-1/MPEG-2/ASF*/DivX operations.
- It is possible to playback finalized +R/+RW (DVD format only) discs. "DVD" lights on the front display panel when a +R/+RW disc is loaded.
- For UX-G55, the unit cannot playback DVD-VR discs with CPRM (Content Protection for Recordable Media).

About color system

This System accommodates the NTSC and PAL system and can playback discs recorded in either the NTSC or the PAL system.

- To change the color system, see page 14.

Note on Region Code

DVD players and DVDs have their own Region Code numbers. This System can playback only DVDs with an appropriate Region Code number.

- For details, see "Specifications" on page 44.

EX.:



(For Central and South American countries and Australia)

Audio formats

The System can playback the following digital audio formats.

- LPCM (Linear PCM)*, DIGITAL (Dolby Digital), DTS (Digital Theater Systems), MLP (Meridian Lossless Packing)*

When playing a multi-channel encoded DVDs, the System properly converts these multi-channel signals into 2 channels, and emits the downmixed sound from the speakers.

- To enjoy the powerful sound of these multi-channel encoded DVDs, connect a proper decoder or an amplifier with a proper built-in decoder to the OPTICAL DIGITAL OUT terminal on the rear.

IMPORTANT: Before playing a disc, make sure of the following...

- Turn on the TV and select an appropriate input mode on the TV to view the pictures or on-screen displays.
- For disc playback, you can change the initial setting to your preference. See "Setup Menu Operations" on page 35.

If "⊗" appears on the TV screen when you press a button, the disc cannot perform the operation you have tried to do.

How to Read This Manual

- Button and control operations are explained in the table below.
- Some related tips and notes are explained later in the sections "Learning More about This System" and "Troubleshooting," but not in the same section explaining the operations (indicates that the content has some information).

	Indicates that you press the button briefly .
	Indicates that you press the button briefly and repeatedly until an option you want is selected.
	Indicates that you press one of the buttons.
	Indicates that you press and hold the button for a specified period.
	Indicates that you turn the control toward the specified direction(s).
	Indicates that this operation is only possible using the remote control.
	Indicates that this operation is only possible using the main unit.

"DVD Logo" is a trademark of DVD Format/Logo Licensing Corporation registered in the US, Japan and other countries.

Caution for DualDisc playback

The Non-DVD side of a "DualDisc" does not comply with the "Compact Disc Digital Audio" standard. Therefore, the use of the Non-DVD side of a DualDisc in this product is not recommended.

* For UX-G60 only

Connections INFO

Do not connect the AC power cord until all other connections have been made.

- Connect VIDEO OUT directly to the video input of your TV. Connecting VIDEO OUT to a TV via a VCR may interfere with your viewing when playing back a copy-protected disc. Connecting VIDEO OUT to an integrated TV/VCR system may also interfere with your viewing.

Rear panel

The illustration below is UX-G60.

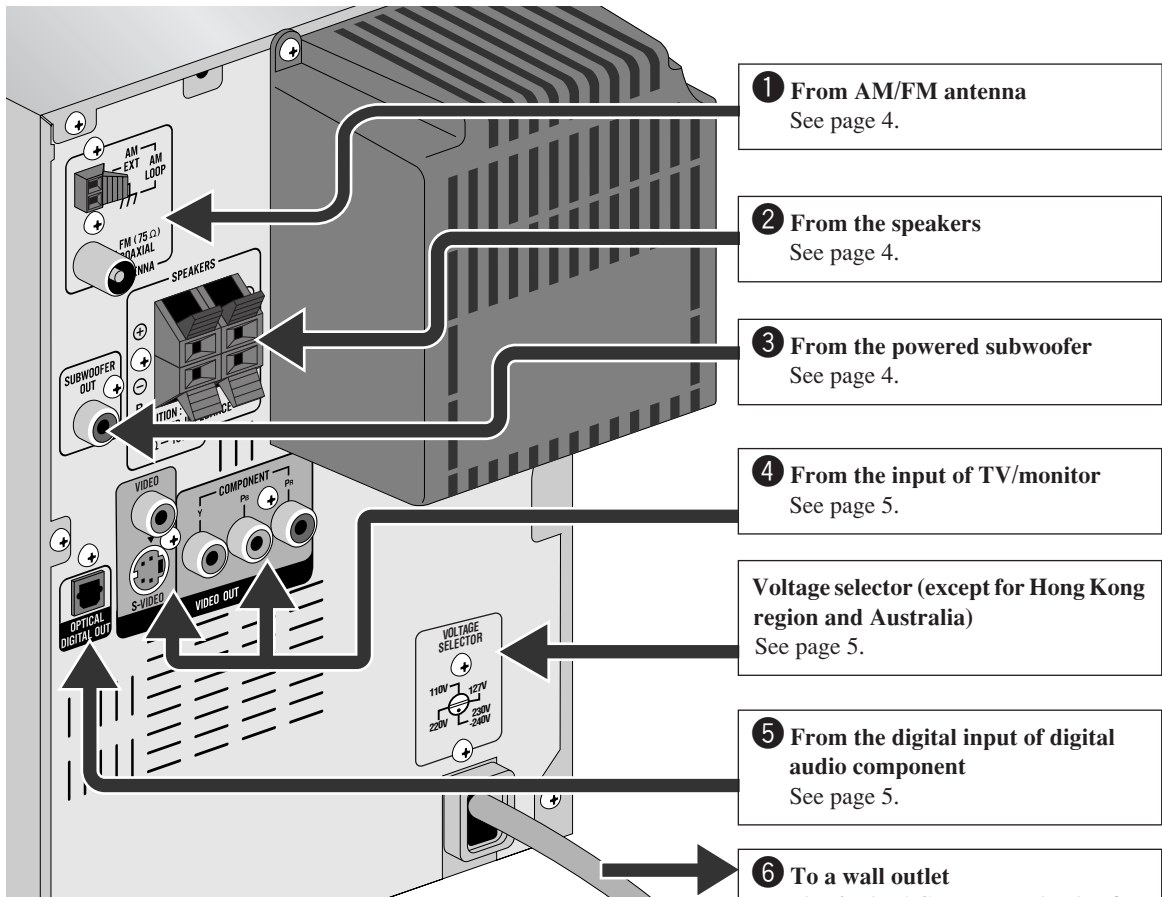

Front panel

The illustration below is UX-G60.

Pull down the cover until you hear a clicking sound.

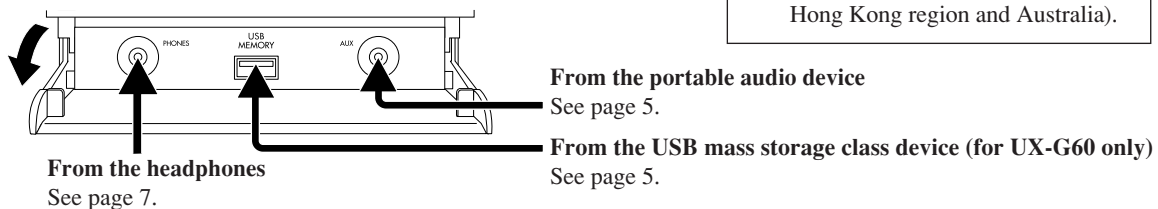

1 AM/FM antenna

To assemble the AM loop antenna

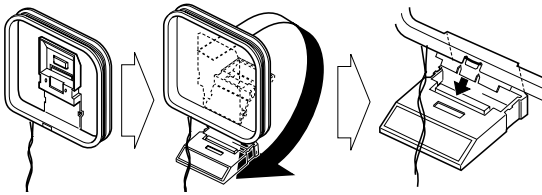

To connect AM/FM antenna

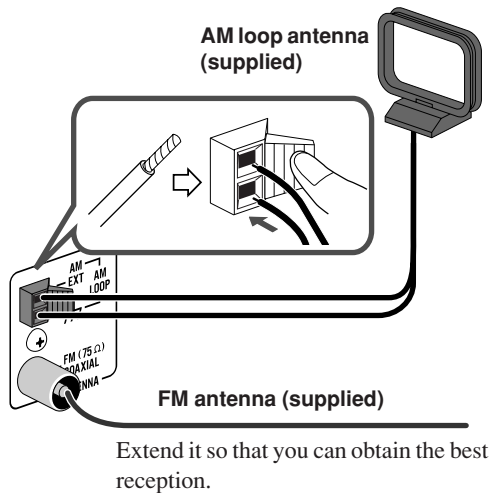

For better AM/FM reception

AM loop antenna (supplied)
Keep it connected.

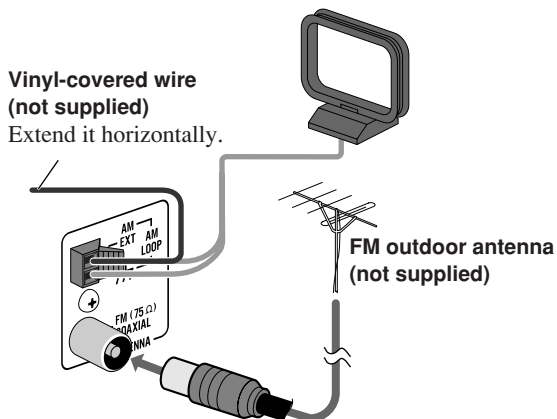

- Disconnect the supplied FM antenna, and connect to an outdoor FM antenna using a 75 Ω wire with coaxial type connector (IEC or DIN45325).

2 Speakers

- When connecting the speaker cords, match the polarity of the speaker terminals: red color to (+) and black color to (-).

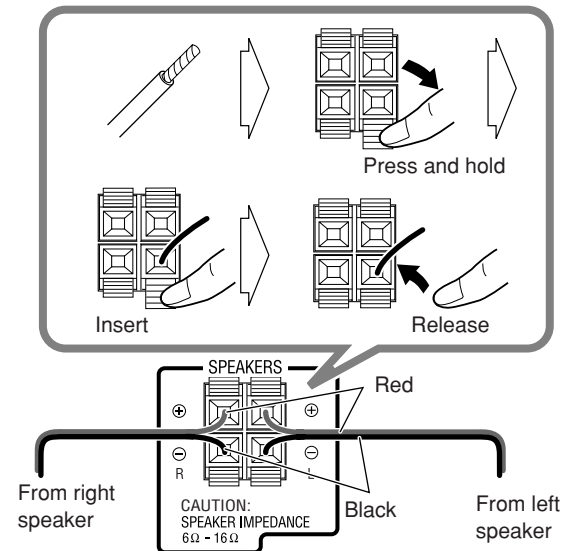

- DO NOT connect more than one speaker to each terminal.
- DO NOT push or pull the speakers as this will damage the foot spacers at the bottom of the speakers.

3 To connect the powered subwoofer

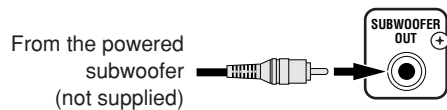

The subwoofer connected can reproduce the bass sounds recorded in front left and right channels, but cannot reproduce the LFE signals in DVD multi-channel discs.

- Before plugging the unit to the main supply, make sure that the powered subwoofer is turned off.

4 TV/monitor

Connect the COMPONENT (for UX-G60 only), S-VIDEO, or VIDEO jacks which you want to use.

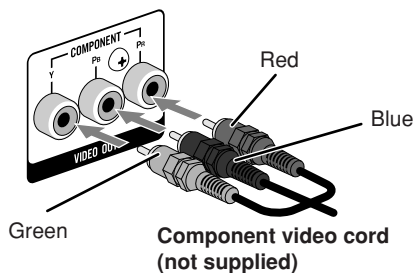

- To select progressive scanning mode (see page 14), use COMPONENT jacks.

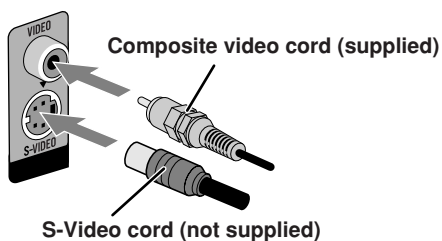

- After connecting a TV, select the proper video signal mode according to the connection method. See "Changing the Scanning Mode" on page 14.

5 Digital audio component

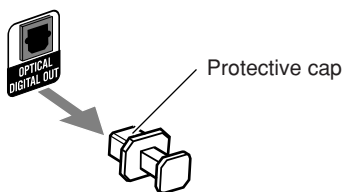

- Set "DIGITAL AUDIO OUTPUT" in the "AUDIO" menu correctly according to the connected digital audio equipment (see page 36). If the setting is incorrect, loud noise may be generated causing damage to the speakers.

When connecting a portable audio device (AUX)

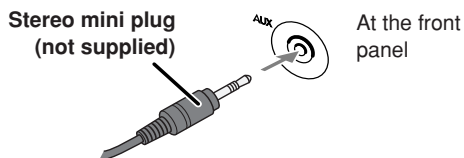

- By using QP Link (Quick Portable Link), you can easily start playing back a portable audio device on this unit. See page 11 for details.

- If an external device is not equipped with a stereo mini plug audio output, use a plug adaptor to convert the stereo mini plug to the corresponding plug of the audio output.

When connecting a USB mass storage class device (for UX-G60 only)

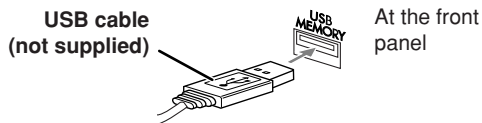

- You can connect a USB mass storage class device such as a USB flash memory device, hard disk drive, multimedia card reader, etc. to this System. See pages 10 and 38 for details.
- If you press USB MEMORY ►, the System detects the USB mass storage class device and the control screen appears on the TV screen. See page 26 for details.

Before plugging in the System (except for Hong Kong region and Australia)

Set the correct voltage for your area with the voltage selector on the rear.

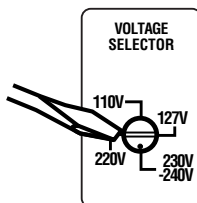

Use a screwdriver to set the voltage selector to the same voltage as where you are plugging in the unit. (See also the back cover page.)

Preparing the remote control

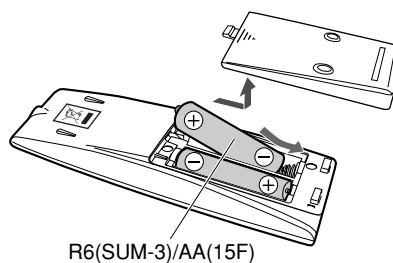

- Dispose of batteries in the proper manner, according to federal, state, and local regulations.



DO NOT recharge, short, disassemble, heat the battery or dispose of it in a fire.

When using the remote control

Point the top of the remote control toward the remote sensor as directly as possible. If you operate it from a diagonal position, the operating range (approx. 5 m) may be shorter.

Display Indicators

The indications on the display tell you a lot of things while you are operating the System. Before operating the System, be familiar with when and how the indicator illuminates on the display.

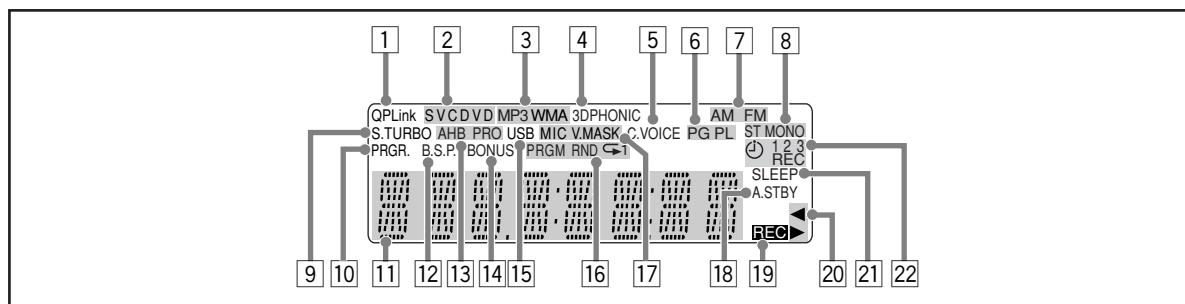

- 1 QP Link (Quick Portable Link) indicator
 - Lights when QP Link is activated.
- 2 Disc format indicators
 - SVCD: lights when playing back an SVCD.
 - VCD: lights when playing back a VCD.
 - CD: lights when playing back a CD.
 - DVD: lights when playing back a DVD.
- 3 Audio file format indicators
 - MP3: lights when an MP3 track is detected.
 - WMA*: lights when a WMA track is detected.
- 4 3D PHONIC indicator
 - Lights when 3D Phonic is activated.
- 5 C.VOICE (Clear Voice) indicator
 - Lights when Clear Voice is activated.
- 6 PG/PL indicators
 - PG: lights when a DVD-VR formatted disc is called up.
 - PL: lights when a Play List recorded on a DVD-VR formatted disc is called up.
- 7 Radio band indicators
 - AM: lights when tuning in to an AM station.
 - FM: lights when tuning in to an FM station.
- 8 FM reception indicators
 - ST (stereo): lights while an FM stereo station with sufficient signal strength is tuned in.
 - MONO: lights while receiving an FM stereo station in monaural.
- 9 S.TURBO (Sound Turbo) indicator
 - Lights when Sound Turbo II is activated.
- 10 PRGR. (Progressive) indicator*
 - Lights when the progressive scanning mode is selected.
- 11 Main display
 - While listening to radio: band (or preset number) and station frequency appear.
 - While selecting "AUX": "AUX" appears.
 - While playing a disc or file: current status appears.
 - While selecting "TAPE": "TAPE" appears.
- 12 B.S.P. (Browsable Still Picture) indicator*
 - Lights when Browsable Still Pictures are detected while playing a DVD Audio disc.
- 13 AHB PRO indicator
 - Lights when Active Hyper Bass Pro is activated.
- 14 BONUS indicator*
 - Lights when a DVD Audio disc with a bonus group is detected.
- 15 USB indicator*
 - Lights when "USB MEMORY" is selected as the source.
- 16 Playback mode indicators
 - PRGM: lights when Program Play is activated.
 - RND: lights when Random Play is activated.
 - (repeat)1:
 - (repeat)1: lights when One Track/Chapter/Step Repeat is activated.
 - (repeat)1: lights when One Group/Title/All Tracks Repeat is activated.
- 17 Indicators for Karaoke function*
 - MIC: lights when the microphone is connected.
 - V.MASK (Voice Mask): lights when Voice Mask is activated.
- 18 A.STBY (Auto Standby) indicator
 - Lights when Auto Standby is activated.
 - Flashes when disc playback stops with Auto Standby activated.
- 19 REC indicator
 - Lights while recording.
- 20 (tape direction) indicators
 - Lights to indicate the current tape running direction.
 - Flashes slowly during playback and recording.
 - Flashes quickly while rewinding a tape.
- 21 SLEEP indicator
 - Lights when the Sleep Timer is activated.
- 22 Daily Timer indicators
 - (clock icon): lights when Daily Timer is on standby or is being set.
 - 1/2/3: lights when a Daily Timer (1, 2, or 3) is on standby; flashes while working or being set.
 - REC: lights when the Recording Timer stands by; flashes while working or being set.

* For UX-G60 only

Daily Operations—Playback

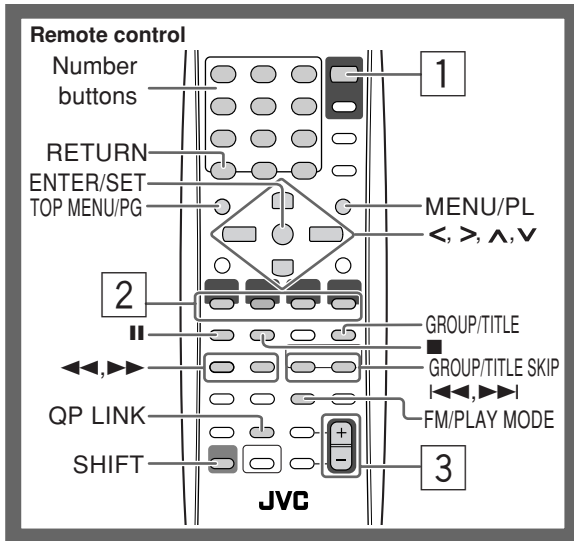

In this manual, operations using the remote control are mainly explained; however, you can use the buttons and controls on the main unit if they have the same (or similar) name and marks.

1 Turn on the power.

The STANDBY lamp on the main unit turns off.

- Without pressing **⏻/I AUDIO**, the System turns on by pressing one of the source buttons.
- The System turns on and activates the AUX source by starting playback on an external device when QP Link is activated. (See page 11 for details.)

2 Select the source.

Playback automatically starts if the selected source is ready.

- If you press **AUX**, start playback on the external component.

3 Adjust the volume.

4 Operate the target source as explained later.

To turn off (standby) the unit



The STANDBY lamp on the main unit lights in red.

- A small amount of power is always consumed even while on standby.

You can reduce power consumption by pressing **DIMMER** (while holding **SHIFT**) to turn the display off while on standby.

- When the display is turned off, QP Link does not work.

For private listening

Connect a pair of headphones to the PHONES jack on the main unit. The sound will no longer come out of the speakers. **Be sure to turn down the volume before connecting or putting on the headphones.**

- Disconnecting the headphones will activate the speakers again.



DO NOT turn off (standby) the System with the volume set to an extremely high level; otherwise, the sudden blast of sound may damage your hearing, speakers and/or headphones when you turn on the System or start playback.

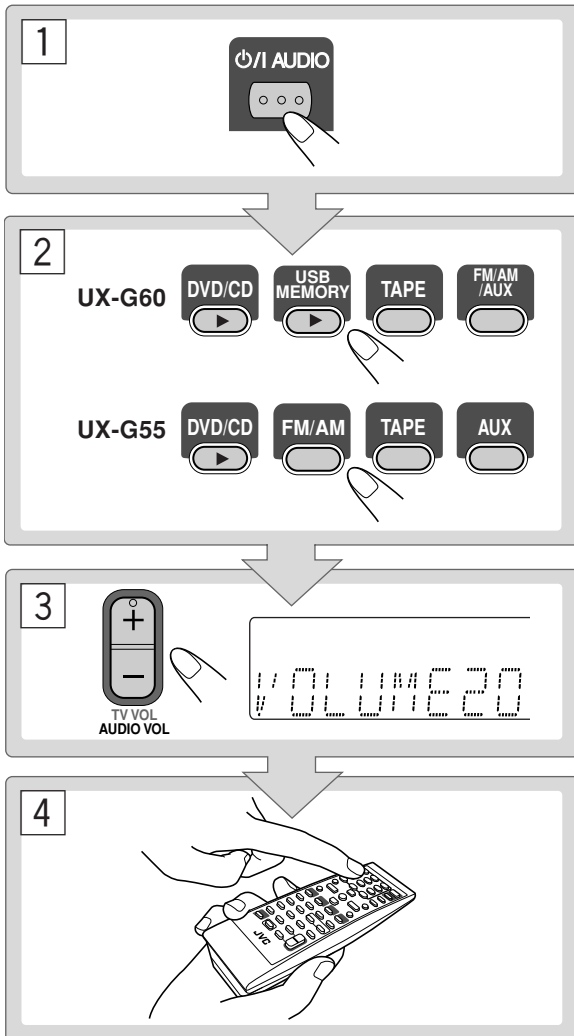

Listening to the Radio INFO

To set the AM tuner interval spacing



Before operating the tuner, it is required to select the appropriate AM space interval used for your area.
 • This is possible only while the System is on standby.

1 Select the AM band.

UX-G60

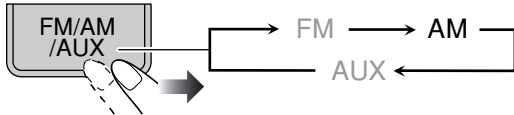

UX-G55

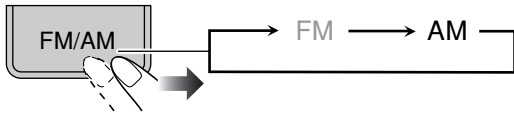

2 Turn off the power.



3 Select the appropriate AM space interval for your area.

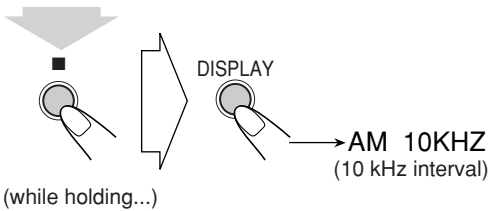
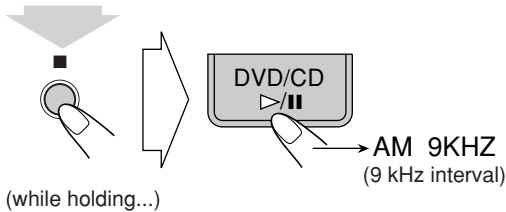

To select the band (FM or AM) UX-G60

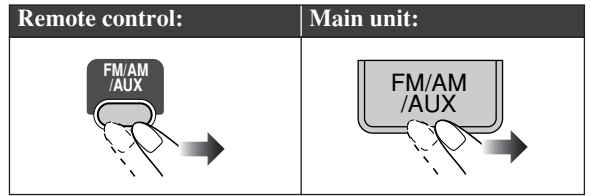

UX-G55

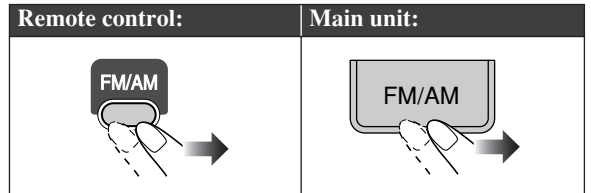

To tune in to a station

While FM or AM is selected...

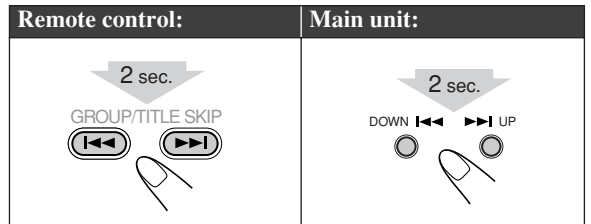

Frequency starts changing on the display.

When a station (frequency) with sufficient signal strength is tuned in, the frequency stops changing.

- When you repeatedly press the button, the frequency changes step by step.

To stop searching manually, press either button.

If the FM station has poor reception



The MONO indicator lights on the display. Reception will improve though stereo effect is lost—Monaural reception.

To restore the stereo effect, press the button again (the MONO indicator disappears).

To preset the stations



You can preset 30 FM and 15 AM stations.

1 Tune in to a station you want to preset.

- You can also store the monaural reception mode for FM preset stations if selected.

2 Activate the preset number entry mode.

ENTER/SET

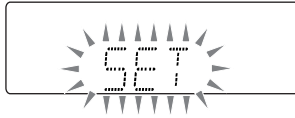

- Finish the following process while the indication on the display is flashing.

3 Select a preset number for the station you store.

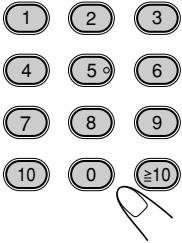

Examples:

To select preset number 5, press 5.

To select preset number 10, press 10.

To select preset number 15, press ≥ 10 , 1, then 5.

To select preset number 30, press ≥ 10 , 3, then 0.

- You can also use the \gg or \ll button.

4 Store the station.

ENTER/SET



To tune in to a preset station



1 Select the band (FM or AM).

UX-G60

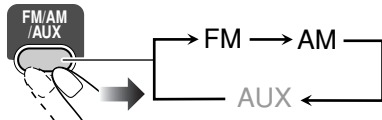

UX-G55

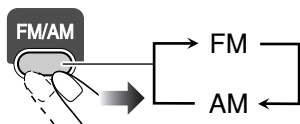

2 Select the preset number for the station you stored.

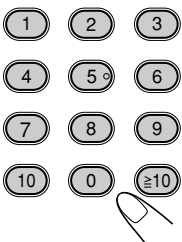

Examples:

To select preset number 5, press 5.

To select preset number 10, press 10.

To select preset number 15, press ≥ 10 , 1, then 5.

To select preset number 30, press ≥ 10 , 3, then 0.

- You can also use the \gg or \ll button.

Playing Back a Tape

To insert a tape

You can playback type I tapes.

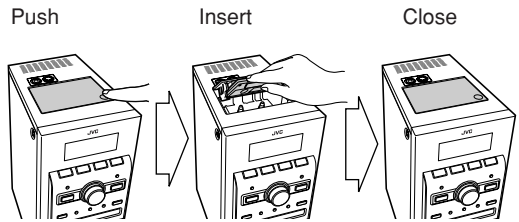

With the tape side facing outside

The illustration above is UX-G60.

To start:	To stop:
<p>When "TAPE" is not selected as the current source, press twice.</p>	
To rewind/fast-forward the tape:	
Remote control:	
<p>Fast-forward the tape.</p>	<p>Rewind the tape.</p>
Main unit:	
<p>Rewind the tape.</p>	<p>Fast-forward the tape.</p>

Playing Back a Disc/File INFO

Before operating a disc/file, be familiar how a disc/file is recorded.

- DVD Video comprises of “Titles” which includes “Chapters,” DVD Audio*/MP3/WMA*/MPEG-1/MPEG-2/ASF*/DivX comprises of “Groups” which includes “Tracks,” JPEG comprises of “Groups” which includes “Files,” and CD/SVCD/VCD comprises of only “Tracks.”
- For playback of MP3/WMA*/JPEG/MPEG-1/MPEG-2/ASF*/DivX files in a USB mass storage class device*, see also page 26.

To insert a disc

You can insert a disc while playing another source.

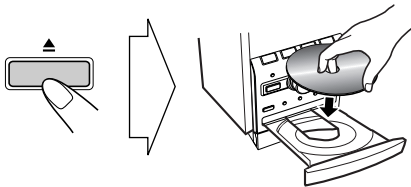

- When using an 8 cm disc, place it on the inner circle of the disc tray.

To close the disc tray, press ▲ again.

- If you press DVD/CD ►, disc tray closes automatically and playback starts (depending on how the disc is programmed internally).

To connect a USB mass storage class device

This section applies only to UX-G60.

You can connect a USB mass storage class device (see page 5) while playing another source.

- If you press USB MEMORY ►, the System detects the USB mass storage class device, the control screen appears on the TV screen, and playback starts.
- To disconnect the USB mass storage class device safely, disconnect the device after turning the System off.

To playback a disc/file

To start:	To pause:	To stop:
<div style="display: flex; justify-content: space-around;"> <div style="text-align: center;"> <p>DVD/CD</p> </div> <div style="text-align: center;"> <p>USB</p> <p>USB MEMORY*</p> </div> </div>	<p>To release, press DVD/CD ► or USB MEMORY ►*.</p>	

- **While playing a disc/file:** This System can store the stop point, and when you start playback again by pressing DVD/CD ► or USB MEMORY ►* (even while on standby), it starts from the position where you have stopped—Resume Play. (“RESUME” appears on the display when you stop playback.)

To stop completely while Resume is activated, press ■ twice. (To cancel Resume, see “RESUME” on page 36.)

- When operating the System, the on-screen guide icon (see the following table) appears on the TV.

On-screen guide icons

- During DVD Video playback, the following icons may appear on the TV:

At the beginning of a scene containing multi-angle views.

At the beginning of a scene containing multi-audio sounds.

At the beginning of a scene containing multi-subtitles.

- The following icons will be also shown on the TV to indicate your current operation.



- To deactivate the on-screen guide icons, see “ON SCREEN GUIDE” in “OTHERS” menu on page 36.

To select a title/group

While playing a disc/file...

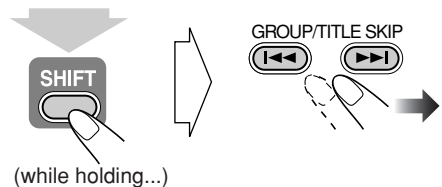

- You can select a title/group directly by pressing a number button after pressing GROUP/TITLE (except for DVD-VR disc).

- Group name appears for MP3 or WMA* playback.

To select a chapter/track

- For VCD/SVCD, cancel PBC (see next page).

While playing a disc/file...



- First time you press ◀◀, you will go back to the beginning of the current chapter/track.

To locate a particular portion

While playing a disc/file...



- Search speed changes as illustrated above except for MP3/WMA*/DivX discs/files. For MP3/WMA*/DivX discs/files, search speed and the indications on the TV are different.

- No sound comes out if searching is carried out while showing the moving picture.

To return to normal playback, press DVD/CD ► or USB MEMORY ►* (depending on the source type).

* For UX-G60 only

- For DivX, each time you press the > or < button, you can skip to a scene for 30 seconds or 5 minutes depending on the DivX file.

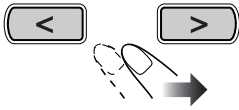

To locate an item directly



You can select a title/chapter/track directly and start playback.

- For DVD Video, you can select a **title before starting playback**, while you can select a **chapter after starting playback**.

Examples:

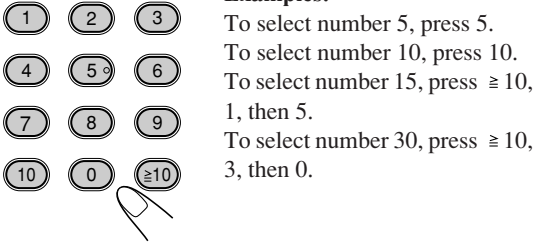

To playback using the disc menu



■ For DVD Video/DVD Audio*:

1 Show the disc menu.

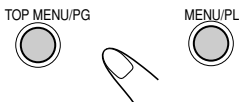

2 Select an item on the disc menu.

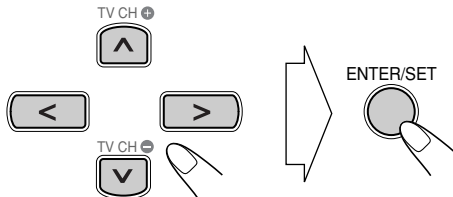

- With some discs, you can also select items by entering the number using the number buttons.

■ For SVCD/VCD with PBC:

While playing a disc with PBC, "PBC" appears on the display.

When disc menu appears on the TV, select an item on the menu. Playback of the selected item starts.

Examples:

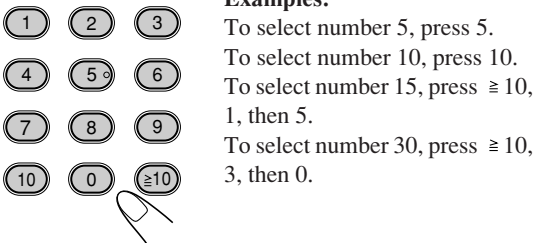

To move to the next or previous page of the current menu:

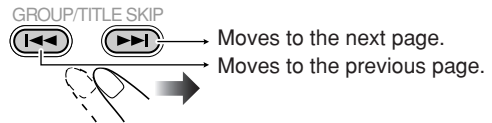

To return to the previous menu:

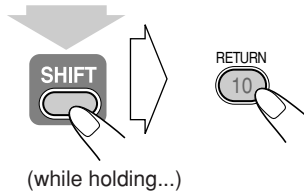

To cancel PBC, press ■, then select a track. Playback starts with the selected track.

To reactivate PBC, press ■ (twice if Resume is turned "ON"), then press DVD/CD ►.

Playing Back a

Portable Audio Device



INFO

By using QP Link (Quick Portable Link), you can easily start playing back a portable audio device connected to the AUX jack.

- Make sure to set the volume of your portable audio device loud enough so that the System can detect the sound signal.

To activate QP Link

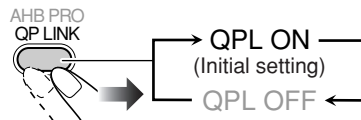

When QP Link is activated, connecting a portable device to the AUX jack and starting playback performs the following:

- While listening to another source...
 Changes the source to AUX automatically. (If you change from AUX to another source, QP Link will be canceled.)
- While the System is on standby...
 Turns on the System and activates the AUX source automatically (except when the display is turned off).

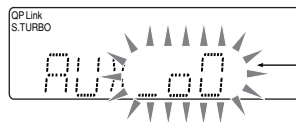

Bubbles appear when QP Link works.

While QP Link plays back the device...

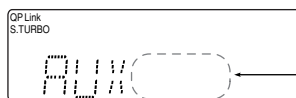

Bubbles disappear when the sound signal stops or is too weak.

* For UX-G60 only

Daily Operations—Sound & Other Adjustments

Remote control

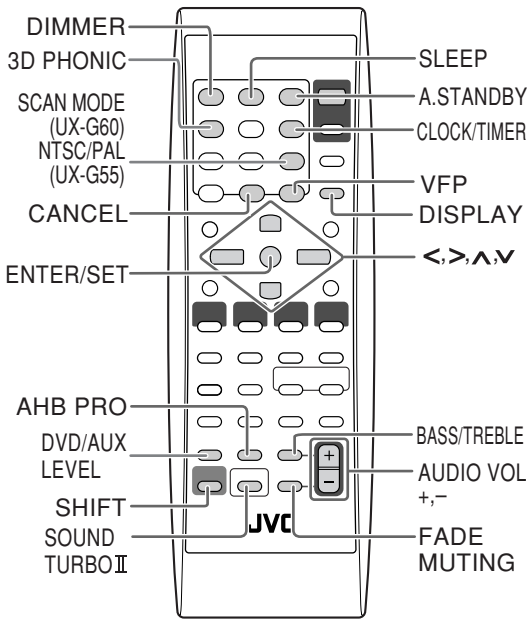

Main unit

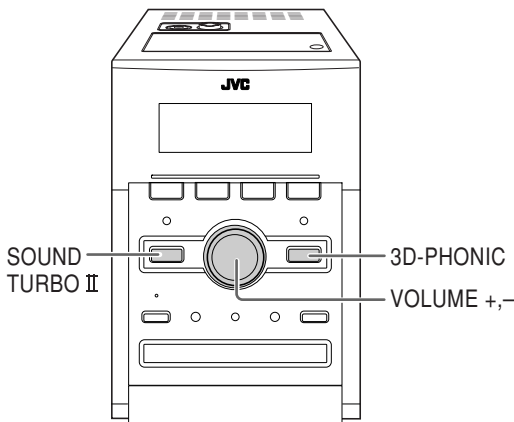

The illustration above is UX-G60.

Adjusting the Volume

You can adjust the volume level from VOL MIN to level 40 (VOL MAX).

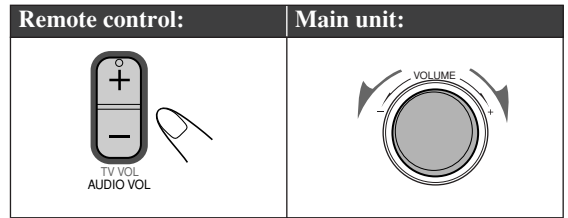

To drop the volume in a moment



To restore the volume, press again, or adjust the volume level.

Adjusting the Sound

INFO

To reinforce the heavy sound

This boosts the low and high frequency sound—Sound Turbo II.

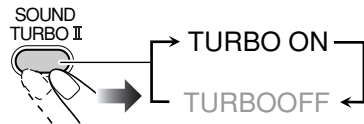

- When Sound Turbo II is turned on, AHB Pro is automatically turned on, and cannot be turned off. (AHB PRO indicator does not light even though the function is turned on.)

To reinforce the bass sound



While Sound Turbo II is off, the richness and fullness of the bass sound is clearly maintained regardless of how you set the volume—Active Hyper Bass Pro.

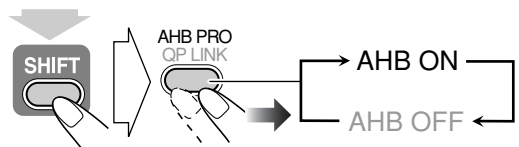

(while holding...)

- When Sound Turbo II is turned on, AHB Pro setting cannot be changed.

To adjust the tone



You can adjust the bass and treble level from -3 to +3.

To adjust the bass



To adjust the treble



Creating 3-dimensional Sound Field

—3D Phonic

- This does not function for MPEG-1/MPEG-2/ASF*/DivX discs.

While playing a disc...

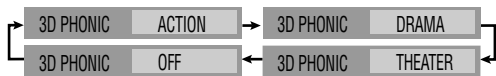
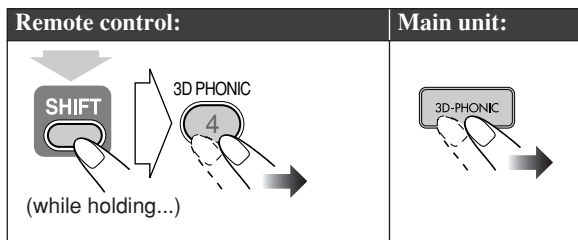

ACTION	Suitable for action movies and sports programs.
DRAMA	Creates natural and warm sound. Enjoy movies in a relaxed mood.
THEATER	Enjoy sound effects like in a major theater.

Presetting Automatic DVD Video Sound

Increase Level



DVD Video sound is sometimes recorded at a lower level than other discs and sources. You can set the increase level for the currently loaded DVD Video, so you do not have to adjust the volume when you change the source.

- This only functions for DVD Video and DVD-VR format disc.

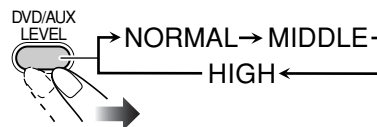

NORMAL	Original recording level.
MIDDLE	Output level is increased (less than "HIGH").
HIGH	Output level is increased (more than "MIDDLE"). (initial setting)

Adjusting the Audio Input Level



If the sound from the component connected to the AUX jack is too loud or is too quiet when changing from another source to "AUX," you can change the audio input level through the AUX jack (without changing the volume level).

While the "AUX" is selected as a source...

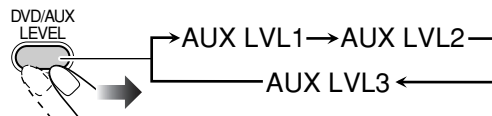

AUX LVL1	Select this when the sound is too loud with "AUX LVL2" selected. This setting is recommended for listening and recording when connecting an audio device other than a portable audio device to the AUX jack.
AUX LVL2	Select this when the sound is too loud with "AUX LVL3" selected.
AUX LVL3	Select this when listening to a portable audio device or recording the sound from it (initial setting).

* For UX-G60 only

Changing the Display Brightness

You can dim the display window.

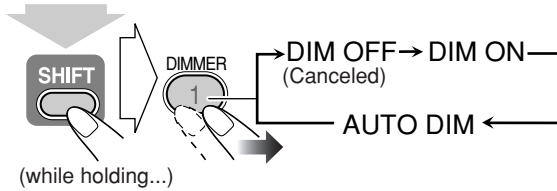

DIM ON	Dims the display.
AUTO DIM*1	Removes the display illumination when starting playback a disc with a video source. <ul style="list-style-type: none"> The display illuminates when playback stops.

*1 "AUTO DIM" does not work for CD/MP3/WMA*2.

Changing the Scanning Mode

Select the color system and the video signal mode according to the type of your TV. If you connect a progressive TV to UX-G60 through the COMPONENT jacks, you can enjoy a high quality picture from the built-in DVD player by selecting "PAL PRG" or "NTSC PRG."

UX-G60

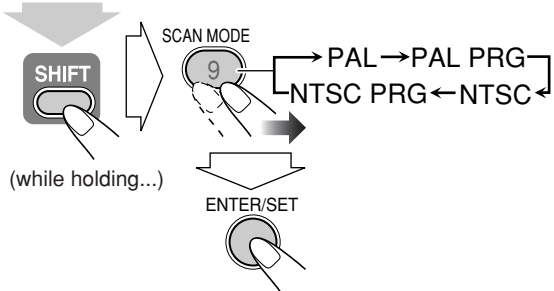

UX-G55

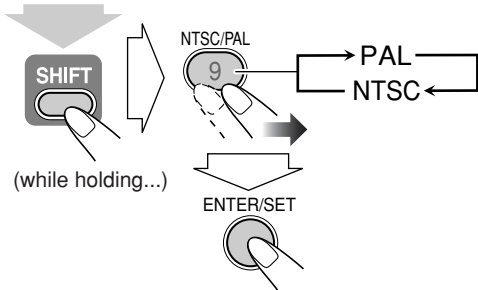

PAL	Select for a conventional PAL TV.
PAL PRG*2	Select for a progressive PAL TV. Select to enjoy a progressive scanned picture with a progressive PAL TV.
NTSC	Select for a conventional NTSC TV.
NTSC PRG*2	Select for a progressive NTSC TV. Select to enjoy a progressive scanned picture with a progressive NTSC TV.

Changing the Picture Tone

While showing a playback picture on the TV, you can select a preset picture tone, or adjust it and store your own taste.

To select a preset picture tone

1 While playing, display VFP setting screen.

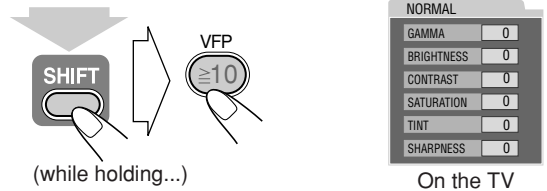

2 Select a preset picture tone.

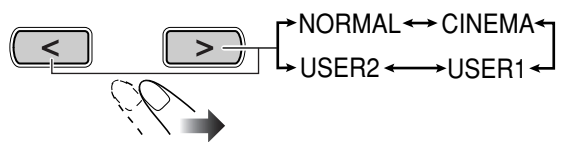

NORMAL	Normally select this.
CINEMA	Suitable for a movie source.
USER1/USER2	You can adjust parameters and can store the settings.

To remove the screen, press VFP again while holding SHIFT.

To adjust the picture tone

1 Select "USER1" or "USER2."

• Follow steps 1 and 2 explained above.

2 Select a parameter you want to adjust.

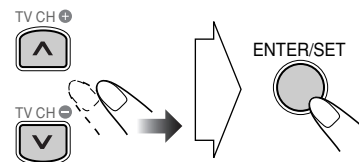

GAMMA	Adjust if the neutral color is bright or dark (-3 to +3).
BRIGHTNESS	Adjust if the entire picture is bright or dark (-8 to +8).
CONTRAST	Adjust if the far and near positions are unnatural (-7 to +7).
SATURATION	Adjust if the picture is whitish or blackish (-7 to +7).
TINT	Adjust if the human skin color is unnatural (-7 to +7).
SHARPNESS	Adjust if the picture is indistinct (-8 to +8).

*2 For UX-G60 only

3 Adjust the parameter.

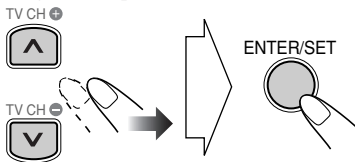

4 Repeat steps 2 to 3 to adjust other parameters.

To erase the screen, press VFP again while holding SHIFT.

Setting the Clock



Without setting the built-in clock, you cannot use Daily Timers (see page 33) and Sleep Timer.

- To correct a mis-entry during the process, press CANCEL (while holding SHIFT) or CLOCK/TIMER (while holding SHIFT). You can return to the previous step.

1 Activate the clock setting mode.

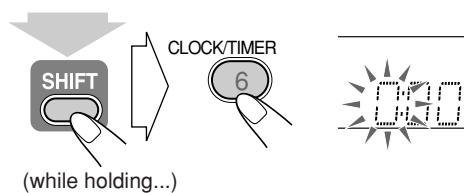

- If you have already adjusted the clock before, press the button repeatedly until the clock setting mode is selected.

2 Set the time.

- Adjust the hour, then the minute.

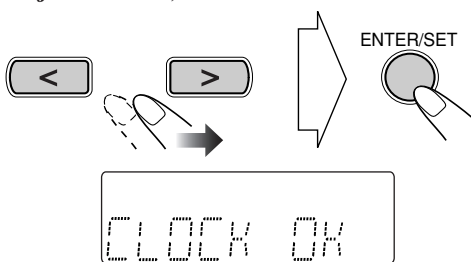

Now the built-in clock starts working.

To check the current clock time during play

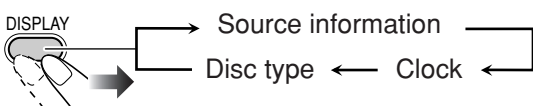

Turning Off the Power Automatically



Auto Standby

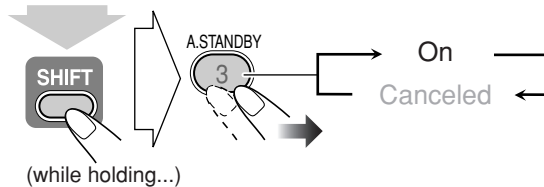

When Auto Standby is in use, the A.STBY indicator lights on the display.

When disc play stops, the A.STBY indicator starts flashing. If no operation is done for about 3 minutes while the indicator is flashing, the System turns off (standby) automatically.

Sleep Timer

You can set the shut-off time so that you can go to bed without turning it off yourself.

1 Specify the time (in minutes).

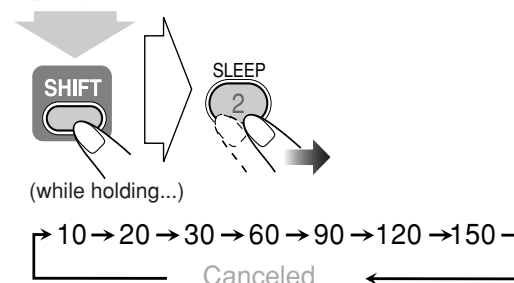

2 Wait until the set time disappears.

To check the time remaining until the shut-off time, press SLEEP while holding SHIFT.

- If you press the button repeatedly, you can change the shut-off time.

Unique DVD/VCD Operations

The following discs/files can be played back only with UX-G60:

- DVD Audio, WMA, ASF, DivX Ultra
- Files in a USB mass storage class device

Remote control

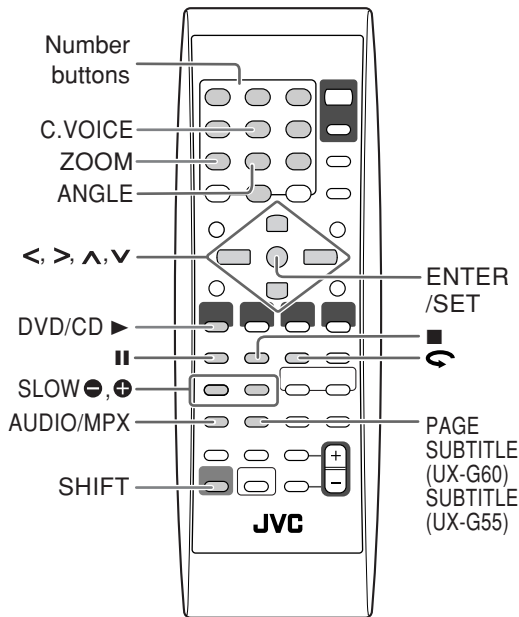

Selecting the Audio Track

For DVD Video/DivX: While playing back a chapter containing audio languages, you can select the language to listen to.

For DVD Audio*: While playing back a track containing audio channels, you can select the audio channel to listen to.

For DVD-VR and SVCD/VCD: When playing back a track, you can select the audio channel to play.

- You can also select the audio track using the on-screen bar (see page 22).



While playing a DVD Video...

Ex.:

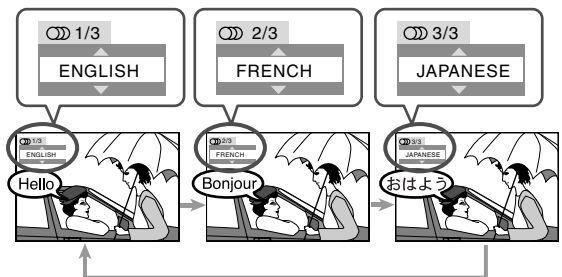

While playing a DVD Audio*/DivX...

Ex.:

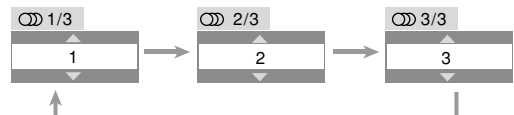

While playing a DVD-VR, or SVCD/VCD...

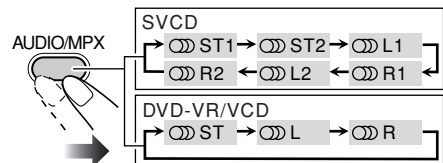

ST1/ST2/ST To listen to normal stereo (2-channel) playback.

L1/L2/L To listen to the left audio channel.

R1/R2/R To listen to the right audio channel.

- SVCD can have 4 audio channels. SVCD usually uses these 4 channels to record two 2-channel recordings (ST1/ST2).

* For UX-G60 only

Selecting the Subtitle Language

For DVD Video/DivX: While playing back a chapter containing subtitles in different languages, you can select the subtitle language to display on the TV.

For DVD-VR: While playing, you can turn the subtitles on or off.

For SVCD: While playing, you can select the subtitles even if no subtitles are recorded on the disc.

- You can also select the subtitle language using the on-screen bar (see page 22).

While playing a DVD Video/DivX...

1

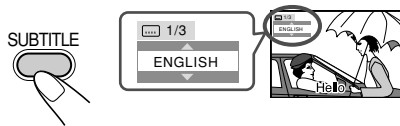

2

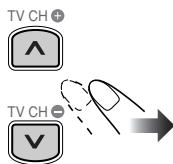

Ex.:

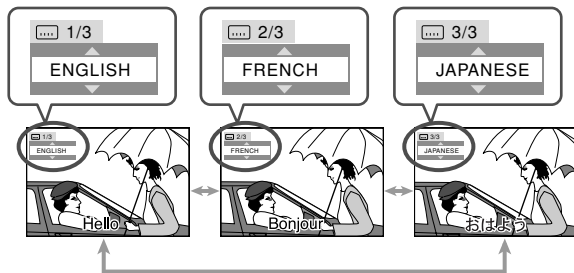

While playing a DVD-VR...

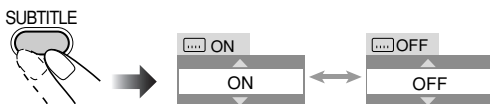

While playing an SVCD...

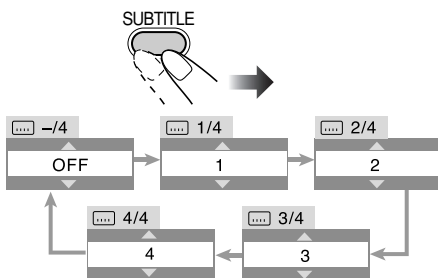

Selecting the View Angle

For DVD Video only: While playing back a chapter containing multi-view angles, you can view the same scene from different angles.

- You can also select the multi-view angles using the on-screen bar (see page 22).

While playing...

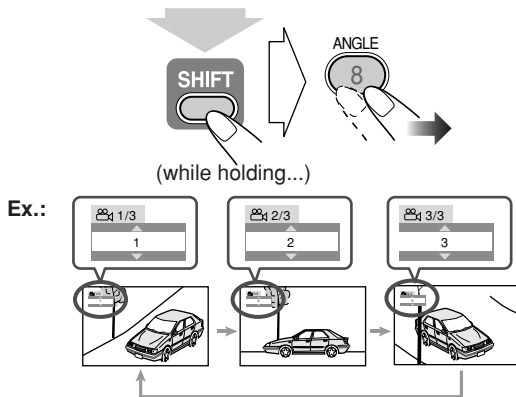

Selecting the Browsable Still Pictures

This function is available only for UX-G60.

For DVD Audio only: While playing back a track linked to browsable still pictures (B.S.P.), you can select the still picture (turn the page) to be shown on the TV screen.

- If a track is linked to browsable still pictures (B.S.P.), they are usually shown automatically during playback.
- You can also select the page using the on-screen bar (see page 22).

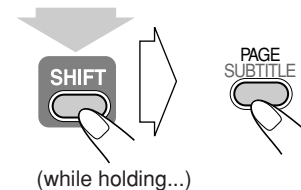

Each time you press the button (while holding SHIFT), the still picture changes one after another (if available).

Playing Back Bonus Group

This function is available only for UX-G60.

For DVD Audio only: Some DVD Audio discs have a special group called "bonus group" whose contents are not open to the public.

- To playback a bonus group, you have to enter the specific "key number" (a kind of password) for the bonus group. The way of getting the key number depends on the disc.

1 Select the bonus group.

- The bonus group is usually recorded as the last group (for example, if a disc contains 4 groups including a bonus group, "group 4" is the bonus group).
- For how to select the group, see "To select a title/group" on page 10.

Continued on the next page

* For UX-G60 only

2 Enter the key number.

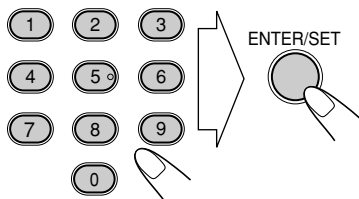

3 Follow the interactive instructions shown on the screen.

To cancel the key number entry, press ■.

Making Dialogues Clear—Clear Voice Remote ONLY

When you playback a disc, you can make the singer's voices or dialogues of the movie clear—Clear Voice. When Clear Voice is in use, the C.VOICE indicator lights on the display.

- This function only works for center-channel encoded multi-channel disc.

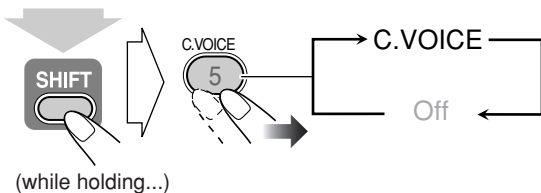

Special Effect Playback Remote ONLY INFO

Pause playback

To pause:	To resume normal playback:
While playing... 	

Frame-by-frame playback

1 While playing...



Still picture playback starts.

2 Advance the still picture frame by frame.



To resume normal playback, press DVD/CD ►.

Slow-motion playback

- This does not function for MPEG-1/MPEG-2/ASF*1/DivX discs.

1 While playing...



Still picture playback starts.

2 Select slow motion speed.

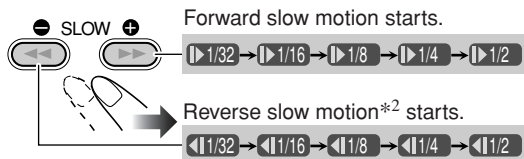

*2 Only available for DVD Video.

To resume normal playback, press DVD/CD ►.

To replay the previous scenes (One-Touch Replay)

- This function is only used while playing DVD Video/DVD-VR.

While playing back...



The playback position moves back about 10 seconds before the current position (only within the same title).

Zoom

1 While playing back...

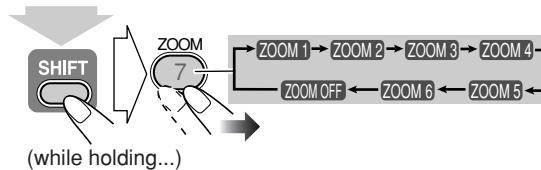

2 Move the zoomed-in position.

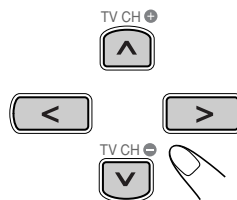

To cancel Zoom, press ZOOM (while holding SHIFT) repeatedly until "ZOOM OFF" appears on the TV.

Advanced Playback Operations

The following discs/files can be played back only with UX-G60:

- DVD Audio, WMA, ASF, DivX Ultra
- Files in a USB mass storage class device

Remote control

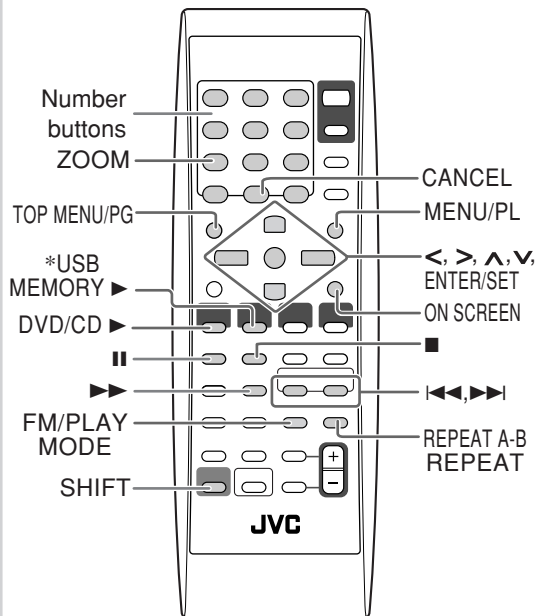

Main unit

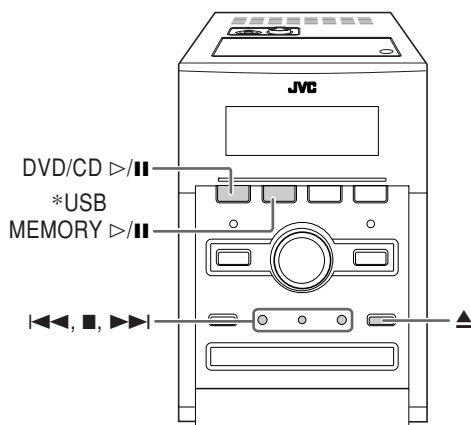

The illustration above is UX-G60.

Programming the Playing Order

—Program Play



INFO

You can arrange the playing order of the chapters or tracks (up to 99) before you start playback.

- Program play cannot be used for DVD-VR/JPEG/MPEG-1/MPEG-2/ASF*/DivX and files in a USB mass storage class device*.
- Resume does not work for Program Play.

1 Before starting playback, activate Program Play.

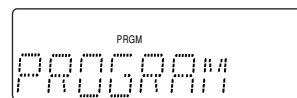
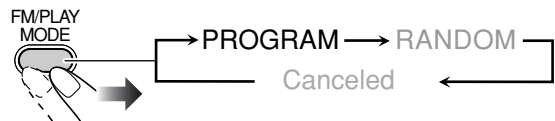

On the display

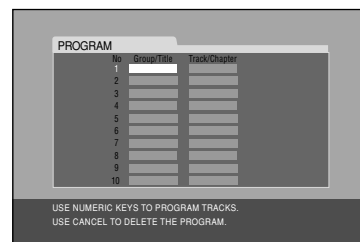

On the TV

2 Select chapters or tracks you want for Program Play.

- For DVD Video/DVD Audio*/MP3/WMA*:

- ① Select a title or group number.
- ② Select a chapter or track number.
- ③ Repeat the above steps ① and ②.

- For SVCD/VCD/CD:

- ① Select tracks.

To enter the numbers directly:

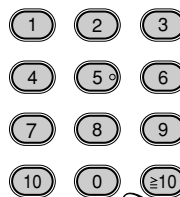

Examples:

To enter number 5, press 5.
 To enter number 10, press 10.
 To enter number 15, press \leq 10, 1, then 5.
 To enter number 30, press \leq 10, 3, then 10.

Continued on the next page

* For UX-G60 only

3 Start playback.



Playback starts in the order you have programmed.

To skip a step:	To pause:	To stop:
	<p>To release, press DVD/CD ▶.</p>	

To check the programmed contents

Before or after playback...

TV CH +



In the reverse order.

TV CH -



In the programmed order.

- You can also use ◀◀ or ▶▶ to check the programmed contents.

To modify the program

Before or after playback...

To erase the last track/file:

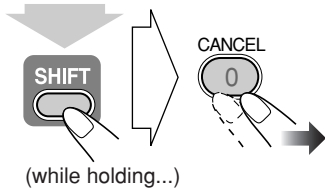

To erase the entire program:

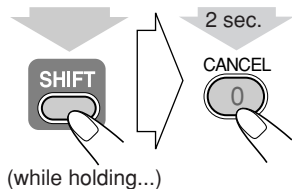

To add another track/file to the program:

Repeat step 2.

Playing at Random—Random Play

You can play all chapters or tracks at random.

- Random Play cannot be used for DVD-VR/JPEG/MPEG-1/MPEG-2/ASF*¹/DivX, some DVDs and files in the USB mass storage class device*¹.

1 Before starting playback, activate Random Play.

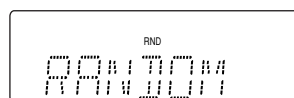
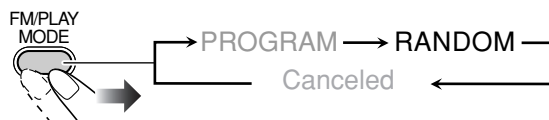

2 Start playback.



Playback starts in random order. Random Play ends when the entire disc has been played.

To skip a chapter/track:	To pause:	To stop:
	<p>To release, press DVD/CD ▶.</p>	

To exit from Random Play

Before or after playback...

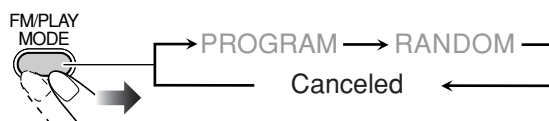

To exit from Program Play

Before or after playback...

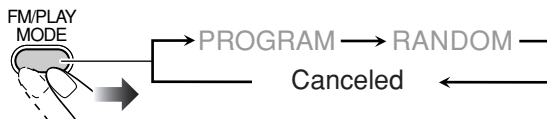

Playing Repeatedly



- You can also select the repeat mode using the on-screen bar (see pages 23 and 24).
- For MP3/WMA*¹/JPEG/MPEG-1/MPEG-2/ASF*¹/DivX, see page 27.

Repeat Play

You can repeat playback.

• For DVD Video:

While playing...



• For DVD Audio*¹:

While playing or before playback...

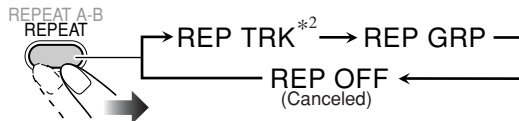

• For CD/SVCD/VCD:

While playing (without PBC for SVCD/VCD) or before playback...

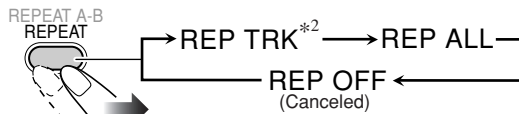

• For DVD-VR:

While playing an original program...



While playing a Program List...

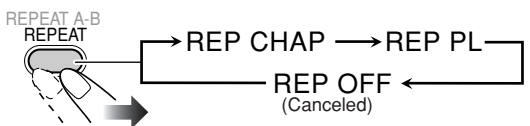

REP CHAP*²	Repeats the current chapter.
REP TTL	Repeats the current title.
REP TRK*²	Repeats the current track.
REP GRP	Repeats the current group.
REP PG	Repeats the current program.
REP ALL	Repeats the disc or program.
REP PL	Repeats the current Program List.

*² During Program Play and Random Play, “REP STEP” appears instead of these indications, and repeat modes change as follows for all the discs.

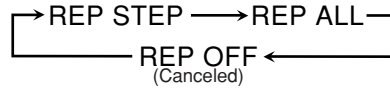

A-B Repeat

You can repeat playback of a desired portion by specifying the beginning (point A) and the ending (point B).

- A-B Repeat cannot be used for MP3/WMA*¹/MPEG-1/MPEG-2/ASF*¹/DivX, some DVDs and files in the USB mass storage class device*¹.

1 While playing (without PBC for SVCD/VCD), select the start point (A).

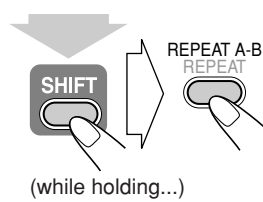

↻ starts flashing on the display.

- ↻ A-B appears on the TV if the TV is turned on.

2 Select the end point (B).

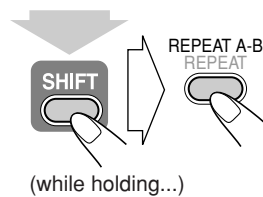

↻ stops flashing.

- ↻ A-B appears on the TV.
- You can search for the end point using the ►► button.

To cancel A-B Repeat, press REPEAT A-B again while holding SHIFT.

- A-B Repeat will also be canceled when you stop play or skip the chapter or track.

Prohibiting Disc Ejection—Child Lock



You can lock the disc tray so that no one can eject the loaded disc.

- This is possible only while the System is on standby.

While the disc tray is closed...

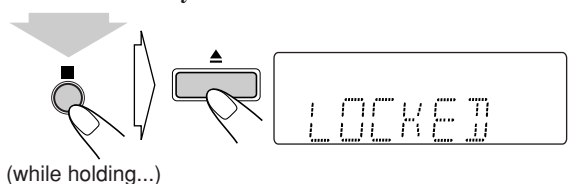

To cancel the prohibition, repeat the same procedure. “UNLOCKED” appears on the display.

*¹ For UX-G60 only

On-screen Disc Operations Remote ONLY »» INFO

You can check the disc information and use some functions through the on-screen bar.

On-screen bars

DVD Video

DVD Audio*1

SVCD

VCD

CD

MP3/WMA*1/MPEG-1/MPEG-2/ASF*1/DivX

USB*1

On-screen Bar Information

1 Disc type

2 Playback information

Indication	Meanings
Dolby D, LPCM	Audio format
3/2.1ch, 2/0.0 ch	Channel number
TITLE 2	Current title
CHAP 3	Current chapter
GROUP 1	Current group
TRACK 14	Current track
TOTAL 1:25:58	Time indications

3 Operation modes

Indication	Meanings
	Playback
	Forward/Reverse search
	Forward/Reverse slow-motion
	Pause
	Stop

4 Function icons (on the pull-down menu)

Indication	Meanings
TIME	Select to change the time indication.
	Select to repeat playback.
	Select for time search.
CHAP. →	Select for chapter search.
TRACK →	Select for track search.
	Select to change the audio language or channel (see also page 16).
	Select to change subtitle language (see also page 17).
	Select to change the view angle (see also page 17).
PAGE 1/5	Select to change the page (see also page 17).

To operate using the On-screen Bar

Ex.: Selecting a subtitle (French) for DVD Video

While a disc is selected as the source...

1 Display the entire on-screen bar.

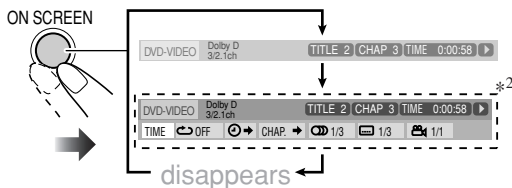

*2 This does not appear for MP3/WMA*¹/JPEG/MPEG-1/ MPEG-2/ASF*¹/DivX discs and files in a USB mass storage class device*¹.

2 Select (highlight) the item you want.

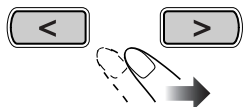

3 Display the pop-up window.



4 Select the desired option in the pop-up window.

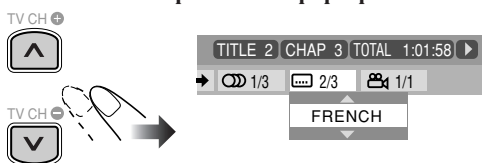

5 Finish the setting.

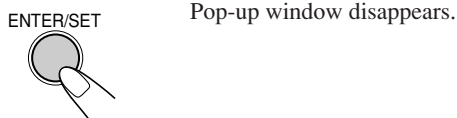

To remove the on-screen bar



For detailed operations of the following functions, see also "To operate using the On-screen Bar" on the left.

To change the time information

You can change the time information in the on-screen bar and the display window on the main unit.

1 While playing, display the on-screen bar with the pull-down menu.



2 Make sure [TIME] is selected (highlighted).

3 Change the time indication.

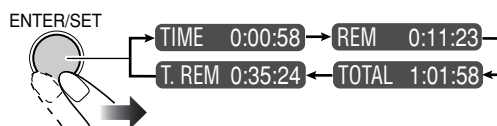

TIME	Elapsed playing time of the current chapter/track (except for DVD-VR).
REM	Remaining time of the current chapter/track (except for DVD-VR).
TOTAL	Elapsed disc time.
T. REM	Remaining disc time.

To remove the on-screen bar

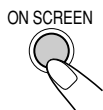

Repeat Play

• See also page 21.

1 While playing a disc (without PBC for SVCD/VCD), display the entire on-screen bar.

• Repeat Play can be selected before starting playback, except for DVD Video/DVD-VR.

2 Select [OFF].

3 Display the pop-up window.



Continued on the next page

*¹ For UX-G60 only

4 Select the repeat mode you want.

A-B	Repeats a desired portion (see below).
TITLE* ¹	Repeats the current title.
GROUP	Repeats the current group.
ALL	Repeats the disc (except for DVD) or program.
CHAPTER* ²	Repeats the current chapter.
TRACK* ²	Repeats the current track.
OFF	Cancels Repeat Play.

*¹ While playing a DVD-VR disc, "PG" appears, and while playing a Play list, "PL" appears.

*² During Program Play and Random Play, "STEP" appears.

5 Finish the setting.

ENTER/SET



A-B Repeat

• See also page 21.

1 While playing, display the entire on-screen bar.

2 Select **OFF**.

3 Display the pop-up window.



4 Select "A-B."

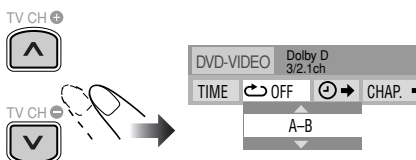

5 Select the start point (A).

ENTER/SET



6 Select the end point (B).

ENTER/SET



A-B Repeat starts. The selected portion plays repeatedly.

• Before pressing ENTER/SET, you can search for the end point using the **▶▶** button.

To cancel A-B Repeat, repeat steps **1** to **3**, and select "OFF" in step **4**.

Time Search

You can move to a particular point by specifying the elapsed playing time from the beginning.

1 While playing (without PBC for SVCD/VCD), display the entire on-screen bar.

• Time Search can be used before starting playback, except for DVD Video/DVD-VR.

2 Select **⏪**.

3 Display the pop-up window.

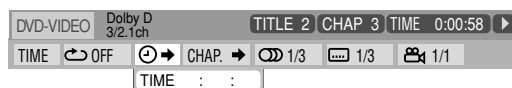

4 Enter the time.

You can specify the time in hours/minutes/seconds.

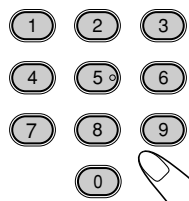

Examples:

To move to a point of 1 (hours): 02 (minutes): 00 (seconds), press 1, 0, 2, 0, then 0.

To move to a point of 54 (minutes): 00 (seconds), press 0, 5, 4, 0, then 0.

• It is always required to enter the hour digit (even "0" hour), but it is not required to enter trailing zeros (the last two digits in the examples above).

• **To correct a mis-entry**, press cursor **<** to erase the last entry.

5 Finish the setting.

ENTER/SET



The System starts playing the disc from the selected playing time.

Chapter/Track Search

You can search for the chapter (DVD Video/DVD-VR) or track (DVD Audio^{*3}) number to play.

1 While playing, display the entire on-screen bar.

2 Select **CHAP.▶** or **TRACK▶**.

3 Display the pop-up window.



^{*3} For UX-G60 only

4 Enter the desired chapter/track number.

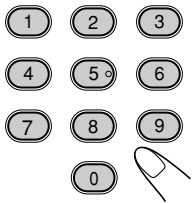

Examples:

- To select chapter/track 5, press 5.
- To select chapter/track 10, press 1, then 0.
- To select chapter/track 15, press 1, then 5.
- To select chapter/track 30, press 3, then 0.

- To correct a mis-entry, press the number buttons until the desired number shown in the pop-up window.

5 Finish the setting.



The System starts playing the searched chapter or track.

Browsable Still Pictures

This function is available only for UX-G60.

For DVD Audio only: While playing back a track linked to browsable still pictures (B.S.P.), you can select the still picture (turn the page) to be shown on the TV.

- If a track is linked to browsable still pictures (B.S.P.), they are usually shown automatically during playback.

1 While playing a DVD Audio, display the entire on-screen bar.

2 Select **PAGE 1 / 5**.

3 Display the pop-up window.

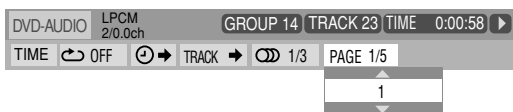

4 Select a still picture you want.

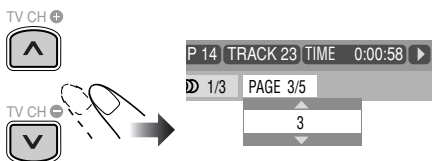

5 Finish the setting.



Control screen for DVD-R/-RW in DVD-VR format

The control screen is superimposed on the TV screen when you call up Program List (PG) or Play List (PL).

To select playback type

To select the Program List:	To select the Play List:
To remove the list, press the same button again.	

Ex.: When Program List is selected.

ORIGINAL PROGRAM				
No	Date	Ch	Time	Title
1	03/12/06	L	12:15	La fleur
2	09/12/06	L	23:05	The last struggle
3	18/12/06	L	08:17	free flyer
4	20/12/06	L	07:47	BOOM!
5	25/12/06	L	19:38	Mr. Lawrence
6	28/12/06	L	14:20	Satisfy U

Ex.: When Play List is selected.

PLAY LIST				
No	Date	Chap	Length	Title
1	03/12/06	002	0:23:24	Nebula G.
2	15/12/06	004	1:04:39	CDJ
3	24/12/06	013	0:41:26	Secret Garden
4	27/12/06	017	0:09:08	S. Walker

- Listed number
- Recording date
- Recording channels
- Recording time
- Title
- Highlight bar (current selection)
- Chapters included
- Playback time

To select an item in the list and start playback

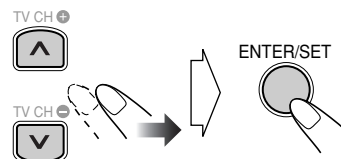

Audio/Video File Operations

The following discs/files can be played back only with UX-G60:

- DVD Audio, WMA, ASF, DivX Ultra
- Files in a USB mass storage class device

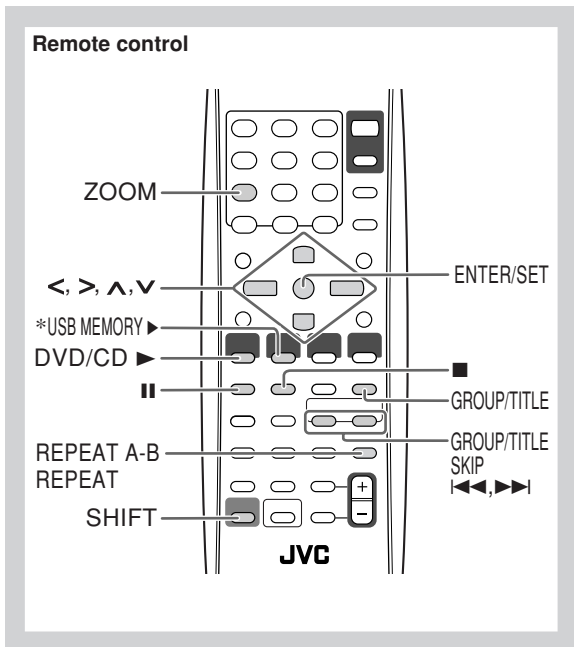

Operations on the Control



Screen

You can search for and play the desired items through the control screen for MP3/WMA*/JPEG/MPEG-1/MPEG-2/ASF*/DivX files.

Control screen for MP3/WMA*/JPEG/MPEG-1/MPEG-2/ASF*/DivX files

The control screen automatically appears on the TV screen when you load a disc or connect and select a USB mass storage class device* in which MP3, WMA*, JPEG, MPEG-1, MPEG-2, ASF*, or DivX is recorded.

Ex.: When the MP3 disc is loaded.

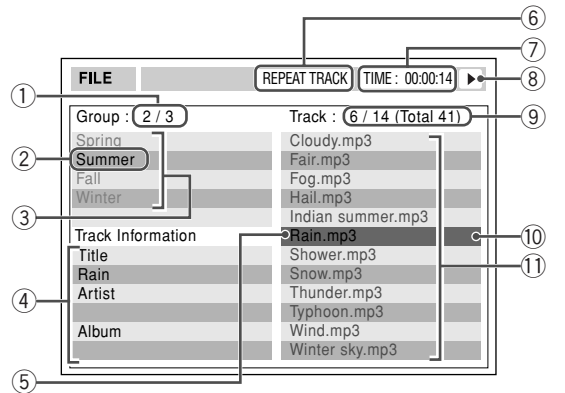

- ① Current group number/total group number
- ② Current group
- ③ Group list
- ④ Track information (ID3 Tag Version 1.0: only for MP3 and WMA*)
- ⑤ Current track
- ⑥ Repeat Play setting
- ⑦ Elapsed playing time of the current track (except for JPEG)
- ⑧ Operation mode icon
- ⑨ Current track number/total number of tracks in the current group (total number of tracks on the loaded disc)
- ⑩ Highlight bar
- ⑪ Track list

- If files of different types (MP3, WMA*, JPEG, MPEG-1, MPEG-2, ASF* and DivX) are recorded on a disc or device, select the file type to play (see page 35).

To move the highlight bar between group list and track list

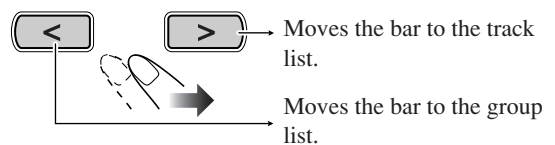

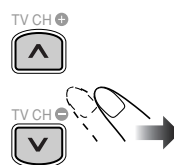

To select an item in the list



Move the highlight bar to the desired item.

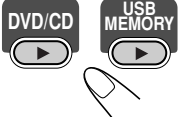

- If you move the highlight bar while playing back an MP3, WMA* file or DVD-VR (PG/PL) disc, the selected track starts playback automatically.

To start playback

For JPEG:	
	The selected track (still picture) is displayed until you change it.
	Press one of the buttons depending on the current source. Slide-show playback starts. Each track (still picture) is shown on the screen for about 3 seconds, then changes one after another.
For the other files:	
	Playback starts with the selected track. • Pressing DVD/CD ► or USB MEMORY ►*1 also starts playback.

- Once you start viewing a JPEG/MPEG-1/MPEG-2/ASF*1/DivX track, the control screen disappears.
- To cancel slide-show and display the current still picture, press **II**.

To select a group:

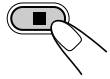
 (while holding...)	
To skip a track:	To stop playback:
	

- You can select a group directly by pressing a number button after pressing GROUP/TITLE (except for DVD-VR disc).

To repeat MP3 or WMA*1 playback

While playing or before playback...

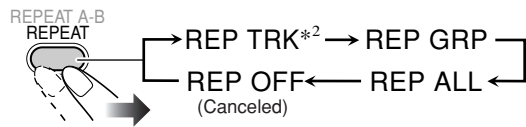

To repeat slide-show for JPEG

While playing or before playback...

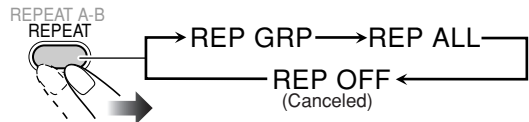

To repeat MPEG-1/MPEG-2/ASF*1/ DivX playback

While playing or before playback...



REP TRK*2 Repeats the current track.

REP GRP Repeats the current group.

REP ALL Repeats the disc.

*2 During Program Play and Random Play, "REP STEP" appears instead of this indication.

To zoom in the JPEG files

- You cannot zoom in the still picture during slide-show.

1 While playing back a still picture...

- During slide-show, press **II** to display the still picture, then...

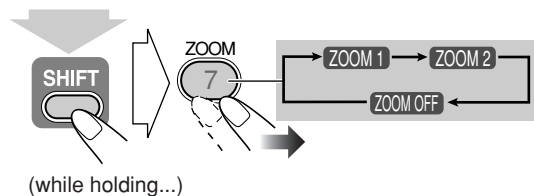

2 Move the zoomed-in position.

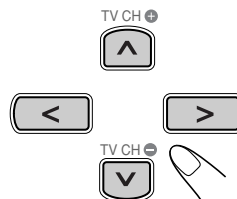

To cancel Zoom, press ZOOM (while holding SHIFT) repeatedly until "ZOOM OFF" appears on the TV.

*1 For UX-G60 only

Advanced Tape Operations

Remote control

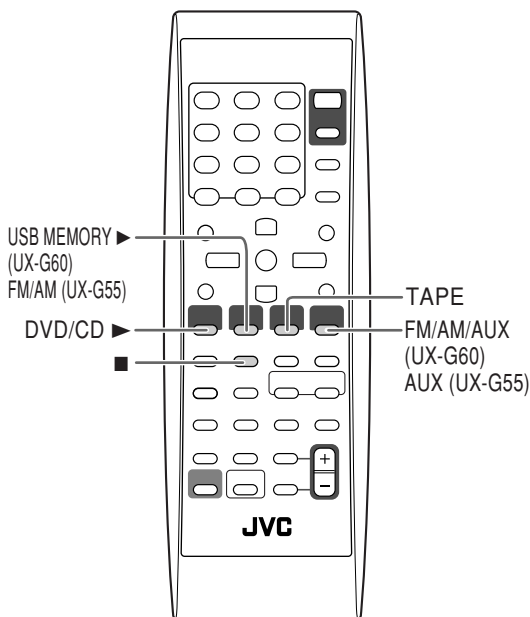

IMPORTANT

It may be unlawful to record or playback copyrighted material without the consent of the copyright owner.

Recording on a Tape **INFO**

You can use type I tapes for recording.

- To play a tape, see page 9.

1 Insert a recordable cassette.

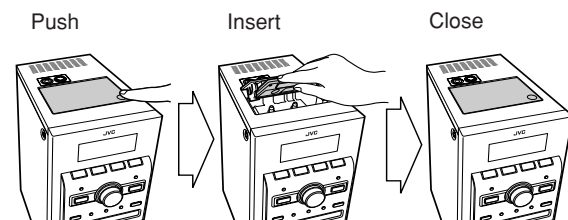

With the tape side facing outside

The illustration above is UX-G60.

2 Select and start playing the source—"FM," "AM," "DVD/CD," "USB MEM*," or "AUX."

- When recording from a disc or USB source, you can also use "Synchronized Recording" (see page 29).

3 Start recording.

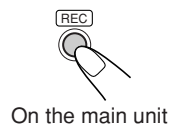

On the main unit

Main unit

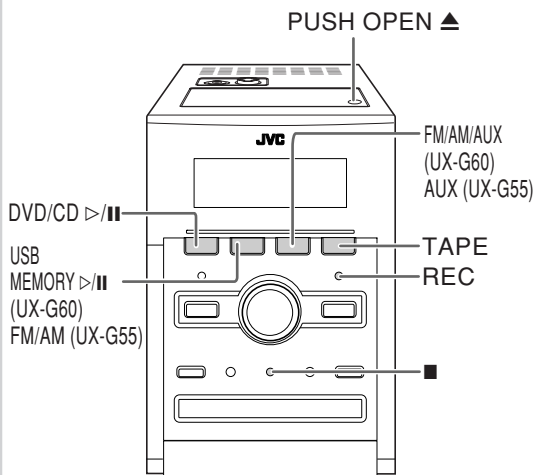

The illustration above is UX-G60.

To stop recording:



Synchronized Recording INFO

You can start and stop both playback and tape recording at the same time.

To record the entire tracks

1 Load a disc or connect a USB mass storage class device*¹ and insert a recordable cassette.

- Press DVD/CD ► or USB MEMORY ►*¹ to select the current playing source, then ■.

2 Start recording.



The System automatically creates 4-second blanks between the tunes recorded on the tapes.

On the main unit

- When either playback*² or recording ends, both playback and recording stop at the same time.

*² For DVD Video: When a title is finished playing.

- When the tape reaches its end, both playback and recording also stop at the same time.

To record a “Live” disc

It will not be desirable to put 4-second blank portions between the tunes recorded on the tape.

To record the entire tracks without any interruption recorded, pause playback (press DVD/CD ► or USB MEMORY ►*¹, then ||) before pressing REC.

To record Program Play

1 Select Program Play (and make a program), but do not start playback.

2 Press REC to start recording.

- When disc play stops, recording stops automatically.

To record only your favorite track

You can specify tracks to be recorded on the tape while listening from a disc (except for DVD Video/DVD-VR) or USB mass storage class device*¹.

1 Start playing a disc/file.

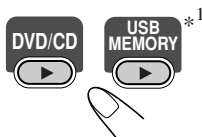

2 While a track you want to record on the tape is playing...



On the main unit

Playback returns to the beginning of that track and the track is recorded on the tape. After recording the track, playback and recording automatically stop.

3 Repeat steps 1 and 2 to record other tracks you want.

- You can change the disc if necessary.

To protect your recording

Cassettes have two small tabs on the back to protect from unexpected erasure or re-recording.

To protect your recording, remove these tabs.



To re-record on a protected tape, cover the holes with adhesive tape.

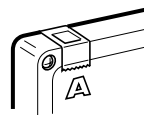

*¹ For UX-G60 only

Enjoying Karaoke

Remote control

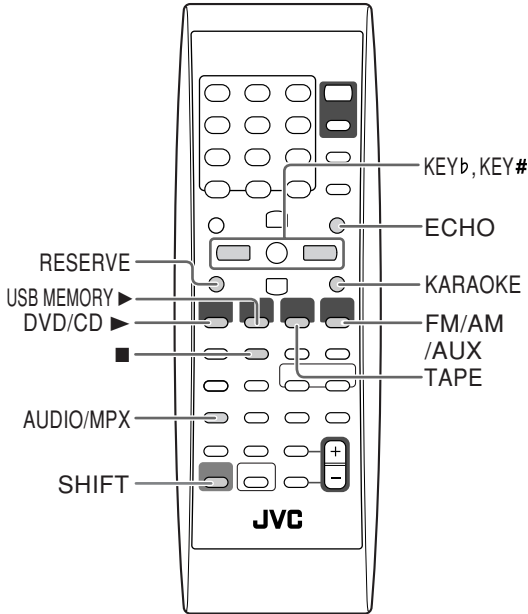

Main unit

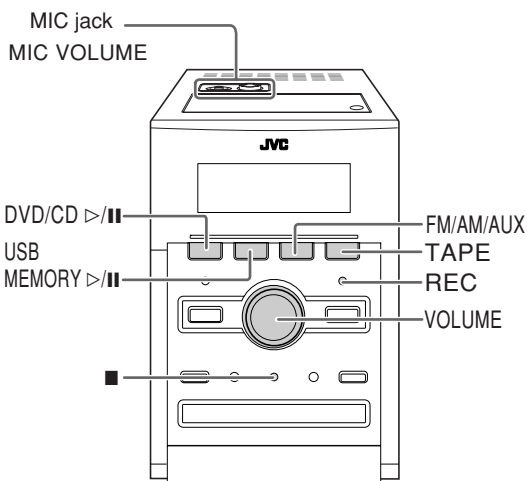

The illustration above is UX-G60.

NOTE

This function is not available for UX-G55.

IMPORTANT

Always set MIC VOLUME to MIN when connecting or disconnecting the microphone.



DO NOT keep the microphone connected while they are not in use.

Singing Along (Karaoke) **INFO**

To sing along using the Karaoke discs

You can enjoy Karaoke using the Karaoke disc (except Karaoke CD).

- By pressing REC, you can record your singing-along (for SVCD/VCD without PBC).

1 Turn MIC VOLUME to MIN.

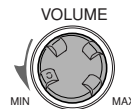

2 Connect the microphone (not supplied) to the MIC jack.

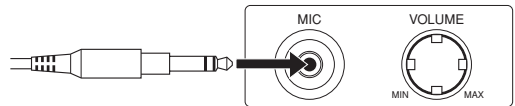

3 Insert and start playing a Karaoke disc.

4 Select an audio track.



- For details, see “Selecting the Audio Track” on page 16.

5 Sing into the microphone.

6 Adjust the MIC VOLUME and VOLUME.

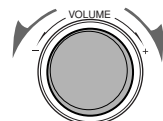
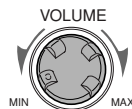

Karaoke function is not available in the Australian model.

To adjust the Key (disc/file playback only)

1 Activate Key Control.

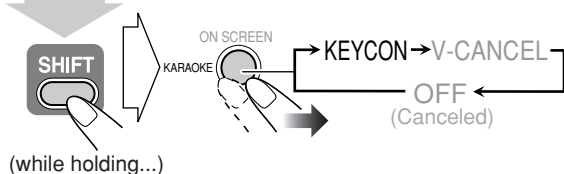

2 Adjust the Key

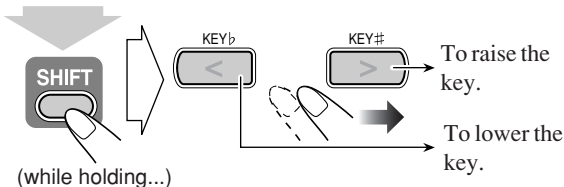

- Key Control cannot be activated for DVD Audio/ DVD-VR/MPEG-1/MPEG-2/ASF/DivX.

To deactivate Key Control, press KARAOKE (while holding SHIFT) to select "OFF."

To apply echo to your voice

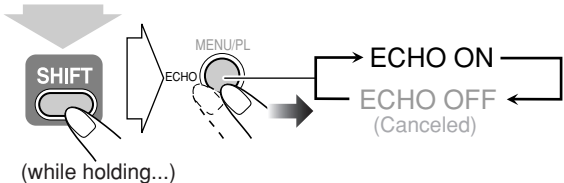

To sing along using the stereo discs/audio files —Vocal Masking

You can enjoy Karaoke while playing a stereo disc or an audio file.

Vocal Masking reduces the lead vocal of any disc except DVD Audio and DVD-VR.

1 Turn MIC VOLUME to MIN.

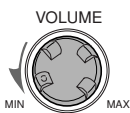

2 Connect the microphone (not supplied) to the MIC jack.

3 Insert and start playing a stereo disc or start playing an audio file.



4 Activate Vocal Masking.

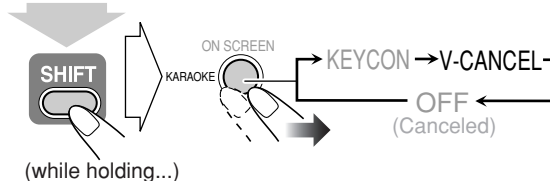

5 Sing into the microphone.

6 Adjust the MIC VOLUME and VOLUME.



- You can apply echo to your voice.

To deactivate Vocal Masking, select "OFF" in step 4.

Microphone Mixing

You can enjoy microphone mixing while playing any source.

- By pressing REC, you can record your singing-along (except when the playing source is "TAPE").

1 Turn MIC VOLUME to MIN.

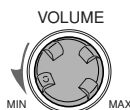

2 Connect the microphone (not supplied) to the MIC jack.

3 Start playing the source—"FM," "AM," "DVD/CD," "USB MEM," "TAPE," or "AUX."

4 Sing into the microphone.

5 Adjust the MIC VOLUME and VOLUME.



- You can apply echo to your voice. While playing a disc, you can also adjust Key Control and apply echo.
- When selecting "TAPE" as the source, microphone mixing is available only during tape playback.

To use the microphone only, select "AUX" in step 3, but do not start playback.

Karaoke function is not available in the Australian model.

Reserving Karaoke Songs



—Karaoke Program Play

You can determine the playback order of the titles or tracks on the disc player. You can program up to 12 steps.

1 Change the source to “DVD/CD.”

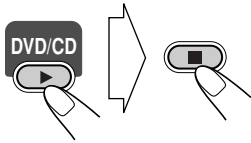

2 Activate Karaoke Program Play.

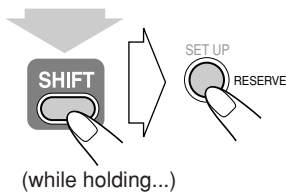

(while holding...)

No	Gr/Tt	Tr/Chap
1		
2		
3		
4		
5		

On the TV screen

• PRGM indicator flashes during this mode.

3 Select songs you want for Karaoke Program Play.

Press the number buttons to select a song in the following order.

- ① Select a title/group.
- ② Select a chapter/track.

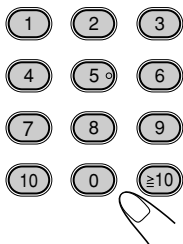

Examples:

- To select preset number 5, press 5.
- To select preset number 10, press 10.
- To select preset number 15, press \cong 10, 1, then 5.
- To select preset number 30, press \cong 10, 3, then 0.

4 Start playback.



Playback starts in the order you have programmed.

To check the programmed contents

During Karaoke Program Play...

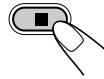

The Karaoke reserve screen appears.

To modify the program

While the Karaoke reserve screen is shown on the TV...

To remove the unwanted track:

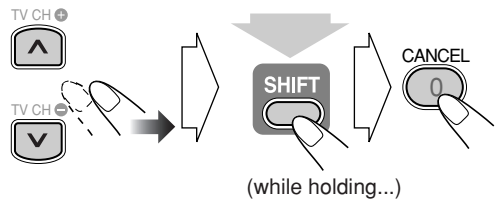

(while holding...)

To add another track to the program:

Repeat step 3.

To erase the entire program:

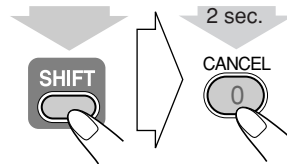

To exit from Karaoke Program Play

Before or after playback...

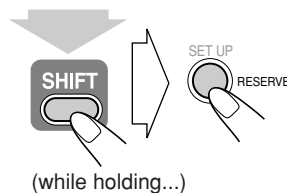

(while holding...)

During playback...

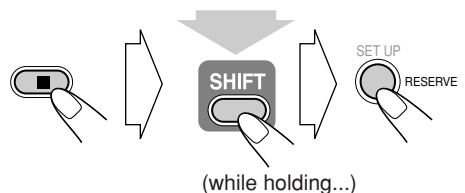

(while holding...)

Karaoke function is not available in the Australian model.

Timer Operations

Remote control

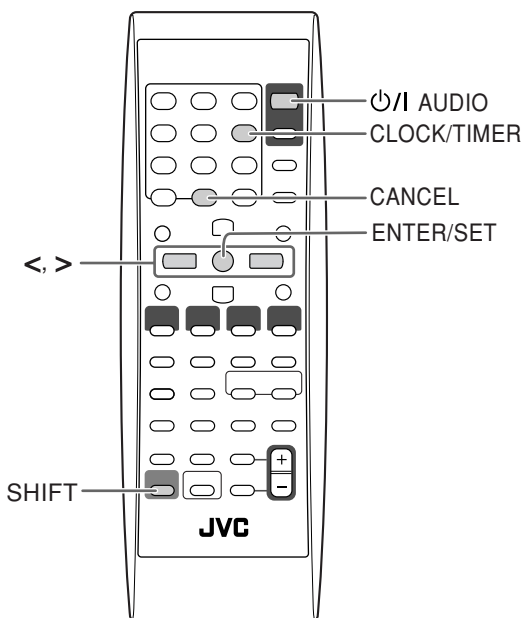

- 1 Select one of the timer setting modes you want to set—DAILY 1 ON time, DAILY 2 ON time, DAILY 3 ON time, or REC TMR(Recording Timer) ON time.

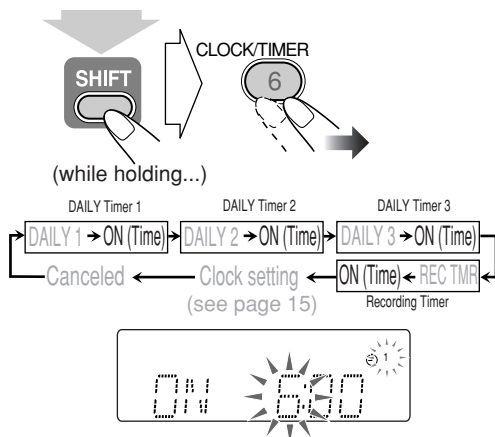

Ex. When Daily Timer 1 setting mode is selected

- When the clock has not been set, pressing CLOCK/TIMER (while holding SHIFT) makes the System enter the clock setting mode.

- 2 Make the timer setting as you want.

Repeat the procedure for the following settings until finished—

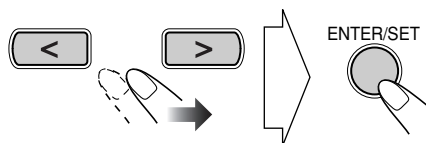

- ① Set the hour then the minute for on-time.
- ② Set the hour then the minute for off-time.
- ③ Select the playback source—"TUNER FM," "TUNER AM," "TAPE," "DISC," "USB MEM*," or "AUX."

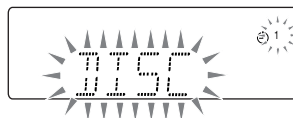

- ④ For "TUNER FM" and "TUNER AM": Select a preset channel.
For "DISC": Select the title/group number, then the chapter/track number.
For "USB MEM*": Select the group number, then the track/file number.

Setting the Timer



Using Daily Timer, you can wake up with your favorite music. On the other hand, with Recording Timer, you can make a tape of a radio broadcast automatically.

You can store three Daily Timer settings and one Recording Timer setting; however, you can activate only one of the timers at the same time.

- To exit from the timer setting, press CLOCK/TIMER (while holding SHIFT) as required.
- To correct a mis-entry during process, press CANCEL (while holding SHIFT). You can go back to the previous step.

Daily Timer initial settings when shipped from the factory

- DAILY 1: ON Time (6:00)/OFF Time (8:00)/ Source (TUNER FM 1)/Volume level (--)
- DAILY 2: ON Time (7:00)/OFF Time (9:00)/ Source (TUNER FM 1)/Volume level (--)
- DAILY 3: ON Time (10:00)/OFF Time (12:00)/ Source (TUNER FM 1)/Volume level (--)

Continued on the next page

* For UX-G60 only

⑤ **Select the volume level.**

- You can adjust the volume level (“1” to “40” and “VOL --”).
- If you select “VOL --,” the volume is set to the last level when the unit has been turned off.

Once settings are completed, the Timer setting information appears in sequence.

- This function is not available for VCD with PBC activated.

For Recording Timer:

- ① **Set the hour then the minute for on-time.**
- ② **Set the hour then the minute for off-time.**
- ③ **Select the playback source—“TUNER FM,” “TUNER AM,” or “AUX.”**
- ④ **For “TUNER FM” and “TUNER AM”: Select a preset channel.**

Once settings are completed, the Timer setting information appears in sequence. The volume is set to the last level when the unit has been turned off.

3 Turn off the unit (on standby) if you have set the on-time.



How Daily Timer works

Once the Daily Timer has been set, the timer indicator (⌚) and timer number indicator (1/2/3) are lit on the display. Daily Timer is activated at the same time everyday until the timer is turned off manually (see the next column) or another timer is activated.

When the on-time comes

The System turns on, tunes in to the specified station or starts playing the loaded disc with the specified chapter or track, and sets the volume level gradually to the preset level after about 30 seconds.

- While Daily Timer is working, the timer indicator (⌚) and timer number indicator (1/2/3) flash on the display.

When the off-time comes

The System stops playback, and turns off (on standby) automatically.

- The timer setting remains in memory until you change it.

How Recording Timer works

When Recording Timer has been set, Timer (⌚) indicator and the REC indicator are lit on the display. Recording Timer works only once.

When the on-time comes

The System turns on, tunes in to the specified station or changes the source to “AUX”, and starts recording.

When the off-time comes

The System stops recording, and turns off (on standby).

- The timer setting remains in memory until you change it.

To turn on or off the Timer

Since Daily Timer is activated at the same time everyday, you may need to cancel it on some particular days.

To cancel the Timer

- 1 Select the Timer (DAILY 1, DAILY 2, or DAILY 3) you want to cancel.**

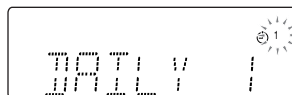
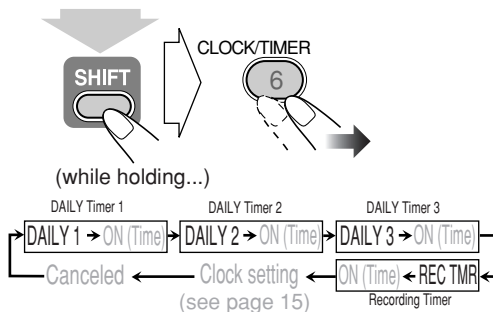

Ex. To cancel Daily Timer 1

- 2 Turn off the selected Timer.**

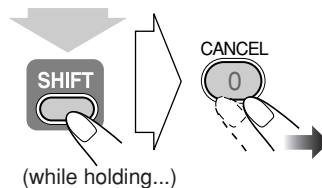

To turn on the Timer

- 1 Select the Timer (DAILY 1, DAILY 2, or DAILY 3) you want to activate.**

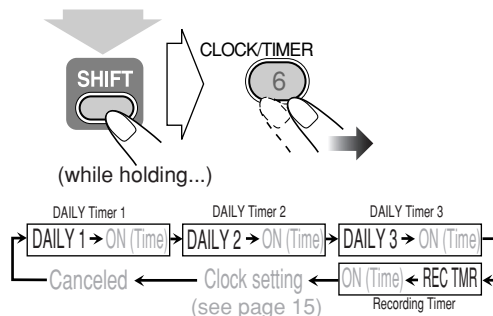

- 2 Activate the selected Timer.**

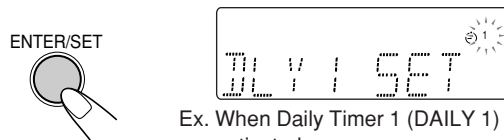

Ex. When Daily Timer 1 (DAILY 1) is activated

- 3 Wait until the indication disappears.**

Setup Menu Operations INFO

Remote Control

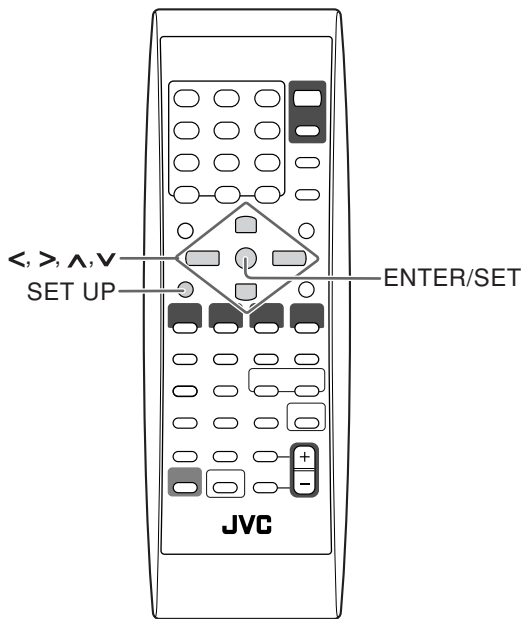

Initial settings Remote ONLY >>>

The Setup Menu cannot be activated during playback.

1 Press SET UP.

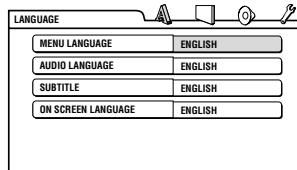

2 Press < (or >) to select the menu.

3 Press ^ (or v) to move to select the item.

4 Press ENTER/SET.

5 Press ^ (or v) to select the options, then press ENTER/SET.

- For settings of the LANGUAGE menu, see also "Language Code List" on page 42.

To remove a preference display

Press SET UP.

A LANGUAGE menu

Item	Contents
MENU LANGUAGE	You can select the initial menu language of the DVD Video.
AUDIO LANGUAGE	You can select the initial audio language of the DVD Video.
SUBTITLE	You can select the initial subtitle language of the DVD Video.
ON SCREEN LANGUAGE	You can select "ENGLISH," "CHINESE," or "SPANISH" as the on-screen language.

P PICTURE menu

Item	Contents
MONITOR TYPE <div style="display: flex; justify-content: space-around; align-items: center;"> <div style="text-align: center;"> <p>16:9</p> </div> <div style="text-align: center;"> <p>4:3 LB</p> </div> </div> <div style="margin-top: 10px;"> <p>4:3 PS</p> </div>	You can select the monitor type to match your TV when you playback DVD Video discs recorded for wide-screen televisions. 16:9/16:9 MULTI (Wide television screen): For a wide-screen (16:9) TV. 4:3 LB/4:3 MULTI LB (Letter Box conversion): For a conventional (4:3) TV. Displays a wide-screen picture to fit the width of the TV screen keeping the aspect ratio. 4:3 PS/4:3 MULTI PS (Pan Scan conversion): For a conventional (4:3) TV. The picture is zoomed in to fill the screen vertically and the left and right sides of the picture are cut off. • For multi-color system TVs, select the [MULTI] option.
PICTURE SOURCE	You can obtain optimal picture quality by selecting the source type of the disc contents. AUTO: Normally, select this option. The System recognizes the picture type (film or video source) of the current disc according to the disc information. FILM: For a film source disc. VIDEO: For a video source disc.
SCREEN SAVER	You can set the screen saver function to ON or OFF . If no operation is done for about 5 minutes, the display dims.
FILE TYPE	You can select the file type to play. AUDIO: To play MP3 and WMA (for UX-G60 only) files. STILL PICTURE: To play JPEG files. VIDEO: To play MPEG-1, MPEG-2, ASF (for UX-G60 only) and DivX files.



AUDIO menu

Item	Contents
DIGITAL AUDIO OUTPUT	Set this item correctly when using the OPTICAL DIGITAL OUT terminal on the rear. PCM ONLY: When connecting to audio equipment which can decode only linear PCM signals. DOLBY DIGITAL/PCM: When connecting to a Dolby Digital decoder or an amplifier with a built-in Dolby Digital decoder. STREAM/PCM: When connecting to a DTS decoder or an amplifier with a built-in DTS decoder.
DOWN MIX	This setting is effective for digital audio output if “DIGITAL AUDIO OUTPUT” is set to “PCM ONLY.” DOLBY SURROUND: Select this when connecting to a surround decoder. STEREO: Select this when connecting to a stereo receiver, MD player, TV, etc.
D. RANGE COMPRESSION	Set this item to listen to DVD Video recorded in Dolby Digital format at low or middle volume. AUTO: You can enjoy powerful playback sound with full dynamic range. ON: Select this when you want to fully apply the compression effect to make the sound at lower volume clear (useful at midnight).



OTHERS menu

Item	Contents
RESUME	You can select Resume. ON: The System resumes playback from the position where playback has been stopped if the disc is still in the disc tray. OFF: Resume is deactivated.
ON SCREEN GUIDE	Activate or deactivate the on-screen guide.
DivX REGISTRATION	The System has its own Registration Code. If necessary, you can confirm it. Once you have played back a disc in which the Registration Code is recorded, the System's Registration Code is overwritten for copyright protection.

Additional Information

Learning More about This System ● ● ●

Connections (see pages 3 to 5)

- Make sure the antenna conductors do not touch any other terminals, connecting cords or the power cord. Also, keep the antennas away from metallic parts of the System, connecting cords and the AC power cord. This could cause poor reception.
- Use only speakers with the same speaker impedance as indicated by the speaker terminals on the rear of the System.
- The speakers are magnetically shielded to avoid color distortions on TVs. However, if not installed properly, it may cause color distortions. So, pay attention to the following when installing the speakers.
 - When placing the speakers near a TV set, turn off the TV's main power switch or unplug it before installing the speakers.
Then wait at least 30 minutes before turning on the TV's main power switch again.
 - Some TVs may still be affected even though you have followed the above instructions. If this happens, move the speakers away from the TV.

Daily Operations—Playback (see pages 7 to 11)

Listening to the Radio:

- If you store a new station into an occupied preset number, the previously stored station in that number will be erased.
- When you unplug the AC power cord or if a power failure occurs, the preset stations will be erased in a few days. If this happens, preset the stations again.

Playing Back a Disc/File:

- When you change the source to DVD/CD or USB MEMORY (for UX-G60 only), it may take a while to activate the source.
- On some DVD, SVCD, or VCD discs, the actual operations may be different from what is explained in this manual, due to the programming and disc structure; such differences are not a malfunction of this System.
- This System can recognize up to 4 000 tracks in a disc. Also, the System can recognize up to 150 tracks per group and up to 99 groups in a disc.
 - If there are any unplayable files in a folder, those files are also counted in the total file number.
 - Playable files which do not belong to any groups are handled as group 1.
- For DVD-VR playback...
 - This System can play only a disc of UDF-Bridge format.
 - For details about DVD-VR format and play list, refer to the manual of the recording equipment.
 - You cannot use reverse slow motion, Program Play, or Random Play.
- For MP3 or WMA (for UX-G60 only) playback...
 - MP3/WMA discs require a longer readout time than regular CDs. (It depends on the complexity of the group/file configuration.)

- Some MP3/WMA files cannot be played back and will be skipped. This results from their recording processes and conditions.
- This System can play only a disc of ISO 9660 Level 1 or Level 2.
- This System can playback MP3/WMA files with the extension code <.mp3> or <.wma> (regardless of the letter case—upper/lower).
- It is recommended that you make each MP3/WMA file at a sampling rate of 44.1 kHz and at a bit rate of 128 kbps. This System cannot playback files made at a bit rate of less than 64 kbps.
- For JPEG files playback...
 - It is recommended that you record a file at 640 x 480 resolution. (If a file has been recorded at a resolution of more than 640 x 480, it will take a long time to be shown.)
 - This System can play only baseline JPEG files*. Progressive JPEG files* or lossless JPEG files* cannot be played.
 - * Baseline JPEG format: Used for digital cameras, web, etc.
 - Progressive JPEG format: Used for web.
 - Lossless JPEG format: An old type and rarely used now.
 - This System can playback JPEG files with the extension code <.jpg> or <.jpeg> (regardless of the letter case—upper/lower).
 - This System may not playback JPEG files properly if they are recorded from a device other than a digital camera.
 - During slide-show playback, zoom cannot be operated.
- For MPEG-1/MPEG-2 playback...
 - The stream format should conform to MPEG system/program stream.
 - 720 x 576 pixels (25 fps)/720 x 480 pixels (30 fps) is recommended for the highest resolution.
 - This System also supports the resolutions of 352 x 576/480 x 576/352 x 288 pixels (25 fps) and 352 x 480/480 x 480/352 x 240 pixels (30 fps).
 - The file format should be MP@ML (Main Profile at Main Level)/SP@ML (Simple profile at Main Level)/MP@LL (Main Profile at Low Level).
 - Audio streams should conform to MPEG1 Audio layer-2 or MPEG2 Audio Layer-2.
- For DivX playback...
 - This System can play only a disc of UDF-Bridge format. “Multi-border” is not supported.
 - The System supports DivX files whose resolution is 720 x 480 pixels or less (30 fps), and 720 x 576 pixels or less (25 fps).
 - Audio stream should conform to MPEG1 Audio Layer-2 or MPEG Audio Layer-3 (MP3).

- This System can playback DivX files with the extension code <.divx> <.div> <.avi> (regardless of the letter case—upper/lower).
- The System does not support GMC (Global Motion Compression).
- The file encoded in the interlaced scanning mode may not be played back correctly.
- You cannot use the following functions—One Touch Replay, Slow motion, A-B Repeat, Program Play, Random Play and on-screen operations.

Playing Back a Disc/File for UX-G60:

- Some DVD Audio discs prohibit downmix. When you playback such a disc, “LR ONLY” appears on the display and the System plays back the left front and right front signals.
- When playing back a DVD Audio disc recorded in MLP (Meridian Lossless Packing; a lossless audio compression system that can completely recreate the PCM signal), the signals are recognized as the linear PCM signals, however, no indicator lights up on the display.
- While the System is reading a disc, changing the source to USB MEMORY may cause the System to continue playback the DVD/CD source. In this case, press ■ on the main unit to reactivate the USB source.
- The following functions cannot be used for the files in the USB mass storage class device:
 - Selecting the View Angle (page 17)
 - Special Effect Playback (page 18)
 - Program Play (page 19)
 - A-B Repeat (page 21)
 - Time Search (page 24)
- For playback of files in the USB mass storage class device...
 - When connecting a USB mass storage class device, refer also to its manual.
 - Connect one USB mass storage class device to the System at a time. Do not use a USB hub.
 - You cannot charge any USB device through the USB MEMORY jack of this System.
 - While playing back a file in a USB mass storage class device, do not disconnect the device. It may cause a malfunction of both the System and the device.
 - JVC bears no responsibility for any loss of data in the USB mass storage class device while using this System.
 - When connecting with a USB cable, use the cable whose length is less than 1 m.
 - This System is compatible with the USB Full-Speed (not compatible with the USB 1.1).
 - You can playback the following types of files in a USB mass storage class device (maximum data transfer rate: 2 Mbps):
 - Music: MP3, WMA
 - Picture: JPEG
 - Movie: MPEG-1, MPEG-2, ASF, DivX (maximum frame rate of 30 fps for progressive)

- You cannot playback a file larger than 2 Gigabyte.
- When playing a file which has a large transfer rate, frames or sounds may be dropped during playback.
- This System cannot recognize a USB mass storage class device whose rating is other than 5 V and does not exceed 500 mA.
- This System may not playback some USB mass storage class devices and does not support DRM (Digital Rights Management).
- This System may not playback some files even though their formats are listed above.
- For ASF playback...
 - This System can playback ASF files with the extension code <.asf> (regardless of the letter case—upper/lower).
 - This System supports ASF files whose resolution is 352 x 288 pixels or less.
 - Some recorded files may not be able to playback depending on file characteristics, kind of digital camera/video camera, or recording conditions.
 - You cannot use the following functions—One Touch Replay, Slow motion, A-B Repeat, Program Play and Random Play.

Playing Back a Portable Audio Device:

- When QP Link fails due to a weak sound signal from the AUX jack, Auto Standby may turn the System off even if you can hear the sound from the speakers. In such cases, adjust the volume level of the component louder so that the System can detect the sound signal properly.
- Changing from AUX to another source while QP Link works will deactivate QP Link temporarily. In this case, the following reactivates QP Link:
 - Pressing QP LINK on the remote control twice.
 - Unplug the component from the AUX jack, then plug it in again.
- If you press ⏻/I (Standby/on) to turn the System off or if preset Timer turns the System off while QP Link works, the System will deactivate QP Link temporarily. In such cases, the following reactivates QP Link:
 - When the sound signal from the AUX jack stops or is too weak for about 30 seconds after the System is turned off.
 - When you turn on the power again.
- QP Link may start working when you just plug in the component to the AUX jack or unplug it. This is not a malfunction.

Daily Operations—Sound & Other Adjustments (see pages 12 to 15)

Adjusting the Sound:

- This function also affects the sound through the headphones.

Changing the Scanning Mode (for UX-G60 only):

- You cannot change the scanning mode to progressive in the following cases:
 - When your TV does not support the progressive video input.
 - When you have not connected your TV to the system using a component video cord.

Setting the Clock:

- “0:00” will flash on the display until you set the clock.
- The clock may gain or lose 1 to 2 minutes per month. If this happens, reset the clock.

Unique DVD/VCD Operations (see pages 16 to 18)

Selecting the Audio Track:

- On some DVD Video discs, you cannot change audio languages while playing back.

Special Effect Playback:

- During slow-motion playback, no sound will be reproduced.
- While zoomed in, the picture may look coarse.

Advanced Playback Operations (see pages 19 to 25)

Programming the Playing Order—Program Play:

- While programming steps...
Your entry will be ignored if you have tried to program an item number that does not exist (for example, selecting track 14 on a disc that only has 12 tracks).

Playing Repeatedly:

- A-B Repeat can be used within the same title while playing a DVD Video, and within the same track for the other discs.

On-screen Disc Operations:

- For DVD-R/-RW in the VR format, “PG” or “PL” appears instead of “TITLE” on the on-screen bar.

Audio/Video File Operations (see pages 26 and 27)

Operations on the Control Screen:

- If you press ON SCREEN on the remote control during playback, playback information appears on the TV screen.

Advanced Tape Operations (see pages 28 and 29)

Recording on a Tape:

- The recording level is automatically set correctly. Thus, you can adjust the sound you are actually listening to without affecting the recording level.

- There is leader tape which cannot be recorded onto at the start and end of cassette tapes. Thus, when recording CDs or radio broadcasts, wind the leader tape first to ensure that the recording will be made without any music part lost.
- If you start recording with no cassette inserted, “NO REC” appears on the display. If a protected tape has been inserted, “NO REC” appears.
- You cannot open or close the disc tray while recording a disc.

Synchronized Recording:

- Synchronized recording does not function on the file format of MPEG-1, MPEG-2, ASF*, and DivX.

Enjoying Karaoke (for UX-G60 only) (see pages 30 to 32) (Not available in the Australian model)

Singing Along (Karaoke):

- Karaoke mode setting (Key Control and Vocal Masking) can be used when selecting “DVD/CD” or “USB MEMORY” as the source, except for DVD-VR/DVD Audio/MPEG-1/MPEG-2/ASF/DivX files. Even if the source is “DVD/CD” or “USB MEMORY,” Karaoke mode setting cannot be used while “NO DISC” or “NO DEVICE” appears on the display.
- Karaoke mode setting is automatically canceled when the source is changed.
- When selecting “DVD/CD” or “USB MEMORY” as the source, the microphone is not available while playback is stopped or paused. To use the microphone, activate Key Control or Vocal Masking.
- Karaoke mode setting is also applied to the optical digital output signals.
- When Vocal Masking is activated, 3D Phonic will be canceled temporarily.
- On some music discs, Vocal Masking does not provide the correct effect.
- You can also use the microphone when selecting “FM,” “AM,” or “AUX” as the source. When selecting “TAPE” as the source, you can use the microphone only during tape playback.

Timer Operations (see pages 33 and 34)

Setting the Timer:

- If you do not specify the preset station or track number correctly while setting a timer, the currently selected station or the first track will be played when the timer is activated.
- When you unplug the AC power cord or if a power failure occurs, the timer will be canceled. You need to set the clock first, then the timer again.
- If you set DVD Video as the source, Daily Timer will not work correctly.

Timer Priority:

- If you set the Sleep Timer after Daily Timer starts playing the selected source, Daily Timer is canceled.

* For UX-G60 only

Setup Menu Operations (see pages 35 and 36)

General:

- If the upper and lower parts of the menu are cut off, adjust the picture size control of the TV.

LANGUAGE menu:

- When the language you have selected for MENU LANGUAGE, AUDIO LANGUAGE, or SUBTITLE is not recorded on a disc, the original language is used as the initial language.

PICTURE menu—MONITOR TYPE:

- Even if “4:3 PS/4:3 MULTI PS” is selected, the screen size may become 4:3 letter box while playing a disc. This depends on how the discs are recorded.
- When you select “16:9/16:9 MULTI” for a picture whose aspect ratio is 4:3, the picture slightly changes due to the process for converting the picture width.

OTHERS menu—ON SCREEN GUIDE:

- The setup menu and on-screen bar will be displayed (and recorded) even though this function is set to “OFF.” Subtitles and the information for zoom-in always appear on the display regardless of this setting.

Maintenance

To get the best performance of the System, keep your discs, tapes and mechanism clean.

Handling discs

- Remove the disc from its case by holding it at the edge while pressing the center hole lightly.
- Do not touch the shiny surface of the disc, or bend the disc.
- Put the disc back in its case after use to prevent warping.
- Be careful not to scratch the surface of the disc when placing it back in its case.
- Avoid exposure to direct sunlight, extreme temperature, and moisture.

To clean the disc:

Wipe the disc with a soft cloth in a straight line from center to edge.

Handling cassette tapes

- If the tape is loose in its cassette, take up the slack by inserting a pencil in one of the reels and rotate it.
 - If the tape is loose, it may get stretched, cut, or caught in the cassette.
- Be careful not to touch the tape surface.
- Avoid the following places to store the tape—in dusty places, in direct sunlight or heat, in moist areas, on a TV or speaker, or near a magnet.

To keep the best recording and playback sound quality:

- Use a cotton swab moistened with alcohol to clean the heads, capstans, and pinch rollers.
- Use a head demagnetizer (available at electronics and audio shops) to demagnetize the heads (when the System turned off).

Cleaning the System

- Stains should be wiped off with a soft cloth. If the System is heavily stained, wipe it with a cloth soaked in water-diluted neutral detergent and wrung well, then wipe clean with a dry cloth.
- Since the System may deteriorate in quality, become damaged or get its paint peeled off, be careful about the following:
 - DO NOT wipe it with a hard cloth.
 - DO NOT wipe it forcefully.
 - DO NOT wipe it with thinner or benzine.
 - DO NOT apply any volatile substance such as insecticides to it.
 - DO NOT allow any rubber or plastic to remain in contact for a long time.

To remove the speaker grilles (for UX-G60 only):

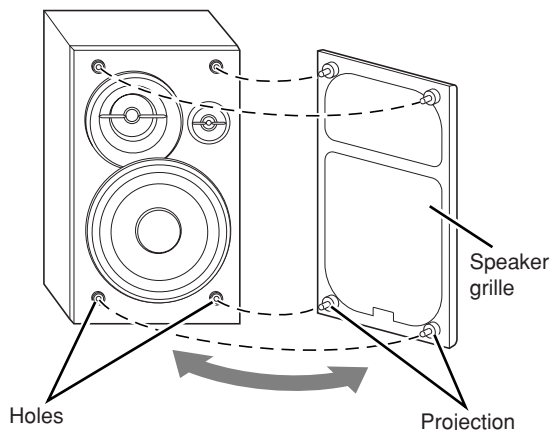

Troubleshooting

General:

Adjustments or settings are suddenly canceled before you finish.

⇒ There is a time limit. Repeat procedure again.

Operations are disabled.

⇒ The built-in microprocessor may malfunction due to external electrical interference. Unplug the AC power cord and then plug it back in.

Unable to operate the System from the remote control.

⇒ The path between the remote control and the remote sensor on the System is blocked.

⇒ The batteries are exhausted.

No sound is heard.

⇒ Speaker connections are incorrect or loose.

⇒ Headphones are connected.

No picture appears on the screen.

⇒ The video cord connections are incorrect or loose.

No picture is displayed on the TV screen, the picture is blurred, or the picture is divided into two parts.

⇒ The System is connected to a TV which does not support progressive video input.

The left and right edges of the picture are missing on the screen.

⇒ Select "4:3 LB" for "MONITOR TYPE" (see page 35).

Radio Operations:

Hard to hear broadcasts because of noise.

⇒ Antennas connections are incorrect or loose.

⇒ The AM loop antenna is too close to the System.

⇒ The FM antenna is not properly extended and positioned.

Disc/File Playback Operations:

The disc does not play.

⇒ You have inserted a disc whose Region Code is not correct. ("RG ERROR" appears on the display.)

⇒ The disc is placed upside down. Place the disc with the label side up.

ID3 Tag on an MP3 or WMA* file cannot be shown.

⇒ There are two types of ID3 Tag—Version 1 and Version 2. This System can only show ID3 Tag Version 1.

Groups and tracks are not played back as you expect.

⇒ The playing order is determined when the groups and tracks were recorded. It depends on the writing application.

MP3, WMA*, JPEG, MPEG-1, MPEG-2, ASF* or DivX files are not played back.

⇒ The disc or the USB mass storage class device* may include both type of tracks (MP3 or WMA* files and JPEG files). In this case, you can only playback the files selected by the "FILE TYPE" setting (see page 35).

⇒ You have changed the "FILE TYPE" setting after the System read the disc or the USB mass storage class device*. In this case, reload the disc or disconnect the USB mass storage class device* and connect it again.

"NO AUDIO" appears.*

⇒ This System cannot playback illegally produced DVD Audio discs.

"LR ONLY" appears.*

⇒ Some DVD Audio discs prohibit downmixed output.

When you playback such a disc, this System plays back the left front and right front signals only.

The disc sound is discontinuous.

⇒ The disc is scratched or dirty.

No subtitle appears on the display though you have selected the initial subtitle language.

⇒ Some DVDs are programmed to always display no subtitle initially. If this happens, press SUBTITLE after starting playback (see page 17).

Audio language is different from the one you have selected as the initial audio language.

⇒ Some DVDs are programmed to always use the original language initially. If this happens, press AUDIO/MPX after starting playback (see page 16).

The disc tray does not open or close.

⇒ The AC power cord is not plugged in.

⇒ Child Lock is in use. "LOCKED" appears in the display window (see page 21).

Tape Operations:

The cassette holder cannot be opened.

⇒ Power supply from the AC power cord has been cut off while the tape was running. Turn on the System.

QP Link Operations:

The System automatically turns on even if the Timer turn the System to standby or if you turn the System to standby while playback is going on the portable audio device.

⇒ In this case, deactivate QP Link or stop playback on the device connected to the AUX jack.

Recordings:

Impossible to record.

⇒ Small tabs on the back of the cassette are removed. Cover the holes with adhesive tape.

Timer Operations:

Daily Timer does not work.

⇒ The System has been turned on when the on-time comes. Timer starts working only when the System is turned off.

Daily Timer does not start playback.

⇒ The disc loaded is a DVD Video. Change the disc.

⇒ Title/group number and chapter/track number are not entered while setting the Daily Timer. Do not skip these steps when you want to play a disc using Daily Timer.

* For UX-G60 only

Language Code List

AA	Afar
AB	Abkhazian
AF	Afrikaans
AM	Ameharic
AR	Arabic
AS	Assamese
AY	Aymara
AZ	Azerbaijani
BA	Bashkir
BE	Byelorussian
BG	Bulgarian
BH	Bihari
BI	Bislama
BN	Bengali, Bangla
BO	Tibetan
BR	Breton
CA	Catalan
CO	Corsican
CS	Czech
CY	Welsh
DA	Danish
DZ	Bhutani
EL	Greek
EO	Esperanto
ET	Estonian
EU	Basque
FA	Persian
FI	Finnish
FJ	Fiji
FO	Faroese
FY	Frisian
GA	Irish
GD	Scots Gaelic
GL	Galician
GN	Guarani
GU	Gujarati
HA	Hausa
HI	Hindi
HR	Croatian
HU	Hungarian
HY	Armenian
IA	Interlingua
IE	Interlingue
IK	Inupiak
IN	Indonesian
IS	Icelandic
IW	Hebrew
JI	Yiddish

JW	Javanese
KA	Georgian
KK	Kazakh
KL	Greenlandic
KM	Cambodian
KN	Kannada
KO	Korean (KOR)
KS	Kashmiri
KU	Kurdish
KY	Kirghiz
LA	Latin
LN	Lingala
LO	Laothian
LT	Lithuanian
LV	Latvian, Lettish
MG	Malagasy
MI	Maori
MK	Macedonian
ML	Malayalam
MN	Mongolian
MO	Moldavian
MR	Marathi
MS	Malay (MAY)
MT	Maltese
MY	Burmese
NA	Nauru
NE	Nepali
NL	Dutch
NO	Norwegian
OC	Occitan
OM	(Afan) Oromo
OR	Oriya
PA	Panjabi
PL	Polish
PS	Pashto, Pushto
PT	Portuguese
QU	Quechua
RM	Rhaeto-Romance
RN	Kirundi
RO	Rumanian
RW	Kinyarwanda
SA	Sanskrit
SD	Sindhi
SG	Sangho
SH	Serbo-Croatian
SI	Singhalese
SK	Slovak
SL	Slovenian

SM	Samoan
SN	Shona
SO	Somali
SQ	Albanian
SR	Serbian
SS	Siswati
ST	Sesotho
SU	Sundanese
SV	Swedish
SW	Swahili
TA	Tamil
TE	Telugu
TG	Tajik
TH	Thai
TI	Tigrinya
TK	Turkmen
TL	Tagalog
TN	Setswana
TO	Tonga
TR	Turkish
TS	Tsonga
TT	Tatar
TW	Twi
UK	Ukrainian
UR	Urdu
UZ	Uzbek
VI	Vietnamese
VO	Volapuk
WO	Wolof
XH	Xhosa
YO	Yoruba
ZU	Zulu

OPTICAL DIGITAL OUT Signals

DIGITAL AUDIO OUTPUT Playback disc/file	Output Signals		
	STREAM/PCM	DOLBY DIGITAL/PCM	PCM ONLY
DVD Video			
with 48 kHz, 16/20/24 bit Linear PCM	48 kHz, 16 bit Linear PCM* ²		
with 96 kHz, Linear PCM	48 kHz, 16 bit Linear PCM		
with Dolby Digital	Dolby Digital bitstream		48 kHz, 16 bit Linear PCM
with DTS	DTS bitstream	48 kHz, 16 bit Linear PCM	
DVD Audio*¹			
with 48/96/192 kHz, 16/20/24 bit Linear PCM	48 kHz, 16 bit Linear PCM		
with 44.1/88.2/176.4 kHz, 16/20/24 bit Linear PCM	44.1 kHz, 16 bit Linear PCM		
with Dolby Digital	Dolby Digital bitstream		48 kHz, 16 bit Linear PCM
with DTS	DTS bitstream	48 kHz, 16 bit Linear PCM	
DVD-R/-RW/-ROM in DVD-VR format			
with 48 kHz, 16/20/24 bit Linear PCM	48 kHz, 16 bit Linear PCM* ²		
with Dolby Digital	Dolby Digital bitstream		48 kHz, 16 bit Linear PCM
SVCD, VCD, CD	44.1 kHz, 16 bit Linear PCM/48 kHz, 16 bit Linear PCM		
CD with DTS	DTS bitstream	44.1 kHz, 16 bit Linear PCM	
MP3/WMA*¹/DivX disc/file	32/44.1/48 kHz, 16 bit Linear PCM		
ASF*¹ disc/file	32 kHz, 16 bit Linear PCM		

*¹ For UX-G60 only

*² While playing some DVDs, digital signals may be emitted at 20 bits or 24 bits (at their original bit rate) through the OPTICAL DIGITAL OUT terminal if the discs are not copy-protected.

Operating JVC's TVs Using the Remote Control

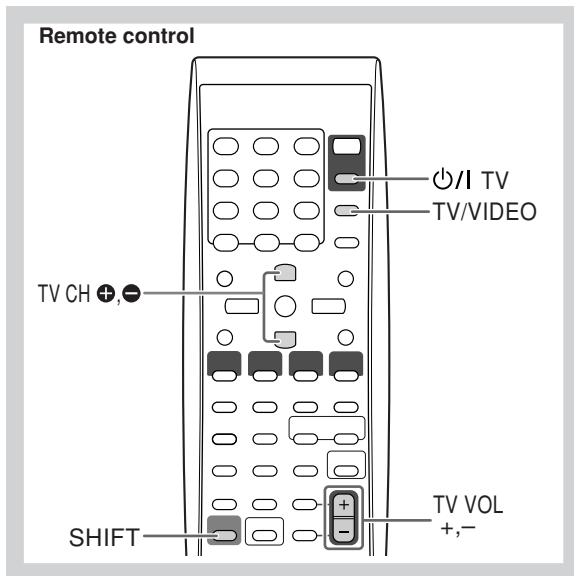

You can use the remote control to operate JVC's TVs.

P/I TV	Turn on/off TV.
TV/VIDEO	Change the input mode.

While holding SHIFT, press...

TV VOL +, -	Adjust the volume.
TV CH +, -	Change the channels.

Specifications

Amplifier section

CA-UXG60 (for UX-G60)/CA-UXG55 (for UX-G55)

Output Power:

CA-UXG60: 120 W (60 W + 60 W) at 6 Ω (10% THD)

CA-UXG55: 50 W (25 W + 25 W) at 6 Ω (10% THD)

Audio Input AUX: 500 mV/50 kΩ (at "AUX LVL1")
250 mV/50 kΩ (at "AUX LVL2")
125 mV/50 kΩ (at "AUX LVL3")

Digital output: OPTICAL DIGITAL OUT:
-21 dBm to -15 dBm (660 nm ±30 nm)

Digital input: USB MEMORY (for CA-UXG60 only)

Video Out:

Color system: NTSC or PAL (interlaced/progressive*)

VIDEO (composite): 1 V(p-p)/75 Ω

S-VIDEO: Y (luminance) 1 V(p-p)/75 Ω

C (chrominance, burst)

NTSC 0.286 V(p-p)/75 Ω

PAL 0.3 V(p-p)/75 Ω

COMPONENT: (Y) 1 V(p-p)/75 Ω

(PB/PR) 0.7 V(p-p)/75 Ω

6 Ω – 16 Ω

Speaker impedance:

Tuner section

FM tuning range: 87.50 MHz – 108.00 MHz

AM (MW) tuning range:

531 kHz – 1 710 kHz (at 9 kHz intervals)

530 kHz – 1 710 kHz (at 10 kHz intervals)

For Saudi Arabia only:

531 kHz – 1 602 kHz (at 9 kHz intervals)

530 kHz – 1 600 kHz (at 10 kHz intervals)

Tape section

Frequency response: 60 Hz – 14 000 Hz

Wow and flutter: 0.15 % (WRMS)

Disc/file player section

Region codes:

Middle East: 2

South East Asia, Hong Kong region: 3

Central and South America, Australia: 4

Playable disc:

DVD Video/DVD Audio*/CD/VCD/SVCD/CD-R/CD-RW (CD/SVCD/VCD/MP3/WMA*/JPEG/MPEG-1/MPEG-2/ASF*/DivX format)

DVD-R/-RW (DVD-VR/DVD Video/MP3/WMA*/JPEG/MPEG-1/MPEG-2/ASF*/DivX format)

+R/+RW (DVD-Video format)

DVD-ROM (DVD Video/DivX format)

Playable file:

MP3/WMA*/JPEG/MPEG-1/MPEG-2/ASF*/DivX format

Dynamic range: 80 dB

Horizontal resolution: 500 lines

Wow and flutter: Immeasurable

General

Power requirement:

AC 110 V/AC 127V/AC 220 V/AC 230 V-240V ~
(adjustable with the voltage selector), 50 Hz/60 Hz

For Hong kong: AC 220 V ~, 50 Hz

For Oceanian countries: AC 240 V ~, 50 Hz

Power consumption (UX-G60/UX-G55):

125 W/65 W (at operation)

14 W/11 W (at standby)

3.5 W/3.5 W (at standby dimmer OFF mode)

Dimensions (approx.): 170 mm x 250 mm x 342 mm
(W/H/D)

Mass (approx.): UX-G60: 5.7 kg/UX-G55: 4.7 kg

Speaker section

SP-UXG63 (for UX-G60)

Speaker units: Tweeter: 1.5 cm dome x 1
Squawker: 4 cm cone x 1
Woofers: 13.5 cm cone x 1

Impedance: 6 Ω

Dimensions (approx.): 166 mm x 250 mm x 232 mm
(W/H/D)

Mass (approx.): 2.8 kg each

SP-UXG55 (for UX-G55)

Speaker units: 10 cm cone x 1

Impedance: 6 Ω

Dimensions (approx.): 145 mm x 250 mm x 200 mm
(W/H/D)

Mass (approx.): 2 kg each

Supplied Accessories

See page 3.

Design and specifications are subject to change without notice.

- Manufactured under license from Dolby Laboratories. "Dolby", "Pro Logic", "MLP lossless", and the double-D symbol are trademarks of Dolby Laboratories.
 - "DTS" and "DTS 2.0+ Digital Out" are trademarks of Digital Theater Systems, Inc.
 - "Official DivX[®] Certified product" "Plays all versions of DivX[®] video (including DivX[®] 6) with standard playback of DivX[®] media files" "DivX, DivX certified, and associated logos are trademarks of DivX, Inc. and are used under licence."
 - "Official DivX[®] Ultra Certified product" "Plays all versions of DivX[®] video (including DivX[®] 6) with enhanced playback of DivX[®] media files and the DivX[®] Media Format" "DivX, DivX Ultra Certified, and associated logos are trademarks of DivX, Inc. and are used under licence."
 - USE OF THIS PRODUCT IN ANY MANNER THAT COMPLIES WITH THE MPEG-4 VISUAL STANDARD IS PROHIBITED, EXCEPT FOR USE BY A CONSUMER ENGAGING IN PERSONAL AND NON-COMMERCIAL ACTIVITIES.
 - This product incorporates copyright protection technology that is protected by U.S. patents and other intellectual property rights. Use of this copyright protection technology must be authorized by Macrovision, and is intended for home and other limited viewing uses only unless otherwise authorized by Macrovision. Reverse engineering or disassembly is prohibited.
- "CONSUMERS SHOULD NOTE THAT NOT ALL HIGH DEFINITION TELEVISION SETS ARE FULLY COMPATIBLE WITH THIS PRODUCT AND MAY CAUSE ARTIFACTS TO BE DISPLAYED IN THE PICTURE. IN CASE OF 525 OR 625 PROGRESSIVE SCAN PICTURE PROBLEMS, IT IS RECOMMENDED THAT THE USER SWITCH THE CONNECTION TO THE 'STANDARD DEFINITION' OUTPUT. IF THERE ARE QUESTIONS REGARDING OUR TV SET COMPATIBILITY WITH THIS MODEL 525p AND 625p DVD PLAYER, PLEASE CONTACT OUR CUSTOMER SERVICE CENTER."

* For UX-G60 only

Parts Index

Remote control

Button	Page
Ⓞ/Ⓜ AUDIO	25 7
Ⓞ/Ⓜ TV	26 43
■	15 10, 11, 18, 20, 27, 28, 29
▶▶, ◀◀	17 9, 10
▶▶, ◀◀	38 9, 10, 11, 20, 27
■	16 10, 18, 20, 27, 29
∧, ∨, >, <, ENTER/SET	11 9, 11, 14, 15, 18, 23, 25, 27, 33, 34, 35
↶ (One-Touch Replay)	36 18
3D PHONIC	5 13
AHB PRO	20 12
ANGLE	7 17
AUDIO/MPX	19 16, 30
AUDIO VOL +, -	41 7, 13
AUX (UX-G55)	35 7, 10
A.STANDBY	24 15
BASS/TREBLE	43 13
C.VOICE	4 18
CANCEL	9 20, 34
CLOCK/TIMER	27 15, 33, 34
DIMMER	3 14
DISPLAY	30 15
DVD/AUX LEVEL	21 13
DVD/CD ▶	14 7, 10, 27
ECHO (UX-G60)*	32 31
FADE MUTING	42 12
FM/PLAY MODE	39 8, 19, 20
FM/AM (UX-G55)	13 7, 8, 28
FM/AM/AUX (UX-G60)	35 7, 8, 28
GROUP/TITLE	37 10, 27
GROUP/TITLE SKIP	38 10
KARAOKE (UX-G60)*	33 31
KEY ♭, # (UX-G60)*	11 31
MENU/PL	32 11, 25
NTSC/PAL (UX-G55)	29 14
Number buttons	1 9, 11, 18, 19, 24, 25
ON SCREEN	33 23
PAGE (UX-G60)	18 17
QP LINK	20 11
REPEAT	40 21
REPEAT A-B	40 21
RESERVE (UX-G60)*	12 32
RETURN	8 11
SCAN MODE (UX-G60)	29 14
SET UP	12 35
SHIFT	22 10, 11, 13, 14, 15, 17, 18, 21, 27, 31, 32, 33, 34, 43
SLEEP	2 15
SLOW ⊕, ⊖	17 18
SOUND TURBO II	23 12
SUBTITLE	18 17
TAPE	34 7
TOP MENU/PG	10 11, 25
TV CH ⊕, ⊖	11 43
TV VOL +, -	41 43
TV/VIDEO	28 43
USB MEMORY ▶/■ (UX-G60)	13 7, 10, 27, 28, 29, 31
VFP	31 14
ZOOM	6 18, 27

Main unit

Button	Page
Ⓞ/Ⓜ & STANDBY lamp	(8) 7
■	(10) 10, 21
▲	(19) 10, 21
3D-PHONIC	(17) 13
AUX (UX-G55)	(14) 7
AUX jack	(21) 5
Cassette holder	(13) 9, 28
Display	(3) 6
DISPLAY	(6) 15
DVD/CD ▶/■	(5) 7, 10, 27, 28, 29, 31
FM/AM (UX-G55)	(4) 7, 8, 28
FM/AM/AUX (UX-G60)	(14) 7, 8, 28
MIC jack (UX-G60)*	(1) 30, 31
MIC VOLUME (UX-G60)*	(12) 30, 31

PHONES	(11) 7
REC	(16) 28, 29, 30
Remote sensor	(2) 5
SOUND TURBO II	(7) 12
TAPE	(15) 10
▶▶ UP, DOWN ◀◀	(9/20) 8, 20
USB MEMORY jack (UX-G60)	(22) 5
USB MEMORY ▶/■ (UX-G60)	(3) 7, 10, 27, 28, 29, 31
VOLUME +, -	(18) 12, 30, 31

Remote control

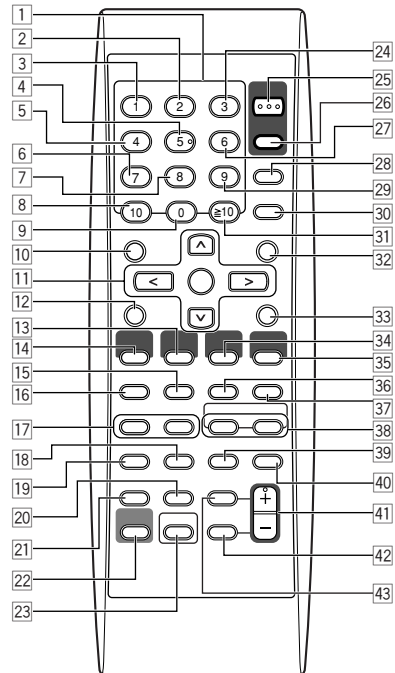

This remote control can also operate JVC's TVs (see page 43).

Main unit

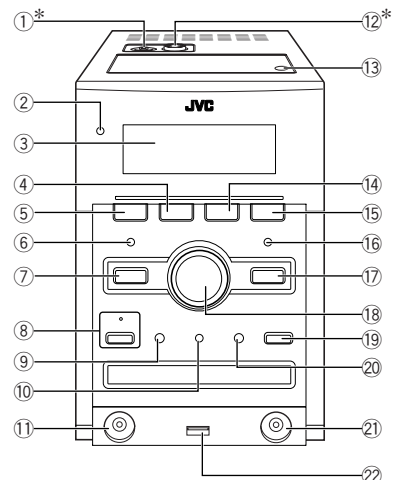

The illustration above is UX-G60.

* Not on the Australian model.

Mains (AC) Line Instruction (not applicable for Europe, U.S.A., Canada, Australia, and U.K.)

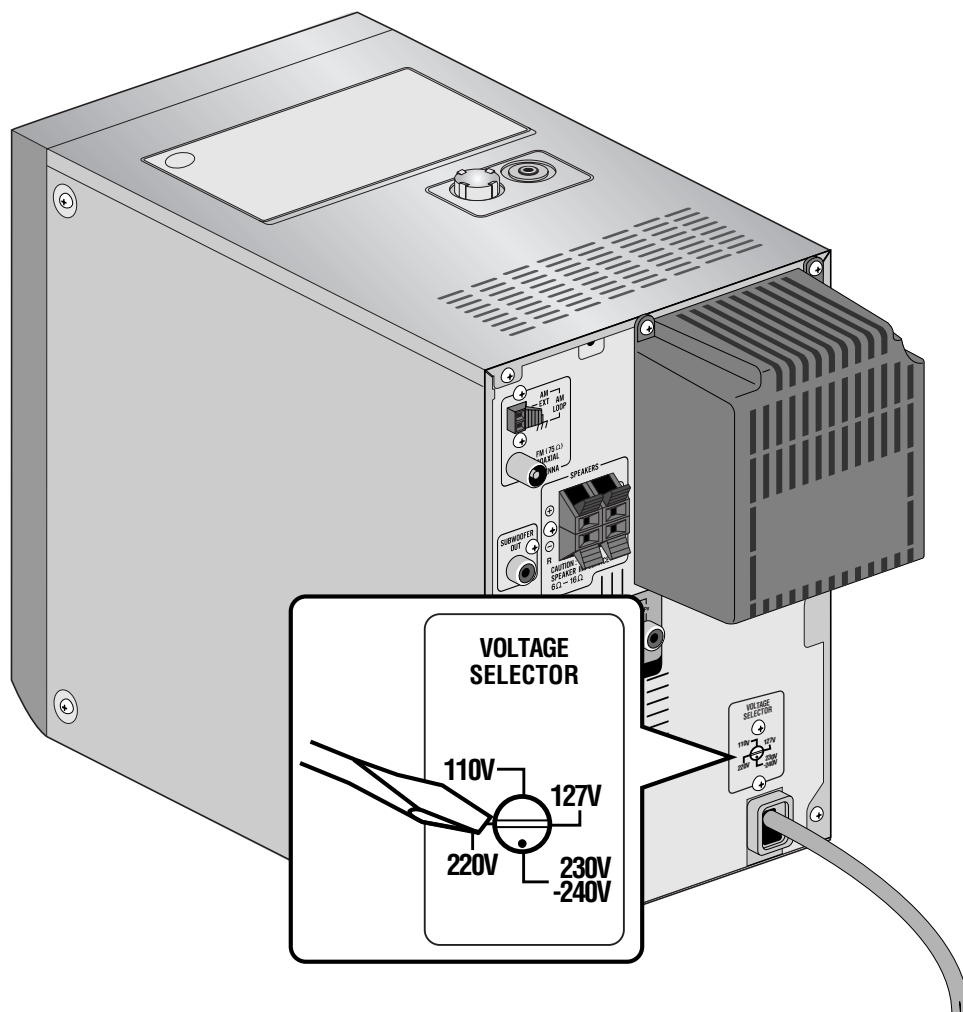

The illustration above is UX-G60 (except for Hong Kong region and Australia).

CAUTION for mains (AC) line
BEFORE PLUGGING IN, do check that your mains (AC) line voltage corresponds with the position of the voltage selector switch provided on the outside of this equipment and, if different, reset the voltage selector switch, to prevent from a damage or risk of fire/electric shock.

JVC

Free Manuals Download Website

<http://myh66.com>

<http://usermanuals.us>

<http://www.somanuals.com>

<http://www.4manuals.cc>

<http://www.manual-lib.com>

<http://www.404manual.com>

<http://www.luxmanual.com>

<http://aubethermostatmanual.com>

Golf course search by state

<http://golfingnear.com>

Email search by domain

<http://emailbydomain.com>

Auto manuals search

<http://auto.somanuals.com>

TV manuals search

<http://tv.somanuals.com>