

JVC



MICRO COMPONENT SYSTEM

UX-G66R

Consists of AX-UXG66, XT-UXG66R,
TD-UXG66, and SP-UXG66.

STEREO AMPLIFIER

AX-UXG66

COMPACT DISC/TUNER

XT-UXG66R

CASSETTE DECK

TD-UXG66

SPEAKER SYSTEM

SP-UXG66



COMPACT
disc
DIGITAL AUDIO



INSTRUCTIONS

For Customer Use:

Enter below the Model No. and Serial No. which are located either on the rear, bottom or side of the cabinet. Retain this information for future reference.

Model No. _____

Serial No. _____

LVT0705-003A

[B]

Warnings, Cautions and Others

Caution — switch!

Disconnect the mains plug to shut the power off completely (the STANDBY/ON lamp goes off).

The  switch in any position does not disconnect the mains line.

- When the unit is on standby, the STANDBY/ON lamp lights red.
- When the unit is turned on, the STANDBY/ON lamp lights green.

The power can be remote controlled.

CAUTION

To reduce the risk of electrical shocks, fire, etc.:

1. Do not remove screws, covers or cabinet.
2. Do not expose this appliance to rain or moisture.

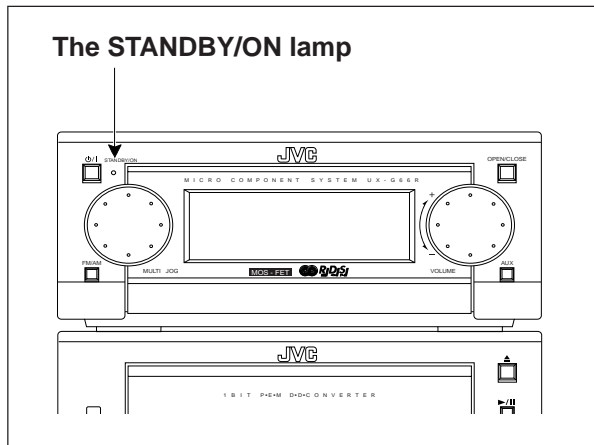

Caution: Proper Ventilation

To avoid risk of electric shock and fire, and to prevent damage, locate the apparatus as follows:

1 Front:

No obstructions and open spacing.

2 Sides/ Top/ Back:

No obstructions should be placed in the areas shown by the dimensions below.

3 Bottom:

Place on the level surface. Maintain an adequate air path for ventilation by placing on a stand with a height of 10 cm or more.

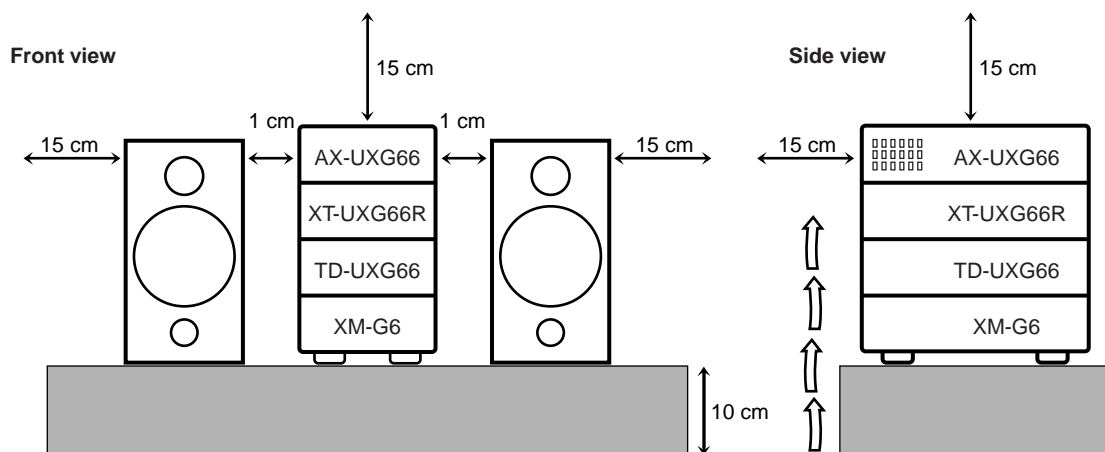

IMPORTANT FOR LASER PRODUCTS

REPRODUCTION OF LABELS

① CLASSIFICATION LABEL, PLACED ON EXTERIOR SURFACE

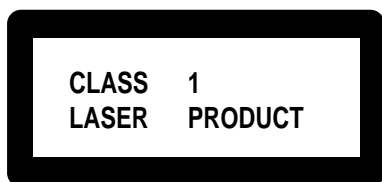

② WARNING LABEL, PLACED INSIDE THE UNIT

DANGER: Invisible laser radiation when open and interlock failed or defeated. AVOID DIRECT EXPOSURE TO BEAM. (e)

WARNING: Osynlig laserstrålning när denna del är öppnad och spärren är urkopplad. Betrakta ej strålen. (s)

ADVARSEL: Usynlig laserstrålning ved åbning, når sikkerhedsafbrydere er ude af funktion. Undgå udsættelse for stråling (d)

VARO: Avattaessa ja suo- jalukitus ohitettaessa olet alltiina näkymättömälle lasersäteilylle. Älä katso säteeseen. (f)

1. CLASS 1 LASER PRODUCT
2. **DANGER:** Invisible laser radiation when open and interlock failed or defeated. Avoid direct exposure to beam.
3. **CAUTION:** Do not open the top cover. There are no user serviceable parts inside the Unit; leave all servicing to qualified service personnel.

CAUTION

- Do not block the ventilation openings or holes. (If the ventilation openings or holes are blocked by a newspaper or cloth, etc., the heat may not be able to get out.)
- Do not place any naked flame sources, such as lighted candles, on the apparatus.
- When discarding batteries, environmental problems must be considered and local rules or laws governing the disposal of these batteries must be followed strictly.
- Do not use this apparatus in a bathroom or places with water. Also do not place any containers filled with water or liquids (such as cosmetics or medicines, flower vases, potted plants, cups, etc.) on top of this apparatus.

IMPORTANT for the U.K.

DO NOT cut off the mains plug from this equipment. If the plug fitted is not suitable for the power points in your home or the cable is too short to reach a power point, then obtain an appropriate safety approved extension lead or consult your dealer.

BE SURE to replace the fuse only with an identical approved type, as originally fitted.

If nonetheless the mains plug is cut off ensure to remove the fuse and dispose of the plug immediately, to avoid a possible shock hazard by inadvertent connection to the mains supply.

If this product is not supplied fitted with a mains plug then follow the instructions given below:

IMPORTANT:

DO NOT make any connection to the terminal which is marked with the letter E or by the safety earth symbol or coloured green or green-and-yellow.

The wires in the mains lead on this product are coloured in accordance with the following code:

Blue : Neutral
Brown : Live

As these colours may not correspond with the coloured markings identifying the terminals in your plug proceed as follows:

The wire which is coloured blue must be connected to the terminal which is marked with the letter N or coloured black.

The wire which is coloured brown must be connected to the terminal which is marked with the letter L or coloured red.

IF IN DOUBT - CONSULT A COMPETENT ELECTRICIAN.

Introduction

We would like to thank you for purchasing one of our JVC products. Before operating this micro component system, read this manual carefully and thoroughly to obtain the best possible performance from your system, and retain this manual for future reference.

About This Manual

This manual is organized as follows:

- The manual mainly explains operations using the buttons and controls on the units. You can also use the buttons on the remote control if they have the same or similar names (or marks) as those on the units. If operation using the remote control is different from that using each unit, it is then explained.
- Basic and common information that is the same for many functions is grouped in one place, and is not repeated in each procedure. For instance, we do not repeat the information about turning on/off the system, setting the volume, changing the sound effects, and others, which are explained in the section “Basic Settings” and “Common Operations” on pages 10 to 13.
- The following marks are used in this manual:



Gives you warnings and cautions to prevent from a damage or risk of fire/ electric shock.

Also gives you information which is not good for obtaining the best possible performance from the units.



Gives you information and hints you had better know.

Precautions

Installation

- Install in a place which is level, dry and neither too hot nor too cold — between 5°C (41°F) and 35°C (95°F).
- Install the units in a location with adequate ventilation to prevent internal heat buildup in the units.
- Leave sufficient distance between the units and the TV.
- Keep the speakers away from the TV to avoid interference with TV.



DO NOT install the units in a location near heat sources, or in a place subject to direct sunlight, excessive dust or vibration.

Power sources

- When unplugging from the wall outlet, always pull the plug, not the AC power cord.



DO NOT handle the AC power cord with wet hands.

Moisture condensation

Moisture may condense on the lens inside the units in the following cases:

- After starting heating in the room
- In a damp room
- If the units are brought directly from a cold to a warm place

Should this occur, the system may malfunction. In this case, leave the units turned on for a few hours until the moisture evaporates, unplug the AC power cord, and then plug it in again.

Others

- Should any metallic object or liquid fall into a unit, unplug the units and consult your dealer before operating any further.
- If you are not going to operate the units for an extended period of time, unplug the AC power cord from the wall outlet.



DO NOT disassemble the units since there are no user serviceable parts inside.

If anything goes wrong, unplug the AC power cord and consult your dealer.

Contents

Introduction	1	Playing Back a Tape	24
About This Manual	1	Playing Back a Tape — Basic Operation	24
Precautions	1	Fast-Winding a Tape	25
Contents	2	Searching and Skipping to Each Program	
Location of the Buttons and Controls	3	— Music Scan	25
Front Panels	4	Playing Back Dolby-Recorded Tape	25
Remote Control	5	Recording onto a Tape	26
Getting Started	6	Manual Recording onto a Tape	26
Unpacking	6	Recording in Auto Reverse	27
Putting the Batteries into the Remote Control	6	Synchronized Recording from a CD	28
Connecting the System Control Cables and the External		Recording from the external equipment	28
Wire	6	Using the Timers	29
Connecting MD Recorder XM-G6	7	Using Recording Timer	29
Connecting Sub Woofer System	7	Using Daily Timer	30
Connecting Antennas	7	Using Sleep Timer	32
Connecting Speakers	8	Timer Priority	32
Connecting Other Equipments	9	Maintenance and Additional Information	33
Basic Settings	10	Handling CDs	33
Setting the Clock	10	Handling Cassette Tapes	34
Setting the Display Illumination (Dimmer)	10	Types of Cassette Tapes	34
Common Operations	11	Troubleshooting	35
Turning On the Power and Selecting the Sources	11	Specifications	36
Adjusting the Volume	11		
Reinforcing the Bass Sound	12		
Adjusting Bass and Treble Sounds	12		
Operating the Sliding Panel	13		
Listening to the External Equipment	13		
Listening to FM and AM Broadcasts	14		
Tuning in a Station	14		
Presetting Stations	15		
Receiving FM Stations with RDS	16		
Changing the RDS Information	16		
Searching for Programs by PTY Codes (PTY Search)	17		
Switching to a Program Type Temporarily	17		
Playing Back a CD	20		
Playing Back the Entire Disc — Normal Play	20		
Searching and Skipping Tracks	21		
Programing the Playing Order of the Tracks			
— Program Play	21		
Playing at Random — Random Play	23		
Repeating Tracks — Repeat Play	23		

Location of the Buttons and Controls

Become familiar with the buttons and controls on the units.

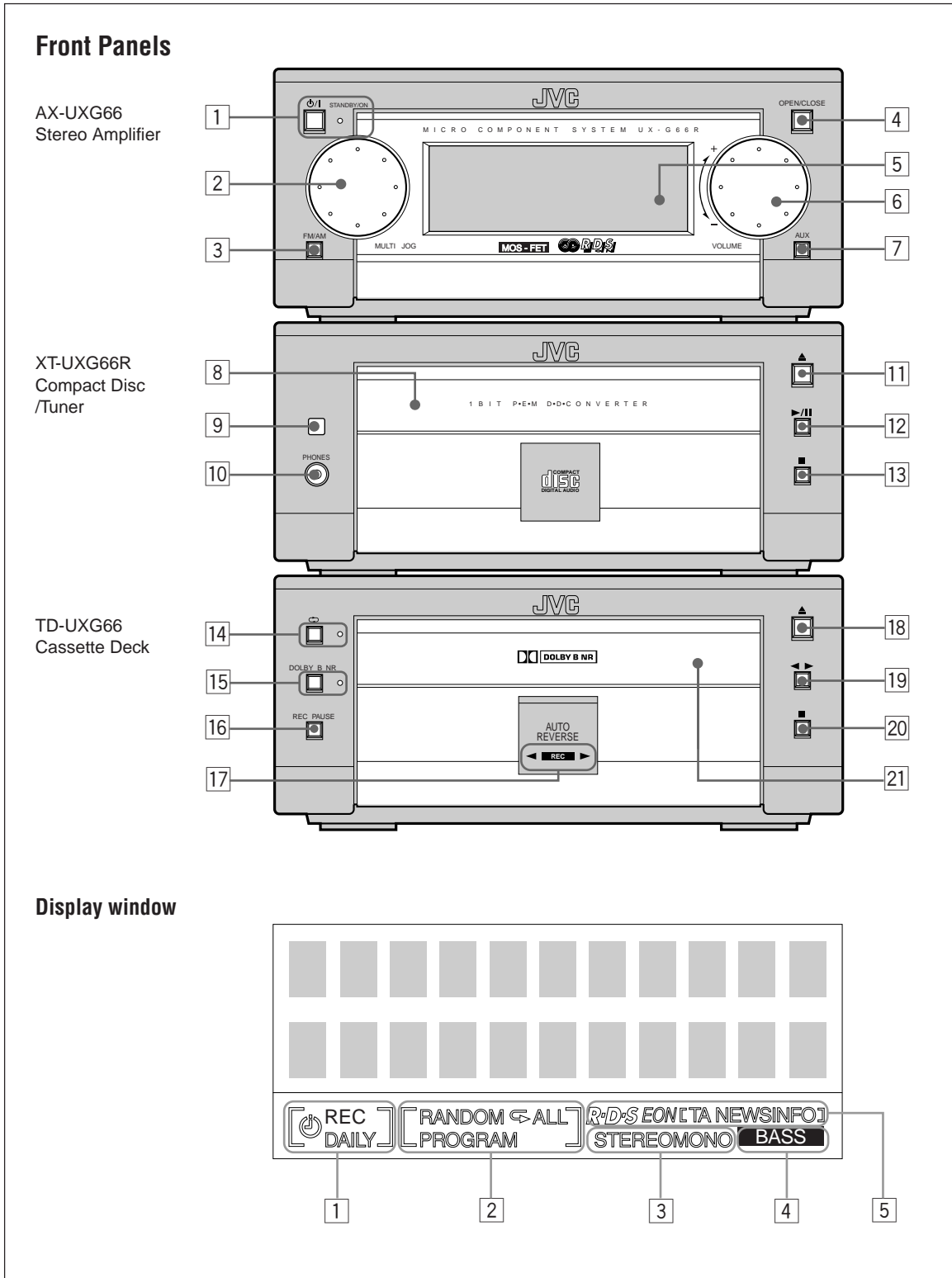

Front Panels

AX-UXG66 Stereo Amplifier

- 1 ⏻ button and STANDBY/ON lamp (11)*
- 2 MULTI JOG dial
- 3 FM/AM button (14)*
- 4 OPEN/CLOSE button (13)*
- 5 Display window
- 6 VOLUME dial (11)
- 7 AUX button (13, 28)*

XT-UXG66R Compact Disc/Tuner

- 8 CD tray
- 9 Remote sensor (5)
- 10 PHONES jack (12)
- 11 ▲ (open/close) button for CD tray (20)*
- 12 ▶/⏸ (play/pause) button (21)*
- 13 ■ (stop) button (21)

TD-UXG66 Cassette Deck

- 14 ⏪ (auto-reverse) button and lamp (24, 27)
- 15 DOLBY B NR button and lamp (25, 27)
- 16 REC PAUSE button (26)
- 17 Tape operations indicators (24, 26)
 - Tape direction (◀ / ▶) and REC indicators
- 18 ▲ (open/close) button for Tape tray (24)*
- 19 ◀▶ (playback) button (24)*
- 20 ■ (stop) button (25)
- 21 Tape tray



To press the buttons suffixed with * mark also turns on the system.

Display window

- 1 Timer mode indicators
 - ⌚ REC (recording timer) and ⌚ DAILY (daily timer) indicators
- 2 CD playback mode indicators
 - PROGRAM, RANDOM, ↺ (repeat 1), and ↻ ALL (repeat all) mode indicators
- 3 FM mode indicators
 - STEREO and MONO indicators
- 4 BASS indicator
- 5 RDS mode indicators
 - RDS, EON, and TA/NEWS/INFO indicators

Buttons behind the sliding panel

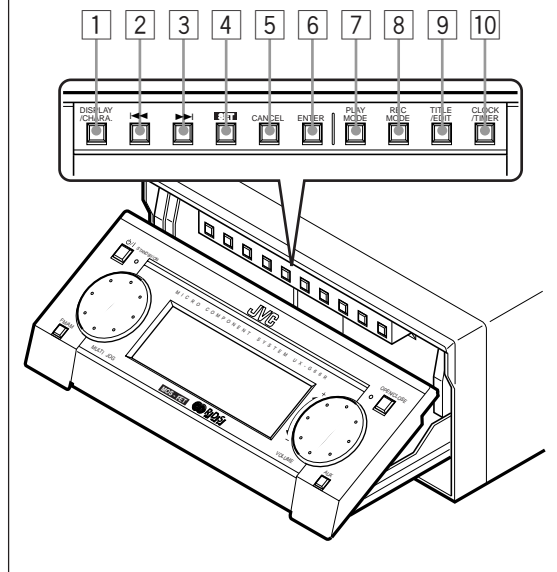

- 1 DISPLAY/CHARA. button (16)
- 2 <<< button (14, 21, 22, 25)
- 3 >>> button (14, 21, 22, 25)
- 4 SET button (22, 29)
- 5 CANCEL button (10, 22, 29)
- 6 ENTER button **
- 7 PLAY MODE button (21)
- 8 REC MODE button (28)
- 9 TITLE/EDIT button **
- 10 CLOCK/TIMER button (10, 29)

** Used only with MiniDisc recorder XM-G6 (not supplied).



- DO NOT operate any button and control until the system setup is completed.
- DO NOT operate the sliding panel by hands, otherwise it will cause serious damages on the sliding mechanism (see page 13).

Become familiar with the buttons on the remote control.

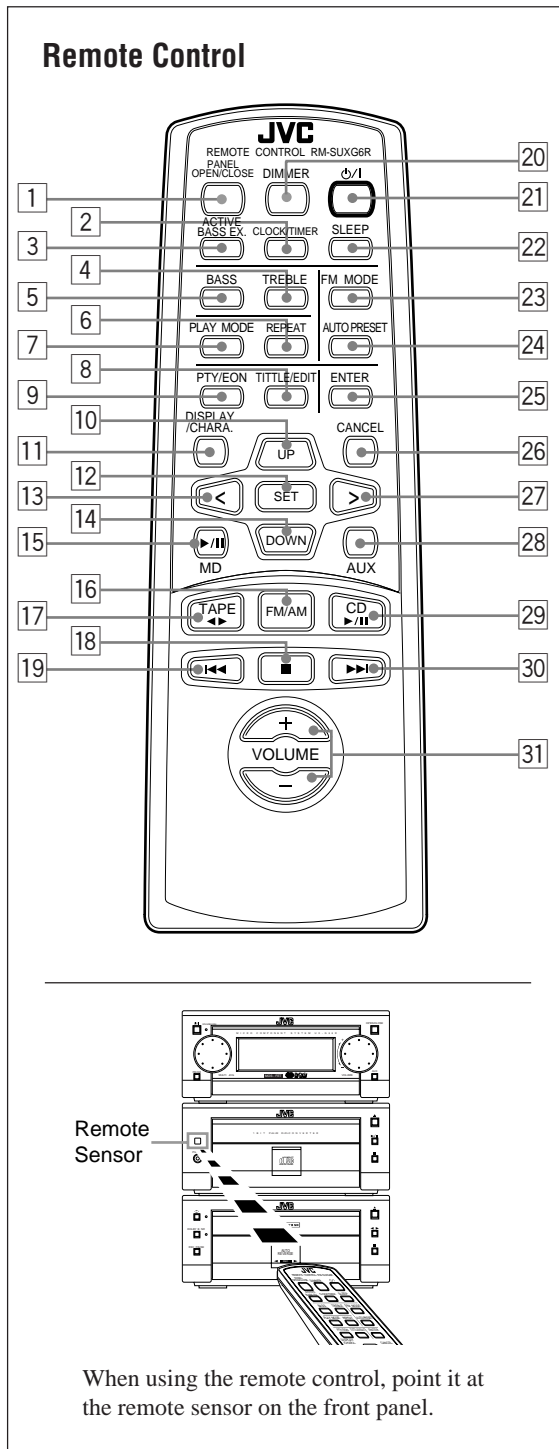

Remote Control

- 1 PANEL OPEN/CLOSE button (13)
- 2 CLOCK/TIMER button (10, 29)
- 3 ACTIVE BASS EX. (extension) button (12)
- 4 TREBLE button (12)
- 5 BASS button (12)
- 6 REPEAT button (23)
- 7 PLAY MODE button (21)
- 8 TITLE/EDIT button *
- 9 PTY/EON button (17)
- 10 UP button (12, 14, 21)
- 11 DISPLAY/CHARA. button (16)
- 12 SET button (22, 29)
- 13 < (left cursor) button (10, 21, 29)
- 14 DOWN button (12, 14, 21)
- 15 MD ►/|| (play/pause) button *
- 16 FM/AM button (14)
- 17 TAPE ◀▶ (playback) button (24)
- 18 ■ (stop) button (21, 25)
- 19 ◀◀ button (14, 21, 22, 25)
- 20 DIMMER button (10)
- 21 ◻/I (standby/on) button (11)
- 22 SLEEP button (32)
- 23 FM MODE button (15)
- 24 AUTO PRESET button (15)
- 25 ENTER button *
- 26 CANCEL button (10, 22, 29)
- 27 > (right cursor) button (10, 21, 29)
- 28 AUX button (13, 28)
- 29 CD ►/|| (play/pause) button (21)
- 30 ►►I button (14, 21, 22, 25)
- 31 VOLUME +/- button (11)

* Used only with MiniDisc recorder XM-G6 (not supplied).



To operate the system correctly using the remote control

Before using these buttons:

For Tuner operations, press FM/AM button on the remote control first.

For CD operations, press CD ►/|| (play/pause) button on the remote control first.

For Tape operations, press TAPE ◀▶ (playback) button on the remote control first.

Getting Started

Unpacking

After unpacking, check to be sure that you have all the following items.

The number in the parentheses indicates the quantity of the pieces supplied.

- AM loop antenna (1)
- FM antenna (1)
- Remote control (1)
- Batteries (2)
- Speaker cords (2)
- External wire (1)

If any is missing, consult your dealer immediately.

Putting the Batteries into the Remote Control

Insert the batteries — R6P (SUM-3)/AA (15F) — into the remote control, by matching the polarity (+ and -) on the batteries with the + and - markings on the battery compartment.

When the remote control can no longer operate the units, replace both batteries at the same time.

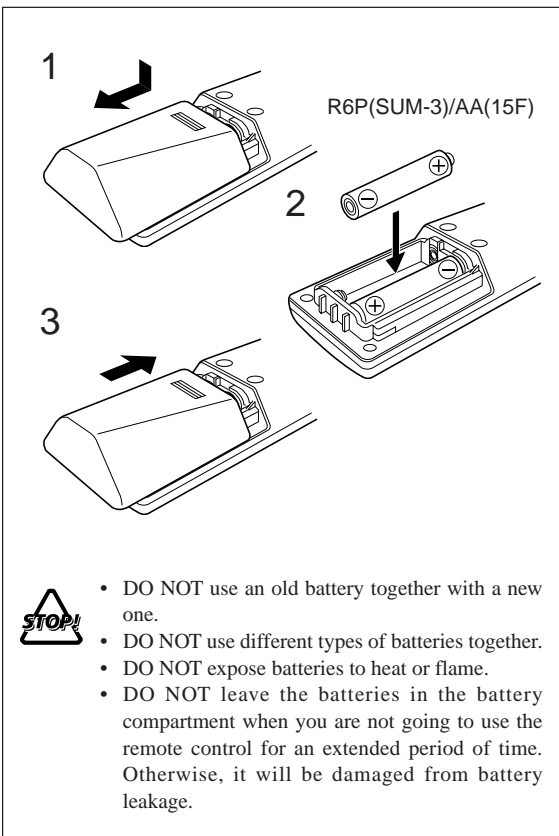

Connecting the System Control Cables and the External Wire

UX-G66R micro component system consists of three units, AX-UXG66 Stereo Amplifier, XT-UXG66R Compact Disc/Tuner, TD-UXG66 Cassette Deck, and SP-UXG66 Speaker System.

You can easily connect these units using the system control cables equipped on the rear panel of the units.

- **To prevent malfunction**, connect the external wire as illustrated.

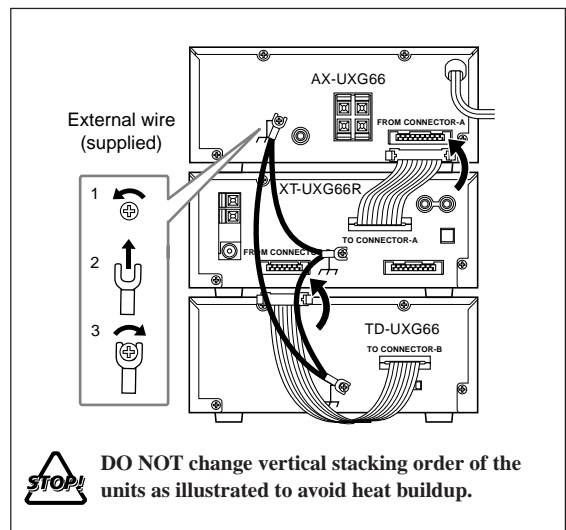

- **To connect the cables**, press the middle of the connector body until it clicks into the connector on the rear panel.
- **To disconnect**, if needed, pull the connector out pushing both sides of the connector body. Never pull out the cables themselves.

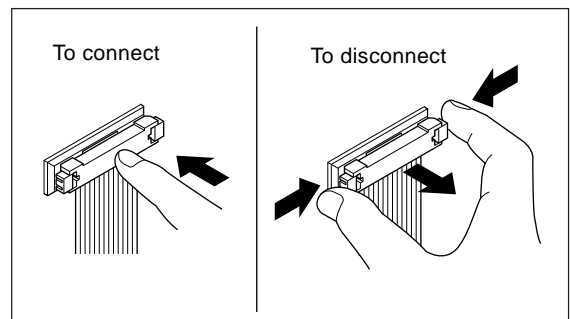

When connecting the system control cables to the connectors

Make sure to connect the cable to the connector having the same name such as "FROM CONNECTOR-A" and "TO CONNECTOR-A."

Connecting MD Recorder XM-G6

You can also connect the MD recorder XM-G6 (not supplied), specifically designed for UX-G66R. This unit will complete UX-G66R micro component system.

When you connect and use this unit, refer to the Instructions supplied with it for details.

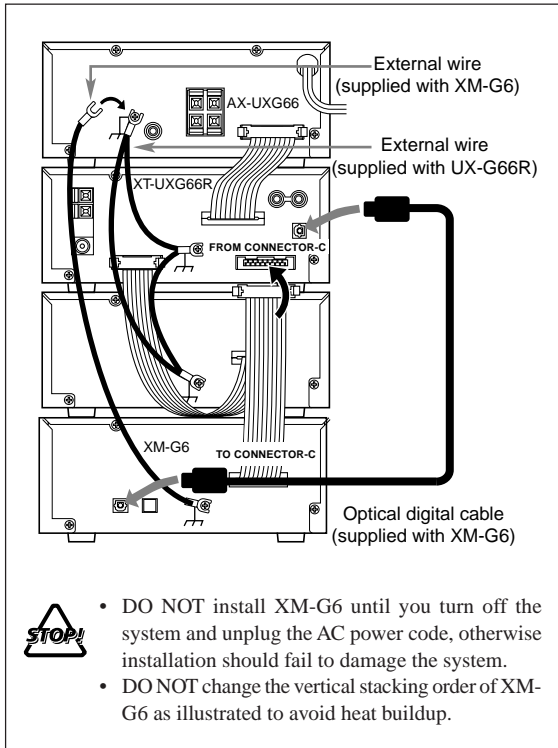

Connecting Antennas

Supplied FM antenna

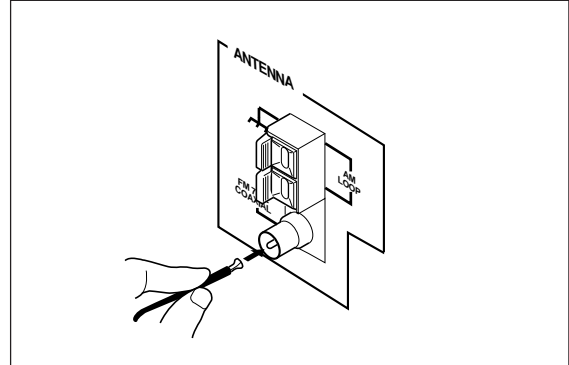

- 1 Attach the FM antenna to the FM 75 Ω COAXIAL terminal on the rear panel of XT-UXG66R.
- 2 Extend the FM antenna.
- 3 Fasten it up in the position which gives you the best reception.



About the supplied FM antenna

The FM antenna supplied with this unit can only be used as temporary measure. If reception is poor, you can connect an outdoor FM antenna.

To connect an outdoor FM antenna

Before connecting it, disconnect the supplied FM antenna.

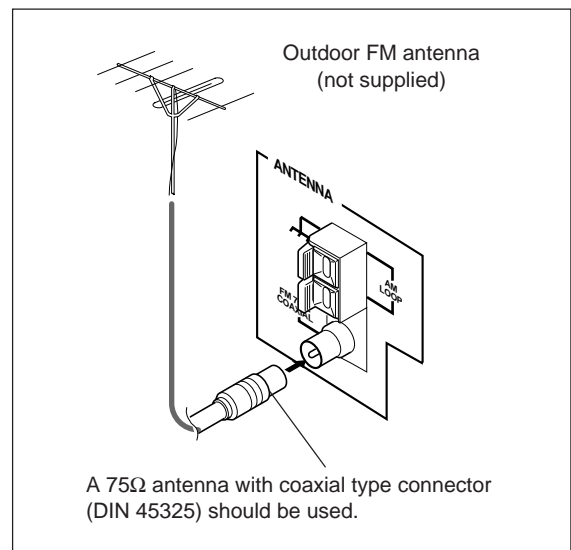

Connecting Sub Woofer System

When using JVC external sub woofer system, connect audio cable between AX-UXG66's SUB WOOFER OUT jack and the input of your sub woofer system.

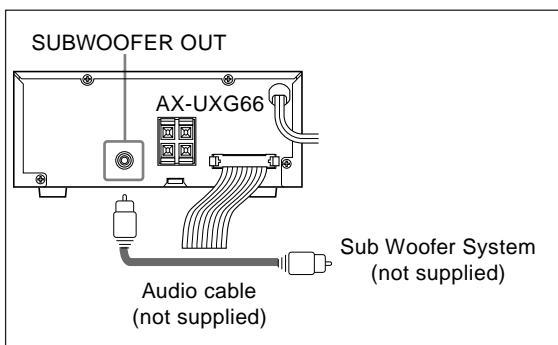

AM antenna

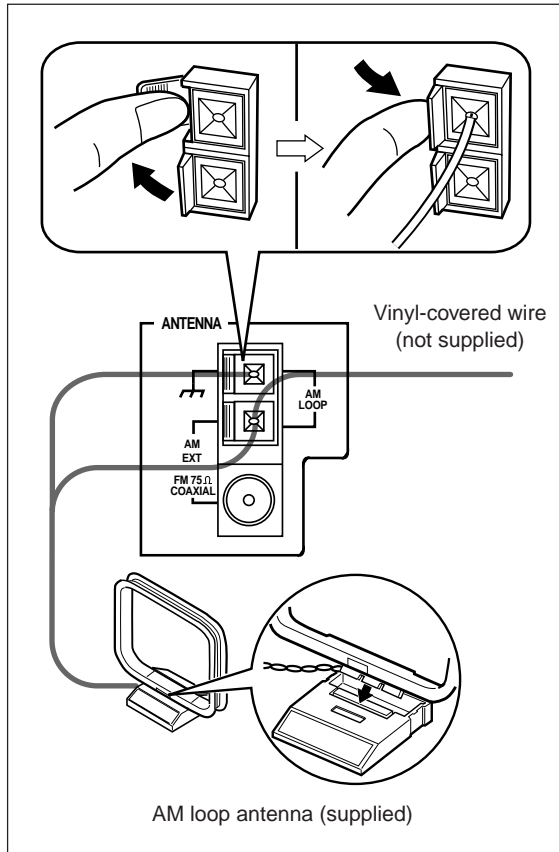

- 1** Connect the AM loop antenna to the AM LOOP terminals as illustrated.
- 2** Turn the AM loop antenna until you have the best reception.

To connect an external AM antenna

When reception is poor, connect a single vinyl-covered wire to the AM EXT terminal and extend it horizontally. (The AM loop antenna must remain connected.)



For better reception of both FM and AM

- Make sure the antenna conductors do not touch any other terminals and connecting cables.
- Keep the antennas away from metallic parts of the units, connecting cables, and the AC power cord.

Connecting Speakers

You can connect the speakers using the speaker cords.

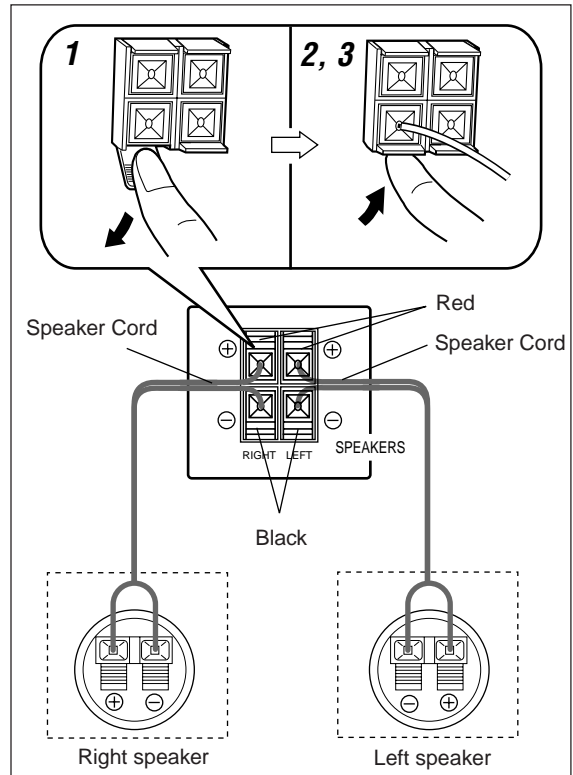

- 1** Open the speaker terminal.
- 2** Insert the end of the speaker cord to the terminal. Match the polarity of the speaker terminals: Red (+) to red (+) and black (-) to black (-).
- 3** Close the speaker terminal on the rear of the unit.



When connecting speaker cords

- Make sure to connect the cords correctly following the right series of above steps. During operation, wrong connection or a short circuit make the power turned off to protect the system. The clock loses the setting and is reset to "0:00". Also the MD recording may fail.
- Use only speakers with the same speaker impedance as indicated by the speaker terminals on the rear of the unit.

Connecting Other Equipments

You can connect the following equipments to the system:

- Audio equipment — used only as an analog playback device.
- Audio equipment with an optical digital input terminal — used as a digital recording device.

When you connect and use these equipments, refer also to the manuals supplied with them.

To connect audio equipment without a digital output terminal

Connect the audio output jacks on the other equipment and the ANALOG IN jacks, using an audio cable (not supplied).

Be sure that the plugs of the audio cables and the jacks on the rear panel of the unit are color coded: White plugs and jacks are for left audio signals, and red ones for right audio signals.



- DO NOT connect other equipment while the power is on.
- DO NOT plug in any equipment until all connections are complete.

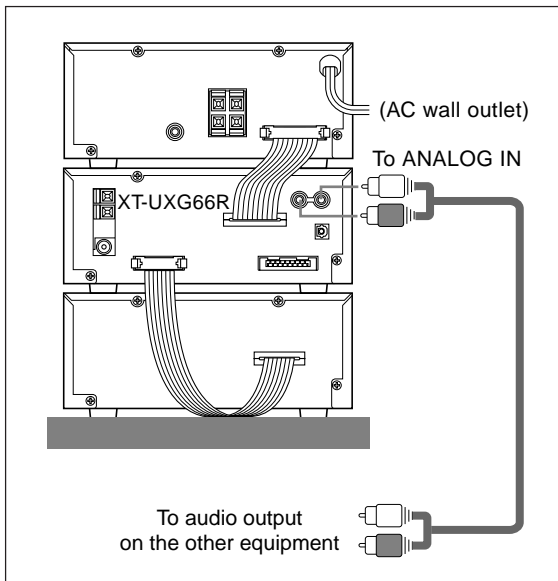

- By using audio cable (not supplied), connect between the audio output jacks on the other equipment and the ANALOG IN jacks.

To connect audio equipment with an optical digital input terminal

By using both an optical digital cable (not supplied) and an audio cable (not supplied), connect:

- Between the optical digital input terminal on the other equipment and the optical digital output terminal on XT-UXG66R.
- Between the audio output jacks on the other equipment and the ANALOG IN jacks.

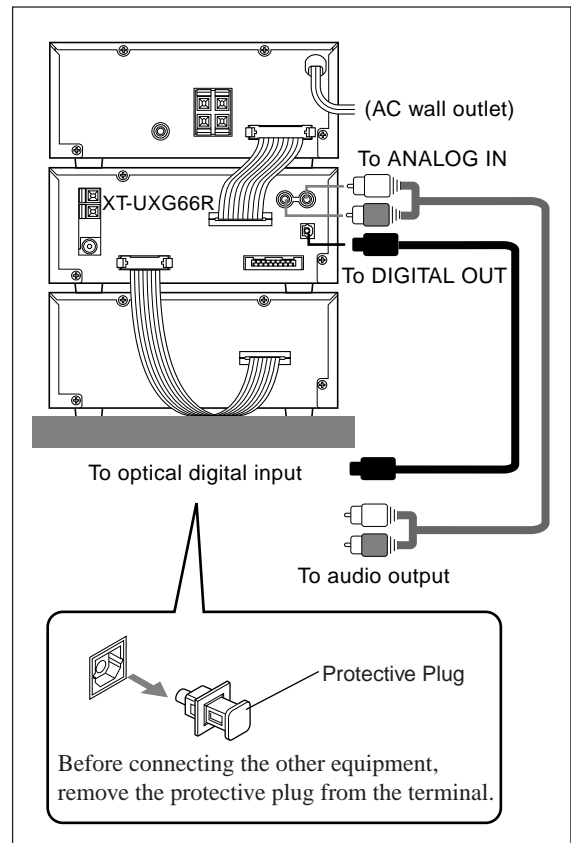

NOW, you can plug in the system and other connected equipment FINALLY!

When connecting the AC power cord into a wall outlet, the system switches to standby mode with STANDBY/ON lamp lit red.

Basic Settings

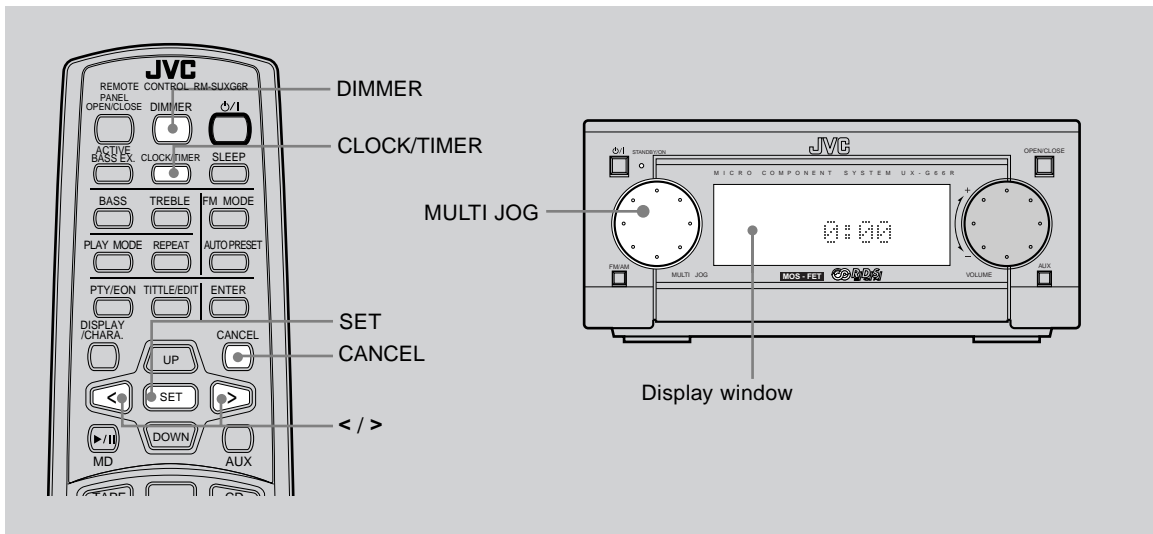

Before operating the system any further, set the clock built in this system first, then some other basic settings.

Setting the Clock

You can set the clock using the remote control whether the system is turned on or turned off (i.e. standby mode).

- 1 Press **CLOCK/TIMER button on the remote control**. The hour digit in the display window starts blinking.

0:00

- 2 Press **</> button on the remote control to adjust the hour, then press SET button on the remote control (rotating MULTI JOG dial also available)**.

10:00

- To correct the hour after pressing SET button, press CANCEL button. The hour digit starts blinking again.

- 3 Press **</> button on the remote control to adjust the minute, then press SET button on the remote control (rotating MULTI JOG dial also available)**.

10:28



If there is a power failure

The clock loses the setting and is reset to "0:00."

To adjust the clock again

You need to press CLOCK/TIMER button five times until the clock setting mode is selected.

Setting the Display Illumination (Dimmer)

You can adjust the brightness of around the display window. Each time you press DIMMER button, the display window dims and brightens alternately.

- **While the system is turned off:**

Press DIMMER button, "DISPLAY OFF" appears in the display window for a while and the system clock disappears.

DISPLAY OFF

Press the button again, "DISPLAY ON" appears in the display window for a while and only the system clock become dimmed.

DISPLAY ON

- **While the system is turned on:**

Press DIMMER button, both operating information and indicators in the display window dims. The light around MULTI JOG dial also becomes darker than usual. Press the button again, all the illumination around the display window recovers as usual.



Dimmer setting in the standby mode

Once the system is turned on, the dimmer setting in the standby mode does affect neither normal operations nor display indications.

Common Operations

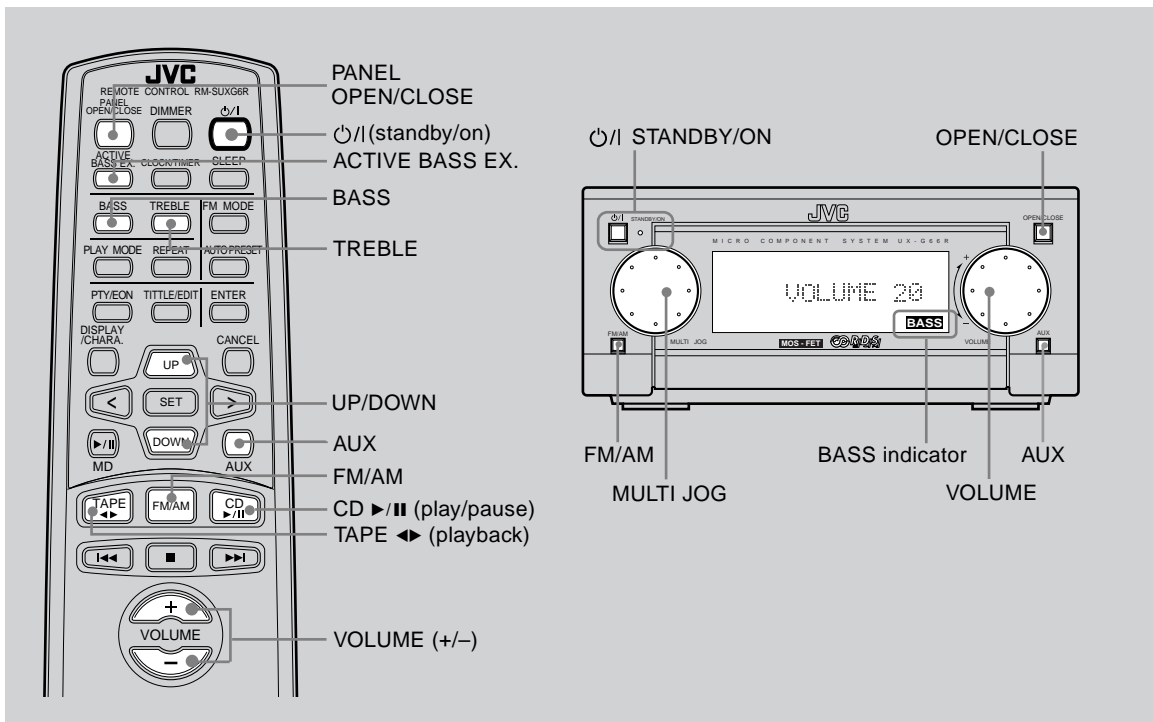

Here are basic and common things that apply to all the operations of UX-G66R system.

Turning On the Power and Selecting the Sources

When you press a play button for example, like FM/AM, CD ▶/|| (play/pause), or TAPE ◀▶ (playback), the system automatically turns on and STANDBY/ON lamp lights green.

One Touch Play

If any CD or a tape, or last tuned station provided, the system starts playing that source.

To select the external equipment as the source, press MD ▶/|| (play/pause) or AUX button so that the system automatically turns on.

Using ⏻/⏻ button

- **To turn on the system without playing,** press ⏻/⏻ button so that STANDBY/ON lamp lights green.
- **To turn off the system (standby mode),** press again ⏻/⏻ button so that STANDBY/ON lamp lights red.

A little power is always consumed even while the system is in standby mode.

- **To save the power consumption,** make use of Dimmer feature (see page 10).
- **To switch off the power supply completely,** unplug the AC power cord from the AC outlet. STANDBY/ON lamp goes off.



When you unplug the AC power cord or if a power failure occurs

The clock is reset to "0:00" right away, while the tuner preset stations will be erased in a few days.

Adjusting the Volume

You can adjust the volume level only while the system is turned on.

- Rotate VOLUME dial clockwise to increase the volume level or counterclockwise to decrease it.
- Using VOLUME dial, rotating quickly makes a large change in the volume level while rotating slowly makes a step-by-step change.

- When using the remote control, press VOLUME + button to increase the volume level or press VOLUME – button to decrease it.

The volume level (from 0 to 50) appears in the display window as follows:

VOLUME 20



For private listening

Connect a pair of headphones to the PHONES jack. No sound comes out of the speakers. Be sure to turn down the volume level before connecting or putting headphones.

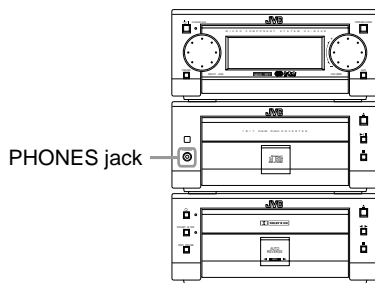

DO NOT turn off the system with the volume level set to an extremely high level; otherwise, the sudden blast of sound can damage your hearing, speakers and/or headphones when you turn on the system or start playing any source.

REMEMBER you cannot adjust the volume level while the system is turned off.

Reinforcing the Bass Sound

The richness and fullness of the bass sound is maintained regardless of how low you set the volume level.

You can use this effect only while listening sources.

- To get the effect**, press ACTIVE BASS EX. button on the remote control, and its indicator lights in the display window.
- To cancel the effect**, press the button again so that the indicator goes off.

Adjusting Bass and Treble Sounds

You can adjust bass and treble sound effects with the remote control, conforming to your preference and acoustic surroundings.

You can use this effect only while listening sources.

To adjust the bass

1 Press BASS button.

The current level settings shortly appears as follows:

BASS +3

To exit from the level setting, press the button again.

2 Press UP/DOWN button to adjust the level.

- Press UP button to increase the bass tone level.
- Press DOWN button to decrease the bass tone level.

The bass level can be adjusted in seven steps from –3 through 0 to +3 (step “0” makes no effect).

To cancel the effect, adjust the level to “0.”

To adjust the treble

1 Press TREBLE button.

The current level settings shortly appears as follows:

TREBLE –2

To exit from the level setting, press the button again.

2 Press UP/DOWN button to adjust the level.

- Press UP button to increase the treble tone level.
- Press DOWN button to decrease the treble tone level.

The treble level can be adjusted in seven steps from –3 through 0 to +3 (step “0” makes no effect).

To cancel the effect, adjust the level to “0.”

Operating the Sliding Panel

You can use the sliding panel to enable advanced operations features provided for UX-G66R micro component system.

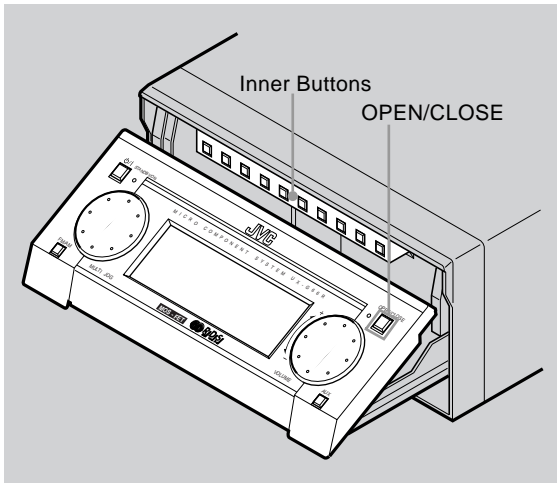

- Press OPEN/CLOSE button on the front panel (or PANEL OPEN/CLOSE button on the remote control).
The sliding panel opens to uncover the inner buttons behind the panel for further operations.
- Press OPEN/CLOSE button again.
The sliding panel automatically closes to hide the 10 inner buttons.

Each time you press the button, the sliding panel opens and closes repeatedly.

The buttons behind the sliding panel provided to control various program settings such as playback, recording, and presetting mode of each source. For details, refer to chapters concerning to the particular unit.



When turning off the system

After pressing  button, the system closes sliding panel as well as other CD tray and Tape tray automatically if they are still opened.

Listening to the External Equipment

You can listen to an external equipment such as MD recorder, VCR, and other auxiliaries.

First make sure that the external equipment is properly connected to the system (see page 7 and 9). For operation of the equipment, refer to its Instructions.

1 Press AUX button to select an external source.

- To play an audio equipment without optical digital output, select AUX so that the following information appears in the display window.

AUX

2 Start playing back the external equipment.

3 Adjust the volume level to the desired listening level.

4 Apply other sound effects, if you wish.

Listening to FM and AM Broadcasts

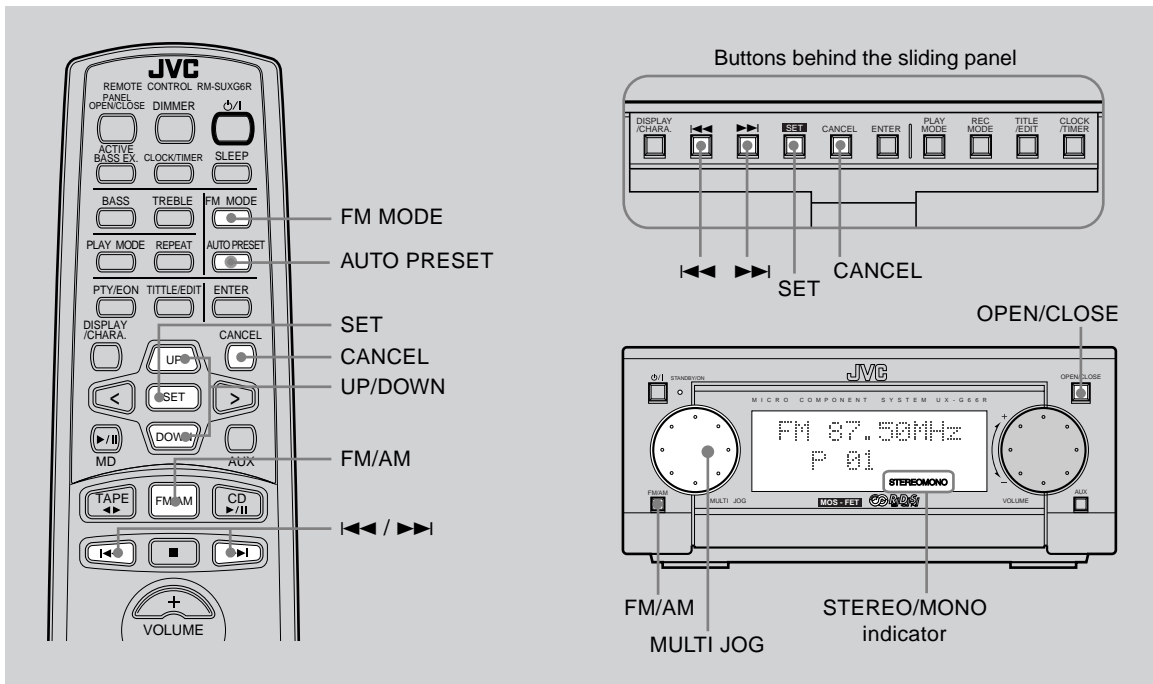

You can tune in FM and AM (MW/LW) stations manually, automatically, and use the preset station feature.

Tuning in a Station

1 Press FM/AM button.

The system automatically turns on and tunes in the last tuned station (either FM or AM—MW/LW). The following information appears in the display window.

FM 87.50MHz
P 01 — Preset number

- Each time you press the button, the band alternates between FM and AM.
- If a program on FM band is broadcast in stereo, STEREO indicator lights.

2 Select a station using one of the following three methods.

• Manual Tuning

Opening the sliding panel, press \lll / \ggg (lower/higher frequencies) button repeatedly to change the frequencies step by step until you find the desired station.

• Auto Tuning

Opening the sliding panel, press and hold \lll / \ggg (lower/higher frequencies) button for a second or more to start searching a station and stop automatically until the station of sufficient signal strength is tuned in.

• Preset Station Tuning

Rotate MULTI JOG dial clockwise to increase the preset number or counterclockwise to decrease it until the desired station is easily found.



Using the remote control:

UP/DOWN button on the remote control also has the same function as MULTI JOG dial on the front panel.



Preset Station

You are possibly not allowed to use the feature until the station presetting completes.

In some cases, test frequencies have been already memorized for the system since the factory examined the preset station features before shipment. This is not a malfunction.

Presetting Stations

You can preset up to 30 FM and 15 AM (MW/LW) stations into memory by following two methods: manual/automatic presettings.

- There is a time limit in doing the following steps. If the setting is canceled before you finish, start from step 1 again.

To preset stations manually — Manual Preset

- 1 Press **◀◀ / ▶▶** (lower/higher frequencies) button to tune in the desired station manually.

FM 87.50MHz

- 2 Press **SET** button.
“SET” appears in the display window for a while (not blinking).

SET

- Note that “SET” message disappears, presetting procedure is cancelled.

- 3 Rotate **MULTI JOG** dial or press repeatedly **UP/ DOWN** button to select the preset channel numbered from 1 to 30 on FM, or 1 to 15 on AM.

FM 87.50MHz
P 02

- Note that the selected channel “02” disappears, presetting procedure is cancelled.

- 4 Press **SET** button again.
“STORED” appears in the display window for a while.

STORED

- 5 The tuned station in step 1 is now stored in the preset channel selected in step 3.

FM 87.50MHz
P 02



Storing a new station on an used channel erases the previously stored one.

To preset stations automatically — Auto Preset

You can automatically preset 30 FM, 15 AM (MW/LW) stations. Preset numbers will be allocated as stations are found, starting from the lowest frequency and moving up to the higher frequency.

On the remote control only:

- 1 Press **FM/AM** button to select a desired band.
- 2 Press and hold **AUTO PRESET** button on the remote control for more than two seconds.
The system automatically starts searching for stations with the strong signals continuously, and they are stored successively into memory as follows:

FM 91.25MHz
↓
P 01
↓
FM 95.75MHz
↓
P 02



When you unplug the AC power cord or if a power failure occurs

The preset stations will be erased in a few days. If this happens, preset the stations again.

To change the FM reception mode

- When an FM stereo broadcast is hard to receive or noisy, press **FM MODE** button on the remote control so that **MONO** indicator lights in the display window. Reception improves.
- To restore the stereo effect, press **FM MODE** button again so that **STEREO** indicator lights in the display window.

In this stereo mode, you can hear stereo sounds when a program is broadcast in stereo.

Receiving FM Stations with RDS

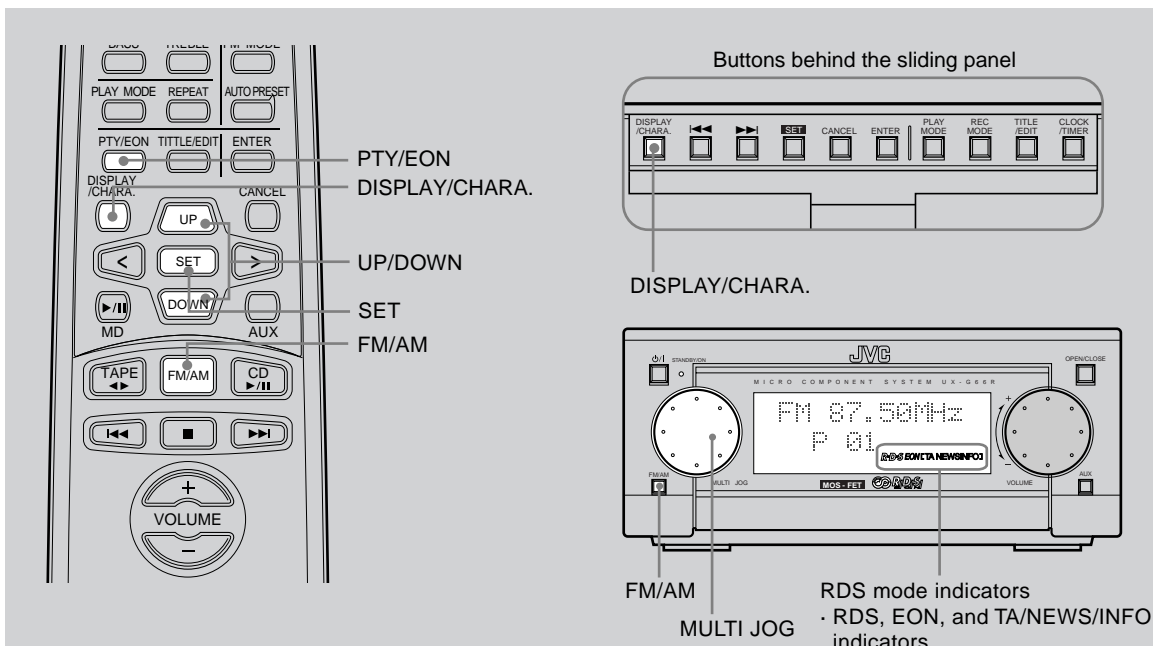

RDS allows FM stations to send an additional signal along with their regular program signals. For example, the stations send their station names, as well as information about what type of program they broadcast such as sports and music.

When tuned in an FM station which provides the RDS service, RDS indicator lights in the display window. You can receive the following types of RDS signals.

PS (Program Service):

Shows commonly known station names.

PTY (Program Type):

Shows types of broadcast programs.

RT (Radio Text):

Shows text messages the station sends.

EON (Enhanced Other Networks):

Provides the information about the types of the programs sent by other RDS stations than the one being received.



More about RDS

- Not all the FM stations provide RDS signals, nor do all RDS stations provide the same services. If in doubt, check with local radio stations for details on RDS in your area.
- RDS may not work correctly if the received station is not transmitting the signals properly or if the signal strength is weak.

Changing the RDS Information

You can see RDS information in the display window while listening to an FM station.

- RDS operations are possible only using the remote control except DISPLAY/CHARA. button.

Press DISPLAY/CHARA. button repeatedly while listening to an FM station.

Each time you press the button, the display window changes to show the following information:

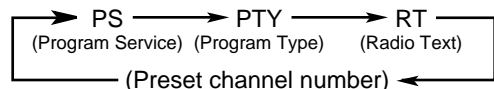

If no PS, PTY, or RT signals are sent by a station
 "NO PS," "NO PTY," or "NO RT" appears in the display window.

If the unit takes time to show RDS information received from a station
 "PS," "PTY," or "RT" may appear in the display window.

Searching for Programs by PTY Codes (PTY Search)

One of the RDS advantages is that you can locate a particular kind of program by specifying the PTY codes.

- The PTY Search is applicable only to preset stations.
- There is a time limit in doing the following steps. If the setting is canceled before you finish, start from step 1 again.

To search a program, use the remote control.

1 Press PTY/EON button on the remote control while listening to an FM station.

“SELECT PTY” appears and starts blinking in the display window.



2 Press UP/DOWN button repeatedly to select a PTY code while “SELECT PTY” is blinking.

Each time you press the button, the PTY codes change as follows (refer also to the list on page 19):

News ⇄ Affairs ⇄ Info ⇄ Sport ⇄ Educate ⇄
 Drama ⇄ Culture ⇄ Science ⇄ Varied ⇄ Pop
 M ⇄ Rock M ⇄ Easy M ⇄ Light M ⇄ Classics
 ⇄ Other M ⇄ Weather ⇄ Finance ⇄ Children
 ⇄ Social ⇄ Religion ⇄ Phone In ⇄ Travel ⇄
 Leisure ⇄ Jazz ⇄ Country ⇄ Nation M ⇄
 Oldies ⇄ Folk M ⇄ Document ⇄ Test ⇄ Alarm!
 ⇄ (back to the beginning)

3 Press SET button to enter the PTY code.

While searching, “SEARCH” appears in the display window.

The unit searches 30 preset FM stations, and stops when it finds the one you have selected, and tunes in that station.

- **To continue searching after the first stop:**
Press SET button again while the indications in the display window are blinking.
If no program is found, “NOT FOUND” appears and the unit returns to the last received station.
- **To stop searching during the process:**
Press PTY/EON button while searching.

Switching to a Program Type Temporarily

The EON function allows the system to switch temporarily to a broadcast program of your choice (News, TA, and/or Info) from a different station except when you are listening to a non-RDS stations — some FM stations and AM (MW/LW) stations.

- EON indicator lights while receiving a station with the EON code.
- EON function is applicable only to preset stations.

To activate the EON function, use the remote control.

1 Press PTY/EON button.

The last EON data type selected and “SELECT EON” appears and starts blinking in the display window.



2 Press UP/DOWN button repeatedly to select the EON data type you want.

Each time you press the button, the EON data types change as follows:

(Blank indications) → TA → News → Info → TA
 News → News Info → TA Info → TA News Info →
 (back to the beginning)

TA: Traffic announcement

News: News

Info: Program the purpose of which is to impart advice in the widest sense.

3 Press SET button to enter the EON data types.

RDS system switches to EON standby mode to receive a desired data type.

When the program is over, the indicator of received PTY code stops blinking and remains lit, but the EON function still remains activated.

- **To cancel the EON function:**
Press PTY/EON button again so that TA/News/Info indicator goes off.

How the EON function actually works:**CASE 1****If there is no station broadcasting the program you have selected**

The unit continues tuning in the current station.



When a station starts broadcasting the program you have selected, the unit automatically switches to the station. The indicator of received PTY code starts flashing.



When the program is over, "EON END" appears in the display window, and the unit goes back to the previously tuned station, but the EON function still remains activated.

CASE 2**If there is a station broadcasting the program you have selected**

The unit tunes in the program. The indicator of received PTY code starts flashing.



When the program is over, "EON END" appears in the display window, and the unit goes back to the previously tuned station, but the EON function still remains activated.

CASE 3**If the FM station you are listening to is broadcasting the program you have selected**

The unit continues to receive the station but the indicator of received PTY code starts flashing.



When the program is over, the indicator of received PTY code stops flashing and remains lit, but the EON function still remains activated.

**More about the EON function**

- EON data sent from some stations may not be compatible with this unit.
- While listening to a program tuned in by the EON function, the station does not change even if another network station starts broadcasting a program of the same EON data.
- While listening to a program tuned in by the EON function, you can only use PTY/EON and DISPLAY/CHARA. buttons as the tuner operation buttons.
- If the stations alternate intermittently between the station tuned by the EON function and the currently tuned station ("WAITING" flashes in the display window), press PTY/EON button to cancel the EON function.
If you do not press the button, the currently tuned station is received finally, and the indication of the EON data type flashing in the display window disappears.

Description of the PTY codes:

News:	News.	Finance:	Stock market reports, commerce, trading etc.
Affairs:	Topical program expanding or enlarging upon the news — debate or analysis.	Children:	Programs targeted at a young audience.
Info:	Program the purpose of which is to impart advice in the widest sense.	Social:	Programs about sociology, history, geography, psychology and society.
Sport:	Program concerned with any aspect of sports.	Religion:	Religious programs.
Educate:	Educational programs.	Phone In:	Involving members of the public expressing their views either by phone or at a public forum.
Drama:	All radio plays and serials.	Travel:	Travel information.
Culture:	Programs concerning any aspect of national or regional culture, including language, theater.	Leisure:	Programs about recreational activities.
Science:	Programs about natural sciences and technology.	Jazz:	Jazz music.
Varied:	Used for mainly speech-based programs like quizzes, panel games and personality interviews.	Country:	Songs which originate from, or continue the musical tradition of the American Southern States.
Pop M:	Commercial music of current popular appeal.	Nation M:	Current popular music of the nation or region in that country's language.
Rock M:	Rock music.	Oldies:	Music from the so-called "golden age" of popular music.
Easy M:	Current contemporary music considered to be "easy-listening."	Folk M:	Music which has its roots in the musical culture of a particular nation.
Light M:	Instrumental music, and vocal or choral works.	Document:	Program concerning factual matters, presented in an investigative style.
Classics:	Performances of major orchestral works, symphonies, chamber music, etc.	Test:	Broadcast when testing emergency broadcast equipment or receivers.
Other M:	Music not fitting into any of the other categories.	Alarm!:	Emergency announcement.
Weather:	Weather reports and forecasts.	Classification of the PTY codes for some FM stations may be different from the above list.	

Playing Back a CD

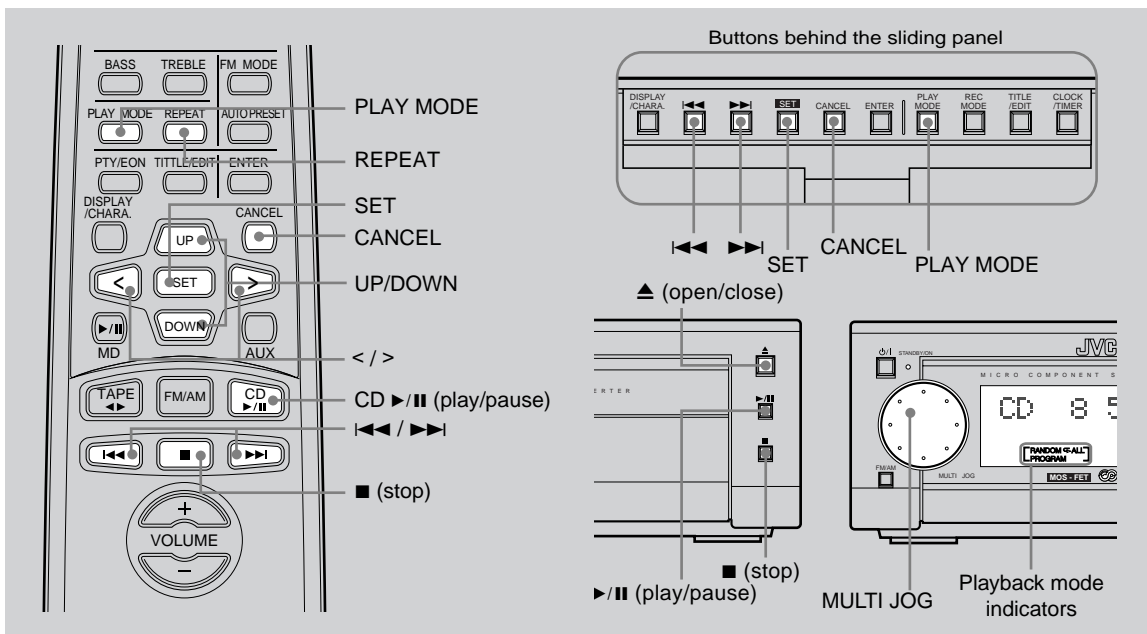

- You can use Normal, Program, Random, or Repeat Play.
- When using the buttons behind the sliding panel, press OPEN/CLOSE button on the AX-UXG66 to open the sliding panel first.
 - When using the remote control, press CD ►/|| (play/pause) button first and ■ (stop) button successively.

- DO NOT try to open or close the CD tray by hands as it will be damaged.
- DO NOT place any foreign matters.
- DO NOT prevent the tray from opening and closing, because it may results damages on the unit.

Playing Back the Entire Disc — Normal Play

- 1 Press ▲ (open/close) button on CD unit.
The system automatically turns on and the disc tray comes out.

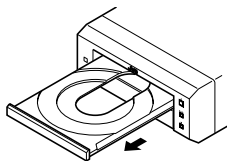

- 2 Place a disc correctly on the circle of the disc tray, with its label side up.

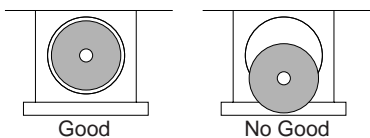

- When using a CD single (8 cm), place it on the inner circle of the disc tray.

- 3 Press ▲ (open/close) button again.
The disc tray closes while the information appears one after another as follows.

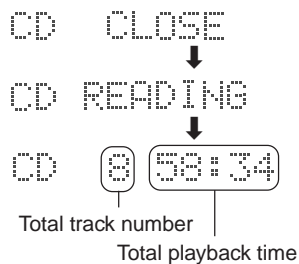

- When closing the tray without a CD placed, "CD NO DISC" appears.

When pressing ►/|| (play/pause) button directly, the system starts playback a CD immediately.

4 Press ►/|| (play/pause) button on the CD unit.

Each track of the CD starts playing one after another, and stops when the final track has finished playing.

CD 1 0:01

- **To stop playing back for a moment**, press ►/|| (play/pause) button on the CD unit. The playback time starts blinking in the display window.

CD 5 58:34

- **To resume playback**, press ►/|| (play/pause) button again. Playback continues from the point where it was stopped for a while.

5 Press ■ (stop) button to stop playing back the CD.

Following information for the CD appears in the display window.

CD 6 58:34

Total track number Total playback time

6 Press ▲ (open/close) button on the CD unit to remove the CD.

- Pressing ▲ (open/close) button during playback directly, the CD unit stops playback and opens CD tray.

Searching and Skipping Tracks

While playing back a CD, you can do the following operations.

To search and skip to a particular point in a track

During playback, press and hold ◀◀ / ▶▶ button to meet the desired passages in a track:

- Press and hold ▶▶ button:
Fast forwards in the track.
- Press and hold ◀◀ button:
Fast reverses in the track.



UP/DOWN button on the remote control is also available to searching operations.

To go to another track

Before or during playback, press ◀◀ / ▶▶ button repeatedly:

Press ▶▶ button:

Skips to the beginning of the next and succeeding tracks.

Press ◀◀ button:

Goes back to the beginning of the current and previous tracks.

Rotating MULTI JOG dial clockwise also changes the tracks forwards quickly, while rotating it counterclockwise the tracks reverse quickly.



</> button on the remote control is also available to skipping operations.

Programming the Playing Order of the Tracks — Program Play

You can arrange the order in which the tracks play before you start playback. You can program up to 32 tracks.

1 Place a CD.

- If the current playing source is not the CD, press ►/|| (play/pause) button on the CD unit, then ■ (stop) button before going to the next step.

2 Press PLAY MODE button repeatedly until “CD PROGRAM” appears in the display window.

CD PROGRAM

- Each time you press the button, playback mode indicators also change as follows:

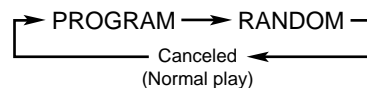
**3 Rotate MULTI JOG dial to select a track number to be programmed (</> buttons also available).**

CD 1 P

Track number Program number

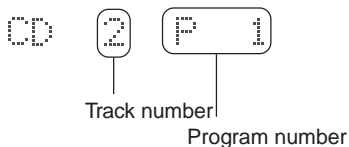
4 Press SET button to program the track number.

Here the track number 2 on the CD is stored into a program number 1, and shortly after that the total playback time of programmed tracks appears in the display window as follows:

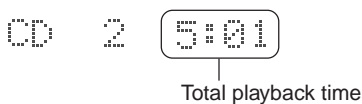
**5 Repeat steps 3 to 4 to program other tracks you want up to 32 tracks.**

- If you try to program a 33rd step "MEMORY FULL" will appear in the display window, and your entry is ignored.
- The total playback time of programmed tracks exceeds 99'59" "-- : --" will appear in the display window.

6 Press ►/II (play/pause) button on the CD unit.

The programmed tracks are played back in the order you have set.

- Other CD operations are the same as Normal play.

7 Press ■ (stop) button to quit the program play.

- When Program play finished, CD unit automatically stops.

To check the program contents

Before playing back the CD, you can check the program contents by using ◀◀ / ▶▶ button.

Press ▶▶ button:

Shows the programmed tracks in the programmed order.

Press ◀◀ button:

Shows them in the reverse order.

To modify the program

Before playing back the CD, you can erase the last programmed track by pressing CANCEL button. Each time you press the button, the last programmed track is erased from the end of program.

- To add new tracks to the program before you start playing-back, simply select a track number again you want to add (repeat steps 3 to 4).

To erase all the programmed data

After playing back the CD, you can erase all the programmed track data by pressing ■ (stop) button. New program can be entered again.

To exit from the Program play mode

Before or during playback, you can exit from Program play mode as follows:

- Before playback, press PLAY MODE button twice.
- During playback, press ■ (stop) button then PLAY MODE button twice.

Playback mode indicator goes off and the system resumes Normal play mode.



Pressing ▲ (open/close) button to open the CD tray also quits and erases the program play.

Playing at Random — Random Play

The tracks of the loaded CD will play in no special order (at random) when you select this mode.

1 Place a CD.

If the current playing source is not the CD, press ►/|| (play/pause) button on the CD unit, then ■ (stop) button before going to the next step.

2 Press PLAY MODE button repeatedly until “CD RANDOM” appears in the display window.

CD RANDOM

- Each time you press the button, playback mode indicator also changes as follows:

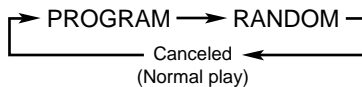

3 Press ►/|| (play/pause) button on the CD unit.

CD  RANDOM

The track numbers are shuffled in the display window for a few seconds, and start playing back at random. Random play ends when all the tracks are played back once.

- Other CD operations are the same as Normal play.

4 Press ■ (stop) button to quit Random play.

To exit from Random play mode

Before playing back the CD, you can exit from Random play mode as follows:

- Before playback, press PLAY MODE button once.
- During playback, press ■ (stop) button then press PLAY MODE button once.

Play mode indicator goes off and the system resumes the normal play mode.



Pressing ▲ (open/close) button to open the CD tray also quits and erases the random play.

Repeating Tracks — Repeat Play

You can have the entire disc, the programmed tracks, or the individual track repeat as many times as you like.

1 Place a CD.

If the current playing source is not the CD, press ►/|| (play/pause) button on the CD unit, then ■ (stop) button before going to the next step.

2 Press REPEAT button on the remote control repeatedly to set the repeat mode.

- Each time you press the button, repeat mode indicators light in the display window, and Repeat playback mode changes as follows:

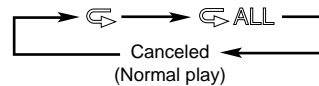

↻ : Repeats one track on the CD or in a program.

↻ ALL : Repeats all the tracks on the CD or a program.

3 Press ■ (stop) button to quit Repeat play.

To exit from Repeat play mode

Pressing REPEAT button repeatedly until repeat mode indicators (↻ and ↻ ALL) goes off in the display window.



Combining play modes:

- When combining Program play and Repeat play, you can repeat whole the programmed tracks or one track among them (↻ and ↻ ALL).
- When combining Random play and Repeat play, you can just repeat whole the shuffled tracks (only ↻ ALL).

Playing Back a Tape

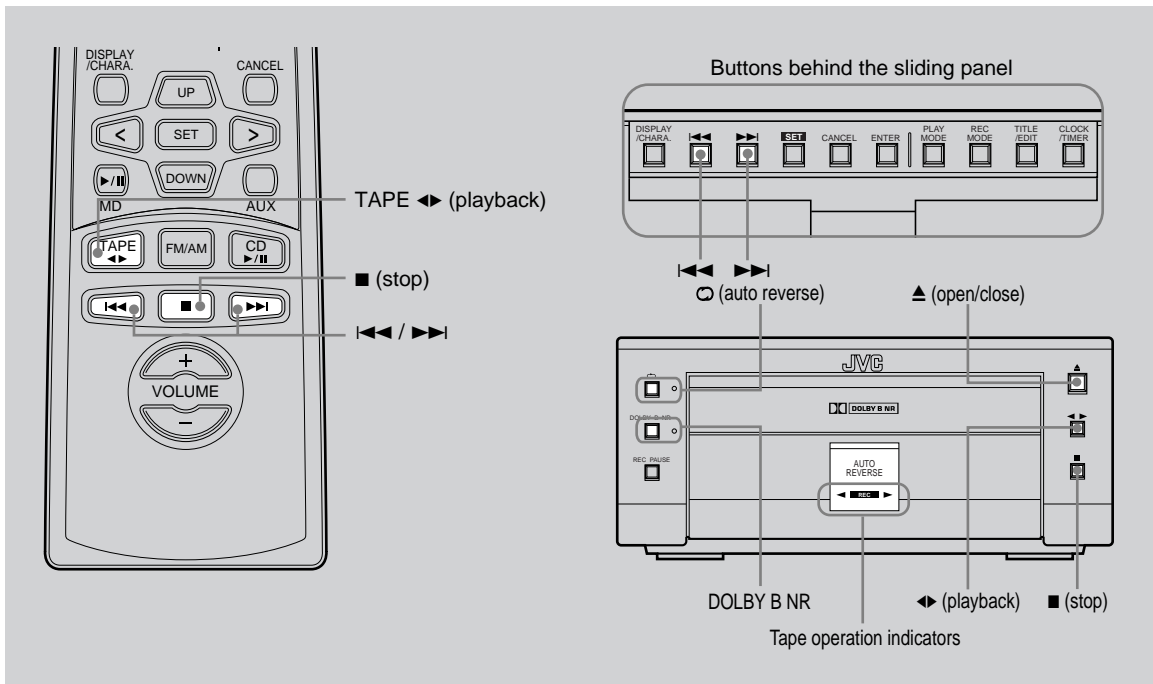

You can listen to Normal (Type I), High position (Type II), and Metal (Type IV) type tapes without further settings.

- When using the inner buttons, press OPEN/CLOSE button on AX-UXG66 unit to open the sliding panel first.
- When using the remote control, press TAPE ◀▶ (playback) button first and ■ (stop) button successively.



DO NOT use tapes longer than 120 minutes.
The characteristic deterioration may occur and these tapes easily jam in the tape transport mechanism.

Playing Back a Tape — Basic Operation

1 Press ▲ (open/close) button on the cassette deck unit.

The system automatically turns on and the tape tray comes out.

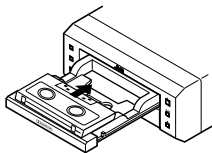

2 Place a tape on the tray with the side you want to listen to facing up (forward side).

Tape fits in the caved-in area so that an exposed edge of the tape faces toward the inside of the unit.



- DO NOT try to open or close the tape tray by hands as it will be damaged.
- DO NOT place any foreign matters.
- DO NOT prevent the tray from opening and closing, because it may results damages on the unit.

3 Press ▲ (open/close) button again to close the tray.

4 Press ◀▶ (playback) button on the unit or TAPE ◀▶ (playback) button on the remote control.

The tape playback starts and the tape direction indicator blinks slowly in orange to show the tape running direction.

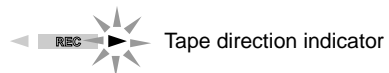

- Each time you press ◀▶ (playback) on the cassette deck unit or TAPE ◀▶ (playback) button on the remote control, you can change the tape sides to be played back currently.

- ▶ : plays the forward side.
- ◀ : plays the reverse side.



Playback comes to an end (Auto Reverse)

The cassette deck unit automatically changes the tape direction to the reverse side, and continue playback both sides. Each time to press the button, Auto Reverse feature is set to on/off alternately.

5 Press ■ (stop) button to stop playback the tape.

6 Press ▲ (open/close) button directly to stop and remove the tape.



While the system is turned off (standby mode)
Pressing ◀▶ (playback) or TAPE ▶▶ (playback) button automatically switches the system turned on and starts playback if a tape is already loaded.

Fast-Winding a Tape

While stopping the tape, press ◀◀◀ / ▶▶▶ button to fast-wind the tape.

To fast-forward, if the current tape direction is:

▶ ⇒ Press ▶▶▶ button.

◀ ⇒ Press ◀◀◀ button.

To fast-rewind, if the current tape direction is:

▶ ⇒ Press ◀◀◀ button.

◀ ⇒ Press ▶▶▶ button.

During fast-winding, the tape direction indicator starts blinking quickly.

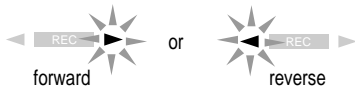

When the tape comes to an end
The deck unit automatically stops.

Searching and Skipping to Each Program — Music Scan

While playing the tape, you can search and skip to the beginning of the current and next program on a tape.



Music scan searches for blank portions that usually separate programs recorded onto the tape, then automatically plays the program beginning after that blank portion.

To skip backward to the current music

Press the button opposite to the tape direction indicator as follows:

▶ ⇒ Press ◀◀◀ button.

◀ ⇒ Press ▶▶▶ button.

To skip forward to the next music

Press the button same as the tape direction indicator as follows:

▶ ⇒ Press ▶▶▶ button.

◀ ⇒ Press ◀◀◀ button.

During Music Scan progressed, the tape direction indicator starts blinking rhythmically.

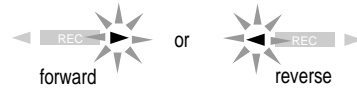

Repeating Music Scan feature made easy

searching a desired program on a tape one after another.



The beginning of the desired program may not be located properly

If blanks between music are too short, the blanks contain too much noise or the program itself contains very low-level or silent part.

Playing Back Dolby-Recorded Tape

You can play back the tape recorded with Dolby B NR system. The Dolby NR system allows to reduce hiss noise in playback.

Press DOLBY B NR button on the cassette deck before playback. Each time you press the button, the Dolby NR lamp on the unit lights up orange or turns off.



A tape recorded using Dolby NR

Should be played back using the Dolby NR of the same type as that used in recording. The audio quality will be affected if a different type is used in playback.

Dolby noise reduction manufactured under license from Dolby Laboratories Licensing Corporation.

“DOLBY” and the double-D symbol **DD** are trademarks of Dolby Laboratories Licensing Corporation.

Recording onto a Tape

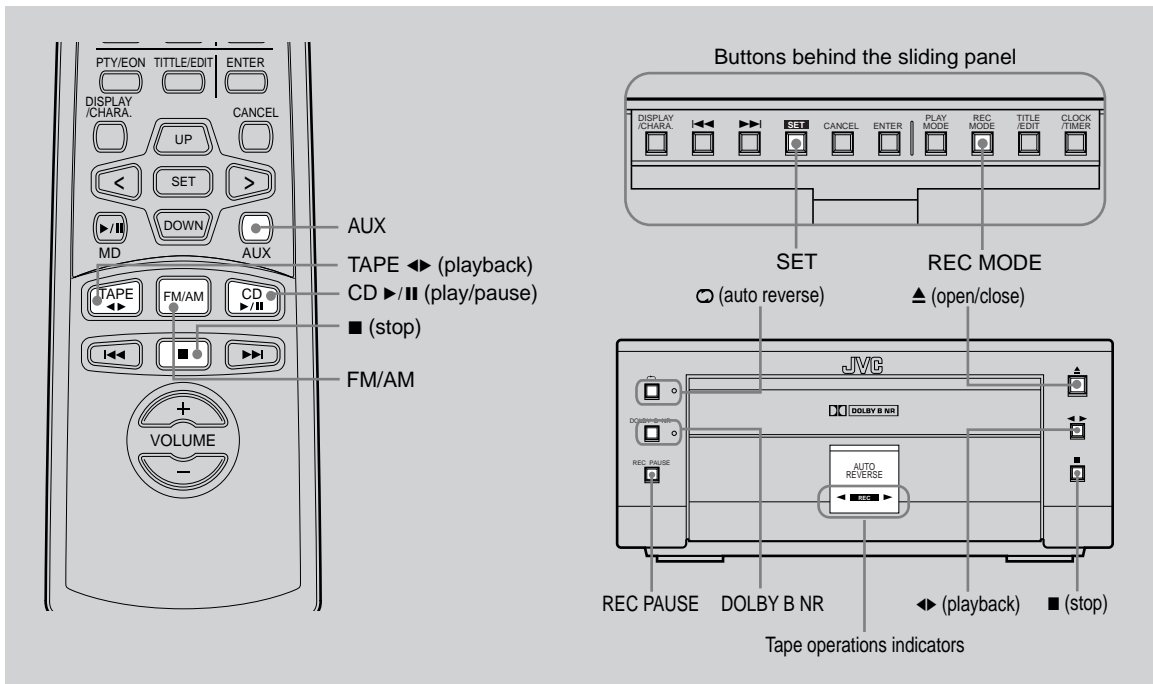

Two types of cassette tapes can be recorded onto, including normal (Type I), and High position (Type II) tapes. These types are identified automatically by the cassette deck unit and the recording level is also corrected automatically. Neither volume level nor sound effects during playback does affect to the recording.

IMPORTANT:

- It should be noted that it may be unlawful to pre-recorded tapes, records, or discs without the consent of the owner of copy right in the sound or video recording, broadcast or cable program and in any literary, dramatic, or artistic embodied therein.

Manual Recording onto a Tape

1 Select one of the recording sources — FM/AM broadcasts, CD, or other external equipment.

- To record FM/AM broadcasts, receive a station with Tuner unit.
- To record a CD or its tracks programed, set the play-pause mode for CD unit.
- To record from an external equipment connected to ANALOG IN jacks, prepare it as required.



Make sure to select a source first, otherwise you cannot use recording function.

2 Place a recordable tape with the side you want to record facing up.

Press ▲ (open/close) button on the cassette deck unit to open the tape tray; place a tape on it; and press ▲ (open/close) button again to close it.

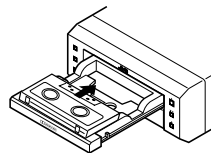

- You cannot record onto the tape without a protect tab. When using that tape, cover the hole for desired side with adhesive tape.

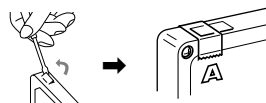

3 Press REC PAUSE button on the cassette deck unit.



REC indicator lights red to show the recording pause mode, and “TAPE REC” appears in the display window as follows,

```

FM 87.50MHz
TAPE REC
OR
CD 8 58:34
TAPE REC
  
```



To change the recording source

You cannot change the selected source during the recording pause mode. To exit from the recording pause mode, press ■ (stop) button on the cassette deck unit.



To make the blank tape

Press AUX button to start recording without connecting nor playing back the external equipment.

4 Press Tape ◀▶ (playback) button for FM/AM broadcasts or ▶/II (play/pause) button on the CD unit to start recording.

Tape direction indicator starts blinking slowly in the display window.

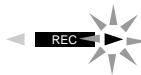

Tape direction indicator

- **To stop recording for a moment**, press REC PAUSE button on the cassette deck unit. Tape direction indicator stops blinking in the display window.
- **To resume recording**, press ◀▶ (playback) button again. Recording continues from the point where it was stopped for a while.

5 Press ■ (stop) button on the cassette deck unit for FM/AM broadcasts recording, or ■ (stop) button on the CD unit for the CD recording.

Recording stops and REC indicator goes off in the display window.



On CD recording, cassette deck unit will stop after leaving a non-recorded portion of 4 seconds. If you want to quit recording immediately, press ■ (stop) button on the cassette deck unit.

6 Press ▲ (open/close) button on the cassette deck unit to remove the tape.

- Pressing ▲ (open/close) button directly during recording, the cassette deck unit stops recording and opens the tape tray.



• **Dolby B NR**

Press DOLBY B NR button before recording to reduce frequency response noise.

When the tape is played back later, also press the button with its lamp lit.

• **BEAT CUT on AM (MW/LW)**

When recording AM broadcast, beats noise may be heard.

Set the BEAT CUT selector to either position 1 or 2 on the rear panel of the cassette deck unit to reduce the noise.

Recording in Auto Reverse

1 Select one of the recording sources — FM/AM broadcasts, CD, or other external equipments.

2 Make sure the tape side for recording meets the tape direction indicator ▶ (forward).



- Each time to press ◀▶ (playback) button or TAPE ◀▶ (playback) button on the remote control, you can change the tape direction to be recorded onto.

▶ : Good, records onto the forward side.

◀ : No good, records onto the reverse side.



- The recording in the auto reverse mode stops automatically after completing recording onto the ◀ (reverse) direction side.

Be sure to start recording from the ▶ (forward) direction side.

- When the auto reverse mode is set to off, recording stops after having recorded onto one side of the tape.

3 Press ⏮ (auto reverse) button on the cassette deck unit to set the reverse mode on.

The auto reverse lamp lights orange on the front panel.

4 Press REC PAUSE button on the cassette deck unit.

5 Repeat the steps 4 to 5 of “Manual Recording onto a Tape” mentioned in the left column.

Synchronized Recording from a CD

CD application on UX-G66R system can be recorded with a simple, one-touch operation.

- 1 Place a recordable tape and a source CD into each tray.**
 - To record using Dolby B NR, press the DOLBY B NR button before recording so that its lamp near the button lights orange.
- 2 Press ►/II (play/pause) button on the CD unit, then ■ (stop) button to set the system to CD operation mode.**
- 3 Press REC MODE button behind the sliding panel.**
The display window shows information as follows:

```
SYNC REC
>TAPE
```

- 4 Press SET button.**
Display window shows as follows:

```
SYNC REC
TAPE REC

then

CD 1 --- : ---
TAPE REC
```

UX-G66R starts playback on the CD unit as well as recording on the cassette deck unit simultaneously. You can get an entire copy of the source CD.

To select a particular track or program, use REC PAUSE button on the cassette deck unit. During SYNC REC mode, you cannot operate CD unit except ■ (stop) button.

- To make recording pause temporarily,** press REC PAUSE button on the cassette deck unit.
- To resume recording,** press ◀▶ (playback) button on the cassette deck unit.



Using Program play for CD recording

To edit CD's tracks to be recorded, it is useful to set the desired tracks to be played back into a program in advance.

When CD playback finished, the CD unit first, then the cassette deck stops recording automatically.



Cassette deck unit will stop after leaving a non-recorded portion of 4 seconds.

If you want to quit recording immediately, press ■ (stop) button on the cassette deck unit.

- 5 Press ▲ (open/close) button on each unit to remove the CD and the tape.**

Recording from the External Equipment

You can record audio sources played-back on the external equipment onto a tape manually.

First of all, make sure to connect the external equipment properly (see also page 9).

Recording an external audio source manually

- 1 Press AUX button to show "AUX" in the display window.**
The external audio source is selected.
- 2 Repeat the steps 2 and 3 on page 26 to prepare a tape to record.**
Information appears as follows:

```
AUX
TAPE REC
```

- 3 Press ◀▶ (playback) button on the cassette deck unit or TAPE ◀▶ (playback) button on the remote control to start recording.**
Tape direction indicator starts blinking slowly in the display window.

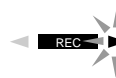

Tape direction indicator

- 4 Start playing back the external equipment.**
 - To stop recording for a moment,** press REC PAUSE button on the cassette deck unit. Tape direction indicator stops blinking in the display window.
 - To resume recording,** press ◀▶ (playback) button again.
 - To end the recording,** press ■ (stop) button on the cassette deck unit.
Recording stops and REC indicator goes off in the display window.

Using the Timers

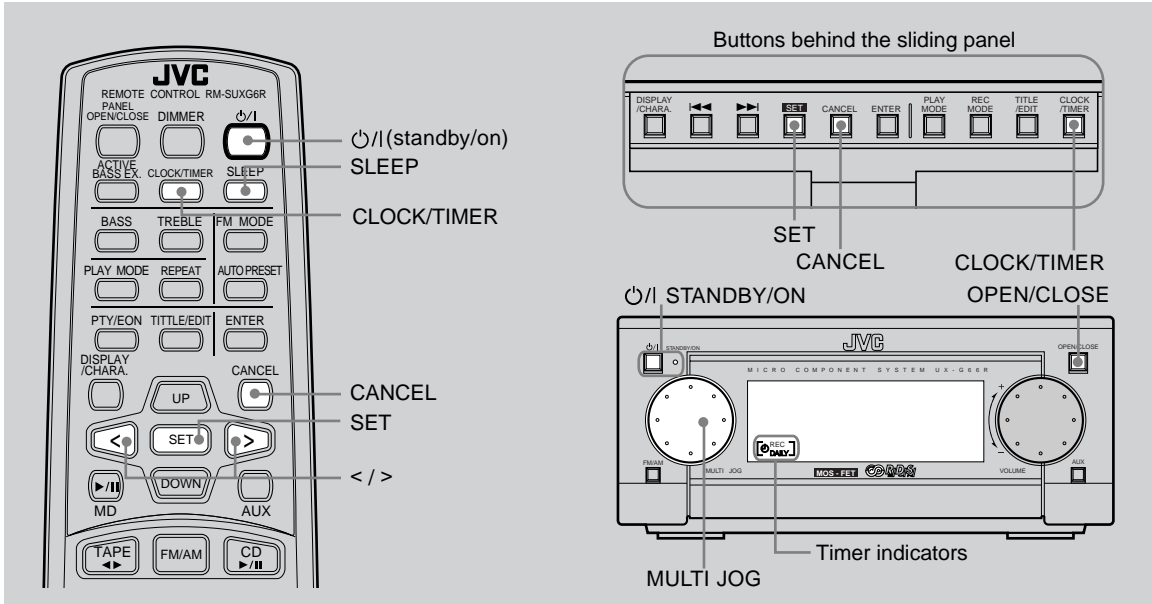

On UX-G66R system, three timer features are available — Recording Timer, Daily Timer, and Sleep Timer. Before using these timers, you need to set the clock built in the system (see page 10).

Using Recording Timer

With Recording Timer, you can make a tape of a radio broadcast automatically.

- You can set Recording Timer whether the system is turned on or off.
- To correct a mis-entry any time during the setting process, press CANCEL button.

How Recording Timer actually works

The system automatically turns on, tunes into the specified station, turns off the volume, and starts recording when the timer-on time comes.

Then, when the timer-off time comes, the system automatically turns off (standby).

The timer settings remain stored in memory until you reset them or unplug the AC power cord.

1 Press **CLOCK/TIMER** button repeatedly until “REC TIMER” and its timer-on time appear in the display window.

You can select the timer-on/off time, a tuner preset channel to record, and recording media.

- If MD recorder XM-G6 (not supplied) connected, you can select MD as recording media (see page 7).

- Each time you press the button, the timer mode changes as follows:

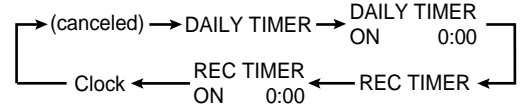

2 Rotate **MULTI JOG** dial (</> button on the remote control also available) to select the hour of the timer-on time, then press **SET** button.

REC TIMER
ON 21:30

3 Rotate **MULTI JOG** dial (</> button on the remote control also available) to select the minute of the timer-on time, then press **SET** button.

REC TIMER
ON 21:30

4 Rotate **MULTI JOG** dial (</> button on the remote control also available) to select the hour of the timer-off time, then press **SET** button.

REC TIMER
OFF 22:30

- 5** Rotate MULTI JOG dial (</> button on the remote control also available) to select the minute of the timer-off time, then press SET button.

REC TIMER
OFF 22:30

- 6** Rotate MULTI JOG dial (</> button on the remote control also available) to select either "TUNER FM" or "TUNER AM," then press SET button.

- 7** Rotate MULTI JOG dial (</> button on the remote control also available) to select a preset channel, then press SET button.

TUNER FM
P 05

"TAPE REC" follows in the display window as selected recording media, unless any MD recorder connected.

- If XM-G6 MD recorder connected, you can select either a tape or an MD as recording media.

- 8** Press SET button to select recording media, and turn off the system.

After completing the settings...

The REC timer indicator lights and the setting items appear one after another in the display window. Thus the Recording Timer is ready for unattended recording.



After a timer recording is complete...

Set the volume to an appropriate listening level.



If you press a certain button while Recording Timer is operating
Recording will stop.

To use the same Recording Timer settings repeatedly

Once you have set the recording timer, it remains stored in memory until you change it.

To activate the recording timer with the previous settings, follow the procedure below:

- 1** Press CLOCK/TIMER button repeatedly until "REC TIMER" appears in the display window.

REC TIMER

- 2** Press SET button to call the previous settings for next timer recording.

The REC timer indicator lights, and the setting items appear one after another in the display window.

- To erase the recording timer, press CANCEL button in this step.

Using Daily Timer

With Daily Timer, you can wake up on your favorite music or radio program.

- You can set the daily timer whether the system is turned on or off.

How Daily Timer actually works

The system automatically turns on, and starts playing the specified source when the timer-on time comes. Then, when the timer-off time comes, the system automatically turns off (standby).

The timer settings remain stored in memory until you reset them or disconnect the AC power cord.

- 1** Press CLOCK/TIMER button repeatedly until "DAILY TIMER" and its timer-on time appear.

- Each time you press the button, the timer mode changes as follows:

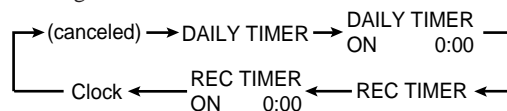

- 2** Rotate MULTI JOG dial (</> button on the remote control also available) to select the hour of the timer-on time, then press SET button.

DAILY TIMER
ON 6:15

- 3** Rotate MULTI JOG dial (</> button on the remote control also available) to select the minute of the timer-on time, then press SET button.

DAILY TIMER
ON 6:15

- 4** Rotate MULTI JOG dial (</> button on the remote control also available) to select the hour of the timer-off time, then press SET button.

DAILY TIMER
OFF 7:00

- 5** Rotate MULTI JOG dial (</> button on the remote control also available) to select the minute of the timer-off time, then press SET button.

DAILY TIMER
OFF 7:00

- 6** Rotate MULTI JOG dial (</> button on the remote control also available) to select the source, then press SET button.

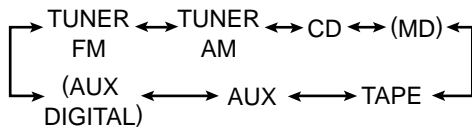

- TUNER FM:** Tunes into a preset FM station. Go to step 7.
- TUNER AM:** Tunes into a preset AM station. Go to step 7.
- CD:** Plays a CD. Prepare a CD, then go to step 7.
- (MD):** Plays a MD, only when XM-G6 MD recorder connected. Then go to step 7.
- TAPE:** Plays a tape. Prepare a tape, then go to step 8.
- AUX*:** Selects "AUX" as the source. Make the external equipment ready for playback.
- (AUX DIGITAL):** Selects an external digital audio equipment as the source if connected.

* To use the external equipment with the Daily Timer, it also has the timer function.

- 7** If you have selected FM/AM as the source in the above step, select a preset channel.

- 1) Rotate MULTI JOG dial (</> button on the remote control also available) to select a preset channel.
- 2) Press SET button.

FM 87.50MHz
P 02

If you have selected CD as the source in the above step, select a track.

- 1) Rotate MULTI JOG dial (</> button on the remote control also available) to select a track.
- 2) Press SET button.

CD 1

- 8** Rotate MULTI JOG dial (UP/DOWN button on the remote control also available) to adjust the volume level, then press SET button.

- You can adjust the volume within the range of "0" to "50." If you select "– –," the volume is set to the previous level when the unit is turned off.

VOLUME ----

After completing the settings...

The daily timer indicator lights, and the setting items appear one after another in the display window.

Turns off the unit (standby) if you have set the daily timer with the unit turned on.



If you press a certain button while Daily Timer is operating

The unit will not turn off automatically.

To use the same Daily Timer settings repeatedly

Once you have set Daily Timer, it remains stored in memory until you change it.

To activate the daily timer with the previous settings, follow the procedure below:

- 1** Press CLOCK/TIMER button repeatedly until "DAILY TIMER" appears in the display window.

DAILY TIMER

- 2** Press SET button to activate Daily timer.

The daily timer indicator lights, and the setting items appear one after another in the display window.

- To deactivate the daily timer, press CANCEL button in this step.

Using Sleep Timer

With Sleep Timer, you can fall asleep to your favorite music or radio program.

How Sleep Timer actually works

The system automatically turns off after the selected time length passes while playing any source.

On the remote control only:

1 Press SLEEP button on the remote control repeatedly to select the sleep timer.

- Each time you press the button, the time length changes as follows:

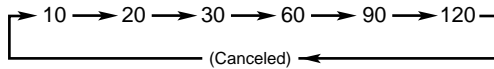

2 Wait for about 5 seconds after selecting the time length.

When the sleep timer setting is completed, the display window dims and just shows the remaining time until the shut-off time minute by minute like “SLEEP 30” then “SLEEP 29”.

- **To change the shut-off time**, press SLEEP button repeatedly until the desired time length appears.
- **To cancel the setting**, press SLEEP button repeatedly until the sleep timer indication disappears.

Timer Priority

Since each timer can be set separately, you may wonder what happens if the setting for these timers overlaps. Here are the priorities for each timer.

- **Recording Timer has priority over Daily Timer and Sleep Timer.**

If Daily Timer is set to come on while Recording Timer is operating, Daily Timer will not come on at all.

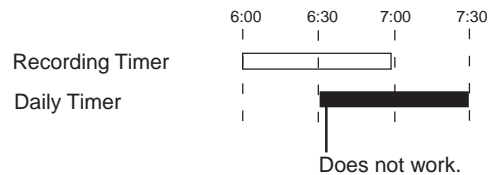

If Recording Timer is set to come on while Sleep Timer is operating, Sleep Timer will be canceled several seconds before Recording Timer comes on.

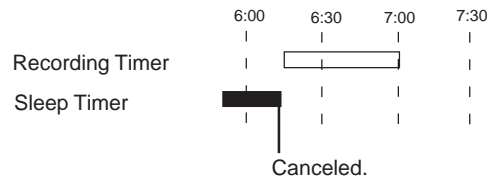

- **Sleep Timer has priority over Daily Timer.**

If Daily Timer is set to come on while Sleep Timer is operating, Daily Timer will not come on at all.

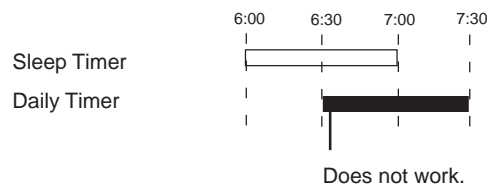

Therefore, the equation is like this (high > low):

Recording Timer > Sleep Timer > Daily Timer

Maintenance and Additional Information

General Notes

In general, you will have the best performance by keeping your CDs, cassette tapes and the mechanism clean.

- Store CDs and cassette tapes in their cases, and keep them in cabinets or on shelves.
- Keep the CD disc tray, and the cassette tapes tray closed when not in use.

Handling CDs



- Only CDs bearing this mark can be used with this system. However, continued use of irregular shape CDs (e.g. heart shape, octagonal) can damage the system.

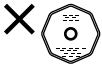
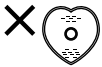

- Remove the CD from its case by holding it at the edge while pressing the center hole lightly.
- Do not touch the shiny surface of the disc, or bend the CD.
- Put the CD back in its case after use to prevent warping.

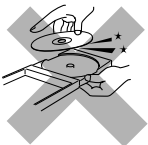

- Be careful not to scratch the surface of the CD when placing it back in its case.
- Avoid exposure to direct sunlight, temperature extremes, and moisture.



- To clean the CD
Wipe the CD with a soft cloth in a straight line from center to edge.



DO NOT use any solvent — such as conventional record cleaner, spray, thinner, or benzine — to clean the CD.

Handling Cassette Tapes

Cautions regarding handling

- Do not touch the surface of the tape or pull the tape out of the cassette.
- Tape spooled loosely around the hubs is likely to jam in the pinch rollers and capstans. Before loading the tape into the cassette tray, take up the slack in the tape as shown below.

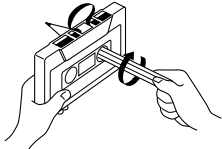

Tape storage

- Place tapes in their cases for storage.
- Avoid storing tapes on top of TVs or speakers, in sunlight or places of high temperature, or in humid or dusty areas.

To prevent accidental erasure

- Cassette tapes have tabs to prevent accidental erasure.
- If you remove the tabs after making a recording, the cassette deck cannot be set to record when that tape is loaded. Remove the tabs so that valuable recordings will not be accidentally erased.

Recording (erasure) is not possible when the tabs are removed.

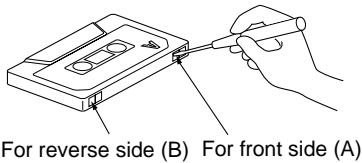

For reverse side (B) For front side (A)

- To make another recording on a tape whose tabs have been removed, cover the tab holes with adhesive tape.

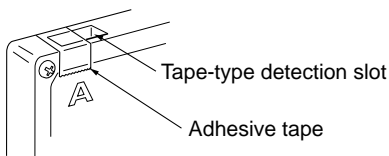

DO NOT cover the tape-type detection slots.

Types of Cassette Tapes

This cassette deck unit incorporates an Automatic Tape Detection function. This mechanism uses the tape-type detection holes to distinguish which type of tape was inserted, and sets the bias and equalizer to the optimum settings for that tape automatically.

The following types of tapes may be used with this cassette deck unit.

Normal tape

TYPE I

BIAS: NORMAL

EQ: 120 μ s

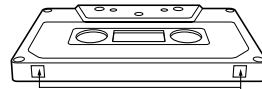

Normal (No detection slots) Tab
(to prevent accidental erasure)

High position (CrO₂) tape

TYPE II

BIAS: HIGH

EQ: 70 μ s

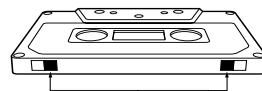

High position
detection slots

Metal tape (only for playback)

TYPE IV

BIAS: METAL

EQ: 70 μ s

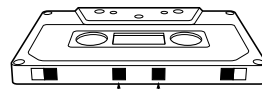

Metal detection slots



- Certain early period Metal and High position (CrO₂) tapes may not have tape-type detection slots. The cassette deck unit cannot obtain the correct characteristics for these tapes.
- Ferrochromite (FeCr) TYPE III tapes cannot be used with this cassette deck unit.

Troubleshooting

If you are having a problem with your system, check this list for a possible solution before calling for service. If you cannot solve the problem from the hints given here, or the units has been physically damaged, call a qualified person, such as your dealer, for service.

Symptom	Possible Cause	Action
No sound is heard.	<ul style="list-style-type: none"> • Connections are incorrect, or loose. • Headphones are connected. • Volume level is set to “– –”. 	<ul style="list-style-type: none"> • Check all connections and make corrections (see pages 6 – 9). • Disconnect the headphones (see page 12). • Adjust the volume again (see page 11).
Poor radio reception.	<ul style="list-style-type: none"> • The antenna is not connected correctly. • The AM loop antenna is too close to the units. • The FM antenna is not properly extended and positioned. • The AM radio noise interferes with tape recording. 	<ul style="list-style-type: none"> • Reconnect the antenna securely. • Change the position and direction of the AM loop antenna. • Extend FM antenna to the best reception position (see page 7). • Set the BEAT CUT selector again (see page 27).
Unable to record onto a tape.	<ul style="list-style-type: none"> • You are using a tape without a protect tab. • Tape-type detection slots are covered by foreign matters. 	<ul style="list-style-type: none"> • Cover the hole with adhesive tape (see page 34). • Remove the foreign matters.
The CD skips.	<ul style="list-style-type: none"> • The CD is dirty or scratched. 	<ul style="list-style-type: none"> • Clean or replace the CD (see page 33).
Unable to operate using the remote control.	<ul style="list-style-type: none"> • The path between the remote control and the remote sensor on the front panel is blocked. • The batteries have lost their charge. 	<ul style="list-style-type: none"> • Remove the obstruction. • Replace the batteries (see page 6).
Loaded CD and tape cannot be ejected.	<ul style="list-style-type: none"> • The main AC power cord is not plugged in. • The system is under the recording operations. 	<ul style="list-style-type: none"> • Plug in the AC power plug. • Stop the recording if required (see pages 27).
The CD does not play.	<ul style="list-style-type: none"> • The CD is upside down. 	<ul style="list-style-type: none"> • Put in the CD with the label side up.
Operations are disabled.	<ul style="list-style-type: none"> • The built-in microprocessor has malfunctioned due to external electrical interference. 	<ul style="list-style-type: none"> • Unplug the system then plug it back in.

Specifications

Stereo Amplifier AX-UXG66

Output power:	48 W (24 W + 24 W) at 6 Ω (Max.) 42 W (21 W + 21 W) at 6 Ω (10% THD)
Load impedance:	6 Ω (6 Ω to 16 Ω allowance)
Audio output level/Impedance (at 1 kHz):	Sub Woofer 800 mV/440 Ω
Power requirement:	AC 230 V \sim , 50 Hz
Power consumption:	63 W (at operation) 2.0 W (on standby: with Dimmer)
Dimensions (approx.):	182 mm x 81 mm x 313 mm (W/H/D) (7 ³ / ₁₆ in. x 3 ¹ / ₄ in. x 12 ³ / ₈ in.)
Mass (approx.):	3.8 kg (8.4 lbs)

Compact Disc/Tuner XT-UXG66R

Audio input sensitivity/Impedance (at 1 kHz):	AUX: 400 mV/47 kΩ
[CD section]	
Digital output:	OPTICAL DIGITAL OUT
Wow and flutter:	Immeasurable
[Tuner section]	
FM tuning range:	87.50 MHz – 108.00 MHz
AM tuning range:	MW: 522 kHz – 1 629 kHz LW: 144 kHz – 288 kHz
Dimensions (approx.):	181 mm x 81 mm x 313 mm (W/H/D) (7 ³ / ₁₆ in. x 3 ¹ / ₄ in. x 12 ³ / ₈ in.)
Mass (approx.):	1.9 kg (4.2 lbs)

Cassette Deck TD-UXG66

Frequency response :	
Normal	30 Hz – 15 000 Hz
High position	30 Hz – 16 000 Hz
Wow and flutter:	0.1 % WRMS
Dimensions (approx.):	181 mm x 81 mm x 304 mm (W/H/D) (7 ³ / ₁₆ in. x 3 ¹ / ₄ in. x 12 in.)
Mass (approx.):	1.9 kg (4.2 lbs)

Speaker System

Type:	2-way Bass-Reflex Type
Speaker unit:	Woofer 11.5 cm (4 ⁹ / ₁₆ in.) Cone x 1 Tweeter 3.0 cm (1 ³ / ₁₆ in.) Balanced Dome x 1
Power handling capacity:	24 W
Impedance:	6 Ω
Frequency range:	40 Hz – 20 000 Hz
Sound Pressure Level:	85.5 dB/W•m
Dimensions (approx.):	157 mm x 295 mm x 232 mm (W/H/D) (6 ³ / ₁₆ in. x 11 ⁵ / ₈ in. x 9 ³ / ₁₆ in.)
Mass (approx.):	3.3 kg (7.3 lbs) each

Supplied Accessories

See page 6.

Design and specifications are subject to change without notice.

US and foreign patents licensed from Dolby Laboratories Licensing Corporation.

SAFETY INSTRUCTIONS

“SOME DOS AND DON'TS ON THE SAFE USE OF EQUIPMENT”

This equipment has been designed and manufactured to meet international safety standards but, like any electrical equipment, care must be taken if you are to obtain the best results and safety is to be assured.

Do read the operating instructions before you attempt to use the equipment.

Do ensure that all electrical connections (including the mains plug, extension leads and interconnections between pieces of equipment) are properly made and in accordance with the manufacturer's instructions. Switch off and withdraw the mains plug when making or changing connections.

Do consult your dealer if you are ever in doubt about the installation, operation or safety of your equipment.

Do be careful with glass panels or doors on equipment.

DON'T continue to operate the equipment if you are in any doubt about it working normally, or if it is damaged in any way—switch off, withdraw the mains plug and consult your dealer.

DON'T remove any fixed cover as this may expose dangerous voltages.

DON'T leave equipment switched on when it is unattended unless it is specifically stated that it is designed for unattended operation or has a standby mode.

Switch off using the switch on the equipment and make sure that your family know how to do this.

Special arrangements may need to be made for infirm or handicapped people.

DON'T use equipment such as personal stereos or radios so that you are distracted from the requirements of traffic safety. It is illegal to watch television whilst driving.

DON'T listen to headphones at high volume as such use can permanently damage your hearing.

DON'T obstruct the ventilation of the equipment, for example with curtains or soft furnishings.

Overheating will cause damage and shorten the life of the equipment.

DON'T use makeshift stands and NEVER fix legs with wood screws — to ensure complete safety always fit the manufacturer's approved stand or legs with the fixings provided according to the instructions.

DON'T allow electrical equipment to be exposed to rain or moisture.

ABOVE ALL

— NEVER let anyone, especially children, push anything into holes, slots or any other opening in the case - this could result in a fatal electrical shock.;

— NEVER guess or take chances with electrical equipment of any kind -it is better to be safe than sorry!



Free Manuals Download Website

<http://myh66.com>

<http://usermanuals.us>

<http://www.somanuals.com>

<http://www.4manuals.cc>

<http://www.manual-lib.com>

<http://www.404manual.com>

<http://www.luxmanual.com>

<http://aubethermostatmanual.com>

Golf course search by state

<http://golfingnear.com>

Email search by domain

<http://emailbydomain.com>

Auto manuals search

<http://auto.somanuals.com>

TV manuals search

<http://tv.somanuals.com>