

JVC



CD RECEIVER

KD-S670

ENGLISH

RECEPTOR CON CD

KD-S670

ESPAÑOL

RECEPTEUR CD

KD-S670

FRANÇAIS

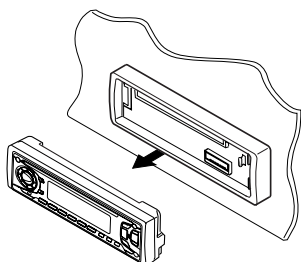
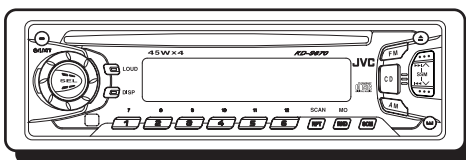

COMPACT
disc
DIGITAL AUDIO

For installation and connections, refer to the separate manual.
Para la instalación y las conexiones, refiérase al manual separado.
Pour l'installation et les raccordements, se référer au manuel séparé.

INSTRUCTIONS

MANUAL DE INSTRUCCIONES
MANUEL D'INSTRUCTIONS

For customer Use:

Enter below the Model No. and Serial No. which are located on the top or bottom of the cabinet. Retain this information for future reference.

Model No. _____

Serial No. _____

GET0011-001A

[J]

INFORMATION (For USA)

This equipment has been tested and found to comply with the limits for a Class B digital device, pursuant to Part 15 of the FCC Rules. These limits are designed to provide reasonable protection against harmful interference in a residential installation. This equipment generates, uses, and can radiate radio frequency energy and, if not installed and used in accordance with the instructions, may cause harmful interference to radio communications. However, there is no guarantee that interference will not occur in a particular installation. If this equipment does cause harmful interference to radio or television reception, which can be determined by turning the equipment off and on, the user is encouraged to try to correct the interference by one or more of the following measures:

- Reorient or relocate the receiving antenna.
- Increase the separation between the equipment and receiver.
- Connect the equipment into an outlet on a circuit different from that to which the receiver is connected.
- Consult the dealer or an experienced radio/TV technician for help.

IMPORTANT FOR LASER PRODUCTS**Precautions:**

1. CLASS 1 LASER PRODUCT
2. **DANGER:** Invisible laser radiation when open and interlock failed or defeated. Avoid direct exposure to beam.
3. **CAUTION:** Do not open the top cover. There are no user-serviceable parts inside. Leave all servicing to qualified service personnel.
4. **CAUTION:** This CD player uses invisible laser radiation, however, is equipped with safety switches to prevent radiation emission when unloading CDs. It is dangerous to defeat the safety switches.
5. **CAUTION:** Use of controls, adjustments or performance of procedures other than those specified herein may result in hazardous radiation exposure.

How to reset your unit

Press and hold both the SEL (Select) and O/I/ATT (Standby/On/ATT) buttons at the same time for several seconds.

This will reset the built-in microcomputer.

NOTES: Your preset adjustments — such as preset channels or sound adjustments — will also be erased.

If a CD is in the unit, it will eject when you reset the unit. Pay attention not to drop the CD.

O/I/ATT
(Standby/On/ATT)

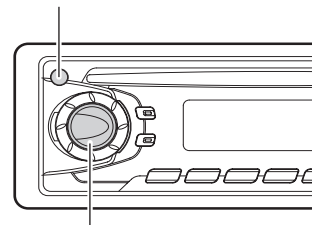

SEL (Select)

BEFORE USE*** For safety....**

- Do not raise the volume level too much, as this will block outside sounds, making driving dangerous.
- Stop the car before performing any complicated operations.

***Temperature inside the car....**

If you have parked the car for a long time in hot or cold weather, wait until the temperature in the car becomes normal before operating the unit.

Thank you for purchasing a JVC product. Please read all instructions carefully before operation, to ensure your complete understanding and to obtain the best possible performance from the unit.

CONTENTS

How to reset your unit 2



BASIC OPERATIONS 4

RADIO OPERATIONS 5

Listening to the radio 5

Storing stations in memory 6

FM station automatic preset: SSM 6

Manual preset 7

Tuning into a preset station 8

Other convenient tuner functions 9

Scanning broadcast stations 9

Selecting FM reception sound 9



CD OPERATIONS 10

Playing a CD 10

Locating a track or a particular portion on a CD 11

Selecting CD playback modes 12

Other convenient CD functions 12

Prohibiting CD ejection 12



SOUND ADJUSTMENTS 13

Adjusting the sound 13

Turning on/off the loudness function 14

Using the Sound Control Memory 15

Selecting and storing the sound modes 15

Recalling the sound modes 16

Canceling Advanced SCM 17

Storing your own sound adjustments 18



OTHER MAIN FUNCTIONS 19

Setting the clock 19

Selecting the level display 21

Detaching the control panel 22



REMOTE OPERATIONS 23

Installing the battery 23

Using the remote controller 24

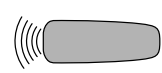

MAINTENANCE 25

Handling CDs 25

TROUBLESHOOTING 26



SPECIFICATIONS 27



BASIC OPERATIONS

ENGLISH

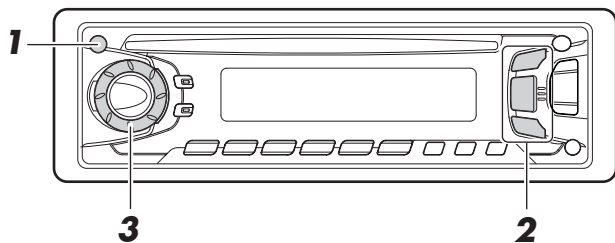

Note:

When you use this unit for the first time, set the built-in clock correctly, see page 19.

1



Turn on the power.

Note on One-Touch Operation:

When you select a source in step 2 below, the power automatically comes on. You do not have to press this button to turn on the power.

2

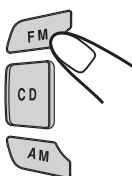

Select the source.

To operate the tuner, see pages 5 – 9.

To operate the CD player, see pages 10 – 12.

3

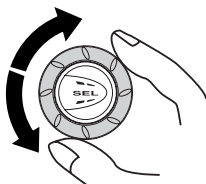

Adjust the volume.



Volume level indicator

Volume level appears

4

Adjust the sound as you want (see pages 13 – 18).

To drop the volume in a moment

Press briefly while listening to any source. “ATT” starts flashing on the display, and the volume level will drop in a moment.

To resume the previous volume level, press the button briefly again.

To turn off the power

Press for more than 1 second.

Listening to the radio

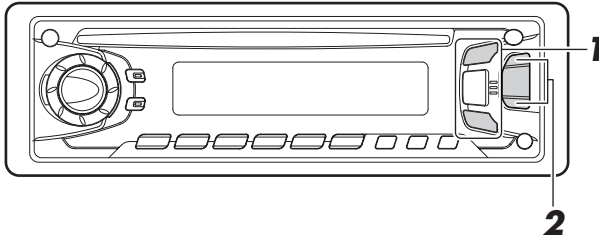

1

Select the band (FM1, FM2, FM3 or AM).

You can select any one of FM1, FM2, and FM3 to listen to an FM station.

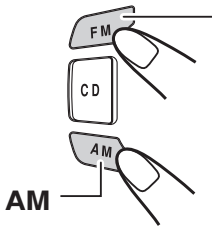

selected band appears



Audio or volume level indicator



2

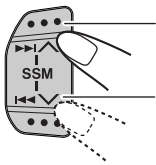

To search stations of higher frequencies.

To search stations of lower frequencies.

Start searching a station.

When a station is received, searching stops.



To stop searching before a station is received, press the same button you have pressed for searching.

To tune in a particular frequency without searching:

1 Select the band (FM or AM).

Press FM or AM repeatedly.

2 Press and hold $\blacktriangleright\blacktriangleright\blacktriangleup$ or $\blacktriangleleft\blacktriangleleft\blacktriangledown$ until "M" starts flashing on the display.

Now you can manually change the frequency while "M" is flashing.

3 Press $\blacktriangleright\blacktriangleright\blacktriangleup$ or $\blacktriangleleft\blacktriangleleft\blacktriangledown$ repeatedly until the frequency you want is reached.

• If you hold down the button, the frequency keeps changing until you release the button.



Storing stations in memory

You can use one of the following two methods to store broadcasting stations in memory.

- Automatic preset of FM stations: SSM (Strong-station Sequential Memory)
- Manual preset of both FM and AM stations

FM station automatic preset: SSM

You can preset 6 local FM stations in each FM band (FM1, FM2, and FM3).

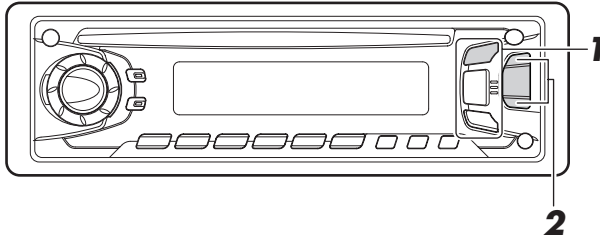

1

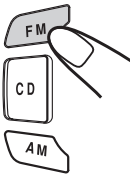

Select the FM band number (FM1, FM2 or FM3) you want to store FM stations into.

2

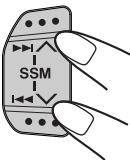

Press and hold the both buttons for more than 2 seconds.

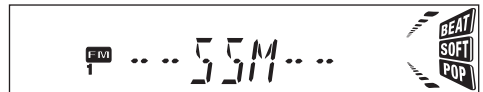

“SSM” appears, then disappears when automatic preset is over.

Local FM stations with the strongest signals are searched and stored automatically in the band number you have selected (FM1, FM2 or FM3). These stations are preset in the number buttons — No. 1 (lowest frequency) to No. 6 (highest frequency).

When automatic preset is over, the station stored in number button 1 will be automatically tuned in.

Manual preset

You can preset up to 6 stations in each band (FM1, FM2, FM3 and AM) manually.

EXAMPLE: Storing an FM station of 88.3 MHz into the preset number 1 of the FM1 band

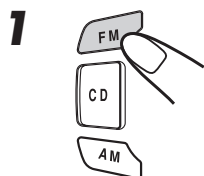
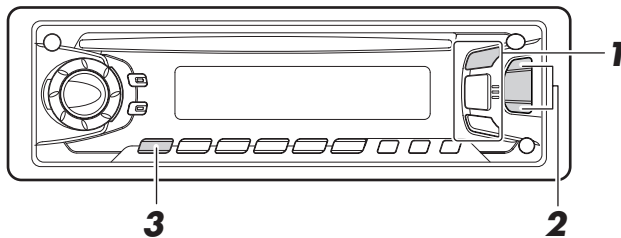

Select the FM1 band.

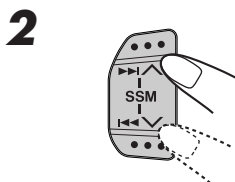

Tune into a station of 88.3 MHz.

See page 5 to tune into a station.

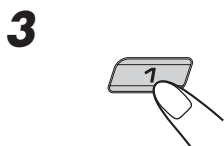

Press and hold the button for more than 2 seconds.



"P1" flashes for a few seconds.

4 Repeat the above procedure to store other stations into other preset numbers.

Notes:

- A previously preset station is erased when a new station is stored in the same preset number.
- Preset stations are erased when the power supply to the memory circuit is interrupted (for example, during battery replacement). If this occurs, preset the stations again.

Tuning into a preset station

You can easily tune into a preset station.
Remember that you must store stations first. If you have not stored them yet, see pages 6 and 7.

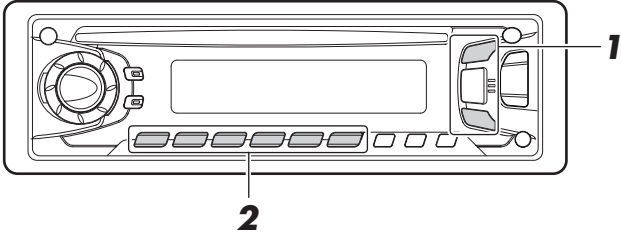

1

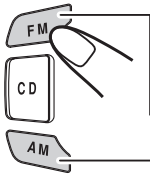

Select the band (FM1, FM2, FM3 or AM) you want.



2



Select the number (1 – 6) for the preset station you want.

Other convenient tuner functions

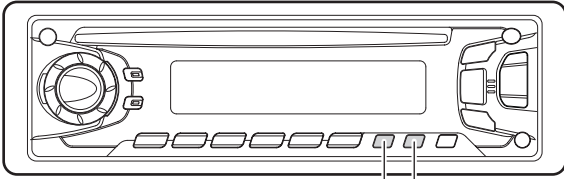

RPT/SCAN MO/RND

Scanning broadcast stations

When you press RPT/SCAN while listening to the radio, station scanning starts. Each time a broadcast is tuned in, scanning stops for about 5 seconds (tuned frequency number flashes on the display), and you can check what program is now being broadcasted.

If you want to listen to that program, press the same button again to stop scanning.

Selecting FM reception sound

When an FM stereo broadcast is hard to receive:

Press MO/RND (Mono/Random) while listening to an FM stereo broadcast. The sound you hear becomes monaural but reception will be improved.



Lights up when receiving an FM broadcast in stereo.

To restore the stereo effect, press the same button again.



CD OPERATIONS

Playing a CD

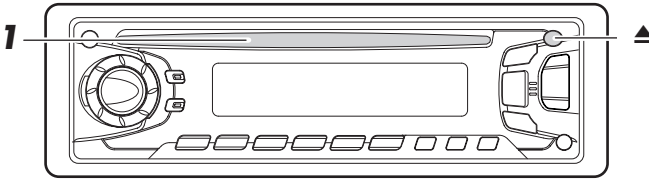

1

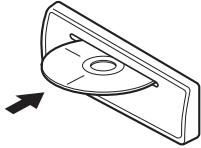

Insert a disc into the loading slot.

The unit turns on, draws a CD and starts playback automatically.

- When a CD is inserted upside down, “EJECT” appears on the display and the CD automatically ejects.

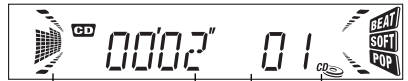
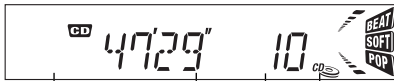
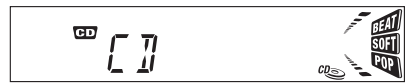

Total playing time of the inserted disc

Total track number of the inserted disc

Elapsed playing time

Current track time

Note on One-Touch Operation:

When a CD is already in the loading slot, pressing CD turns on the unit and starts playback automatically.

CAUTION on Volume Setting

CDs produces very little noise compared with other sources. If the volume level is adjusted for the tuner, for example, the speakers may be damaged by the sudden increase in the output level. Therefore, lower the volume before playing a CD and adjust it as required during playback.

To stop play and eject the CD

Press ▲.

CD play stops and the CD automatically ejects from the loading slot. The source changes to the tuner (you will hear the last received station).

If you change the source to FM or AM, the CD play also stops (without ejecting the CD this time).

- If the ejected disc is not removed for about 15 seconds, the disc is automatically inserted again into the loading slot to protect it from dust. (CD play will not start this time.)
- You can eject the CD even when the unit is turned off.



Locating a track or a particular portion on a CD

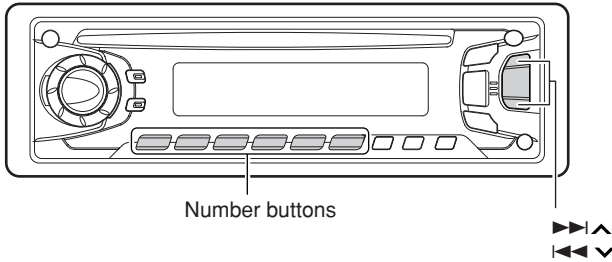

To fast forward or reverse the track

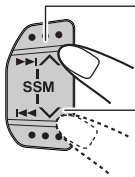

Press and hold **▶▶|▲**, while playing a CD, to fast forward the track.

Press and hold **◀◀|▼**, while playing a CD, to reverse the track.

To go to the next track or the previous track

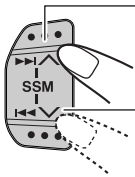

Press **▶▶|▲** briefly, while playing a CD, to go ahead to the beginning of the next track. Each time you press the button consecutively, the beginning of the next tracks is located and played back.

Press **◀◀|▼** briefly, while playing a CD, to go back to the beginning of the current track. Each time you press the button consecutively, the beginning of the previous tracks is located and played back.

To go to a particular track directly

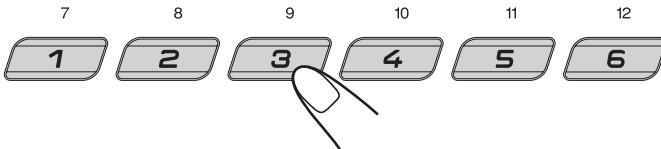

Press the number button corresponding to the track number to start its playback.

- To select a track number from 1 – 6:
Press 1 (7) – 6 (12) briefly.
- To select a track number from 7 – 12:
Press and hold 1 (7) – 6 (12) for more than 1 second.



Selecting CD playback modes

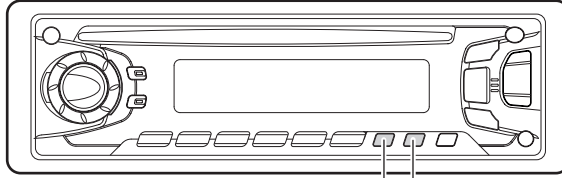

RPT/SCAN MO/RND

To play back tracks at random (Random Play)

You can play back all tracks on the CD at random.

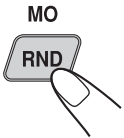

Each time you press MO/RND (Mono/Random) while playing a CD, CD random play mode turns on and off alternatively. When the random mode is turned on, the RND indicator lights up on the display and a track randomly selected starts playing.



To play back tracks repeatedly (Repeat Play)

You can play back the current track repeatedly.



Each time you press RPT/SCAN (Repeat/Scan) while playing a CD, CD repeat play mode turns on and off alternatively. When the repeat mode is turned on, the RPT indicator lights up on the display.



Track number of the currently playing track

Other convenient CD functions

Prohibiting CD ejection

You can prohibit the CD ejection and can “lock” a CD in the loading slot.

Press and hold CD and ▲ for more than 2 seconds. “EJECT” flashes on the display for about 5 seconds, and the CD is “locked.”

To cancel the prohibition and “unlock” the CD, press and hold CD and ▲ for more than 2 seconds again. “EJECT” appears on the display, and the CD ejects from the loading slot.

Adjusting the sound

You can adjust the treble/bass sound and the speaker balance.

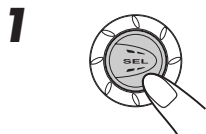
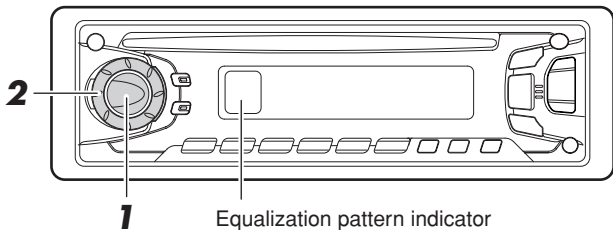

Select the item you want to adjust.

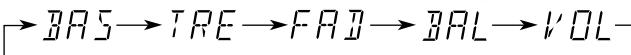

Indication	To do:	Range
BAS (Bass)	Adjust the bass	-06 (min.) — +06 (max.)
TRE (Treble)	Adjust the treble	-06 (min.) — +06 (max.)
FAD (Fader)*	Adjust the front and rear speaker balance	R06 (rear only) — F06 (front only)
BAL (Balance)	Adjust the left and right speaker balance	L06 (left only) — R06 (right only)
VOL (Volume)	Adjust the volume	00 (min.) — 50 (max.)

Note:

* If you are using a two-speaker system, set the fader level to “00.”

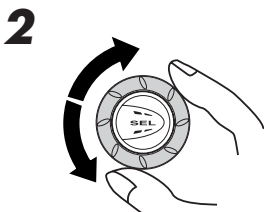

Adjust the level.

Equalization pattern changes as you adjust the bass or treble.

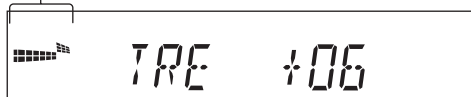

Note:

Normally the control dial works as the volume control. So you do not have to select “VOL” to adjust the volume level.



Turning on/off the loudness function

The human ear is less sensitive to low and high frequencies at low volumes. The loudness function can boost these frequencies to produce well-balanced sound at low volume level.

Each time you press LOUD, the loudness function turns on and off alternatively.



Using the Sound Control Memory

You can select and store a preset sound adjustment suitable to each playback source. (**Advanced SCM**)

Selecting and storing the sound modes

Once you select a sound mode, it is stored in memory, and will be recalled every time you select the same source. A sound mode can be stored each of the following sources — FM1, FM2, FM3, AM or CD.

- If you do not want to store the sound mode separately for each playback source, but want to use the same sound mode for all the sources, see “Canceling Advanced SCM” on page 17.

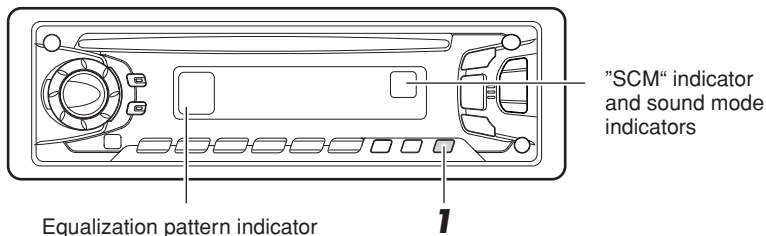
1

Select the sound mode you want.

Each time you press the button, the sound mode changes as follows.

→ *SCM OFF* → *BEAT* → *SOFT* → *POP* →

- When “SCM LINK” is set to “LINK ON”, the selected sound mode can be stored in memory for the current source and the effect applies only to the current source. Each time you change the playback source, the SCM indicator flashes on the display.
- When “SCM LINK” is set to “LINK OFF”, the selected sound mode effect applies to any source.

Indication	For:	Preset values		
		Bass	Treble	Loudness
SCM OFF	(Flat sound)	00	00	On
BEAT	Rock or disco music	+02	00	On
SOFT	Quiet background music	+01	-03	Off
POP	Light music	+04	+01	Off

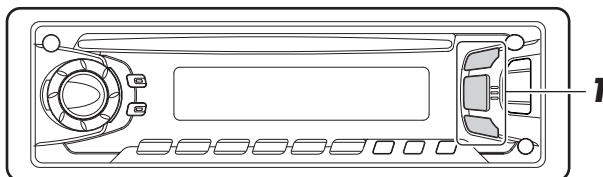
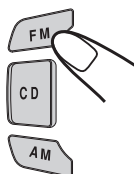

Recalling the sound modes

**1**

When “SCM LINK” is set to “LINK ON,” select the source.

The sound mode stored in memory for the selected source is recalled.

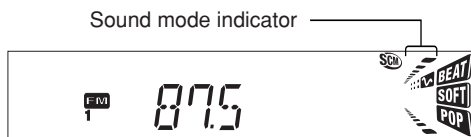
**Notes:**

- You can adjust each sound mode to your preference, and store it in memory. If you want to adjust and store your original sound mode, see “Storing your own sound adjustments” on page 18.
- To adjust the bass and treble reinforcement levels or to turn on/off the loudness function temporarily, see pages 13 and 14. (Your adjustments will be cancelled if another source is selected.)

Canceling Advanced SCM

You can cancel the Advanced SCM (Sound Control Memory), and unlink the sound modes and the playback sources.

When shipped from the factory, a different sound mode can be stored in memory for each source so that you can change the sound modes simply by changing the sources.

LINK ON: Advanced SCM (different SCMs for different sources)

LINK OFF: Conventional SCM (one SCM for all sources)

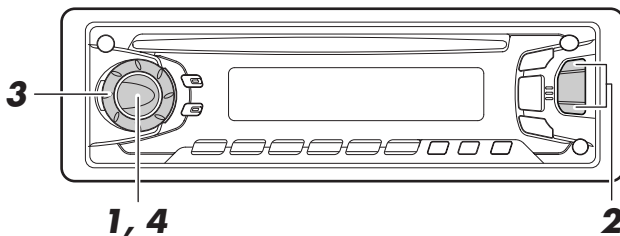
**1**

Press and hold SEL for more than 2 seconds. "CLOCK H," "CLOCK M," "SCM LINK," or "LEVEL" appears on the display.

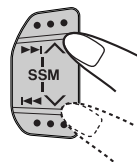
2

Select "SCM LINK" if not shown on the display.

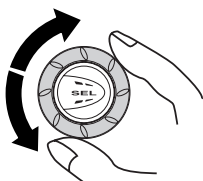
**3**

Select the desired mode — "LINK ON" or "LINK OFF".

4

Finish the setting.



Storing your own sound adjustments

You can adjust the sound modes (BEAT, SOFT, POP: see page 15) to your preference and store your own adjustments in memory.

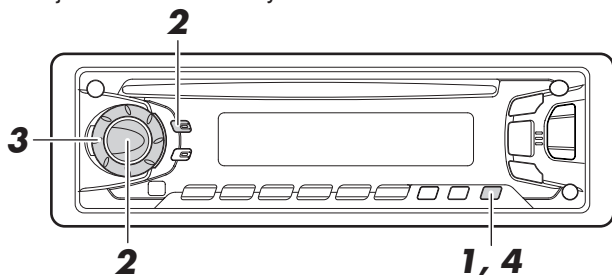
**1**

Call up the sound mode you want to adjust.
See page 15 for details.

**Within
5 seconds**

2

To adjust the bass or treble sound level
Select "BAS" or "TRE."



To turn on or off the loudness function
Each time you press LOUD, the loudness
function turns on and off alternatively. (→ go to step 4)

**Within
5 seconds**

3

Adjust the bass or treble level.
See page 13 for details.

**Within
5 seconds**

4

Press and hold SCM until the sound mode
you have selected in step 1 flashes on the
display.
Your setting is stored in memory.

5

Repeat the same procedure to store other settings.

To reset to the factory settings

Repeat the same procedure and reassign the preset values listed in the table on page 15.

Setting the clock

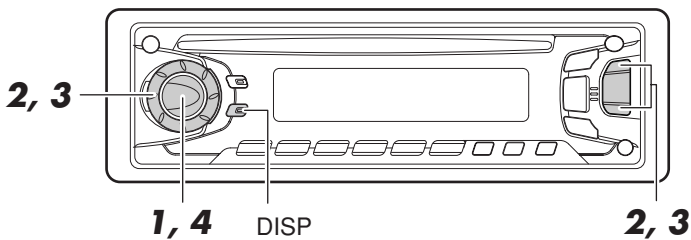

1



Press and hold SEL for more than 2 seconds.

“CLOCK H,” “CLOCK M,” “SCM LINK,” or “LEVEL” appears on the display.

2

1.

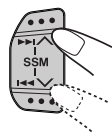

2.

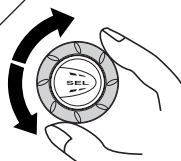

Set the hour.

1. Select “CLOCK H” if not shown on the display.



2. Adjust the hour.

3

1.

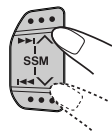

2.



Set the minute.

1. Select “CLOCK M.”



2. Adjust the minute.

4



Start the clock.

To check the current clock time (changing the display mode)

Press DISP repeatedly. Each time you press the button, the display mode changes as follows.

During tuner operation:

Frequency ↔ Clock

During CD operation:

Elapsed playing time ↔ Clock

- If the unit is not in use when you press DISP, the power turns on, the clock time is shown for 5 seconds, then the power turns off.

Selecting the level display

You can select the level display according to your preference.
 When shipped from the factory, "AUDIO 2" is selected.
AUDIO 1: Shows the audio level indicator and the equalization pattern indicator.
AUDIO 2: Alternates "AUDIO 1" setting and illumination display.
OFF: Erases the audio level indicator and the equalization pattern indicator.

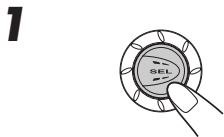
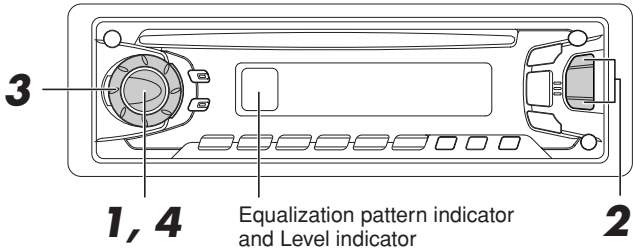

Press and hold SEL for more than 2 seconds. "CLOCK H," "CLOCK M," "SCM LINK," or "LEVEL" appears on the display.

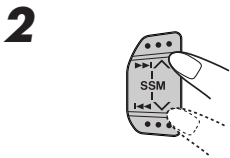

Select "LEVEL" if not shown on the display.

```

    → CLOCK H → CLOCK M → SCM LINK
    ← LEVEL ←
    
```

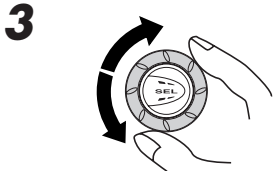

Select the desired mode—"AUDIO 1", AUDIO 2" or "OFF".



Finish the setting.

Detaching the control panel

You can detach the control panel when leaving the car. When detaching or attaching the control panel, be careful not to damage the connectors on the back of the control panel and on the panel holder.

How to detach the control panel

Before detaching the control panel, be sure to turn off the power.

- 1 Unlock the control panel.

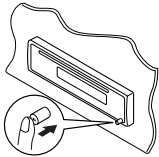

- 2 Lift and pull the control panel out of the unit.

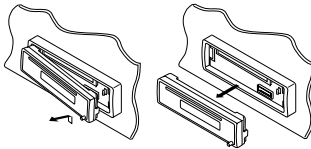

- 3 Put the detached control panel into the case provided.

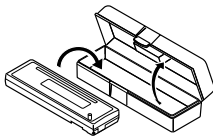

How to attach the control panel

- 1 Insert the left side of the control panel into the groove on the panel holder.

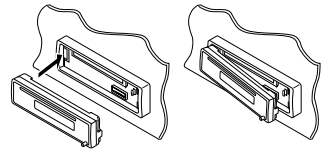

- 2 Press the right side of the control panel to fix it to the panel holder.

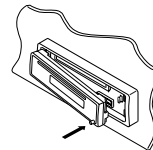

Note on cleaning the connectors:

If you frequently detach the control panel, the connectors will deteriorate.

To minimize this possibility, periodically wipe the connectors with a cotton swab or cloth moistened with alcohol, being careful not to damage the connectors.

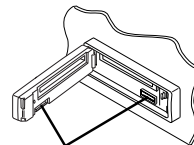

Connectors



Before using the remote controller:

- Aim the remote controller directly at the remote sensor on the main unit. Make sure there is no obstacle in between.
- Do not expose the remote sensor to strong light (direct sunlight or artificial lighting).

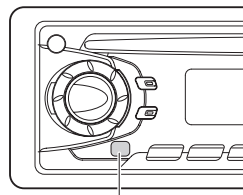

Remote sensor

Installing the battery

When the controllable range or effectiveness of the remote controller decreases, replace the battery.

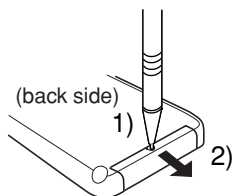

1. Remove the battery holder.

- 1) Push out in the direction indicated by the arrow using a ball point pen or a similar tool.
- 2) Remove the battery holder.

Lithium coin battery
(product number:
CR2025)

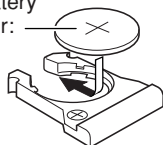

2. Place the battery.

Slide the battery into the holder with the + side facing upwards so that the battery is fixed in the holder.

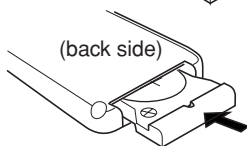

3. Return the battery holder.

Insert again the battery holder pushing it until you hear a clicking sound.

WARNING:

- Store the batteries in a place which children cannot reach.
If a child accidentally swallows the battery, immediately consult a doctor.
- Do not recharge, short, disassemble or heat the batteries or dispose of in a fire.
Doing any of these things may cause the batteries to give off heat, crack or start a fire.
- Do not leave the batteries with other metallic materials.
Doing this may cause the batteries to give off heat, crack or start a fire.
- When throwing away or saving the batteries, wrap in tape and insulate; otherwise, it may cause the batteries to give off heat, crack or start a fire.
- Do not poke the batteries with tweezers or similar tools.
Doing this may cause the batteries to give off heat, crack or start a fire.

Using the remote controller

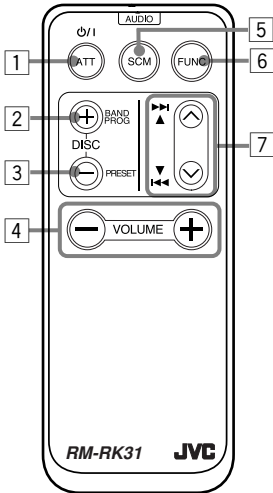

- 1 Functions the same as the O/I/ATT button on the main unit.
- 2
 - Functions as the BAND button while listening to the radio. Each time you press the button, the band changes.
 - Does not function as the PROG button.
- 3
 - Functions as the PRESET button while listening to the radio. Each time you press the button, the preset station number increases, and the selected station is tuned in.
- 4 Functions the same as the control dial on the main unit.

Note: *These buttons cannot be used for the clock (CLOCK H, CLOCK M), SCM LINK and LEVEL (see pages 19, 17 and 21).*
- 5 Selects the sound mode. Each time you press SCM (Sound Control Memory), the mode changes.
- 6 Selects the source. Each time you press FUNC (function), the source changes.
- 7
 - Searches stations while listening to the radio.
 - Fast forwards or reverses the track if pressed and held while listening to a CD.
 - Skips to the beginning of the next tracks or goes back to the beginning of the current (or previous tracks) if pressed briefly while listening to a CD.

Handling CDs

This unit has been designed only to reproduce the CDs bearing the  mark. Other discs cannot be played back.

How to handle CDs

When removing a CD from its case, press down the center holder of the case and lift the CD out, holding it by the edges.

- Always hold the CD by the edges. Do not touch its recording surface.

When storing a CD into its case, gently insert the CD around the center holder (with the printed surface facing up).

- Make sure to store CDs into the cases after use.

To keep CDs clean

A dirty CD may not play correctly. If a CD does becomes dirty, wipe it with a soft cloth in a straight line from center to edge.

To play new CDs

New CDs may have some rough spots around the inner and outer edges. If such a CD is used, this unit may reject the CD.

To remove these rough spots, rub the edges with a pencil or ball-point pen, etc.

Moisture condensation

Moisture may condense on the lens inside the CD player in the following cases:

- After starting the heater in the car.
 - If it becomes very humid inside the car.
- Should this occur, the CD player may malfunction. In this case, eject the CD and leave the unit turned on for a few hours until the moisture evaporates.

Center holder



CAUTIONS:

- Do not insert 8cm (3 3/16") CDs (single CDs) into the loading slot. (Such CDs cannot be ejected.)
- Do not insert any CD of unusual shape – like a heart or flower; otherwise, it will cause a malfunction.
- Do not expose CDs to direct sunlight or any heat source or place them in a place subject to high temperature and humidity. Do not leave them in a car.
- Do not use any solvent (for example, conventional record cleaner, spray, thinner, benzine, etc.) to clean CDs.

When playing a CD-R (Recordable)

You can play back your original CD-Rs on this receiver.

- Before playing back CD-Rs, read their instructions or cautions carefully.
- Some CD-Rs recorded on CD recorders may not be played back on this receiver because of their disc characteristics, and of the following reasons:
 - Discs are dirty or scratched.
 - Moisture condensation occurs on the lens inside the unit.
 - The pickup lens inside the CD player is dirty.
- Use only "finalized" CD-Rs.
- CD-RWs (Rewritable) cannot be played back on this receiver.

About mistracking:

Mistracking may result from driving on extremely rough roads. This does not damage the unit and the CD, but will be annoying.

We recommend that you stop CD play while driving on such rough roads.

TROUBLESHOOTING

What appears to be trouble is not always serious. Check the following points before calling a service center.

Symptoms	Causes	Remedies
• CD cannot be played back.	CD is inserted upside down.	Insert the CD correctly.
• CD sound is sometimes interrupted.	You are driving on rough roads.	Stop CD play while driving rough roads.
	CD is scratched.	Change the CD.
	Connections are incorrect.	Check the cords and connections.
• Sound cannot be heard from the speakers.	The volume is turned to the minimum level.	Adjust it to the optimum level.
	Connections are incorrect.	Check the cords and connections.
• SSM (Strong-station Sequential Memory) automatic preset does not work.	Signals are too weak.	Store stations manually.
• Static noise while listening to the radio.	The antenna is not connected firmly.	Connect the antenna firmly.
• "NO DISC" appears on the display.	No CD is in the loading slot.	Insert a CD into the loading slot.
	CD is inserted incorrectly.	Insert it correctly.
• CD can be neither played back nor ejected.	The CD player may function incorrectly.	Press ⏏/ATT and ▲ at the same time for more than 2 seconds. Be careful not to drop CD when it is ejected.
• The unit does not work at all.	The built-in microcomputer may function incorrectly due to noise, etc.	Press ⏏/ATT and SEL at the same time for more than 2 seconds to reset the unit. (The clock setting and preset stations stored in memory are erased.) (See page 2.)

SPECIFICATIONS

AUDIO AMPLIFIER SECTION

Maximum Power Output:

Front: 45 watts per channel

Rear: 45 watts per channel

Continuous Power Output (RMS):

Front: 17 watts per channel into 4 Ω , 40 to 20 000 Hz at no more than 0.8% total harmonic distortion.

Rear: 17 watts per channel into 4 Ω , 40 to 20 000 Hz at no more than 0.8% total harmonic distortion.

Load Impedance: 4 Ω (4 Ω to 8 Ω allowance)

Tone Control Range

Bass: ± 10 dB at 100 Hz

Treble: ± 10 dB at 10 kHz

Frequency Response: 40 Hz to 20 000 Hz

Signal-to-Noise Ratio: 70 dB

Line-Out Level/Impedance: 2.0 V/20 k Ω load (full scale)

Output Impedance: 1 k Ω

TUNER SECTION

Frequency Range

FM: 87.5 MHz to 107.9 MHz

AM: 530 kHz to 1 710 kHz

[FM Tuner]

Usable Sensitivity: 11.3 dBf (1.0 μ V/75 Ω)

50 dB Quieting Sensitivity:

16.3 dBf (1.8 μ V/75 Ω)

Alternate Channel Selectivity (400 kHz):

65 dB

Frequency Response: 40 Hz to 15 000 Hz

Stereo Separation: 35 dB

Capture Ratio: 1.5 dB

[AM Tuner]

Sensitivity: 20 μ V

Selectivity: 35 dB

CD PLAYER SECTION

Type: Compact disc player

Signal Detection System: Non-contact optical pickup (semiconductor laser)

Number of channels: 2 channels (stereo)

Frequency Response: 5 Hz to 20 000 Hz

Dynamic Range: 96 dB

Signal-to-Noise Ratio: 98 dB

Wow and Flutter: Less than measurable limit

GENERAL

Power Requirement

Operating Voltage: DC 14.4 volts (11 volts to 16 volts allowance)

Allowable Working Temperature:

0°C to +40°C (32°F to 104°F)

Grounding System: Negative ground

Dimensions (W x H x D)

Installation Size:

182 mm x 52 mm x 150 mm

(7-3/16" x 2-1/16" x 5-15/16")

Panel Size: 188 mm x 58 mm x 14 mm

(7-7/16" x 2-5/16" x 5/8")

Mass: 1.3 kg (2.9 lbs) (excluding accessories)

Design and specifications subject to change without notice.

If a kit is necessary for your car, consult your telephone directory for the nearest car audio speciality shop.



JVC

**MOBILE
ENTERTAINMENT**

<http://www.jvcmobile.com>

Visit us on-line for

Technical Support & Customer Satisfaction Survey.

US RESIDENTS ONLY

**Having TROUBLE with operation?
Please reset your unit**

**Refer to page of How to Reset
Still having trouble??**

USA ONLY

Call 1-800-252-5722

<http://www.jvcservice.com>

We can help you!

JVC

VICTOR COMPANY OF JAPAN, LIMITED



EN, SP, FR



1000HISFLEJES

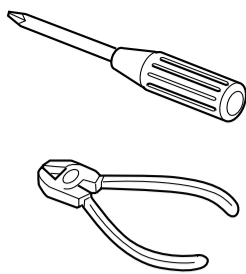

ENGLISH

- This unit is designed to operate on 12 volts DC, NEGATIVE ground electrical systems.

INSTALLATION (IN-DASH MOUNTING)

- The following illustration shows a typical installation. However, you should make adjustments corresponding to your specific car. If you have any questions or require information regarding installation kits, consult your JVC car audio dealer or a company supplying kits.

- Before mounting:** Press (Control Panel Release button) to detach the control panel if already attached.
 - * When shipped from the factory, the control panel is packed in the hard case.
- Remove the trim plate.
- Remove the sleeve after disengaging the sleeve locks.
 - Stand the unit.
 - Note:** When you stand the unit, be careful not to damage the fuse on the rear.
 - Insert the 2 handles between the unit and the sleeve, as illustrated, to disengage the sleeve locks.
 - Remove the sleeve.
 - Note:** Be sure to keep the handles for future use after installing the unit.
- Install the sleeve into the dashboard.
 - * After the sleeve is correctly installed in the dashboard, bend the appropriate tabs to hold the sleeve firmly in place, as illustrated.
- Fix the mounting bolt to the rear of the unit's body and place the rubber cushion over the end of the bolt.
- Do the required electrical connections explained on the back of this instructions.
- Slide the unit into the sleeve until it is locked.
- Attach the trim plate so that the projection on the trim plate is fixed to the left side of the unit.
- Attach the control panel.

ESPAÑOL

- Esta unidad está diseñada para funcionar con 12 voltios de CC, con sistemas eléctricos de masa NEGATIVA.

INSTALACION (MONTAJE EN EL TABLERO DE INSTRUMENTOS)

- La siguiente ilustración muestra una instalación típica. Sin embargo usted deberá efectuar los ajustes correspondientes a su automóvil. Si tiene alguna pregunta o necesita información acerca de las herramientas para instalación, consulte con su concesionario de JVC de equipos de audio para automóviles o a una compañía que suministra tales herramientas.

- Antes de instalar:** Pulse (soltar panel de control) para separar el panel de control si ya está unido.
 - * Cuando se envía de la fábrica, el panel de control está embalado en el estuche duro.
- Retire la placa de guarnición.
- Retire la cubierta después de desenganchar los retenes de la cubierta.
 - Ponga la unidad vertical.
 - Nota:** Al poner la unidad vertical, tenga cuidado de no dañar el fusible provisto en la parte posterior.
 - Inserte las dos asas entre la unidad y la cubierta tal como en la ilustración y desenganche los retenes de la cubierta.
 - Retire la cubierta.
 - Nota:** Después de instalar la unidad, asegúrese de guardar las asas para uso futuro.
- Instale la cubierta en el tablero de instrumentos.
 - * Después de que la cubierta esté correctamente instalada en el tablero de instrumentos, doble las lengüetas correspondientes para sostener la cubierta firmemente en su lugar, tal como se muestra.
- Fixe el perno de montaje o la parte trasera del cuerpo de la unidad y coloque el cojín de goma sobre el extremo del perno.
- Realice las conexiones eléctricas requeridas en base a las explicaciones que figuran en la parte de atrás de estas instrucciones.
- Deslice la unidad dentro de la cubierta hasta que quede trabada.
- Coloque la placa de guarnición de manera que el saliente de la misma quede colocado en el lateral izquierdo de la unidad.
- Coloque el panel de control.

FRANÇAIS

- Cet appareil est conçu pour fonctionner sur des sources de courant continu de 12 volts à masse NEGATIVE.

INSTALLATION (MONTAGE DANS LE TABLEAU DE BORD)

- L'illustration suivante est un exemple d'installation typique. Cependant, vous devez faire les ajustements correspondant à votre voiture particulière. Si vous avez des questions ou avez besoin d'information sur des kits d'installation, consulter votre revendeur d'autoradios JVC ou une compagnie d'approvisionnement.

- Avant le montage:** Appuyer sur (déblocage du panneau de commande) pour éventuellement détacher le panneau de commande.
 - * Lorsque ce panneau de commande sort d'usine, il est rangé dans un étui de transport.
- Retirer la plaque d'assemblage.
- Libérer les verrous du manchon et retirer le manchon.
 - Poser l'appareil à la verticale.
 - Remarque:** Lorsque vous mettez l'appareil à la verticale, faire attention de ne pas endommager le fusible situé sur le fond.
 - Insérer les 2 poignées entre l'appareil et le manchon comme indiqué pour désengager les verrous de manchon.
 - Retirer le manchon.
 - Remarque:** S'assurer de garder les poignées pour une utilisation ultérieure, après l'installation de l'appareil.
- Installer le manchon dans le tableau de bord.
 - * Après installation correcte du manchon dans le tableau de bord, plier les bonnes pattes pour maintenir fermement le manchon en place, comme montré.
- Monter le boulon de montage sur l'arrière du corps de l'appareil puis passer l'amortisseur en caoutchouc sur l'extrémité du boulon.
- Réalisez les connexions électriques expliquées au dos de cette page.
- Faire glisser l'appareil dans le manchon jusqu'à ce qu'il soit verrouillé.
- Attachez la plaque d'ajustage de façon que la projection de la plaque soit fixée sur le côté gauche de l'appareil.
- Remonter le panneau de commande.

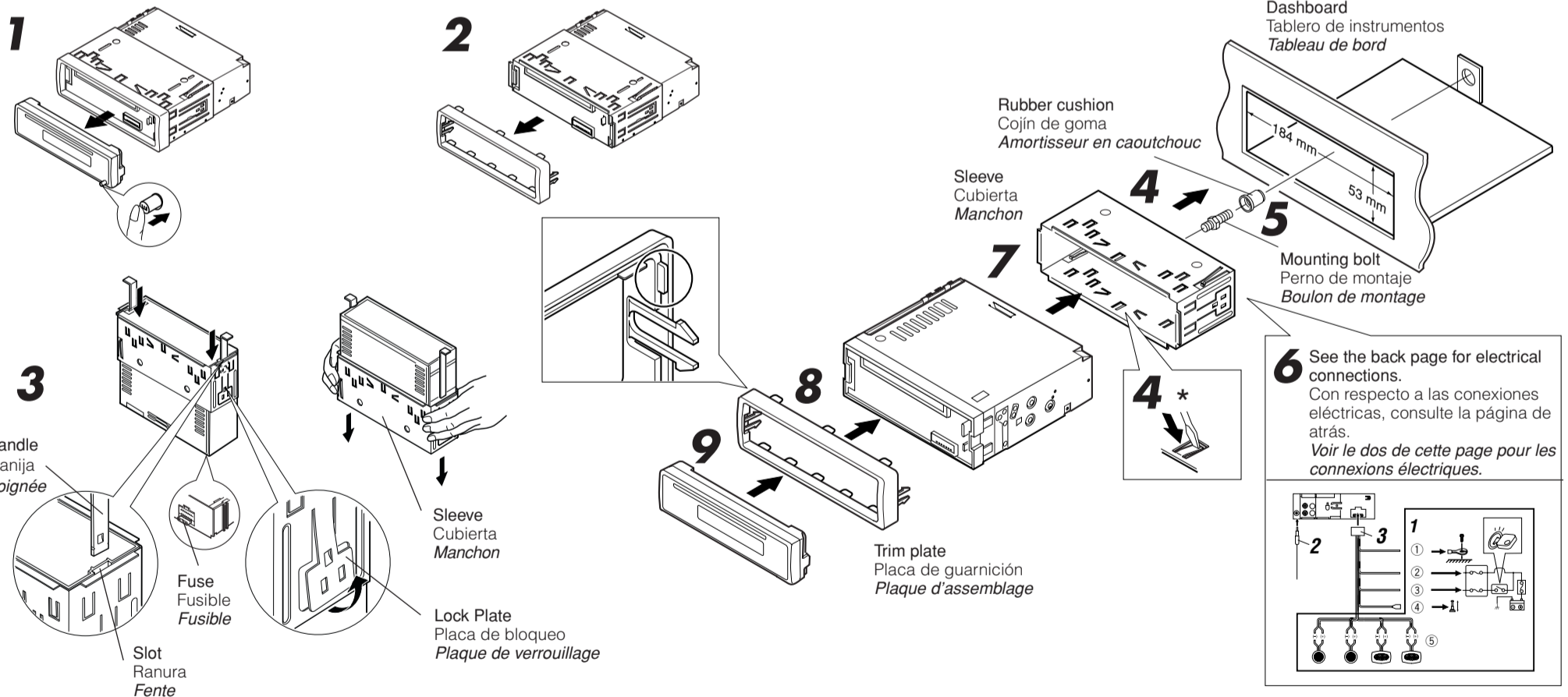

TROUBLESHOOTING

- The fuse blows.**
 - * Are the red and black leads connected correctly?
- Power cannot be turned on.**
 - * Is the yellow lead connected?
- No sound from the speakers.**
 - * Is the speaker output lead short-circuited?
- Sound is distorted.**
 - * Is the speaker output lead grounded?
 - * Are the "-" terminals of L and R speakers grounded in common?
- Unit becomes hot.**
 - * Is the speaker output lead grounded?
 - * Are the "-" terminals of L and R speakers grounded in common?

LOCALIZACION DE AVERIAS

- El fusible se quema.**
 - * ¿Están los conductores rojo y negro correctamente conectados?
- No es posible conectar la alimentación.**
 - * ¿Está el cable amarillo conectado?
- No sale sonido de los altavoces.**
 - * ¿Está el cable de salida del altavoz cortocircuitado?
- El sonido presenta distorsión.**
 - * ¿Está el cable de salida del altavoz conectado a masa?
 - * ¿Están los terminales "-" de los altavoces L y R conectados a una masa común?
- La unidad se calienta.**
 - * ¿Está el cable de salida del altavoz conectado a masa?
 - * ¿Están los terminales "-" de los altavoces L y R conectados a una masa común?

EN CAS DE DIFFICULTÉS

- Le fusible saute.**
 - * Les fils rouge et noir sont-ils raccordés correctement?
- L'appareil ne peut pas être mise sous tension.**
 - * Le fil jaune est-elle raccordée?
- Pas de son des haut-parleurs.**
 - * Le fil de sortie de haut-parleur est-il court-circuité?
- Le son est déformé.**
 - * Le fil de sortie de haut-parleur est-il à la masse?
 - * Les bornes "-" des haut-parleurs gauche et droit sont-elles mises ensemble à la masse?
- L'appareil devient chaud.**
 - * Le fil de sortie de haut-parleur est-il à la masse?
 - * Les bornes "-" des haut-parleurs gauche et droit sont-elles mises ensemble à la masse?

- When using the optional stay
- Cuando emplea un soporte opcional
- Lors de l'utilisation du hauban en option

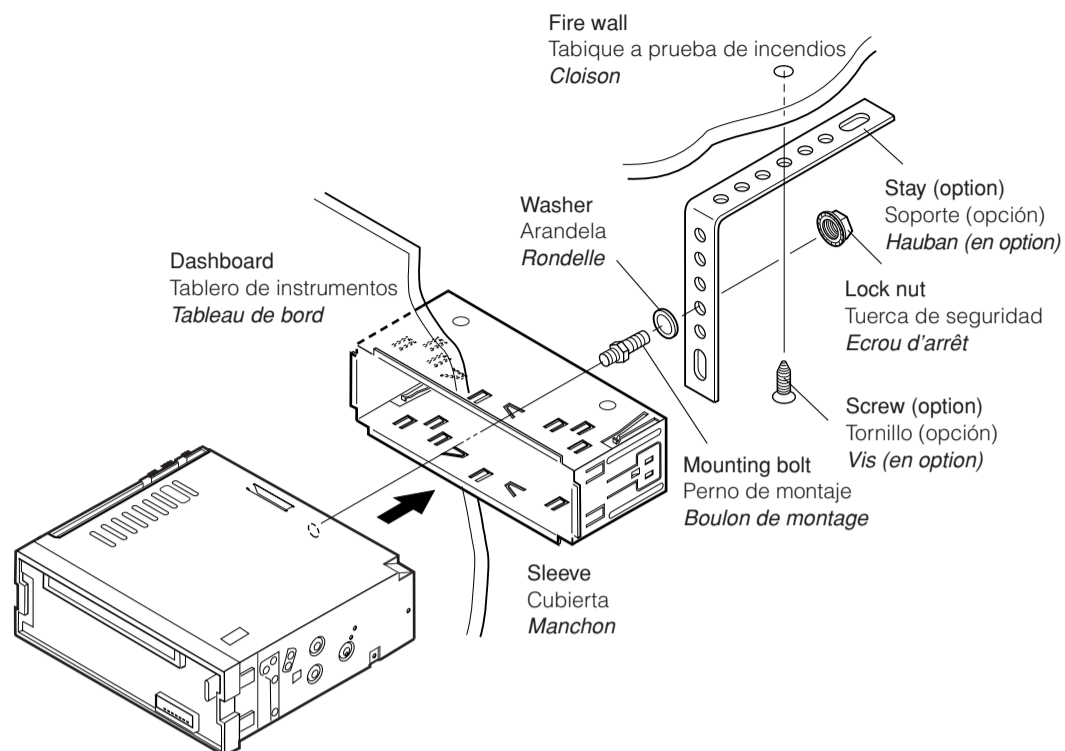

- When installing the unit without using the sleeve
- Instalación de la unidad sin utilizar la cubierta
- Lors de l'installation de l'appareil sans utiliser de manchon

In a Toyota for example, first remove the car radio and install the unit in its place.
En un Toyota por ejemplo, primero extraiga la radio del automóvil y luego instale la unidad en su lugar.

Par exemple dans une Toyota, retirer d'abord l'autoradio et installer l'appareil à la place.

Flat type screws (M5 x 6 mm)*
Tornillos tipo plano (M5 x 6 mm)*
Vis à tête plate (M5 x 6 mm)*

* Not included with this unit.
* No suministrado con esta unidad.
* Non fourni avec cet appareil.

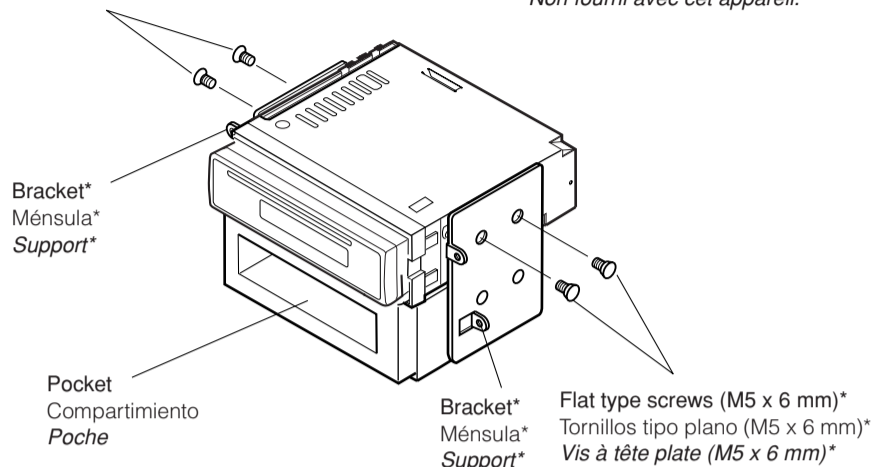

Note: When installing the unit on the mounting bracket, make sure to use the 6 mm-long screws. If longer screws are used, they could damage the unit.

Nota: Cuando instala la unidad en la ménsula de montaje, asegúrese de utilizar los tornillos de 6 mm de longitud. Si se utilizan tornillos más largos, éstos pueden dañar la unidad.

Remarque: Lors de l'installation de l'appareil sur le support de montage, s'assurer d'utiliser des vis d'une longueur de 6 mm. Si des vis plus longues sont utilisées, elles peuvent endommager l'appareil.

Removing the unit

- Before removing the unit, release the rear section.

- 1 Remove the control panel.
- 2 Remove the trim plate.
- 3 Insert the 2 handles into the slots, as shown. Then, while gently pulling the handles away from each other, slide out the unit. (Be sure to keep the handles after installing it.)

Extracción de la unidad

- Antes de extraer la unidad, libere la sección trasera.

- 1 Extraiga el panel de control.
- 2 Retire la placa de guarnición.
- 3 Inserte las 2 manijas entre las ranuras, como se muestra. Luego, separe gentilmente las manijas y extraiga la unidad. (Asegúrese de conservar las manijas después de instalarlo.)

Retrait de l'appareil

- Avant de retirer l'appareil, libérer la section arrière.

- 1 Retirer le panneau de commande.
- 2 Retirer la plaque d'assemblage.
- 3 Introduire les deux poignées dans les fentes, comme montré. Puis, tout en tirant doucement les poignées écartées, faire glisser l'appareil pour le sortir. (S'assurer de conserver les poignées après l'installation de l'appareil.)

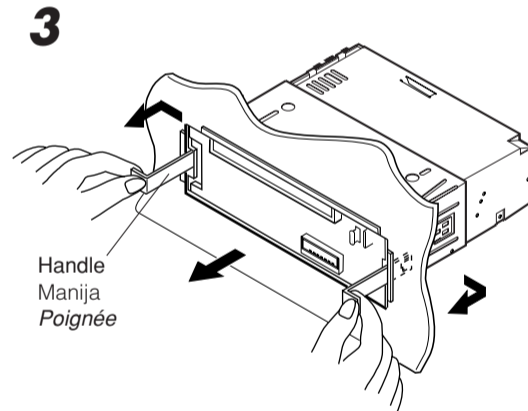
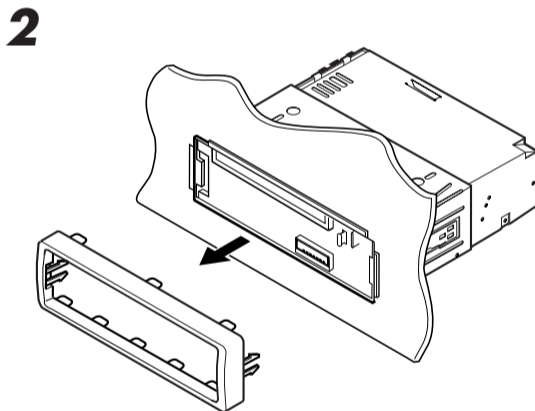
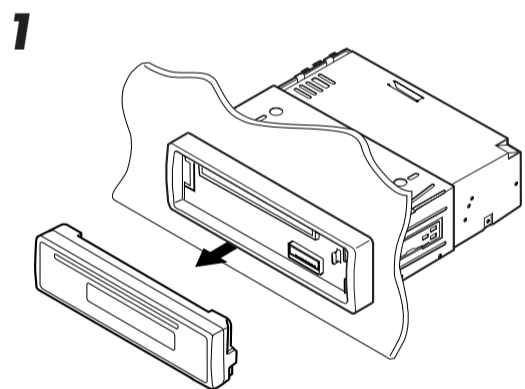

Parts list for installation and connection

The following parts are provided with this unit.
After checking them, please set them correctly.

Lista de piezas para instalación y conexión

Con esta unidad se suministran las siguientes piezas.
Después de inspeccionarlas, colóquelas correctamente.

Liste des pièces pour l'installation et raccordement

Les pièces suivantes sont fournies avec cet appareil.
Après vérification, veuillez les placer correctement.

Hard case/Control panel
Estuche duro/Panel de control
Etui de transport /Panneau de commande

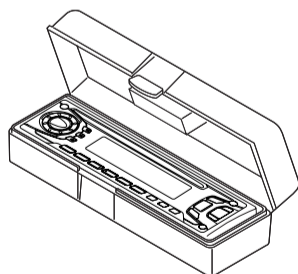

Sleeve
Cubierta
Manchon

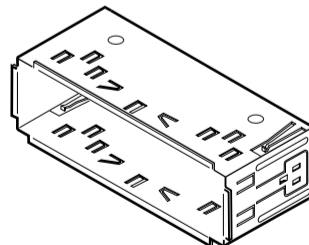

Trim plate
Placa de guarnición
Plaque d'assemblage

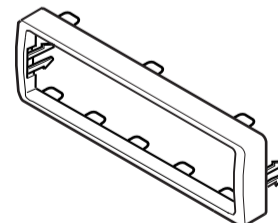

Power cord
Cordón de alimentación
Cordon d'alimentation

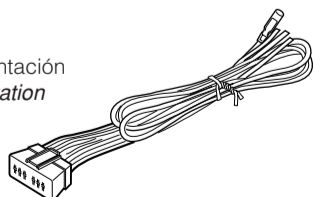

Washer (ø5)
Arandela (ø5)
Rondelle (ø5)



Lock nut (M5)
Tuerca de seguridad (M5)
Ecrou d'arrêt (M5)



Remote controller
Mando a distancia
Télécommande

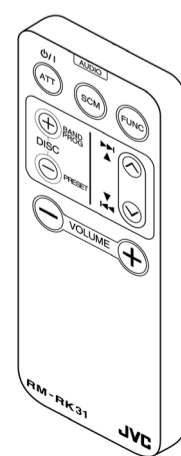

Handles
Manijas
Poignées

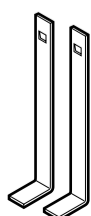

Mounting bolt (M5 x 20 mm)
Perno de montaje (M5 x 20 mm)
Boulon de montage (M5 x 20 mm)



Rubber cushion
Cojin de goma
Amortisseur en caoutchouc



Battery
Pila
Pile



CR2025

ELECTRICAL CONNECTIONS

CONEXIONES ELECTRICAS

RACCORDEMENTS ELECTRIQUES

To prevent short circuits, we recommend that you disconnect the battery's negative terminal and make all electrical connections before installing the unit. If you are not sure how to install this unit correctly, have it installed by a qualified technician.

Para evitar cortocircuitos, recomendamos que desconecte el terminal negativo de la batería y que efectúe todas las conexiones eléctricas antes de instalar la unidad. Si usted no está seguro de cómo instalar correctamente la unidad, hágala instalar por un técnico cualificado.

Pour éviter tout court-circuit, nous vous recommandons de débrancher la borne négative de la batterie et d'effectuer tous les raccordements électriques avant d'installer l'appareil. Si l'on n'est pas sûr de pouvoir installer correctement cet appareil, le faire installer par un technicien qualifié.

Note:
This unit is designed to operate only on **12 volts DC, NEGATIVE ground electrical systems**. If your vehicle does not have this system, a voltage inverter is required, which can be purchased at JVC car audio dealers.

Nota:
Esta unidad está diseñada para funcionar con **12 voltios de CC, con sistemas eléctricos de masa NEGATIVA** solamente. Si su vehículo no posee este sistema, será necesario un inversor de tensión, que puede ser adquirido en los concesionarios de JVC de equipos de audio para automóviles.

Remarque:
Cet appareil est conçu pour fonctionner sur des sources de courant continu de **12 volts à masse NEGATIVE** seulement. Si votre véhicule n'offre pas ce type d'alimentation, il vous faut un convertisseur de tension, que vous pouvez acheter chez un revendeur d'autoradios JVC.

- Replace the fuse with one of the specified rating. If the fuse blows frequently, consult your JVC car audio dealer.
- If noise is a problem...
This unit incorporates a noise filter in the power circuit. However, with some vehicles, clicking or other unwanted noise may occur. If this happens, connect the unit's **rear ground terminal** (See connection diagram below.) to the car's chassis using shorter and thicker cords, such as copper braiding or gauge wire. If noise still persists, consult your JVC car audio dealer.
- Maximum input of the speakers should be more than 45 watts at the rear and 45 watts at the front, with an impedance of **4 to 8 ohms**.
- **Be sure to ground this unit to the car's chassis.**
- The heat sink becomes very hot after use. Be careful not to touch it when removing this unit.

- Reemplace el fusible por uno con la corriente especificada. Si el fusible se quemase frecuentemente consulte con su concesionario de JVC de equipos de audio para automóviles.
- Si el ruido fuese un problema...
Esta unidad tiene un filtro de ruido en el circuito de alimentación. Sin embargo, en algunos vehículos, pueden producirse chasquidos u otros ruidos indeseados. En tal caso conecte el **terminal de tierra posterior** (Ver diagrama de conexión abajo.) del receptor al chasis del automóvil, utilizando cordones más gruesos y cortos tales como alambre de cobre trenzado o de grueso calibre. Si el ruido persiste, consulte a su concesionario de JVC de equipos de audio para automóvil.
- La entrada máxima de los altavoces traseros debe ser mayor de 45 vatios y la de los delanteros de 45 vatios, con una impedancia de **4 a 8 ohmios**.
- **Asegúrese de conectar esta unidad a tierra en el chasis del automóvil.**
- El sumidero térmico estará muy caliente después del uso. Asegúrese de no tocarlo al desmontar esta unidad.

- Remplacer le fusible par un de la valeur précisée. Si le fusible saute souvent, consulter votre revendeur d'autoradios JVC.
- Si le bruit est un problème...
Cet appareil incorpore un filtre de bruit dans le circuit d'alimentation. Cependant, avec certains véhicules, quelques claquements ou autres bruits non désirés risquent de se produire. Si cela arrive, raccorder la **borne de masse arrière** de l'appareil au châssis de la voiture (voir le schéma de raccordement ci-dessous) en utilisant des cordons les plus gros et les plus courts possibles telle qu'une barre de cuivre ou une tresse. Si le bruit persiste, consulter votre revendeur d'autoradios JVC.
- La puissance admissible des haut-parleurs doit être supérieure à 45 watts à l'arrière et à 45 watts l'avant, avec une impédance de **4 à 8 ohms**.
- **S'assurer de raccorder la mise à la masse de cet appareil au châssis de la voiture.**
- Le radiateur devient très chaud après usage. Faire attention de ne pas le toucher en retirant cet appareil.

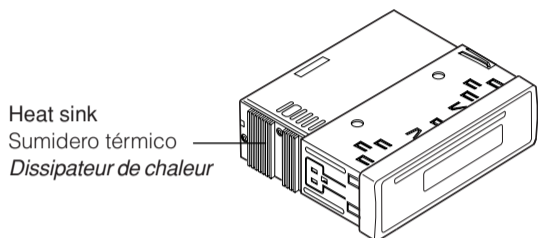

A Typical Connections / Conexiones típicas / Raccordements typiques

Before connecting: Check the wiring in the vehicle carefully not to fail in connecting this unit. Incorrect connection may cause a serious damage to this unit.

Antes de la conexión: Verifique atentamente el conexionado del vehículo para no cometer errores al conectar esta unidad. Una conexión incorrecta podría producir daños graves en la unidad.

Avant de commencer la connexion: vérifiez attentivement le câblage du véhicule pour ne pas connecter incorrectement cet appareil. Une connexion incorrecte peut endommager sérieusement l'appareil.

- 1 Connect the colored leads of the power cord to the car battery, speakers and automatic antenna (if any) in the following sequence.
 - ① Black: ground
 - ② Yellow: to car battery (constant 12V)
 - ③ Red: to an accessory terminal
 - ④ Blue with white stripe: to automatic antenna (200mA max.)
 - ⑤ Others: to speakers
- 2 Connect the antenna cord.
- 3 Finally connect the wiring harness to the unit.

- 1 Conecte los conductores de color del cable de alimentación a la batería del automóvil, altavoces y antena automática (si la hubiere) en la secuencia siguiente.
 - ① Negro: a tierra.
 - ② Amarillo: a la batería del automóvil (12V constantes)
 - ③ Rojo: a un terminal de accesorio
 - ④ Azul con rayas blancas: a la antena automática (200mA máx.)
 - ⑤ Otros: a los altavoces
- 2 Conecte el cable de antena.
- 3 Por último, conecte a la unidad el cableado preformado.

- 1 Connectez les fils de couleur du cordon d'alimentation à la batterie de la voiture, aux enceintes et à l'antenne automatique (s'il y en a une) dans l'ordre suivant.
 - ① Noir: a la masse
 - ② Jaune: a la batterie de la voiture (12V constant)
 - ③ Rouge: à la prise accessoire
 - ④ Bleu à bandes blanches: à l'antenne automatique (200mA max.)
 - ⑤ Autres: aux enceintes
- 2 Connectez le cordon d'antenne.
- 3 Finalement, connectez le faisceau de fils à l'appareil.

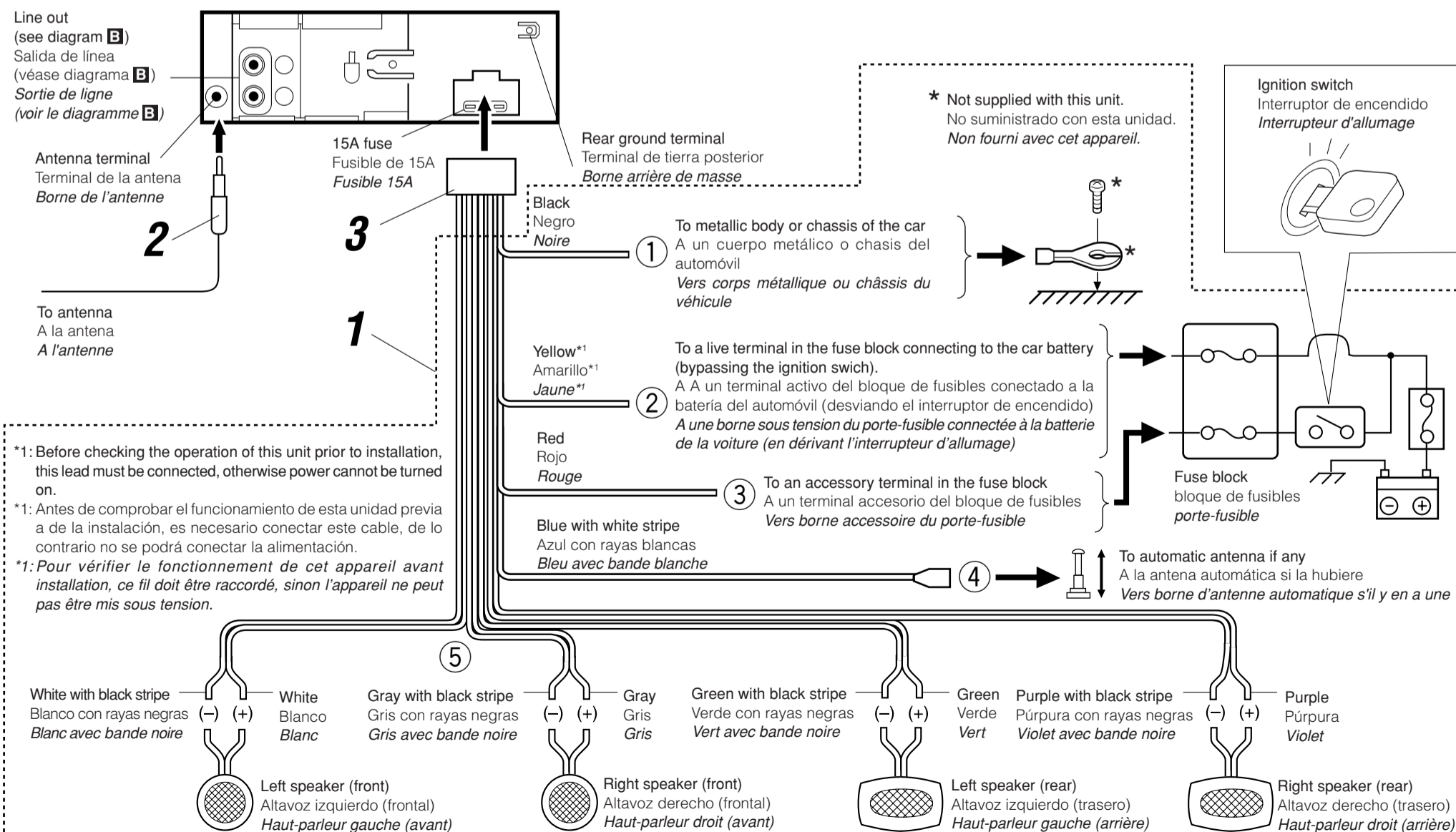

PRECAUTIONS on power supply and speaker connections:

- **DO NOT** connect the speaker leads of the power cord to the car battery; otherwise, the unit will be seriously damaged.
- Connect the black lead (ground), yellow lead (to car battery, constant 12V), and red lead (to an accessory terminal) correctly.
- **BEFORE** connecting the speaker leads of the power cord to the speakers, check the speaker wiring in your car.
 - If the speaker wiring in your car is as illustrated in Fig. 1 and Fig. 2 below, **DO NOT** connect the unit using that original speaker wiring. If you do, the unit will be seriously damaged. Redo the speaker wiring so that you can connect the unit to the speakers as illustrated in Fig. 3.
 - If the speaker wiring in your car is as illustrated in Fig. 3, you can connect the unit using the original speaker wiring in your car.
 - If you are not sure of the speaker wiring of your car, consult your car dealer.

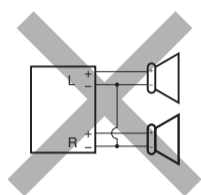

Fig. 1

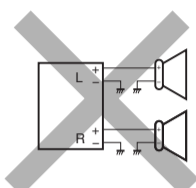

Fig. 2

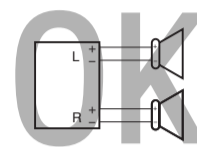

Fig. 3

PRECAUCIONES sobre las conexiones de la fuente de alimentación y de los altavoces:

- **NO** conecte los conductores de altavoz del cable de alimentación a la batería de automóvil, pues podrían producirse graves daños en la unidad.
- Conecte correctamente el conductor negro (a tierra), el conductor amarillo (a la batería del automóvil, 12V constantes), y el conductor rojo (a un terminal de accesorio).
- **ANTES** de conectar a los altavoces los conductores de altavoz del cable de alimentación, verifique el conexionado de altavoz de su automóvil.
 - Si el conexionado de altavoz de su automóvil es como se indica en las Figs. 1 y 2 de abajo, **NO** conecte la unidad utilizando ese conexionado de altavoz original. Si lo hace, se producirán daños graves en la unidad. Vuelva a efectuar el conexionado de altavoz de manera que pueda conectar la unidad a los altavoces de la manera indicada en la Fig.3.
 - Si el conexionado de altavoz de su automóvil es como se indica en la Fig.3, podrá conectar la unidad utilizando el conexionado de altavoz original de su automóvil.
 - Si tiene dudas sobre el conexionado de altavoz de su automóvil, consulte con su concesionario.

PRECAUTIONS sur l'alimentation et la connexion des enceintes:

- **NE CONNECTEZ PAS** les fils d'enceintes du cordon d'alimentation à la batterie; sinon, l'appareil serait sérieusement endommagé.
- Connectez correctement le fil noir (a la masse), le fil jaune (a la batterie de la voiture, 12V constant) et le fil rouge (à la prise accessoire).
- **AVANT** de connecter les fils d'enceintes du cordon d'alimentation aux enceintes, vérifiez le câblage des enceintes de votre voiture.
 - Si le câblage des enceintes de votre voiture est réalisé comme montré sur la Fig. 1 ou Fig. 2 ci-dessous, **NE CONNECTEZ PAS** l'appareil en utilisant ce câblage original d'enceintes. Si vous le faites, l'appareil sera sérieusement endommagé. Recommencez le câblage des enceintes de façon que vous puissiez connecter l'appareil aux enceintes comme montré sur la Fig. 3.
 - Si le câblage des enceintes de votre voiture est comme montré sur la Fig. 3, vous pouvez connecter l'appareil en utilisant ce câblage original d'enceintes pour votre voiture.
 - Si vous n'êtes pas sûrs du câblage d'enceintes de votre voiture, consulter le concessionnaire de votre voiture.

Connecting the leads / Conexión de los conductores / Raccordement des fils

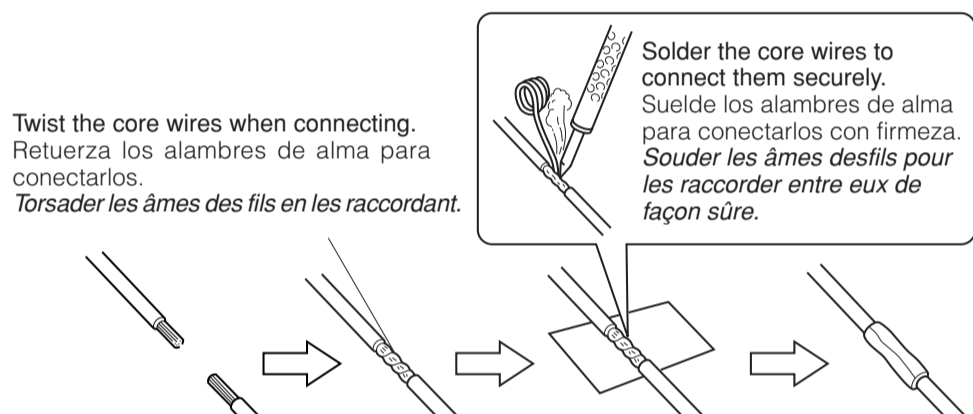

CAUTION / PRECAUCION / PRECAUTION:

- To prevent short-circuit, cover the terminals of the **UNUSED** leads with insulating tape.
- Para evitar cortocircuitos, cubra los cables **NO UTILIZADOS** con cinta aislante.
- Pour éviter les court-circuits, couvrir les bornes des fils qui ne sont **PAS** utilisés avec de la bande isolante

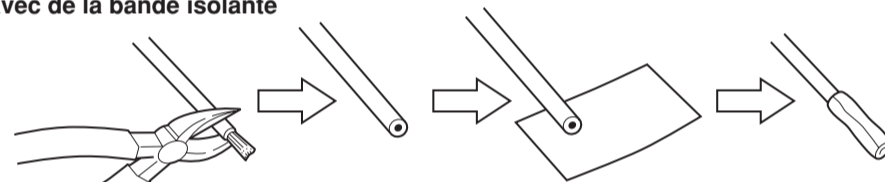

B Connections Adding Other Equipment / Conexiones para añadir otros equipos / Raccordement pour ajouter d'autres appareils

- You can connect an amplifier and other equipment to upgrade your car stereo system.
- Connect the remote lead (blue with white stripe) to the remote lead of the other equipment so that it can be controlled through this unit.
 - For amplifier only:
 - Connect this unit's line-out terminals to the amplifier's line-in terminals.
 - **Disconnect the speakers from this unit, connect them to the amplifier. Leave the speaker leads of this unit unused. (Cover the terminals of the these unused leads with insulating tape, as illustrated above.)**

- Usted podrá conectar un amplificador y otros equipos para mejorar el sistema estéreo de su automóvil.
- Conecte el cable remoto (azul con rayas blancas) al cable remoto del otro equipo para que pueda ser controlado a través de esta unidad.
 - Sólo para el amplificador:
 - Conecte los terminales de salida de línea de esta unidad con los terminales de entrada de línea del amplificador.
 - **Desconecte los altavoces de esta unidad y conéctelos al amplificador. Los cables de los altavoces de esta unidad quedan sin usar. (Cubra los terminales de estos cables sin usar con cinta aislante, tal comose indica en la figura de arriba).**

- Vous pouvez connecter un amplificateur ou autre appareil pour améliorer votre système autoradio.
- Connecter le fil d'alimentation à distance (bleu avec des bandes blanches) au fil d'alimentation à distance de l'autre appareil de façon qu'il puisse être contrôlé par cet appareil.
 - Pour l'amplificateur seulement:
 - Raccorder les bornes de sortie ligne de cet appareil aux bornes d'entrée ligne de l'amplificateur.
 - **Déconnectez les enceintes de cet appareil et connectez-les à l'amplificateur. Laissez les fils d'enceintes de cet appareil inutilisés. (Recouvrir les extrémités de ces fils inutilisés avec de la bande isolante comme montré ci-dessus.)**

Amplifier / Amplificador / Amplificateur

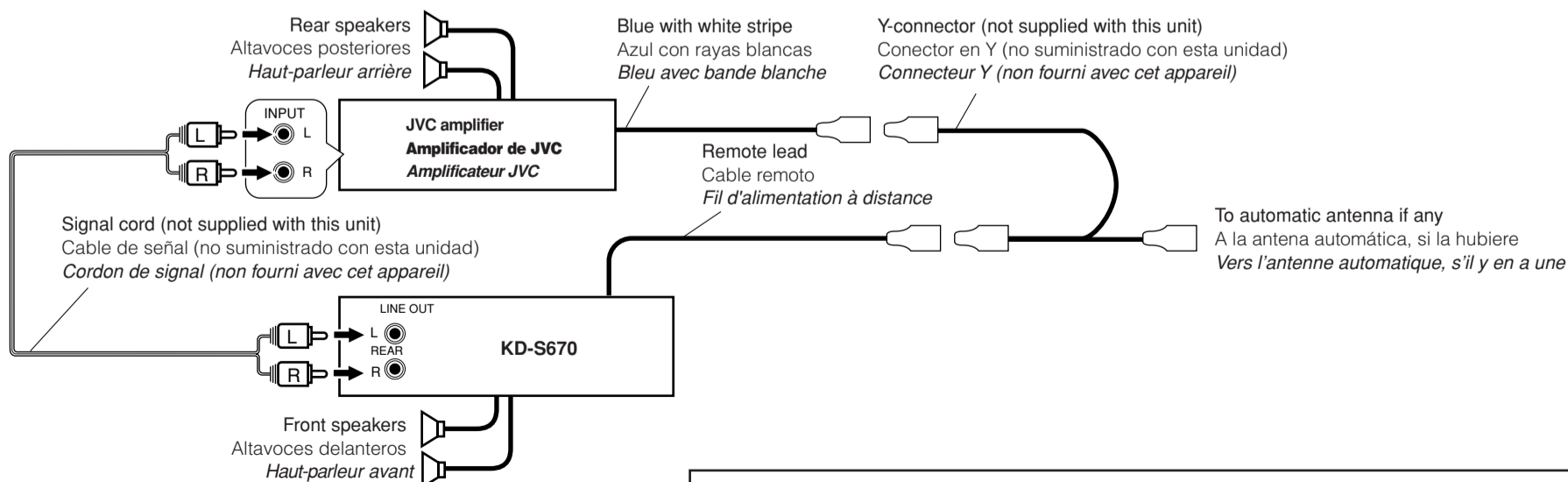

- CAUTION / PRECAUCION / PRECAUTION:**
- To prevent internal heat buildup inside this unit, place this unit **UNDER** the other equipment.
 - Para evitar el aumento del calor interior de esta unidad, póngala **DEBAJO** del otro equipo.
 - Pour éviter un échauffement interne de cet appareil, placez-le **SOUS** l'autre appareil.

Free Manuals Download Website

<http://myh66.com>

<http://usermanuals.us>

<http://www.somanuals.com>

<http://www.4manuals.cc>

<http://www.manual-lib.com>

<http://www.404manual.com>

<http://www.luxmanual.com>

<http://aubethermostatmanual.com>

Golf course search by state

<http://golfingnear.com>

Email search by domain

<http://emailbydomain.com>

Auto manuals search

<http://auto.somanuals.com>

TV manuals search

<http://tv.somanuals.com>