

JVC

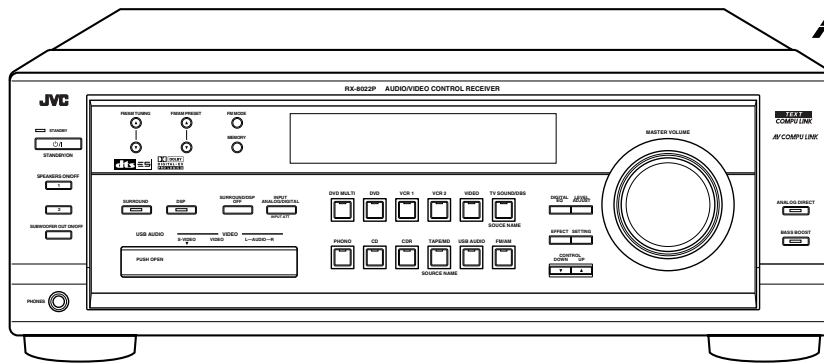

AUDIO/VIDEO CONTROL RECEIVER

RX-8022PSL

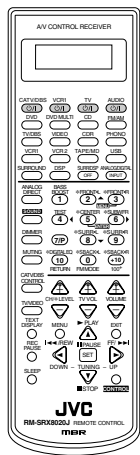

AV COMPU LINK

**TEXT
COMPU LINK**

dts ES

**DOLBY
DIGITAL EX
PRO LOGIC II**

INSTRUCTIONS

For Customer Use:

Enter below the Model No. and Serial No. which are located either on the rear, bottom or side of the cabinet. Retain this information for future reference.

Model No. _____

Serial No. _____

LVT0870-006A

[A]

Warnings, Cautions and Others

Caution — ⏻/I switch!

Disconnect the mains plug to shut the power off completely. The ⏻/I switch in any position does not disconnect the mains line. The power can be remote controlled.

CAUTION

To reduce the risk of electrical shocks, fire, etc.:

1. Do not remove screws, covers or cabinet.
2. Do not expose this appliance to rain or moisture.

CAUTION

- Do not block the ventilation openings or holes. (If the ventilation openings or holes are blocked by a newspaper or cloth, etc., the heat may not be able to get out.)
- Do not place any naked flame sources, such as lighted candles, on the apparatus.
- When discarding batteries, environmental problems must be considered and local rules or laws governing the disposal of these batteries must be followed strictly.
- Do not expose this apparatus to rain, moisture, dripping or splashing and that no objects filled with liquids such as vases, shall be placed on the apparatus.

Caution: Proper Ventilation

To avoid risk of electric shock and fire and to protect from damage.

Locate the apparatus as follows:

Front: No obstructions open spacing.

Sides: No obstructions in 10 cm from the sides.

Top: No obstructions in 10 cm from the top.

Back: No obstructions in 15 cm from the back

Bottom: No obstructions, place on the level surface.

In addition, maintain the best possible air circulation as illustrated.

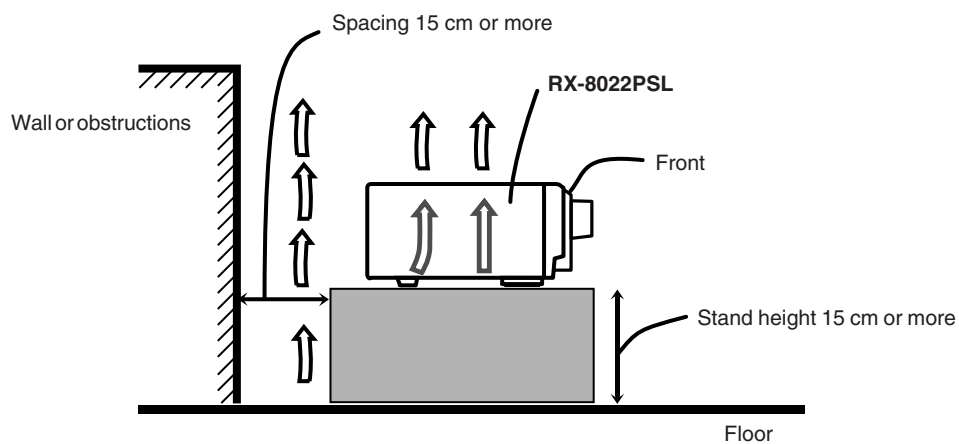

Table of Contents

Introduction	2	Setting Sound	30
Features	2	Attenuating the Input Signal	30
Precautions	2	Turning Analog Direct On and Off	30
Parts Identification	3	Reinforcing the Bass	31
Getting Started	5	Activating the Subwoofer Sound	31
Before Installation	5	Using Surround Modes and DSP Modes	32
Checking the Supplied Accessories	5	■ Surround Modes	32
Setting the Voltage Selector	5	Reproducing Theater Ambience	32
Connecting the FM and AM Antennas	5	Introducing the Surround Modes	32
Connecting the Speakers	6	■ DSP Modes	34
Connecting Audio/Video Components	8	Available Surround and DSP Modes According to	
■ Analog Connections	8	the Speaker Layouts	35
■ Digital Connections	13	Activating the Surround Modes	36
■ USB Connection	14	Activating the DSP Modes	36
Connecting the Power Cord	15	Using the DVD MULTI Playback Mode	37
Putting Batteries in the Remote Control	15	Activating the DVD MULTI Playback Mode	37
Basic Operations	16	Adjusting Sound	38
Turning On the Power	16	Basic Procedure	38
Selecting the Source to Play	16	Adjusting the Equalization Patterns—DIGITAL EQ	39
Adjusting the Volume	18	Adjusting the Speaker Output Levels—LEVEL ADJUST	40
Selecting the Front Speakers	18	Adjusting the Sound Parameters for the Surround and	
Listening Only with Headphones	18	DSP Modes—EFFECT ADJUST	42
Selecting the Analog or Digital Input Mode	19	COMPU LINK Remote Control System	43
Muting the Sound	20	TEXT COMPU LINK Remote Control System ...	44
Changing the Display Brightness	20	■ Showing the Disc Information on the TV Screen	45
Using the Sleep Timer	20	■ Searching for a Disc (Only for the CD player)	46
Basic Settings	21	■ Entering the Disc Information	47
Basic Procedure	21	AV COMPU LINK Remote Control System ...	49
1 Setting the Speakers	22	Operating JVC's Audio/Video Components ...	51
2 Selecting Channel Numbers to Reproduce		Operating Audio Components	51
Multi-channel Digital Software	23	Operating Video Components	53
3 Setting the Speaker Distance	23	Operating Other Manufacturers' Video	
4 Setting the Bass Sounds	24	Equipment	54
5 Setting the Dynamic Range	24	Troubleshooting	57
6 Setting the Digital Input (DIGITAL IN) Terminals	25	Specifications	59
7 Setting the Component Video Input	25		
8 Memorizing the Volume Level for Each Source	26		
9 Showing the Text Information on the Display	26		
Receiving Radio Broadcasts	27		
Tuning into Stations Manually	27		
Using Preset Tuning	27		
Selecting the FM Reception Mode	28		
Operating the Tuner Using the On-Screen Display	29		

Introduction

We would like to thank you for purchasing one of our JVC products. Before operating this unit, read this manual carefully and thoroughly to obtain the best possible performance from your unit, and retain this manual for future reference.

Features

Dolby Digital EX*

Dolby Digital EX is newly introduced surround encoding format as an extension of multi-channel Dolby Digital, designed to add an extra surround channel to Dolby Digital 5.1-channel. By using a matrix encoding/decoding method, additional “surround back” channel signal is encoded (and decoded) in both the left and right surround channel signals.

DTS-ES Extended Surround (DTS-ES)**

DTS-ES is another new format developed by Digital Theater Systems, Inc., adding a surround back channel on the basis of DTS Digital Surround.

Dolby Pro Logic II*

Dolby Pro Logic II converts all 2-channel stereo software, especially Dolby Surround encoded software, into 5-channel (plus subwoofer) signals. It reproduces realistic Surround sounds approaching to Dolby Digital 5.1-channel. Dolby Pro Logic II has two modes to reproduce—Movie mode and Music mode.

Neo:6**

Neo:6 can reproduce realistic Surround fields by converting 2-channel stereo software into 6-channel (plus subwoofer) signals. Neo:6 has two modes to reproduce—Neo:6 Cinema and Neo:6 Music.

DAP (Digital Acoustic Processor)

Sound field simulation technology allows precise ambience recreation of existing theaters and halls. Thanks to the high-performance DSP (Digital Signal Processor) and high-capacity memory, you can enjoy 5.1-channel surround by playing 2-channel or multi-channel software.

Multi-channel headphone virtual surround sound—3D HEADPHONE

The built-in headphone virtual surround system is compatible with Multi-channel software like Dolby Digital, DTS Digital Surround, etc. Thanks to the new signal processing algorithms used by the high-performance DSP, you can enjoy a natural surround sound through the headphones.

COMPU LINK/TEXT COMPU LINK/AV COMPU LINK remote control systems

These COMPU LINK remote control systems allow you to operate other JVC's audio/video components from this receiver.

* Manufactured under license from Dolby Laboratories. “Dolby,” “Pro Logic,” and the double-D symbol are trademarks of Dolby Laboratories.

** “DTS,” “DTS-ES Extended Surround” and “Neo:6” are trademarks of Digital Theater Systems, Inc.

Precautions

Power sources

- When unplugging the receiver from the wall outlet, always pull the plug, not the AC power cord.
- Do not handle the AC power cord with wet hands.
- If you are not going to operate the receiver for an extended period of time, unplug the AC power cord from the wall outlet.

Ventilation

High power amplifiers built in this receiver will generate heat inside the cabinet. For safety, observe the following carefully.

- Make sure there is good ventilation around the receiver. Poor ventilation could overheat and damage the receiver.
- Do not block the ventilation openings or holes. (If the ventilation openings or holes are blocked by a newspaper or cloth, etc., the heat may not be able to get out.)

Others

- Should any metallic object or liquid fall onto the unit, unplug the unit and consult your dealer before operating any further.
- Do not expose this apparatus to rain, moisture, dripping or splashing and that no objects filled with liquids, such as vases shall be placed on the apparatus.
- Do not disassemble the unit since there are no user serviceable parts inside.

If anything goes wrong, unplug the AC power cord and consult your JVC dealer.

Parts Identification

Become familiar with the buttons and controls on the receiver before use.
Refer to the pages in parentheses for details.

Front Panel

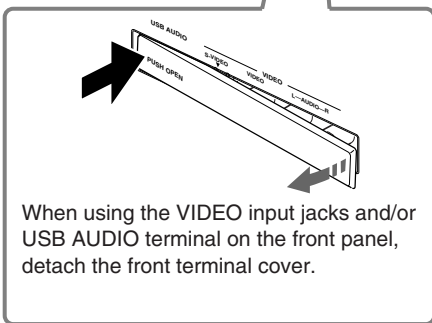
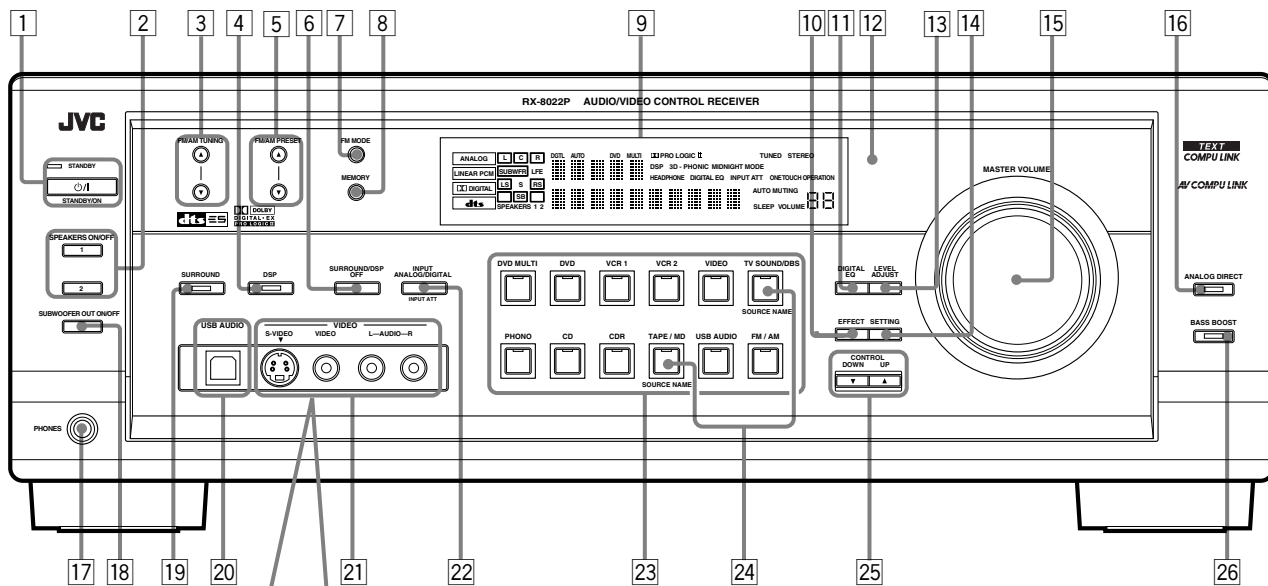

Display Window

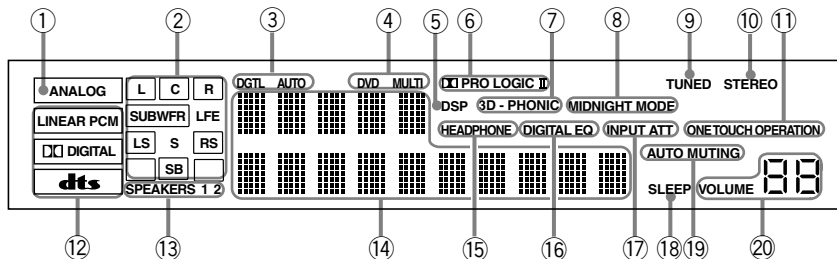

Front Panel

- 1 STANDBY/ON \odot/I button and STANDBY lamp (16)
- 2 • SPEAKERS ON/OFF 1 button (18)
• SPEAKERS ON/OFF 2 button (18)
- 3 FM/AM TUNING $\blacktriangle/\blacktriangledown$ buttons (27)
- 4 DSP button and lamp (36)
- 5 FM/AM PRESET $\blacktriangle/\blacktriangledown$ buttons (27, 28)
- 6 SURROUND/DSP OFF button (36)
- 7 FM MODE button (28)
- 8 MEMORY button (27)
- 9 Display window (16)
- 10 EFFECT button (42)
- 11 DIGITAL EQ (equalization) button (39)
- 12 Remote sensor (15)
- 13 LEVEL ADJUST button (41)
- 14 SETTING button (21)
- 15 MASTER VOLUME control (18)
- 16 ANALOG DIRECT button and lamp (30)
- 17 PHONES jack (18)
- 18 SUBWOOFER OUT ON/OFF button (31)
- 19 SURROUND button and lamp (36)
- 20 USB AUDIO terminal (14)
- 21 VIDEO input jacks (10)
- 22 • INPUT ANALOG/DIGITAL button (19)
• INPUT ATT button (30)
- 23 Source selecting buttons and lamps (16, 17, 19, 27, 28, 37)
DVD MULTI, DVD, VCR 1, VCR 2, VIDEO, TV SOUND/DBS, PHONO, CD, CDR, TAPE/MD, USB AUDIO, FM/AM

- 24 SOURCE NAME buttons (17)
- 25 CONTROL UP \blacktriangle /DOWN \blacktriangledown buttons (21, 41, 42)
- 26 BASS BOOST button and lamp (31)

Display Window

- 1 ANALOG indicator (19)
- 2 Speaker indicators and signal indicators (17)
- 3 DGTL (digital) AUTO indicator (19)
- 4 DVD MULTI indicator (37)
- 5 DSP indicator (18, 34)
- 6 • $\square\square$ PRO LOGIC indicator (33)
• $\square\square$ PRO LOGIC II indicator (32)
- 7 3D-PHONIC indicator (33, 34)
- 8 MIDNIGHT MODE indicator (24)
- 9 TUNED indicator (27)
- 10 STEREO indicator (27, 28)
- 11 ONE TOUCH OPERATION indicator (26)
- 12 Digital signal format indicators (19)
- 13 SPEAKERS 1/2 indicators (18)
- 14 Main Display
- 15 HEADPHONE indicator (18, 34)
- 16 DIGITAL EQ (equalization) indicator (39)
- 17 INPUT ATT (attenuator) indicator (30)
- 18 SLEEP indicator (20)
- 19 AUTO MUTING indicator (28)
- 20 VOLUME level indicator (16, 20)

Remote Control

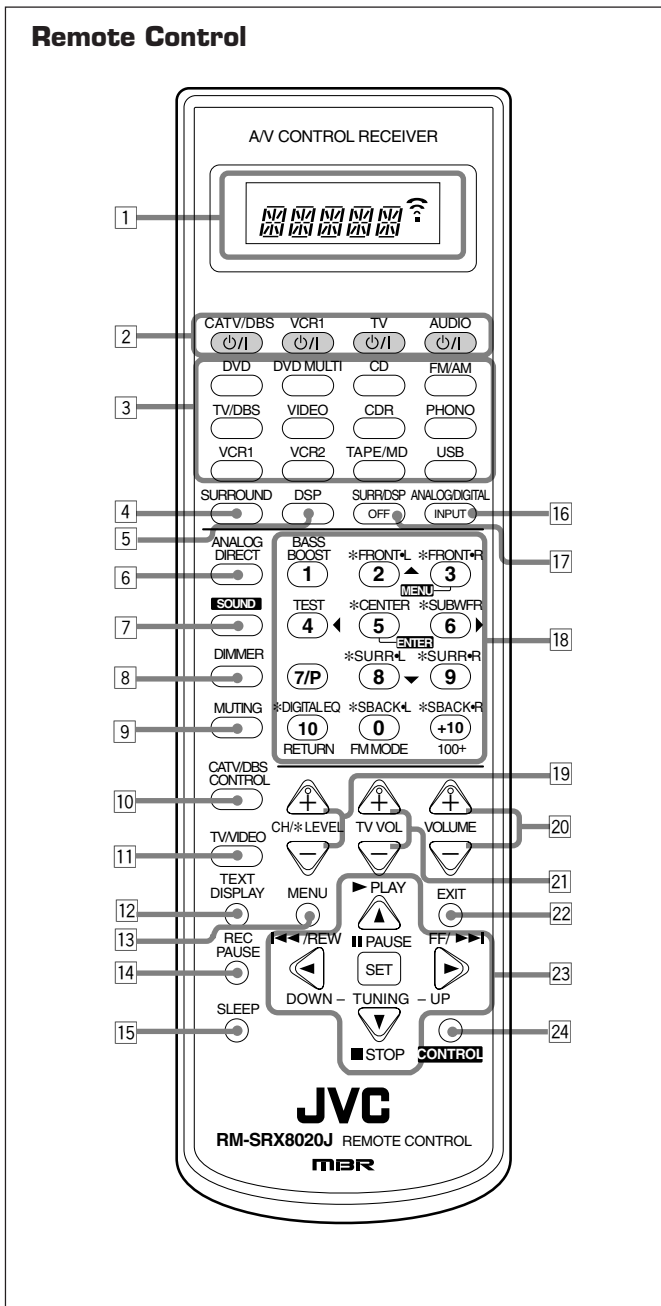

Remote Control

- 1 Remote control display window
- 2 \odot/I buttons (16, 53 – 56)
CATV/DBS \odot/I , VCR1 \odot/I , TV \odot/I , AUDIO \odot/I
- 3 Source selecting buttons (16, 17, 19, 27, 28, 37)
DVD, DVD MULTI, CD, FM/AM, TV/DBS, VIDEO, CDR, PHONO, VCR1, VCR2, TAPE/MD, USB
- 4 SURROUND button (36)
- 5 DSP button (36)
- 6 ANALOG DIRECT button (30)
- 7 SOUND button (31, 39, 41)
- 8 DIMMER button (20)
- 9 MUTING button (20)
- 10 CATV/DBS CONTROL button (55)
- 11 TV/VIDEO button (53)
- 12 TEXT DISPLAY button (45 – 48)
- 13 MENU button (21, 29 – 31, 38)
- 14 REC PAUSE button (52, 53, 55)
- 15 SLEEP button (20)
- 16 ANALOG/DIGITAL INPUT button (19)
- 17 SURR (surround)/DSP OFF button (36)
- 18
 - 10 keys for operating tuner (28)
 - 10 keys for adjusting sound (31, 39, 41, 51)
 - 10 keys for operating audio/video components (51 – 55)
- 19 CH (channel) +/- buttons (53 – 55)
 - LEVEL +/- buttons (39, 41)
 - These buttons function only after pressing 10 keys which are marked with an asterisk (*).
- 20 VOLUME +/- buttons (18)
- 21 TV VOL (volume) +/- buttons (53, 54)
- 22 EXIT button (21, 29 – 31, 38, 40, 42, 45 – 47)
- 23
 - TUNING UP /DOWN buttons (27)
 - On-screen operating buttons (21, 29 – 31, 38 – 40, 42, 45 – 48)
 - Operating buttons for audio/video components (52, 53, 55, 56)
- 24 CONTROL button (51 – 53)

Remote control display window

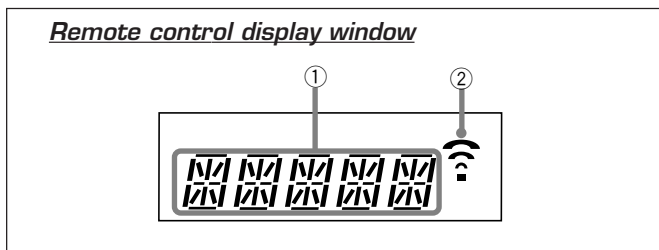

Remote control display window

- 1 Remote control operation mode display (16)
 - Remote control operation mode such as "DVD," "CD," "SOUND," etc. appears.
 - When the remote control operation mode changes, it is shown on the display.
- 2 Signal transmission indicator
 - Lights up when transmitting the remote control signals.

Getting Started

This section explains how to connect audio/video components and speakers to the receiver, and how to connect the power supply.

Before Installation

General Precautions

- Be sure your hands are dry.
- Turn the power off to all components.
- Read the manuals supplied with the components you are going to connect.

Locations

- Install the receiver in a location that is level and protected from moisture.
- The temperature around the receiver must be between -5°C and 35°C .
- Make sure there is good ventilation around the receiver. Poor ventilation could cause overheating and damage the receiver.

Handling the receiver

- Do not insert any metal object into the receiver.
- Do not disassemble the receiver or remove screws, covers, or cabinet.
- Do not expose the receiver to rain or moisture.

Checking the Supplied Accessories

Check to be sure you have all of the following items, which are supplied with the receiver.

The number in the parentheses indicates quantity of the pieces supplied.

- Remote Control (1)
- Batteries (2)
- AM Loop Antenna (1)
- FM Antenna (1)
- AC Plug Adaptor (1)

If anything is missing, contact your dealer immediately.

Setting the Voltage Selector

Before connections, always do the following first if necessary.

Select the correct voltage in VOLTAGE SELECTOR on the rear by using a screw driver. Check to be sure if the voltage mark is set to the voltage for your area where this unit plugs in.

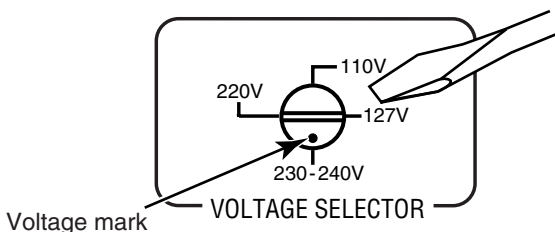

Connecting the FM and AM Antennas

FM Antenna Connections

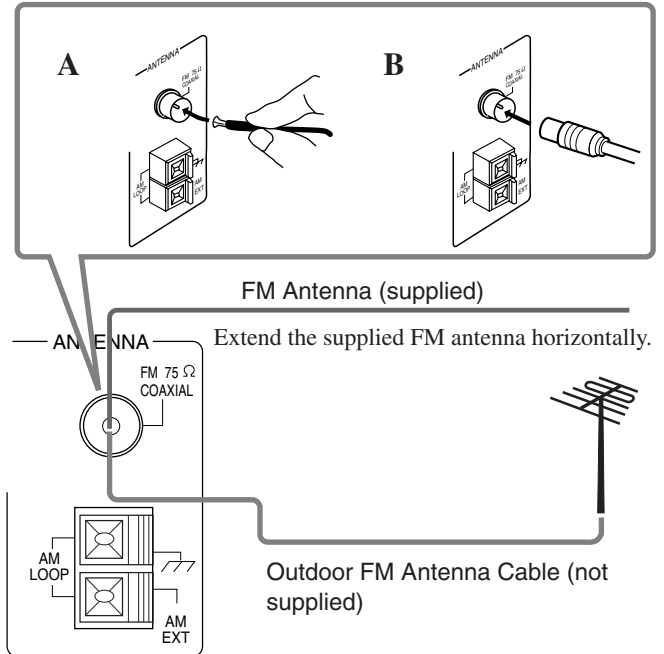

A. Using the Supplied FM Antenna

The FM antenna provided can be connected to the FM 75 Ω COAXIAL terminal as temporary measure.

B. Using the Standard Type Connector (not supplied)

A standard type connector should be connected to the FM 75 Ω COAXIAL terminal.

Note:

If reception is poor, connect the outdoor FM antenna (not supplied). Before attaching a 75 Ω coaxial cable (the kind with a round wire going to an outdoor antenna), disconnect the supplied FM antenna.

AM Antenna Connections

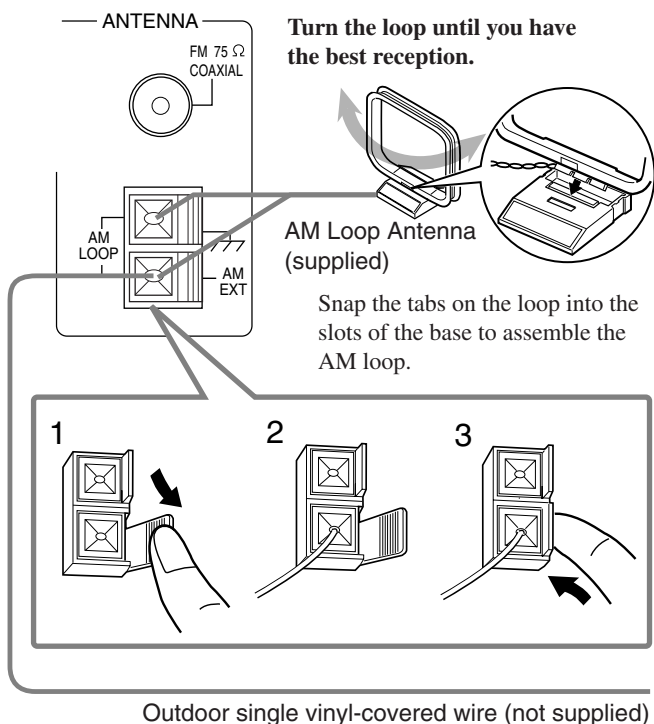

Notes:

- If the AM loop antenna wire is covered with vinyl, remove the vinyl by twisting it as shown in the diagram.
- Make sure the antenna conductors do not touch any other terminals, connecting cords and power cord. This could cause poor reception.
- If reception is poor, connect an outdoor single vinyl-covered wire (not supplied) to the AM EXT terminal. (Keep the AM loop antenna connected.)



Connecting the Speakers

You can connect the following speakers:

- Two pairs of front speakers to produce normal stereo sound.
- One pair of surround speakers to enjoy the surround effect.
- One surround back speaker or one pair of surround back speakers to enjoy 6.1-channel sound reproduction.
- One center speaker to produce more effective surround effect (to emphasize human voices).
- One subwoofer to enhance the bass.

IMPORTANT:

After connecting the speakers listed above, set the speaker setting information properly to obtain the best possible Surround and DSP effect. For details, see page 22.

CAUTION:

Use speakers with the SPEAKER IMPEDANCE indicated by the speaker terminals.

Typical speaker layout

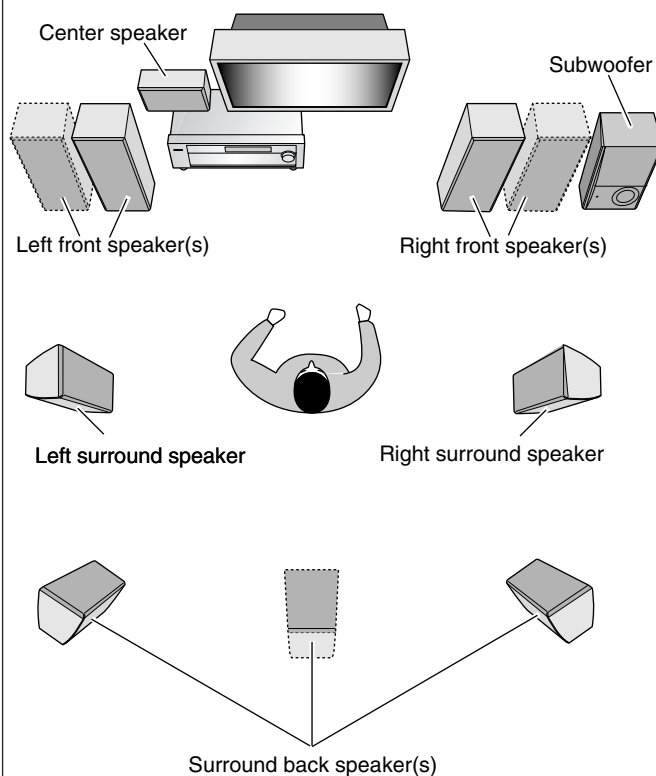

Basic connecting procedure

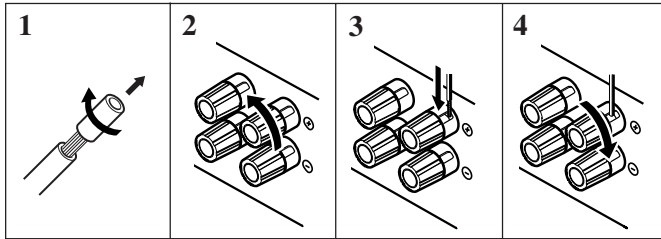

- 1 Cut, twist and remove the insulation at the end of each speaker signal cable (not supplied).
- 2 Turn the knob counterclockwise.
- 3 Insert the speaker signal cable.
- 4 Turn the knob clockwise.

For each speaker (except for a subwoofer), connect the (+) and (-) terminals on the rear panel to the (+) and (-) terminals marked on the speakers.

Connecting the front, center and surround speakers

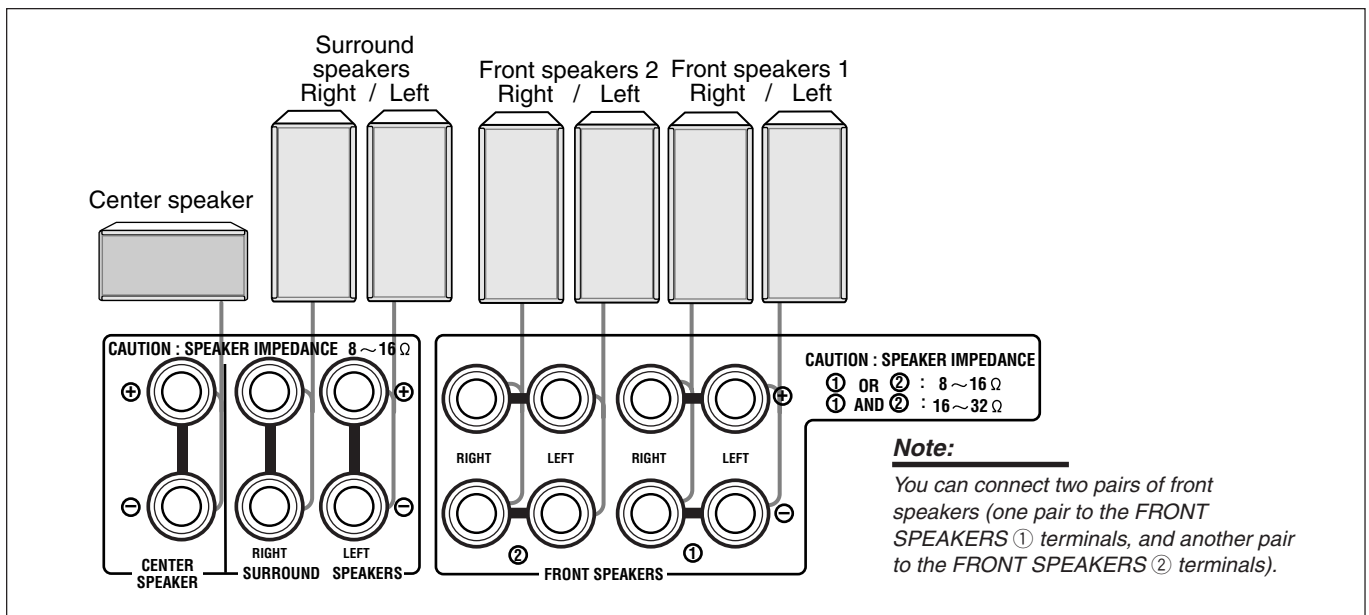

Connecting the surround back speakers

To fully enjoy Dolby Digital EX and DTS-ES Extended Surround (see pages 32 and 33), you need to connect the surround back speakers through a power amplifier connected to the PRE OUT SURR BACK jacks on the rear panel, using a cable with RCA pin plugs (not supplied). Connect the white plug to the audio left jack, and the red plug to the audio right jack.

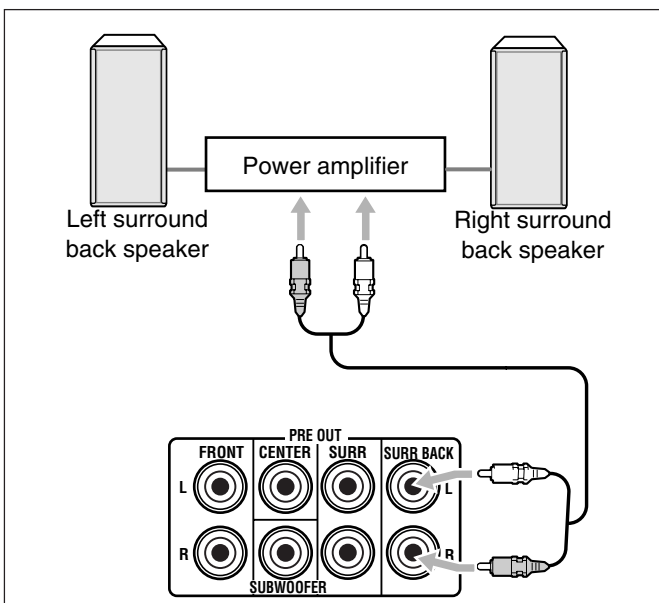

Note:

If you have selected "1SPK" for the surround back speaker quantity (see page 22), connect the surround back speaker to the PRE OUT SURR BACK L (left) jack.

Connecting the subwoofer speaker

You can enhance the bass by connecting a subwoofer. Connect the input jack of a powered subwoofer to the PRE OUT SUBWOOFER jack on the rear panel, using a cable with RCA pin plugs (not supplied).

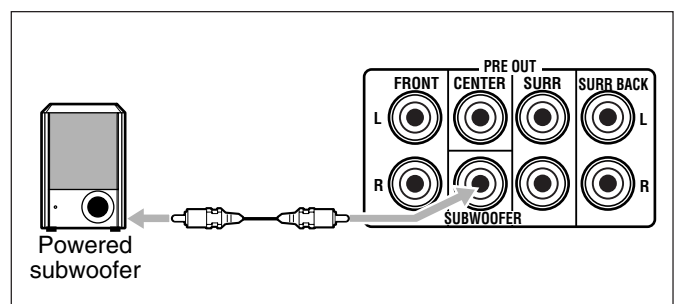

Note:

You can place a subwoofer wherever you like since bass sound is non-directional. Normally place it in front of you.

Enhancing your audio system

You can use this receiver as the pre-amplifier (control amplifier) when you connect power amplifiers to the PRE OUT jacks on the rear panel using cables with RCA pin plugs (not supplied). Connect the white plug to the audio left jack, and the red plug to the audio right jack.

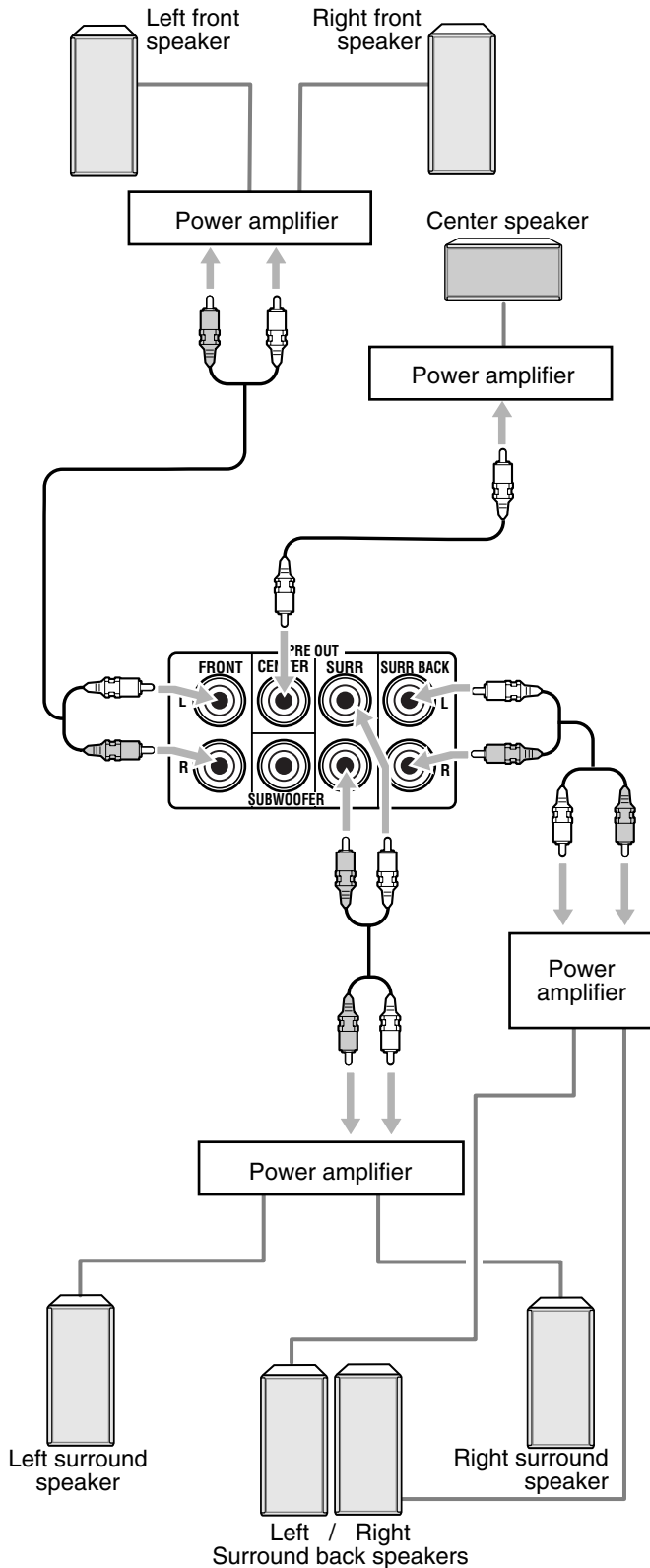

Note:

If you have selected "1SPK" for the surround back speaker quantity (see page 22), connect the surround back speaker to the PRE OUT SURR BACK L (left) jack.

Connecting Audio/Video Components

You can connect the following audio/video components to this receiver. Refer also to the manuals supplied with your components.

Audio Components	Video Components
• Turntable	• VCRs (VCR 1 and VCR 2)
• CD player*	• Video camera
• Cassette deck or MD recorder*	• TV*
• CD recorder*	• DBS tuner*
• Personal computer (PC)	• DVD player*

* You can connect these components using the methods described in "Analog Connections" (see below) and in "Digital Connections" (see page 13).

Analog Connections

Audio component connections

Use the cables with RCA pin plugs (not supplied). Connect the white plug to the audio left jack, and the red plug to the audio right jack.

CAUTION:

If you connect a sound-enhancing device such as a graphic equalizer between the source components and this receiver, the sound output through this receiver may be distorted.

Turntable

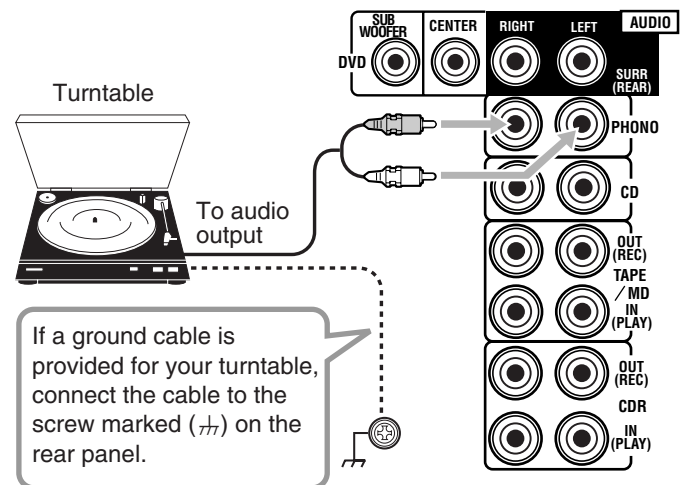

Note:

This connection is for the turntable with an MM (moving-magnet) type cartridge. Any turntables incorporating a small-output cartridge such as an MC (moving-coil) type must be connected to this receiver through a commercial head amplifier or step-up transformer. Direct connection may result in insufficient volume.

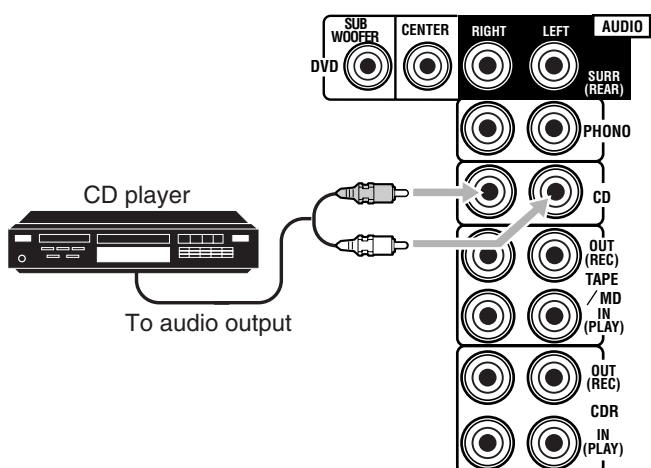
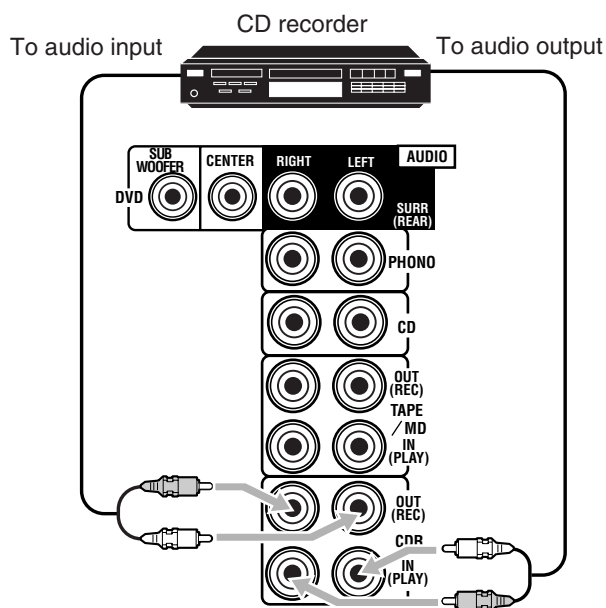
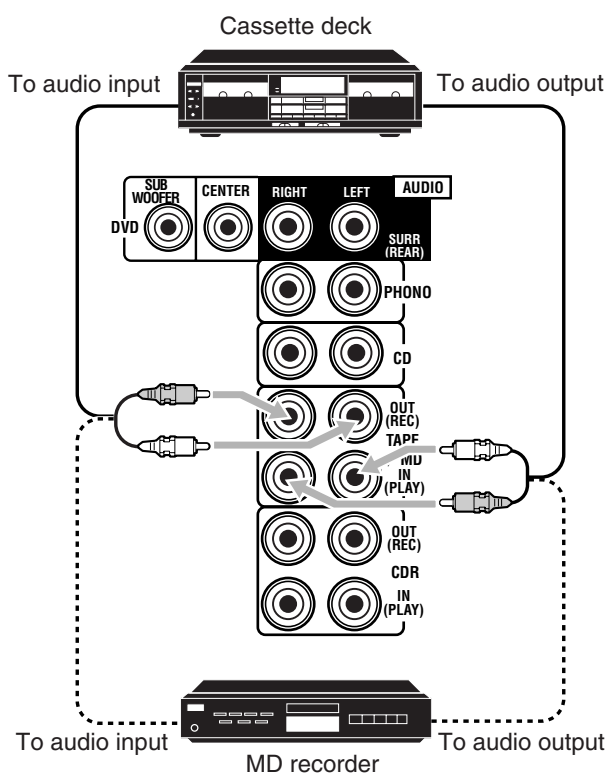
CD player**CD recorder****Cassette deck or MD recorder****If your audio components have a COMPU LINK or TEXT COMPU LINK jack**

- See also page 43 for detailed information about the connection and the COMPU LINK remote control system.
- See also page 44 for detailed information about the connection and the TEXT COMPU LINK remote control system.

Note:

You can connect either a cassette deck or an MD recorder to the TAPE/MD jacks. When connecting an MD recorder to the TAPE/MD jacks, change the source name to "MD," which will be shown on the display when it is selected as the source. See page 17 for details.

Video component connections

Use the cables with RCA pin plugs (not supplied). Connect the white plug to the audio left jack, the red plug to the audio right jack, and the yellow plug to the video jack.

- If your video components have S-video (Y/C-separation) and/or component video (Y, Pb/Cb, Pr/Cr) terminals, connect them using an S-video cable (not supplied) and/or component video cable (not supplied). By using these jacks, you can get a better picture quality in the order—Component video > S-video > Composite video.

IMPORTANT:

This receiver is equipped with the following video jacks—composite video, S-video and component video jacks. You can use any of the three to connect a video component.

However, **the video signals from one type of these input jacks are output only through the video output jacks of the same type.**

Therefore, if a recording video component and a playing video component are connected to the receiver through the video jacks of the different type, you cannot record the picture. In addition, if the TV and a playing video component are connected to the receiver through the video jacks of the different type, you cannot view the playback picture on the TV.

VCR(s)

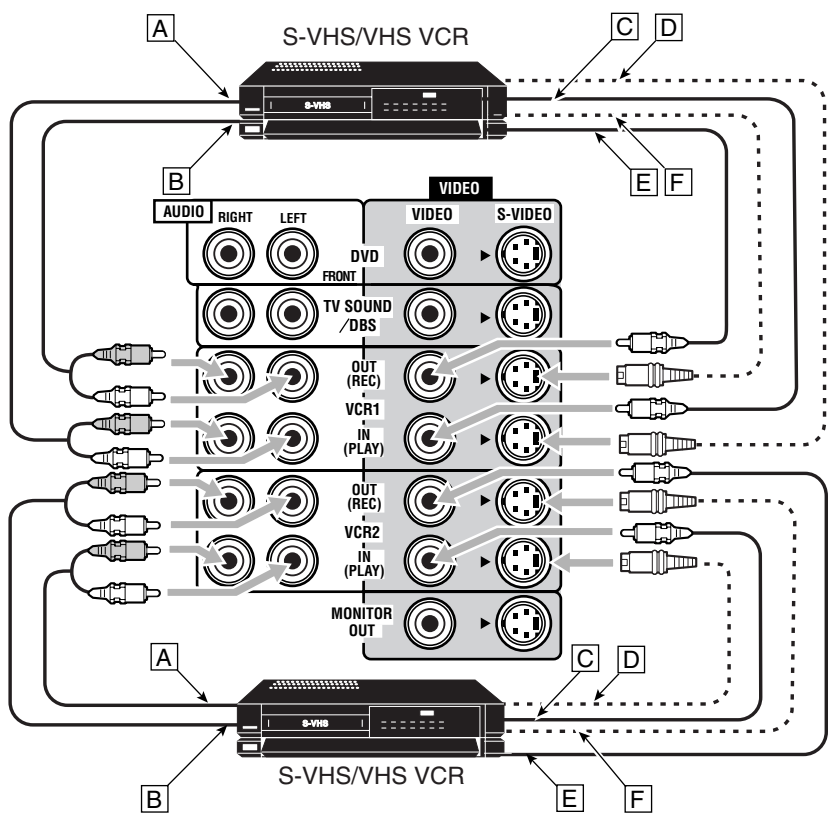

- A To left/right audio output
- B To left/right audio input
- C To composite video output
- D To S-video output
- E To composite video input
- F To S-video input

Video camera

The VIDEO input jacks on the front panel are convenient when connecting and disconnecting the equipment frequently.

- When you do not use the terminals on the front panel, attach the supplied front terminal cover to protect them from dust.

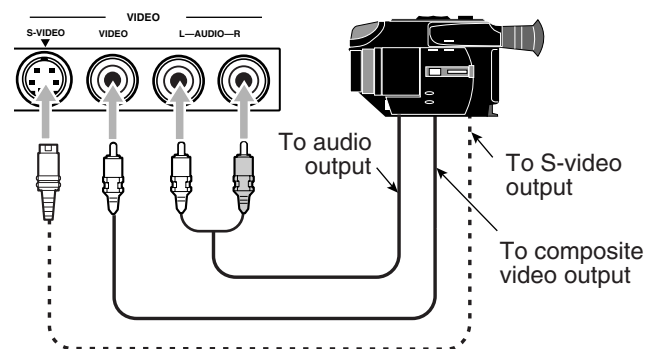
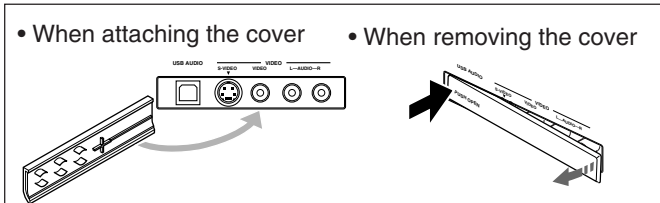

TV and/or DBS tuner

When connecting the TV to the AUDIO jacks (TV SOUND/DBS), DO NOT connect the TV's video output to these video input jacks.

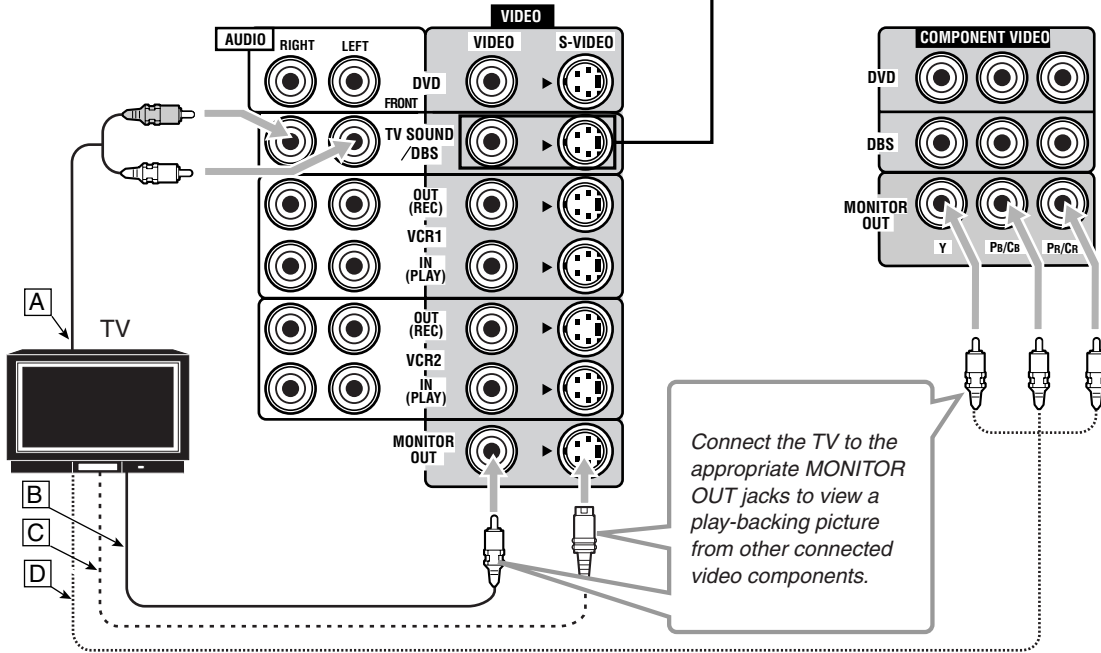

- A To audio output
- B To composite video input
- C To S-video input
- D To component video input

Note:

Use a TV of PAL- or multi-color system.

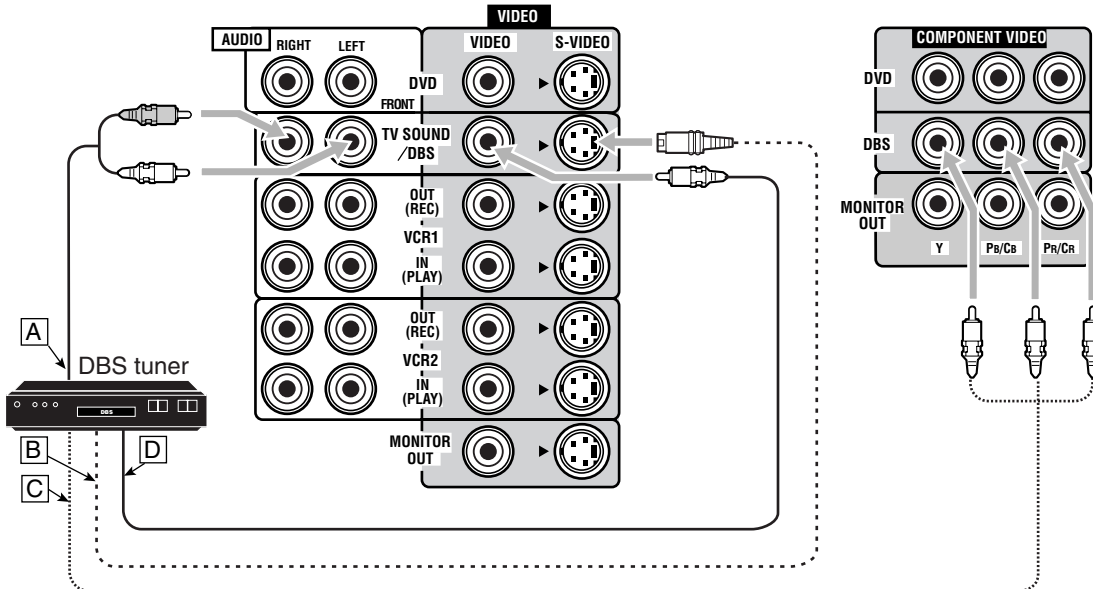

- A To audio output
- B To S-video output
- C To component video output
- D To composite video output

Notes:

- When connecting a DBS tuner to the TV SOUND/DBS jacks, change the source name to "DBS," which will be shown on the display when it is selected as the source. See page 17 for details.
- When connecting a DBS tuner to the component video input jacks, make the component video input setting correctly. See pages 25 and 49 for details.

DVD player

- When you connect a DVD player with stereo output jacks:

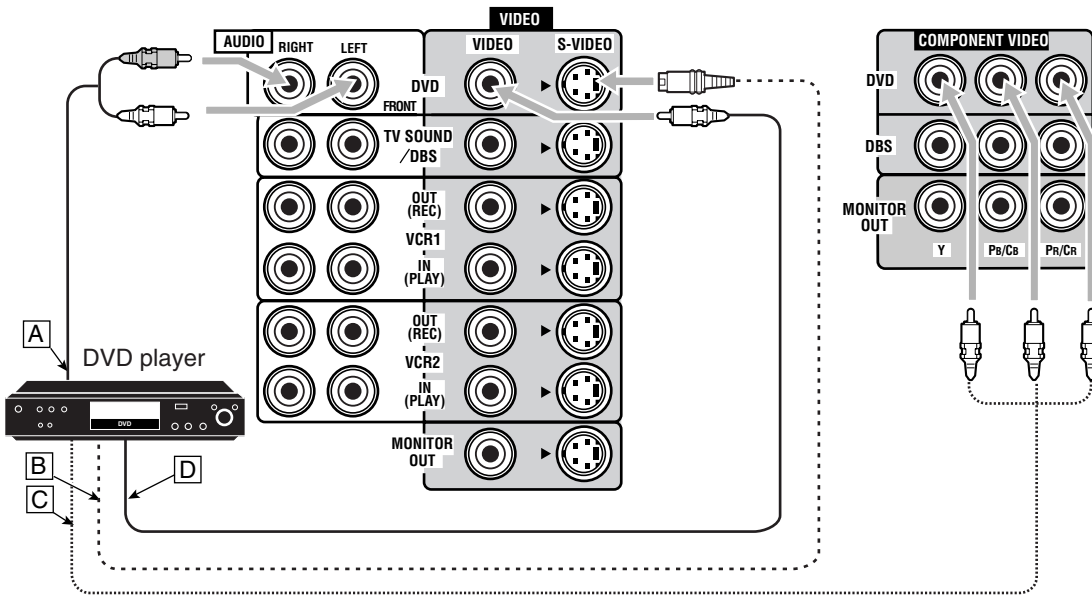

- A To front left/right audio output
- B To S-video output
- C To component video output
- D To composite video output

- When you connect a DVD player with its analog discrete output (5.1-channel reproduction) jacks:

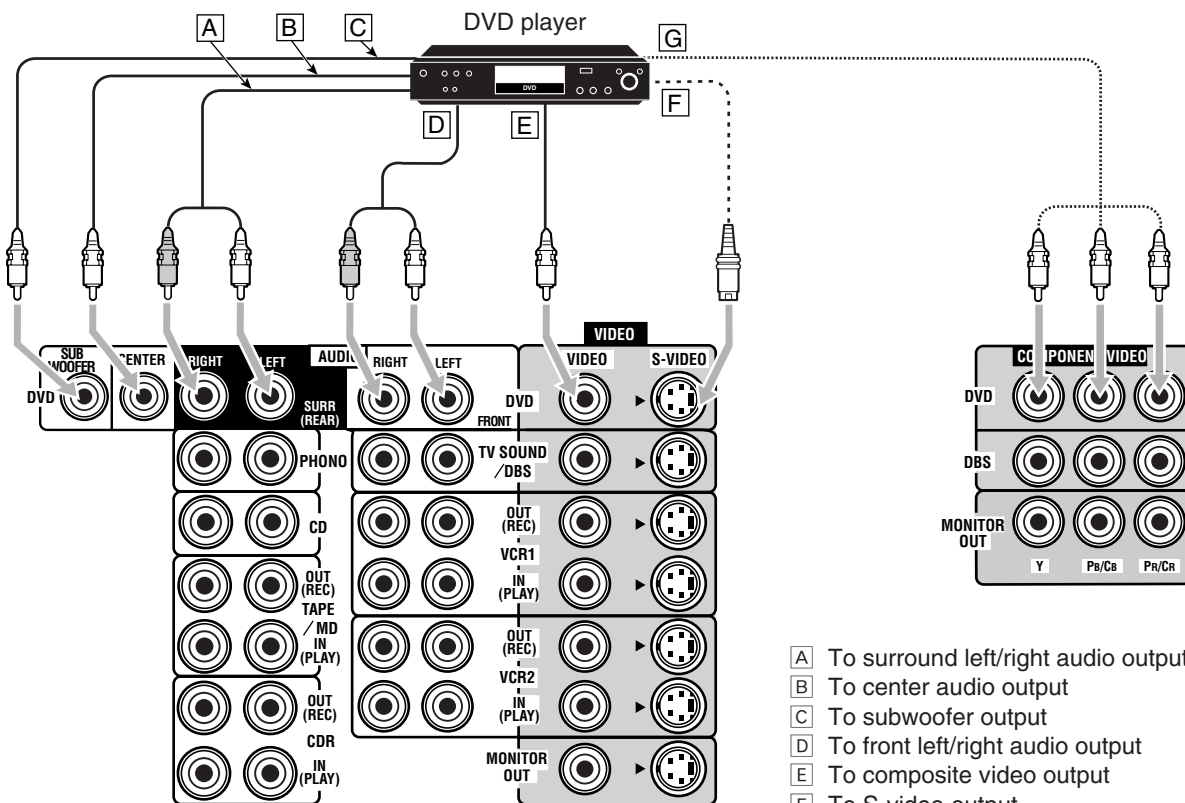

- A To surround left/right audio output
- B To center audio output
- C To subwoofer output
- D To front left/right audio output
- E To composite video output
- F To S-video output
- G To component video output

Note:

When connecting a DVD player to the component video input jacks, make the component video input setting correctly. See pages 25 and 49 for details.

Digital Connections

This receiver is equipped with four DIGITAL IN terminals—one digital coaxial terminal and three digital optical terminals—and one DIGITAL OUT terminal.

IMPORTANT:

- When connecting a DVD player, digital TV broadcast tuner or DBS tuner using the digital terminals, you also need to connect it to the video jacks on the rear. Without connecting it to the video jacks, you can view no playback picture.
- After connecting the components using the DIGITAL IN terminals, set the following correctly if necessary.
 - Set the digital input (DIGITAL IN) terminal setting correctly. For details, see “6 Setting the Digital Input (DIGITAL IN) Terminals” on page 25.
 - Select the digital input mode correctly. For details, see “Selecting the Analog or Digital Input Mode” on page 19.

Notes:

- When shipped from the factory, the DIGITAL IN terminals have been set for use with the following components:
 - DIGITAL 1 (coaxial): For DVD player
 - DIGITAL 2 (optical): For CD player
 - DIGITAL 3 (optical): For digital TV broadcast tuner
 - DIGITAL 4 (optical): For CD recorder
- When you want to operate the CD player, CD recorder, or MD recorder using the COMPU LINK remote control system, connect the target component also as described in “Analog Connections” (see page 9).
- When you want to operate a DVD player using the AV COMPU LINK remote control system (see page 49), connect the DVD player also as described in “Analog Connections” (see page 12).

Digital input terminals

You can connect any digital equipment as follows:

Digital TV



DBS tuner



DVD player



CD player



CD recorder



MD recorder



Digital coaxial cable (not supplied)
between digital coaxial terminals



Digital optical cable (not supplied)
between digital optical terminals



Digital output terminal

CD recorder



MD recorder



Digital optical cable (not supplied)
between digital optical terminals



When the digital recording equipment such as an MD recorder and CD recorder has a digital optical input terminal, connecting it to the DIGITAL OUT terminal enables you to perform digital-to-digital recording.

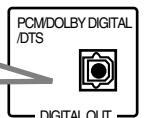

When the component has a digital coaxial output terminal, connect it to the DIGITAL 1 (DVD) terminal, using a digital coaxial cable (not supplied).

When the component has a digital optical output terminal, connect it to the DIGITAL 2 (CD), DIGITAL 3 (TV) or DIGITAL 4 (CDR) terminal, using a digital optical cable (not supplied).

Before connecting a digital optical cable, unplug the protective plug.

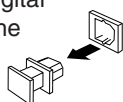

Note:

The digital signal format output through the DIGITAL OUT terminal is the same as that of the input signal. This means that when the DTS Digital Surround signals are input, the DTS Digital Surround signals are output.

USB Connection

This receiver is equipped with a USB terminal on the front panel. You can connect your PC to this terminal and enjoy sound reproduced through your PC.

When you connect your PC for the first time, follow the procedure below.

- Remember you cannot send any signal or data to your PC from this receiver.

IMPORTANT:

- Check if your PC equipped with the CD-ROM drive is running on Windows® 98*, Windows® Me* or Windows® XP* and prepare its CD-ROM.
- Check your PC's BIOS setting—whether USB is available, and whether USB IRQ is set to "AUTO" or to available IRQ number.

How to install the USB drivers

The following procedure is described using the English version of Windows® 98. If your PC is running on a different version of operation system or language, the screens shown on your PC's monitor will differ from the ones used in the following procedure.

1. Turn on your PC and start running Windows® 98, Windows® Me or Windows® XP.

If the PC has been turned on, quit all the applications now running.

2. Turn on the receiver, and press USB AUDIO on the front panel or USB on the remote control.

The lamp on the USB AUDIO button on the front panel lights up.

3. Connect the receiver to the PC using a USB cable (not supplied).

Your PC automatically recognizes this connection, and shows the following screen on the monitor.

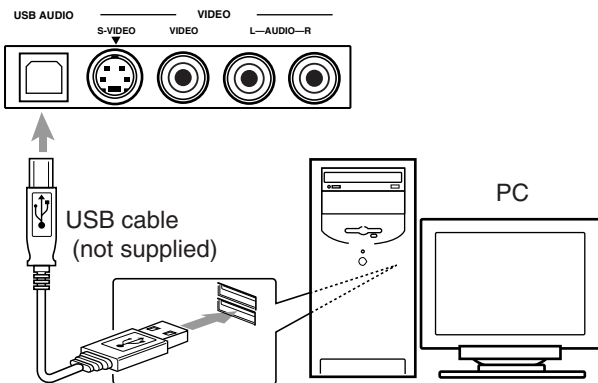

4. Install the USB drivers following the instructions shown on the PC's monitor.

5. Check if the drivers are correctly installed.

- Open the Control Panel on your PC: Select [Start] → [Settings] → [Control Panel].
- Select [System], then [Device Manager] and click [Sound, video and game controllers] and [Universal serial bus controller].

The following window appears, and you can check whether the drivers are installed.

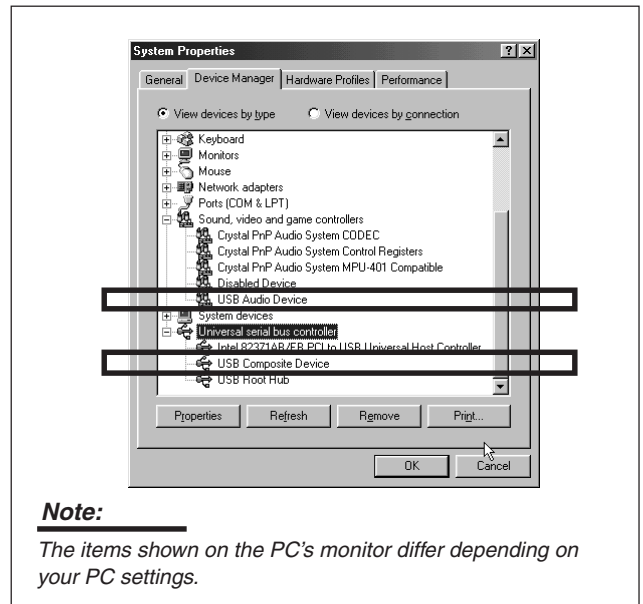

6. Change the PC audio setting.

- If you have closed Control Panel, open it again: Select [Start] → [Settings] → [Control Panel].
- Click [Multimedia], then select "USB Audio Device [1]" for "Playback" of "Audio," and close the window.

To play back a CD from CD-ROM drive on PC, click [Multimedia], [CD Music], then check [Enable digital CD audio for this CD-ROM device].

Now PC is ready for playback through the USB connection.

After installation is completed, you can use your PC as the playback source. The PC automatically recognizes the receiver whenever a USB cable is connected between the PC and the receiver while the receiver is turned on.

- When not using the PC as the playback source, disconnect the USB cable.

To play back sounds on the PC, refer to the manuals supplied with the sound reproduction application installed in the PC.

Notes:

- DO NOT turn off the receiver or disconnect the USB cable while installing the drivers and for several seconds while your PC is recognizing the receiver.
- Use a full speed USB cable (revision 1.0). Recommended cord length is 1.5 m.
- If your PC does not recognize the receiver, disconnect the USB cable and connect it again. If it does not work yet, restart Windows.
- The installed drivers can be recognized only when the USB cable is connected between the receiver and your PC.
- The sound may not be played back correctly—interrupted or degraded—due to your PC settings and PC specifications.
- When you do not use the terminals on the front panel, attach the supplied front terminal cover to protect them from dust.

* Microsoft®, Windows® 98, Windows® Me and Windows® XP are registered trademarks of Microsoft Corporation.

Connecting the Power Cord

Before plugging the receiver into an AC outlet, make sure that all connections have been made.

Plug the power cord into an AC outlet.

Keep the power cord away from the connecting cables and the antenna. The power cord may cause noise or screen interference. We recommend that you use a coaxial cable to connect the antenna, since it is well-shielded against interference.

Note:

The preset settings such as preset channels and sound adjustment may be erased in a few days in the following cases:

- When you unplug the power cord.
- When a power failure occurs.

CAUTIONS:

- Do not plug in before setting the voltage selector switch on the rear of the unit and all connection procedures are complete.
- Do not touch the power cord with wet hands.
- Do not pull on the power cord to unplug the cord. When unplugging the cord, always grasp the plug so as not to damage the cord.

Putting Batteries in the Remote Control

Before using the remote control, put two supplied batteries first. When using the remote control, aim the remote control directly at the remote sensor on the receiver.

1. On the back of the remote control, remove the battery cover.

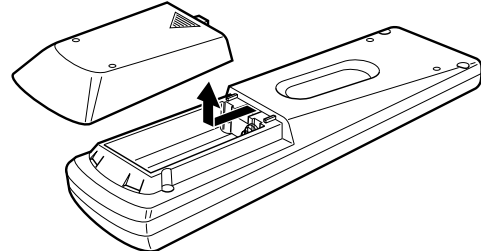

2. Insert batteries. Make sure to match the polarity: (+) to (+) and (-) to (-).

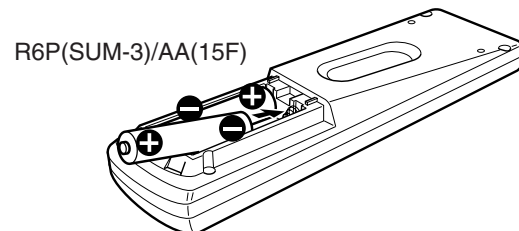

3. Replace the cover.

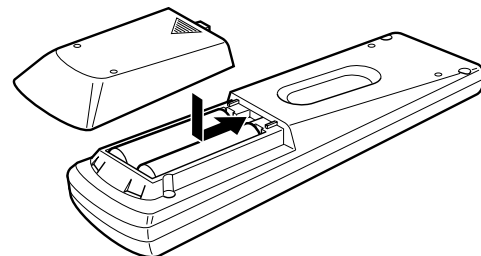

If the range or effectiveness of the remote control decreases, replace the batteries. Use two R6P(SUM-3)/AA(15F) type dry-cell batteries.

Note:

After replacing the batteries, set the manufacturers' codes again (see page 54).

CAUTION:

Follow these precautions to avoid leaking or cracking cells:

- Place batteries in the remote control so they match the polarity: (+) to (+) and (-) to (-).
- Use the correct type of batteries. Batteries that look similar may differ in voltage.
- Always replace both batteries at the same time.
- Do not expose batteries to heat or flame.

Basic Operations

The following operations are commonly used when you play any sound sources.

Before using the remote control

How to confirm the remote control operation mode

The display window on the remote control shows the following information when you press certain buttons on the remote control, so that you can confirm which operation you do.

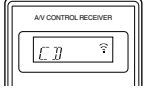
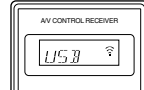
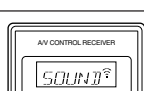
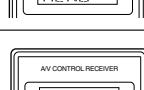
Pressing one of the source selecting buttons, the source name selected appears on the display.		
Buttons	Indications	Ex.: When you press CD.
FM/AM	TUNER	
CD	CD	
PHONO	PHONO	
TAPE/MD	TAPE	
DVD or DVD MULTI	DVD	
CDR	CDR	
USB	USB	
TV/DBS	TV	
VCR1	VCR1	
VCR2	VCR2	
VIDEO	VIDEO	
Pressing SOUND before you adjust the sound effect, "SOUND" appears on the display.		
Pressing TEXT DISPLAY or MENU before you use on-screen menu or TEXT COMPU LINK, "MENU" appears on the display.		
Pressing CONTROL or CATV/DBS CONTROL before you operate an audio or video equipment connected to the receiver, the remote control operation mode selected appears on the display (see pages 51 and 54).		
		Ex.: When you press CATV/DBS CONTROL.

Note:

A small amount of power is consumed in standby mode. To turn the power off completely, unplug the AC power cord.

Selecting the Source to Play

Press one of the source selecting buttons.

The lamp on the front panel button for selected source lights up.

- The selected source name and the previously selected Surround/DSP mode also appear on the display.

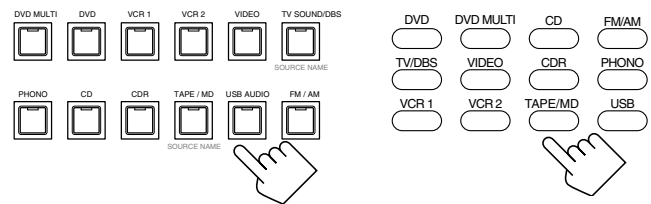

On the front panel

From the remote control

Selected source name and current Surround/DSP mode appear

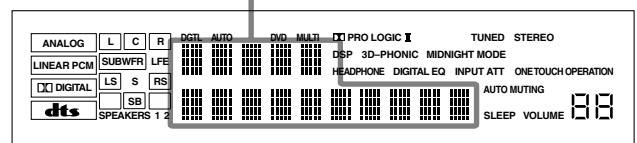

- DVD MULTI :Select the DVD player for viewing a DVD using the analog discrete output mode (5.1-channel reproduction). To enjoy the DVD MULTI playback, see page 37.
- DVD :Select the DVD player.
- VCR 1 :Select the video component connected to the VCR 1 jacks.
- VCR 2 :Select the video component connected to the VCR 2 jacks.
- VIDEO :Select the video component connected to the VIDEO jacks.
- TV (SOUND)/DBS :Select TV sounds (or the DBS tuner).
- PHONO * :Select the turntable.
- CD * :Select the CD player.
- CDR * :Select the CD recorder.
- TAPE/MD * :Select the cassette deck (or the MD recorder).
- USB (AUDIO) :Select the personal computer (PC) connected to the USB terminal.
- FM/AM * :Select an FM or AM broadcast.
- Each time you press the button, the band alternates between FM and AM.

Turning On the Power

On the front panel:

Press STANDBY/ON .

The STANDBY lamp goes off. The name of the current source and Surround/DSP mode appear on the display.

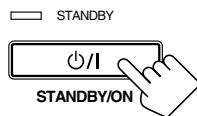

Current source name and Surround/DSP mode appear

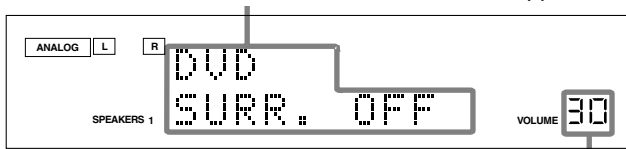

Current volume level appears

To turn off the power (into standby mode),

press STANDBY/ON  again.

The STANDBY lamp lights up.

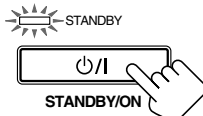

From the remote control:

Press AUDIO .

The STANDBY lamp on the front panel goes off. The name of the current source and Surround/DSP mode appear on the display.

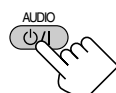

To turn off the power (into standby mode), press AUDIO  again. The STANDBY lamp on the front panel lights up.

Notes:

- When connecting an MD recorder (to the TAPE/MD jacks) and a DBS tuner (to the TV SOUND/DBS jacks), change the source names shown on the display. For details, see page 17.
- When you press one of the source selecting buttons on the remote control marked with an asterisk (*) above, the receiver automatically turns on.

Changing the source name

When you have connected an MD recorder to the TAPE/MD jacks or a DBS tuner to the TV SOUND/DBS jacks on the rear panel, change the source name which will be shown on the display.

On the front panel ONLY:

When changing the source name from "TAPE" to "MD":

1. Press TAPE/MD (SOURCE NAME).
 - Make sure "TAPE" appears on the display.
2. Press and hold SOURCE NAME (TAPE/MD) until "ASSGN. MD" appears on the display.

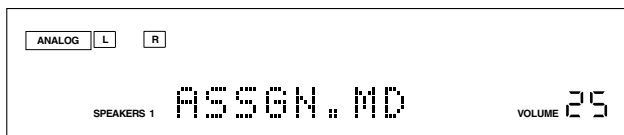

When changing the source name from "TV" to "DBS":

1. Press TV SOUND/DBS (SOURCE NAME).
 - Make sure "TV" appears on the display.
2. Press and hold SOURCE NAME (TV SOUND/DBS) until "ASSGN. DBS" appears on the display.

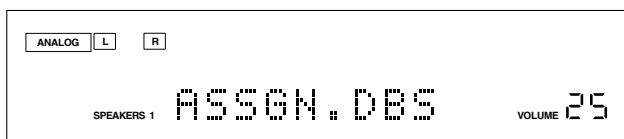
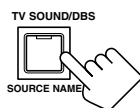

To change the source name to "TAPE" or "TV," repeat the same procedure above—press and hold SOURCE NAME (TAPE/MD) to select "TAPE," or press and hold SOURCE NAME (TV SOUND/DBS) to select "TV."

Note:

- Without changing the source name, you can still use the connected components. However, there may be some inconvenience.
- "TAPE" or "TV" will appear on the display when you select the MD recorder or DBS tuner.
 - You cannot use the digital input mode (see page 19) for the MD recorder.
 - You cannot use the COMPU LINK remote control system (see page 43) to operate the MD recorder.

Selecting different sources for picture and sound

You can watch picture from a video component while listening to sound from another component.

Press one of the audio source selecting buttons— PHONO, CD, CDR, TAPE/MD, USB (AUDIO), FM/AM—while viewing the picture from a video component such as the VCR or DVD player, etc.

The lamp on the front panel button for the selected source lights up.

On the front panel:

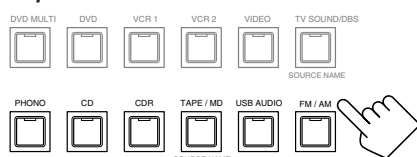

From the remote control:

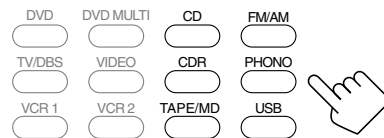

Note:

Once you have selected a video source, pictures of the selected source are sent to the TV until you select another video source.

Speaker and signal indicators on the display

By checking the following indicators, you can easily confirm which speakers you are activating and which signals are coming into this receiver from the source.

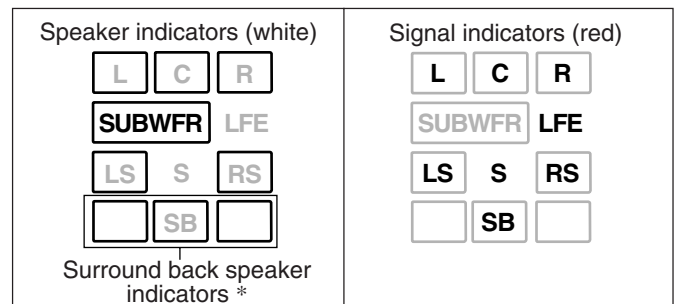

The speaker indicators light up—:

- When the corresponding speakers are set to "LARGE" or "SMALL" (see "[1] Setting the Speakers" on page 22) and are also required for the Surround/DSP mode currently selected.
 - *If you have selected "1SPK" for the surround back speaker quantity (see page 22), the center surround back speaker indicator lights up. If you have selected "2SPK," the left and right surround back speaker indicators light up.
- When "SUBWOOFER" is set to "YES," [SUBWFR] lights up. (See "[1] Setting the Speakers" on page 22.)

The signal indicators light up to indicate the incoming signals.

- L : • **When digital input is selected:** Lights up when the left channel signal comes in.
 - **When analog input is selected:** Always lights up.
- R : • **When digital input is selected:** Lights up when the right channel signal comes in.
 - **When analog input is selected:** Always lights up.
- C : Lights up when the center channel signal comes in.
- LFE : Lights up when the LFE channel signal comes in.
- LS : Lights up when the left surround channel signal comes in.
- RS : Lights up when the right surround channel signal comes in.
- S : When the monaural rear channel signal or 2 channel Dolby Surround encoded signal comes in.
- SB : Lights up when the surround back channel signal comes in.

Note:

When "DVD MULTI" is selected as the source, "L," "C," "R," "LFE," "LS" and "RS" light up.

Adjusting the Volume

On the front panel:

To increase the volume, turn MASTER VOLUME clockwise.

To decrease the volume, turn it counterclockwise.

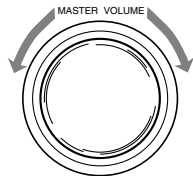

From the remote control:

To increase the volume, press VOLUME +.

To decrease the volume, press VOLUME -.



CAUTION:

Always set the volume to the minimum before starting any sources. If the volume is set at its high level, the sudden blast of sound energy can permanently damage your hearing and/or ruin your speakers.

Notes:

- The volume level can be adjusted within the range of “0” (minimum) to “70” (maximum).
- If you set One Touch Operation to “ON” (see page 26), you do not have to adjust the volume level each time you change the source. It is automatically set to the stored level.

Selecting the Front Speakers

On the front panel ONLY:

When you have connected two pairs of the front speakers, you can select which to use.

To use the speakers connected to the FRONT SPEAKERS ① terminals, press SPEAKERS ON/OFF 1 so that the SPEAKERS 1 indicator lights up on the display. Make sure that the SPEAKERS 2 indicator is not lit on the display.

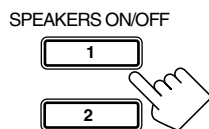

To use the speakers connected to the FRONT SPEAKERS ② terminals, press SPEAKERS ON/OFF 2 so that SPEAKERS 2 indicator lights up on the display. Make sure that the SPEAKERS 1 indicator is not lit on the display.

To use both sets of the speakers, press SPEAKERS ON/OFF 1 and SPEAKERS ON/OFF 2 so that the SPEAKERS 1 and SPEAKERS 2 indicators light up on the display.

To use neither sets of the speakers, press SPEAKERS ON/OFF 1 and SPEAKERS ON/OFF 2 so that the SPEAKERS 1 and SPEAKERS 2 indicators disappear from the display. The HEADPHONE indicator lights up and “HEADPHONE” appears on the display.

- Activating the speakers turns on the Surround and DSP modes previously selected.

Listening Only with Headphones

You can listen with the headphones without deactivating both pairs of speakers by connecting a pair of headphones to the PHONES jack on the front panel. If you want to use a pair of headphones without outputting sounds from the front speakers, you must turn off both pairs of the front speakers as mentioned above.

HEADPHONE mode

When using the headphones, the following signals are output regardless of your speaker setting:

- For 2 channel software, the front left and right channel signals are output directly from the headphones.
- For multi-channel software, the front left and right, center, and surround channel signals are down-mixed and then output from the headphones.

- If a DSP mode is activated, you can enjoy the DSP effects. “3D H.PHONE” appears on the display and the DSP indicator lights up on the display. (See page 34.)

Note:

In the following cases, the speakers connected to the FRONT SPEAKERS ② terminals are deactivated even if both pairs of the front speakers are activated.

- If you select “DVD MULTI” as the source.
- If you select any of the Surround/DSP modes which activate the center and/or surround speaker(s).

CAUTION:

Be sure to turn down the volume:

- Before connecting or putting on headphones, as its high volume can damage both the headphones and your hearing.
- Before turning on speakers again, as its high volume may output from the speakers.

Selecting the Analog or Digital Input Mode

When you have connected digital source components using the digital terminals (see page 13), you need to change the input mode for these components to the appropriate digital input mode correctly—DGTL AUTO, DGTL DTS, or DGTL D.D.

Before you start, remember...

The digital input (DIGITAL IN) terminal setting should be correctly done for the sources you want to select the digital input mode for (see “6 Setting the Digital Input (DIGITAL IN) Terminals” on page 25). Without setting this digital input terminal correctly, you cannot change the input mode from analog input to digital input even if you follow the procedure below.

1. Press one of the source selecting buttons—DVD, TV (SOUND)/DBS, CD, CDR or TAPE/MD—for which you want to change the input mode.

The lamp on the front panel button for the selected source lights up.

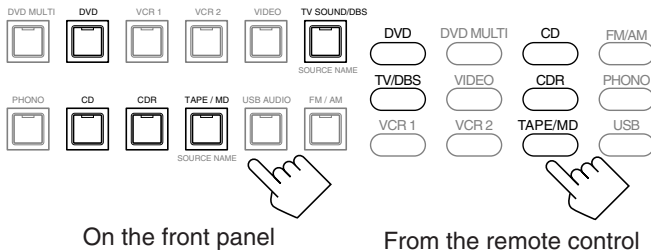

On the front panel

From the remote control

Note:

If “TAPE” has been assigned as the source name to the TAPE/MD button when using an MD recorder, it does not work in this step. To change the source name, see “Changing the source name” on page 17.

2. Press INPUT ANALOG/DIGITAL (INPUT ATT)—or ANALOG/DIGITAL INPUT on the remote control—briefly to change the input mode.



On the front panel

From the remote control

- Each time you press the button, the input mode changes as follows:

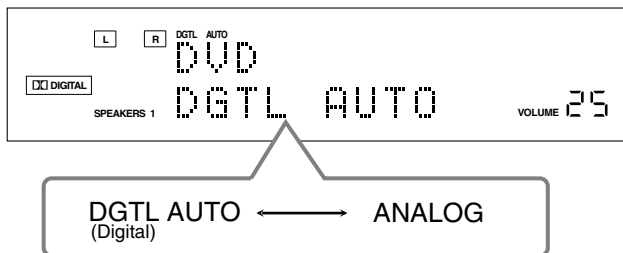

DGTL AUTO: Select this for the digital input mode. The receiver automatically detects the incoming signals.

The DGTL AUTO indicator lights up on the display, and the digital signal format indicators for the detected signals also light up.

ANALOG: Select this for the analog input mode.

The ANALOG indicator lights up.

When selecting “DGTL AUTO,” the following indicators showing detected signals light up on the display.

LINEAR PCM : Lights up when Linear PCM signals come in.

LINEAR PCM : Lights up when the digital signals are not recognized.

DIGITAL : Lights up when Dolby Digital or Dolby Digital EX signals come in.

dts : Lights up when DTS Digital Surround or DTS-ES signals come in.

When playing a software encoded with the Dolby Digital or DTS Digital Surround, the following symptoms may occur:

- Sound does not come out at the beginning of playback.
- Noise comes out while chapters or tracks are being searched for or skipped over.

1. Press INPUT ANALOG/DIGITAL (INPUT ATT) or ANALOG/DIGITAL INPUT on the remote control.

- “DGTL AUTO” appears on the display.

2. Press CONTROL UP ▲ or DOWN ▼ on the front panel to select “DGTL D.D” or “DGTL DTS” while “DGTL AUTO” still remains on the display.

- Each time you press the button, the input mode changes as follows:

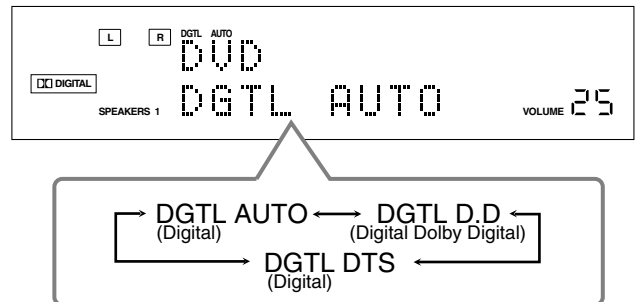

When selecting “DGTL D.D” or “DGTL DTS,” the following indicators showing detected signals light up on the display.

DGTL : Always lights up.

When selecting “DGTL D.D”

DIGITAL : • Lights up when Dolby Digital signals come in.

• The frame flashes when Dolby Digital signals are not recognized.

When selecting “DGTL DTS”

dts : • Lights up when DTS Digital Surround signals come in.

• The frame flashes when DTS Digital Surround signals are not recognized.

Note:

When you turn off the power or select another source, “DGTL D.D” and “DGTL DTS” settings are canceled and the digital input mode is automatically reset to “DGTL AUTO.”

Muting the Sound

From the remote control ONLY:

Press **MUTING** to mute the sound through all speakers and headphones connected.

“MUTING” appears on the display and the volume turns off (the volume level indicator goes off).

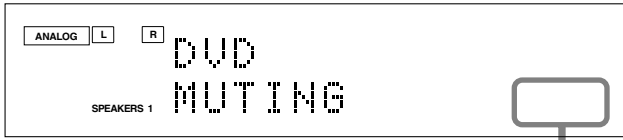
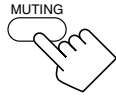

Ex.: When the source is “DVD.”

The volume level indicator goes off.

To restore the sound, press **MUTING** again.

- Turning **MASTER VOLUME** on the front panel or pressing **VOLUME +/-** on the remote control also restores the sound.

Changing the Display Brightness

You can dim the display.

From the remote control ONLY:

Press **DIMMER**.

- Each time you press the button, the display dims and brightens alternately.



Using the Sleep Timer

Using the Sleep Timer, you can fall asleep while listening to music.

From the remote control ONLY:

Press **SLEEP** repeatedly.

The **SLEEP** indicator lights up on the display, and the shut-off time changes in 10 minutes intervals.

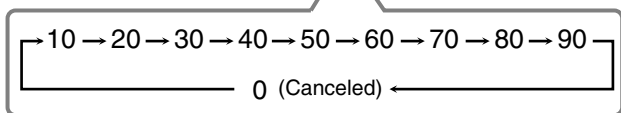

Ex.: When the source is “DVD.”

When the shut-off time comes:

The receiver turns off automatically.

To check or change the time remaining until the shut-off time:

Press **SLEEP** once.

The remaining time until the shut-off time appears in minutes.

- To change the shut-off time, press **SLEEP** repeatedly.

To cancel the Sleep Timer:

Press **SLEEP** repeatedly until “**SLEEP 0min**” appears on the display. (The **SLEEP** indicator goes off.)

- Turning off the power also cancels the Sleep Timer.

Recording a source

For analog-to-analog recording

You can record any analog source through the receiver to—

- the cassette deck (or MD recorder) connected to the **TAPE/MD** jacks,
- the **VCRs** connected to the **VCR 1** and **VCR 2** jacks, and
- the **CD recorder** connected to the **CDR** jacks—
—at the same time.

For digital-to-digital recording

You can record the currently selected digital input source through the receiver to a digital recording device connected to the **DIGITAL OUT** terminal.

Notes:

- Analog-to-digital and digital-to-analog recordings are not possible.
- The output volume level, **Midnight Mode** (see page 24), **Bass Boost** (see page 31), **digital equalization** (see page 39), **Surround modes** and **DSP modes** (see pages 32 to 36) cannot affect the recording.
- The test tone signal (see pages 40 and 41) does not come out through the **DIGITAL OUT** terminal.

Basic adjustment auto memory

This receiver memorizes sound settings for each source—

- when you turn off the power,
- when you change the source, and
- when you assign the source name (see page 17).

When you change the source, the memorized settings for the newly selected source are automatically recalled.

The following can be stored for each source:

- Analog/digital input mode (see page 19)
- Input attenuator mode (see page 30)
- Analog Direct (see page 30)
- Speaker channel output levels (see pages 40 and 41)
- Digital equalization pattern (see page 39)
- Sound parameters (see page 42)
- Surround and DSP mode selection (see pages 35 and 36)
- Bass Boost setting (see page 31)

Notes:

- If the source is **FM** or **AM**, you can assign a different setting for each band.
- If you want to memorize the volume level with the above settings, set “**ONE TOUCH (OPR)**” to “**ON**” (see page 26).

Basic Settings

Some of the following settings are required after connecting and positioning your speakers while others will make operations easier.

- When performing the basic settings, it is recommended to use the remote control so that you can show the on-screen display on the TV.
- When using the buttons on the front panel, you can perform the same settings. (The following on-screen display cannot be shown if you use the buttons on the front panel.)
- The on-screen display will disappear if no operation is done for about 1 minute.

Basic Procedure

Ex. When setting the subwoofer information

Using the on-screen display (through the remote control):

1. Press MENU.

The MENU screen appears on the TV.

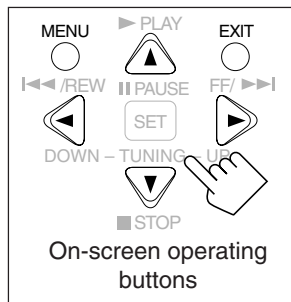
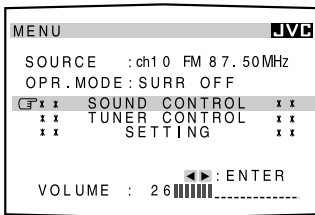

2. Press ▲ or ▼ to move to “SETTING,” then press ◀ or ▶.

SETTING 1 menu showing setting items appears on the TV.

- The item pointed by is also shown on the display on the unit.

3. Press ▲ or ▼ to move to “SUBWOOFER.”

- To go to the next screen, press ▼ continuously.
- To go back to the previous screen, press ▲ continuously.

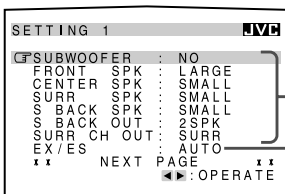

SETTING 1 menu

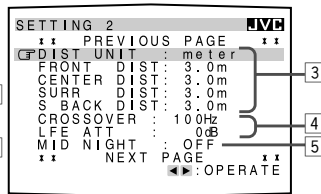

SETTING 2 menu

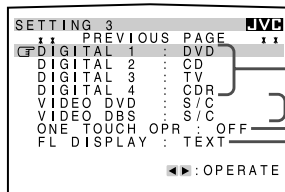

SETTING 3 menu

For details about each setting item (1 to 9), see pages 22 to 26.

4. Press ◀ or ▶ to select a setting you want to use.

In this example, the subwoofer information is set to “YES” to output bass sound through the subwoofer.

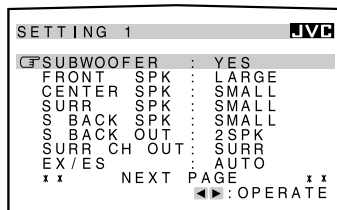

5. When you finish, press EXIT repeatedly until the menu disappears from the TV.

On the front panel:

Before you start, remember...

There is a time limit in doing the following steps. If the setting is canceled before you finish, start from step 1 again.

1. Press SETTING repeatedly until “SUB WOOFER” appears on the display.

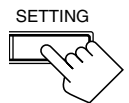

Each time you press the button, the setting items change as follows.

- For details about each setting item (1 to 9), see pages 22 to 26.



SUB WOOFER:NO (1)	FRONT SPK:LARGE (1)
CNTR SPK:SMALL (1)	SURR SPK:SMALL (1)
SBACK SPK:SMALL (1)	SBACK OUT:2SPK (1)
SURR CH:SURR (1)	EX/ES:AUTO (2)
DIST UNIT:meter (3)	FRONT DIST:3.0m (3)
CNTR DIST:3.0m (3)	SURR DIST:3.0m (3)
SBACK DIST:3.0m (3)	CROSS OVER:100Hz (4)
LFE ATT:0dB (4)	MID NIGHT:OFF (5)
DGTL COAX 1:DVD (6)	2:CD 3:TV 4:CDR (6)
VIDEO DVD:S/C (7)	VIDEO DBS:S/C (7)
ONE TOUCH:OFF (8)	FL DISP:TEXT (9)

(Back to the beginning)

2. Press CONTROL UP ▲ or DOWN ▼ to select a setting you want to use.

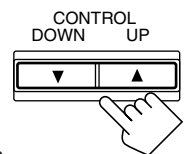

In this example, the subwoofer information is set to “YES” to output bass sound through the subwoofer.



NOTICE—

- Items shown on the on-screen display and on the front panel display in this section are initial values when shipped from the factory.
- Some of the items cannot be shown or cannot be adjusted according to currently selected settings. (For details, see the respective explanation.)

1 Setting the Speakers

To obtain the best possible surround sound from the Surround and DSP modes, you have to register the setting about the speaker arrangement after all connections are completed.

■ Subwoofer setting—SUBWOOFER

[On-screen display]

[Front panel]

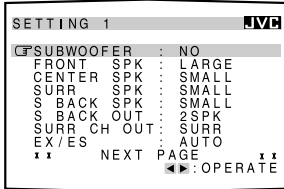

Select whether you have connected a subwoofer or not.

YES : Select this when a subwoofer is connected.

NO : Select this when no subwoofer is used.

Note:

If you have selected "NO" for the subwoofer, you cannot use SUBWOOFER OUT ON/OFF on the front panel.

■ Sizes for front speakers, center speaker, surround speakers, and surround back speakers—FRONT SPK, CENTER (CNTR) SPK, SURR SPK, S BACK (SBACK) SPK

[On-screen display]

[Front panel]

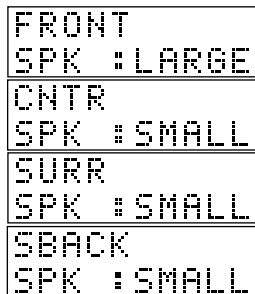
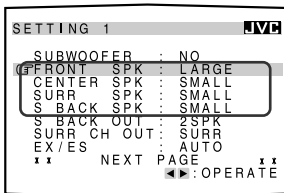

Select the sizes for each connected speaker.

LARGE : Select this when the speaker size is relatively large.

SMALL : Select this when the speaker size is relatively small.

NONE : Select this when you have not connected a speaker. (Not selectable for the front speakers)

Notes:

- Keep the following comments in mind as reference when adjusting.
 - If the size of the cone speaker unit built in your speaker is larger than 12 cm, select "LARGE," and if it is smaller than 12 cm, select "SMALL."
- If you have selected "NO" for the subwoofer setting, you can only select "LARGE" for the front speakers.
- If you have selected "SMALL" for the front speakers, you cannot select "LARGE" for the center, surround, and surround back speakers.
- If you have selected "SMALL" for the surround speakers, you cannot select "LARGE" for the surround back speakers.
- If you have selected "NONE" for the surround speakers, the surround back speakers are fixed to "NONE."

■ Surround back speakers quantity—S BACK (SBACK) OUT

[On-screen display]

[Front panel]

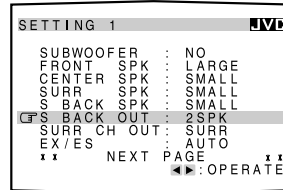

Select the surround back speakers quantity.

2SPK : Select this to use 2 surround back speakers.

1SPK : Select this to use 1 surround back speaker.

Notes:

- If you have selected "NONE" for the surround back speakers (see the left), this setting cannot be available.
- If you have selected "1SPK" for the surround back speaker quantity, connect the surround back speaker to the PRE OUT SURR BACK L (left) jack.

■ Selecting surround speakers to use—SURR CH (OUT)

[On-screen display]

[Front panel]

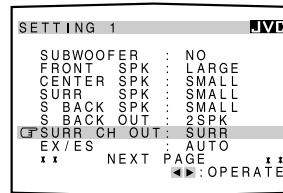

Select the surround speakers to activate when playing back 5.1-multi-channel software.

SURR : Select this to use only the left and right surround speakers.

SBACK : Select this to use only the surround back speakers.

SURR+SBACK (S+SBK) : Select this to use both the surround speakers and surround back speakers.

Notes:

- If you have selected "NONE" for the surround back speakers (see the left), this setting is skipped.
- If you have selected "1SPK" for the surround back speaker quantity, this setting is skipped. The surround channels' signals are output through the surround speakers.
- This setting is ignored when performing 6.1-channel reproduction.

2 Selecting Channel Numbers to Reproduce Multi-channel Digital Software—EX/ES

[On-screen display]

[Front panel]

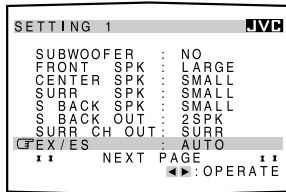

You can select 5.1-channel reproduction or 6.1-channel reproduction when playing back multi-channel (more than 5.1-channel) digital software with setting the surround back speakers to “LARGE” or “SMALL” (see page 22). “AUTO” is initial setting.

AUTO: Select this to reproduce signals originally recorded as marked on the software such as or .

- When playing back Dolby Digital EX software (bearing the mark , “DOLBY D EX (Dolby Digital EX)” activates using the surround back speaker(s).
- When playing back Dolby Digital 5.1-channel software, “DOLBY D (Dolby Digital)” activates without using the surround back speaker(s).
- When playing back DTS-ES Discrete software (bearing the mark , “ES DSCRETE (DTS-ES Discrete)” activates using the surround back speaker(s).
- When playing back DTS-ES Matrix software (bearing the mark , “ES MATRIX (DTS-ES Matrix)” activates using the surround back speaker(s).
- When playing back DTS Digital Surround 5.1-channel software, “DTS (DTS Digital Surround)” activates without using the surround back speaker(s).

ON : Select this to activate 6.1-channel reproduction using the surround back speaker(s).

- When playing back Dolby Digital EX software (bearing the mark , “DOLBY D EX (Dolby Digital EX)” activates using the surround back speaker(s).
- When playing back Dolby Digital 5.1-channel software, “DOLBY D EX (Dolby Digital EX)” activates using the surround back speaker(s). Surround back channels are reproduced using digital matrix processing.
- When playing back DTS-ES Discrete software (bearing the mark , “ES DSCRETE (DTS-ES Discrete)” activates using the surround back speaker(s).
- When playing back DTS-ES Matrix software (bearing the mark , “ES MATRIX (DTS-ES Matrix)” activates using the surround back speaker(s).
- When playing back DTS Digital Surround 5.1-channel software, “DTS NEO:6” activates using the surround back speaker(s). Surround back channels are reproduced using digital matrix processing.

OFF : Select this to activate 5.1-channel reproduction without using the surround back speaker(s).

- When playing back Dolby Digital EX software (bearing the mark) or DTS-ES software (bearing the mark , the surround back signals are output from the surround speakers mixed with the surround signals.
- When playing back Dolby Digital or DTS Digital Surround 5.1-channel software, conventional “DOLBY D (Dolby Digital)” or “DTS (DTS Digital Surround)” activates.

Note:

If you have selected “NONE” for the surround back speakers (see page 22), you cannot select this setting. The 6.1-channel and 5.1-channel software are played back as “OFF” is selected.

3 Setting the Speaker Distance

The distance from your listening point to the speakers is another important element to obtain the best possible sound of the Surround and DSP modes. You need to set the distance from your listening point to the speakers.

By referring to the speaker distance setting, this unit automatically sets the delay time of the sound through each speaker so that sounds through all the speakers can reach you at the same time.

Measuring unit—DIST UNIT

[On-screen display]

[Front panel]

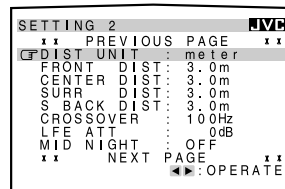

Select which unit you use.

meter : Select this to set the distance in meters.

feet : Select this to set the distance in feet.

Speaker distance—FRONT DIST, CENTER (CNTR) DIST, SURR DIST, S BACK (SBACK) DIST

[On-screen display]

[Front panel]

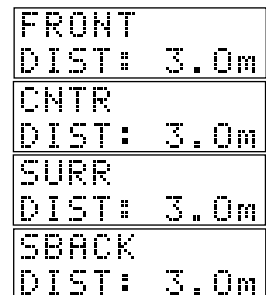
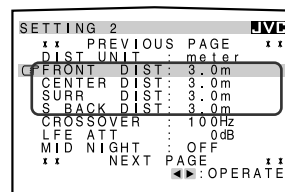

Set the distance from the listening point within the range of **0.3 m (1 ft) to 9.0 m (30 ft)**, in 0.3 m (1 ft) intervals.

Notes:

- You cannot set the speaker distance for the speakers you have selected “NONE” (see page 22).
- This setting is not valid for the DVD MULTI playback mode.

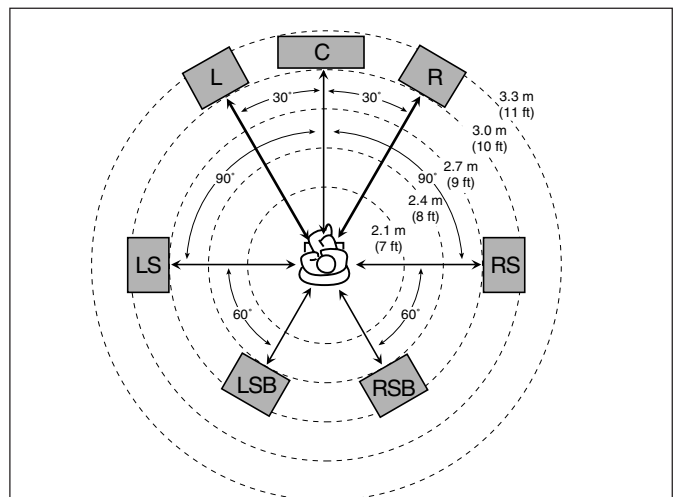

EX. In the above case, set the speaker distance as follows:

FRONT DIST	:	3.0 m or 10 ft
CENTER (CNTR) DIST	:	3.0 m or 10 ft
SURR DIST	:	2.7 m or 9 ft
S BACK (SBACK) DIST	:	2.4 m or 8 ft

4 Setting the Bass Sounds

You can adjust subwoofer and bass sounds precisely according to your preference.

■ Crossover frequency—CROSSOVER

[On-screen display]

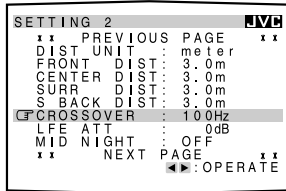

[Front panel]



When you use a subwoofer, you can select the cutoff frequency for the small speakers used.

Select one of the crossover frequency levels from “80Hz,” “100Hz,” “120Hz” and “150Hz” according to the size of the small speaker connected.

- | | |
|--------------|---|
| 80Hz | : Select this frequency when the cone speaker unit built in the speaker is about 12 cm. |
| 100Hz | : Select this frequency when the cone speaker unit built in the speaker is about 10 cm. |
| 120Hz | : Select this frequency when the cone speaker unit built in the speaker is about 8 cm. |
| 150Hz | : Select this frequency when the cone speaker unit built in the speaker is about 6 cm. |

Notes:

- If you have selected “LARGE” for all activated speakers (see page 22), this function is fixed to “OFF.”
- Crossover frequency is not valid for the DVD MULTI playback, All Channel Stereo and 3D HEADPHONE mode.

■ Low frequency effect attenuator—LFE ATT

[On-screen display]

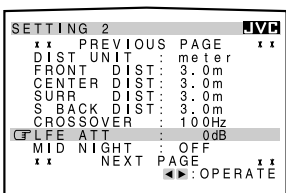

[Front panel]



If the bass sound is distorted while playing back software encoded with Dolby Digital or DTS Digital Surround, set the LFE level to eliminate distortion.

Select one of the following:

- | | |
|--------------|---|
| 0dB | : Normally select this. |
| -10dB | : Select this when the bass sound is distorted. |

5 Setting the Dynamic Range—MID NIGHT

[On-screen display]

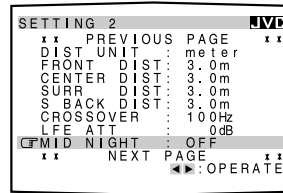

[Front panel]



You can enjoy a powerful sound at night using the Midnight Mode.

Select one of the following:

- | | |
|------------|---|
| 1 | : Select this when you want to reduce the dynamic range. The MIDNIGHT MODE indicator lights up on the display. |
| 2 | : Select this when you want to apply the compression effect (useful at midnight). The MIDNIGHT MODE indicator lights up on the display. |
| OFF | : Select this when you want to enjoy surround with its full dynamic range (no effect applied). The MIDNIGHT MODE indicator goes off from the display. |

Notes:

- If Analog Direct is in use, Midnight Mode is temporarily canceled.
- Midnight Mode is not valid for DVD MULTI playback mode even though the setting is adjustable.

6 Setting the Digital Input (DIGITAL IN) Terminals

[On-screen display]

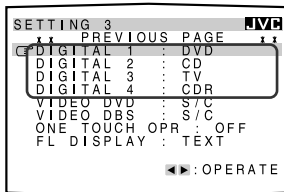

[Front panel]

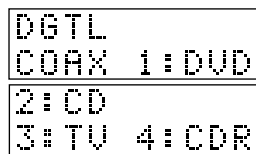

When you use the digital input terminals, you have to register which components you have connected to the digital input terminals.

■ Digital coaxial terminal—DIGITAL 1 (DGTL COAX 1)

Set the component connected to the digital coaxial terminal (DIGITAL IN 1)—DVD, MD**, CDR, TV (or DBS*) or CD.

* If you have changed the source name from "TV" to "DBS," "DBS" appears (see page 17).

** If you want to connect an MD recorder to the digital input terminal, change the source name to "MD" from "TAPE" (see page 17).

■ Digital optical terminals—DIGITAL 2, DIGITAL 3 and DIGITAL 4

Set the components connected to the digital optical terminals (DIGITAL IN 2 – 4).

- Each time you press ◀ or ▶ on the remote control or CONTROL UP ▲ or DOWN ▼ on the front panel, the digital component names change as follows:

When "DIGITAL 1 (DGTL COAX 1)" is set to "DVD"

```

2: CD 3: TV (or DBS*) 4: CDR  ⇐⇒
2: CD 3: TV (or DBS*) 4: MD** ⇐⇒
2: CD 3: MD**  4: CDR      ⇐⇒
2: MD** 3: TV (or DBS*) 4: CDR ⇐⇒
(back to the beginning)
    
```

When "DIGITAL 1 (DGTL COAX 1)" is set to "MD"***

```

2: CD 3: TV (or DBS*) 4: CDR  ⇐⇒
2: CD 3: TV (or DBS*) 4: DVD  ⇐⇒
2: CD 3: DVD  4: CDR      ⇐⇒
2: DVD 3: TV (or DBS*) 4: CDR ⇐⇒
(back to the beginning)
    
```

When "DIGITAL 1 (DGTL COAX 1)" is set to "CDR"

```

2: CD 3: TV (or DBS*) 4: DVD  ⇐⇒
2: CD 3: TV (or DBS*) 4: MD** ⇐⇒
2: CD 3: MD**  4: DVD      ⇐⇒
2: MD** 3: TV (or DBS*) 4: DVD ⇐⇒
(back to the beginning)
    
```

When "DIGITAL 1 (DGTL COAX 1)" is set to "TV" or "DBS"***

```

2: CD 3: DVD 4: CDR  ⇐⇒ 2: CD 3: DVD 4: MD**  ⇐⇒
2: CD 3: MD** 4: CDR ⇐⇒ 2: MD** 3: DVD 4: CDR  ⇐⇒
(back to the beginning)
    
```

When "DIGITAL 1 (DGTL COAX 1)" is set to "CD"

```

2: DVD 3: TV (or DBS*) 4: CDR  ⇐⇒
2: DVD 3: TV (or DBS*) 4: MD** ⇐⇒
2: DVD 3: MD**  4: CDR      ⇐⇒
2: MD** 3: TV (or DBS*) 4: CDR ⇐⇒
(back to the beginning)
    
```

* If you have changed the source name from "TV" to "DBS," "DBS" appears (see page 17).

** If you want to connect an MD recorder to the digital input terminal, change the source name to "MD" from "TAPE" (see page 17).

Note:

When shipped from the factory, the DIGITAL IN terminals have been set for use with the following components:

- DIGITAL 1 (coaxial): For DVD player
- DIGITAL 2 (optical): For CD player
- DIGITAL 3 (optical): For digital TV broadcast tuner
- DIGITAL 4 (optical): For CD recorder

7 Setting the Component Video Input

When you use the component video inputs for the DVD player and/or DBS tuner, you have to register the type of input jacks.

Without setting this correctly, you cannot view the correct input on the TV.

■ For the DVD player—VIDEO DVD

[On-screen display]

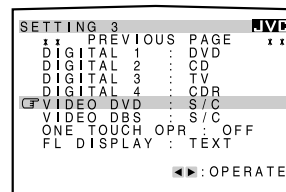

[Front panel]

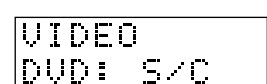

Select one of the following:

COMPONENT (COMPNT) : Select this when connecting the DVD player to the component video input jacks.

S/C : Select this when connecting the DVD player to the composite video or S-video input jacks.

■ For the DBS tuner—VIDEO DBS

[On-screen display]

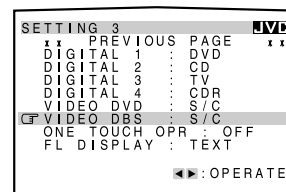

[Front panel]

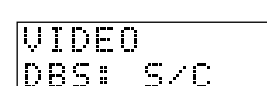

Select one of the following:

COMPONENT (COMPNT) : Select this when connecting the DBS tuner to the component video input jacks.

S/C : Select this when connecting the DBS tuner to the composite video or S-video input jacks.

Note:

If you have not selected appropriate video input jacks, the AV COMPU LINK remote control system cannot operate properly. (See page 49.)

8 Memorizing the Volume Level for Each Source
—ONE TOUCH OPR (ONE TOUCH)

[On-screen display]

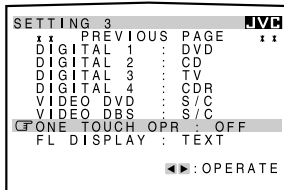

[Front panel]



9 Showing the Text Information on the Display
—FL DISPLAY (DISP)

[On-screen display]

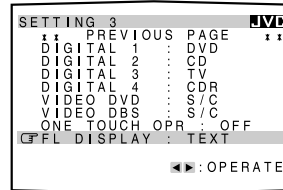

[Front panel]



This unit memorizes some settings separately for each source (see page 20).

In addition, you can store the volume level for each source with the other memorized settings.

Select one of the following:

ON : Select this to store the volume level separately for each source. (The ONE TOUCH OPERATION indicator lights up on the display.)

This receiver memorizes the volume level—

- when you change the source
- when you change the source name.

OFF : Select this not to store the volume level.

To recall the volume level

With the ONE TOUCH OPERATION indicator lit, the volume level for the currently selected source is recalled when the source is selected.

To cancel the One Touch Operation

Set One Touch Operation to “OFF” so that the ONE TOUCH OPERATION indicator goes off.

When you have connected an MD recorder or CD player equipped with TEXT COMPU LINK remote control system (see page 44), you can show the text information such as disc title or track title on the display of this receiver.

Select one of the following:

NORMAL : Source name and Surround/DSP mode appear during play.

TEXT : Text information appears during play.

Note:

Though you have selected “TEXT,” the source name and Surround/DSP mode will appear while playing a disc that has no text information.

Receiving Radio Broadcasts

You can browse through all the stations or use the preset function to go immediately to a particular station.

Tuning into Stations Manually

On the front panel:

1. Press FM/AM to select the band (FM or AM).

The FM/AM lamp on the front panel button lights up. The last received station of the selected band is tuned in.

- Each time you press the button, the band alternates between FM and AM.

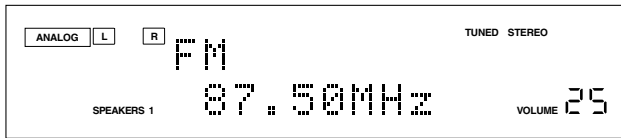
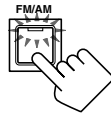

2. Press FM/AM TUNING ▲ or ▼ until you find the frequency you want.

- Pressing FM/AM TUNING ▲ increases the frequency.
- Pressing FM/AM TUNING ▼ decreases the frequency.



From the remote control:

1. Press FM/AM to select the band (FM or AM).

The FM/AM lamp on the front panel button lights up. The last received station of the selected band is tuned in.

- Each time you press the button, the band alternates between FM and AM.

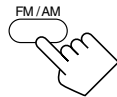

2. Press TUNING UP ► or TUNING DOWN ◀ until you find the frequency you want.

- Pressing TUNING UP ► increases the frequency.
- Pressing TUNING DOWN ◀ decreases the frequency.



Notes:

- When a station of sufficient signal strength is tuned in, the TUNED indicator lights up on the display.
- When an FM stereo program is received, the STEREO indicator also lights up.
- When you hold and then release the button in step 2, the frequency keeps changing until a station is tuned in.

Using Preset Tuning

Once a station is assigned to a channel number, the station can be quickly tuned in. You can preset up to 30 FM and 15 AM stations.

To store the preset stations

Before you start, remember...

There is a time limit in doing the following steps. If the setting is canceled before you finish, start from step 2 again.

On the front panel ONLY:

1. Tune in the station you want to preset (see "Tuning into Stations Manually" on the left).

- If you want to store the FM reception mode for this station, select the FM reception mode you want. See "Selecting the FM Reception Mode" on page 28.

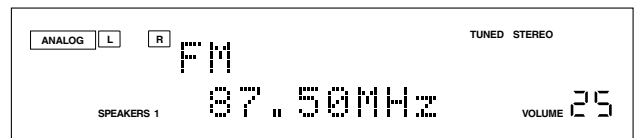

2. Press MEMORY.

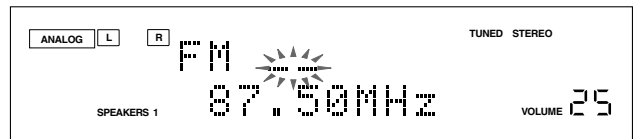

The channel number position starts flashing on the display for about 10 seconds.

3. Press FM/AM PRESET ▲ or ▼ to select a channel number while the channel number position is flashing.

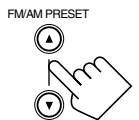

4. Press MEMORY again while the selected channel number is flashing on the display.

The selected channel number stops flashing.

The station is assigned to the selected channel number.

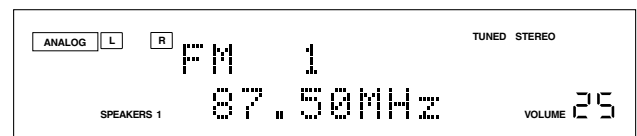

5. Repeat steps 1 to 4 until you store all the stations you want.

To erase a stored preset station

Storing a new station on a used number erases the previously stored one.

To tune in a preset station

On the front panel:

1. Press FM/AM to select the band (FM or AM).

The FM/AM lamp on the front panel button lights up. The last received station of the selected band is tuned in.

- Each time you press the button, the band alternates between FM and AM.

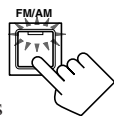

2. Press FM/AM PRESET ▲ or ▼ until you find the channel you want.

- Pressing FM/AM PRESET ▲ increases the number.
- Pressing FM/AM PRESET ▼ decreases the number.

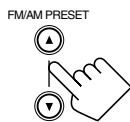

From the remote control:

1. Press FM/AM to select the band (FM or AM).

The FM/AM lamp on the front panel button lights up. The last received station of the selected band is tuned in.

- Each time you press the button, the band alternates between FM and AM.



2. Press the 10 keys to select a preset channel number.

- For channel number 5, press 5.
- For channel number 15, press +10 then 5.
- For channel number 20, press +10 then 10.
- For channel number 30, press +10, +10, then 10.

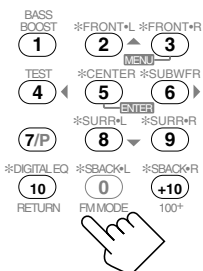

Note:

When you use the 10 keys on the remote control, be sure that they are activated for the tuner, not for the CD and others. (See page 51.)

Selecting the FM Reception Mode

When an FM stereo broadcast is hard to receive or noisy, you can change the FM reception mode while receiving an FM broadcast.

- You can store the FM reception mode for each preset station (see page 27).

While listening to an FM station, press FM MODE.

- Each time you press the button, the FM reception mode alternates between “FM AUTOMUTING” and “FM MODE MONO.”



On the front panel



From the remote control



FM AUTOMUTING: Normally select this.

When a program is broadcasted in stereo, you will hear stereo sound; when in monaural, you will hear monaural sounds. This mode is also useful to suppress static noise between stations. The AUTO MUTING indicator lights up on the display. (Initial setting)

FM MODE MONO: Select this to improve the reception (but stereo effect will be lost).

In this mode, you will hear noise while tuning into the stations. The AUTO MUTING indicator goes off from the display. (The STEREO indicator also goes off.)

Operating the Tuner Using the On-Screen Display

You can also operate the tuner using the on-screen display.

- The on-screen display will disappear if no operation is done for about 1 minute.

■ Operating the tuner

1. Press MENU.

The MENU screen appears on the TV.

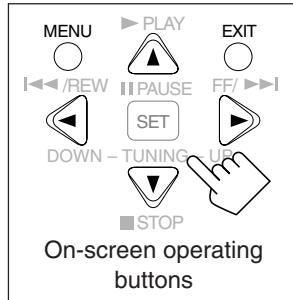
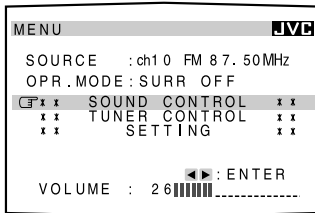

2. Press ▲ or ▼ to move to "TUNER CONTROL," then press ◀ or ▶.

The TUNER CONTROL menu appears.

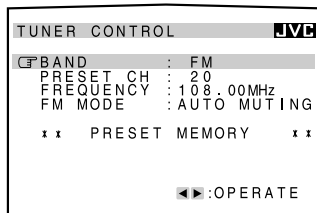

3. Press ▲ or ▼ to move to an item you want to set or adjust.

On the TUNER CONTROL menu, you can do the following:

BAND	: Select the band.
PRESET CH	: Select a preset channel station.
FREQUENCY	: Tune in a station manually.
FM MODE	: Select the FM reception mode.*
PRESET MEMORY	: See "Storing the preset stations" on the right.

Note:

* "FM MODE" is not displayed when an AM station is selected.

4. Press ◀ or ▶ to select an item you want to use.

5. When you finish, press EXIT repeatedly until the menu disappears from the TV.

■ Storing the preset stations

1. Press MENU.

The MENU screen appears on the TV.

2. Press ▲ or ▼ to move to "TUNER CONTROL," then press ◀ or ▶.

The TUNER CONTROL menu appears.

3. Tune into a station you want to store on the TUNER CONTROL menu, referring to "Operating the tuner".

4. Press ▲ or ▼ to move to "PRESET MEMORY," then press ◀ or ▶.

 moves to "PRESET CH" and the channel number starts flashing.

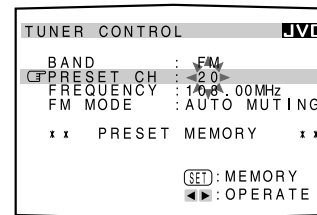

5. Press ◀ or ▶ to select a channel number you want.

6. Press SET to store the setting.

The selected channel number stops flashing.

7. Repeat steps 3 to 6 until you store all the stations you want.

8. When you finish, press EXIT repeatedly until the menu disappears from the TV.

Setting Sound

You can select the following sound settings to your preference according to your listening conditions or sources.

- Items shown in this section are the initial values when shipped from the factory.
- The on-screen display will disappear if no operation is done for about 1 minute.

Attenuating the Input Signal

When the input level of the analog source is too high, the sounds will be distorted. If this happens, you need to attenuate the input signal level to prevent the sound distortion.

- Once you have made adjustment, it is memorized for each source.

On the front panel:

Press and hold **INPUT ATT (INPUT ANALOG/DIGITAL)** so that the **INPUT ATT indicator lights up on the display.**

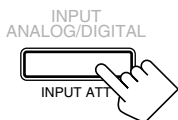

- Each time you press and hold the button, the input attenuator mode turns on (“ATT ON”) or off (“NORMAL”).

Using the on-screen display (through the remote control):

1. Press MENU.

The MENU screen appears on the TV.

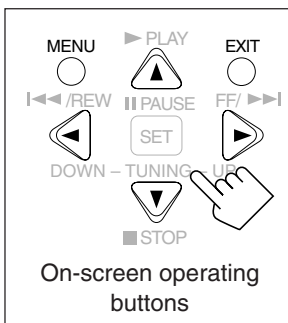
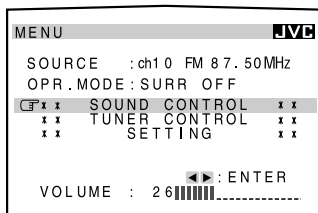

On-screen operating buttons

2. Press ▲ or ▼ to move **☞** to “SOUND CONTROL,” then press ◀ or ▶.

The SOUND CONTROL menu appears.

3. Press ▲ or ▼ to move **☞** to “INPUT ATT.”

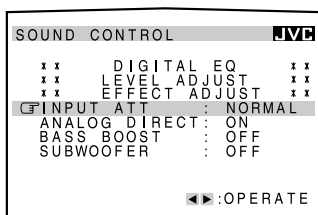

4. Press ◀ or ▶ to select “ATT ON” or “NORMAL.”

When “ATT ON” is selected, the INPUT ATT indicator lights up on the display.

5. When you finish, press EXIT repeatedly until the menu disappears from the TV.

Notes:

- This function is available when analog input terminals are in use.
- This function is not valid for the DVD MULTI playback mode.

Turning Analog Direct On and Off

You can enjoy the sound closer to the original source by overriding the sound adjustments such as speaker output level adjustments (see page 40), Equalization pattern (see page 39), Surround and DSP modes (see pages 32 to 36), Bass Boost (see page 31) and Midnight Mode (see page 24). You can only adjust the volume level while Analog Direct is in use.

- Once you have made adjustment, it is memorized for each source.

Press ANALOG DIRECT to turn on Analog Direct.

The ANALOG DIRECT lamp on the front panel button lights up.

- Each time you press the button, Analog Direct turns on and off.
 - When Analog Direct turns on, “A. DIRECT” appears on the display.



On the front panel



From the remote control

Using the on-screen display (through the remote control):

1. Press MENU.

The MENU screen appears on the TV.

2. Press ▲ or ▼ to move **☞** to “SOUND CONTROL,” then press ◀ or ▶.

The SOUND CONTROL menu appears.

3. Press ▲ or ▼ to move **☞** to “ANALOG DIRECT.”

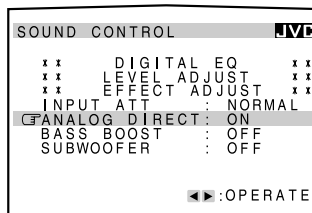

4. Press ◀ or ▶ to select “ON” or “OFF.”

When Analog Direct is turned on, the ANALOG DIRECT lamp on the front panel button lights up.

- When Analog Direct turns on, “A. DIRECT” appears on the display.

5. When you finish, press EXIT repeatedly until the menu disappears from the TV.

Notes:

- When digital input mode is in use, Analog Direct is not available.
- Turning on Surround or DSP mode cancels Analog Direct and previously selected sound adjustments are recalled.
- If Analog Direct is in use, Midnight Mode is temporarily canceled even though adjustable.

Reinforcing the Bass

You can boost the bass level.

- Once you have made adjustment, it is memorized for each source.

On the front panel:

Press BASS BOOST to turn on Bass Boost function.

The BASS BOOST lamp on the front panel button lights up.

- Each time you press the button, Bass Boost activates ("BOOST ON") and deactivates ("BOOST OFF") alternately.

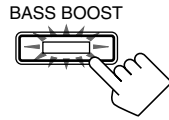

From the remote control:

1. Press SOUND.

The 10 keys are activated for sound adjustments.

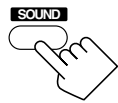

2. Press BASS BOOST to turn on Bass Boost function.

The BASS BOOST lamp on the front panel button lights up.

- Each time you press the button, Bass Boost activates ("BOOST ON") and deactivates ("BOOST OFF") alternately.



Using the on-screen display (through the remote control):

1. Press MENU.

The MENU screen appears on the TV.

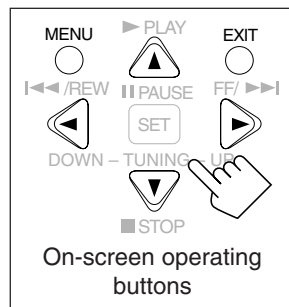
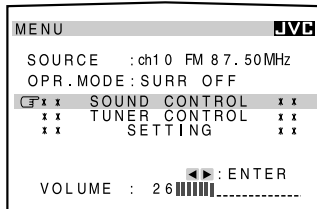

2. Press ▲ or ▼ to move to "SOUND CONTROL," then press ◀ or ▶.

The SOUND CONTROL menu appears.

3. Press ▲ or ▼ to move to "BASS BOOST."

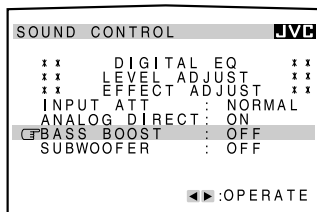

4. Press ◀ or ▶ to select "ON" or "OFF"

When Bass Boost is turned on, the BASS BOOST lamp on the front panel button lights up.

5. When you finish, press EXIT repeatedly until the menu disappears from the TV.

Notes:

- This function does not affect the sounds outputting from the surround speakers.
- When Analog Direct is in use (see page 30), the Bass Boost function is canceled temporarily.

Activating the Subwoofer Sound

You can cancel the subwoofer sound even though you have connected a subwoofer and have set "SUBWOOFER" to "YES" (see page 22). This is useful when enjoying surround sound at night.

On the front panel:

Press SUBWOOFER OUT ON/OFF to cancel the subwoofer sound output.

Each time you press the button, the subwoofer sound output is deactivated ("SUBWFR OFF") and activated ("SUBWFR ON") alternately.

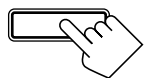

Using the on-screen display (through the remote control):

1. Press MENU.

The MENU screen appears on the TV.

2. Press ▲ or ▼ to move to "SOUND CONTROL," then press ◀ or ▶.

The SOUND CONTROL menu appears.

3. Press ▲ or ▼ to move to "SUBWOOFER."

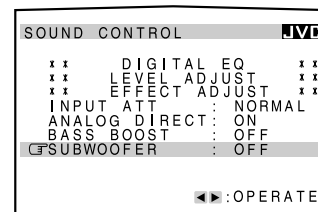

4. Press ◀ or ▶ to select "ON" or "OFF."

5. When you finish, press EXIT repeatedly until the menu disappears from the TV.

Notes:

- If you have selected "NO" for the subwoofer (see page 22), you cannot use this function.
- When you have selected "SMALL" for the front speakers, you cannot select "OFF" for the subwoofer even if it is set to "YES" (see page 22).

Using Surround Modes and DSP Modes

This unit activates a variety of Surround modes and DSP (Digital Signal Processor) modes. To use Surround and DSP modes properly, speakers required for creating each Surround and DSP modes should be activated.

Surround Modes

Reproducing Theater Ambience

In a movie theater, many speakers are located on the walls to reproduce impressive multi-surround sounds, reaching you from all directions.

With these many speakers, sound localization and sound movement can be expressed.

Surround modes built in this receiver can create almost the same surround sounds as you can feel in a real movie theater.

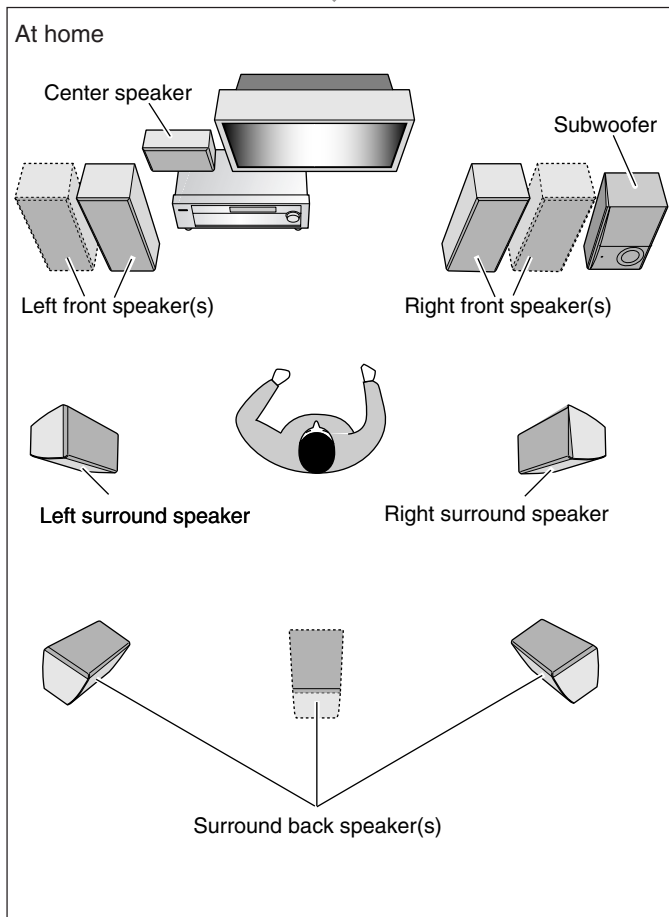
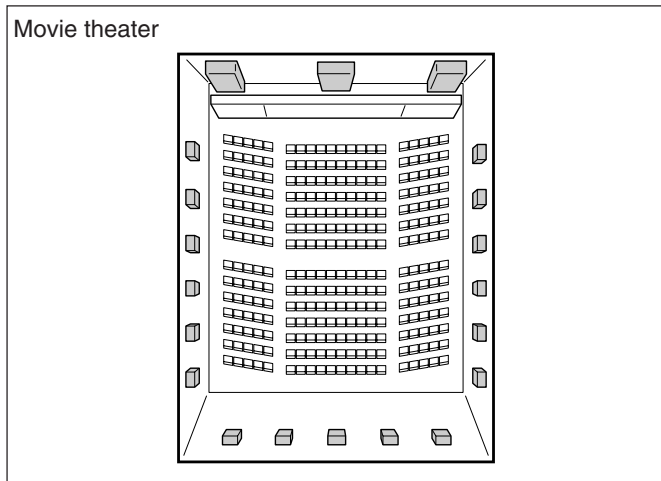

Introducing the Surround Modes

Dolby Surround

Dolby Digital EX*

Dolby Digital EX is newly introduced surround encoding format as an extension of multi-channel Dolby Digital, designed to add an extra surround channel to Dolby Digital 5.1-channel (see below). By using a matrix encoding/decoding method, additional “surround back” channel signal is encoded (and decoded) in both the left and right surround channel signals.

Compared to the conventional Dolby Digital 5.1-channel, this newly added surround back channel can reproduce more detailed movements behind you while viewing the video software. In addition, surround sound localization will become more stable, so that you can enjoy a realistic surround field in your listening room.

Best used to reproduce multi-channel movie sound tracks of the software encoded with Dolby Digital EX ().

- To enjoy the software encoded with Dolby Digital EX, connect the source component using the digital terminals on the rear of this receiver. (See page 13.)

Dolby Digital*

Used to reproduce multi-channel sound tracks of the software encoded with Dolby Digital ().

Dolby Digital 5.1-channel encoding method (so-called discrete 5.1-channel digital audio format) records and digitally compresses the left front channel, right front channel, center channel, left surround channel, right surround channel, and LFE channel signals (total 6 channels, but LFE channel is counted as 0.1 channel, therefore, called 5.1-channel).

Since each channel is completely independent from the other channel signals to avoid interference, you can obtain a much better sound quality with better stereo and surround effects.

- To enjoy the software encoded with Dolby Digital, connect the source component using the digital terminals on the rear of this receiver. (See page 13.)

* Dolby Digital software can be roughly grouped into two categories—multi-channel (up to 5.1-channel) and 2-channel software. To enjoy surround sounds while playing Dolby Digital 2-channel software, you can use Dolby Pro Logic II.

Dolby Pro Logic II*

Dolby Pro Logic II has a newly developed multi-channel playback format to convert all 2-channel software into 5-channel (plus subwoofer). Matrix-based conversion method for Dolby Pro Logic II makes no limitation for the cutoff frequency of the surround treble and enables stereo surround sound unavailable with conventional Dolby Pro Logic.

Dolby Pro Logic II can reproduce spacious sound from original sound without adding any new sounds and tonal colorations.

Dolby Pro Logic II has two modes—**Movie mode** and **Music mode**:

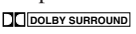
Pro Logic II Movie (PL II MOVIE)—suitable for the reproduction of Dolby Surround encoded sources bearing the mark  . You can enjoy a sound field very close to the one created with discrete 5.1-channel sounds.

Pro Logic II Music (PL II MUSIC)—suitable for the reproduction of any 2-channel stereo sources. You can enjoy wide and deep sound by using this mode. For this mode, you can make precise adjustments to match the sound to your taste.

- When Dolby Pro Logic II is activated, the  PRO LOGIC II indicator lights up on the display.

Dolby Surround (Dolby Pro Logic)*

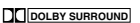
Used to reproduce sound tracks of the software encoded with Dolby Surround ().

Dolby Surround encoding format records the left front channel, right front channel, center channel, and surround channel signals (total 4 channels) into 2 channels.

The **Dolby Pro Logic** decoder built in this receiver decodes these 2-channel signals into original 4-channel signals—matrix-based multi-channel reproduction, and allows you to enjoy a realistic surround sound in your listening room.

- When Dolby Pro Logic is activated, the  PRO LOGIC indicator lights up on the display.

■ DTS Digital Surround

DTS-ES Extended Surround (DTS-ES)**

DTS-ES Extended Surround is another new digital surround encoding format, developed by Digital Theater Systems, Inc., that adds the third surround channel—surround back channel. (See “Dolby Digital EX.”)

DTS ES has two types—**DTS-ES Discrete 6.1** and **DTS-ES Matrix 6.1**:

DTS-ES Discrete 6.1—compatible with DTS-ES Extended Surround (DTS-ES), which has discrete 6.1-channel. You can play back the software encoded with DTS ES ().

DTS-ES Matrix 6.1—is designed to add an extra surround channel to DTS Digital Surround 5.1-channel. By using a matrix encoding/decoding method, additional “surround back” channel signal is encoded (and decoded) in both the left and right surround channel signals. You can playback the software encoded with DTS-ES ().

- To enjoy the software encoded with DTS-ES, connect the source component using the digital terminal on the rear of this receiver. (See page 13.)

Neo:6**

Neo:6 is a newly developed conversion method to create 6-channel (plus subwoofer) from all 2-channel software. Neo:6 has two modes—**Neo:6 Cinema** and **Neo:6 Music**:

Neo:6 Cinema—suitable for reproduction of matrix-based 2-channel software.

Neo:6 Music—suitable for reproduction of all 2-channel stereo music software.

DTS Digital Surround**

Used to reproduce multi-channel sound tracks of the software encoded with DTS Digital Surround ().

DTS Digital Surround is a discrete 5.1-channel digital audio format available on CD, LD, and DVD software.

Compared to Dolby Digital, DTS Digital Surround format has a lower audio compression ratio which enables it to add breadth and depth to the sounds reproduced. As such, DTS Digital Surround features natural, solid and clear sound.

- To enjoy the software encoded with DTS Digital Surround, connect the source component using the digital terminals on the rear of this receiver. (See page 13.)

When using Surround mode, the sounds come out of all the connected and activated speakers.

- **If only the front speakers are connected**, JVC’s original 3D-PHONIC processing (which has been developed to create the surround effect only through the front speakers) is used. The 3D-PHONIC indicator lights up on the display.

DVD MULTI Playback Mode

This receiver provides the DVD MULTI playback mode for reproducing the analog discrete 5.1-channel output mode of the DVD player.

You can adjust the sound reproduced by DVD MULTI playback mode while playing back video software such as a DVD using the analog discrete 5.1-channel output mode.

- For the connection and the details of the DVD MULTI playback mode, see page 37.

Note:

When you select “DVD MULTI” as the source to play, you cannot select any Surround and DSP modes.

* Manufactured under license from Dolby Laboratories. “Dolby,” “Pro Logic,” and the double-D symbol are trademarks of Dolby Laboratories.

** “DTS,” “DTS-ES Extended Surround” and “Neo:6” are trademarks of Digital Theater Systems, Inc.

Reproduced software and channels for each Surround mode

Surround mode	Dolby Digital EX	Dolby Digital 5.1-channel	Dolby Pro Logic II	Dolby Surround
Playback software	Dolby Digital EX	Dolby Digital 5.1-channel	Dolby Digital 2-channel 2-channel stereo software	Dolby Surround 2-channel stereo software
Reproduced channels	6.1-channel	5.1-channel	5-channel + (subwoofer)	4-channel + (subwoofer)

Surround mode	DTS-ES Discrete 6.1	DTS-ES Matrix 6.1	Neo:6 Cinema Neo:6 Music	DTS Digital Surround
Playback software	DTS-ES (with Discrete 6.1-channel signals)	DTS-ES (with Matrix 6.1-channel signals)	2-channel stereo software	DTS Digital Surround
Reproduced channels	6.1-channel	6.1-channel	6-channel + (subwoofer)	5.1-channel

■ DSP Modes

DAP (Digital Acoustic Processor) modes

The sound heard in a concert hall, club, etc. consists of direct sound and indirect sound—early reflections and reflections from behind. Direct sounds reach the listener directly without any reflection. On the other hand, indirect sounds are delayed by the distances of the ceiling and walls (see the diagram below). These indirect sounds are the most important elements of the acoustic surround effects. The DAP mode can reproduce a realistic sound field by adding these indirect sounds.

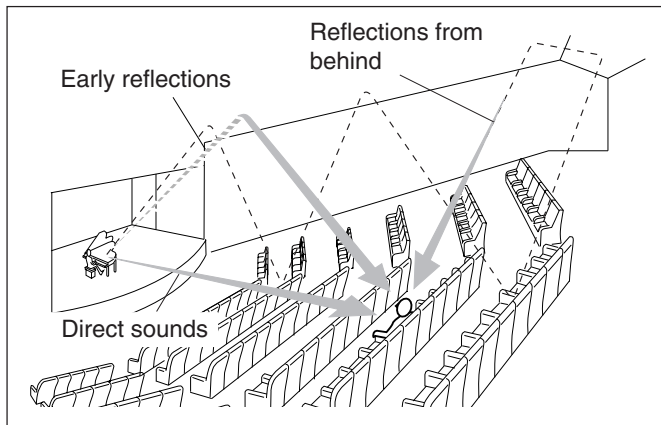

You can use the following DAP modes in order to reproduce a more acoustic sound field in your listening room.

HALL 1:	Gives clear vocal and the feeling of a large concert hall (where the seating capacity is about 1,000).
HALL 2:	Gives clear vocal and the feeling of a small concert hall (where the seating capacity is about 300).
LIVE CLUB:	Gives the feeling of a live music club with a low ceiling.
DANCE CLUB:	Gives a throbbing bass beat.
PAVILION:	Gives the spacious feeling of a pavilion with a high ceiling.

JVC Theater Surround

In order to reproduce a more realistic sound field in your listening room, you can use JVC Theater Surround.

THEATER 1:	Reproduces the sound field of a large theater (where the seating capacity is about 1,000).
THEATER 2:	Reproduces the sound field of a small theater (where the seating capacity is about 300).

When using DAP mode or JVC Theater Surround, the sounds come out of all the connected and activated speakers.

- **If only the front speakers are connected or the front and center speakers are connected, JVC's original 3D-PHONIC processing (which has been developed to create the surround effect only through the front speakers) is used.** The 3D-PHONIC indicator lights up on the display.

All Channel Stereo mode (ALL STEREO)

This mode can reproduce a larger stereo sound field using all the connected (and activated) speakers.

All Channel Stereo can be used when the front and surround speakers are connected to this receiver without respect to the center and/or surround back speakers connection.

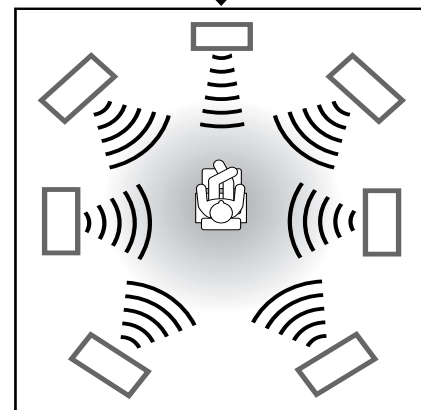
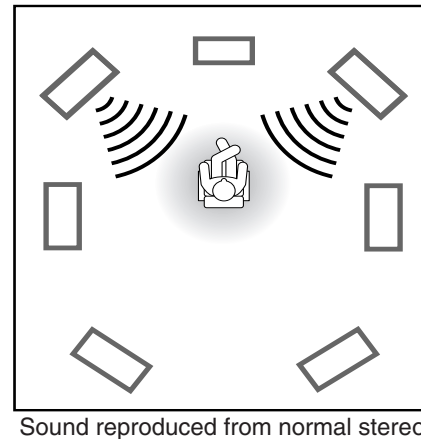

Sound reproduced from All Channel Stereo mode

3D HEADPHONE Mode



This receiver creates acoustic environment through the headphones as though using 5 speakers by signal processing algorithms—3D HEADPHONE mode. The processor combines all channels except LFE channel into two encoded channels. By turning off both the SPEAKERS ON/OFF 1 and SPEAKERS ON/OFF 2 then pressing DSP, 3D HEADPHONE mode is activated without respect to the type of software played back. You can enjoy more natural sound as though you are listening to directly through the conventional stereo headphones. The DSP and HEADPHONE indicators also light up.

Available Surround and DSP Modes According to the Speaker Layouts

Available Surround and DSP modes will vary depending on how many speakers are used with this receiver.

Make sure that you have set the speaker setting correctly (see page 22).

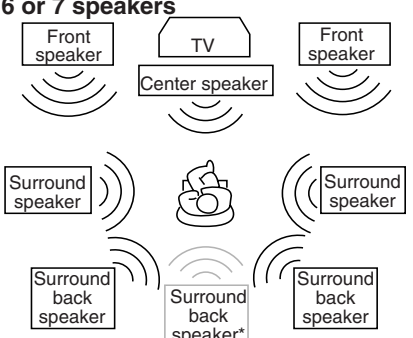
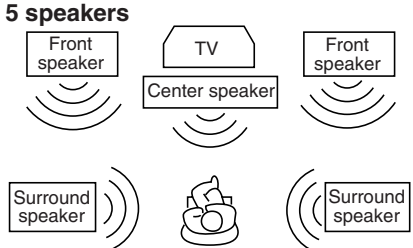
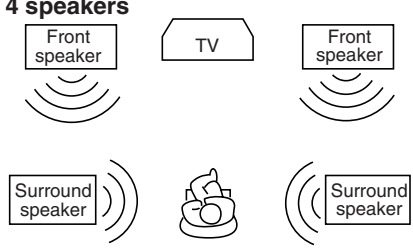
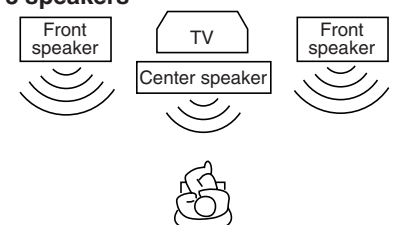
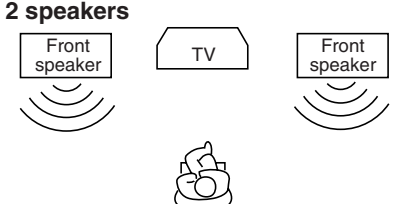
• To turn on and select Surround and DSP modes, see page 36.

Speaker layouts	Available Surround modes	Available DSP modes
<p>6 or 7 speakers</p>  <p>* When selecting "1SPK" for the surround back speaker setting (see page 22).</p>	<p>Dolby Digital EX software : DOLBY D EX*</p> <p>Dolby Digital 5.1-channel software : DOLBY D*</p> <p>: DOLBY D EX**</p> <p>DTS-ES software : ES DSCRETE*</p> <p>: ES MATRIX*</p> <p>DTS 5.1-channel software : DTS*</p> <p>: DTS NEO:6**</p> <p>2-channel software : PL II MOVIE, PL II MUSIC</p> <p>: PRO LOGIC, NEO:6CINMA</p> <p>: NEO:6MUSIC</p>	<p>THEATER 1</p> <p>THEATER 2</p> <p>HALL 1</p> <p>HALL 2</p> <p>LIVE CLUB</p> <p>DANCE CLUB</p> <p>PAVILION</p> <p>ALL STEREO</p>
<p>5 speakers</p> 	<p>Dolby Digital EX software : DOLBY D</p> <p>Dolby Digital 5.1-channel software : DOLBY D</p> <p>DTS-ES software : DTS</p> <p>DTS 5.1-channel software : DTS</p> <p>2-channel software : PL II MOVIE, PL II MUSIC</p> <p>: PRO LOGIC, NEO:6CINMA</p> <p>: NEO:6MUSIC</p>	<p>THEATER 1</p> <p>THEATER 2</p> <p>HALL 1</p> <p>HALL 2</p> <p>LIVE CLUB</p> <p>DANCE CLUB</p> <p>PAVILION</p> <p>ALL STEREO</p>
<p>4 speakers</p> 	<p>Dolby Digital EX software : DOLBY D</p> <p>Dolby Digital 5.1-channel software : DOLBY D</p> <p>DTS-ES software : DTS</p> <p>DTS 5.1-channel software : DTS</p> <p>2-channel software : PL II MOVIE, PL II MUSIC</p> <p>: PRO LOGIC, NEO:6CINMA</p> <p>: NEO:6MUSIC</p>	<p>THEATER 1</p> <p>THEATER 2</p> <p>HALL 1</p> <p>HALL 2</p> <p>LIVE CLUB</p> <p>DANCE CLUB</p> <p>PAVILION</p> <p>ALL STEREO</p>
<p>3 speakers</p> 	<p>Dolby Digital EX software : DOLBY D</p> <p>Dolby Digital 5.1-channel software : DOLBY D</p> <p>DTS-ES software : DTS</p> <p>DTS 5.1-channel software : DTS</p> <p>2-channel software : PL II MOVIE, PL II MUSIC</p> <p>: PRO LOGIC, NEO:6CINMA</p> <p>: NEO:6MUSIC</p>	<p>THEATER 1</p> <p>THEATER 2</p> <p>HALL 1</p> <p>HALL 2</p> <p>LIVE CLUB</p> <p>DANCE CLUB</p> <p>PAVILION</p>
<p>2 speakers</p> 	<p>Dolby Digital EX software : DOLBY D</p> <p>Dolby Digital 5.1-channel software : DOLBY D</p> <p>DTS-ES software : DTS</p> <p>DTS 5.1-channel software : DTS</p> <p>2-channel software : PL II MOVIE, PL II MUSIC</p>	<p>THEATER 1</p> <p>THEATER 2</p> <p>HALL 1</p> <p>HALL 2</p> <p>LIVE CLUB</p> <p>DANCE CLUB</p> <p>PAVILION</p>
		<p>3D H.PHONE</p>

Notes:

* You can select these modes by setting "EX/ES" to "AUTO" (initial setting) when the surround back speakers are set to "LARGE" or "SMALL" (see pages 22 and 23).

** You can select these modes by setting "EX/ES" to "ON" when the surround back speakers are set to "LARGE" or "SMALL" (see pages 22 and 23).

Activating the Surround Modes

Available Surround modes will vary depending on how many speakers are used with this receiver.

Make sure that you have set the speaker setting correctly (see page 22).

1. Set the analog or digital input mode for the source you like to use and start playing.

When playing back multi-channel digital software, select the digital input mode (see page 19).

2. Press SURROUND to activate Surround mode.

- The SURROUND lamp on the front panel button lights up.

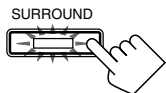

On the front panel



From the remote control

- When playing back multi-channel digital software, an appropriate Surround mode will be selected according to your setting. See "[2] Selecting Channel Numbers to Reproduce Multi-channel Digital Software" on page 23 for details. When selecting "AUTO" (initial setting) for "EX/ES" setting, Surround modes shown on page 35 are activated.

- If you are playing back any other software—analogue, Linear PCM, Dolby Digital 2-channel—the last selected Surround mode is activated. Each time you press the button, Surround mode changes as follow:

- More than 3 speakers*

PL II MOVIE → PL II MUSIC → PRO LOGIC →
NEO:6CINMA → NEO:6MUSIC → (Back to the beginning)

- 2 speakers*

PL II MOVIE ⇄ PL II MUSIC

* See also speaker layouts on page 35.

To cancel the Surround mode

Press SURROUND/DSP OFF on the front panel or SURR/DSP OFF on the remote control so that "SURR OFF" appears on the display. Surround and DSP modes are deactivated. The SURROUND lamp on the front panel button goes off.

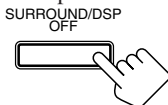

On the front panel

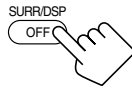

From the remote control

Available Surround and DSP modes for each input signal

Mode	Surround off (stereo)	Available Surround mode	DAP modes	JVC Theater Surround	All Channel Stereo	Headphone	3D headphone
Dolby Digital							
EX (6.1-channel)	<input type="radio"/>	Dolby D EX	<input type="radio"/>	<input type="radio"/>	<input type="radio"/>	<input type="radio"/>	<input type="radio"/>
(5.1-channel)	<input type="radio"/>	Dolby D, Dolby D EX*	<input type="radio"/>	<input type="radio"/>	<input type="radio"/>	<input type="radio"/>	<input type="radio"/>
(2-channel)	<input type="radio"/>	PL II MOVIE, PL II MUSIC, PRO LOGIC, NEO:6CINMA, NEO:6MUSIC	<input type="radio"/>	<input type="radio"/>	<input type="radio"/>	<input type="radio"/>	<input type="radio"/>
DTS Digital Surround							
ES Discrete (6.1-channel)	<input type="radio"/>	(DTS-) ES DISCRETE, DTS	<input type="radio"/>	<input type="radio"/>	<input type="radio"/>	<input type="radio"/>	<input type="radio"/>
ES Matrix (6.1-channel)	<input type="radio"/>	(DTS-) ES MATRIX, DTS	<input type="radio"/>	<input type="radio"/>	<input type="radio"/>	<input type="radio"/>	<input type="radio"/>
(5.1-channel)	<input type="radio"/>	DTS, DTS NEO:6*	<input type="radio"/>	<input type="radio"/>	<input type="radio"/>	<input type="radio"/>	<input type="radio"/>
Linear PCM	<input type="radio"/>	PL II MOVIE, PL II MUSIC, PRO LOGIC, NEO:6CINMA, NEO:6MUSIC	<input type="radio"/>	<input type="radio"/>	<input type="radio"/>	<input type="radio"/>	<input type="radio"/>
Analog	<input type="radio"/>	PL II MOVIE, PL II MUSIC, PRO LOGIC, NEO:6CINMA, NEO:6MUSIC	<input type="radio"/>	<input type="radio"/>	<input type="radio"/>	<input type="radio"/>	<input type="radio"/>

* You can select these modes by setting "EX/ES" to "ON" when the surround back speakers are set to "LARGE" or "SMALL" (see pages 22 and 23).

- If Surround mode is canceled while playing back multi-channel digital software, all channel signals are mixed and output through the front speakers (and subwoofer if you have connected a subwoofer and set its setting correctly—"YES").

You can also adjust digital equalization patterns, speaker output levels and some sound parameters. See "Adjusting Sound" on pages 38 to 42 for details.

Activating the DSP Modes

1. Select and play any sound source.

2. Press DSP to activate DSP mode.

The last selected DSP mode is activated.

- The DSP lamp on the front panel button lights up.

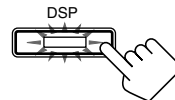

On the front panel

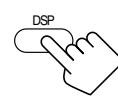

From the remote control

- Each time you press the button, DSP mode changes as follow:

THEATER 1 → THEATER 2 → HALL 1 → HALL 2 →
LIVE CLUB → DANCE CLUB → PAVILION →
ALL STEREO* → (Back to the beginning)

* "ALL STEREO" can be selected when the surround speakers are set to "LARGE" or "SMALL" (see page 22).

To cancel the DSP mode

Press SURROUND/DSP OFF on the front panel or SURR/DSP OFF on the remote control so that "SURR OFF" appears on the display. DSP and Surround modes are deactivated. The DSP lamp on the front panel button goes off.

You can also adjust digital equalization patterns, speaker output levels and some sound parameters. See "Adjusting Sound" on pages 38 to 42 for details.

Note:

If Analog Direct is turned on when using analog input mode (see pages 19 and 30), currently selected Surround and/or DSP mode is canceled temporarily.

Using the DVD MULTI Playback Mode

This receiver provides the DVD MULTI playback mode for reproducing the analog discrete output mode of the DVD player. Before playing back a DVD, refer also to the manual supplied with the DVD player.

When using DVD MULTI playback mode, connect the DVD player with its analog discrete output jacks (A – E).

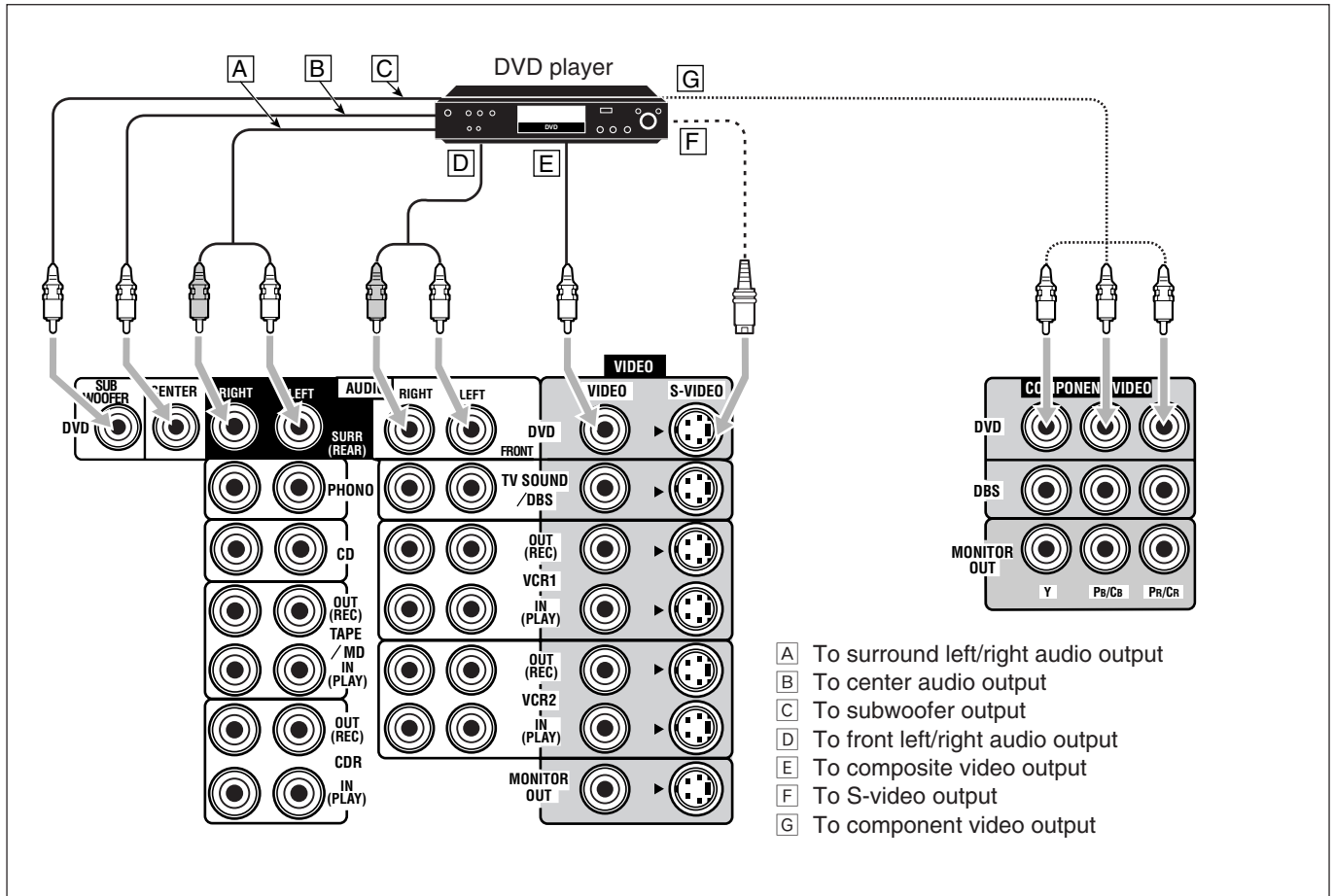

Activating the DVD MULTI Playback Mode

1. Press DVD MULTI so that “DVD MULTI” appears on the display.

The DVD MULTI lamp on the front panel button and the DVD MULTI indicator light up.



On the front panel



From the remote control

Note:

When you select “DVD MULTI” as the source to play, the Surround and DSP modes are canceled, and the SURROUND and DSP buttons do not work.

2. Select the analog discrete output mode on the DVD player, and start playing a DVD.

- Refer also to the manual supplied with the DVD player.

You can also adjust digital equalization patterns and speaker output levels. See “Adjusting Sound” on pages 38 to 41 for details.

- Test tone does not output through the speakers to adjust the speakers output levels when selecting DVD MULTI.

Notes:

- Midnight Mode is not available for DVD MULTI playback mode (see page 24).
- When using a pair of headphones, the sounds of front left and right channels are output from the headphones.

Adjusting Sound

You can adjust sound parameters to your preference after completing basic setting.

- When performing the sound adjustments, it is recommended to use the TV screen so that you can show the on-screen display on the TV.
- When using the buttons on the front panel or remote control without using the on-screen display, you can perform the same adjustments. (The on-screen display cannot be shown.)
- The on-screen display will disappear if no operation is done for about 1 minute.

Basic Procedure

You can also adjust the sound without showing menus on the TV. For details, see each explanation that follows.

Using the on-screen display (through the remote control):

1. Press MENU.

The MENU screen appears on the TV.

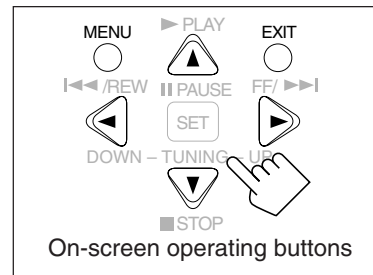
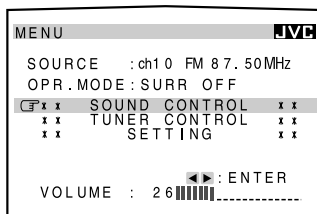

2. Press ▲ or ▼ to move to "SOUND CONTROL," then press ◀ or ▶.

The SOUND CONTROL menu appears.

3. Press ▲ or ▼ to move to select "DIGITAL EQ (Equalization)," "LEVEL ADJUST" or "EFFECT ADJUST," then press ◀ or ▶.

4. Press ▲ or ▼ to move to an item you want to set.

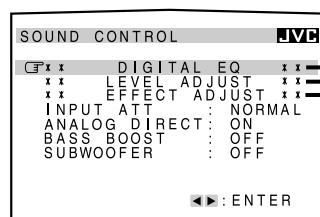

SOUND CONTROL menu

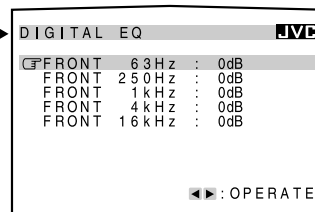

DIGITAL EQ (Equalization) menu (see page 39)

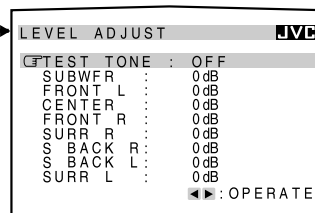

LEVEL ADJUST menu (see page 40)

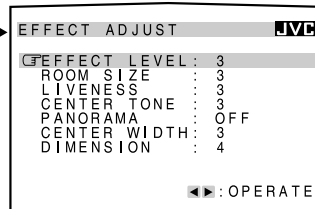

EFFECT ADJUST menu (see page 42)

5. Press ◀ or ▶ to adjust a sound parameter.

6. When you finish, press EXIT repeatedly until the menu disappears from the TV.

- If Analog Direct is in use, you cannot make any sound adjustments.
- Above items shown on the on-screen display are initial values when shipped from the factory.
- Some of the items cannot be shown or cannot be adjusted. (For details, see the respective explanation in this section.)

Adjusting the Equalization Patterns —DIGITAL EQ

You can adjust the equalization patterns to your preference.
• Once you have made adjustment, it is memorized for each source.

Using the on-screen display (through the remote control):

1. Show DIGITAL EQ (Equalization) menu (see page 38).

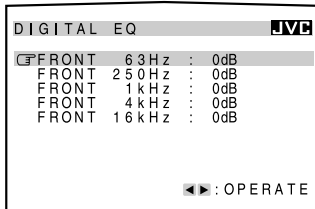

2. Press ▲ or ▼ to move  to the frequency you want to adjust.
3. Press ◀ or ▶ to adjust the frequency level you want.
The DIGITAL EQ indicator lights up on the display.
• The frequency level changes from -8 dB to +8 dB in 2 dB steps.
4. Repeat steps 2 and 3 to adjust the other frequency levels.
5. When you finish, press EXIT repeatedly until the menu disappears from the TV.

To flat the equalization pattern,
set all the frequency levels to “0dB” in step 3. The DIGITAL EQ indicator goes off from the display.

On the front panel:

Before you start, remember...

There is a time limit in doing the following steps. If the setting is canceled before you finish, start from step 1 again.

1. Press DIGITAL EQ (Equalization) repeatedly to select the frequency you want to adjust.



- Each time you press the button, the frequency with its current level changes as follows:

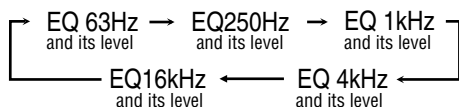

- “0dB” is the initial setting for each frequency.

2. Press CONTROL UP ▲ or DOWN ▼ repeatedly to adjust the frequency level.

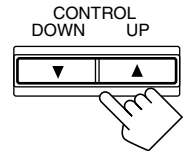

The DIGITAL EQ indicator lights up on the display.

- The frequency level changes from -8 dB to +8 dB in 2 dB steps.

3. Repeat steps 1 and 2 to adjust the other frequency levels.

To flat the equalization pattern,
set all the frequency levels to “0dB” in step 2. The DIGITAL EQ indicator goes off from the display.

From the remote control:

Before you start, remember...

There is a time limit in doing the following steps. If the setting is canceled before you finish, start from step 2 again.

1. Press SOUND.

“SOUND” appears on the remote control display window.



- The 10 keys are activated for sound adjustments.

2. Press DIGITAL EQ (Equalization) repeatedly to select the frequency you want to adjust.



“EQ” appears on the remote control display window.

- Each time you press the button, the frequency with its current level changes as follows:



- “0dB” is the initial setting for each frequency.

3. Press LEVEL + or - repeatedly to adjust the frequency level.

The DIGITAL EQ indicator lights up on the display.

- The frequency level changes from -8 dB to +8 dB in 2 dB steps.



4. Repeat steps 2 and 3 to adjust the other frequency levels.

To flat the equalization pattern,
set all the frequency levels to “0dB” in step 3. The DIGITAL EQ indicator goes off from the display.

Notes:

- When Analog Direct is in use, the digital equalization patterns cannot be adjusted.
- The digital equalization patterns affect the front speaker sounds only.

Adjusting the Speaker Output Levels —LEVEL ADJUST

You can adjust the speaker output levels. The test tone can be also output from each speaker except subwoofer to check the output level balance when using the Surround mode.

- Once you have made adjustment, it is memorized for each source.
- When using the buttons on the front panel to adjust output level for the Surround mode, no test tone is available.

■ Adjustable speakers

You can adjust the following speakers' output levels within the range of **-10 dB** to **+10 dB** ("**0 dB**" is the initial setting):

SUBWFR	: Select this to adjust the subwoofer output level.
FRONT L (FRNT L)	: Select this to adjust the left front speaker output level.
CENTER	: Select this to adjust the center speaker output level.
FRONT R (FRNT R)	: Select this to adjust the right front speaker output level.
SURR R	: Select this to adjust the right surround speaker output level.
S BACK R (SBK R) *	: Select this to adjust the right surround back speaker output level.
S BACK L (SBK L) or S BACK *	: Select this to adjust the left surround back speaker output level.
SURR L	: Select this to adjust the left surround speaker output level.

Notes:

- * If you have selected "1SPK" for the surround back speaker (see page 22), "S BACK" appears instead of "S BACK (SBK) L" and "S BACK (SBK) R." No test tone outputs from the right surround back speaker.
- If you have selected "NO" or "NONE" for a speaker (see page 22), the output level for the corresponding speaker cannot be adjustable.
- The center and left and right surround speakers' output levels are adjustable for DVD MULTI playback mode, even though "NONE" is selected for the speaker settings.
- Speaker output levels except that of the subwoofer are not adjustable when Analog Direct is in use.

Using the on-screen display (through the remote control):

Adjustment is also possible without outputting the test tone. In this case, you can skip steps 2, 3 and 7 below.

1. Show LEVEL ADJUST menu (see page 38).

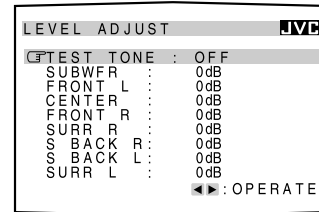

2. Press ▲ or ▼ to move **⏏** to "TEST TONE."

3. Press ◀ or ▶ to select "ON" to check if you can hear the sounds through all the speakers at equal level.

A test tone comes out of the speakers (only if the speakers are activated) in the following order:

FRONT L (Left front speaker) → CENTER (Center speaker) →
 FRONT R (Right front speaker) →
 SURR R (Right surround speaker) →
 S BACK R (Right surround back speaker)* →
 S BACK L (Left surround back speaker) or
 S BACK (Surround back speaker)* →
 SURR L (Left surround speaker) → (Back to the beginning)

* If you have selected "1SPK" for the surround back speaker (see page 22), "S BACK" appears instead of "S BACK L" and "S BACK R." No test tone outputs from the right surround back speaker.

4. Press ▲ or ▼ to move **⏏** to a speaker you want to adjust.
5. Press ◀ or ▶ to adjust the speaker output level (-10 dB to +10 dB).
6. Repeat steps 4 and 5 to adjust the other speakers output levels.
7. After the adjustment is finished, press ▲ or ▼ to move **⏏** to "TEST TONE," then select "OFF."
8. When you finish, press EXIT repeatedly until the menu disappears from the TV.

Notes:

- If you have selected "NO" or "NONE" for a speaker (see page 22), test tone does not come out of the corresponding speaker.
- Subwoofer output level cannot be adjusted when outputting test tone. When you adjust the subwoofer output level, select "OFF" for "TEST TONE."
- Test tone does not output through the speakers when selecting DVD MULTI.

From the remote control:

Before you start, remember...

There is a time limit in doing the following steps. If the setting is canceled before you finish, start from step 2 again.

Adjustment is also possible without outputting the test tone. In this case, you can skip steps 2 and 6 below.

1. Press SOUND.

"SOUND" appears on the remote control display window.

- The 10 keys are activated for sound adjustments.

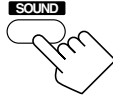

2. Press TEST to check if you can hear the sounds through all the speakers at equal level.

A test tone comes out of the speakers (only if the speakers are activated) in the following order:

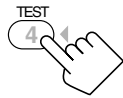

FRNT L (Left front speaker) → CENTER (Center speaker) →
FRNT R (Right front speaker) →
SURR R (Right surround speaker) →
SBK R (Right surround back speaker)* →
SBK L (Left surround back speaker) or
S BACK (surround back speaker)* →
SURR L (Left surround speaker) → (Back to the beginning)

* If you have selected "1SPK" for the surround back speaker (see page 22), "S BACK" appears instead of "SBK L" and "SBK R." No test tone outputs from the right surround back speaker.

3. Select a speaker you want to adjust.

The selected speaker name appears on the remote control display window for a while.

- To select the left front speaker, press FRONT•L. "FRL" appears on the remote control display window.
- To select the center speaker, press CENTER. "CTR" appears on the remote control display window.
- To select the right front speaker, press FRONT•R. "FRR" appears on the remote control display window.
- To select the right surround speaker, press SURR•R. "SURRR" appears on the remote control display window.
- To select the right surround back speaker, press SBACK•R. "SBKR" appears on the remote control display window.
- To select the left surround back speaker, press SBACK•L. "SBKL" appears on the remote control display window.
- To select the left surround speaker, press SURR•L. "SURRL" appears on the remote control display window.

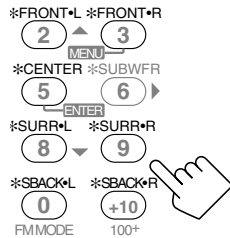

Note:

If you have selected "1SPK" for the surround back speaker (see page 22), press SBACK•L to adjust the surround back speaker output level.

4. Press LEVEL + or - to adjust the speaker output level (-10 dB to +10 dB).



5. Press SOUND again then repeat steps 3 and 4 to adjust the other speakers output levels.

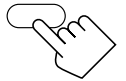

6. Press TEST again to stop the test tone.



Notes:

- If you have selected "NO" or "NONE" for a speaker (see page 22), test tone does not come out of the corresponding speaker.
- Subwoofer output level cannot be adjusted when outputting test tone. When you adjust the subwoofer output level, press SOUND, SUBWFR then LEVEL + or - to adjust the speaker output level (-10 dB to +10 dB). ("S-WFR" appears on the remote control display window.) It is recommended to make adjustments while listening to the sound of the source played back.
- Test tone does not output through the speakers when selecting DVD MULTI.



On the front panel:

You can also use the buttons on the front panel to adjust the speaker output levels. However, no test tone is available when using the buttons on the front panel. So make adjustments while listening to the sound of the source played back.

Before you start, remember...

There is a time limit in doing the following steps. If the setting is canceled before you finish, start from step 1 again.

1. Press LEVEL ADJUST repeatedly to select a speaker you want to adjust.

- Each time you press the button, the items change as follows.



SUBWFR (Subwoofer) → FRNT L (Left front speaker) →
CENTER (Center speaker) → FRNT R (Right front speaker) →
SURR R (Right surround speaker) →
SBK R (Right surround back speaker)* →
SBK L (Left surround back speaker) or
S BACK (surround back speaker)* →
SURR L (Left surround speaker) → (Back to the beginning)

* If you have selected "1SPK" for the surround back speaker (see page 22), "S BACK" appears instead of "SBK L" and "SBK R."

2. Press CONTROL UP ▲ or DOWN ▼ to adjust the speaker output level (-10 dB to +10 dB).

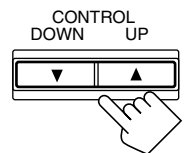

3. Repeat steps 1 and 2 to adjust the other speakers output levels.

Adjusting the Sound Parameters for the Surround and DSP Modes—EFFECT ADJUST

You can adjust the Surround and DSP sound parameters to your preference.

- Once you have made adjustment, it is memorized for each source.

Adjustable parameters

You can adjust the following parameters:

For Surround, DAP, JVC Theater Surround and All Channel Stereo modes (when the center speaker is connected)

CENTER TONE (CTR TONE) : Adjust the center tone. As the number increases, the dialogue becomes clearer so that the human voices change from soft to sharp. (Normally select “3.” Adjustable range: 1 to 5)

For DAP modes and JVC Theater Surround

EFFECT LEVEL (EFFECT) : Adjust the DAP effect level. As the number increases, the DAP effect becomes stronger. (Normally select “3.” Adjustable range: 1 to 5)

ROOM SIZE (ROOMSIZE) : Adjust the virtual room size. As the number increases, the interval between reflections increases so that you will feel as if you were in a larger room. (Normally select “3.” Adjustable range: 1 to 5)

LIVENESS : Adjust the liveness effect. As the number increases, the attenuation level of reflections over time decreases so that acoustics change from “Dead” to “Live.” (Normally select “3.” Adjustable range: 1 to 5)

Note:

You can only adjust the Effect Level when using a DAP mode with the 3D-PHONIC indicator lights up.

For Pro Logic II Music only

PANORAMA (PNRAMA) control : Select “ON” to add “wraparound” sound effect with side-wall image. (Initial setting: “OFF”)

CENTER WIDTH (CWIDTH) : Adjust the center channel localization between the center speaker and the left/right speakers. As the number increases, the center channel sound moves toward the left and right speakers. (Normally select “3.” Adjustable range: OFF and 1 to 7)

DIMENSION : Adjust sound localization position. As the number increases, the sound localization moves towards forward from backward. (Normally select “4.” Adjustable range: 1 to 7)

Note:

Parameters that are not adjustable for the currently selected Surround and DSP modes are skipped.

Using the on-screen display (through the remote control):

- Show EFFECT ADJUST menu (see page 38).

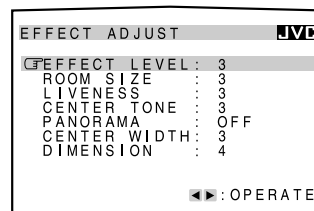

Parameters that are not adjustable for the currently selected Surround and DSP modes are skipped.

- Press ▲ or ▼ to move  to a parameter you want to adjust.
- Press ◀ or ▶ to adjust the parameter.
- Repeat steps 2 and 3 to adjust the other parameters.
- When you finish, press EXIT repeatedly until the menu disappears from the TV.

On the front panel:

Before you start, remember...

There is a time limit in doing the following steps. If the setting is canceled before you finish, start from step 1 again.

- Press EFFECT repeatedly to select a parameter you want to adjust.

- Each time you press the button, the items change as follows:



EFFECT → ROOMSIZE → LIVENESS →
CTR (center) TONE → PNRAMA (Panorama) →
C (center) WIDTH → DIMENSION →
(Back to the beginning)

Parameters that are not adjustable for the currently selected Surround and DSP modes are skipped.

- Press CONTROL UP ▲ or CONTROL DOWN ▼ to adjust the sound parameter.

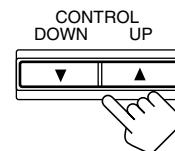

- Repeat steps 1 and 2 to adjust the other parameters.

COMPU LINK Remote Control System

The COMPU LINK remote control system allows you to operate JVC's audio components through the remote sensor on the receiver.

To use this remote control system, you need to connect JVC's audio components through the COMPU LINK-4 (SYNCHRO) jacks (see below) in addition to the connections using cables with RCA pin plugs (see pages 8 and 9).

- Make sure that the AC power cords of these components are unplugged before connection. Plug the AC power cords only after all connections are complete.

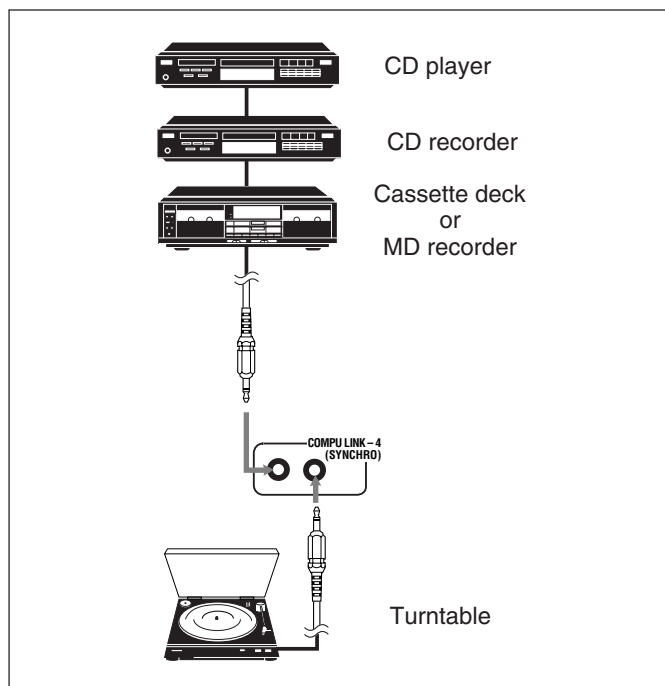

Notes:

- There are four versions of COMPU LINK remote control system. This receiver is equipped with the fourth version—COMPU LINK-4. This version is added systematic operations with the CD recorder to the previous version—COMPU LINK-3.
- If your audio component has two COMPU LINK jacks, you can use either one. If it has only one COMPU LINK jack, connect it so that it is the last item in the series of components. (For example, the turntable or CD player in the diagram above.)
- To operate a cassette deck or MD recorder using the COMPU LINK remote control system, set the source name correctly. (See page 17.)
- Refer also to the manuals supplied with your audio components.

This remote control system allows you to use four functions listed below.

Remote Control through the Remote Sensor on the Receiver

You can control the connected audio components through the remote sensor on the receiver using this remote control. Aim the remote control directly at the remote sensor on the receiver. For details, see pages 51 and 52.

Automatic Source Selection

When you press the play (▶) button on a connected component or on its own remote control, the receiver automatically turns on and changes the source to the component. On the other hand, if you select a new source on the receiver or on the remote control, the selected component begins playing immediately. In both cases, the previously selected source continues playing without sound for a few seconds.

Automatic Power On/Off (Standby): only possible with the COMPU LINK-3 and COMPU LINK-4

The connected components turn on and off (standby) along with the receiver.

When you turn on the receiver, one of the connected components will turn on automatically, depending on which component has been previously selected.

When you turn off the receiver, the connected components will turn off (standby).

Synchronized Recording

Synchronized recording means the cassette deck (or MD recorder) starts recording as soon as a CD begins playing.

To use synchronized recording, follow these steps:

1. Put a tape in the cassette deck (or an MD in the MD recorder), and a disc in the CD player.
2. Press the record (●) button and the pause (II) button on the cassette deck (or MD recorder) at the same time.

This puts the cassette deck (or MD recorder) into recording pause.

If you do not press the record (●) button and pause (II) button at the same time, the synchronized recording feature will not operate.

3. Press the play (▶) button on the CD player.

The source changes on the receiver, and as soon as play starts, the cassette deck (or MD recorder) starts recording. When the play ends, the cassette deck (or MD recorder) enters recording pause, and stops about 4 seconds later.

Notes:

- During synchronized recording, the selected source cannot be changed.
- If the power of any component is shut off during synchronized recording, the COMPU LINK remote control system may not operate properly. In this case, you must start again from the beginning.

TEXT COMPU LINK Remote Control System

The TEXT COMPU LINK remote control system has been developed to deal with the disc information recorded in the CD Text* and MDs. Using these information in the discs, you can operate a CD player or MD recorder equipped with the TEXT COMPU LINK remote control system through the receiver.

Connections:

To use this remote control system, you need to connect a CD player and/or MD recorder you want to operate, following the procedures below.

1. If you have already plugged your CD player, MD recorder, and this receiver into the AC outlets, unplug their AC power cords first.

2. Connect your CD player, MD recorder, and this receiver as follows, through the COMPU LINK jacks and TEXT COMPU LINK jacks.

- 1) **COMPU LINK jacks:** Use the cables with the monaural mini-plugs (not supplied with this receiver).

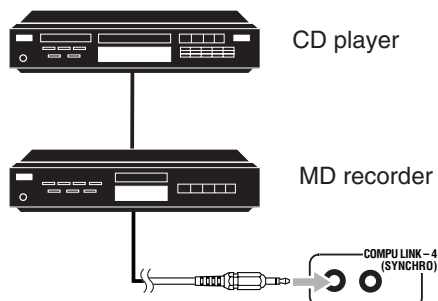

- 2) **TEXT COMPU LINK jacks:** Use the cables with the stereo mini-plugs (not supplied with this receiver).

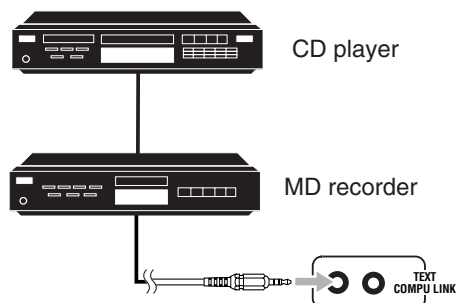

3. Connect your CD player, MD recorder, and this receiver, using the cables with RCA pin plugs (see page 9).

4. Plug the AC power cords of these components into the AC outlets.

5. Turn on the connected components first, then turn on this receiver.

Functions:

This remote control system allows you to use the functions listed below.

Showing the Disc Information on the TV screen

Disc information such as its performer and disc title (and track titles only when a CD Text is selected) is shown on the TV screen.

Searching for a Disc: Only for the CD Player

This remote control system can allow you to search for discs by the performer, disc title, and music genre.

With this disc search, you can easily find the disc you want to play.

Entering the Disc Information

If your CD player or MD recorder has the disc memory function, you can input the following information about the normal audio CDs or MDs on the TV screen.

- For CDs: Performer, disc title, and music genre
- For MDs: Disc title and song titles

* What is a CD Text?

In a CD Text, some information about the disc (its disc title, performer, composer, arranger, etc.) is recorded.

Notes:

- If your audio component has two COMPU LINK jacks, you can use either one. If it has only one COMPU LINK jack, connect it so that it is the last item in the series of components. (For example, the CD player in the diagram in the left column.)
- If your audio component has two TEXT COMPU LINK jacks, you can use either one. If it has only one TEXT COMPU LINK jack, connect it so that it is the last item in the series of components. (For example, the CD player in the diagram in the left column.)
- "TEXT COMPULINK SOURCE NOT CONNECTED" appears on the display in the following cases:
 - When the connections explained in the left column are not correctly done.
 - When you try to use the TEXT COMPU LINK function a few seconds after you turn on the connected equipment. This is not a malfunction of the units.
- Refer also to the manuals supplied with your CD player or MD recorder.

IMPORTANT:

If you turn on the receiver before turning on the other components after connecting the components, the TEXT COMPU LINK remote control system does not work correctly.

If this happens:

1. Turn off all the components including this receiver.
2. Turn on the connected components.
3. Turn on this receiver.

Operations:

To use this remote control system, you need to connect the TV to the MONITOR OUT jack on the rear panel (see page 11), and set the TV's input mode to the proper position to which the receiver is connected. **Make sure you have connected a CD player or MD recorder equipped with the TEXT COMPU LINK remote control system. If not, you cannot use the following functions.**

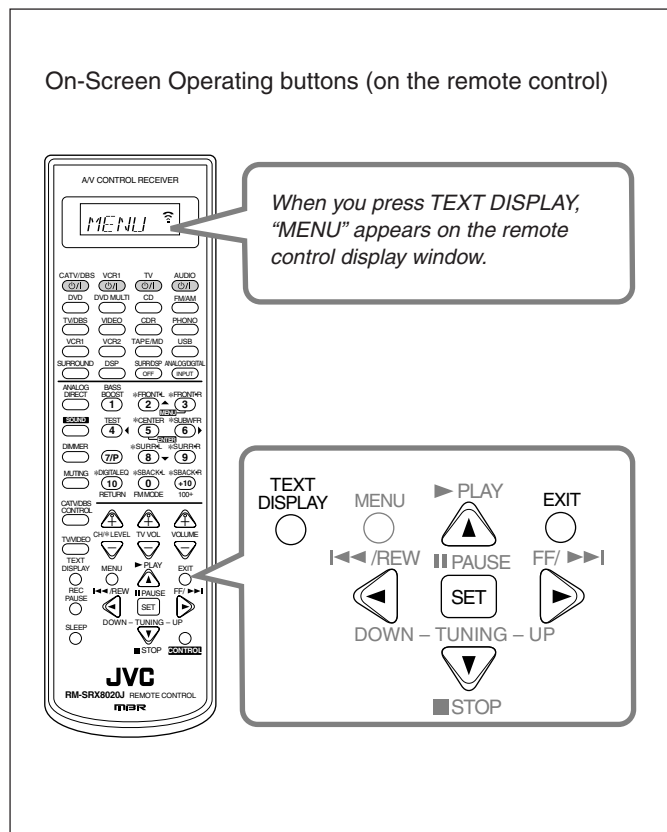

- ① Source name: CD or MD
- ② Select or , then press SET to change the disc.
- ③ Track numbers and track titles.
 - When you move to a track number, you can change the track information by pressing or . Each time you press the button, track information alternates between its track title and its performer. (You can also start playing the track by pressing SET.)
- ④ Select this (move in front), then press SET to go to the DISC SEARCH screen (see page 46).
- ⑤ Select this (move in front), then press SET to go to the TITLE INPUT screen (see page 47).
- ⑥ This appears only when a CD Text is selected.
- ⑦ Disc information such as the disc title, performer, and music genre.

When this is selected (in front), you can change the disc information by pressing or . Each time you press the button, disc information (see "Note on ⑦") changes.
- ⑧ Select or , then press SET to change the track.
- ⑨ Usable buttons and their functions for the current selection.

Indication here will be changed according to what is currently selected (in front) on the screen. See "Note on ⑨."

Note on ⑦:

The following information will appear on the display:

- For CD Texts—Disc title, Performer, Genre, Song writer, Composer, Arranger, Message
Only recorded information will be shown. If there is no data, "NO DATA" will appear.
- For MDs—Disc title
If there is no data, "NO DATA" will appear.

Note on ⑨:

For example, SET button will be used to start play (PLAY), to go to the next screen (ENTER), and to determine the selection (ENTER).

Showing the Disc Information on the TV Screen

Press TEXT DISPLAY while "CD" or "MD" is selected as the source.

The Disc Information screen appears on the TV.

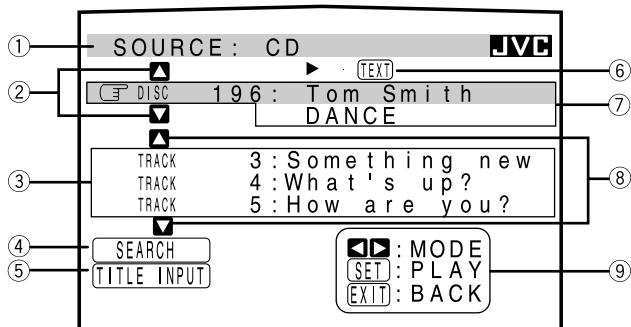

To exit from the Disc information screen

Press EXIT.

Notes:

- The on-screen display will disappear in the following cases:
 - if no operation is done for about 10 minutes.
 - if you do any operation other than explained in this section.
- To control an MD recorder using the TEXT COMPU LINK remote control system, you have to change the source name shown on the display from "TAPE" to "MD." (See page 17.)
- Some special characters and marks cannot be displayed correctly.

■ Searching for a Disc (Only for the CD player)

Search for a disc by its performer:

1. Press TEXT DISPLAY while “CD” is selected as the source.

The Disc Information screen appears on the TV.

2. Press ▲ or ▼ to move \leftarrow to “SEARCH,” then press SET.

The DISC SEARCH screen appears.

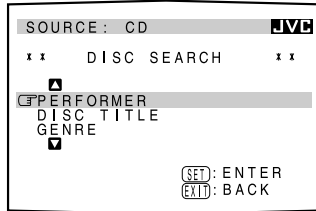

3. Press ▲ or ▼ to move \leftarrow to “PERFORMER,” then press SET.

The PERFORMER SEARCH screen appears.

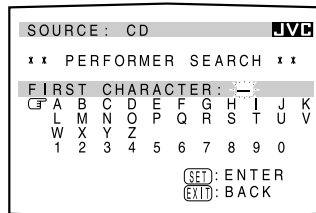

4. Press ▲ / ▼ / ◀ / ▶ to move \leftarrow in front of the first character of the performer you want to search for, then press SET.

To correct the incorrect entry, press ▲ / ▼ / ◀ / ▶ to move \leftarrow in front of the correct character, then press SET.

Note:

Symbols such as @, # or \$ are not be available for search.

5. Press SET again.

Disc search starts, then the SEARCH RESULT screen showing the performers appears.

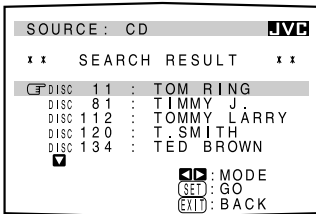

6. On the SEARCH RESULT screen, you can do the following:

- **Changing the indication of the disc information:** Press ▲ or ▼ to move \leftarrow to a searched-for disc, then press ◀ or ▶. Each time you press ◀ or ▶, the disc information alternates between its performer and its disc title.
- **Starting a disc play and going to the Disc Information screen (see page 45):** Press ▲ or ▼ to move \leftarrow to a searched-for disc, then press SET.
- **Showing unseen disc information (if more than 5 discs are listed as a result of the search):** Press ▲ or ▼ until they appear.
- **Going back to the PERFORMER SEARCH screen:** Press EXIT.

Search for a disc by its disc title:

1. Press TEXT DISPLAY while “CD” is selected as the source.

The Disc Information screen appears on the TV.

2. Press ▲ or ▼ to move \leftarrow to “SEARCH,” then press SET.

The DISC SEARCH screen appears.

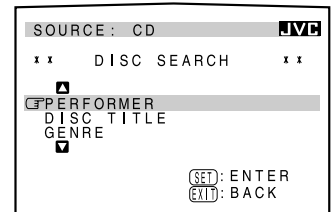

3. Press ▲ or ▼ to move \leftarrow to “DISC TITLE,” then press SET.

The DISC TITLE SEARCH screen appears.

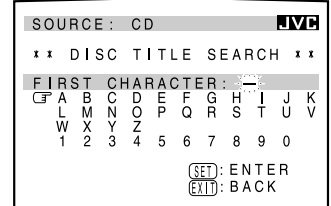

4. Press ▲ / ▼ / ◀ / ▶ to move \leftarrow in front of the first character of the disc title you want to search for, then press SET.

To correct the incorrect entry, press ▲ / ▼ / ◀ / ▶ to move \leftarrow in front of the correct character, then press SET.

Note:

Symbols such as @, # or \$ are not be available for search.

5. Press SET again.

Disc search starts, then the SEARCH RESULT screen showing the disc titles appears.

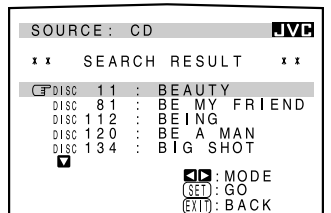

6. On the SEARCH RESULT screen, you can do the following:

- **Changing the indication of the disc information:** Press ▲ or ▼ to move \leftarrow to a searched-for disc, then press ◀ or ▶. Each time you press ◀ or ▶, the disc information alternates between its performer and its disc title.
- **Starting a disc play and going to the Disc Information screen (see page 45):** Press ▲ or ▼ to move \leftarrow to a searched-for disc, then press SET.
- **Showing unseen disc information (if more than 5 discs are listed as a result of the search):** Press ▲ or ▼ until they appear.
- **Going back to the DISC TITLE SEARCH screen:** Press EXIT.

Search for a disc by its genre:

1. Press **TEXT DISPLAY** while “CD” is selected as the source.

The Disc Information screen appears on the TV.

2. Press **▲** or **▼** to move **⇨** to “SEARCH,” then press **SET**.

The DISC SEARCH screen appears.

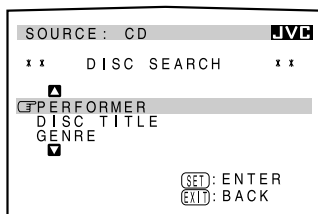

3. Press **▲** or **▼** to move **⇨** to “GENRE,” then press **SET**.

The GENRE SEARCH screen appears.

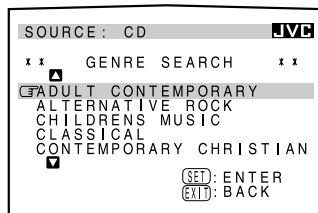

4. Press **▲** or **▼** to move **⇨** to the genre you want to search for, then press **SET**.

To show the unseen genres, press **▲** or **▼** until they appear.

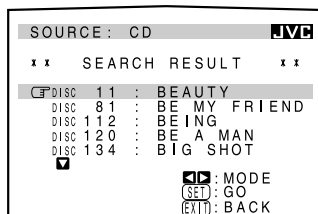

Disc search starts, then the SEARCH RESULT screen showing the disc titles appears.

5. On the SEARCH RESULT screen, you can do the following:

- **Changing the indication of the disc information:** Press **▲** or **▼** to move **⇨** to a searched-for disc, then press **◀** or **▶**. Each time you press **◀** or **▶**, the disc information alternates between its performer and its disc title.
- **Starting a disc play and going to the Disc Information screen (see page 45):** Press **▲** or **▼** to move **⇨** to a searched-for disc, then press **SET**.
- **Showing unseen disc information (if more than 5 discs are listed as a result of the search):** Press **▲** or **▼** until they appear.
- **Going back to the GENRE SEARCH screen:** Press **EXIT**.

Entering the Disc Information

For the CD Player with the disc memory function:

You can use the disc memory function through this receiver. The disc information (its performer, disc title, and music genre) of normal audio CDs will be stored into the memory built in the CD player.

For the disc memory function, refer to the manual supplied with your CD player.

- The performer, disc title, and music genre information are usually recorded in a CD Text. However, if a CD Text has no genre information recorded on the disc itself, you can input its music genre by yourself.

Note:

You can enter the TITLE INPUT screen for a CD Text and input its titles. However, you cannot store the titles you have input for a CD Text.

Example: Entering the following information for Disc 1
Performer: “MICHAEL”
Disc title: “MY FAVORITE”

1. Press **TEXT DISPLAY** while “CD” is selected as the source.

The Disc Information screen appears on the TV.

2. Press **▲** or **▼** to move **⇨** to “TITLE INPUT,” then press **SET**.

The TITLE INPUT/PERFORMER screen appears.

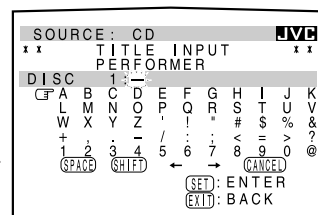

3. Press **▲** / **▼** / **◀** / **▶** to move **⇨** in front of a character you want, then press **SET** to enter the character.

- If the current CD is a CD Text, go to step 5 without entering the performer.

To use the lower case letters, press **▲** / **▼** / **◀** / **▶** to move **⇨** to **(SHIFT)**, then press **SET**.

To use the upper case letters again, press **▲** / **▼** / **◀** / **▶** to move **⇨** to **(SHIFT)**, then press **SET**.

4. Repeat step 3 until you finish putting a performer name (up to 32 characters).

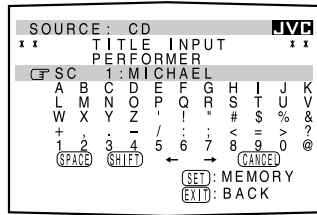

To insert a space, press ▲ / ▼ / ◀ / ▶ / ◀ / ▶ to move **⏏** to **(SPACE)**, then press SET.

To correct an incorrect character:

- 1) Press ▲ / ▼ / ◀ / ▶ to move **⏏** to ← or →, then press SET until the incorrect character is selected.
- 2) Press ▲ / ▼ / ◀ / ▶ to move **⏏** to **(CANCEL)**, then press SET to erase the character.
- 3) Press ▲ / ▼ / ◀ / ▶ to move **⏏** in front of the correct character, then press SET to enter the correct character.

5. Press ▲ / ▼ / ◀ / ▶ to move **⏏ to “DISC 1: MICHAEL (in this example),” then press SET.**

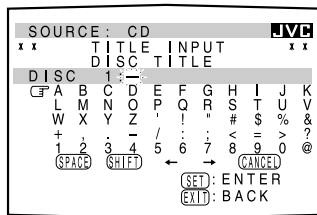

The TITLE INPUT/DISC TITLE screen appears.

6. Enter the disc title, referring to steps 3 and 4.

- If the current CD is a CD Text, go to the next step without entering the disc title.

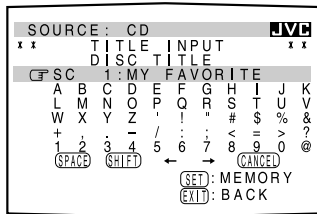

7. Press ▲ / ▼ / ◀ / ▶ to move **⏏ to “DISC 1: MY FAVORITE (in this example),” then press SET.**

The TITLE INPUT/DISC 1 GENRE screen appears.

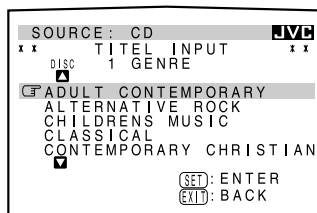

8. Press ▲ or ▼ to move **⏏ to the genre you want, then press SET.**

The Disc Information screen appears again.

To show the unseen genres, press ▲ or ▼ until they appear.

For the MD recorder:

You can write the disc information (disc title and song titles) onto the disc. You can only write the song title for the song currently selected.

- If you have the CD-MD combination deck, you can also enter the disc information (its performer, disc title, and its music genre) of normal audio CDs into the memory built in the CD-MD combination deck. (To do this, follow the procedure of “For the CD Player with the disc memory function” on page 47.)
- If you change the disc or song title with more than 32 characters, the characters following 32nd will be erased from the title.

1. Press TEXT DISPLAY while “MD” is selected as the source.

The Disc Information screen appears on the TV.

2. Press ▲ or ▼ to move **⏏ to “TITLE INPUT,” then press SET.**

The DISC TITLE INPUT screen appears.

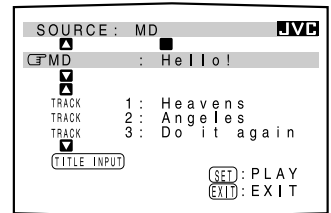

3. Enter the title, referring to steps 3 and 4 of “For the CD Player with the disc memory function.”

- You can enter up to 32 characters for the disc title.

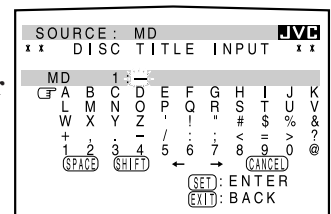

4. Press ▲ / ▼ / ◀ / ▶ to move **⏏ to the disc title you have just entered, then press SET.**

The disc title is stored into the memory and the SONG TITLE INPUT screen for the currently selected song appears.

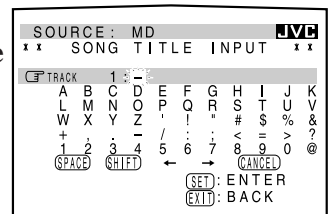

- You can enter a song title for the song currently selected.

5. Enter the song title, referring to steps 3 and 4 of “For the CD Player with the disc memory function.”

- You can enter up to 32 characters for the song title.

6. Press ▲ / ▼ / ◀ / ▶ to move **⏏ to the song title you have just entered, then press SET.**

The song title is stored into the memory and the Disc Information screen appears again.

AV COMPU LINK Remote Control System

The AV COMPU LINK remote control system allows you to operate JVC's video components (TV, VCR, and DVD player) through the receiver.

This receiver is equipped with the AV COMPU LINK-III, which adds a function to operate JVC's video components through the video components terminals. To use this remote control system, you need to connect the video components you want to operate, following the diagrams below and the procedure on the next page.

CONNECTIONS 1: AV COMPU LINK Connection

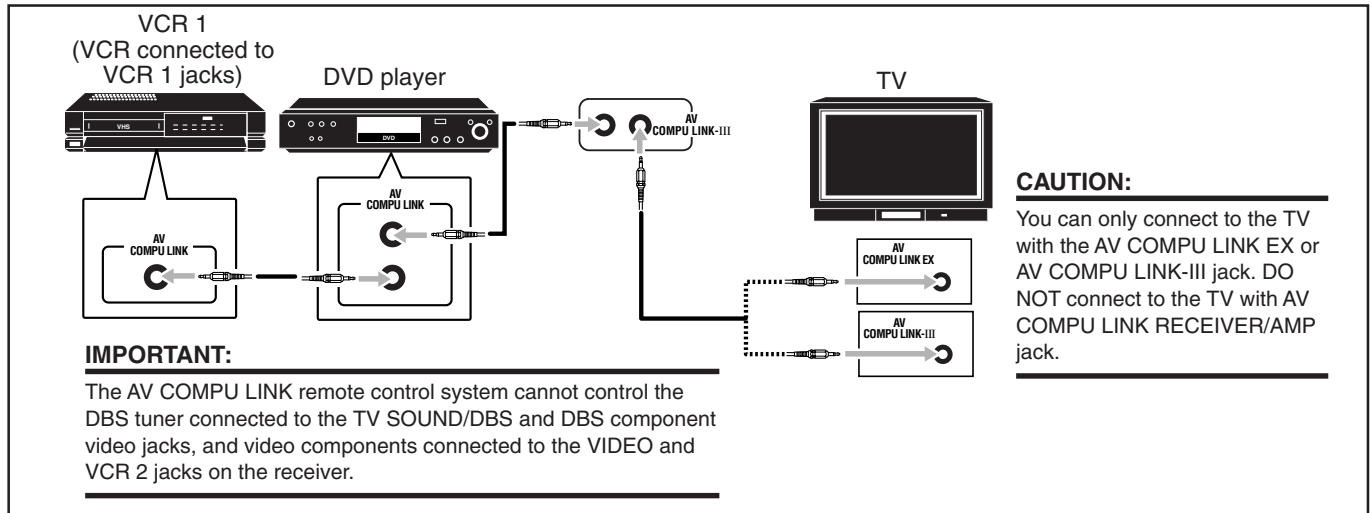

Notes:

- When connecting the receiver and a TV with the AV COMPU LINK EX terminal by using a component video cable, you cannot use automatic selection of TV's input mode (see page 50).
- When connecting only the VCR 1 or DVD player to this receiver, connect it directly to the receiver using cables with the monaural mini-plugs.

CONNECTIONS 2: Video Cable Connection

This receiver is equipped with three types of the video terminals—S-video, composite video, and component video, and the signals coming into this receiver through one type of video jacks can output only through the jack of the same type. So you need to connect the VCR and/or DVD player to the TV using one of the following three ways:

- When using the AV COMPU LINK remote control system, set the component video input for the DVD player and the DBS tuner correctly (see "[7] Setting the Component Video Input" on page 25); otherwise, the correct input for this receiver will not be selected on the TV.

CASE 1	<p>When connecting the source equipment to the receiver through the S-video jacks, connect this receiver to the TV's Video Input 1 jack using S-video cables.</p>
CASE 2	<p>When connecting the source equipment to the receiver through the composite video jacks, connect this receiver to the TV's Video Input 2 jack (composite video input) using composite video cables.</p>
CASE 3	<p>When connecting the source equipment to the receiver through the component video jacks, connect this receiver to the TV's Video Input 2 jack (component video input) using component video cables.</p>

1. **If you have already plugged your VCR 1 (VCR connected to the VCR 1 jacks), DVD player, TV and this receiver into the AC outlets, unplug their AC power cords first.**
2. **Connect your VCR 1, DVD player, TV and this receiver, using the cables with the monaural mini-plugs (not supplied).**
 - See “CONNECTIONS 1” on the previous page.
3. **Connect the audio input/output jacks on VCR 1, DVD player, TV and this receiver using the cables with RCA pin plugs.**
 - See pages 10 to 12.
4. **Connect the video input/output jacks on VCR 1, DVD player, TV and this receiver, using the cables with RCA pin plugs, S-video plug or component video plugs.**
 - See “CONNECTIONS 2” on the previous page.
5. **Plug the AC power cords of the components and the receiver into the AC outlets.**
6. **When turning on the TV for the first time after the AV COMPU LINK connection, turn the TV volume to the minimum using the TV volume control on the TV.**
7. **Turn on the connected components first, then turn on this receiver.**
 - When turning on the VCR 1 (VCR connected to the VCR 1 jacks), use the remote control supplied with this receiver (press VCR1 \odot /I).

The AV COMPU LINK remote control system allows you to use the five basic functions listed below.

Remote Control of the TV, DVD player, and VCR Using This Remote Control

See page 53 for details.

- Aim the remote control directly at **the remote sensor on each target component.**

One-Touch Video Play

Simply by inserting a video cassette without its safety tab into the VCR 1 (VCR connected to the VCR 1 jacks), you can enjoy the video playback without setting other switches manually. The receiver automatically turns on and changes the source to “VCR 1.” The TV automatically turns on and changes the input mode to the appropriate position so that you can view the playback picture. When you insert a video cassette with its safety tab, press the play (\blacktriangleright) button on the VCR 1 (VCR connected to the VCR 1 jacks) or on the remote control. So, you can get the same result.

One-Touch DVD Play

Simply by starting playback on the DVD player, you can enjoy the DVD playback without setting other switches manually.

- When the DVD player is connected through the analog input jacks on this receiver (and analog input is selected), the receiver automatically turns on and changes the source to “DVD” or “DVD MULTI.”
- When the DVD player is connected through the digital input terminal on this receiver (and digital input is selected), the receiver automatically turns on and changes the source to “DVD.” The TV automatically turns on and changes the input mode to the appropriate position so that you can view the playback picture.

Automatic Selection of TV's Input Mode

- When you select “TV” as the source to play on the receiver, the TV automatically changes the input mode to the TV tuner so that you can watch TV.
- When you select “DVD,” “DVD MULTI,” “VCR 1,” “VCR 2,” “VIDEO” or “DBS” as the source to play on the receiver, the TV automatically changes the input mode to the appropriate position (either Video Input 1 or Video Input 2) so that you can view the playback picture.

Notes:

- *When you select “TV” as the source on the receiver, you cannot see the menu on the TV screen since the AV COMPU LINK remote control system automatically changes the TV's input mode to the TV tuner.*
If you do not mind stopping listening to the TV sounds, you can then show the on-screen displays after changing the TV's input mode to the appropriate position (either Video Input 1 or Video Input 2).
- *This function does not work when you connect this receiver and the TV with the AV COMPU LINK using the TV's AV COMPU LINK EX terminal. In this case, reconnect the TV referring to CASE 1 or CASE 2 on page 49.*

Automatic Power On/Off

The TV, VCR 1 (the VCR connected to the VCR 1 jacks), and DVD player turn on and off along with the receiver.

When you turn on the receiver;

- If the previously selected source is “VCR 1,” the TV and VCR 1 will turn on automatically.
- If the previously selected source is “DVD” or “DVD MULTI,” the TV and DVD player will turn on automatically.
- If the previously selected source is “VIDEO,” “VCR 2,” “TV” or “DBS,” only the TV will turn on automatically.

When you turn off the receiver, the TV, VCR 1 and the DVD player will turn off.

Note:

If you turn off the receiver while recording on the VCR 1, the VCR 1 will not turn off, but continue recording.

Operating JVC's Audio/Video Components

You can operate JVC's audio and video components with this receiver's remote control, since control signals for JVC's components are preset in the remote control.

Operating Audio Components

IMPORTANT:

To operate JVC's audio components using this remote control:

- You need to connect JVC's audio components through the COMPU LINK (SYNCHRO) jacks (see page 43) in addition to the connections using cables with RCA pin plugs (see pages 8 and 9).
- Aim the remote control directly at the remote sensor on the receiver.
- If you use the buttons on the front panel or the menu function to choose a source, the remote control will not operate that source. To operate a source with the remote control, the source must be selected using source selecting buttons on the remote control.
- To operate a cassette deck or MD recorder using the COMPU LINK remote control system, set the source name correctly. (See page 17.)
- Refer also to the manuals supplied with your components.

Tuner

You can always perform the following operations on a tuner:

FM/AM : Alternate between FM and AM.

After pressing FM/AM, you can perform the following operations on a tuner:

- 1 - 10, +10 : Select a preset channel number directly.
For channel number 5, press 5.
For channel number 15, press +10, then 5.
For channel number 20, press +10, then 10.

TUNING UP/DOWN : Tune into stations.
FM MODE : Change the FM reception mode.

Sound control section (Amplifier)

You can always perform the following operations:

- SURROUND : Turn on and select Surround modes
- DSP : Turn on and select DSP modes.
- SURR/DSP OFF : Turn off Surround and DSP modes.

After pressing SOUND, you can perform the following operations:

- FRONT•L then LEVEL +/- : Adjust the left front speaker output level. "FRL" appears on the display.
- FRONT•R then LEVEL +/- : Adjust the right front speaker output level. "FRR" appears on the display.
- CENTER then LEVEL +/- : Adjust the center speaker output level. "CTR" appears on the display.
- SURR•L then LEVEL +/- : Adjust the left surround speaker output level. "SURRL" appears on the display.
- SURR•R then LEVEL +/- : Adjust the right surround speaker output level. "SURRR" appears on the display.
- SBACK•L then LEVEL +/- : Adjust the left surround back speaker output level. "SBKLL" appears on the display.
- SBACK•R then LEVEL +/- : Adjust the right surround back speaker output level. "SBKRL" appears on the display.
- SUBWFR then LEVEL +/- : Adjust the subwoofer output level. "S-WFR" appears on the display.
- DIGITAL EQ then LEVEL +/- : Select the audio band and adjust its frequency level. "EQ" appears on the display.
- TEST : Turn on or off the test tone output.
- BASS BOOST : Turn on or off Bass Boost function.

Note:

After adjusting sounds, press the corresponding source selecting button to operate your target source by using the 10 keys; otherwise, the 10 keys cannot be used for operating your target source.

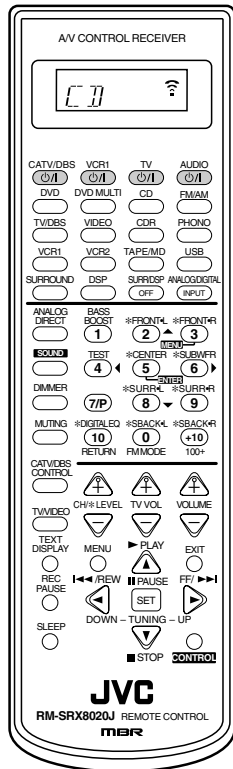

Note:

When you press one of the source selecting buttons, the operation mode appears on the display window. For example, the above illustration shows the remote control now works for CD operation.

Buttons	Indications								
FM/AM	TUNER								
CD	CD								
CDR	CDR								
PHONO	PHONO								
TAPE/MD	TAPE								
CONTROL (repeatedly)*	<table border="0"> <tr> <td>→</td> <td>VCR1</td> <td>→</td> <td>TAPE</td> </tr> <tr> <td>←</td> <td>CDDSC</td> <td>←</td> <td>CDR</td> </tr> </table>	→	VCR1	→	TAPE	←	CDDSC	←	CDR
→	VCR1	→	TAPE						
←	CDDSC	←	CDR						
SOUND	SOUND								

* By pressing CONTROL repeatedly, you can select "VCR1," "TAPE," "CDR" or "CDDSC" as the source.

CD player

After pressing CD, you can perform the following operations on a CD player:

- ▶ PLAY : Start playing.
- ◀◀ : Return to the beginning of the current (or previous) track.
- ▶▶ : Skip to the beginning of the next track.
- STOP : Stop playing.
- || PAUSE : Pause playing. To resume, press ▶ PLAY.
- 1 – 10, +10 : Select a track number directly.
For track number 5, press 5.
For track number 15, press +10, then 5.
For track number 20, press +10, then 10.
For track number 30, press +10, +10, then 10.

CD changer

After selecting “CDDSC” by pressing CONTROL repeatedly, you can perform the following operations on a CD changer:

- ▶ PLAY : Start playing.
- ◀◀ : Return to the beginning of the current (or previous) track.
- ▶▶ : Skip to the beginning of the next track.
- STOP : Stop playing or recording.
- || PAUSE : Pause playing. To resume, press ▶ PLAY.
- 1 – 6, 7/P : Select the number of a disc installed in a CD changer.

After pressing CD, you can perform the following operations on a CD changer:

- 1 – 10, +10 : Select a track number directly.
For track number 5, press 5.
For track number 15, press +10, then 5.
For track number 20, press +10, then 10.
For track number 30, press +10, +10, then 10.

Example:

- Selecting disc number 4, track number 12, and starting playback.
 1. Press CONTROL repeatedly until “CDDSC” appears on the display window, then press 4.
 2. Press CD, then press +10, 2.

Turntable

After pressing PHONO, you can perform the following operations on a turntable:

- ▶ PLAY : Start playing.
- STOP : Stop playing.

CD recorder

After pressing CDR (or selecting “CDR” by pressing CONTROL repeatedly), you can perform the following operations on a CD recorder:

- ▶ PLAY : Start playing.
- ◀◀ : Return to the beginning of the current (or previous) track.
- ▶▶ : Skip to the beginning of the next track.
- STOP : Stop playing or recording.
- || PAUSE : Pause playing. To resume, press ▶ PLAY.

- 1 – 10, +10 : Select a track number directly.
For track number 5, press 5.
For track number 15, press +10, then 5.
For track number 20, press +10, then 10.
For track number 30, press +10, +10, then 10.
- REC PAUSE : Enter recording pause by pressing this button.
To start recording again, press this button, then ▶ PLAY.

Note:

You can use either CDR or CONTROL to activate the buttons listed above. If you press CDR, the playing source also changes. On the other hand, if you press CONTROL repeatedly to select “CDR,” the playing source does not change.

Cassette deck

After pressing TAPE/MD (or selecting “TAPE” by pressing CONTROL repeatedly), you can perform the following operations on a cassette deck:

- ▶ PLAY : Start playing.
- REW : Fast wind the tape from right to left.
- FF : Fast wind the tape from left to right.
- STOP : Stop playing or recording.
- || PAUSE : Pause playing. To resume, press ▶ PLAY.
- REC PAUSE : Enter recording pause by pressing this button.
To start recording again, press this button, then ▶ PLAY.

Notes:

- When you use a cassette deck, change the source name connected to TAPE/MD jacks correctly (see page 17).
- You can use either TAPE/MD or CONTROL to activate the buttons listed above. If you press TAPE/MD, the playing source also changes. On the other hand, if you press CONTROL repeatedly to select “TAPE,” the playing source does not change.

MD recorder

After pressing TAPE/MD (or selecting “TAPE*” by pressing CONTROL repeatedly), you can perform the following operations on the MD recorder:

- ▶ PLAY : Start playing.
- ◀◀ : Return to the beginning of the current (or previous) track.
- ▶▶ : Skip to the beginning of the next track.
- STOP : Stop playing or recording.
- || PAUSE : Pause playing. To resume, press ▶ PLAY.
- REC PAUSE : Enter recording pause by pressing this button.
To start recording again, press this button then ▶ PLAY.

Notes:

- When you use an MD recorder, change the source name connected to TAPE/MD jacks correctly (see page 17).
- You can use either TAPE/MD or CONTROL to activate the buttons listed above. If you press TAPE/MD, the playing source also changes. On the other hand, if you press CONTROL repeatedly to select “TAPE*,” the playing source does not change.
- * Selecting “TAPE” will allow you to control the MD recorder.

Operating Video Components

IMPORTANT:

To operate JVC's video components using this remote control:

- You need to connect JVC's video components through the AV COMPU LINK jacks (see page 49) in addition to the connections using cables with RCA pin plugs (see pages 10 to 12).
- Some JVC's VCRs can accept two types of the control signals—remote code "A" and "B." Before using this remote control, make sure that the remote control code of the VCR connected to the VCR 1 jacks is set to code "A."
 - When another JVC's VCR is connected to the VCR 2 or VIDEO jacks, set its remote control code to code "B." (This remote control cannot emit the control signals of code "B.")
- When using the remote control, aim the remote control directly at the remote sensor on each component, not on the receiver.

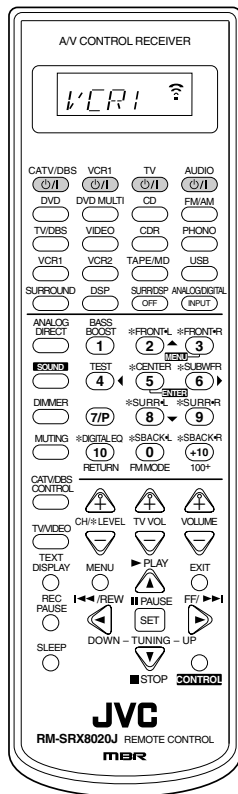

Note:

When you press one of the source selecting buttons, the operation mode appears on the display window. For example, the above illustration shows the remote control now works for VCR 1 operation.

Buttons	Indications						
VCR1	VCR1						
DVD or DVD MULTI	DVD						
TV/DBS	TV						
CONTROL (repeatedly)*	<table border="0"> <tr> <td>VCR1</td> <td>→</td> <td>TAPE</td> </tr> <tr> <td>CDDSC</td> <td>←</td> <td>CDR</td> </tr> </table>	VCR1	→	TAPE	CDDSC	←	CDR
VCR1	→	TAPE					
CDDSC	←	CDR					

* By pressing CONTROL repeatedly, you can select "VCR1," "TAPE," "CDR" or "CDDSC" as the source.

VCR 1 (VCR connected to the VCR 1 jacks)

You can always perform the following operations:

VCR1 \odot/I : Turn on or off the VCR 1 (VCR connected to the VCR 1 jacks).

After pressing VCR1 (or selecting "VCR1" by pressing CONTROL repeatedly), you can perform the following operations on the VCR 1 (VCR connected to the VCR 1 jacks):

- 1 – 9, 0 : Select the TV channels on a VCR.
- ▶ PLAY : Start playing.
- REW : Rewind a tape.
- FF : Fast wind a tape.
- STOP : Stop playing or recording.
- ▬ PAUSE : Pause playing. To resume, press ▶ PLAY.
- REC PAUSE : Enter recording pause by pressing this button. To start recording again, press this button then ▶ PLAY.
- CH +/- : Change the TV channels on the VCR.

Note:

You can use either VCR1 or CONTROL to activate the buttons listed above. If you press VCR1, the playing source also changes. On the other hand, if you press CONTROL repeatedly to select "VCR1," the playing source does not change.

DVD player

After pressing DVD or DVD MULTI, you can perform the following operations on a DVD player:

- ▶ PLAY : Start playing.
- ◀◀ : Return to the beginning of the current (or previous) chapter.
- ▶▶ : Skip to the beginning of the next chapter.
- STOP : Stop playing.
- ▬ PAUSE : Pause playing. To resume, press ▶ PLAY.

After pressing DVD or DVD MULTI, these buttons can be used for the DVD menu operations.

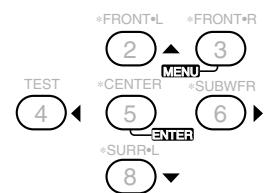

Note:

For detailed menu operations, refer to the instructions supplied with the discs or the DVD player.

TV

You can always perform the following operations:

- TV \odot/I : Turn on or off the TV.
- TV VOL +/- : Adjust the volume.
- TV/VIDEO : Set the input mode (either TV or VIDEO).

After pressing TV/DBS, you can perform the following operations on a TV:

- CH +/- : Change the channels.
- 1 – 9, 0, 100+ : Select the channels.
- RETURN : Alternate between the previously selected channel and the current channel.

Operating Other Manufacturers' Video Equipment

This remote control supplied with the receiver can transmit control signals for other manufacturers' TVs, CATV converters, DBS tuners, VCRs and DVD players. By changing the transmittable signals from preset ones to the other manufacturers', you can operate the other manufacturers' components using this remote control.

When operating the other manufacturers' components, refer also to the manuals supplied with them. To operate these components with the remote control, first you need to set the manufacturers' codes for each TV, CATV converters, DBS tuners VCR and DVD players.

After replacing batteries for the remote control, you need to set the manufacturers' codes again.

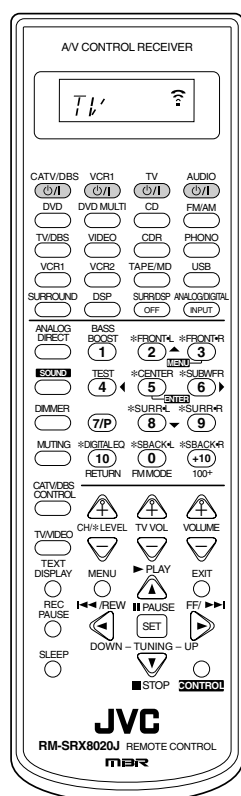

Note:

When you press one of the source selecting buttons, the operation mode appears on the display window. For example, the above illustration shows the remote control now works for TV operation.

Buttons	Indications
TV/DBS	TV
CATV/DBS CONTROL	CATV
VCR1	VCR1
DVD or DVD MULTI	DVD

To change the transmittable signals for operating another manufacturer's TV

1. Press and hold TV \odot/I .
2. Press TV/DBS.
"CALL" appears on the remote control display window.
3. Enter a manufacturer's code using buttons 1-9, and 0.
See the list below to find the code.
4. Release TV \odot/I .

The following buttons can be used for operating the TV:

TV \odot/I	: Turn on and off the TV.
TV VOL +/-	: Adjust the volume.
TV/VIDEO	: Set the input mode (either TV or VIDEO).

After pressing TV/DBS, you can perform the following operations on the TV:

CH +/-	: Change the channels.
1 - 10, 0, 100+ (+10)	: Select the channels.
The 10-key will function as the ENTER button if your TV requires pressing ENTER after selecting a channel number.	

Notes:

- Refer also to the manual supplied with your TV.
- All the functions listed above may not be assigned to the buttons for some TVs.
- If you cannot change the channels of some TVs by pressing number buttons, press CH +/- for changing the channels.

5. Try to operate your TV by pressing TV \odot/I .

When your TV turns on or off, you have entered the correct code.

If there are more than one code listed for your brand of TV, try each one until the correct one is entered.

Manufacturer	Codes	Manufacturer	Codes
JVC	00*, 02, 13, 14, 47, 74	QUELLE	52, 53, 54, 55, 56, 57, 58, 59, 60, 61, 62, 63, 64, 65, 66, 67
AKAI	01, 02	RCA/ PROSCAN	08, 24, 29, 30, 31, 48
BLAUPUNKT	03, 04		SABA
FISHER	01, 05	SAMSUNG	06, 08, 16, 34, 35, 49
GRUNDIG	03, 06, 07		SANYO
HITACHI	08, 09, 10, 49	SCHNEIDER	02, 15, 36
IRADDIO	02	SHARP	37, 38, 77
ITT/NOKIA	11, 12	SONY	39
LOEWE	06, 15, 16	TELEFUNKEN	40, 41, 42, 69
MAGNAVOX	08, 17, 49	THOMSON	71, 72
METS	50, 51, 52, 53	TOSHIBA	37, 43, 44
MITSUBISHI	08, 18, 19, 20	ZENITH	45, 46
MIVAR	21		
NORDMENDE	22, 23		
OKANO	15		
PANASONIC	24, 25, 26, 27, 76		
PHILIPS	15, 17, 28, 75		

*Initial setting

Manufacturers' codes are subject to change without notice. If they are changed, this remote control cannot operate the equipment.

To change the transmittable signals for operating a CATV converter or DBS tuner

1. Press and hold CATV/DBS \odot/I .
2. Press CATV/DBS CONTROL.
"CALL" appears on the remote control display window.
3. Enter a manufacturer's code using buttons 1–9, and 0.

See the following lists to find the code.

4. Release CATV/DBS \odot/I .

The following buttons can be used for operating the CATV converter and DBS tuner:

CATV/DBS \odot/I	:Turn on and off the CATV converter or DBS tuner.
CH +/-	:Change the channels.
1 – 10, 0, 100+ (+10)	:Select the channels. The 10-key will function as the ENTER button if your equipment requires pressing ENTER after selecting a channel number.

Note:

Refer also to the manual supplied with your CATV converter or DBS tuner.

5. Try to operate your CATV converter or DBS tuner by pressing CATV/DBS \odot/I .

When your CATV converter or DBS tuner turns on or off, you have entered the correct code.

If there are more than one code listed for your brand of CATV converter or DBS tuner, try each one until the correct one is entered.

Note:

You cannot preset the signals for both the CATV converter and DBS tuner at the same time.

For DBS tuner

Manufacturer	Codes
JVC	56*, 57, 67
AMSTRAD	43, 44, 45, 46, 47, 48, 49
BLAUPUNKT	30
ECHOSTAR	50, 51, 67
GOLDSTAR	31
GRUNDIG	32, 33
HIRSHMANN	48, 52, 53, 54, 55
INSTRUMENT	68
ITT/NOKIA	34
KATHREIN	52, 58, 59, 60, 61, 62, 63
NEC	35, 36
ORBITECH	48
PHILIPS	37, 38
RCA	65
SAMSUNG	39, 40
SCHWAIGER	61, 64
SIEMENS	41, 42
SONY	66
TECHNISAT	48

*Initial setting

For CATV converter

Manufacturer	Codes
GENERAL INSTRUMENT	06, 07, 08, 09, 10, 11, 12, 13, 14, 29
HAMLIN/REGAL	01, 02, 03, 04, 05
JERROLD	06, 07, 08, 09, 10, 11, 12, 13, 14
OAK	15, 16, 17
PANASONIC	18, 19, 20
PIONEER	21, 22
SCIENTIFIC ATLANTA	23, 24, 25
TOCOM	26
ZENITH	27, 28

Manufacturers' codes are subject to change without notice. If they are changed, this remote control cannot operate the equipment.

To change the transmittable signals for operating another manufacturer's VCR

1. Press and hold VCR1 \odot/I .
2. Press VCR1.
"CALL" appears on the remote control display window.
3. Enter manufacturer's code using buttons 1–9, and 0.

See the list on the next page to find the code.

4. Release VCR1 \odot/I .

The following buttons can be used for operating the VCR:

VCR1 \odot/I	:Turn on and off the VCR.
-----------------------	---------------------------

After pressing VCR1, you can perform the following operations on the VCR:

CH +/-	:Change the TV channels on the VCR.
1 – 10, 0, 100+ (+10)	:Select the TV channels. The 10-key will function as the ENTER button if your VCR requires pressing ENTER after selecting a channel number.
▶ PLAY	:Start playback.
REW	:Rewind a tape.
FF	:Fast wind a tape.
■ STOP	:Stop playing or recording.
PAUSE:	:Pause playing. To resume, press ▶ PLAY.
REC PAUSE	:Enter recording pause by pressing this button. To start recording again, press this button then ▶ PLAY.

Note:

Refer also to the manual supplied with your VCR.

5. Try to operate your VCR by pressing VCR1 \odot/I .
When your VCR turns on or off, you have entered the correct code.

If there are more than one code listed for your brand of VCR, try each one until the correct one is entered.

Manufacturer	Codes
JVC	00*, 26, 27, 28, 29, 58
AIWA	01, 02
BELL & HOWELL	03
BLAUPUNKT	04, 05
CGM	06, 07
EMERSON	08, 10, 11, 12, 64, 65
FISHER	03, 14, 15, 16, 17
FUNAI	01
GE	18, 19, 20
GOLDSTAR	07
GOODMANS	13, 21
GRUNDIG	06, 22
HITACHI	18, 23, 24, 25, 66
LOEWE	07, 21
MAGNAVOX	04, 19, 24
mitsubishi	30, 31, 32, 33, 34, 35
NEC	26, 27
NOKIA	03, 36
NORDMENDE	38
ORION	09
PANASONIC	19, 24, 39, 40
PHILIPS	04, 19, 21, 24, 41, 42
PHONOLA	21
RCA/PROSCAN	04, 18, 19, 23, 24, 43, 44, 45
SABA	38, 46
SAMSUNG	45, 47, 59, 61, 62, 63
SANYO	03, 48, 49
SHARP	37, 50
SIEMENS	03, 51
SONY	52, 53, 54
TELEFUNKEN	55, 60
TOSHIBA	43, 44
ZENITH	56, 57

*Initial setting

Manufacturers' codes are subject to change without notice. If they are changed, this remote control cannot operate the equipment.

To change the transmittable signals for operating another manufacturer's DVD player

1. Press and hold AUDIO $\odot/!$.
2. Press DVD.
"CALL" appears on the remote control display window.
3. Enter a manufacturer's code using buttons 1-9, and 0.
See the following list to find the code.
4. Release AUDIO $\odot/!$.
After pressing DVD or DVD MULTI, you can perform the following operations on the DVD player:

▶ PLAY	:Start playing.
◀◀	:Return to the beginning of the current (or previous) chapter.
▶▶	:Skip to the beginning of the next chapter.
■ STOP	:Stop playing.
PAUSE	:Pause playing. To resume, press ▶ PLAY.

After pressing DVD or DVD MULTI, these buttons can be used for the DVD menu operations.

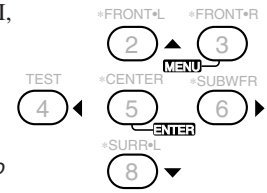

Note:

For detailed menu operations, refer to the instructions supplied with the discs or the DVD player.

Note:

Refer also to the manual supplied with your DVD player.

5. Try to operate your DVD player by pressing one of the above buttons.

- DO NOT forget to turn on the DVD player before pressing one of the above buttons.

If there are more than one code listed for your brand of DVD, try each one until the correct one is entered.

Manufacturer	Codes
JVC	00*, 02
DENON	01
PANASONIC	03
PHILIPS	13
PIONEER	04, 05, 06
RCA	07
SAMSUNG	08
SONY	09
TOSHIBA	10
YAMAHA	11, 12

*Initial setting

Manufacturers' codes are subject to change without notice. If they are changed, this remote control cannot operate the equipment.

Troubleshooting

Use this chart to help you solve daily operational problems. If there is any problem you cannot solve, contact your JVC's service center.

PROBLEM	POSSIBLE CAUSE	SOLUTION
The display does not light up.	The power cord is not plugged in.	Plug the power cord into an AC outlet. (See page 15.)
No sound from speakers.	Speaker signal cables are not connected.	Check speaker wiring and reconnect if necessary. (See pages 6 to 8.)
	The SPEAKERS ON/OFF 1 and SPEAKERS ON/OFF 2 buttons are not set correctly.	Press SPEAKERS ON/OFF 1 and SPEAKERS ON/OFF 2 correctly. (See page 18.)
	An incorrect source is selected.	Select the correct source.
	Muting is activated.	Press MUTING to cancel the mute. (See page 20.)
	An incorrect input mode (analog or digital) is selected.	Select the correct input mode (analog or digital). (See page 19.)
Sound from one speaker only.	Connections are incorrect.	Check connections. For analog connections, see pages 8 to 12. For digital connections, see page 13. For USB connection, see page 14.
	Speaker signal cables are not connected properly.	Check speaker wiring and reconnect if necessary. (See pages 6 to 8.)
No sound from PC connected with a USB cable.	The balance is set to one extreme.	Adjust the balance properly. (See page 40.)
	An electrical shock is applied to the receiver, PC, or USB cable.	Turn off the receiver once, then turn it on again and restart application installed in the PC.
	USB device is not selected on the computer.	Select "USB Audio Device [1]" for "Playback" of "Audio." (See page 14.) Refer to the manuals supplied with your PC.
Noise while reproducing PC sound connected with a USB cable.	"Mute" is selected on the PC.	Check if the volume is set at low level. Refer to the manuals supplied with your PC.
	Strong electromagnetic wave is emitted from a nearby device such as TV	Move the PC away from the device such as TV emitting strong electromagnetic wave.
Sound from PC connected with a USB cable is intermittent.	PC is subjected to excessive load due to using other applications.	Close the applications you do not use.
Continuous hiss or buzzing during FM reception.	Incoming signal is too weak.	Connect an outdoor FM antenna or contact your dealer. (See page 5.)
	The station is too far away.	Select a new station.
	An incorrect antenna is used.	Check with your dealer to be sure you have the correct antenna.
	Antennas are not connected properly.	Check connections. (See pages 5 and 6.)
Occasional cracking noise during FM reception.	Ignition noise from automobiles.	Move the antenna further from automobile traffic.
Noise is heard while playing a record.	A ground cable from the turntable is not connected to the screw marked (⌘) on the rear panel.	Connect the cable to the screw marked (⌘) on the rear panel.
Howling during record playing.	Your turntable is too close to the speakers.	Move the speakers away from the turntable.
No sound effect such as Surround mode, DSP mode and digital equalization.	The Analog Direct is turned on.	Turn off the Analog Direct. (See page 30.)
6.1-channel reproduction cannot be done for Dolby Digital EX or DTS ES software.	Software or setting is not for Dolby Digital EX or DTS ES software.	Play back software bearing the mark  or  Set "EX/ES" setting to "AUTO." (See page 23.)

PROBLEM	POSSIBLE CAUSE	SOLUTION
“OVERLOAD” starts flashing on the display.	Speakers are overloaded because of high volume.	1.Press STANDBY/ON \odot /I on the front panel to turn off the receiver. 2.Stop the playback source. 3.Turn on the receiver again and adjust the volume.
	Speakers are overloaded because of short circuit of speaker terminals.	Press STANDBY/ON \odot /I on the front panel to turn off the receiver, then check the speaker wiring. If “OVERLOAD” does not disappear, unplug the AC power cord, then plug it back again. If speaker wiring is not short-circuited, contact your dealer.
The STANDBY lamp lights up after turning on the power, and soon the receiver turns off again (into standby mode).	The receiver is overloaded because of high voltage.	Press STANDBY/ON \odot /I on the front panel to turn off the receiver. After unplugging the AC power cord, consult your dealer.
Remote control does not work.	There is an obstruction between the remote sensor on the receiver and the remote control.	Remove the obstruction.
	Batteries are weak.	Replace batteries. (See page 15.)
Remote control does not work intendedly.	An incorrect remote control operation mode is selected.	Select the correct remote control operation mode. (See pages 51 to 53.)

Specifications

Amplifier

Output Power:

At Stereo operation:

Front channels: 100 W* per channel, min. RMS, driven into 8 Ω at 1 kHz, with no more than 0.8% total harmonic distortion. (IEC268-3/DIN)

At Surround operation:

Front channels: 100 W* per channel, min. RMS, driven into 8 Ω at 1 kHz, with no more than 0.8% total harmonic distortion.

Center channel: 100 W*, min. RMS, driven into 8 Ω at 1 kHz, with no more than 0.8% total harmonic distortion.

Surround channels: 100 W* per channel, min. RMS, driven into 8 Ω at 1 kHz, with no more than 0.8% total harmonic distortion.

(* Measured on AC 110 V, 127 V, 220 V and 240 V)

Audio

Audio Input Sensitivity/Impedance (1 kHz):	PHONO (MM):	2.5 mV/47 kΩ
	DVD, VCR 1, VCR 2, VIDEO, TV SOUND/DBS, CD, CDR, TAPE/MD:	200 mV/47 kΩ
Audio Input (DIGITAL IN)* :	Coaxial: DIGITAL 1 (DVD):	0.5 V(p-p)/75 Ω
	Optical: DIGITAL 2 (CD), DIGITAL 3 (TV), DIGITAL 4 (CDR):	-21 dBm to -15 dBm (660 nm ±30 nm)
	*Corresponding to Linear PCM, Dolby Digital, and DTS Digital Surround (with sampling frequency — 32 kHz, 44.1 kHz, 48 kHz).	
	USB:	Revision 1.0, full-speed (with sampling frequency — 32 kHz, 44.1 kHz, 48 kHz)
Audio Output Level:	PRE OUT	1.0 V
Recording Output Level:	VCR 1, VCR 2, CDR, TAPE/MD:	200 mV
Digital output:	Optical: DIGITAL OUTPUT:	Signal wave length: 660 nm Output level: -21 dBm to -15 dBm
Signal-to-Noise Ratio ('66 IHF/DIN):	PHONO:	70 dB/66 dB
	DVD, VCR 1, VCR 2, VIDEO, TV SOUND/DBS, CD, CDR, TAPE/MD:	92 dB/67 dB
Frequency Response (8 Ω):	PHONO:	20 Hz to 20 kHz (±1 dB)
	DVD, VCR 1, VCR 2, VIDEO, TV SOUND/DBS, CD, CDR, TAPE/MD:	20 Hz to 100 kHz (+1 dB, -3 dB)
	USB:	20 Hz to 20 kHz (+1 dB, -3 dB)
RIAA Phono Equalization:	±1.0 dB (20 Hz to 20 kHz)	
Bass boost:	+6 dB ±1.0 dB at 100 Hz	

Video

Video Input Sensitivity/Impedance:		
Composite video:	DVD, VCR 1, VCR 2, VIDEO, TV SOUND/DBS:	1 V(p-p)/75 Ω
S-video:	DVD, VCR 1, VCR 2, VIDEO, TV SOUND/DBS:	(Y: luminance): 1 V(p-p)/75 Ω (C: chrominance, burst): 0.286 V(p-p)/75 Ω
Component video:	DVD, DBS:	(Y: luminance): 1 V(p-p)/75 Ω (P _B /P _R): 0.7 V(p-p)/75 Ω
Video Output Level:		
Composite video:	VCR 1, VCR 2, MONITOR OUT:	1 V(p-p)/75 Ω
S-video:	VCR 1, VCR 2, MONITOR OUT:	(Y: luminance): 1 V(p-p)/75 Ω (C: chrominance, burst): 0.286 V(p-p)/75 Ω
Component video:	MONITOR OUT:	(Y: luminance): 1 V(p-p)/75 Ω (P _B /P _R): 0.7 V(p-p)/75 Ω
Synchronization:	Negative	
Signal-to-Noise Ratio:	45 dB	
On-Screen System:	PAL	

FM tuner (IHF)

Tuning Range:	87.50 MHz to 108.00 MHz	
Usable Sensitivity:	Monaural:	12.8 dBf (1.2 μ V/75 Ω)
50 dB Quieting Sensitivity:	Monaural:	21.3 dBf (3.2 μ V/75 Ω)
	Stereo:	41.3 dBf (31.5 μ V/75 Ω)
Signal-to-Noise Ratio (IHF-A weighted):	Monaural:	78 dB at 85 dBf
	Stereo:	73 dB at 85 dBf
Total Harmonic Distortion:	Monaural:	0.4% at 1 kHz
	Stereo:	0.6% at 1 kHz
Stereo Separation at REC OUT:	35 dB at 1 kHz	
Alternate Channel Selectivity:	45 dB: (\pm 400 kHz)	
Frequency Response:	30 Hz to 15 kHz: (+0.5 dB, -3 dB)	

AM tuner

Tuning Range:	522 kHz to 1 629 kHz	
Usable Sensitivity:	Loop antenna	400 μ V/m
Signal-to-Noise Ratio:	50 dB (100 mV/m)	

General

Power Requirements:	AC 110 V/127 V/220 V/230 V – 240V \sim , adjustable with the voltage selector, 50 Hz/60 Hz	
Power Consumption:	210 W (at operation) 2 W (in standby mode)	
Dimensions (W x H x D):	435 mm x 156.5 mm x 425 mm	
Mass:	11.8 kg	

Designs & specifications are subject to change without notice.

Mains (AC) Line Instruction (not applicable for Europe, U.S.A., Canada, Australia and U.K.)

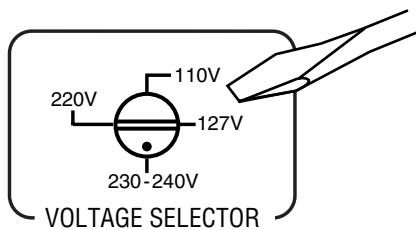
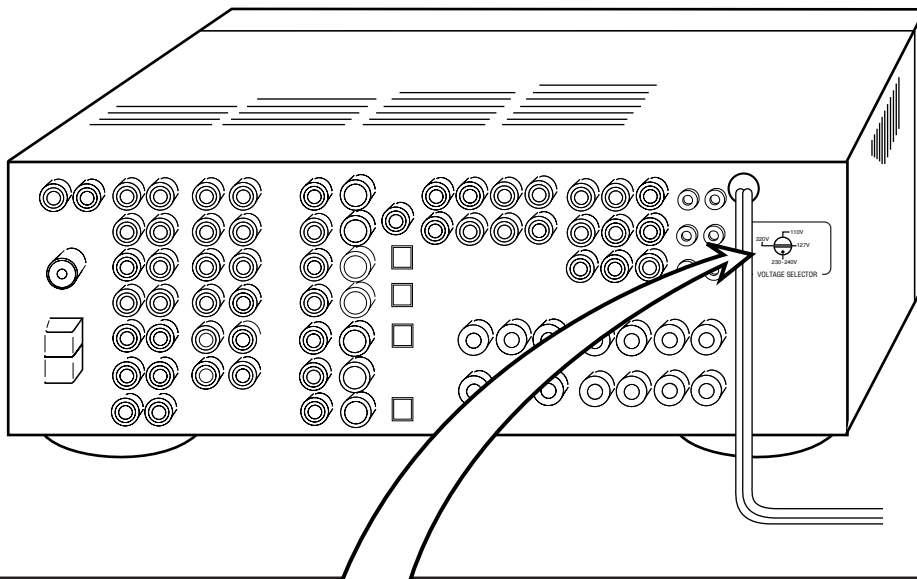

CAUTION for mains (AC) line

BEFORE PLUGGING IN, do check that your mains (AC) line voltage corresponds with the position of the voltage selector switch provided on the outside of this equipment and, if different, reset the voltage selector switch, to prevent from a damage or risk of fire/ electric shock.

JVC

VICTOR COMPANY OF JAPAN, LIMITED

Free Manuals Download Website

<http://myh66.com>

<http://usermanuals.us>

<http://www.somanuals.com>

<http://www.4manuals.cc>

<http://www.manual-lib.com>

<http://www.404manual.com>

<http://www.luxmanual.com>

<http://aubethermostatmanual.com>

Golf course search by state

<http://golfingnear.com>

Email search by domain

<http://emailbydomain.com>

Auto manuals search

<http://auto.somanuals.com>

TV manuals search

<http://tv.somanuals.com>