

# JVC



## AUDIO/VIDEO CONTROL RECEIVER

AUDIO/VIDEO-RECEIVER MIT STEUER-EINHEIT  
AMPLI/TUNER DE COMMANDE AUDIO/VIDEO  
GEINTEGREERDE AUDIO/VIDEO-VERSTERKER  
RECEPTOR DE CONTROL DE AUDIO/VÍDEO  
RICEVITORE DI CONTROLLO AUDIO/VIDEO

# RX-430VBK

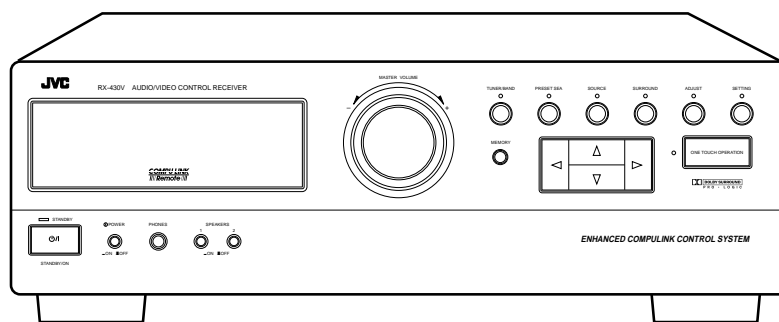
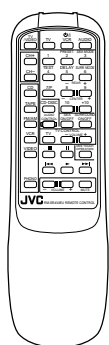

**COMPU LINK**  
Remote

## INSTRUCTIONS

*BEDIENUNGSANLEITUNG  
MANUEL D'INSTRUCTIONS  
GEBRUIKSAANWIJZING  
MANUAL DE INSTRUCCIONES  
ISTRUZIONI*

### For Customer Use:

Enter below the Model No. and Serial No. which are located either on the rear, bottom or side of the cabinet. Retain this information for future reference.

Model No. \_\_\_\_\_

Serial No. \_\_\_\_\_

LET0022-001A  
[EF, G]

**Warnings, Cautions and Others/Warnung, Achtung und sonstige Hinweise/  
Mises en garde, précautions et indications diverses/Waarschuwingen,  
voorzorgen en andere mededelingen/Avisos, precauciones y otras notas/  
Avvertenze e precauzioni da osservare**

---

**IMPORTANT** for the U.K.

**DO NOT** cut off the mains plug from this equipment. If the plug fitted is not suitable for the power points in your home or the cable is too short to reach a power point, then obtain an appropriate safety approved extension lead or consult your dealer.

**BE SURE** to replace the fuse only with an identical approved type, as originally fitted.

If nonetheless the mains plug is cut off ensure to remove the fuse and dispose of the plug immediately, to avoid a possible shock hazard by inadvertent connection to the mains supply.

If this product is not supplied fitted with a mains plug then follow the instructions given below:

**IMPORTANT.**

**DO NOT** make any connection to the terminal which is marked with the letter E or by the safety earth symbol or coloured green or green-and-yellow.

The wires in the mains lead on this product are coloured in accordance with the following code:

Blue : Neutral  
Brown : Live

As these colours may not correspond with the coloured markings identifying the terminals in your plug proceed as follows:

The wire which is coloured blue must be connected to the terminal which is marked with the letter N or coloured black.

The wire which is coloured brown must be connected to the terminal which is marked with the letter L or coloured red.

**IF IN DOUBT - CONSULT A COMPETENT ELECTRICIAN.**

**Per l'Italia:**

“Si dichiara che il questo prodotto di marca JVC è conforme alle prescrizioni del Decreto Ministeriale n.548 del 28/08/95 pubblicato sulla Gazzetta Ufficiale della Repubblica Italiana n.301 del 28/12/95.”

**CAUTION**

To reduce the risk of electrical shocks, fire, etc.:

1. Do not remove screws, covers or cabinet.
2. Do not expose this appliance to rain or moisture.

**ACHTUNG**

Zur Verhinderung von elektrischen Schlägen, Brandgefahr, usw:

1. Keine Schrauben lösen oder Abdeckungen enternen und nicht das Gehäuse öffnen.
2. Dieses Gerät weder Regen noch Feuchtigkeit aussetzen.

**ATTENTION**

Afin d'éviter tout risque d'électrocution, d'incendie, etc.:

1. Ne pas enlever les vis ni les panneaux et ne pas ouvrir le coffret de l'appareil.
2. Ne pas exposer l'appareil à la pluie ni à l'humidité.

**VOORZICHTIG**

Ter vermindering van gevaar voor brand, elektrische schokken, enz.:

1. Verwijder geen schroeven, panelen of de behuizing.
2. Stel dit toestel niet bloot aan regen of vocht.

**PRECAUCIÓN**

Para reducir riesgos de choques eléctricos, incendio, etc.:

1. No extraiga los tornillos, los cubiertas ni la caja.
2. No exponga este aparato a la lluvia o a la humedad.

**ATTENZIONE**

Per ridurre il rischio di scosse elettriche, incendi, ecc...

1. Non togliere viti, coperchi o la scatola.
2. Non esporre l'apparecchio alla pioggia e all'umidità.

**Caution — ① POWER switch and STANDBY/ON ⏻/⏻ button!**

This apparatus is provided with a ① POWER switch to be able to minimize power consumption for safe use. Therefore,

1. When doing initial setting, complete all the connections required, connect the mains plug into the wall outlet, and set the ① POWER switch to ON. After these, it will be available to operate STANDBY/ON ⏻/⏻ button and so on.
2. When not in use, set the ① POWER switch to OFF.
3. Disconnect the mains plug to shut the power off completely. The ① POWER switch and STANDBY/ON ⏻/⏻ button in any position do not disconnect the mains line.
4. The power can be remote controlled.

**Achtung — ① POWER-Schalter und STANDBY/ON ⏻/⏻-Taste!**

Dieses Gerät hat einen Netzschalter (① POWER), um den Stromverbrauch für sichere Verwendung auf ein Minimum bringen zu können. Verfahren Sie deshalb wie folgt:

1. Beim ursprünglichen Aufbau alle erforderlichen Anschlüsse herstellen, den Netzstecker in eine Wandsteckdose stecken, und den ① POWER-Schalter einschalten. Anschließend ist Betrieb der STANDBY/ON ⏻/⏻-Taste usw. möglich.
2. Wenn das Gerät nicht verwendet wird, den ① POWER-Schalter ausschalten.
3. Den Netzstecker aus der Steckdose ziehen, um die Stromversorgung vollkommen zu unterbrechen. Der ① POWER-Schalter und die STANDBY/ON ⏻/⏻-Taste unterbrechen in keiner Stellung die Stromversorgung vollkommen.
4. Die Stromversorgung kann mit der Fernbedienung ein- und ausgeschaltet werden.

**Attention — Commutateur ① POWER et d'une touche STANDBY/ON ⏻/⏻!**

Cet appareil est équipé d'un commutateur ① POWER qui lui permet de réduire sa consommation d'électricité pour une utilisation plus sûre. Par conséquent,

1. En procédant au réglage initial, compléter toutes les connexions nécessaires, connecter la fiche secteur dans la prise murale et mettre le commutateur ① POWER sur la position ON. Ensuite, il sera possible de contrôler la touche STANDBY/ON ⏻/⏻, etc.
2. Mettre le commutateur ① POWER sur la position OFF lorsque l'appareil n'est pas utilisé.
3. Déconnecter la fiche secteur pour couper complètement le courant. Le commutateur ① POWER et la touche STANDBY/ON ⏻/⏻ ne coupent jamais complètement l'alimentation, quelle que soit leurs positions.
4. L'alimentation peut être télécommandée.

**Voorzichtig — ① POWER en STANDBY/ON ⏻/⏻ schakelaars!**

Dit apparaat is voorzien van een ① POWER hoofdschakelaar om het apparaat gebruiksklaar te zetten, maar te zorgen dat het stroomverbruik minimaal blijft. Neem in verband hiermee het volgende in acht:

1. Bij de eerste ingebruikneming zorgt u eerst dat alle aansluitingen in orde zijn, dan steekt u de stekker in het stopcontact en dan zet u de ① POWER schakelaar in de "ON" stand. Daarna kunt u het apparaat aan- en uitschakelen met de STANDBY/ON ⏻/⏻ schakelaar.
2. Wanneer u het apparaat geruime tijd niet gebruikt, kunt u beter de ① POWER schakelaar in de "OFF" stand zetten.
3. Om de stroomtoevoer geheel uit te schakelen, trekt u de stekker uit het stopcontact. Anders zal er altijd een geringe hoeveelheid stroom naar het apparaat lopen, ongeacht de stand van de STANDBY/ON ⏻/⏻ en de ① POWER.
4. U kunt het apparaat ook met de afstandsbediening aan- en uitschakelen.

**Precaución — Interruptor ① POWER y botón STANDBY/ON ⏻/⏻!**

Esta unidad dispone de un interruptor ① POWER que sirve para reducir al mínimo el consumo de alimentación para proporcionar mayor seguridad operacional. Por lo tanto,

1. Al ejecutar el ajuste inicial, después de completar todas las conexiones requeridas, conectar el cable de alimentación a una toma de pared, y activar el interruptor ① POWER. Entonces, será posible ejecutar operaciones tales como la conmutación del estado de alimentación.
2. Desactivar el interruptor ① POWER al dejar la unidad fuera de uso.
3. Desconectar el cable de alimentación para desactivar la alimentación totalmente. Cualquier que sea la posición de ajustes del interruptor ① POWER y el botón STANDBY/ON ⏻/⏻, la alimentación no es cortada completamente.
4. La alimentación puede ser controlada remotamente.

**Attenzione — Interruttore ① POWER e tasto STANDBY/ON ⏻/⏻!**

Per ridurre al minimo l'assorbimento di corrente ai fini della sicurezza, questo apparecchio è stato dotato di un interruttore ① POWER. Di conseguenza,

1. Al momento dell'impostazione iniziale, completare tutti i collegamenti richiesti, inserire la spina del cavo di alimentazione nella presa a muro della rete elettrica e impostare l'interruttore ① POWER in posizione ON. Fatto ciò, sarà pronto all'uso STANDBY/ON ⏻/⏻.
2. Quando non in uso, impostare l'interruttore ① POWER in posizione OFF.
3. Disinserire la spina del cavo di alimentazione dalla presa della rete elettrica per staccare completamente l'alimentazione. L'interruttore ① POWER e il tasto STANDBY/ON ⏻/⏻ in nessuna posizione staccano la linea di alimentazione elettrica principale.
4. È possibile il controllo remoto dell'alimentazione.

### Caution: Proper Ventilation

To avoid risk of electric shock and fire and to protect from damage.

Locate the apparatus as follows:

- Front: No obstructions open spacing.
- Sides: No obstructions in 10 cm from the sides.
- Top: No obstructions in 10 cm from the top.
- Back: No obstructions in 15 cm from the back
- Bottom: No obstructions, place on the level surface.

In addition, maintain the best possible air circulation as illustrated.

### Achtung: Angemessene Ventilation

Stellen Sie das Gerät zur Verhütung von elektrischem Schlag und Feuer und zum Schutz gegen Beschädigung wie folgt auf:

Vorderseite: Offener Platz ohne Hindernisse.

- Seiten: Keine Hindernisse innerhalb 10 cm von den Seiten.
  - Oberseite: Keine Hindernisse innerhalb 10 cm von der Oberseite.
  - Rückseite: Keine Hindernisse innerhalb 15 cm von der Rückseite.
  - Unterseite: Keine Hindernisse. Auf eine ebene Oberfläche stellen.
- Zusätzlich die bestmögliche Luftzirkulation wie gezeigt erhalten.

### Attention: Ventilation Correcte

Pour éviter les chocs électriques, l'incendie et tout autre dégât.

Disposer l'appareil en tenant compte des impératifs suivants

- Avant: Rien ne doit gêner le dégagement
- Flancs: Laisser 10 cm de dégagement latéral
- Dessus: Laisser 10 cm de dégagement supérieur
- Arrière: Laisser 15 cm de dégagement arrière
- Dessous: Rien ne doit obstruer par dessous; poser l'appareil sur une surface plate.

Veiller également à ce que l'air circule le mieux possible comme illustré.

### Voorzichtig: Zorg Voor Goede Ventilatie

Om gevaar voor brand of een elektrische schok te voorkomen, dient u bij opstelling van het apparaat op de volgende punten te letten:

- Voorkant: Voldoende ruimte vrij houden.
- Zijkanten: Minstens 10 cm aan weerszijden vrij houden.
- Bovenkant: Niets bovenop plaatsen; 10 cm speling geven.
- Achterkant: Minstens 15 cm ruimte achteraan vrij houden.
- Onderkant: Opstellen op een egaal horizontaal oppervlak.

Bovendien moet er rondom voldoende luchtdoorstroming zijn, zoals in de afbeelding aangegeven.

### Precaución: Ventilación Adecuada

Para evitar el riesgo de choque eléctrico e incendio y para proteger el aparato contra daños.

Ubique el aparato de la siguiente manera:

- Frente: Espacio abierto sin obstrucciones
- Lados: 10 cm sin obstrucciones a los lados
- Parte superior: 10 cm sin obstrucciones en la parte superior
- Parte trasera: 15 cm sin obstrucciones en la parte trasera
- Fondo: Sin obstrucciones, colóquelo sobre una superficie nivelada

Además, mantenga la mejor circulación de aire posible como se ilustra.

### Attenzione: Problemi di Ventilazione

Per evitare il rischio di folgorazioni ed incendi e proteggere l'unità da danni, installarla nel modo seguente.

- Davanti: Nessun ostacolo, spazio libero
- Lati: Nessun ostacolo per almeno 10 cm
- Sopra: Nessun ostacolo per almeno 10 cm
- Retro: Nessun ostacolo per almeno 15 cm
- Fondo: Libero ed in piano

Inoltre, mantenere il più possibile la circolazione dell'aria.

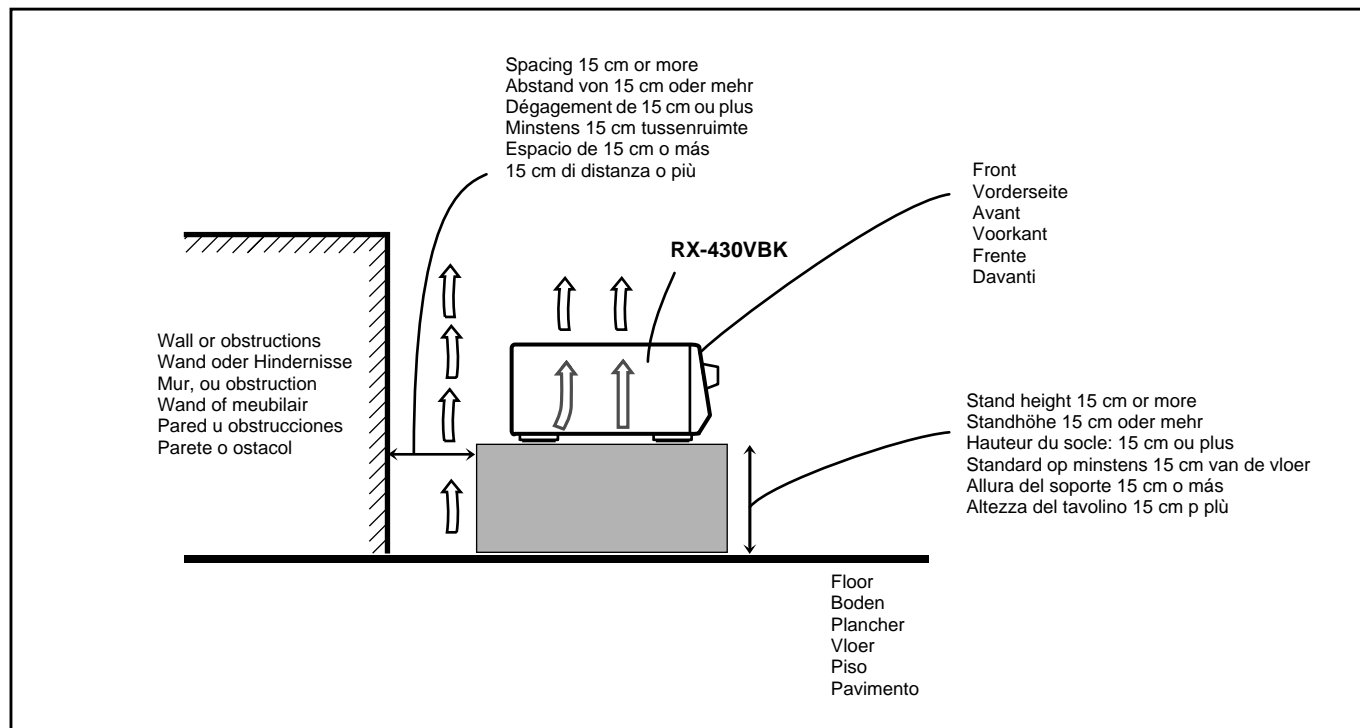

# Table of Contents

<b>Switches, Buttons and Controls</b> .....	<b>2</b>
<b>Getting Started</b> .....	<b>3</b>
Before Installation .....	3
Checking the Supplied Accessories .....	3
Connecting the FM and AM (MW/LW) Antennas .....	4
Connecting the Speakers .....	5
Connecting Audio/Video Components .....	7
Connecting Audio Components for the COMPU LINK-3 Remote Control System .....	8
Connecting the Power Cord .....	9
Putting Batteries in the Remote Control .....	9
<b>Basic Operations</b> .....	<b>10</b>
Turning the Power On and Off (Standby) .....	10
Selecting the Source to Play .....	10
Selecting the Front Speakers .....	11
Adjusting the Volume .....	11
Muting the Sound .....	11
Recording a Source .....	12
Listening with Headphones .....	12
<b>Basic Settings</b> .....	<b>13</b>
Adjusting the Front Speaker Output Balance .....	13
Listening at Low Volume (Loudness) .....	13
Using the Sleep Timer .....	13
Selecting the Center Speaker Size .....	14
<b>One Touch Operation</b> .....	<b>15</b>
About the One Touch Operation .....	15
Using the One Touch Operation .....	15
<b>Receiving Radio Broadcasts</b> .....	<b>16</b>
Tuning in Stations Manually .....	16
Using Preset Tuning .....	16
Selecting the FM Reception Mode .....	17
<b>Using the Preset SEA Modes</b> .....	<b>18</b>
Selecting Your Favorite SEA Mode .....	18
<b>Using the Surround Processor</b> .....	<b>20</b>
Using JVC's Hall Surround .....	20
Speaker Arrangement for Dolby Surround .....	22
Preparing for Dolby Surround .....	23
Using Dolby Surround .....	26
<b>COMPU LINK Remote Control System</b> .....	<b>27</b>
<b>Using the Remote Control</b> .....	<b>28</b>
<b>Troubleshooting</b> .....	<b>30</b>
<b>Specifications</b> .....	<b>31</b>

Become familiar with the buttons and controls on the receiver before use.

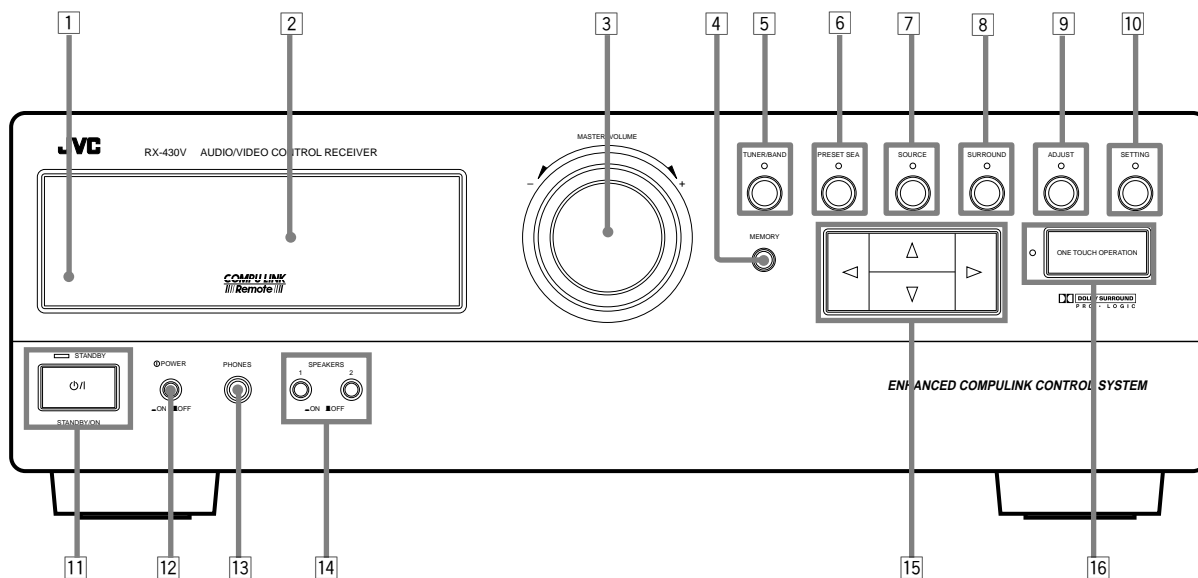

Refer to the pages in parentheses for details.

### Front Panel

- 1 Remote sensor
- 2 Display (10)
- 3 MASTER VOLUME control (11)
- 4 MEMORY button (16)
- 5 TUNER/BAND button and lamp (16, 17)
- 6 PRESET SEA button and lamp (18)
- 7 SOURCE button and lamp (10)
- 8 SURROUND button and lamp (20, 23, 26)
- 9 ADJUST button and lamp (21, 23)
- 10 SETTING button and lamp (13)
- 11 STANDBY/ON  $\odot$ /I button and STANDBY lamp (10)
- 12  $\odot$  POWER switch (9)
- 13 PHONES jack (12)
- 14 SPEAKERS 1/2 buttons (11)
- 15 Control  $\Delta$  /  $\nabla$  /  $\triangleleft$  /  $\triangleright$  buttons
- 16 ONE TOUCH OPERATION button and lamp (15)

### Remote Control

- 17 TV/VIDEO button (29)
- 18 CH (+/-) buttons (29)
- 19 CD-DISC button (28)
- 20 AUDIO CONTROL button (19, 21, 25, 26)
- 21 Source buttons (CD, TAPE, FM/AM, VCR, VIDEO, PHONO) (10, 28, 29)
- 22 VOLUME (+/-) buttons (11)
- 23  $\odot$ /I (Standby/On) buttons (TV, VCR, AUDIO) (10, 29)
- 24 10 keys/Audio control buttons (17, 19, 21, 25, 26, 28)
- 25 SEA ON/OFF button (19)
- 26 SURROUND ON/OFF button (21, 25, 26)
- 27 TV CONTROL buttons (TV, VOLUME (+/-)) (29)
- 28 ONE TOUCH OPERATION button (15)
- 29 Operating buttons for JVC audio/video components (28, 29)
- 30 MUTE button (11)

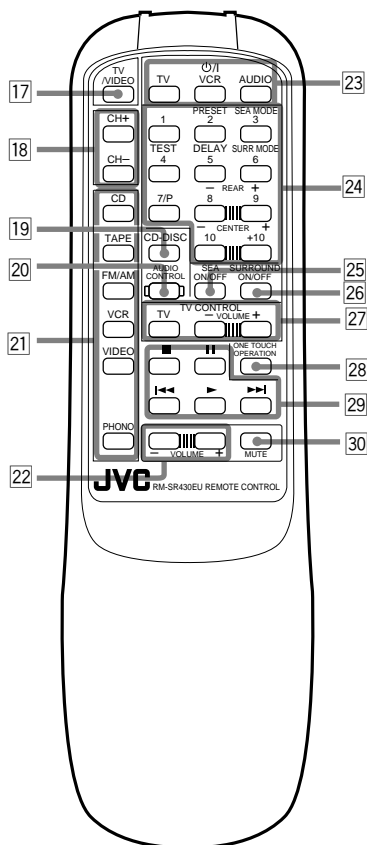

## Getting Started

---

This section explains how to connect stereo components and speakers to the receiver, and how to connect the power supply.

---

### Before Installation

---

#### General

- Be sure your hands are dry.
- Turn the power off to all components.
- Read the manuals supplied with the components you are going to connect.

#### Locations

- Install the receiver in a location that is level and protected from moisture.
- The temperature around the receiver must be between  $-5^{\circ}$  and  $35^{\circ}$  C ( $23^{\circ}$  and  $95^{\circ}$  F).
- Make sure there is good ventilation around the receiver. Poor ventilation could cause overheating and damage the receiver.

#### Handling the receiver

- Do not insert any metal object into the receiver.
  - Do not disassemble the receiver or remove screws, covers, or cabinet.
  - Do not expose the receiver to rain or moisture.
- 

### Checking the Supplied Accessories

---

Check to be sure you have all of the following items, which are supplied with the receiver. The number in the parentheses indicates quantity of the pieces supplied.

- Remote Control (1)
- Batteries (2)
- AM (MW/LW) Loop Antenna (1)
- FM Antenna (1)

If anything is missing, contact your dealer immediately.



## Connecting the FM and AM (MW/LW) Antennas

### FM Antenna Connections

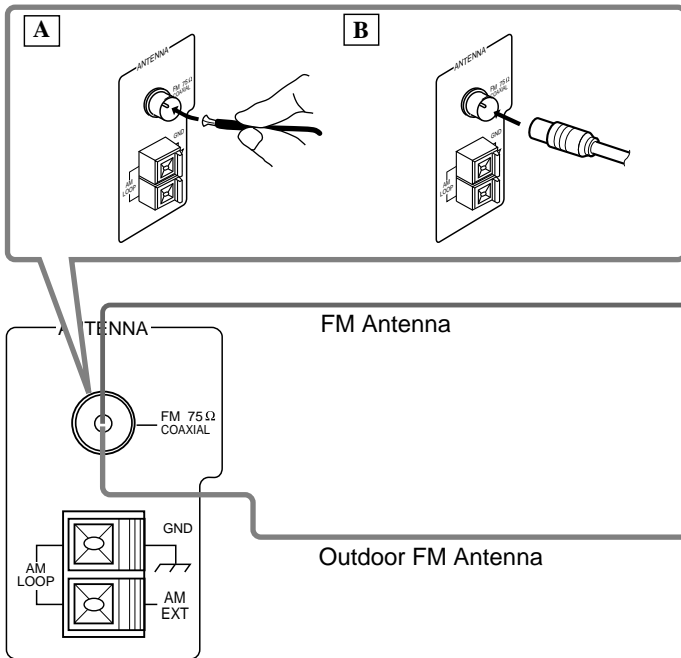

**A Using the Supplied FM Antenna**

The FM antenna provided can be connected to the FM 75-ohm COAXIAL terminal as temporary measure.

**B Using the Standard Type Connector (Not Supplied)**

A standard type connector (IEC or DIN45325) should be connected to the FM 75-ohm COAXIAL terminal.

**Note:** Make sure the antenna conductors do not touch any other terminals, connecting cords or power cord. This could cause poor reception.

Extend the supplied FM antenna horizontally.

If reception is poor, connect an outdoor FM antenna.

Before attaching a 75-ohm coaxial cable (the kind with a round wire going to the outdoor FM antenna), disconnect the supplied FM antenna.

### AM (MW/LW) Antenna Connections

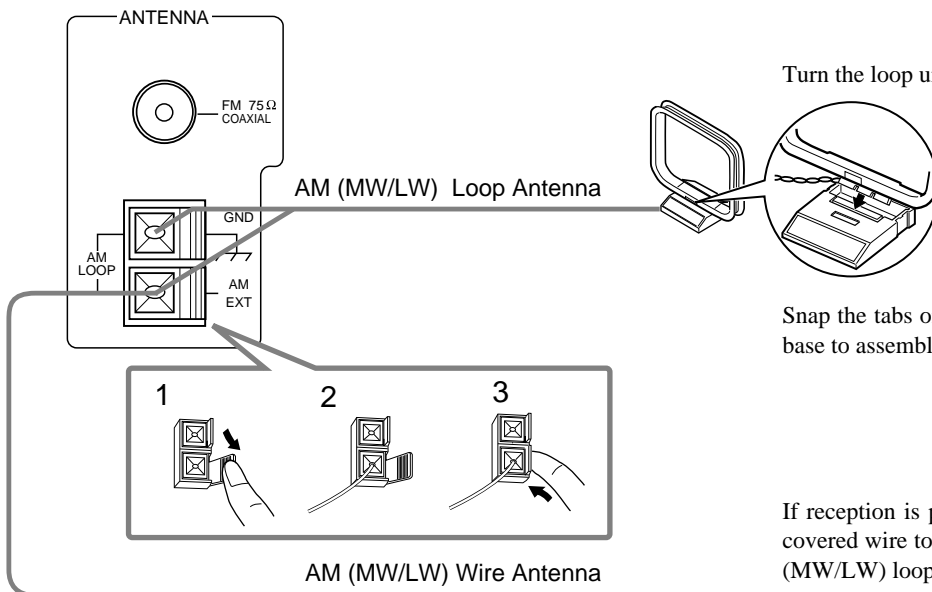

Turn the loop until you have the best reception.

Snap the tabs on the loop into the slots of the base to assemble the AM (MW/LW) loop.

If reception is poor, connect an outdoor single vinyl-covered wire to the AM EXT terminal. (Keep the AM (MW/LW) loop antenna connected.)

**Note :**

Make sure the antenna conductors do not touch any other terminals, connecting cords and power cord. This could cause poor reception.

## Connecting the Speakers

You can connect the following speakers:

- Two sets of front speakers to produce normal stereo sound
- One set of rear speakers to enjoy the surround effect
- One center speaker to produce more effective surround effect (to make human voices outstanding)
- One subwoofer to enhance the bass

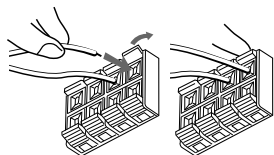
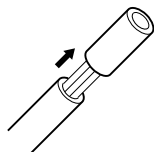

For each speaker (except for subwoofer), connect one end of the speaker signal cable (not supplied) to the speaker terminal on the rear panel and the other end to the speaker. (For connecting a subwoofer, see page 7).

1. Open each terminal.
2. Insert the end of the speaker signal cable as shown (be sure to remove the insulation at the end of each wire first).
3. Close the terminals to clamp the speaker signal cables firmly in place.
4. Connect the black (–) and red (+) terminals on the rear panel to the black (–) and red (+) terminals marked on the speakers.

**CAUTION:**  
When connecting speakers, use speakers with the same SPEAKER IMPEDANCE indicated by the speaker terminals.

### Connecting the front speakers

Connect the front speakers to the FRONT SPEAKERS terminals.

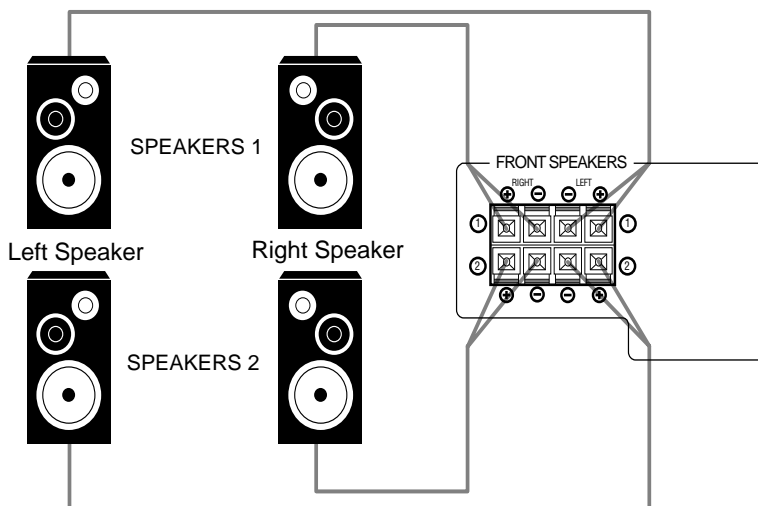

### Connecting the rear and center speakers

Connect rear speakers to the REAR SPEAKERS terminals and a center speaker to the CENTER SPEAKER terminals.

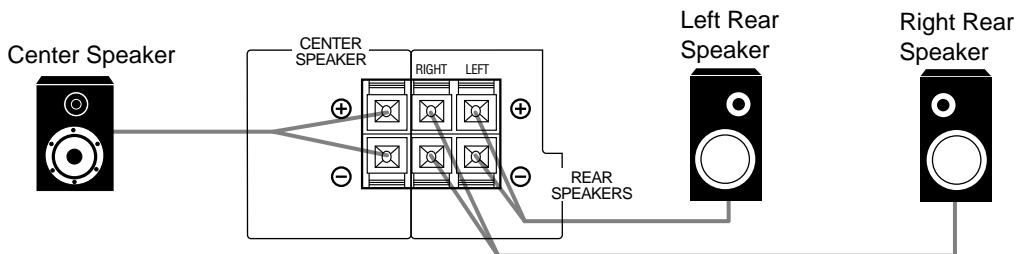

**Note:**  
When you connect rear speakers, make sure that both left and right speakers are connected; otherwise, no sound will come out of the rear speakers.

## About the speaker impedance of the speakers

### CAUTION:

When connecting speakers, use speakers with the same **SPEAKER IMPEDANCE** indicated by the speaker terminals.

### Notes:

- The required speaker impedance of the front speakers does not differ depending on whether both the **FRONT SPEAKERS ①** and **FRONT SPEAKERS ②** terminals are used or only one of them is used.
- The required speaker impedance of the front speakers differs depending on whether or not a center and/or rear speakers are connected at the same time. Since there are four possible speaker connections with the receiver, check which one fits your case and use the speaker with the impedance described below.

### CASE 1 When you connect only front speakers



Use front speakers with **4 — 16 ohm** impedance.

### CASE 2 When you connect front speakers and a center speaker

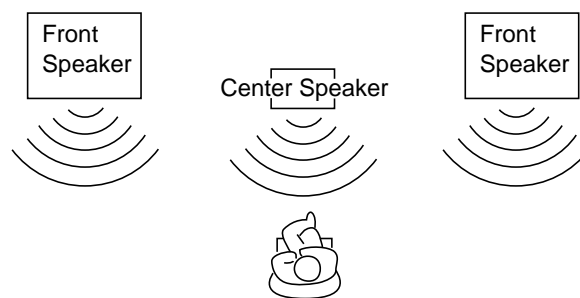

Use the following speakers;

- Front speakers: **8 — 16 ohm** impedance
- Center speaker: **8 — 16 ohm** impedance

### CASE 3 When you connect front and rear speakers

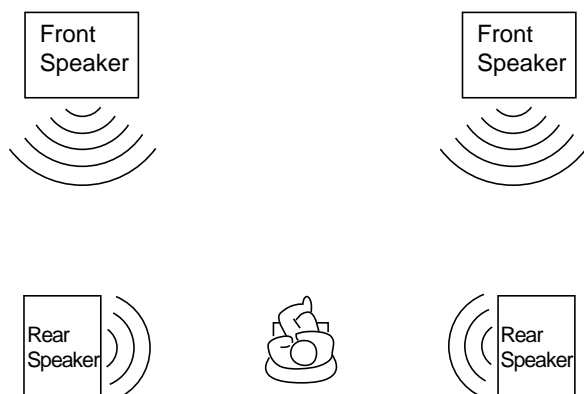

Use the following speakers;

- Front speakers: **8 — 16 ohm** impedance
- Rear speakers: **8 — 16 ohm** impedance

### CASE 4 When you connect front and rear speakers as well as a center speaker

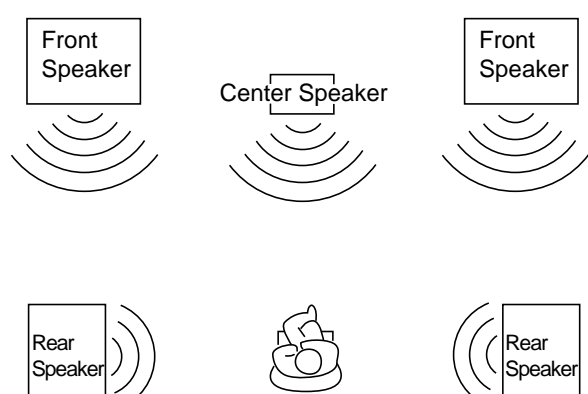

Use the following speakers;

- Front speakers: **8 — 16 ohm** impedance
- Rear speakers: **8 — 16 ohm** impedance
- Center speaker: **8 — 16 ohm** impedance

**Connecting the subwoofer speaker**

Connect the input jack of a powered subwoofer to the SUBWOOFER OUT jack on the rear panel, using a cable with RCA pin plugs.

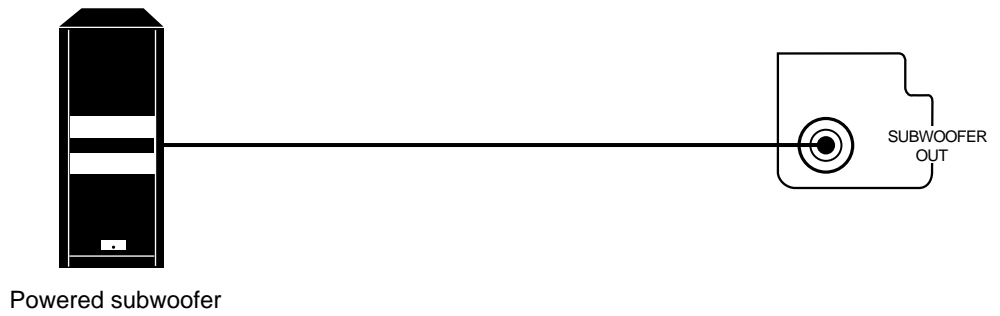

**Connecting Audio/Video Components**

You can connect the following components to the receiver using cables with RCA pin plugs.

Audio Components	Video Components
• Turntable	• VCR
• CD player	• Video disc player
• Cassette deck	• TV

**Note:**

Any turntables incorporating a small-output cartridge such as an MC (moving-coil type) must be connected to the receiver through a commercial head amplifier or step-up transformer. Direct connection may result in insufficient volume.

**Audio component connections**

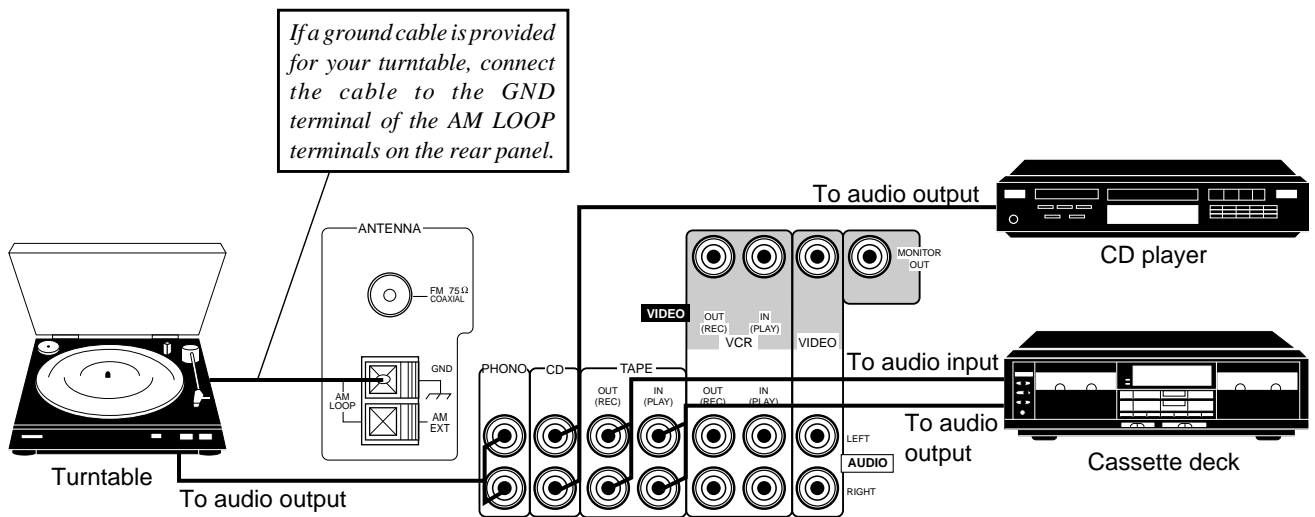

## Video component connections

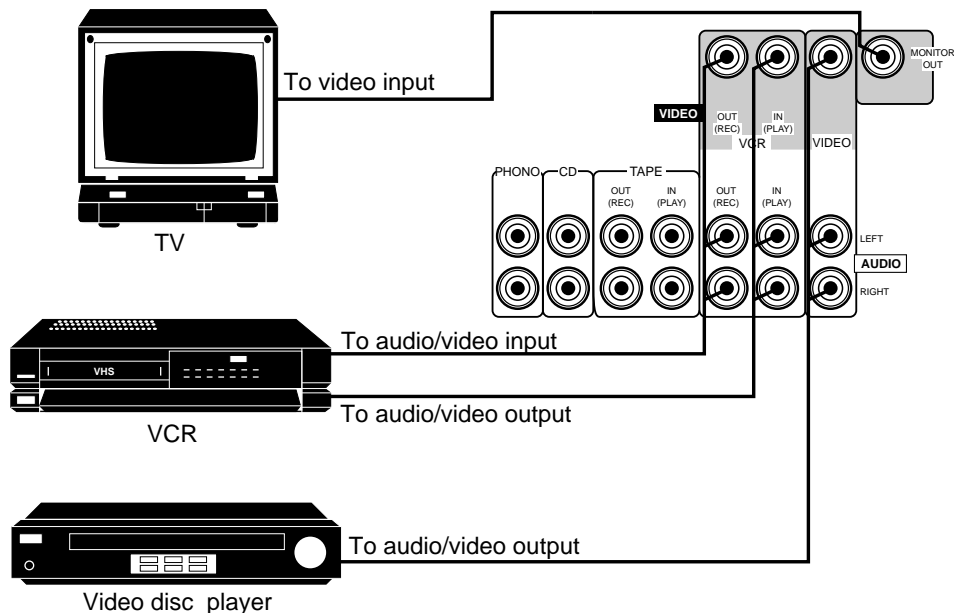

### CAUTION:

If you connect a sound-increasing device such as a graphic equalizer between the source components and the receiver, the sound output through the receiver may be distorted.

## Connecting Audio Components for the COMPU LINK-3 Remote Control System

The COMPU LINK-3 remote control system allows you to control other JVC audio components from the receiver or vice versa. To use this system, connect your JVC audio components and the receiver with the cable (monaural mini-plug) supplied with those components.

If your audio component has two COMPU LINK-3 SYNCHRO jacks, you can use either one.

If it has only one COMPU LINK-3 SYNCHRO jack, connect it so that it is the last item in the series of components (for example, the turntable and the CD player in the diagram below).

### Notes:

- The COMPU LINK-3 remote control system is the upgraded version of the COMPU LINK-1 and COMPU LINK-2. Even if your component has the COMPU LINK-1 or COMPU LINK-2 jacks, you can still connect it in the COMPU LINK-3 remote control system, but some functions may not work correctly.
- For more information about the COMPU LINK-3 (-1 and -2) remote control system, see page 27.

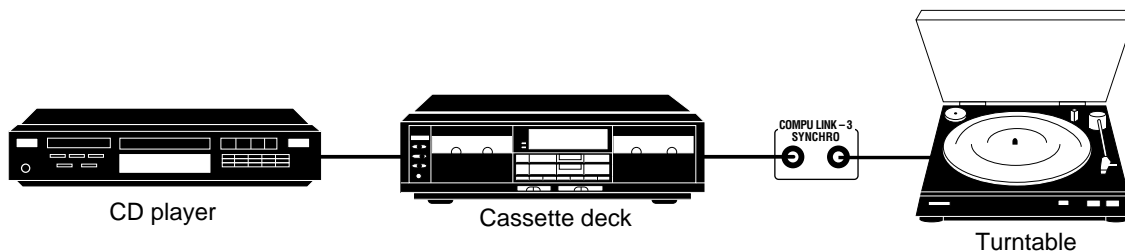

## Connecting the Power Cord



Before plugging the receiver into an AC outlet, make sure that all connections have been made.

### 1. Plug the power cord into an AC outlet.

### 2. Press POWER to set it in the ON position.





The STANDBY lamp lights up. A small amount of power is always consumed.

### To shut off the power completely:

Press  POWER to set it in the  OFF position.



Keep the power cord away from the connecting cables for the TV, VCR, and antenna. The power cord may cause noise or screen interference. We recommend that you use a coaxial cable to connect the antenna, since it is well-shielded against interference.

#### The difference between the POWER switch and the STANDBY/ON button

- The  POWER switch is the mains supply switch, allowing the receiver to connect to the mains supply. To shut off the power completely, press the  POWER switch to set it in the  OFF position.
- The STANDBY/ON  button is a functional on/off (standby) switch, and does not disconnect the receiver from the mains supply. A small amount of power is consumed even in standby mode for the receiver to accept signals from the remote control.

#### Note:

The preset settings such as preset channel and sound adjustment may be erased in the following cases:

- When you press  POWER to set it in the  OFF position.
- When you unplug the power cord.
- When a power failure occurs.

#### CAUTIONS:

- Do not touch the power cord with wet hands.
- Do not pull on the power cord to unplug the receiver. When unplugging the receiver, always grasp the plug itself so as not to damage the cord.

## Putting Batteries in the Remote Control

Before using the remote control, put the two supplied batteries in first. When using the remote control, aim the remote control directly at the remote sensor on the receiver.

### 1. On the back of the remote control, press down on the battery cover and slide it out.

### 2. Insert batteries. Make sure to observe the proper polarity: (+) to (+) and (-) to (-).

### 3. Slide the cover.

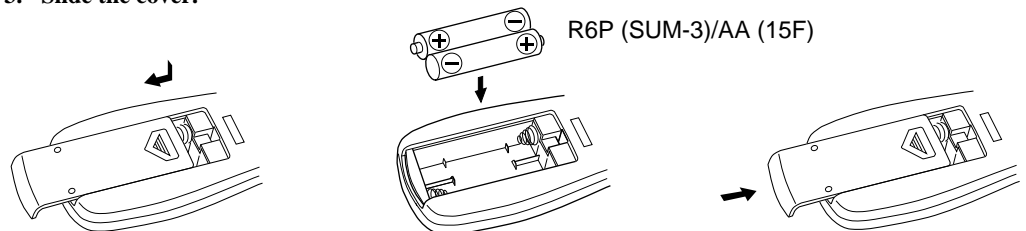

If the range or effectiveness of the remote control decreases, replace the batteries. Use two R6P (SUM-3)/AA (15F) type dry-cell batteries.

#### CAUTIONS:

Follow these precautions to avoid leaking or cracking cells:

- Place batteries in the remote control so they match the polarity indicated: (+) to (+) and (-) to (-).
- Use the correct type of batteries. Batteries that look similar may differ in voltage.
- Always replace both batteries at the same time.
- Do not expose batteries to heat or flame.

The following operations are commonly used when you play any sound source.

## Turning the Power On and Off (Standby)

### On the front panel:

To turn on the power, press STANDBY/ON  $\odot/\mid$ .

The STANDBY lamp goes off. The name of the current source (or station frequency) appears on the display.

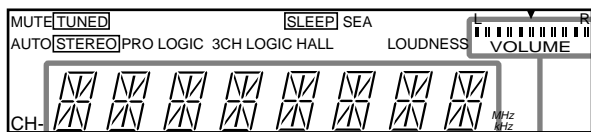
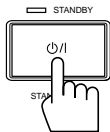

Current source name appears      Current volume level is shown here

To turn off the power (into standby mode), press STANDBY/ON  $\odot/\mid$  again.

The STANDBY lamp lights up.

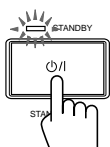

### From the remote control:

To turn on the power, press AUDIO.

The STANDBY lamp goes off. The name of the current source (or station frequency) appears on the display.

To turn off the power (into standby mode), press AUDIO again.

The STANDBY lamp lights up.

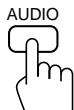

### Note:

Pressing STANDBY/ON  $\odot/\mid$  again turns off the power (into standby mode) and lights the STANDBY lamp. A small amount of power is consumed in standby mode. To turn the power off completely, press  $\odot$  POWER to set it in the  $\blacksquare$  OFF position on the front panel.

## Selecting the Source to Play

### On the front panel:

1. Press SOURCE so that Control  $\Delta/\nabla$  buttons work for selecting the source.

The lamp above the button lights up.

2. Press Control  $\Delta/\nabla$  until the source name you want appears on the display.

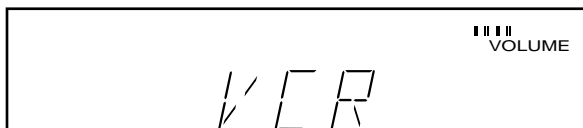
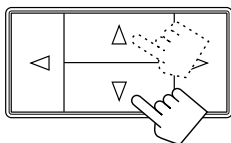

### From the remote control:

Press one of the source button directly.

- |        |  |
|--------|--|
| CD*    | Listen to the CD player.                                 |
| TAPE*  | Listen to the cassette deck connected to the TAPE jacks. |
| FM/AM* | Listen to an FM or AM (MW/LW) broadcast.                 |
| VCR    | View the video component connected to the VCR jacks.     |
| VIDEO  | View the video component connected to the VIDEO jacks.   |
| PHONO* | Listen to a record.                                      |

### Note:

\* When you press one of the source buttons on the remote control marked above with an asterisk, the receiver automatically turns on.



## Selecting the Front Speakers

When you have connected two sets of front speakers, you can select which to use. Pressing SPEAKERS 1 or SPEAKERS 2 activates the respective set of speakers.

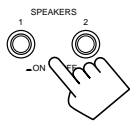

**To use the set of speakers connected to the FRONT SPEAKERS ① terminals**, press SPEAKERS 1 to set it in the **ON** position, and press SPEAKERS 2 to set it in the **OFF** position.

**To use the set of speakers connected to the FRONT SPEAKERS ② terminals**, press SPEAKERS 2 to set it in the **ON** position, and press SPEAKERS 1 to set it in the **OFF** position.

**To use both sets of speakers**, press both SPEAKERS 1 and 2 to set them in the **ON** position.

**To use neither set of speakers**, press both SPEAKERS 1 and 2 to set them in the **OFF** position.

**Note:**

When only one set of the front speakers is connected to either the FRONT SPEAKERS ① or ② terminals, do not press both SPEAKERS 1 and 2 to set them in the **ON** position. If you do, no sound comes out of the front speakers.

## Adjusting the Volume

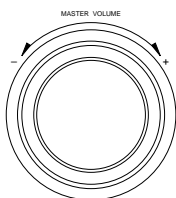

On the front panel

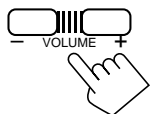

From the remote control

**On the front panel:**

**To increase the volume**, turn MASTER VOLUME clockwise.

**To decrease the volume**, turn it counterclockwise.

When you turn MASTER VOLUME **rapidly**, the volume level also changes **rapidly**.  
When you turn MASTER VOLUME **slowly**, the volume level also changes **slowly**.

**From the remote control:**

**To increase the volume**, press VOLUME +.

**To decrease the volume**, press VOLUME -.

**CAUTION:**  
Always set the volume to the minimum before starting any source. If the volume is set at its high level, the sudden blast of sound energy can permanently damage your hearing and/or ruin your speakers.

## Muting the Sound



**From the remote control only:**

Press MUTE to mute the sound through all speakers and headphones connected.

“MUTE” appears on the display and the volume turns off.

To restore the sound, press MUTE again so that “OFF” appears on the display.

Turn MASTER VOLUME or pressing VOLUME +/- also restores the sound at the previous volume level.



---

## Recording a Source

---

You can record any source playing through the receiver to a cassette deck connected to the TAPE jacks and VCR connected to the VCR jacks at the same time.

While recording, you can listen to the selected sound source at whatever sound level you like, without affecting the sound levels of the recording.

**Note:**

*The output volume level, preset SEA, and surround modes cannot affect the recording.*

---

## Listening with Headphones

---

A standard pair of headphones can be connected to the PHONES jack on the front panel. **Be sure to turn down the volume before connecting or putting on headphones, as high volume can damage both the headphones and your hearing.**

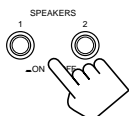

**To listen with only headphones**

Press both SPEAKERS 1 and 2 to set them in the **■** OFF position.

## Basic Settings

Some of the following settings are required after connecting and positioning your speakers in your listening room, while others will make operations easier.

### Adjusting the Front Speaker Output Balance

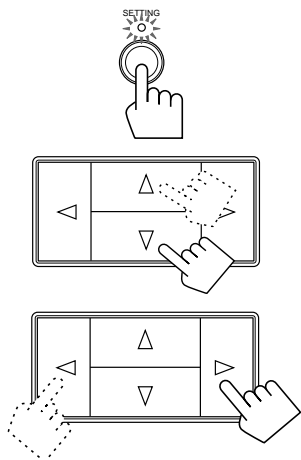

If the sounds you hear from the front right and left speakers are unequal, you can adjust the speaker output balance.

#### On the front panel only:

1. Press **SETTING** so that the Control  $\Delta$  /  $\nabla$  /  $\triangleleft$  /  $\triangleright$  buttons work for adjusting the balance.  
The lamp above the button lights up.
2. Press Control  $\Delta$  /  $\nabla$  until “BALANCE” appears on the display.
3. Press Control  $\triangleleft$  /  $\triangleright$  to adjust the balance.
  - Pressing Control  $\triangleleft$  decreases the right channel output.
  - Pressing Control  $\triangleright$  decreases the left channel output.

### Listening at Low Volume (Loudness)

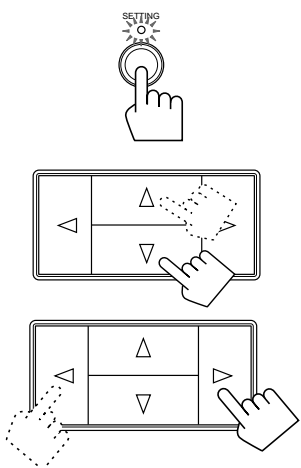

Human ears are not sensitive to bass at low volume. To compensate for this, the loudness function automatically boosts the bass level as you lower the volume.

#### On the front panel only:

1. Press **SETTING** so that the Control  $\Delta$  /  $\nabla$  /  $\triangleleft$  /  $\triangleright$  buttons work for setting the loudness.  
The lamp above the button lights up.
2. Press Control  $\Delta$  /  $\nabla$  until “LOUDNESS” appears on the display.
3. Press Control  $\triangleleft$  /  $\triangleright$  to set the loudness function to “ON” or “OFF.”
  - Select “ON” to activate the loudness function.  
The LOUDNESS indicator lights up on the display.
  - Select “OFF” to cancel it.  
The indicator goes off.

### Using the Sleep Timer

Using the Sleep Timer, you can fall asleep to music and know the receiver will turn off by itself rather than play all night.

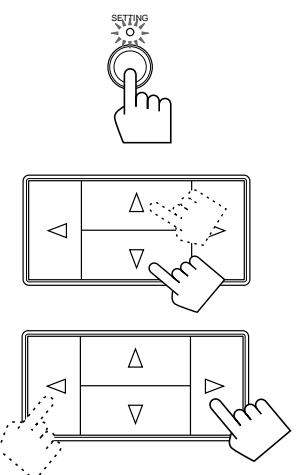

#### On the front panel only:

1. Press **SETTING** so that the Control  $\Delta$  /  $\nabla$  /  $\triangleleft$  /  $\triangleright$  buttons work for setting the Sleep Timer.  
The lamp above the button lights up.
2. Press Control  $\Delta$  /  $\nabla$  until “<SLEEP>” appears on the display.
3. Press Control  $\triangleleft$  /  $\triangleright$  to set the shut-off time.

Each time you press the button, the shut-off time on the display changes as follows, and the SLEEP indicator lights up on the display.

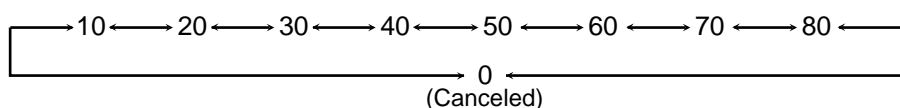

When the shut-off time comes, the receiver turns off (into standby mode) automatically.

#### To check or change the time remaining until the shut-off time:

1. Press **SETTING** if necessary, so that the Control  $\Delta / \nabla / \triangleleft / \triangleright$  buttons work for setting the Sleep Timer.
2. Press Control  $\Delta / \nabla$  if necessary, until "<SLEEP>" appears on the display.
3. Press Control  $\triangleleft / \triangleright$ .

The remaining time until the shut-off time appears in minutes.

- To change the shut-off time, press Control  $\triangleleft / \triangleright$  repeatedly.

**To cancel the Sleep Timer**, press Control  $\triangleleft / \triangleright$  repeatedly in step 3 above until "0" appears on the display. (The SLEEP indicator goes off.)

Turning off the power (into standby mode) also cancels the Sleep Timer.

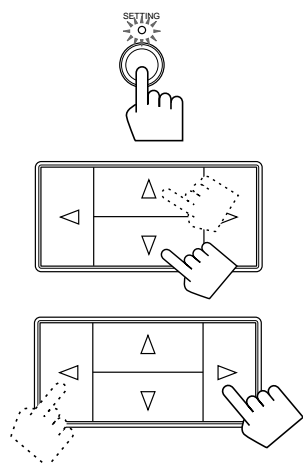

## Selecting the Center Speaker Size

You can register the information about the center speaker after all connections are completed.

If you do this registration first, you do not have to adjust the center speaker mode when you want to activate the surround sound.

However, to register the information, first you have to set the surround mode either to "PROLOGIC" or "3CHLOGIC." (You cannot select the center speaker size when the surround mode is "OFF" or "HALL.")

#### On the front panel only:

1. Press **SURROUND** so that the Control  $\Delta / \nabla$  buttons work for selecting the surround mode.

The lamp above the button lights up.

2. Press Control  $\Delta / \nabla$  until "PROLOGIC" or "3CHLOGIC" appears on the display.

The indicator of the selected mode also lights up on the display.

3. Press **SETTING** so that the Control  $\Delta / \nabla / \triangleleft / \triangleright$  buttons work for selecting the center speaker size.

The lamp above the button lights up.

4. Press Control  $\Delta / \nabla$  until "CNTR SPK" (Center Speaker) appears on the display.

5. Press Control  $\triangleleft / \triangleright$  to select the appropriate item about your center speaker.

Each time you press the button, the display changes to show the following:

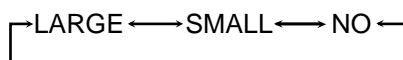

<b>LARGE</b>	Select this mode when the size of the center speaker is the same as that of the front speakers.
<b>SMALL</b>	Select this mode when the size of the center speaker is smaller than that of the front speakers.
<b>NO</b>	Select this mode when you do not use a center speaker. (This mode cannot be selected when you select "3CHLOGIC.")

#### Note:

This "center speaker size" setting is so related to the center mode setting for the Dolby Surround that changing this setting affects and changes the center mode to a relevant mode, and vice versa.

For example;

- If you select "LARGE," the center mode is automatically set to "WIDE," and vice versa.
- If you select "SMALL," the center mode is automatically set to "NORMAL," and vice versa.
- If you select "NO," the center mode is automatically set to "PHANTOM" for PRO LOGIC, and vice versa.

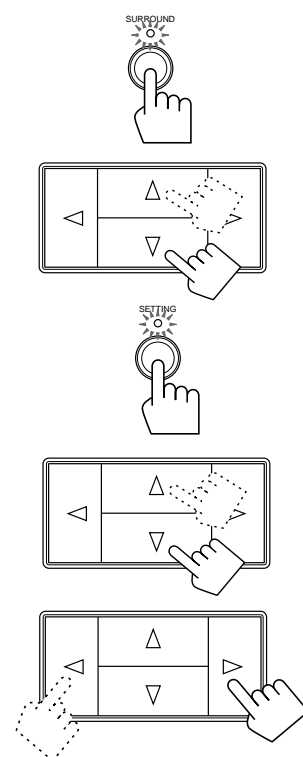

## One Touch Operation

This receiver can memorize the optimum sound setting for each playing source.

### About the One Touch Operation

JVC's One Touch Operation function is used to assign and store different sound settings for each different playing source. By using this function, you do not have to change the settings every time you change the source. The stored settings for the newly selected source are automatically recalled.

The following can be stored for each source:

- Volume level (see page 11)
- Balance (see page 13)
- Loudness (see page 13)
- Preset SEA modes (see page 18)
- Surround mode settings (see page 20)

**Note:**

*If the source is FM or AM (MW/LW), the One Touch Operation function works only when preset channels from 1 — 20 are turned in. You can assign a different setting for each preset channel.*

### Using the One Touch Operation

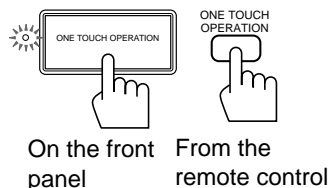

**To store the sound settings:**

**1. Press ONE TOUCH OPERATION.**

The ONE TOUCH OPERATION lamp lights up, then the previously memorized settings are recalled and appear on the display in turn.

**2. Adjust the sound using the functions listed above.**

The newly adjusted settings are memorized.

**To recall the sound settings:**

With the ONE TOUCH OPERATION lamp lit, the settings for the currently selected source is recalled, and appears on the display when the source is selected.

**To cancel the One Touch Operation function:**

Press ONE TOUCH OPERATION so that the lamp goes off. (Even though the One Touch Operation function is canceled, the recalled sound effects remain active.)

You can browse through all the stations or use the preset function to go immediately to a particular station.

## Tuning in Stations Manually

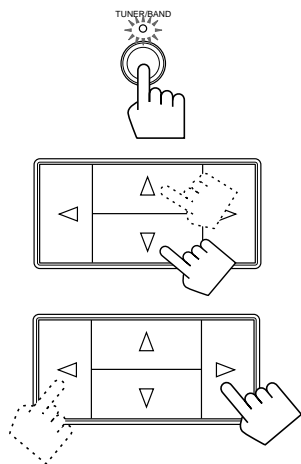

### On the front panel only:

1. Press TUNER/BAND so that the Control  $\Delta$  /  $\nabla$  /  $\triangleleft$  /  $\triangleright$  buttons work for tuner settings. The indicator above the button lights up.
2. Press Control  $\Delta$  /  $\nabla$  until “<FM AM>” appears on the display.
3. Press Control  $\triangleleft$  /  $\triangleright$  to select the band. Each time you press the button, the band alternates between FM and AM (MW/LW).
4. Press Control  $\Delta$  /  $\nabla$  until “-TUNING+” appears on the display.
5. Press Control  $\triangleleft$  /  $\triangleright$  until you find the frequency you want.
  - Pressing Control  $\triangleleft$  decreases the frequency.
  - Pressing Control  $\triangleright$  increases the frequency.

### Notes:

- When you hold down Control  $\triangleleft$  /  $\triangleright$  in step 5, the frequency keeps changing until you press Control  $\triangleleft$  /  $\triangleright$  again or a station is tuned in.
- When a station of sufficient signal strength is tuned in, the TUNED indicator lights up on the display.
- When an FM stereo program is received, the STEREO indicator also lights up.

## Using Preset Tuning

Once a station is assigned to a channel number, the station can be quickly tuned. You can preset up to 40 stations at random.

### Storing the preset stations

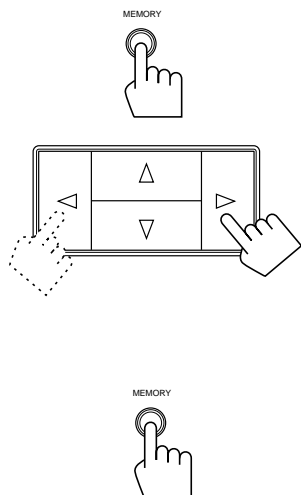

### On the front panel only:

1. Tune in the station you want to preset (see above). If you want to store the FM reception mode for this station, select the FM reception mode you want. See page 17 for details.
2. Press MEMORY. “CH-” appears and the channel number position starts flashing on the display for about 5 seconds.
3. Press Control  $\triangleleft$  /  $\triangleright$  to select a channel number while the channel number position is flashing.
  - Pressing Control  $\triangleleft$  decreases the number.
  - Pressing Control  $\triangleright$  increases the number.

### Note:

You can press 10 keys on the remote control to select a channel number in this step if you have pressed FM/AM prior to starting this preset procedures.

For channel number 5, press 5. For channel number 15, press +10 then 5.

For channel number 20, press +10 then 10. For channel number 30, press +10, +10 then 10.

4. Press MEMORY again while the selected channel number is flashing on the display. The selected channel number stops flashing. The station is assigned to the selected channel number.
5. Repeat steps 1 to 4 until you store all the stations you want.

**To cancel a stored preset station**

Storing a new station on a used number erases the previously stored one.

**CAUTION:**  
 The preset channels may be erased in the following cases:

- When you press POWER to set it in the OFF position.
- When you unplug the power cord.
- When a power failure occurs.

**Tuning in a Preset Station**

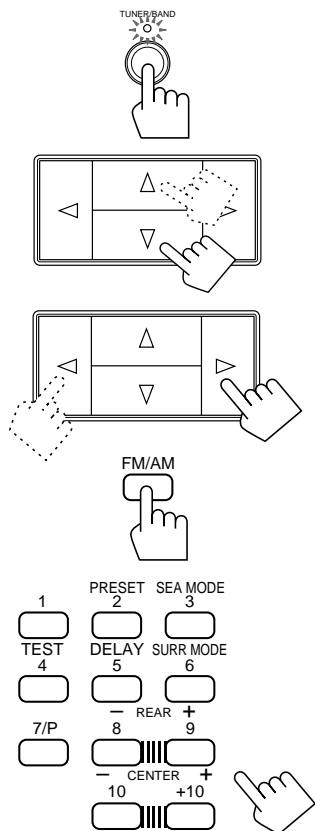

**On the front panel:**

1. Press TUNER/BAND so that the Control / / / buttons work for tuner settings. The lamp above the button lights up.
2. Press Control / until “-PRESET+” appears on the display.
3. Press Control / to select a preset channel. Each time you press the button, the preset channels change.
  - Pressing Control changes preset channel in decreasing order.
  - Pressing Control changes preset channels in increasing order.

**From the remote control:**

1. Press FM/AM. The last received station of the last selected band is tuned in. Each time you press the button, the band alternates between FM and AM (MW/LW).
2. Press 10 keys to select a preset channel number. For channel number 5, press 5. For channel number 15, press +10 then 5. For channel number 20, press +10 then 10. For channel number 30, press +10, +10 then 10.

**Selecting the FM Reception Mode**

You can change the FM reception mode while receiving an FM broadcast.

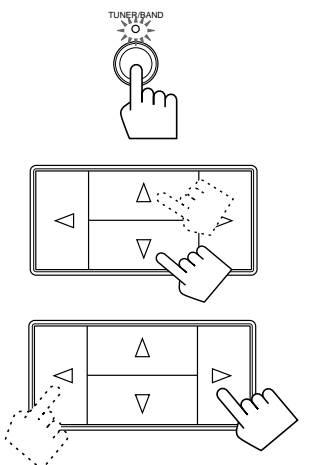

**On the front panel only:**

1. Press TUNER/BAND so that the Control / / / buttons work for tuner settings. The lamp above the button lights up.
2. Press Control / until “FM MODE” appears on the display.
3. Press Control / to select either “FM AUTO” or “FM MONO.”
  - Normally select “FM AUTO.”
  - When an FM stereo broadcast is hard to receive or noisy, select “FM MONO.”

<b>FM AUTO</b>	When a program is broadcast in stereo, you will hear stereo sound; when in monaural, you will hear monaural sounds. This mode is also useful to suppress static noise between stations. The MUTE AUTO indicator lights up on the display.
<b>FM MONO</b>	Reception will be improved although you will lose the stereo effect. In this mode, you will hear noise while tuning into the stations. The MUTE AUTO indicator goes off on the display.

**Note:**  
 You can store the FM reception mode for each preset station.

## Using the Preset SEA Modes

The preset SEA (Sound Effect Amplifier) modes give you control over the way your music sounds.

**Note:**

The preset SEA mode cannot be used for recording.

### Selecting Your Favorite SEA Mode

**On the front panel:**

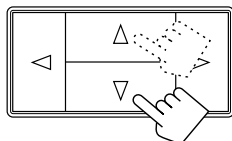

1. Press **PRESET SEA** so that the Control  $\Delta / \nabla / \triangleleft / \triangleright$  buttons work for preset SEA setting. The lamp above the button lights up.

2. Press Control  $\Delta / \nabla$  until the mode you want appears on the display. The SEA indicator also lights up on the display. Each time you press the button, the preset SEA modes change as follows:

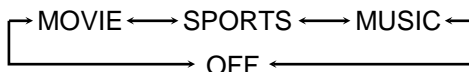

**Note:**

When you turn on the preset SEA mode, the mode and its effect level previously selected is recalled at first.

3. Press Control  $\triangleleft / \triangleright$  to select the effect level. Each time you press the button, the effect level changes as follows:

**When "MOVIE" is selected:**

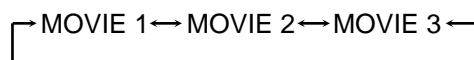

**When "SPORTS" is selected:**



**When "MUSIC" is selected:**

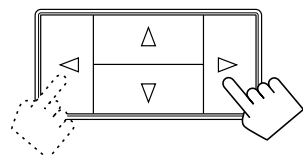
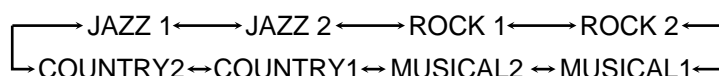

<b>MOVIE</b>	Adds breadth to sounds so you feel like you are in a movie theater.
<b>SPORTS</b>	Makes sound exciting.
<b>MUSIC</b>	Select one of the modes below: <b>JAZZ:</b> Gives a feeling of a live atmosphere. Good for acoustic music. <b>ROCK:</b> Gives a heavy sound. Both high and low frequencies are boosted. <b>MUSICAL:</b> Enhances the mid-frequency range, which the human voice is mostly made up of. <b>COUNTRY:</b> Enhance the high-frequency range so that instruments such the violin and banjo are emphasized.
<b>OFF</b>	No preset SEA mode is applied. (See below)

**To cancel the preset SEA mode,** select "OFF" in step 2 above. The SEA indicator goes off from the display.

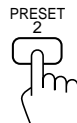
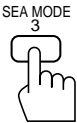

**From the remote control:**

- 1. Press SEA ON/OFF so that the SEA indicator lights up on the display.

The previously selected mode is recalled (at its previous effect level) and is shown on the display. Each time you press the button, the preset SEA mode turns on and off.

**Note:**

When selecting the preset SEA mode, the display will show the current effect level of the preset SEA mode selected.

- 2. Press AUDIO CONTROL so that 10 keys work for adjusting the sound.

- 3. Press SEA MODE until the mode you want appears on the display.

Each time you press the button, the three preset SEA modes change as follows:

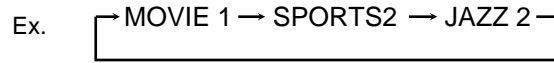

- 4. Press PRESET to select the effect level.

Each time you press the button, the effect level changes as follows:

**When "MOVIE" is selected:**

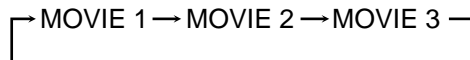

**When "SPORTS" is selected:**



**When "MUSIC" is selected:**

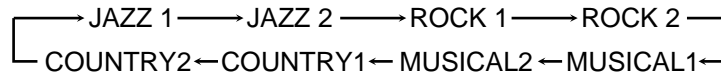

To cancel the preset SEA mode, press SEA ON/OFF so that the SEA indicator goes off from the display.

Each time you press the button, the preset SEA mode turns on and off.



## Using the Surround Processor

The built-in surround processor provides three types of surround programs — Dolby Pro Logic, Dolby 3-Channel Logic, and JVC's Hall Surround.

### What is surround?

The sound heard in a concert hall or a movie theater consists of direct sound and indirect sound: early reflections and reflections from behind. The reflected sounds are always delayed by the distances of the ceiling and walls from the listener. These reflections are some of the most important elements of the acoustic surround.

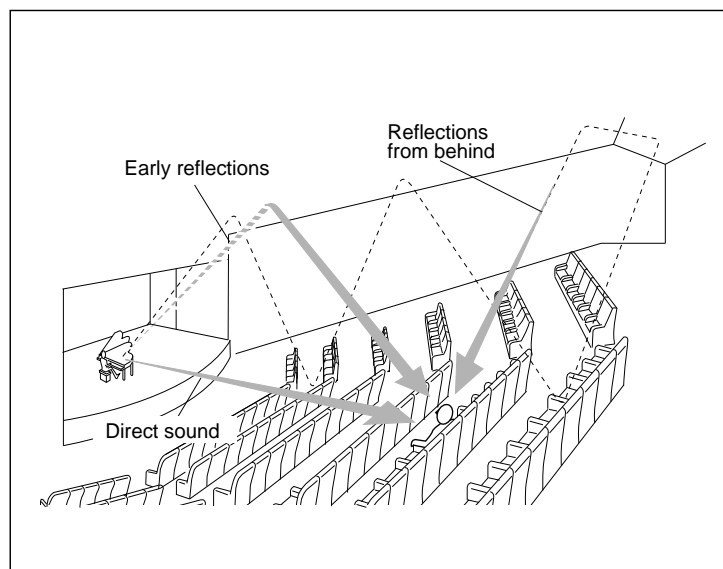

### On JVC's Hall Surround

In order to reproduce a more realistic sound field in your listening room while playing an ordinary stereo source, JVC's Hall Surround has been designed to give you clear vocals and to create the feeling of a concert hall. The sound is reproduced through the front speakers and rear speakers.

### On Dolby Surround

Dolby Surround has been also developed to reproduce the important elements of the acoustic surround at home.

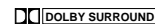
To watch the soundtracks of video software bearing the mark  \* which includes the same encoded surround information as found in Dolby Stereo films, the receiver can provide you with 2 Dolby Surround programs (Dolby Pro Logic and Dolby 3ch Logic).

**Dolby Pro Logic:** Select this mode when the optional rear speakers are connected (as well as a center speaker).

**Dolby 3ch Logic:** Select this mode when a center speaker is connected without rear speakers.

### Notes:

- The surround processor has no effect on monaural sources.
- The surround processor cannot be used for recording.

\* Manufactured under license from Dolby Laboratories Licensing Corporation. "Dolby," the double-D symbol, and "Pro Logic" are trademarks of Dolby Laboratories Licensing Corporation.

## Using JVC's Hall Surround

You need to connect one set of rear speakers to obtain the full effect. Once you have adjusted the Hall Surround, the receiver memorizes the settings.

### On the front panel:

1. Press SURROUND so that the Control  $\Delta$  /  $\nabla$  /  $\triangleleft$  /  $\triangleright$  buttons work for selecting the surround modes.

The lamp above the button lights up.

2. Press Control  $\Delta$  /  $\nabla$  until "HALL" appears on the display.

The HALL indicator also lights up on the display.

Each time you press the button, the surround modes change as follows:

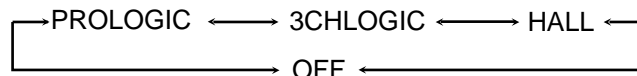

The indicator of the selected surround mode lights up in turn as you select the surround modes.

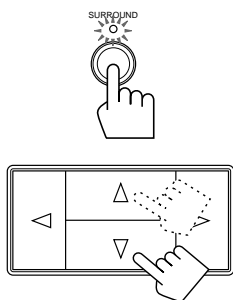

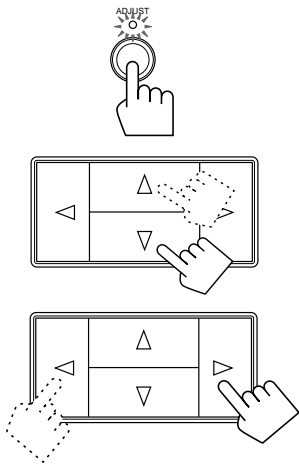

3. Press **ADJUST** so that the Control  $\Delta / \nabla / \triangleleft / \triangleright$  buttons work for surround settings.  
The lamp above the button lights up.
4. Press Control  $\Delta / \nabla$  until “- REAR +” appears on the display.
5. Press Control  $\triangleleft / \triangleright$  to adjust the rear speaker output level.
  - Pressing Control  $\triangleleft$  decreases the output level up to -10 dB.
  - Pressing Control  $\triangleright$  increases the output level up to +10 dB.
6. Press Control  $\Delta / \nabla$  until “-DELAY +” appears on the display.
7. Press Control  $\triangleleft / \triangleright$  to adjust the delay time of the rear speaker output.  
Each time you press the button, the delay time changes as follows:



<b>DELAY 1</b>	Select this when the distance from you to your rear speakers is greater than that to the front speakers.
<b>DELAY 2</b>	Select this when the distance from you to your rear speakers is almost equal to that to the front speakers.
<b>DELAY 3</b>	Select this when the distance from you to your rear speakers is less than that to the front speakers.

To cancel the **Hall surround**, select “OFF” in step 2. The HALL indicator goes off.



**From the remote control:**

1. Press **SURROUND ON/OFF** so that one of the surround mode indicators (**PRO LOGIC, 3CH LOGIC, HALL**) lights up on the display.  
The previous mode is recalled (at its previous settings) and is shown on the display.  
Each time you press the button, the surround mode turns on and off.
2. Press **AUDIO CONTROL** so that 10 keys work for adjusting the sound.
3. Press **SURR MODE** until “**HALL**” appears on the display.  
The HALL indicator also lights up on the display.  
Each time you press the button, the surround modes change as follows:

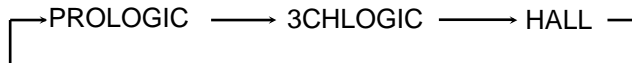

The indicator of the selected surround mode lights up in turn as you select the surround modes.

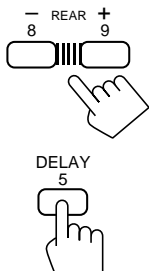

4. Press **REAR +/-** to adjust the rear speaker output level.
  - Pressing REAR - decreases the output level up to -10 dB.
  - Pressing REAR + increases the output level up to +10 dB.
5. Press **DELAY** to adjust the delay time.  
Each time you press the button, the delay time changes as follows:



To cancel the **Hall Surround**, press SURROUND ON/OFF so that the HALL indicator goes off.  
Each time you press the button, the surround mode turns on and off.

The following illustrations show how to obtain the optimum sound environment for various Dolby Surround settings. Try to find the speaker direction and location to create the optimum sound field.

### CASE 1 When you have added a center speaker and rear speakers

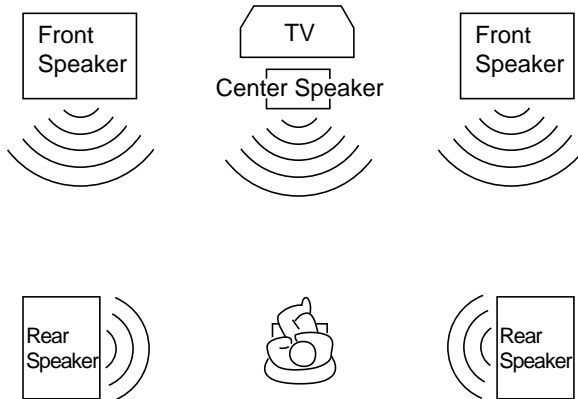

**In this case:**

1. Select "PROLOGIC."
2. Select "NORMAL" or "WIDE" for center mode.

See pages 23 to 25 for more details.

### CASE 2 When you have added rear speakers (without a center speaker)

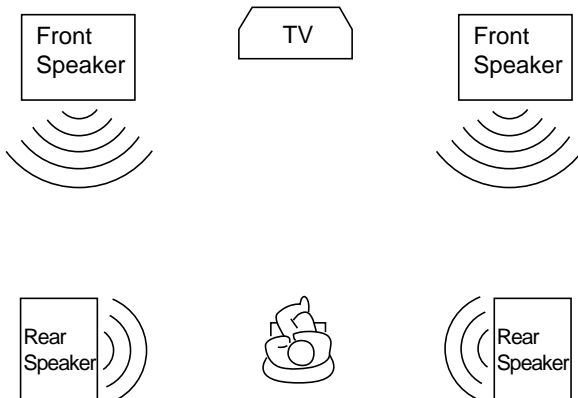

**In this case:**

1. Select "PROLOGIC."
2. Select "PHANTOM" for center mode.

See pages 23 to 25 for more details.

### CASE 3 When you have added a center speaker (without rear speakers)

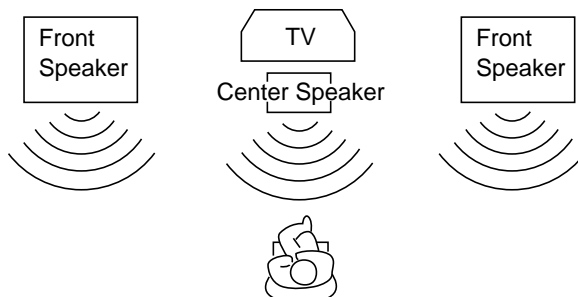

**In this case:**

1. Select "3CHLOGIC."
2. Select "NORMAL" or "WIDE" for center mode.

See pages 23 to 25 for more details.

## Preparing for Dolby Surround

The receiver memorizes two sets of Dolby Surround adjustments; one for Pro Logic and the other for 3ch Logic.

### On the front panel:

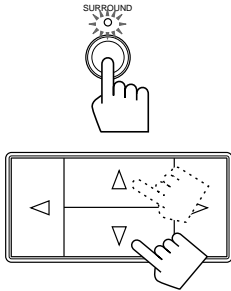

1. Press SURROUND so that the Control  $\Delta$  /  $\nabla$  buttons work for selecting the surround modes.

The lamp above the button lights up.

2. Press Control  $\Delta$  /  $\nabla$  until "PROLOGIC" or "3CHLOGIC" whichever you want appears on the display.

The PRO LOGIC or 3CH LOGIC indicator also lights up.

Each time you press the button, the surround modes change as follows:

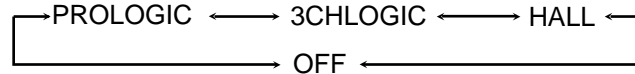

The indicator of the selected surround mode lights up in turn as you select the surround modes.

<b>PROLOGIC</b>	Select this mode when you use a center speaker and rear speakers.
<b>3CHLOGIC</b>	Select this mode when you use a center speaker without rear speakers.
<b>HALL</b>	This is JVC's original surround mode, and is different from Dolby Surround. To use this, see page 20.
<b>OFF</b>	Select this to turn off the surround mode.



3. Press ADJUST so that the Control  $\Delta$  /  $\nabla$  /  $\triangleleft$  /  $\triangleright$  buttons work for adjusting the selected surround mode.

The lamp above the button lights up.

4. Press Control  $\Delta$  /  $\nabla$  until "CNT MODE" (Center Mode) appears on the display.

5. Press Control  $\triangleleft$  /  $\triangleright$  to select the center mode.

Each time you press the button, the center modes change as follows:

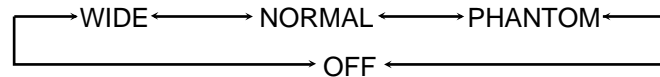

<b>WIDE</b>	Select this mode when the center speaker can reproduce the bass better than the front speakers. All signals of the center channel are output through the center speaker.
<b>NORMAL</b>	Select this mode when the center speaker cannot reproduce the bass better than the front speakers. The bass portions of the center channel signals are output through the front speakers.
<b>PHANTOM</b>	Select this mode when you do not use a center speaker. The center speaker channel signals are output through the front speakers.
<b>OFF</b>	Select this mode to turn off the center speaker channel.

### Notes:

- If you have already set the center speaker size following the procedure described on page 14, you do not have to select the center mode in this procedure.
- When you have selected "3CHLOGIC," you cannot select "PHANTOM."

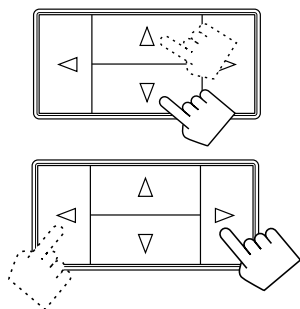

6. Press Control  $\Delta / \nabla$  until “-DELAY +” appears on the display.

7. Press Control  $\triangleleft / \triangleright$  to adjust the delay time of the rear speaker output.

Each time you press the button, the delay time changes as follows:



<b>DELAY 1</b>	Select this when the distance from you to your rear speakers is greater than that to the front speakers.
<b>DELAY 2</b>	Select this when the distance from you to your rear speakers is almost equal to that to the front speakers.
<b>DELAY 3</b>	Select this when the distance from you to your rear speakers is less than that to the front speakers.

**Note:**

When you have selected “3CHLOGIC,” you cannot adjust the delay time.

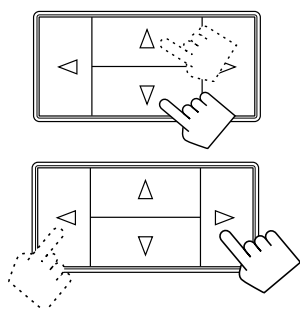

8. Press Control  $\Delta / \nabla$  until “TEST” appears on the display, then press Control  $\triangleleft / \triangleright$  to start checking the speaker output balance.

“TEST” starts flashing on the display, and a test tone comes out of the speakers in the following order:

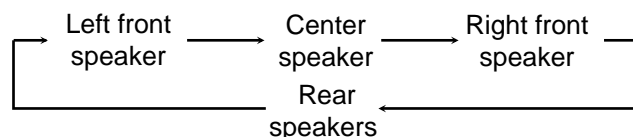

**Notes:**

- No test tone comes out of the rear speakers when you have selected “3CHLOGIC.”
- No test tone comes out of the center speaker when you select “PHANTOM” or “OFF” for the center mode.

9. If necessary, adjust the speaker output balance as follows:

- To adjust the rear speaker output level, press Control  $\Delta / \nabla$  until “-REAR +” appears on the display, then press Control  $\triangleleft / \triangleright$ .
- To adjust the center speaker output level, press Control  $\Delta / \nabla$  until “-CENTER+” appears on the display, then press Control  $\triangleleft / \triangleright$ .

**Notes:**

- The sound levels of the left and right rear speakers will be the same.
- You cannot set the sound level of the rear speakers when you have selected “3CHLOGIC.”
- You cannot set the sound level of the center speaker when you select “PHANTOM” or “OFF” for the center mode.

10. Press Control  $\Delta / \nabla$  until “TEST” appears on the display, then press Control  $\triangleleft / \triangleright$  to stop the test tone.

**From the remote control:**

If you have already set the center speaker size following the procedure described on page 14, you can use the remote control for Dolby Surround preparation.

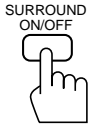

**1. Press SURROUND ON/OFF so that one of the surround mode indicators (PRO LOGIC, 3CH LOGIC, HALL) lights up on the display.**

The previous mode is recalled (at its previous settings) and is shown on the display. Each time you press the button, the surround mode turns on and off.

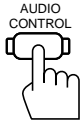

**2. Press AUDIO CONTROL so that 10 keys work for adjusting the sound.**

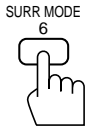

**3. Press SURR MODE until “PROLOGIC” or “3CHLOGIC” whichever you want appears on the display.**

Each time you press the button, the surround modes change as follows:

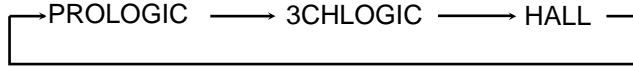

The indicator of the selected surround mode lights up in turn as you select the surround modes.

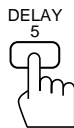

**4. Press DELAY to adjust the delay time of the rear speaker output.**

Each time you press the button, the delay time changes as follows:

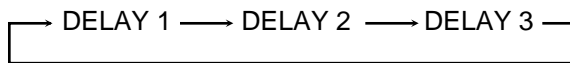

**Note:**

When you have selected “3CHLOGIC,” you cannot adjust the delay time.

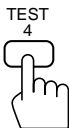

**5. Press TEST to start checking the speaker output balance.**

“TEST” starts flashing on the display, and a test tone comes out from the speakers in the following order:

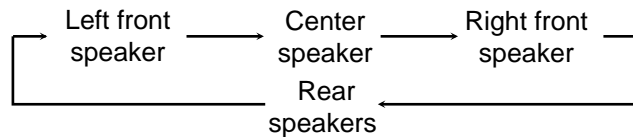

**Notes:**

- No test tone comes out of the rear speakers when you have selected “3CHLOGIC.”
- No test tone comes out of the center speaker when you select “PHANTOM” or “OFF” for the center mode.

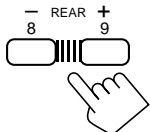

**6. If necessary, adjust the speaker output balance as follows:**

- To adjust the rear speaker output level, press REAR+/-.
- To adjust the center speaker output level, press CENTER +/-.

Pressing – decreases the output level up to –10 dB.

Pressing + increases the output level up to +10 dB.

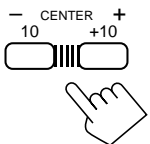

**Notes:**

- The sound levels of the left and right rear speakers will be the same.
- You cannot set the sound level of the rear speakers when you have selected “3CHLOGIC.”
- You cannot set the sound level of the center speaker when you select “PHANTOM” or “OFF” for the center mode.

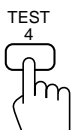

**7. Press TEST again to stop the test tone.**

Once you have set the Dolby Surround adjustments, you can use the same adjustments every time you want to enjoy Dolby Surround.

**On the front panel:**

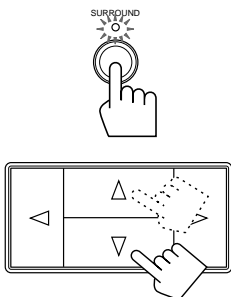

1. Press SURROUND so that the Control  $\Delta$  /  $\nabla$  buttons work for selecting the surround modes. The lamp above the button lights up.

2. Press Control  $\Delta$  /  $\nabla$  until "PROLOGIC" or "3CHLOGIC" whichever you want appears on the display. The PRO LOGIC or 3CH LOGIC indicator also lights up.

Each time you press the button, the surround modes change as follows:

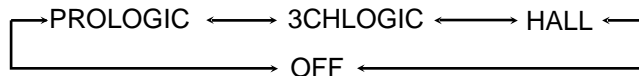

The indicator of the selected surround mode lights up in turn as you select the surround modes.

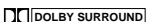
3. Select and play a sound source which was processed with Dolby Surround and is labeled with  mark.

To cancel Dolby Surround, select "OFF" in step 2 above. The indicator of the selected mode goes off.

**From the remote control:**



1. Press SURROUND ON/OFF so that one of the surround mode indicators (PRO LOGIC, 3CH LOGIC, HALL) lights up on the display.

The previous mode is recalled (at its previous settings) and is shown on the display.

Each time you press the button, the surround mode turns on and off.

2. Press AUDIO CONTROL so that 10 keys work for adjusting the sound.

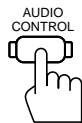

3. If necessary, press SURR MODE until "PROLOGIC" or "3CHLOGIC" whichever you want appears on the display.

Each time you press the button, the surround modes change as follows:

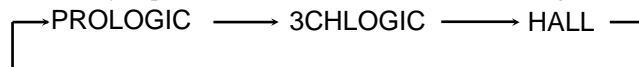

The indicator of the selected surround mode lights up in turn as you select the surround modes.

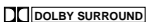
4. Select and play a sound source which was processed with Dolby Surround and is labeled with  mark.

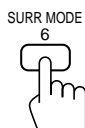

To cancel Dolby Surround, press SURROUND ON/OFF so that the indicator of the selected mode goes off.

Each time you press the button, the surround mode turns on and off.

## COMPU LINK Remote Control System

The COMPU LINK remote control system allows you to operate JVC audio components through the remote sensor on the receiver.

To use this remote control system, you need to connect JVC audio components through the COMPU LINK-3 SYNCHRO jacks with the cables (monaural mini-plug supplied with those components):

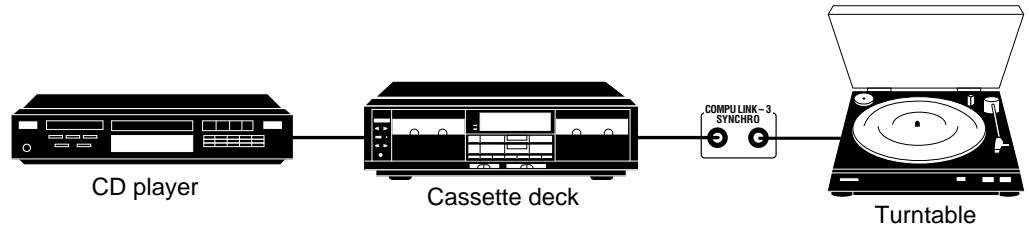

This remote control system allows you to use the four functions listed below.

### ■ Remote Control through the Remote Sensor on the Receiver

You can control JVC audio components through the remote sensor on the receiver using this remote control. Aim the remote control directly at the remote sensor on the receiver.

For details, see page 28.

#### Notes:

- Without connecting the audio components with RCA pin plugs as described on page 7, the COMPU LINK remote control system cannot operate the components.
- Refer also to the manuals supplied with your audio components.

### ■ Automatic Source Selection

When you press the play (▶) button on a connected component or on its own remote control, the receiver automatically turns on and changes its source to the component. On the other hand, if you select a new source on the receiver or the remote control, the selected component begins playing immediately.

In both cases, the previously selected source continues playing without sound for a few seconds.

### ■ Automatic Power On/Off (Standby) (only possible with the COMPU LINK-3 connection)

Both the CD player and cassette deck turn on and off (into standby mode) with the receiver.

When you turn on the receiver, the CD player or cassette deck will turn on automatically, depending which component has been previously selected.

When you turn off the receiver (into standby mode), both the CD player and cassette deck will turn off (into standby mode).

### ■ Synchronized Recording

Synchronized recording means the cassette deck starts recording as soon as a CD or record begins playing.

To use synchronized recording, follow these steps:

- 1 Put a tape in the cassette deck, and a disc in the CD player (or a record on the turntable).
- 2 Press the record (●) button and the pause (||) button on the cassette deck at the same time. This puts the cassette deck into recording pause.

#### Note:

If you do not press the record (●) button and pause (||) button at the same time, the synchronized recording feature will not operate.

- 3 Press the play (▶) button on the CD player or on the turntable.

The source changes on the receiver, and as soon as play starts, the cassette deck starts recording.

When the play ends, the cassette deck enters recording pause, and stops 4 seconds later.

#### Notes:

- During synchronized recording, the selected source cannot be changed.
- If your CD player is playing in program mode, a 4-second blank is recorded between tracks so that the music scan feature of your cassette deck can be used on the recorded tape.
- If the power of any component is shut off during synchronized recording, the COMPU LINK remote control system may not operate properly. In this case, you must start again from the beginning.
- Refer also to the manuals supplied with your CD player and cassette deck.



## Using the Remote Control

You can operate JVC audio and video components with the receiver's remote control, since control signals for JVC components are preset in the remote control.

To operate these components with the remote control, first select a source with the source buttons on the remote control. Then, operate that source using the remote control.

### IMPORTANT:

To operate JVC audio components using this remote control:

- You need to connect JVC audio components through the COMPU LINK-3 SYNCHRO jacks (see page 8) in addition to the connections using cables with RCA pin plugs (see page 7).
- Aim the remote control directly at the remote sensor on the receiver.

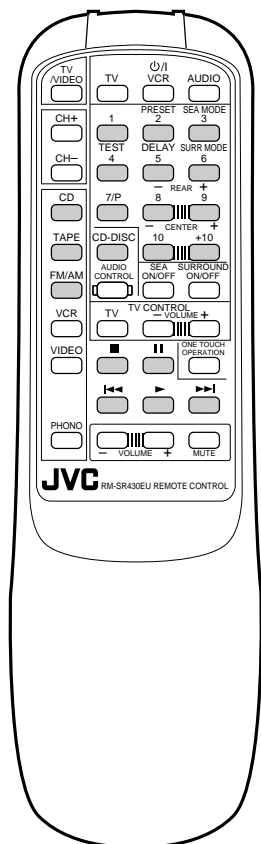

After pressing FM/AM, you can perform the following operations:

- |             |  |
|-------------|--|
| FM/AM       | Alternates between FM and AM (MW/LW)           |
| 1 — 10, +10 | Selects a preset channel number directly       |
|             | For channel number 5, press 5.                 |
|             | For channel number 15, press +10, then 5.      |
|             | For channel number 20, press +10, then 10.     |
|             | For channel number 30, press +10, +10 then 10. |

After pressing CD, you can perform the following operations on a CD player:

- |             |   |
|-------------|---|
| ▶           | Starts playing  |
| ◀◀          | Returns to the beginning of the current (or previous) track |
| ▶▶          | Skips to the beginning of the next track                    |
| ■           | Stops playing   |
| ⏸           | Pauses. To resume playing, press ▶.                         |
| 1 — 10, +10 | Selects a track number directly                             |
|             | For track number 5, press 5.                                |
|             | For track number 15, press +10, then 5.                     |
|             | For track number 20, press +10, then 10.                    |
|             | For track number 30, press +10, +10, then 10                |

After pressing CD-DISC, you can perform the following operations on a CD player-changer:

- |            |  |
|------------|--|
| 1 — 6, 7/P | Select the number of a disc installed in a CD player-changer. Then continue to operate the CD player as described above. |
|------------|--|

After pressing TAPE, you can perform the following operations on a cassette deck:

- |    |                                      |
|----|--------------------------------------|
| ▶  | Starts playback                      |
| ◀◀ | Fast winds a tape from right to left |
| ▶▶ | Fast winds a tape from left to right |
| ■  | Stops operation                      |
| ⏸  | Pauses. To resume playing, press ▶.  |

**IMPORTANT:**

To operate JVC video components using this remote control:

- Aim the remote control directly at the remote sensor on the VCR or TV, not on the receiver.

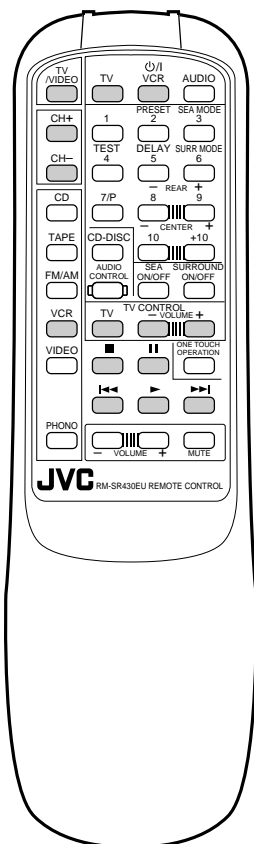

After pressing VCR, you can perform the following operations on a VCR:

- ▶ Starts playback
- ◀◀ Rewinds a video tape
- ▶▶ Fast winds a video tape
- Stops operation
- || Pauses. To resume playing, press ▶.
- CH+/- Changes channels on a VCR

Without pressing VCR, you can always perform the following:

- VCR (in the  $\cup/|$  (Standby/On) section)
- Turns on/off the VCR

After pressing TV (in the TV CONTROL section), you can perform the following operations on TV:

- CH+/- Changes TV channels

Without pressing TV (in the TV CONTROL section), you can always perform the following:

- TV/VIDEO Sets input mode (either to TV or to VIDEO)
- VOLUME +/- (in the TV CONTROL section)
- Adjusts the volume
- TV (in the  $\cup/|$  (Standby/On) section)
- Turns on/off the TV

Use this chart to help you solve daily operational problems. If there is any problem you cannot solve, contact your JVC service center.

PROBLEM	POSSIBLE CAUSE	SOLUTION
The display does not light up	The power cord is not plugged in or the <b>⓪</b> POWER switch is pressed to set in the <b>■</b> OFF position	Plug the power cord into an AC outlet and press <b>⓪</b> POWER to set it in the <b>■</b> ON position
No sound from speakers	Speaker signal cables are not connected	Check speaker wiring and reconnect if necessary
	The <b>SPEAKERS</b> 1 and 2 are not set correctly	Press <b>SPEAKERS</b> 1 and 2 correctly
	An incorrect source is selected	Select the correct source
Sound from one speaker only	Speaker signal cables are not connected properly	Check speaker wiring and reconnect if necessary
	The balance is set to one extreme	Adjust the balance properly (see page 13)
Continuous hiss or buzzing during FM reception	Incoming signal is too weak	Connect an outside FM antenna or contact your dealer
	The station is too far away	Select a new station
	An incorrect antenna is used	Check with your dealer to be sure you have the correct antenna
	Antennas are not connected properly	Check connections
Occasional cracking noise during FM reception	Ignition noise from automobiles	Move the antenna farther from automobile traffic
Howling during record playing	Your turntable is too close to speakers	Move speakers away from the turntable
Remote control does not work	There is an obstruction in front of the remote sensor on the receiver	Remove the obstruction
	Batteries are weak	Replace batteries

## Specifications

### Amplifier

Output Power	At Stereo Operation Front Channels	50 watts per channel, min. RMS, driven into 4 ohms at 1 kHz with no more than 0.9% total harmonic distortion. (IEC268-3/DIN)
		30 watts per channel, min. RMS, driven into 8 ohms at 1 kHz with no more than 0.9% total harmonic distortion. (IEC268-3/DIN)
		30 watts per channel, min. RMS, driven into 8 ohms, 40 Hz to 20 kHz with no more than 0.8% total harmonic distortion.
	At Surround Operation Front Channels	40 watts per channel, min. RMS, driven into 8 ohms at 1 kHz with no more than 0.8% total harmonic distortion.
	Center Channel	40 watts, min. RMS, driven into 8 ohms at 1 kHz, with no more than 0.8% total harmonic distortion.
	Rear Channels	40 watts per channel, min. RMS, driven into 8 ohms at 1kHz, with no more than 0.8% total harmonic distortion.
Total Harmonic Distortion (8 ohms, 1 kHz)		0.8 %* at 30 watts output (* Measured by JVC Audio Analysis System)
Frequency Response (8 ohms)	PHONO CD, TAPE, VCR, VIDEO	20 Hz to 20 kHz ( $\pm 1$ dB) 20 Hz to 20 kHz ( $\pm 1$ dB)
Audio Input Sensitivity/ Impedance (1 kHz)	PHONO (MM) CD, TAPE, VCR, VIDEO	2.5 mV/47 k ohms 200 mV/47 k ohms
Audio Output Level	TAPE, VCR	200 mV
Signal-to-Noise Ratio ( '66 IHF/DIN)	PHONO CD, TAPE, VCR, VIDEO	70 dB/66 dB 87 dB/67 dB
RIAA Phono Equalization		$\pm 0.5$ dB (20 Hz to 20 kHz)
Loudness (Volume Control at -40 dB)		$+5 \pm 2$ dB at 100 Hz
Video Input Sensitivity/ Impedance	VCR, VIDEO	1 Vp-p/75 ohms
Video Output Level	VCR, MONITOR OUT	1 Vp-p (at 1 Vp-p input)
Synchronization		negative
Signal-to-Noise Ratio		45 dB

**FM tuner (IHF)**

Tuning Range		87.5 MHz to 108.0 MHz
Usable Sensitivity		12.7 dBf (1.2 $\mu$ V/75 ohms)
50 dB Quieting Sensitivity	Monaural Stereo	16.3 dBf (1.8 $\mu$ V/75 ohms) 38.3 dBf (22.5 $\mu$ V/75 ohms)
Signal-to-Noise Ratio (IHF-A weighted)	Monaural Stereo	80 dB at 85 dBf 73 dB at 85 dBf
Total Harmonic Distortion	Monaural Stereo	0.15 % at 1 kHz 0.2 % at 1 kHz
Stereo Separation at REC OUT		40 dB at 1 kHz
Capture Ratio		1.5 dB (10 mV)
Alternate Channel Selectivity		60 dB: ( $\pm$ 400 kHz)
Frequency Response		30 Hz to 15 kHz: (+0.5 dB, -3 dB)

**AM (MW/LW) tuner**

Tuning Range	MW: LW:	522 kHz to 1,629 kHz 144 kHz to 288 kHz
Usable Sensitivity	MW: Loop antenna External antenna LW: Loop antenna	300 $\mu$ V/m 30 $\mu$ V 600 $\mu$ V/m
Signal-to-Noise Ratio		50 dB (100 mV/m)

**General**

Power Requirements		AC 230V <sup>~</sup> , 50 Hz
Power Consumption		240 watts 5 watts (in standby mode)
Dimensions (W x H x D)		435 x 146 x 403 mm (17 <sup>3</sup> / <sub>16</sub> x 5 <sup>3</sup> / <sub>4</sub> x 15 <sup>7</sup> / <sub>8</sub> inches)
Mass		8.0 kg (17.7 lbs)

Design & specifications are subject to change without notice

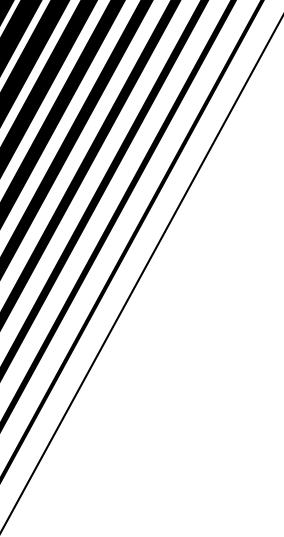

## Free Manuals Download Website

<http://myh66.com>

<http://usermanuals.us>

<http://www.somanuals.com>

<http://www.4manuals.cc>

<http://www.manual-lib.com>

<http://www.404manual.com>

<http://www.luxmanual.com>

<http://aubethermostatmanual.com>

Golf course search by state

<http://golfingnear.com>

Email search by domain

<http://emailbydomain.com>

Auto manuals search

<http://auto.somanuals.com>

TV manuals search

<http://tv.somanuals.com>