

# JVC

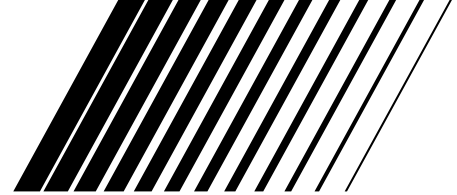

## AUDIO/VIDEO CONTROL RECEIVER

RECEPTOR DE CONTROL DE AUDIO/VÍDEO  
RECEPTOR DE COMANDO AUDIO/VÍDEO

AV功率放大器（带收音）

# RX-5000VBK / RX-5001VGD

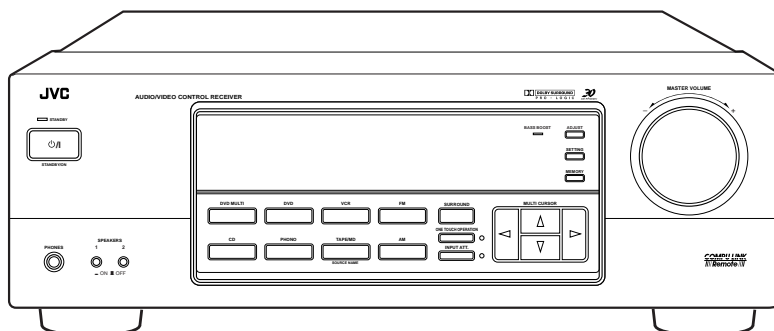
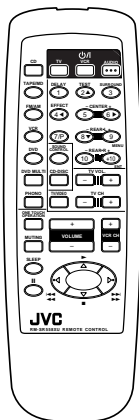

**COMPU LINK**  
Remote

**3D**  
3D-PHONIC

**DOLBY SURROUND**  
PRO • LOGIC

## INSTRUCTIONS

MANUAL DE INSTRUCCIONES  
INSTRUÇÕES  
使用说明书

### For Customer Use:

Enter below the Model No. and Serial No. which are located either on the rear, bottom or side of the cabinet. Retain this information for future reference.

Model No. \_\_\_\_\_

Serial No. \_\_\_\_\_

LVT0384-006A  
[U, US]

# Warnings, Cautions and Others / Avisos, precauciones y otras notas / Advertências, precauções e outras notas / 警告、注意及其他須知事項

## تحذيرات، تنبيهات وأشياء أخرى

### CAUTION

To reduce the risk of electrical shocks, fire, etc.:

1. Do not remove screws, covers or cabinet.
2. Do not expose this appliance to rain or moisture.

### PRECAUCIÓN

Para reducir riesgos de choques eléctricos, incendio, etc.:

1. No extraiga los tornillos, los cubiertas ni la caja.
2. No exponga este aparato a la lluvia o a la humedad.

### ATENÇÃO

Para reduzir riscos de choques eléctricos, incêndio, etc.:

1. Não retire parafusos nem desmonte as tampas ou o gabinete.
2. Não exponha este aparelho à chuva nem à umidade.

### 警告

为了减低触电，火灾等危险：

1. 请勿擅自卸下螺丝钉，盖子或机壳。
2. 切勿让本机受雨淋或置潮湿环境中。

### تحذير

لتجنب خطر الحريق، الصدمات الكهربائية، الخ.:

1. لا تقم بفك البراغي، الاغطية أو الخزانة.
2. لا تقم بتعرض هذا الجهاز للمطر أو للرطوبة.

### Caution — ⏻/I switch!

Disconnect the mains plug to shut the power off completely. The ⏻/I switch in any position does not disconnect the mains line. The power can be remote controlled.

### Precaución — Interruptor ⏻/I!

Desconectar el cable de alimentación para desactivar la alimentación totalmente. Cualquiera que sea la posición de ajuste del interruptor ⏻/I, la alimentación no es cortada completamente. La alimentación puede ser controlada remotamente.

### Precaução — Interruptor ⏻/I!

Desconectar o cabo de alimentação para desligar a alimentação por completo. Qualquer que seja a posição de ajuste do interruptor ⏻/I, a alimentação não é completamente cortada. A alimentação pode ser controlada remotamente.

### 注意 — ⏻/I 按键

无论 ⏻/I 按键在任何位置，电源线的电源还是没有被切断，若要将电源完全关闭，应把电源插头拔离插座。电源可用遥控器控制。

### تحذير — ⏻/I الطاقة

انزع قابس الطاقة الكهربائية من اجل فصل الطاقة الكهربائية عن الجهاز كلياً. لا يفصل مفتاح الطاقة الكهربائية عندما يكون باي وضع ⏻/I الطاقة الكهربائية عن الجهاز. يمكن التحكم عن بعد بالطاقة الكهربائية.

**Caution: Proper Ventilation**

To avoid risk of electric shock and fire and to protect from damage.

Locate the apparatus as follows:

- Front: No obstructions open spacing.  
 Sides: No obstructions in 10 cm from the sides.  
 Top: No obstructions in 10 cm from the top.  
 Back: No obstructions in 15 cm from the back  
 Bottom: No obstructions, place on the level surface.

In addition, maintain the best possible air circulation as illustrated.

**Precaución: Ventilación Adecuada**

Para evitar el riesgo de choque eléctrico e incendio y para proteger el aparato contra daños.

Ubique el aparato de la siguiente manera:

- Frente: Espacio abierto sin obstrucciones  
 Lados: 10 cm sin obstrucciones a los lados  
 Parte superior: 10 cm sin obstrucciones en la parte superior  
 Parte trasera: 15 cm sin obstrucciones en la parte trasera  
 Fondo: Sin obstrucciones, colóquelo sobre una superficie nivelada

Además, mantenga la mejor circulación de aire posible como se ilustra.

**Precaução: ventilação apropriada**

Para prevenir o risco de choque elétrico ou incêndio e para proteger o aparelho contra danos.

Localize-o da seguinte maneira:

- Frente: Espaço aberto, sem obstruções  
 Lados: Espaço de 10 cm sem obstruções nos lados  
 Topo: Espaço de 10 cm sem obstruções acima  
 Atrás: Espaço de 15 cm sem obstruções atrás  
 Parte inferior: Sem obstruções. Coloque o aparelho em superfície nivelada.

Mantenha, além disso, a maior circulação de ar possível, como indica a ilustração.

**注意：正确的通风方法**

为了防止触电、火灾以及避免损坏，

按如下要求放置机器：

- 前面：留下空间不要放置障碍物。  
 侧面：侧面的10cm之内不要放置障碍物。  
 上面：上面的10cm之内不要放置障碍物。  
 背面：背面的15cm之内不要放置障碍物。  
 底部：不要放置障碍物，水平放置。

此外、如图所示，尽可能保持最佳的空气循环。

**تنبيه: حول التهوية الصحيحة**

لتفادي وقوع الصدمة الكهربائية والحريق، ولحماية الأجهزة من التلف قم بتحديد مواقع تركيب الأجهزة كالتالي:

- الامام: مساحة فارغة بدون عوائق  
 الجوانب: عدم وجود أية عوائق بطول ١٠ سم من الجوانب  
 السطح العلوي: عدم وجود أية عوائق بطول ١٠ سم من السطح العلوي  
 الخلف: عدم وجود أية عوائق بطول ١٥ سم من اللوحة الخلفية  
 القاع: عدم وجود أية عوائق، يجب وضع الأجهزة على السطح المستوي.  
 بالإضافة الى ذلك، احتفظ بأفضل توزيع للهواء كما هو مبين في الرسم.

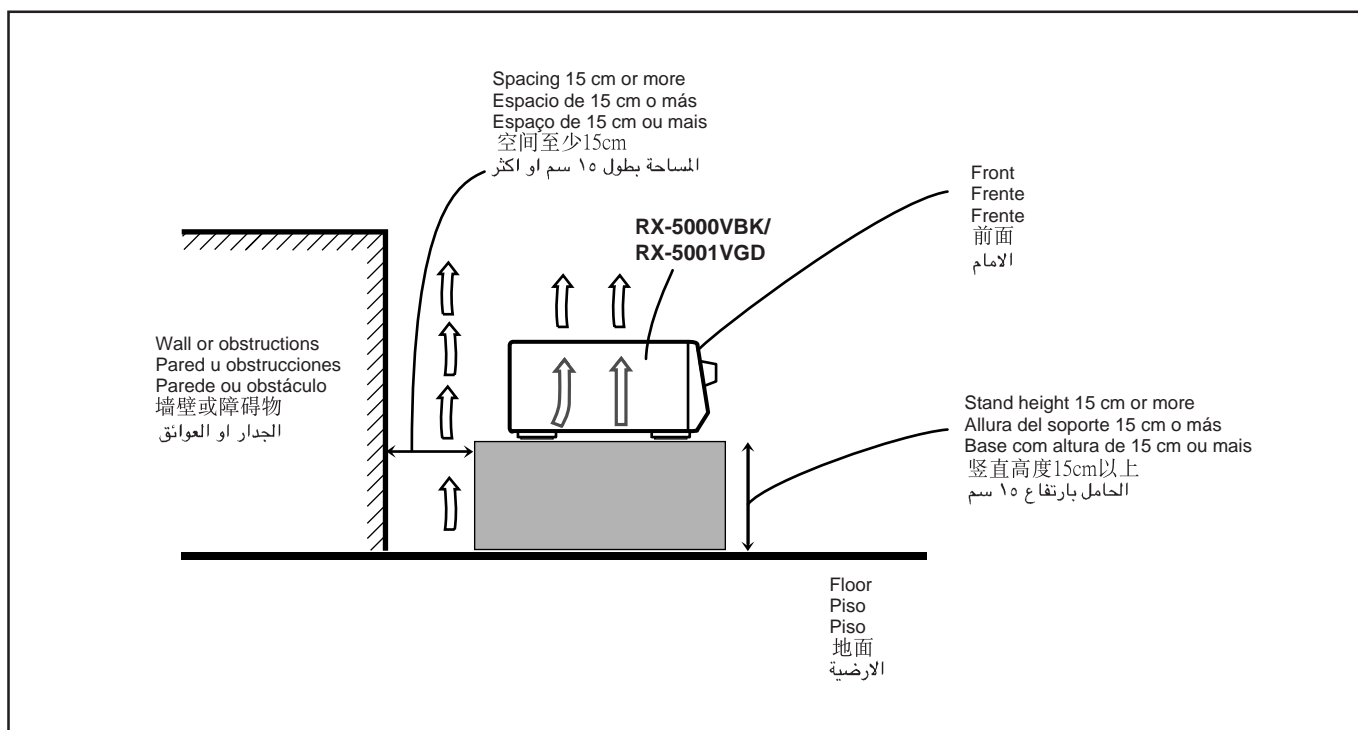

# Table of Contents

<b>Parts Identification .....</b>	<b>2</b>
<b>Getting Started .....</b>	<b>3</b>
Before Installation .....	3
Checking the Supplied Accessories .....	3
Connecting the FM and AM Antennas .....	3
Connecting the Speakers .....	4
Connecting Audio/Video Components .....	5
Connecting the Power Cord .....	7
Putting Batteries in the Remote Control .....	7
<b>Basic Operations .....</b>	<b>8</b>
Turning the Power On and Off (Standby) .....	8
Selecting the Source to Play .....	8
Adjusting the Volume .....	9
Selecting the Front Speakers .....	9
Muting the Sound .....	9
Recording a Source .....	9
Attenuating the Input Signal .....	10
Adjusting the Front Speaker Output Balance .....	10
Reinforcing the Bass .....	10
Adjusting the Tone .....	10
<b>Basic Settings .....</b>	<b>11</b>
Changing the Source Name .....	11
Setting Center and Rear Speakers for the DSP Modes .....	11
Storing the Basic Settings and Adjustments — One Touch Operation .....	12
Using the Sleep Timer .....	12
<b>Receiving Radio Broadcasts .....</b>	<b>13</b>
Setting the AM Tuner Internal Spacing .....	13
Tuning in Stations Manually .....	13
Using Preset Tuning .....	13
Selecting the FM Reception Mode .....	14
<b>Using the DSP Modes .....</b>	<b>15</b>
Available DSP Modes According to the Speaker Arrangement ..	16
Adjusting the 3D-PHONIC Modes .....	17
Adjusting the DAP Modes .....	17
Adjusting the Surround Modes — Dolby Surround and JVC Theater Surround .....	18
Activating the DSP Modes .....	19
<b>Using the DVD MULTI Playback Mode .....</b>	<b>20</b>
Activating the DVD MULTI Playback Mode .....	20
<b>COMPU LINK Remote Control System .....</b>	<b>21</b>
<b>Operating JVC's Audio/Video Components ...</b>	<b>22</b>
<b>Troubleshooting .....</b>	<b>24</b>
<b>Specifications .....</b>	<b>25</b>

# Parts Identification

Become familiar with the buttons and controls on the receiver before use.  
Refer to the pages in parentheses for details.

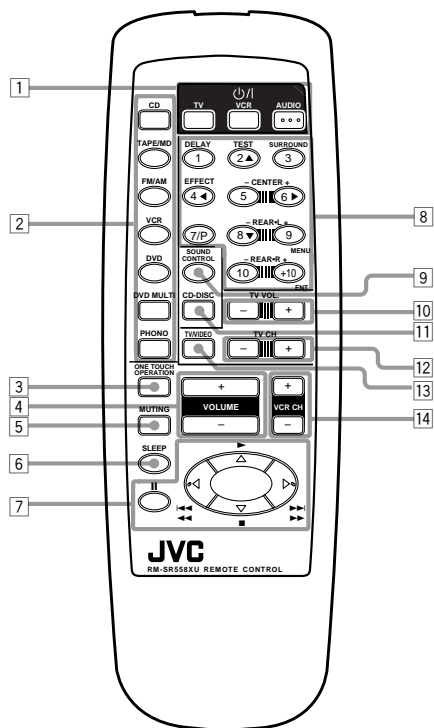
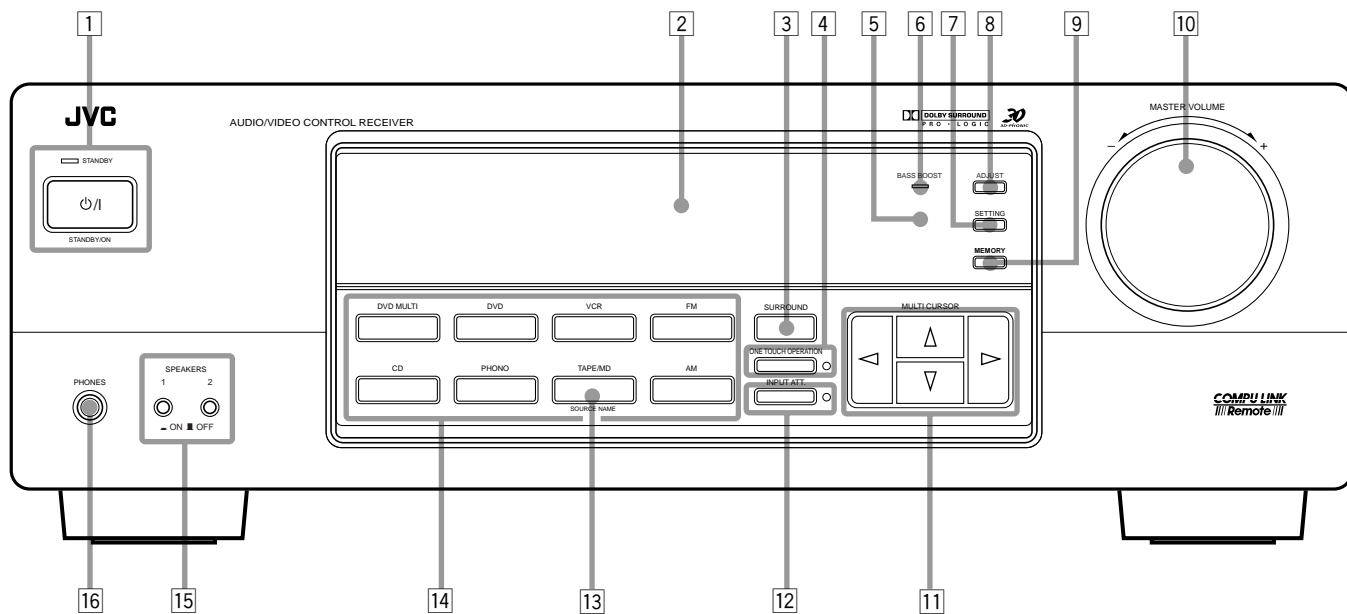

## Front Panel

- 1 STANDBY/ON  $\odot/\text{I}$  button and STANDBY lamp (8)
- 2 Display (8)
- 3 SURROUND button (16)
- 4 ONE TOUCH OPERATION button and lamp (12)
- 5 Remote sensor (7)
- 6 BASS BOOST lamp (10)
- 7 SETTING button (11)\*
- 8 ADJUST button (10)\*
- 9 MEMORY button (13)
- 10 MASTER VOLUME control (9)
- 11 Cursor control buttons
- 12 INPUT ATT. button and lamp (10)
- 13 SOURCE NAME button (11)
- 14 Source selecting buttons (8)  
DVD MULTI, DVD, VCR, FM\*, AM\*,  
TAPE/MD, PHONO, CD
- 15 SPEAKERS 1/2 buttons (9)
- 16 PHONES jack (9)

## Remote Control

- 1  $\odot/\text{I}$  buttons (8, 23)  
TV, VCR, AUDIO
- 2 Source selecting buttons (8)  
CD, TAPE/MD, FM/AM, VCR, DVD,  
DVD MULTI, PHONO
- 3 ONE TOUCH OPERATION button (12)
- 4 VOLUME +/- buttons (9)
- 5 MUTING button (9)
- 6 SLEEP button (12)
- 7 • Operating buttons for audio/video components (22)
- 8 • 10 keys for selecting preset channel (14, 22)  
• 10 keys for adjusting sound (12, 17, 22)  
• 10 keys for operating audio/video components (22)
- 9 SOUND CONTROL button (12, 17, 22)
- 10 TV VOL. +/- buttons (23)
- 11 CD-DISC button (22)
- 12 TV CH +/- buttons (23)
- 13 TV/VIDEO button (23)
- 14 VCR CH +/- buttons (23)

### IMPORTANT:

#### To use the Cursor control buttons (11) on the front panel:

What these buttons actually do depends on which function you are trying to adjust. Before using these buttons, select the function by pressing one of the buttons marked with \*.

# Getting Started

This section explains how to connect audio/video components and speakers to the receiver, and how to connect the power supply.

## Before Installation

### General

- Be sure your hands are dry.
- Turn the power off to all components.
- Read the manuals supplied with the components you are going to connect.

### Locations

- Install the receiver in a location that is level and protected from moisture.
- The temperature around the receiver must be between  $-5^{\circ}\text{C}$  and  $35^{\circ}\text{C}$  ( $23^{\circ}\text{F}$  and  $95^{\circ}\text{F}$ ).
- Make sure there is good ventilation around the receiver. Poor ventilation could cause overheating and damage the receiver.

### Handling the receiver

- Do not insert any metal object into the receiver.
- Do not disassemble the receiver or remove screws, covers, or cabinet.
- Do not expose the receiver to rain or moisture.

## Checking the Supplied Accessories

Check to be sure you have all of the following items, which are supplied with the receiver.

The number in the parentheses indicates quantity of the pieces supplied.

- **Remote Control (1)**
- **Batteries (2)**
- **AM Loop Antenna (1)**
- **FM Antenna (1)**

If anything is missing, contact your dealer immediately.

## Connecting the FM and AM Antennas

### FM Antenna Connections

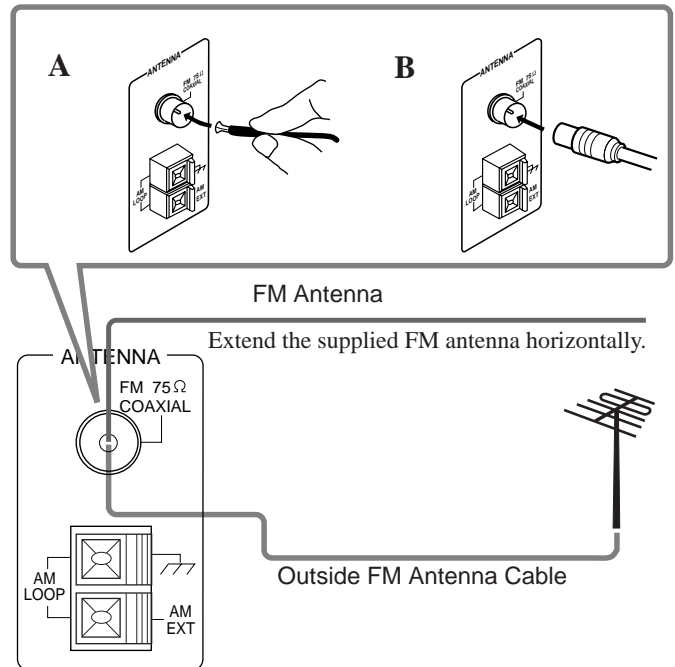

#### A. Using the Supplied FM Antenna

The FM antenna provided can be connected to the FM 75Ω COAXIAL terminal as temporary measure.

#### B. Using the Standard Type Connector (Not Supplied)

A standard type connector should be connected to the FM 75Ω COAXIAL terminal.

#### **Note:**

*If reception is poor, connect the outside antenna.*

*Before attaching a 75Ω coaxial cable (the kind with a round wire going to an outside antenna), disconnect the supplied FM antenna.*

## AM Antenna Connections

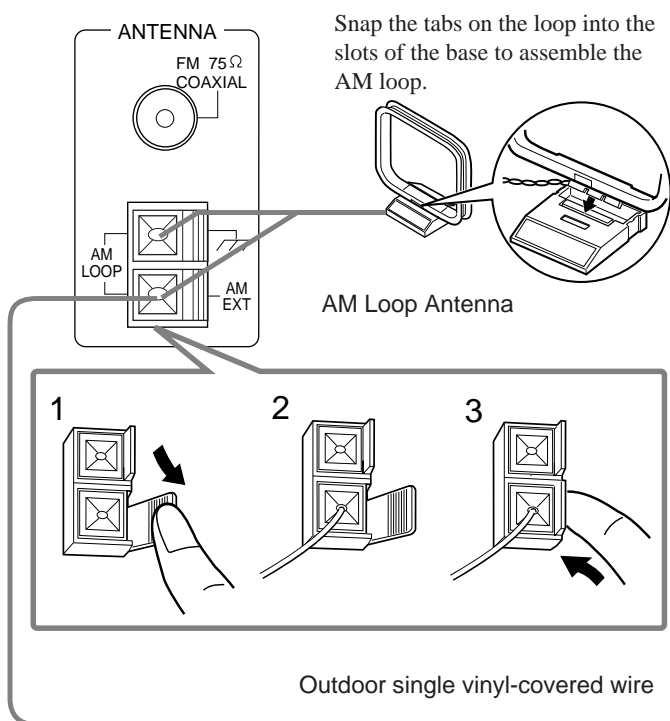

Turn the loop until you have the best reception.

### Notes:

- Make sure the antenna conductors do not touch any other terminals, connecting cords and power cord. This could cause poor reception.
- If reception is poor, connect an outdoor single vinyl-covered wire to the AM EXT terminal. (Keep the AM loop antenna connected.)

## Connecting the Speakers

You can connect the following speakers:

- Two pairs of front speakers to produce normal stereo sound.
- One pair of rear speakers to enjoy the surround effect.
- One center speaker to produce more effective surround effect (to emphasize human voices).
- One subwoofer to enhance the bass.

### IMPORTANT:

After connecting the speakers listed above, set the speaker setting information properly to obtain the best possible DSP (Digital Signal Processor) effect. For details, see page 11.

For each speaker (except for a subwoofer), connect the (-) and (+) terminals on the rear panel to the (-) and (+) terminals marked on the speakers. For connecting a subwoofer, see page 5.

### CAUTION:

Use speakers with the SPEAKER IMPEDANCE indicated by the speaker terminals.

## Basic connecting procedure

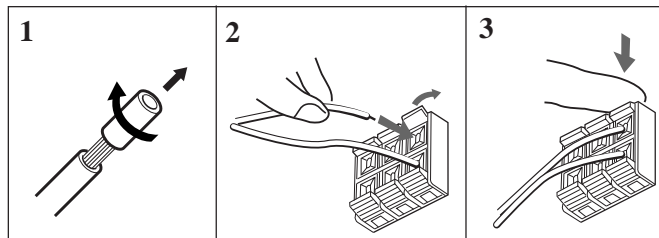

1 Cut, twist and remove the insulation at the end of each speaker signal cable.

2 Open the terminal and then insert the speaker signal cable.

3 Close the terminal.

## Connecting the front speakers

You can connect two pairs of front speakers (one pair to the FRONT SPEAKERS ① terminals, and another pair to the FRONT SPEAKERS ② terminals).

Right speaker — FRONT SPEAKERS ① — Left speaker

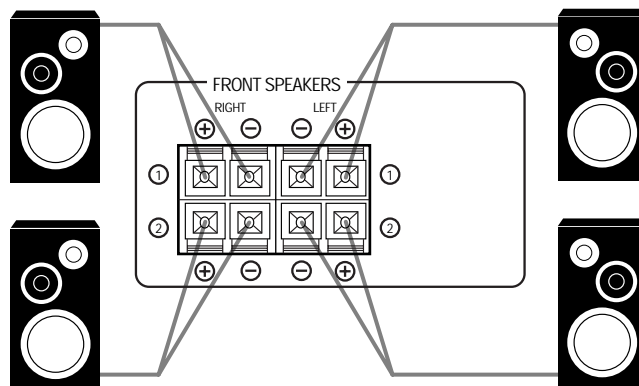

Right speaker — FRONT SPEAKERS ② — Left speaker

## Connecting the rear and center speakers

Connect rear speakers to the REAR SPEAKERS terminals and a center speaker to the CENTER SPEAKER terminals.

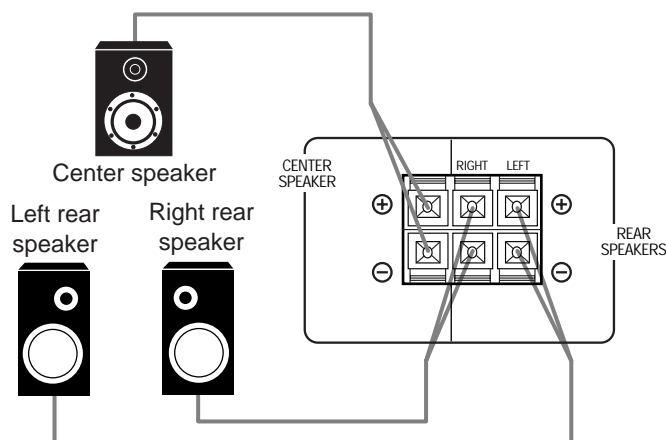

## Connecting the subwoofer speaker

You can enhance the bass by connecting a subwoofer. Connect the input jack of a powered subwoofer to the SUBWOOFER OUT jack on the rear panel, using a cable with RCA pin plugs.



Powered subwoofer

## Connecting Audio/Video Components

You can connect the following audio/video components to this receiver using cables with RCA pin plugs (not supplied). Refer also to the manuals supplied with your components.

Use the cables with RCA pin plugs (not supplied). Connect the white plug to the audio left jack, and the red plug to the audio right jack.

### Audio component connections

#### CAUTION:

If you connect a sound-enhancing device such as a graphic equalizer between the source components and this receiver, the sound output through this receiver may be distorted.

### Turntable

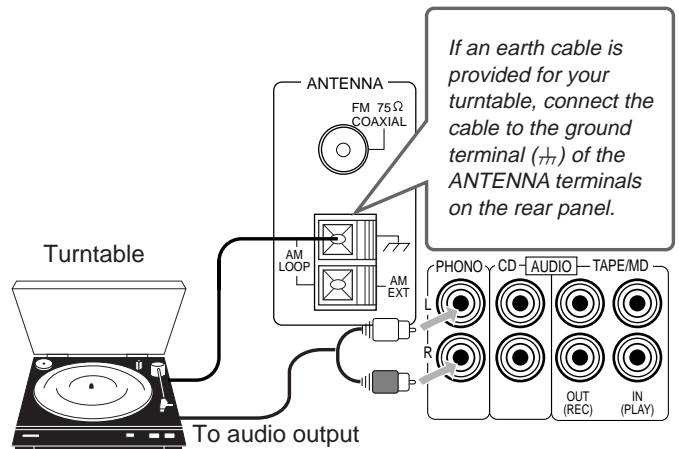

#### Note:

Any turntables incorporating a small-output cartridge such as an MC (moving-coil type) must be connected to this receiver through a commercial head amplifier or step-up transformer. Direct connection may result in insufficient volume.

### CD player

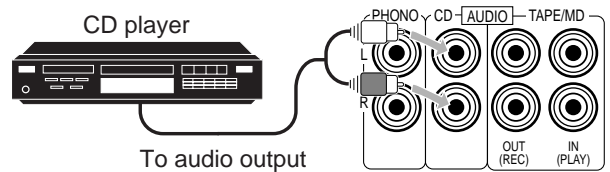

### Cassette deck or MD recorder

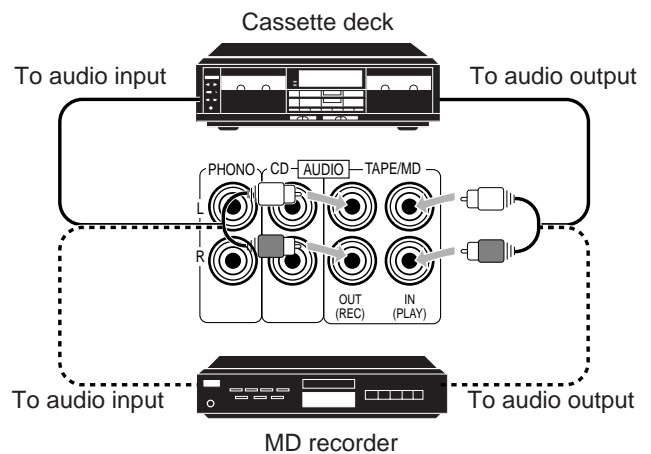

#### Note:

You can connect either a cassette deck or an MD recorder to the TAPE/MD jacks. When connecting an MD recorder to the TAPE/MD jacks, change the source name, which will be shown on the display when selected as the source, to "M D." See page 11 for details.

#### **If your audio components have a COMPU LINK-3 terminal**

See also page 21 for detailed information about the connection and the COMPU LINK-3 remote control system.



### Video component connections

Use the cables with RCA pin plugs (not supplied). Connect the white plug to the audio left jack, the red plug to the audio right jack and the yellow plug to the video jack.

#### TV (as the monitor)

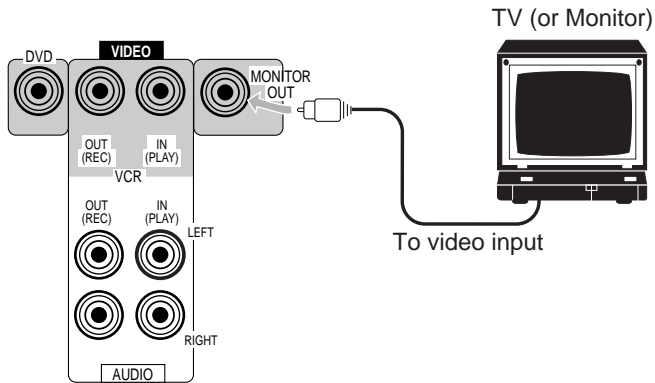

#### VCR

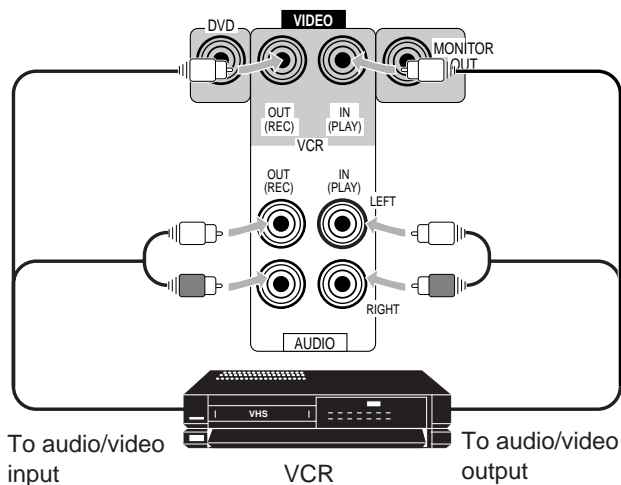

#### DVD player

- When you connect the DVD player with stereo output jacks:

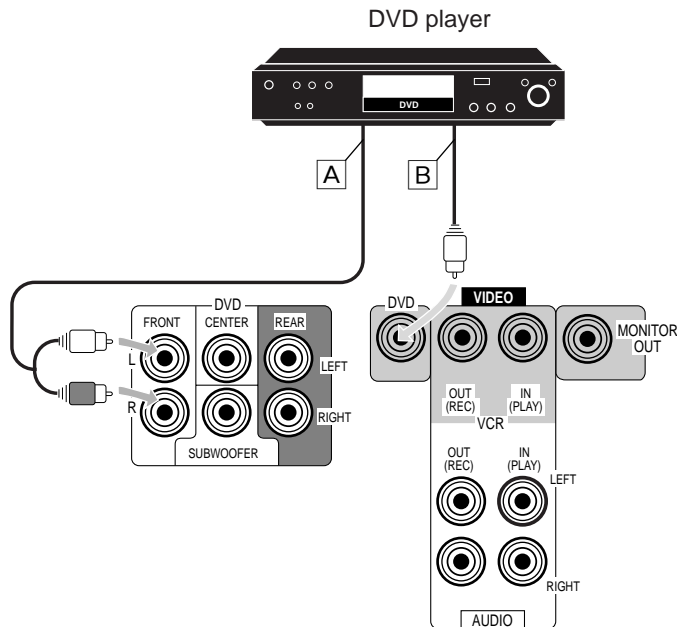

- A To front left/right channel audio output (or to audio mixed output if necessary)
- B To video output

- When you connect the DVD player with its analog discrete output (5.1 CH reproduction) jacks:

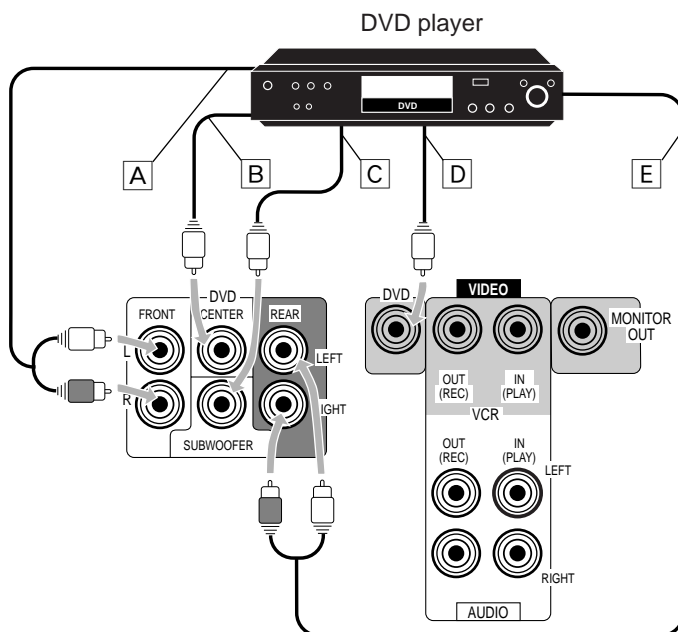

- A To front left/right channel audio output
- B To center channel audio output
- C To subwoofer audio output
- D To video output
- E To rear left/right channel audio output

## Connecting the Power Cord

Before plugging the receiver into an AC outlet, make sure that all connections have been made.

### Plug the power cord into an AC outlet.

Keep the power cord away from the connecting cables and the antenna. The power cord may cause noise or screen interference. We recommend that you use a coaxial cable to connect the antenna, since it is well-shielded against interference.

### Note:

The preset settings such as preset channels and sound adjustment may be erased in a few days in the following cases:

- When you unplug the power cord.
- When a power failure occurs.

### CAUTIONS:

- Do not touch the power cord with wet hands.
- Do not pull on the power cord to unplug the cord. When unplugging the cord, always grasp the plug so as not to damage the cord.

## Putting Batteries in the Remote Control

Before using the remote control, put two supplied batteries first. When using the remote control, aim the remote control directly at the remote sensor on the receiver.

### 1. On the back of the remote control, remove the battery cover as illustrated.

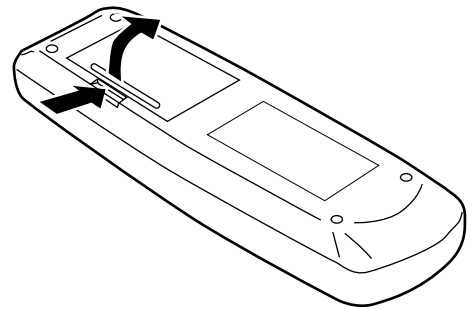

### 2. Insert batteries. Make sure to observe the proper polarity: (+) to (+) and (-) to (-).

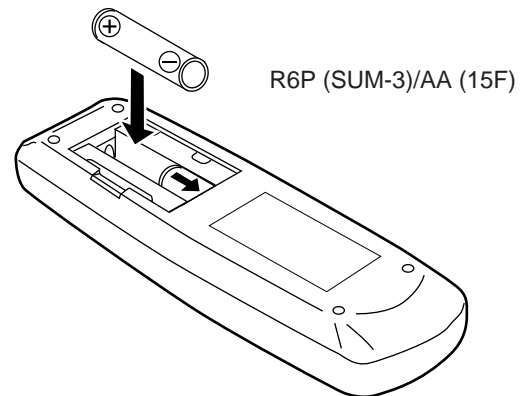

### 3. Replace the cover.

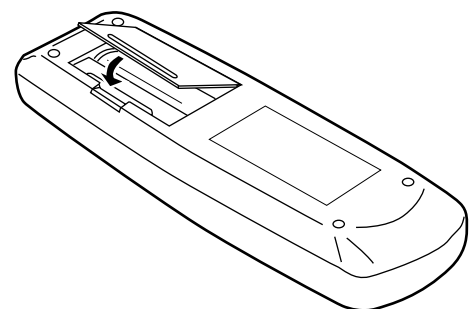

If the range or effectiveness of the remote control decreases, replace the batteries. Use two R6P (SUM-3)/AA (15F) type dry-cell batteries.

### CAUTION:

Follow these precautions to avoid leaking or cracking cells:

- Place batteries in the remote control so they match the polarity indicated: (+) to (+) and (-) to (-).
- Use the correct type of batteries. Batteries that look similar may differ in voltage.
- Always replace both batteries at the same time.
- Do not expose batteries to heat or flame.

# Basic Operations

The following operations are commonly used when you play any sound source.

## Turning the Power On and Off (Standby)

### On the front panel:

To turn on the power, press STANDBY/ON  $\odot/|$ . The STANDBY lamp goes off. The name of the current source (or station frequency) appears on the display.

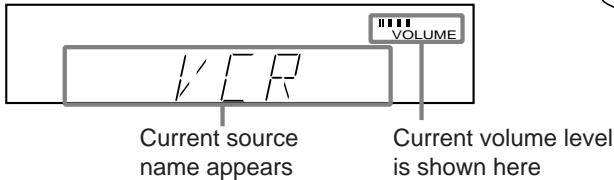
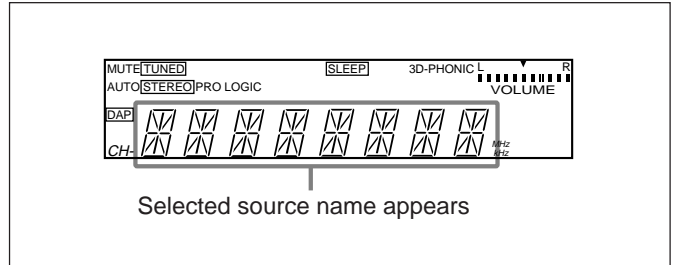
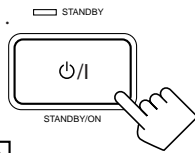

To turn off the power (into standby mode), press STANDBY/ON  $\odot/|$  again. The STANDBY lamp lights up. A small amount of power is consumed in standby mode. To turn the power off completely, unplug the AC power cord.

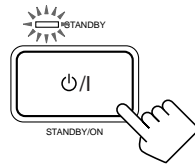

### From the remote control:

To turn on the power, press AUDIO  $\odot/|$ . The STANDBY lamp goes off. The name of the current source (or station frequency) appears on the display.

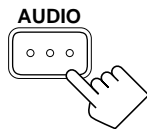

To turn off the power (into standby mode), press AUDIO  $\odot/|$  again. The STANDBY lamp lights up.

### On the front panel:

- DVD MULTI Select the DVD player for viewing the digital video disc using the analog discrete output mode (5.1CH reproduction) on the DVD player. To enjoy the DVD MULTI playback, see page 20.
- DVD Select the DVD player for viewing the stereo digital video disc.
- VCR Select the video component connected to the VCR jacks.
- FM Select an FM broadcast.
- AM Select an AM broadcast.
- TAPE/MD Select the cassette deck (or the MD recorder).
- PHONO Select the turntable.
- CD Select the CD player.

### From the remote control:

- FM/AM Select an FM or AM broadcast. Each time you press the button, the band changes alternately.
- Other buttons function in the same way as the buttons on the front panel.

## Selecting the Source to Play

Press one of the source selecting buttons.

### On the front panel:

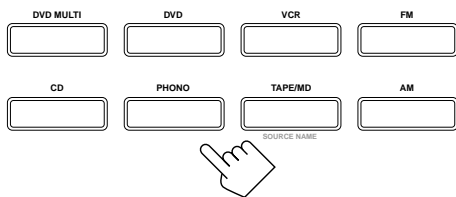

### From the remote control:

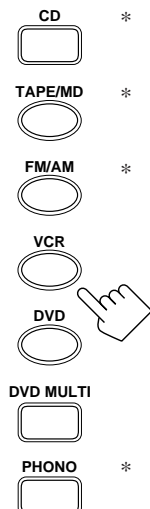

### Note:

When you press one of the source selecting buttons, marked above with an asterisk (\*), on the remote control, the receiver automatically turns on.

### Note:

When connecting an MD recorder (to the TAPE/MD jacks), change the source name that appears on the display. See page 11 for details.

### Selecting different sources for picture and sound

You can watch picture from a video component while listening to sound from another component.

Press one of the audio source selecting buttons (CD, TAPE/MD, PHONO, FM, AM), while viewing the picture from a video component such as the VCR or DVD player, etc.

### Note:

Once you have selected a video source, pictures of the selected source are sent to the TV until you select another video source.

## Adjusting the Volume

### On the front panel:

To increase the volume, turn MASTER VOLUME clockwise (+).

To decrease the volume, turn it counterclockwise (-).

- When you turn MASTER VOLUME rapidly, the volume level also changes rapidly.
- When you turn MASTER VOLUME slowly, the volume level also changes slowly.

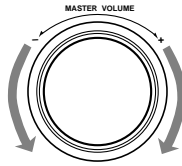

### From the remote control:

To increase the volume, press VOLUME +.

To decrease the volume, press VOLUME -.

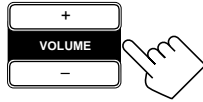

### CAUTION:

Always set the volume to the minimum before starting any source. If the volume is set at its high level, the sudden blast of sound energy can permanently damage your hearing and/or ruin your speakers.

### Note:

The volume level can be adjusted within the range of "0" (minimum) to "80" (maximum).

## Selecting the Front Speakers

### On the front panel ONLY:

When you have connected two pairs of the front speakers, you can select which to use. Pressing SPEAKERS 1 or SPEAKERS 2 activates the respective set of speakers.

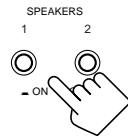

- To use the speakers connected to the **FRONT SPEAKERS ① terminals**, press SPEAKERS 1 to set it in the **ON** position, and press SPEAKERS 2 to set it in the **OFF** position.
- To use the speakers connected to the **FRONT SPEAKERS ② terminals**, press SPEAKERS 2 to set it in the **ON** position, and press SPEAKERS 1 to set it in the **OFF** position.
- To use **both sets of the speakers**, press SPEAKERS 1 to set it in the **ON** position, and press SPEAKERS 2 to set it in the **ON** position.
- To use **neither set of the speakers**, press SPEAKERS 1 and SPEAKERS 2 to set them in the **OFF** position.

### Note:

When only one set of the speakers is connected to either the **FRONT SPEAKERS ①** or **② terminals**, do not activate both pairs of the speakers. If you do, no sound comes out of the front speakers.

### Listening only with headphones

1. Connect a pair of headphones to the PHONES jack on the front panel.
2. Press SPEAKERS 1 and SPEAKERS 2 to set them in the **OFF** position.

### CAUTION:

Be sure to turn down the volume before connecting or putting on headphones, as high volume can damage both the headphones and your hearing.

### Note:

You cannot shut off the sound through the other speakers using the **SPEAKERS 1** and **2** buttons.

## Muting the Sound

### From the remote control ONLY:

Press **MUTING** to mute the sound through all speakers and headphones connected.

"MUTING" appears on the display and the volume turns off (the volume level indicator goes off).

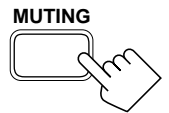

To restore the sound, press **MUTING** again.

- Turning **MASTER VOLUME** or pressing **VOLUME +/-** also restores the sound.

## Recording a Source

You can record any source playing through the receiver to a cassette deck (or an MD recorder) connected to the **TAPE/MD** jacks and the **VCR** connected to the **VCR** jacks at the same time.

While recording, you can listen to the selected sound source at whatever sound level you like, without affecting the sound levels of the recording.

### Note:

The output volume level, tone adjustment (see page 10), Bass Boost (see page 10) and DSP modes (see page 15) cannot affect the recording.

### IMPORTANT:

Before recording, turn off the **DVD MULTI** playback mode.

## Attenuating the Input Signal

When the input level of the playing source is too high, the sounds will be distorted. If this happens, you need to attenuate the input signal level to prevent the sound distortion.

### **On the front panel ONLY:**

Press INPUT ATT. so that the lamp next to the button lights up.

- Each time you press the button, the Input Attenuator mode turns on or off.

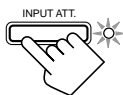

### **Note:**

When selecting "DVDMULTI" as the source, this effect only applies to front left and right channel signals.

## Adjusting the Front Speaker Output Balance

If the sounds you hear from the front right and left speakers are unequal, you can adjust the speaker output balance.

### **Before you start, remember...**

- There is a time limit in doing the following steps. If the setting is canceled before you finish, start from step 1 again.

### **On the front panel ONLY:**

1. Press ADJUST so that MULTI CURSOR  $\Delta$  /  $\nabla$  buttons work for adjusting the sound.

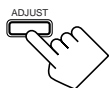

2. Press MULTI CURSOR  $\Delta$  /  $\nabla$  repeatedly until "BALANCE" appears on the display.

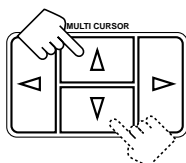

3. Press MULTI CURSOR  $\triangleleft$  /  $\triangleright$  to adjust the balance.

- Pressing  $\triangleleft$  decreases the right channel output.
- Pressing  $\triangleright$  decreases the left channel output.

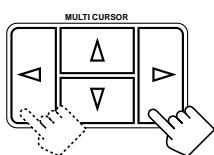

## Reinforcing the Bass

With this Bass Boost function, you can boost the bass level.

### **Before you start, remember...**

- There is a time limit in doing the following steps. If the setting is canceled before you finish, start from step 1 again.

### **On the front panel ONLY:**

1. Press ADJUST so that MULTI CURSOR  $\Delta$  /  $\nabla$  buttons work for adjusting the sound.



2. Press MULTI CURSOR  $\Delta$  /  $\nabla$  repeatedly until "B-BOOST" appears on the display.

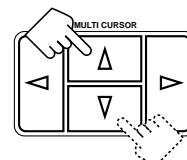

3. Press MULTI CURSOR  $\triangleleft$  /  $\triangleright$  to switch this function "ON" or "OFF."

- When this function is switched "ON," the BASS BOOST lamp on the front panel lights up.

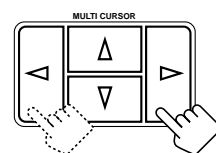

### **Note:**

The Bass Boost function affects the front speaker sounds only.

## Adjusting the Tone

You can adjust the treble and bass sounds as you like.

### **Before you start, remember...**

- There is a time limit in doing the following steps. If the setting is canceled before you finish, start from step 1 again.

### **On the front panel ONLY:**

1. Press ADJUST so that MULTI CURSOR  $\Delta$  /  $\nabla$  buttons work for adjusting the sound.



2. Press MULTI CURSOR  $\Delta$  /  $\nabla$  repeatedly until "- BASS +" or "-TREBLE+" appears on the display.

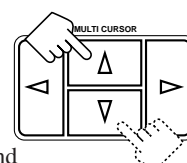

- Select "- BASS +" to adjust the bass sound level.
- Select "-TREBLE+" to adjust the treble sound level.

3. Press MULTI CURSOR  $\triangleleft$  /  $\triangleright$  to adjust the bass or treble sound level within the range of -10 to +10.

- Each time you press the button, the sound level changes by  $\pm 2$ .

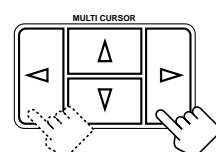

# Basic Settings

Some of the following settings are required after connecting and positioning your speakers in your listening room, while others will make operations easier.

## Changing the Source Name

When you have connected an MD recorder to the TAPE/MD jacks on the rear panel: Change the source name shown on the display when you select the MD recorder as the source.

### On the front panel ONLY:

When changing the source name from "TAPE" to "M D":

#### 1. Press TAPE/MD.

- Make sure "TAPE" appears on the display.

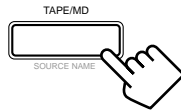

#### 2. Press and hold SOURCE NAME (the same button as TAPE/MD) until "M D" appears on the display.

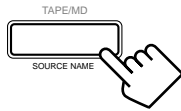

To change the source name from "M D" to "TAPE," repeat the same procedure above (in step 1, make sure "M D" appears on the display).

### Note:

Without changing the source name, you can still use the connected components. However, there may be some inconvenience.

- "TAPE" will appear on the display when you select the MD recorder.
- You cannot use the COMPU LINK remote control system (see page 21) to operate the MD recorder.

## Setting Center and Rear Speakers for the DSP Modes

To obtain the best possible surround sound of the DSP (Digital Signal Processor) modes (see page 15), you have to register the information about the speaker arrangement after all connections are completed.

### Center Speaker Setting

Register the center speaker size.

#### Before you start, remember...

- There is a time limit in doing the following steps. If the setting is canceled before you finish, start from step 1 again.

### On the front panel ONLY:

#### 1. Press SETTING so that MULTI CURSOR $\Delta / \nabla$ buttons work for setting the center speaker size.

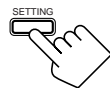

#### 2. Press MULTI CURSOR $\Delta / \nabla$ repeatedly until "CNTR SPK" (Center Speaker) appears on the display.

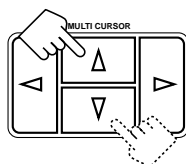

#### 3. Press MULTI CURSOR $\triangleleft / \triangleright$ to select your center speaker size.

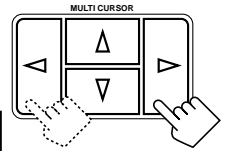
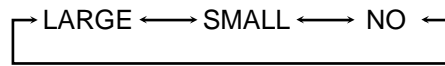

**LARGE:** Select this mode when the size of the center speaker is the same as that of the front speakers.

**SMALL:** Select this mode when the size of the center speaker is smaller than that of the front speakers.

**NO:** Select this mode when you do not use a center speaker.

### Rear Speaker Setting

Register whether you have connected the rear speakers or not.

#### Before you start, remember...

- There is a time limit in doing the following steps. If the setting is canceled before you finish, start from step 1 again.

### On the front panel ONLY:

#### 1. Press SETTING so that MULTI CURSOR $\Delta / \nabla$ buttons work for setting the rear speaker information.



#### 2. Press MULTI CURSOR $\Delta / \nabla$ repeatedly until "REAR SPK" (Rear Speaker) appears on the display.

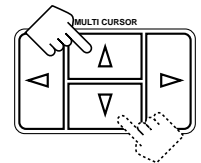

#### 3. Press MULTI CURSOR $\triangleleft / \triangleright$ to register whether you have connected the rear speakers.

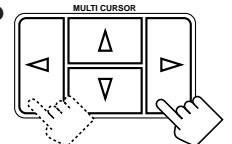

**YES:** Select this mode when you use rear speakers.

**NO:** Select this mode when you do not use rear speakers.

### Note:

When you change your speakers, you need to register the information about the speakers again.

### Delay Time Setting

Register the delay time of the sound from the rear speakers, comparing the sound from the front speakers.

#### Before you start, remember...

- There is a time limit in doing the following steps. If the setting is canceled before you finish, start from step 1 again.
- You can adjust the delay time only when you have connected the rear speakers and have set "REAR SPK" to "YES" (see above).
- Delay time setting is only valid for "PROLOGIC" (see page 15).



**On the front panel:**

1. Press **SETTING** so that **MULTI CURSOR**  $\Delta / \nabla$  buttons work for setting the delay time.



2. Press **MULTI CURSOR**  $\Delta / \nabla$  repeatedly until “-DELAY +” appears on the display.

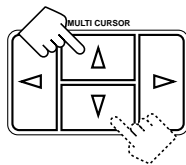

3. Press **MULTI CURSOR**  $\triangleleft / \triangleright$  to select an appropriate delay time.

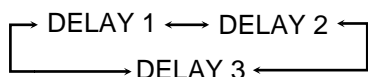
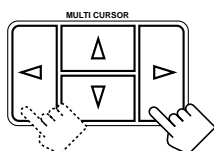

**DELAY 1:** Select this mode when the distance from you to your rear speakers is greater than that to the front speakers.

**DELAY 2:** Select this mode when the distance from you to your rear speakers is almost equal to that to the front speakers.

**DELAY 3:** Select this mode when the distance from you to your rear speakers is less than that to the front speakers.

**From the remote control:**

1. Press **SOUND CONTROL**.
2. Press **SURROUND** repeatedly until “PROLOGIC” appears on the display.
3. Press **DELAY** repeatedly until an appropriate delay time appears on the display.

## Storing the Basic Settings and Adjustments — One Touch Operation

JVC's One Touch Operation function is used to assign and store different sound settings for each different playing source. By using this function, you do not have to change the settings every time you change the source. The stored settings for the newly selected source are automatically recalled.

The following can be stored for each source:

- Volume level (see page 9)
- Input Attenuator (see page 10)
- Balance (see page 10)
- Bass Boost (see page 10)
- Tone adjustment (see page 10)
- DSP modes
  - 3D-PHONIC mode settings (see page 17)
  - DAP mode settings (see page 17)
  - Surround mode settings (see page 18)
- DVD MULTI playback mode settings (see page 20)

**To store the sound settings**

1. Press **ONE TOUCH OPERATION**.

The **ONE TOUCH OPERATION** lamp lights up, then the previously memorized settings are recalled.



On the front panel



On the remote

2. **Adjust the sound using the functions listed to the left.**

The newly adjusted settings are memorized.

**To recall the sound settings**

With the **ONE TOUCH OPERATION** lamp lit, the settings for the currently selected source are recalled, when the source is selected.

**To cancel the One Touch Operation function**

Press **ONE TOUCH OPERATION** so that the lamp goes off. (Even though the One Touch Operation function is canceled, the recalled sound effects remain active.)

**Notes:**

- If the source is FM or AM, you can assign a different setting for each band.
- The DSP modes and DVD MULTI playback mode cannot be used at the same time.

## Using the Sleep Timer

Using the Sleep Timer, you can fall asleep to music and know the receiver will turn off by itself rather than play all night.

**From the remote control ONLY:**

Press **SLEEP** repeatedly.

The **SLEEP** indicator lights up on the display, and the shut-off time changes as follows (in minutes):

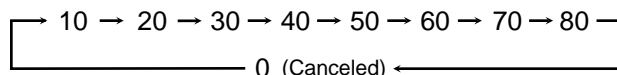
**When the shut-off time comes**

The receiver turns off automatically.

**To check or change the time remaining until the shut-off time**

Press **SLEEP** once.

The remaining time until the shut-off time appears in minutes.

- To change the shut-off time, press **SLEEP** repeatedly.

**To cancel the Sleep Timer**

Press **SLEEP** repeatedly until “0” appears on the display. (The **SLEEP** indicator goes off.)

Turning off the power also cancels the Sleep Timer.

# Receiving Radio Broadcasts

You can browse through all the stations or use the preset function to go immediately to a particular station.

## Setting the AM Tuner Interval Spacing

Some countries space AM stations 9 kHz apart, and other countries use 10 kHz spacing. When shipped, the spacing is set to 9 kHz.

### On the front panel ONLY:

#### To select the 10 kHz interval:

Be sure the receiver is tuned off, but is plugged into an AC outlet. Hold down MULTI CURSOR  $\Delta$  and press STANDBY/ON  $\text{O/I}$ . Now the 10 kHz interval is selected.



#### To change back to the 9 kHz interval:

Be sure the receiver is tuned off, but plugged into an AC outlet. Hold down MULTI CURSOR  $\nabla$  and press STANDBY/ON  $\text{O/I}$ . Now the 9 kHz interval is selected.



## Tuning in Stations Manually

### On the front panel ONLY:

#### 1. Press FM or AM.

The last station of the selected band is tuned in.

- MULTI CURSOR  $\Delta$  /  $\nabla$  /  $\triangleleft$  /  $\triangleright$  buttons can be now used for operating the tuner.

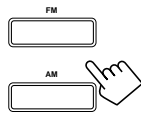

#### 2. Press MULTI CURSOR $\Delta$ / $\nabla$ repeatedly until “-TUNING+” appears on the display.

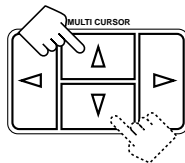

-- TUNING +

#### 3. Press MULTI CURSOR $\triangleleft$ / $\triangleright$ until you find the frequency you want.

- Pressing  $\triangleleft$  decreases the frequency.
- Pressing  $\triangleright$  increases the frequency.

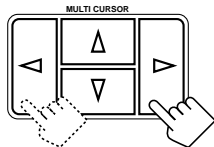

### Notes:

- When you hold MULTI CURSOR  $\triangleleft$  /  $\triangleright$  in step 3, the frequency keeps changing until a station is tuned in.
- When a station of sufficient signal strength is tuned in, the TUNED indicator lights up on the display. When an FM stereo program is received, the STEREO indicator also lights up.

## Using Preset Tuning

Once a station is assigned to a channel number, the station can be quickly tuned. You can preset up to 30 FM stations and 15 AM stations.

### To store the preset stations

#### Before you start, remember...

- There is a time limit in doing the following steps. If the setting is canceled before you finish, start from step 1 again.

### On the front panel ONLY:

#### 1. Tune in the station you want to preset (see “Tuning in Stations Manually”).

If you want to store the FM reception mode for this station, select the FM reception mode you want. See “Selecting the FM Reception Mode”.

#### 2. Press MEMORY.

“CH-” appears and the channel number position starts flashing on the display for about 5 seconds.

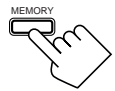

CH- \_ \_ \_

#### 3. Press MULTI CURSOR $\triangleleft$ / $\triangleright$ to select a channel number while the channel number position is flashing.

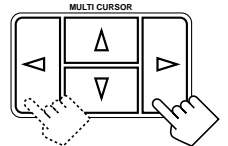

#### Note:

You can use the 10 keys on the remote control to select the preset number. When using the 10 keys, be sure that they are activated for the tuner, not for the CD and others. (See page 22.)

#### 4. Press MEMORY again while the selected channel number is flashing on the display.

The selected channel number stops flashing. The station is assigned to the selected channel number.

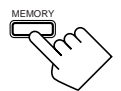

#### 5. Repeat steps 1 to 4 until you store all the stations you want.

### To erase a stored preset station

Storing a new station on a used number erases the previously stored one.



## To tune in a preset station

### On the front panel:

#### 1. Press FM or AM.

The last station of the selected band is tuned in.

- MULTI CURSOR  $\Delta$  /  $\nabla$  /  $\triangleleft$  /  $\triangleright$  buttons can be now used for operating the tuner.

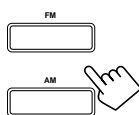

#### 2. Press MULTI CURSOR $\Delta$ / $\nabla$ repeatedly until “-PRESET+” appears on the display.

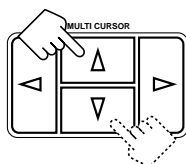

#### 3. Press MULTI CURSOR $\triangleleft$ / $\triangleright$ to select a preset channel station.

- Pressing  $\triangleleft$  decreases the preset channel number.
- Pressing  $\triangleright$  increases the preset channel number.

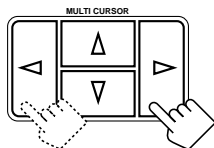

### From the remote control:

#### 1. Press FM/AM.

The last station is tuned in.

- Each time you press the button, the band alternates between FM and AM.

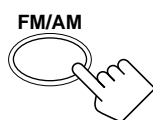

#### 2. Press the 10 keys to select a preset channel number.

- For channel number 5, press 5.
- For channel number 15, press +10 then 5.
- For channel number 20, press +10 then 10.
- For channel number 30, press +10, +10, then 10.

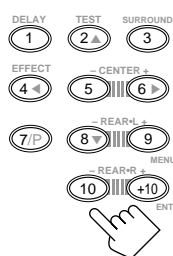

### Note:

When you use the 10 keys on the remote control, be sure that they are activated for the tuner, not for the CD and others. (See page 22.)

## Selecting the FM Reception Mode

### When an FM stereo broadcast is hard to receive or noisy

You can change the FM reception mode while receiving an FM broadcast.

### On the front panel ONLY:

#### 1. Press FM.

The last station of the selected band is tuned in.

- MULTI CURSOR  $\Delta$  /  $\nabla$  /  $\triangleleft$  /  $\triangleright$  buttons can be now used for operating the tuner.

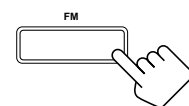

#### 2. Press MULTI CURSOR $\Delta$ / $\nabla$ repeatedly until “FM MODE” appears on the display.

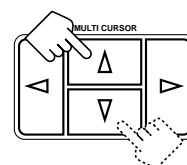

FM MODE

#### 3. Press MULTI CURSOR $\triangleleft$ / $\triangleright$ to switch the FM reception “FM MONO” or “FM AUTO.”

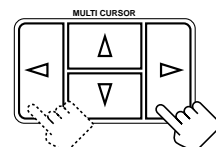

FM MONO



FM AUTO

**FM MONO:** Reception will be improved although you will lose the stereo effect. In this mode, you will hear noise while tuning into the stations. The MUTE AUTO indicator goes off on the display.

**FM AUTO:** When a program is broadcasted in stereo, you will hear stereo sound; when in monaural, you will hear monaural sounds. This mode is also useful to suppress static noise between stations. The MUTE AUTO indicator lights up on the display.

# Using the DSP Modes

The built-in Surround Processor provides three types of the DSP (Digital Signal Processor) mode — 3D-PHONIC mode, DAP (Digital Acoustic Processor) mode and Surround mode (Dolby Pro Logic and JVC Theater Surround).

## 3D-PHONIC modes

The 3D-PHONIC mode gives you such a nearly surround effect as it is reproduced through the Dolby Surround decoder, which is widely used to reproduce sounds with a feeling of movement like those experienced in movie theaters. The 3D-PHONIC mode is the result of research on sound localization technology carried out at JVC for many years. **This mode can be used when two front speakers are connected to this receiver (without respect to the rear/center speaker connection).**

You can select either 3D ACTION or 3D THEATER to your preference.

---

**3D ACTION:** Best for action and war movies — where the action is fast and explosive.

---

**3D THEATER:** Reproduces the sound field of a large theater.

---

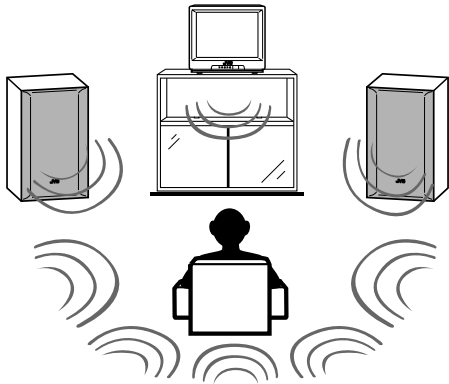

## DAP modes

The sound heard in a concert hall or club consists of direct sound and indirect sound — early reflections and reflections from behind. Direct sounds reach the listener directly without any reflection. On the other hand, indirect sounds are delayed by the distances of the ceiling and walls. These direct sounds and indirect sounds are the most important elements of the acoustic surround effects. The DAP mode can create these important elements, and gives you a real “being there” feeling. **This mode can be used when the front speakers are connected to this receiver (without respect to the rear/center speaker connection).**

You can select one of the following to your preference.

---

**DANCE CLUB:** Gives a throbbing bass beat.

---

**LIVE CLUB:** Gives the feeling of a live music club with a low ceiling.

---

**HALL:** Gives clear vocal and the feeling of a concert hall.

---

**PAVILION:** Gives the spacious feeling of a pavilion with a high ceiling.

---

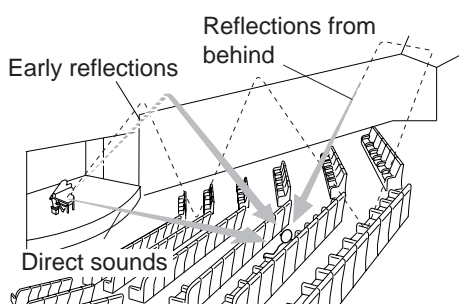

## Surround Modes

With this receiver, you can use two types of the Surround modes.

### • Dolby Surround

Dolby Surround has been developed to reproduce the important elements of the acoustic surround at home.

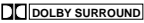
To watch the soundtracks of video software bearing the mark  \* which includes the same encoded surround information as found in Dolby Stereo films, the receiver can provide you with Dolby Surround decoder.

There are two types of Dolby Surround – “Pro Logic” and “3 Stereo.”

**“Pro Logic” can be used when the front speakers and rear speakers are connected to this receiver (regardless of the center speaker connection). On the other hand, “3 Stereo” can be used when the rear speakers are not connected (center speaker must be connected).**

### • JVC Theater Surround

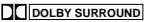
In order to reproduce a more realistic sound field in your listening room while playing soundtracks of video software bearing the mark  , JVC Theater Surround has been designed to give you clearer vocals and to create a real “being there” feeling.

**This mode can be used when the front speakers and rear speakers are connected to this receiver (without respect to the center speaker connection).**

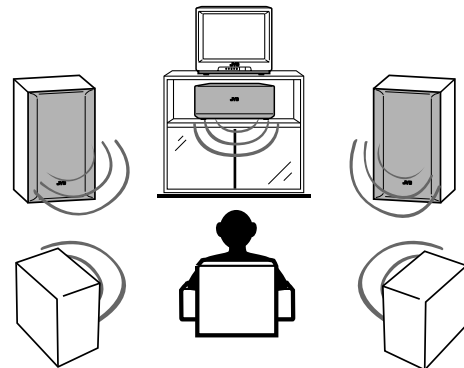

### Notes:

- The DSP modes have no effect on monaural sources.
- The DSP modes cannot be used for recording.
- When you select “DVMULTI” as the source to play, you cannot select or adjust the DSP modes.

### IMPORTANT:

Before recording, turn off the DVD MULTI playback mode.

---

**As for the DVD MULTI playback mode, see page 20.**

\* Manufactured under license from Dolby Laboratories Licensing Corporation. “Dolby,” the double-D symbol, and “Pro Logic” are trademarks of Dolby Laboratories Licensing Corporation.

## Available DSP Modes According to the Speaker Arrangement

Available DSP modes will vary depending on how many speakers are used with this receiver.

**Make sure that you have set the speaker information correctly (see page 11).**

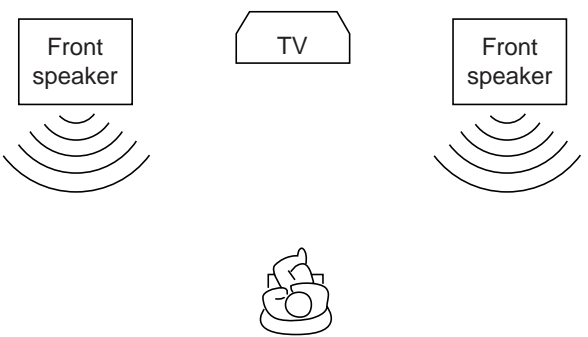
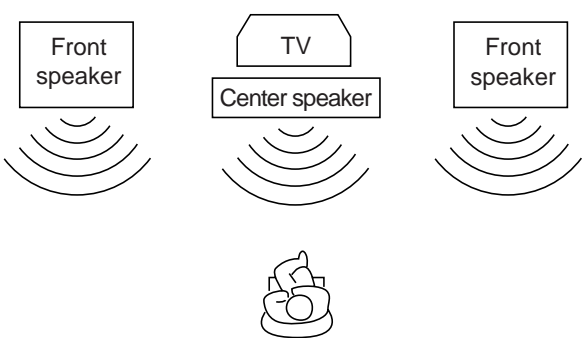
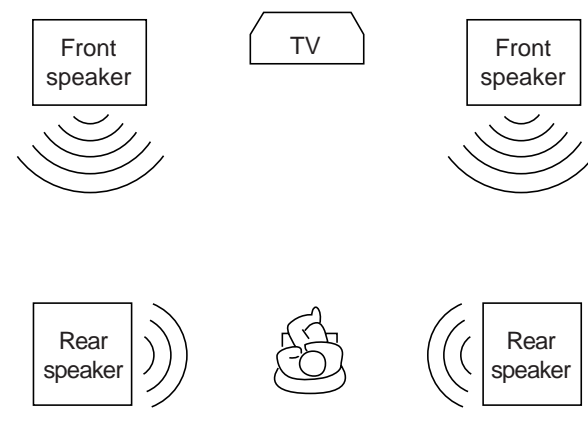
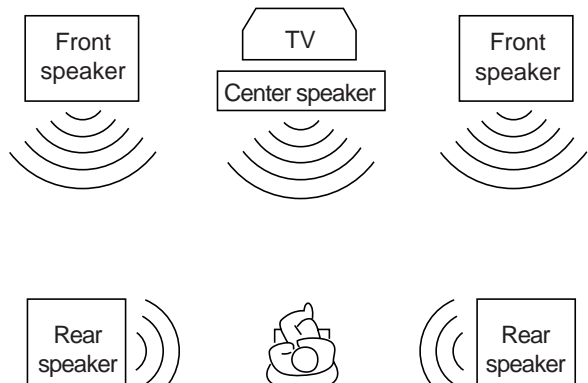
Speaker arrangements	Available DSP modes
 <p>Diagram showing two front speakers, a TV, and a subwoofer.</p>	<p>Each time you press SURROUND, the DSP modes change as follows:</p> <ul style="list-style-type: none"> <li>• 3D THEATER</li> <li>• DANCE C (DANCE CLUB)</li> <li>• LIVE C (LIVE CLUB)</li> <li>• HALL</li> <li>• PAVILION</li> <li>• 3D ACTION</li> <li>• OFF (DSP mode is canceled)</li> </ul>
 <p>Diagram showing two front speakers, a TV, and a center speaker.</p>	<p>Each time you press SURROUND, the DSP modes change as follows:</p> <ul style="list-style-type: none"> <li>• 3 STEREO</li> <li>• 3D THEATER</li> <li>• DANCE C (DANCE CLUB)</li> <li>• LIVE C (LIVE CLUB)</li> <li>• HALL</li> <li>• PAVILION</li> <li>• 3D ACTION</li> <li>• OFF (DSP mode is canceled)</li> </ul>
 <p>Diagram showing two front speakers, a TV, and two rear speakers.</p>	<p>Each time you press SURROUND, the DSP modes change as follows:</p> <ul style="list-style-type: none"> <li>• PRO LOGIC</li> <li>• THEATER</li> <li>• DANCE C (DANCE CLUB)</li> <li>• LIVE C (LIVE CLUB)</li> <li>• HALL</li> <li>• PAVILION</li> <li>• 3D ACTION</li> <li>• OFF (DSP mode is canceled)</li> </ul>
 <p>Diagram showing two front speakers, a TV, a center speaker, and two rear speakers.</p>	<p>Each time you press SURROUND, the DSP modes change as follows:</p> <ul style="list-style-type: none"> <li>• PRO LOGIC</li> <li>• THEATER</li> <li>• DANCE C (DANCE CLUB)</li> <li>• LIVE C (LIVE CLUB)</li> <li>• HALL</li> <li>• PAVILION</li> <li>• 3D ACTION</li> <li>• OFF (DSP mode is canceled)</li> </ul>

## Adjusting the 3D-PHONIC Modes

Before you start, remember...

- Make sure that you have set the speaker information correctly (see page 11).
- There is a time limit in doing the following steps. If the setting is canceled before you finish, start from step 1 again.

**On the front panel:**

1. Press **SURROUND** repeatedly until “3DACTION” or “3DTHEATR” appears on the display.

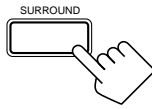

The 3D-PHONIC and PRO LOGIC indicators also light up on the display.

2. Press **ADJUST** so that **MULTI CURSOR**  $\Delta / \nabla / \triangleleft / \triangleright$  buttons work for adjusting the surround setting.



3. Press **MULTI CURSOR**  $\Delta / \nabla$  repeatedly until “-EFFECT+” appears on the display.

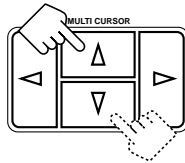

4. Press **MULTI CURSOR**  $\triangleleft / \triangleright$  to select an effect level you want.

- Each time you press the button, the effect level changes as follows:

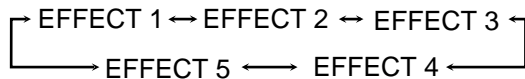

As the number increases, the selected 3D-PHONIC mode becomes stronger.

**From the remote control:**

1. Press **SOUND CONTROL**.

The 10 keys are activated for sound adjustments.



2. Press **SURROUND** repeatedly until “3DACTION” or “3DTHEATR” appears on the display.

The 3D-PHONIC and PRO LOGIC indicators also light up on the display.



3. Press **EFFECT** to select an effect level you want.

- Each time you press the button, the effect level changes as follows:

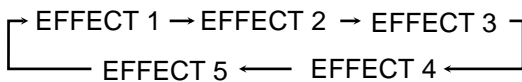

As the number increases, the selected 3D-PHONIC mode becomes stronger.

## Adjusting the DAP Modes

Before you start, remember...

- Make sure that you have set the speaker information correctly (see page 11).
- There is a time limit in doing the following steps. If the setting is canceled before you finish, start from step 1 again.
- You can only adjust the rear speaker output level when you have connected the rear speakers and have set “REAR SPK” to “YES” (see page 11).

**On the front panel:**

1. Press **SURROUND** repeatedly until the DAP mode — **DANCE CLUB, LIVE CLUB, HALL, or PAVILION** — appears on the display.

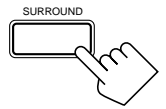

The DAP indicator also lights up on the display.

2. Press **ADJUST** so that **MULTI CURSOR**  $\Delta / \nabla / \triangleleft / \triangleright$  buttons work for adjusting the DSP setting.

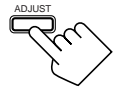

3. Press **MULTI CURSOR**  $\Delta / \nabla$  repeatedly until “- REAR +” appears on the display.

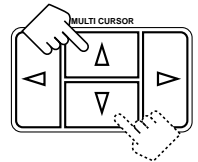

4. Press **MULTI CURSOR**  $\triangleleft / \triangleright$  to adjust the rear speaker output level (from -10 to +10).

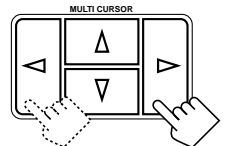

**Note:**

You cannot adjust the left and right rear speaker output levels separately.

5. Press **MULTI CURSOR**  $\Delta / \nabla$  repeatedly until “-EFFECT+” appears on the display.

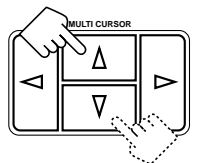

6. Press **MULTI CURSOR**  $\triangleleft / \triangleright$  to select an effect level you want.

- Each time you press the button, the effect level changes as follows:

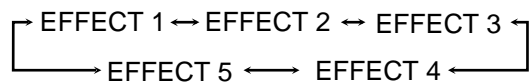
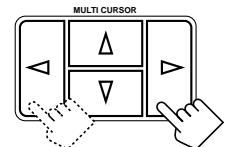

As the number increases, the selected DAP mode becomes stronger.

**From the remote control:****1. Press SOUND CONTROL.**

The 10 keys are activated for sound adjustments.

**2. Press SURROUND repeatedly until the DAP mode — DANCE CLUB, LIVE CLUB, HALL, or PAVILION — appears on the display.**

The DAP indicator also lights up on the display.

**3. Press REAR•L - / + to adjust the rear speaker output level.**

- Pressing REAR•L - decreases the output level up to -10 dB.
- Pressing REAR•L + increases the output level up to +10 dB.

**Note:**

You cannot adjust the left and right rear speaker output levels separately.

**4. Press EFFECT to select an effect level you want.**

- Each time you press the button, the effect level changes as follows:

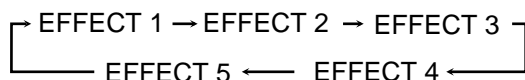

As the number increases, the selected DAP mode becomes stronger.



## Adjusting the Surround Modes — Dolby Surround and JVC Theater Surround

**Before you start, remember...**

- Make sure that you have set the speaker information correctly (see page 11).
- There is a time limit in doing the following steps. If the setting is canceled before you finish, start from step 1 again.
- You can only adjust the effect level when selecting JVC Theater Surround.
- You can only adjust the rear and/or center speaker output levels when you have connected rear speakers and/or a center speaker and have set "REAR SPK" and/or "CNTR SPK" correctly. See page 11.

**From the remote control:****1. Press SOUND CONTROL.**

The 10 keys are activated for sound adjustments.

**2. Press SURROUND repeatedly until the mode — "PROLOGIC," "3 STEREO," or "THEATER" — appears on the display.**

- For "PROLOGIC" and "3 STEREO," the PRO LOGIC indicator lights up on the display.
- For "THEATER," the PRO LOGIC and DAP indicators light up on the display.

**3. Press TEST to check the speaker output balance.**

"TEST" starts flashing on the display, and a test tone comes out of the speakers in the following order:

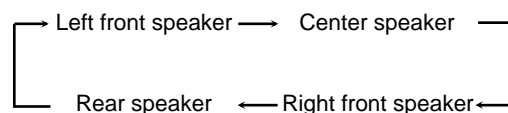
**Note:**

You can adjust the speaker output levels without outputting the test tone.

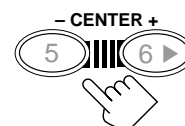
**4. Press CENTER - / + repeatedly to adjust the center speaker output level (from -10 to +10).****5. Press REAR•L - / + to adjust the rear speaker output level (from -10 to +10).****Notes:**

- You cannot adjust the left and right rear speaker output levels separately.
- You cannot use the REAR•R - / + buttons to adjust the rear speaker output level.

**6. Press TEST again to stop the test tone.****7. ONLY FOR JVC Theater Surround:****Press EFFECT to select an effect level you want.**

- Each time you press the button, the effect level changes as follows:

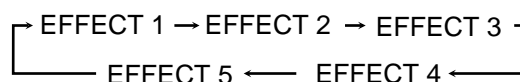

As the number increases, JVC Theater Surround becomes stronger.



**On the front panel:**

You can also use the buttons on the front panel to adjust the Surround modes. However, no test tone is available when using the buttons on the front panel. So, make adjustments while listening to the sound of the source played back.

1. Press **SURROUND** repeatedly until the mode — “PROLOGIC,” “3 STEREO,” or “THEATER” — appears on the display.

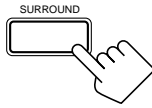

The PRO LOGIC indicator lights up on the display.

2. Press **ADJUST** so that **MULTI CURSOR**  $\Delta / \nabla / \triangleleft / \triangleright$  buttons work for adjusting the DSP setting.

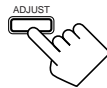

3. Press **MULTI CURSOR**  $\Delta / \nabla$  repeatedly until “-CENTER+” appears on the display.

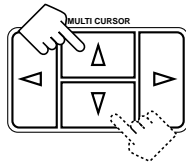

4. Press **MULTI CURSOR**  $\triangleleft / \triangleright$  to adjust the center speaker output level (from -10 to +10).

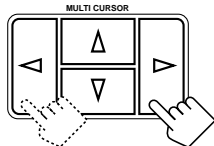

5. Press **MULTI CURSOR**  $\Delta / \nabla$  repeatedly until “- REAR +” appears on the display.

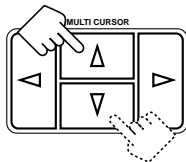

6. Press **MULTI CURSOR**  $\triangleleft / \triangleright$  to adjust the rear speaker output level (from -10 to +10).

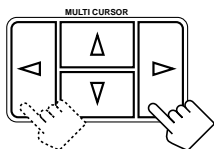
**Note:**

You cannot adjust the left and right rear speaker output levels separately.

7. **ONLY FOR JVC Theater Surround:**

Press **MULTI CURSOR**  $\Delta / \nabla$  repeatedly until “-EFFECT+” appears on the display.

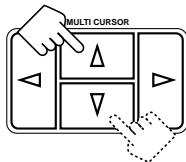

8. **ONLY FOR JVC Theater Surround:**

Press **MULTI CURSOR**  $\triangleleft / \triangleright$  to select an effect level you want.

- Each time you press the button, the effect level changes as follows:

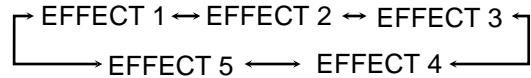
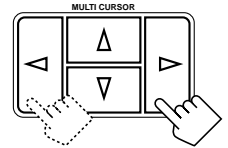

As the number increases, JVC Theater Surround becomes stronger.

**Activating the DSP Modes**

Once you have finished adjustments for the DSP modes, you can use the same adjustments every time you want to use these modes.

**On the front panel:**

1. Press **SURROUND** repeatedly until the DSP mode you want appears on the display.

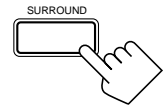

- Each time you press the button, the DSP modes change. (See page 16 for more details.)

2. **Select and play a sound source.**

- To enjoy the 3D-PHONIC, Dolby Surround, and JVC Theater Surround, play back a software which was processed with Dolby Surround and is labeled with mark.

**To cancel the DSP mode**

Press **SURROUND** repeatedly until “OFF” appears on the display.

**From the remote control:**

1. Press **SOUND CONTROL**.

The 10 keys are activated for sound adjustments.



2. Press **SURROUND** repeatedly until the DSP mode you want appears on the display.

- Each time you press the button, the DSP modes change. (See page 16 for more details.)



3. **Select and play a sound source.**

- To enjoy the 3D-PHONIC, Dolby Surround, and JVC Theater Surround, play back a software which was processed with Dolby Surround and is labeled with mark.

**To cancel the DSP mode**

Press **SURROUND** repeatedly until “OFF” appears on the display in step 2 above.



# Using the DVD MULTI Playback Mode

This receiver provides the DVD MULTI playback mode for reproducing the analog discrete output mode of the DVD player. Before playing back a DVD, refer also to the manual supplied with the DVD player.

## Activating the DVD MULTI Playback Mode

You can adjust the DVD MULTI playback mode while playing back a DVD using the analog discrete output mode on the DVD player. Once you made adjustments, the receiver memorizes the adjustments until you change them.

### Before you start, remember...

- Make sure that you have set the speaker information correctly (see page 11).
- There is a time limit in doing the following steps. If the setting is canceled before you finish, start from step 1 again.
- You can only adjust the rear and/or center speaker output levels when you have connected rear speakers and/or a center speaker and have set "REAR SPK" and/or "CNTR SPK" correctly. See page 11.

### On the front panel:

1. Press DVD MULTI.



#### Note:

When you select "DVDMULTI" as the source to play, the DSP mode is canceled temporarily, and the SURROUND button does not work.

2. Select the analog discrete output mode on the DVD player, and start playing a DVD.

- Refer to the manual supplied with the DVD player.

If you need to make any adjustment, go to the following steps.

3. Press ADJUST so that MULTI CURSOR  $\Delta / \nabla / \triangleleft / \triangleright$  buttons work for adjusting the DVD MULTI playback setting.



4. Press MULTI CURSOR  $\Delta / \nabla$  repeatedly until "-CENTER+" appears on the display.

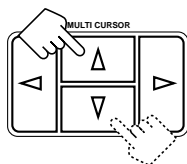

5. Press MULTI CURSOR  $\triangleleft / \triangleright$  to adjust the center speaker output level (from -10 to +10).

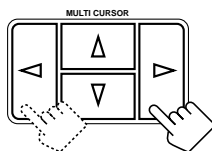

6. Press MULTI CURSOR  $\Delta / \nabla$  repeatedly until "-REAR L+" appears on the display.

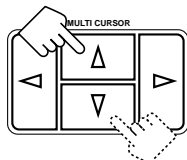

7. Press MULTI CURSOR  $\triangleleft / \triangleright$  to adjust the left rear speaker output level (from -10 to +10).

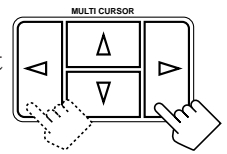

8. Press MULTI CURSOR  $\Delta / \nabla$  repeatedly until "-REAR R+" appears on the display.

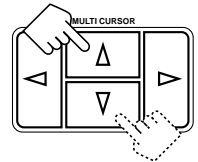

9. Press MULTI CURSOR  $\triangleleft / \triangleright$  to adjust the right rear speaker output level (from -10 to +10).

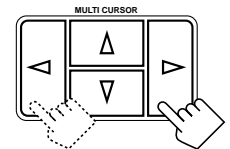

### From the remote control:

1. Press DVD MULTI.



#### Note:

When you select "DVDMULTI" as the source to play, the DSP mode is canceled temporarily, and the SURROUND button does not work.

2. Select the analog discrete output mode on the DVD player, and start playing a DVD.

- Refer to the manual supplied with the DVD player.

If you need to make any adjustment, go to the following steps.

3. Press SOUND CONTROL.

The 10 keys are activated for adjusting the sound.

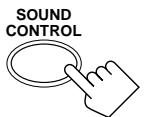

4. Press CENTER - / + to adjust the center speaker output level.

- Pressing CENTER - decreases the output level up to -10 dB.
- Pressing CENTER + increases the output level up to +10 dB.



5. Press REAR•L - / + to adjust the left rear speaker output level.

- Pressing REAR•L - decreases the output level up to -10 dB.
- Pressing REAR•L + increases the output level up to +10 dB.



6. Press REAR•R - / + to adjust the right rear speaker output level.

- Pressing REAR•R - decreases the output level up to -10 dB.
- Pressing REAR•R + increases the output level up to +10 dB.



# COMPU LINK Remote Control System

The COMPU LINK remote control system allows you to operate JVC audio components through the remote sensor on the receiver.

To use this remote control system, you need to connect JVC audio components through the COMPU LINK-3 (SYNCHRO) jacks (see below) in addition to the connections using cables with RCA pin plugs (see page 5).

- Make sure that the AC power cords of these components are unplugged before connection. Plug the AC power cords only after all connections are complete.

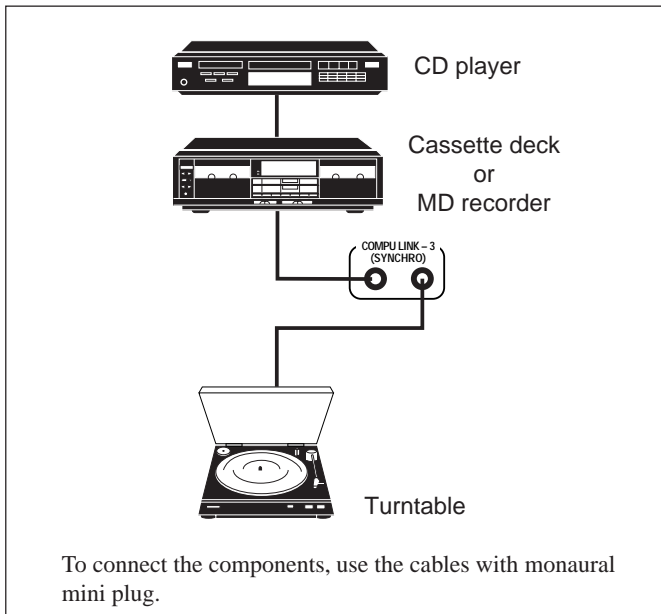

## Notes:

- If your audio component has two COMPU LINK-3 (SYNCHRO) jacks, you can use either one. If it has only one COMPU LINK-3 (SYNCHRO) jack, connect it so that it is the last item in the series of components. (For example, the turntable or CD player in the diagram above.)
- To operate the cassette deck or MD recorder using the COMPU LINK remote control system, set the source name correctly. (See page 11.)
- Refer also to the manuals supplied with your audio components.

This remote control system allows you to use four functions listed below.

## Remote Control through the Remote Sensor on the Receiver

You can control the connected audio components through the remote sensor on the receiver using this remote control. Aim the remote control directly at the remote sensor on the receiver. For details, see pages 22 and 23.

## Automatic Source Selection

When you press the play (▶) button on a connected component or on its own remote control, the receiver automatically turns on and changes the source to the component. On the other hand, if you select a new source on the receiver or the remote control, the selected component begins playing immediately.

In both cases, the previously selected source continues playing without sound for a few seconds.

## Automatic Power On/Off (Standby): only possible with the COMPU LINK-3 connection

Both the CD player and cassette deck (or MD recorder) turn on and off (standby) along with the receiver.

When you turn on the receiver, the CD player or cassette deck (or MD recorder) will turn on automatically, depending on which component has been previously selected.

When you turn off the receiver, both the CD player and cassette deck (or MD recorder) will turn off (standby).

## Synchronized Recording

Synchronized recording means the cassette deck (or MD recorder) starts recording as soon as a CD or a record begins playing.

To use synchronized recording, follow these steps:

1. Put a tape in the cassette deck (or an MD in the MD recorder), and a disc in the CD player (or a record on the turntable).
2. Press the record (●) button and the pause (⏸) button on the cassette deck (or MD recorder) at the same time.

This puts the cassette deck (or MD recorder) into recording pause.

If you do not press the record (●) button and pause (⏸) button at the same time, the synchronized recording feature will not operate.

3. Press the play (▶) button on the CD player or on the turntable.

The source changes on the receiver, and as soon as play starts, the cassette deck (or MD recorder) starts recording. When the play ends, the cassette deck (or MD recorder) enters recording pause, and stops about 4 seconds later.

## Notes:

- During synchronized recording, the selected source cannot be changed.
- If the power of any component is shut off during synchronized recording, the COMPU LINK remote control system may not operate properly. In this case, you must start again from the beginning.



# Operating JVC's Audio/Video Components

You can operate JVC's audio and video components with this receiver's remote control, since control signals for JVC components are preset in the remote control.

## IMPORTANT:

To operate JVC's audio components using this remote control:

- You need to connect JVC audio components through the COMPU LINK-3 (SYNCHRO) jacks (see page 21) in addition to the connections using cables with RCA pin plugs (see page 5).
- Aim the remote control directly at the remote sensor on the receiver.
- If you use the buttons on the front panel to choose a source, the remote control will not operate that source. To operate a source with the remote control, the source must be selected using buttons on the remote control.
- Refer also to the manuals supplied with your components.

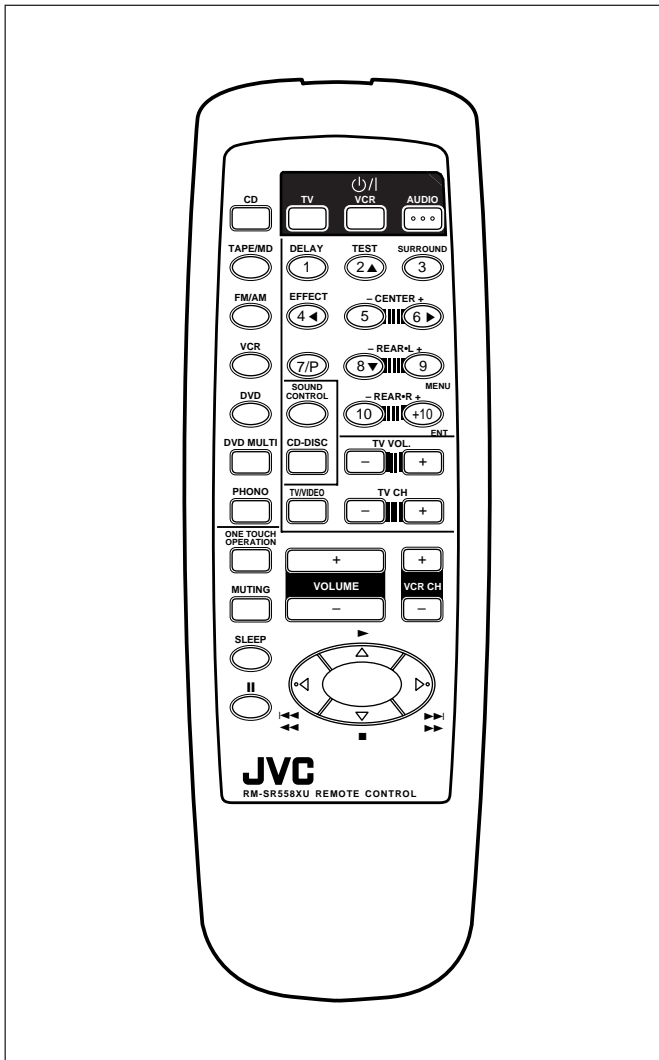

## Tuner

After pressing FM/AM, you can perform the following operations:

- FM/AM: Alternates between FM and AM.  
1 – 10, +10: Selects a preset channel number directly.  
For channel number 5, press 5.  
For channel number 15, press +10, then 5.  
For channel number 20, press +10, then 10.

## Sound control section (Amplifier)

After pressing SOUND CONTROL, you can perform the following operations:

- SURROUND: Selects the DSP modes.  
CENTER – / +: Adjusts the center speaker output level for the Surround/DVD MULTI playback modes.  
REAR•L – / +: Adjusts the left/right rear speaker output level for the DSP modes.  
Adjusts the left rear speaker output level for the DVD MULTI playback mode.  
REAR•R – / +: Adjusts the right rear speaker output level for the DVD MULTI playback mode.  
DELAY: Selects the delay time of the rear speaker sound. (Only works when "PROLOGIC" is selected.)  
EFFECT: Selects the effect level for the DSP modes.  
TEST: Turns on or off the test tone output for the Surround mode.

## Note:

After adjusting sounds, press the corresponding source selecting button or CD-DISC to operate your target source by using the 10 keys; otherwise, the 10 keys cannot be used for operating your target source.

## Cassette deck

After pressing TAPE/MD, you can perform the following operations on a cassette deck:

- ▶: Starts playing.  
◀◀: Fast winds the tape from right to left.  
▶▶: Fast winds the tape from left to right.  
■: Stops operations.  
||: Pauses playing. To release it, press ▶.

## Note:

To operate the cassette deck or MD recorder using the COMPU LINK remote control system, set the source name correctly. (See page 11.)

## CD player

After pressing CD, you can perform the following operations on the CD player:

- ▶: Starts playing.  
◀◀: Returns to the beginning of the current (or previous) track.  
▶▶: Skips to the beginning of the next track.  
■: Stops playing.  
||: Pauses playing. To release it, press ▶.  
1 – 10, +10: Selects a track number directly.  
For track number 5, press 5.  
For track number 15, press +10, then 5.  
For track number 20, press +10, then 10.

**CD player-changer**

After pressing CD-DISC, you can perform the following operations on a CD player-changer:

- ▶: Starts playing.
- ◀◀: Returns to the beginning of the current (or previous) track.
- ▶▶: Skips to the beginning of the next track.
- : Stops playing.
- ||: Pauses playing. To release it, press ▶.
- 1 – 6, 7/P: Selects the number of a disc installed in a CD player-changer.

After pressing CD, you can perform the following operations on the CD player-changer:

- 1 – 10, +10: Selects a track number directly.  
For track number 5, press 5.  
For track number 15, press +10, then 5.  
For track number 20, press +10, then 10.

**MD recorder**

After pressing TAPE/MD, you can perform the following operations on the MD recorder:

- ▶: Starts playing.
- ◀◀: Returns to the beginning of the current (or previous) track.
- ▶▶: Skips to the beginning of the next track.
- : Stops playing.
- ||: Pauses playing. To release it, press ▶.

**Note:**

To operate the cassette deck or MD recorder using the COMPU LINK remote control system, set the source name correctly. (See page 11.)

**IMPORTANT:**

To operate JVC's video components using this remote control:

- Aim the remote control directly at the remote sensor on the VCR, DVD player or TV, not on the receiver.
- Some JVC VCRs can accept two types of the control signals — remote code "A" and "B." Before using this remote control, make sure that the remote control code of the VCR connected to the VCR jacks is set to code "A."

**VCR**

You can always perform the following operations :

VCR  $\odot/|$ : Turns on or off the VCR.

VCR CH +/-: Changes the channels on the VCR.

After pressing VCR, you can perform the following operations on the VCR:

- ▶: Starts playing.
- ◀◀: Rewinds a tape.
- ▶▶: Fast winds a tape.
- : Stops operations.
- ||: Pauses playing. To release it, press ▶.

**DVD player**

After pressing DVD or DVD MULTI, you can perform the following operations on a DVD player:

- ▶: Starts playing.
- ◀◀: Returns to the beginning of the current (or previous) track.
- ▶▶: Skips to the beginning of the next track.
- : Stops playing.
- ||: Stops playing temporarily. To release it, press ▶.

After pressing DVD or DVD MULTI, these buttons can be used for the DVD menu operations.

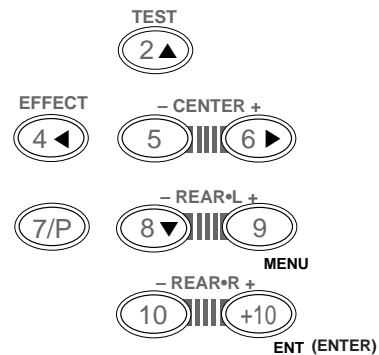
**Note:**

For detailed menu operations, refer to the instructions supplied with the discs or the DVD player.

**TV**

You can always perform the following operations:

TV  $\odot/|$ : Turns on or off the TV.

TV VOL. +/-: Adjusts the volume.

TV/VIDEO: Sets the input mode (either TV or VIDEO).

TV CH +/-: Changes the channels.

# Troubleshooting

Use this chart to help you solve daily operational problems. If there is any problem you cannot solve, contact your JVC service center.

PROBLEM	POSSIBLE CAUSE	SOLUTION
The display does not light up.	The power cord is not plugged in.	Plug the power cord into an AC outlet.
No sound from speakers.	Speaker signal cables are not connected.	Check speaker wiring and reconnect if necessary.
	The SPEAKERS 1 and 2 buttons are not set correctly.	Press SPEAKERS 1 and 2 correctly.
	An incorrect source is selected.	Select the correct source.
	Muting is activated.	Press MUTING to cancel the mute.
Sound from one speaker only.	Speaker signal cables are not connected properly.	Check speaker wiring and reconnect if necessary.
	The balance is set to one extreme.	Adjust the balance properly (see page 9).
Continuous hiss or buzzing during FM reception.	Incoming signal is too weak.	Connect an outside FM antenna or contact your dealer.
	The station is too far away.	Select a new station.
	An incorrect antenna is used.	Check with your dealer to be sure you have the correct antenna.
	Antennas are not connected properly.	Check connections.
Occasional cracking noise during FM reception.	Ignition noise from automobiles.	Move the antenna farther from automobile traffic.
Howling during record playing.	Your turntable is too close to speakers.	Move speakers away from the turntable.
"OVERLOAD" starts flashing on the display.	Speakers are overloaded because of high volume.	Rotate the MASTER VOLUME control counterclockwise three or four times, then press STANDBY/ON (⏻) on the front panel. If "OVERLOAD" does not disappear, unplug the AC power cord, then plug it back again.
	Speakers are overloaded because of short circuit of speaker terminals.	Press STANDBY/ON (⏻) on the front panel, then check the speaker wiring. If "OVERLOAD" does not disappear, unplug the AC power cord, then plug it back again. If speaker wiring is not short-circuited, contact your dealer.
Remote control does not work.	There is an obstruction in front of the remote sensor on the receiver.	Remove the obstruction.
	Batteries are weak.	Replace batteries.

## **Amplifier**

### Output Power

At Stereo operation: 100 W per channel, min. RMS, both channels driven into 8  $\Omega$  at 1 kHz, with no more than 0.9% total harmonic distortion. (IEC268-3/DIN)

### At Surround operation:

Front Channel: 70 W per channel, min. RMS, driven into 8  $\Omega$  at 1 kHz, with no more than 0.8% total harmonic distortion.

Center channel: 70 W, min. RMS, driven into 8  $\Omega$  at 1 kHz, with no more than 0.8% total harmonic distortion.

Rear channel: 70 W per channel, min. RMS, driven into 8  $\Omega$  at 1 kHz, with no more than 0.8% total harmonic distortion.

### Total Harmonic Distortion (8 $\Omega$ , 1 kHz):

0.8%\* at 100 W output

(\* Measured by JVC Audio Analysis System)

## **Audio**

### Audio Input Sensitivity/Impedance (1 kHz):

PHONO (MM): 2.7 mV/47 k  $\Omega$

CD, TAPE/MD, VCR, DVD:  
220 mV/47 k  $\Omega$

Audio Output Level: TAPE/MD, VCR 220 mV

### Signal-to-Noise Ratio ('66 IHF/DIN):

PHONO: 70 dB/66 dB

CD, TAPE/MD, VCR, DVD:  
87 dB/67 dB

### Frequency Response (8 $\Omega$ ):

PHONO: 20 Hz to 20 kHz ( $\pm$ 1 dB)

CD, TAPE/MD, VCR, DVD:  
20 Hz to 20 kHz ( $\pm$ 1 dB)

RIAA Phono Equalization:  $\pm$ 1.0 dB (20 Hz to 20 kHz)

## **Video**

### Video Input Sensitivity/Impedance:

VCR, DVD: 1V(p-p)/75  $\Omega$

### Video Output Level:

VCR, MONITOR OUT: 1V(p-p)/75  $\Omega$

Synchronization: Negative

Signal-to-Noise Ratio: 45 dB

**FM tuner (IHF)**

Tuning Range: 87.50 MHz to 108.00 MHz

Usable Sensitivity: Monaural: 12.8 dBf (1.20  $\mu$ V/75  $\Omega$ )

50 dB Quieting Sensitivity:

Monaural: 21.3 dBf (3.2  $\mu$ V/75  $\Omega$ )

Stereo: 41.3 dBf (31.5  $\mu$ V/75  $\Omega$ )

Signal-to-Noise Ratio (IHF-A weighted):

Monaural: 78 dB at 85 dBf

Stereo: 73 dB at 85 dBf

Total Harmonic Distortion:

Monaural: 0.4% at 1 kHz

Stereo: 0.6% at 1 kHz

Stereo Separation at REC OUT: 35 dB at 1 kHz

Alternate Channel Selectivity:

45 dB: ( $\pm$ 400 kHz)

Frequency Response: 30 Hz to 15 kHz: (+0.5 dB, -3 dB)

**AM tuner**

Tuning Range: 531 kHz to 1,602 kHz (at 9 kHz interval)  
530 kHz to 1,600 kHz (at 10 kHz interval)

Usable Sensitivity: Loop antenna 400  $\mu$ V/m

Signal-to-Noise Ratio: 50 dB (100 mV/m)

**General**

Power Requirements: AC 220 V  $\sim$ ,  
adjustable with the voltage selector,  
50 Hz

Power Consumption: 250 W (at operation)  
5 W (in standby mode)

Dimensions (W x H x D): 435 mm x 146 mm x 403.5 mm  
(17 <sup>3</sup>/<sub>16</sub> in. x 5 <sup>3</sup>/<sub>4</sub> in. x 15 <sup>15</sup>/<sub>16</sub> in.)

Mass: 10.2 kg (22.5 lbs)

Designs & specifications are subject to change without notice.

Mains (AC) Line Instruction (not applicable for Europe, U.S.A., Canada, Australia and U.K.)

Instrucción sobre la línea de la red (CA) (no aplicable para Europa, EE.UU., Canadá, Australia, ni el Reino Unido)

Instrução sobre a tensão da rede eléctrica (CA) (não aplicável para a Europa, os E.U.A., o Canadá, a Austrália e o Reino Unido)

主 (AC) 电源线路说明 (不适用于欧洲、美国、加拿大、澳洲及英国型号)

تعليمات التيار الرئيسي (التردد) (لا ينطبق لأوروبا وأمريكا وكندا وأستراليا والمملكة المتحدة)

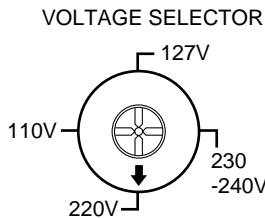
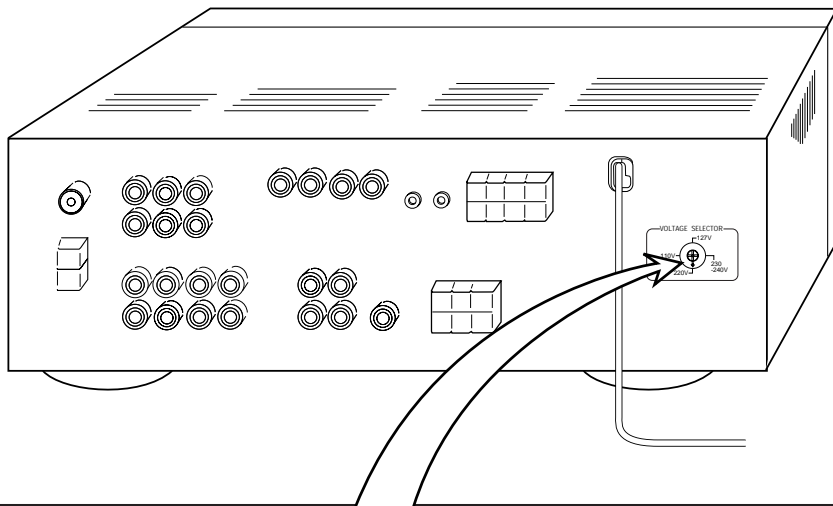

**CAUTION for mains (AC) line**

BEFORE PLUGGING IN, do check that your mains (AC) line voltage corresponds with the position of the voltage selector switch provided on the outside of this equipment and, if different, reset the voltage selector switch, to prevent from a damage or risk of fire/electric shock.

**PRECAUCIÓN para la línea de la red (CA)**

ANTES DE ENCHUFAR EL EQUIPO, compruebe si la tensión de la línea de la red (CA) corresponde con la posición del selector de tensión situado en la parte exterior del equipo, y si es diferente, reajuste el selector de tensión para evitar el riesgo de incendios/ descargas eléctricas.

**PRECAUÇÃO para a ligação à tensão da rede (CA)**

ANTES DE LIGAR O APARELHO A UMA TOMADA DA REDE, verifique se a tensão da rede CA corresponde à posição do selector de voltagem localizado na parte externa deste equipamento. Caso não corresponda, reajuste o selector de voltagem a fim de evitar avarias ou riscos de incêndio e choque eléctrico.

**有关主(AC)电源线路的注意事项**

接插电源以前，务请检查当地的主 (AC) 电源线路电压是否和位于本机外面的电压选择开关设定的位置一致。如果不一致，即重新设定电压选择开关使符合当地电压，以免损坏机器或引起火灾/触电的危险。

**هام من أجل خط التيار المتردد (AC) الرئيسي**

قبل ادخال القابس، تأكد من أن فولتية خط التيار المتردد (AC) الرئيسي لديك متوافقة مع موضع مفتاح اختيار الفولتية المتوفر خارج هذه المعدات وإذا اختلفت، فقم باعادة ضبط مفتاح اختيار الفولتية، لمنع التلف أو الصدمة الكهربائية وخطر الحريق.

**JVC**

VICTOR COMPANY OF JAPAN, LIMITED

## Free Manuals Download Website

<http://myh66.com>

<http://usermanuals.us>

<http://www.somanuals.com>

<http://www.4manuals.cc>

<http://www.manual-lib.com>

<http://www.404manual.com>

<http://www.luxmanual.com>

<http://aubethermostatmanual.com>

Golf course search by state

<http://golfingnear.com>

Email search by domain

<http://emailbydomain.com>

Auto manuals search

<http://auto.somanuals.com>

TV manuals search

<http://tv.somanuals.com>