

JVC



AUDIO/VIDEO CONTROL RECEIVER

RECEPTEUR DE COMMANDE AUDIO/VIDEO

RX-7520VBK

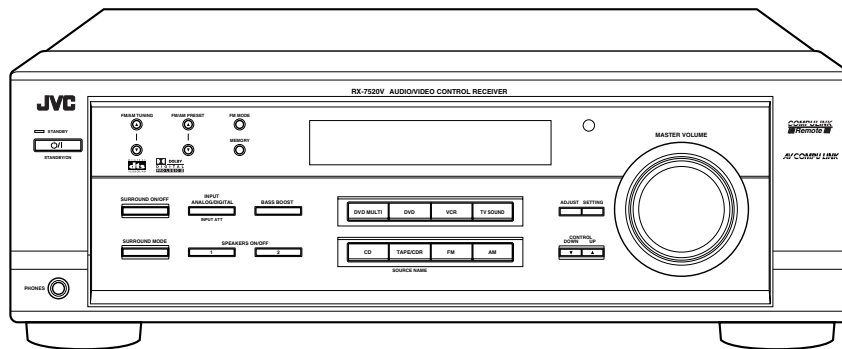
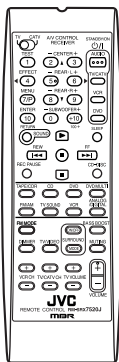

AV COMPU LINK

COMPU LINK
/// Remote ///

DIGITAL
dts
SURROUND

DOLBY
DIGITAL
PRO LOGIC II

INSTRUCTIONS

MANUAL D'INSTRUCTIONS

For Customer Use:

Enter below the Model No. and Serial No. which are located either on the rear, bottom or side of the cabinet. Retain this information for future reference.

Model No. _____

Serial No. _____

LVT0852-002A

[C]

Warnings, Cautions and Others/ Mises en garde, précautions et indications diverses

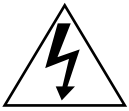

The lightning flash with arrowhead symbol, within an equilateral triangle is intended to alert the user to the presence of uninsulated "dangerous voltage" within the product's enclosure that may be of sufficient magnitude to constitute a risk of electric shock to persons.



The exclamation point within an equilateral triangle is intended to alert the user to the presence of important operating and maintenance (servicing) instructions in the literature accompanying the appliance.

WARNING: TO REDUCE THE RISK OF FIRE OR ELECTRIC SHOCK, DO NOT EXPOSE THIS APPLIANCE TO RAIN OR MOISTURE.

CAUTION

To reduce the risk of electrical shocks, fire, etc.:

1. Do not remove screws, covers or cabinet.
2. Do not expose this appliance to rain or moisture.

ATTENTION

Afin d'éviter tout risque d'électrocution, d'incendie, etc.:

1. Ne pas enlever les vis ni les panneaux et ne pas ouvrir le coffret de l'appareil.
2. Ne pas exposer l'appareil à la pluie ni à l'humidité.

Caution — STANDBY/ON button!

Disconnect the mains plug to shut the power off completely. The STANDBY/ON  button in any position does not disconnect the mains line. The power can be remote controlled.

Attention — Commutateur STANDBY/ON !

Déconnecter la fiche de secteur pour couper complètement le courant. Le commutateur STANDBY/ON  ne coupe jamais complètement la ligne de secteur, quelle que soit sa position. Le courant peut être télécommandé.

For U.S.A.

This equipment has been tested and found to comply with the limits for a Class B digital device, pursuant to part 15 of the FCC Rules. These limits are designed to provide reasonable protection against harmful interference in a residential installation.

This equipment generates, uses and can radiate radio frequency energy and, if not installed and used in accordance with the instructions, may cause harmful interference to radio communications. However, there is no guarantee that interference will not occur in a particular installation. If this equipment does cause harmful interference to radio or television reception, which can be determined by turning the equipment off and on, the user is encouraged to try to correct the interference by one or more of the following measures:

Reorient or relocate the receiving antenna.
Increase the separation between the equipment and receiver.

Connect the equipment into an outlet on a circuit different from that to which the receiver is connected.

Consult the dealer or an experienced radio/TV technician for help.

Changes or modifications not expressly approved by the manufacturer for compliance could void the user's authority to operate the equipment.

For Canada/pour le Canada

CAUTION: TO PREVENT ELECTRIC SHOCK, MATCH WIDE BLADE OF PLUG TO WIDE SLOT, FULLY INSERT
ATTENTION: POUR EVITER LES CHOCS ELECTRIQUES, INTRODUIRE LA LAME LA PLUS LARGE DE LA FICHE DANS LA BORNE CORRESPONDANTE DE LA PRISE ET POUSSER JUSQU'AU FOND

For Canada/pour Le Canada

THIS DIGITAL APPARATUS DOES NOT EXCEED THE CLASS B LIMITS FOR RADIO NOISE EMISSIONS FROM DIGITAL APPARATUS AS SET OUT IN THE INTERFERENCE-CAUSING EQUIPMENT STANDARD ENTITLED "DIGITAL APPARATUS," ICES-003 OF THE DEPARTMENT OF COMMUNICATIONS.
 CET APPAREIL NUMERIQUE RESPECTE LES LIMITES DE BRUITS RADIOELECTRIQUES APPLICABLES AUX APPAREILS NUMERIQUES DE CLASSE B PRESCRITES DANS LA NORME SUR LE MATERIEL BROUILLEUR; "APPAREILS NUMERIQUES", NMB-003 EDICTEE PAR LE MINISTRE DES COMMUNICATIONS.

Caution: Proper Ventilation

To avoid risk of electric shock and fire and to protect from damage.

Locate the apparatus as follows:

- Front: No obstructions open spacing.
- Sides: No obstructions in 10 cm from the sides.
- Top: No obstructions in 10 cm from the top.
- Back: No obstructions in 15 cm from the back.
- Bottom: No obstructions, place on the level surface.

In addition, maintain the best possible air circulation as illustrated.

Attention: Ventilation Correcte

Pour éviter les chocs électriques, l'incendie et tout autre dégât.

Disposer l'appareil en tenant compte des impératifs suivants

- Avant: Rien ne doit gêner le dégagement
- Flancs: Laisser 10 cm de dégagement latéral
- Dessus: Laisser 10 cm de dégagement supérieur
- Arrière: Laisser 15 cm de dégagement arrière
- Dessous: Rien ne doit obstruer par dessous; poser l'appareil sur une surface plate.

Veiller également à ce que l'air circule le mieux possible comme illustré.

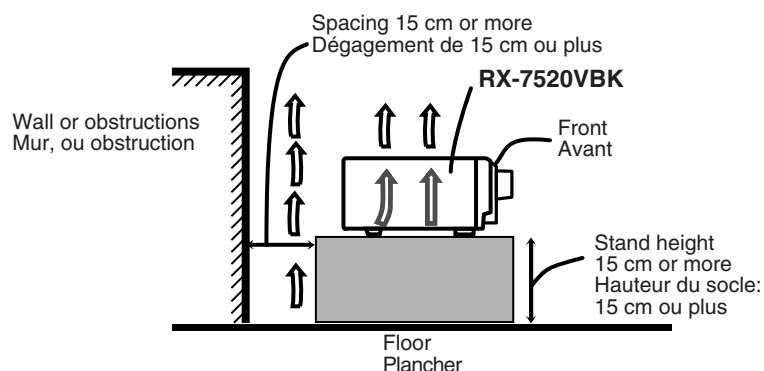

Parts Identification	2
Getting Started	3
Before Installation	3
Checking the Supplied Accessories	3
Putting Batteries in the Remote Control	3
Connecting the FM and AM Antennas	4
Connecting the Speakers	5
Connecting Audio/Video Components	6
Connecting the Power Cord	9
Basic Operations	10
Turning On the Power	10
Selecting the Source to Play	10
Adjusting the Volume	11
Selecting the Front Speakers	11
Listening Only with Headphones	12
Turning Off the Sounds Temporarily—Muting	12
Changing the Display Brightness	12
Turning Off the Power with the Sleep Timer	12
Basic Settings	14
Setting the Digital Input (DIGITAL IN) Terminals	14
Selecting the Analog or Digital Input Mode	14
Setting the Video Input Terminal	16
Setting the Speaker Information	16
Sound Adjustments	19
Attenuating the Input Signal	19
Adjusting the Front Speakers Output Balance	19
Adjusting the Tone	20
Adjusting the Subwoofer Output Level	20
Reinforcing the Bass	20
Tuner Operations	21
Tuning in Stations Manually	21
Using Preset Tuning	21
Selecting the FM Reception Mode	22
Creating Realistic Sound Fields	23
About Relations between Speaker Layouts and Surround Modes	25
Using Dolby Pro Logic II, Dolby Digital and DTS Digital Surround	26
Using DAP Modes and All Channel Stereo	28
Using DVD MULTI Playback Mode	30
Activating DVD MULTI Playback Mode	30
COMPU LINK Remote Control System	31
AV COMPU LINK Remote Control System	32
Operating JVC's Audio/Video Components	34
Operating Audio Components	34
Operating Video Components	36
Operating Other Manufacturers' Video Equipment	37
Troubleshooting	40
Specifications	41



This mark indicates that the remote control CAN ONLY be used for the operation explained.



This mark indicates that the remote control CANNOT be used for the operation explained. Use buttons on the front panel.

Parts Identification

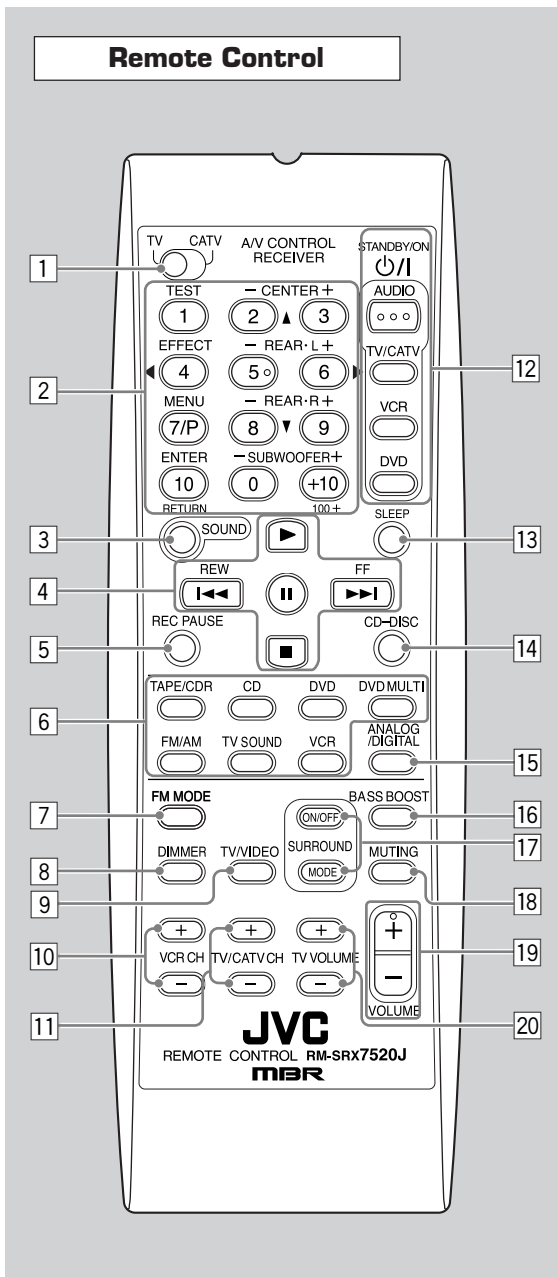
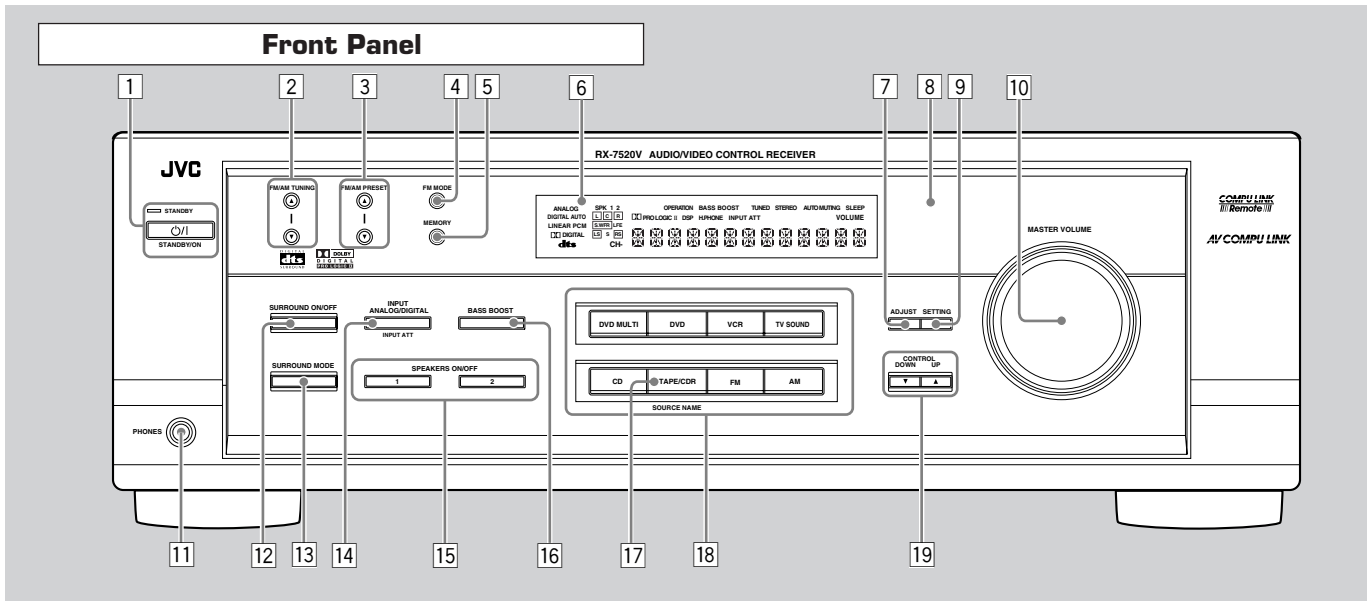

See pages in the parentheses for details.

Front Panel

- 1 STANDBY/ON \odot/I button and STANDBY lamp (10)
- 2 FM/AM TUNING $\blacktriangle/\blacktriangledown$ buttons (21)
- 3 FM/AM PRESET $\blacktriangle/\blacktriangledown$ buttons (21, 22)
- 4 FM MODE button (22)
- 5 MEMORY button (21, 22)
- 6 Display (10)
- 7 ADJUST button (19, 20, 27 – 30)
- 8 Remote sensor (3)
- 9 SETTING button (14, 16 – 18)
- 10 MASTER VOLUME control (11)
- 11 PHONES jack (12)
- 12 SURROUND ON/OFF button (25, 27, 29)
- 13 SURROUND MODE button (25, 27, 29)
- 14 • INPUT ANALOG/DIGITAL button (15)
• INPUT ATT button (19)
- 15 SPEAKERS ON/OFF 1 and 2 buttons (11, 12)
- 16 BASS BOOST button (20)
- 17 SOURCE NAME button (11)
- 18 Source selecting buttons (10, 11, 14, 21, 22, 30)
DVD MULTI, DVD, VCR, TV SOUND, CD, TAPE/CDR, FM, AM
- 19 CONTROL UP \blacktriangle /DOWN \blacktriangledown buttons (14, 16 – 20, 27 – 30)

Remote Control

- 1 TV/CATV selector (36, 37)
- 2 •10 keys for selecting preset channels (22)
•10 keys for adjusting sound (20, 27, 28, 30, 34)
•10 keys for operating audio/video components (34 – 37)
- 3 SOUND button (20, 27, 28, 30, 34)
- 4 Operating buttons for audio/video components (34 – 36, 38, 39)
- 5 REC PAUSE button (35, 36, 38)
- 6 Source selecting buttons (10, 11, 14, 21, 22, 30, 34 – 39)
TAPE/CDR, CD, DVD, DVD MULTI, FM/AM, TV SOUND, VCR
- 7 FM MODE button (22)
- 8 DIMMER button (12)
- 9 TV/VIDEO button (36, 37)
- 10 VCR CH (channel) +/- buttons (36, 38)
- 11 TV/CATV CH (channel) +/- buttons (36, 37)
- 12 STANDBY/ON \odot/I buttons (10, 33, 36 – 39)
AUDIO, TV/CATV, VCR, DVD
- 13 SLEEP button (12)
- 14 CD-DISC button (35)
- 15 ANALOG/DIGITAL button (15)
- 16 BASS BOOST button (20)
- 17 SURROUND ON/OFF and SURROUND MODE buttons (25, 28)
- 18 MUTING button (12)
- 19 VOLUME +/- button (11)
- 20 TV VOLUME +/- buttons (36, 37)

Before Installation

General Precautions

- DO NOT insert any metal object into the unit.
- DO NOT disassemble the unit or remove screws, covers, or cabinet.
- DO NOT expose the unit to rain or moisture.

Locations

- Install the unit in a location that is level and protected from moisture.
- The temperature around the unit must be between -5°C and 35°C (23°F and 95°F).
- Make sure there is good ventilation around the unit. Poor ventilation could cause overheating and damage the unit.

Handling the unit

- DO NOT touch the power cord with wet hands.
- DO NOT pull on the power cord to unplug the cord. When unplugging the cord, always grasp the plug so as not to damage the cord.
- Keep the power cord away from the connecting cords and the antenna. The power cord may cause noise or screen interference. It is recommended to use a coaxial cable for antenna connection, since it is well-shielded against interference.
- When a power failure occurs, or when you unplug the power cord, the preset settings such as preset FM/AM channels and sound adjustments may be erased in a few days.

Checking the Supplied Accessories

Check to be sure you have all of the following supplied accessories. The number in the parentheses indicates the quantity of the pieces supplied.

- Remote Control (1)
- Batteries (2)
- AM Loop Antenna (1)
- FM Antenna (1)

If anything is missing, contact your dealer immediately.

Putting Batteries in the Remote Control

Before using the remote control, put two supplied batteries first.

- When using the remote control, aim the remote control directly at the remote sensor on the unit.

1 On the back of the remote control, remove the battery cover.

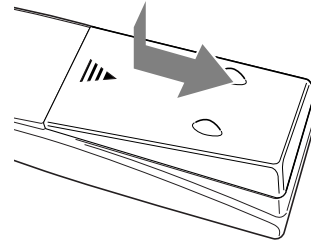

2 Insert batteries.

- Make sure to match the polarity: (+) to (+) and (-) to (-).

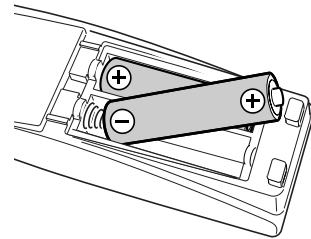

3 Replace the cover.

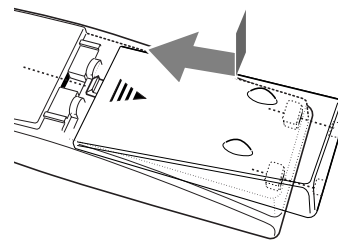

If the range or effectiveness of the remote control decreases, replace the batteries. Use two R6P(SUM-3)/AA(15F) type dry-cell batteries.

CAUTION:

Follow these precautions to avoid leaking or cracking cells:

- Place batteries in the remote control so they match the polarity: (+) to (+) and (-) to (-).
- Use the correct type of batteries. Batteries that look similar may differ in voltage.
- Always replace both batteries at the same time.
- Do not expose batteries to heat or flame.

Getting Started

Connecting the FM and AM Antennas

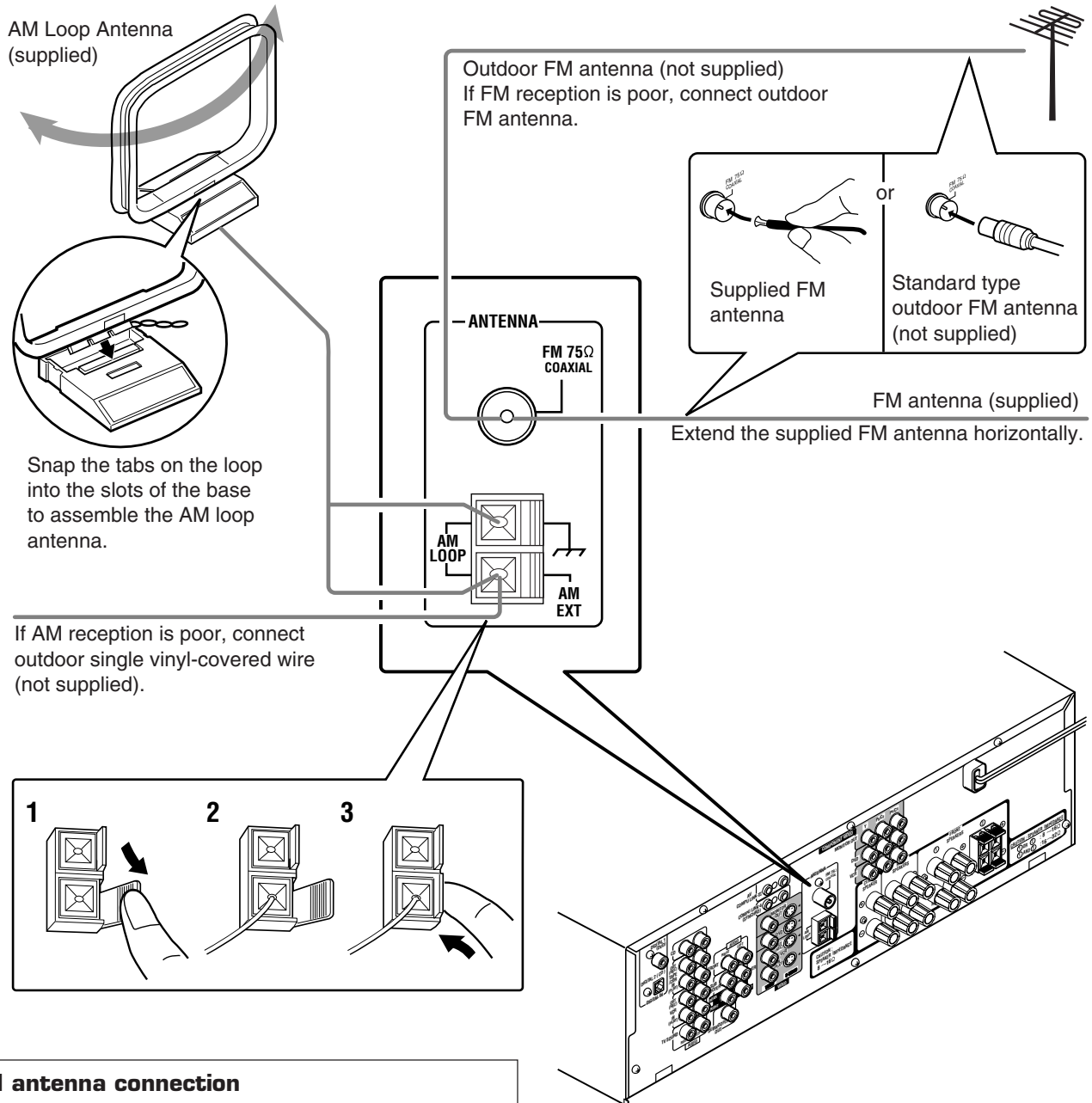

AM antenna connection

Connect the supplied AM loop antenna to the AM LOOP terminals.

Turn the loop until you have the best reception.

- If the reception is poor, connect an outdoor single vinyl-covered wire (not supplied) to the AM EXT terminal. (Keep the AM loop antenna connected.)

FM antenna connection

Connect the supplied FM antenna to the FM 75 Ω COAXIAL terminal as a temporary measure.

Extend the supplied FM antenna horizontally.

- If the reception is poor, connect an outdoor FM antenna (not supplied). Before attaching a 75 Ω coaxial cable (with a standard type connector), disconnect the supplied FM antenna.

Notes:

- If the AM loop antenna wire is covered with vinyl, remove the vinyl while twisting it as shown on the right.
- Make sure the antenna conductors do not touch any other terminals, connecting cords and power cord. This could cause poor reception.

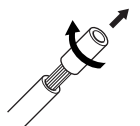

“NO” for the subwoofer, “LARGE” for the front speakers, and “SMALL” for the center and rear speakers are initial settings. To get best possible sound, change the subwoofer and speaker settings to fit your listening conditions.

Connecting the Speakers

Speaker layout diagram

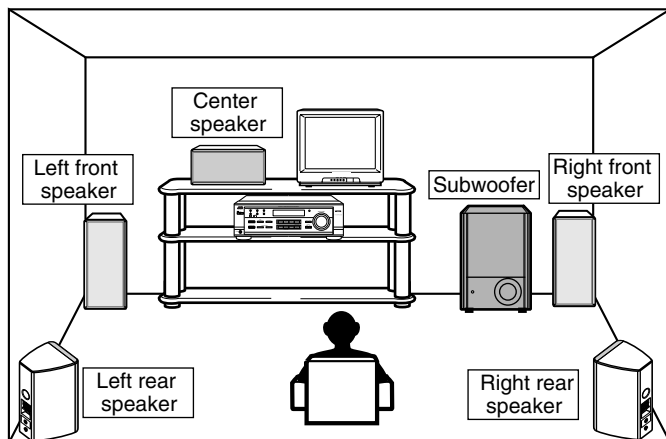

After connecting the front, center, rear speakers and/or subwoofer, set the speaker setting information properly to obtain the best possible Surround effects. For details, see pages 16 to 18.

CAUTION:

Use speakers with the SPEAKER IMPEDANCE indicated by the speaker terminals.

Connecting the front speakers

You can connect two pairs of front speakers (one pair to the FRONT SPEAKERS ① terminals, and the other pair to the FRONT SPEAKERS ② terminals).

About the speaker impedance

The required speaker impedance of the front speakers does differ depending on whether both the FRONT SPEAKERS ① and FRONT SPEAKERS ② terminals are used or only one of them is used.

CASE 1 When you connect only one pair of front speakers



Use front speakers with $8\ \Omega - 16\ \Omega$ impedance.

CASE 2 When you connect two pairs of front speakers

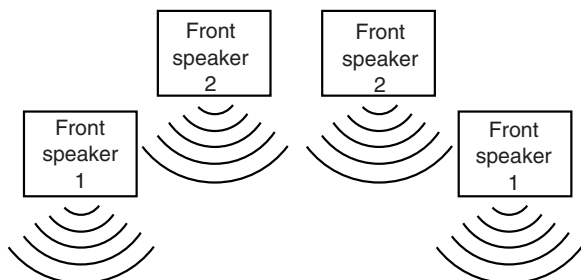

Use front speakers with $16\ \Omega - 32\ \Omega$ impedance.

Connection diagram

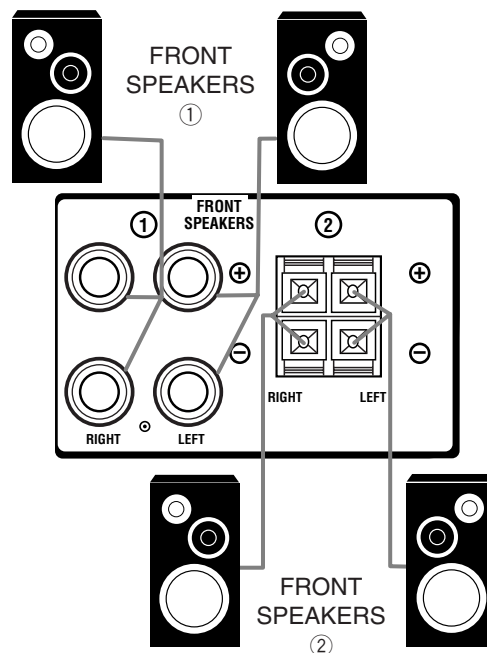

Connecting speakers to the FRONT SPEAKERS ① terminals

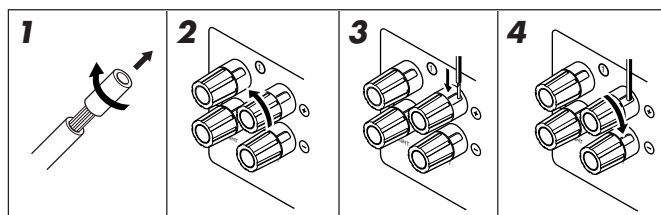

For each speaker, connect the (+) and (-) terminals on the rear panel to the (+) and (-) terminals marked on the speakers.

- 1 Cut, twist and remove the insulation at the end of each speaker signal cable (not supplied).
- 2 Turn the knob counterclockwise.
- 3 Insert the speaker signal cable.
- 4 Turn the knob clockwise.

Connecting speakers to the FRONT SPEAKERS ② terminals

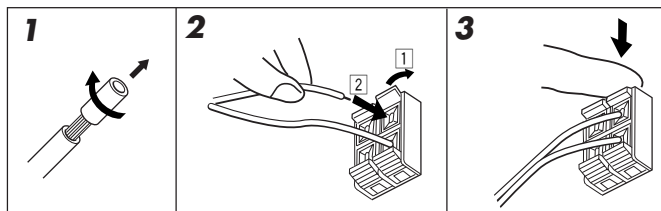

For each speaker, connect the (+) and (-) terminals on the rear panel to the (+) and (-) terminals marked on the speakers.

- 1 Cut, twist and remove the insulation at the end of each speaker cord.
- 2 Open the terminal (1), then insert the speaker cord (2).
- 3 Close the terminal.

Getting Started

Connecting the rear and center speakers

Connect rear speakers to the REAR SPEAKERS terminals and a center speaker to the CENTER SPEAKER terminals.

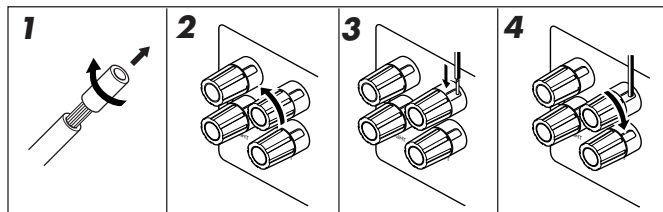
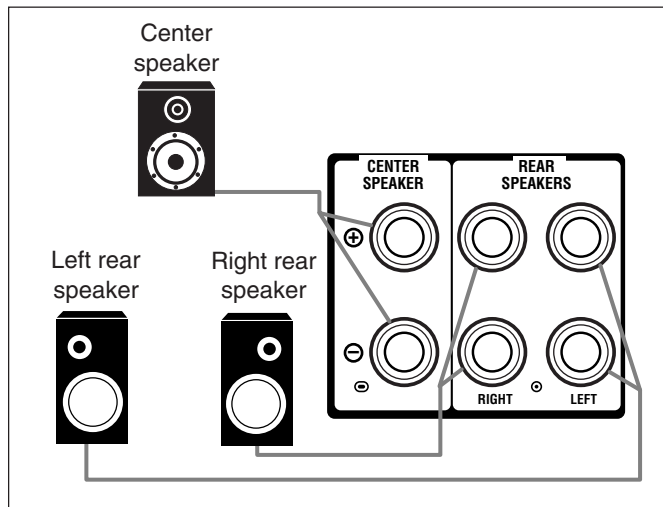

For each speaker, connect the (+) and (-) terminals on the rear panel to the (+) and (-) terminals marked on the speakers.

- 1** Cut, twist and remove the insulation at the end of each speaker signal cable (not supplied).
- 2** Turn the knob counterclockwise.
- 3** Insert the speaker signal cable.
- 4** Turn the knob clockwise.

Connecting the subwoofer speaker

By connecting a subwoofer, you can enhance the bass or reproduce the original LFE signals recorded on the digital software.

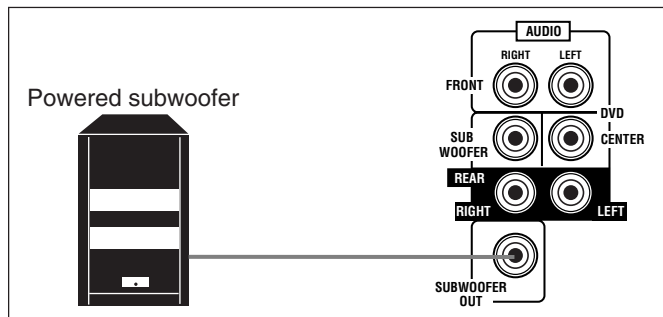

Connect the input jack of a powered subwoofer to the SUBWOOFER OUT jack on the rear panel, using a cable with RCA pin plugs (not supplied).

- Refer also to the manual supplied for your subwoofer.

Since bass sound is non-directional, you can place a subwoofer wherever you like. Normally place it in front of you.

Connecting Audio/Video Components

Turn off all components before connecting.

You can connect the following audio/video components to this unit. Refer also to the manuals supplied with your components.

Audio Components	Video Components
• CD player*	• VCR
• Cassette deck or CD recorder*	• TV*
	• DVD player*

* You can connect these components using the methods described in "Analog connections" (below) or in "Digital connections" (see page 9).

Analog connections

Audio component connections

Use the cables with RCA pin plugs (not supplied).

Connect the white plug to the audio left jack, and the red plug to the audio right jack.

CAUTION:

If you connect a sound-enhancing device such as a graphic equalizer between the source components and this receiver, the sound output through this receiver may be distorted.

CD player

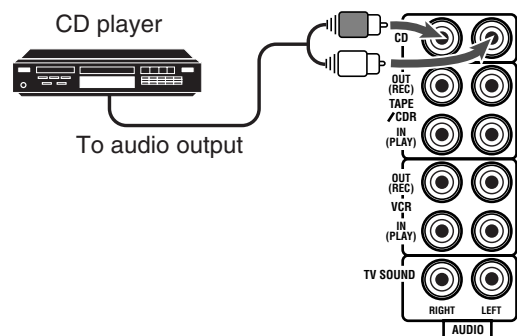

Cassette deck or CD recorder

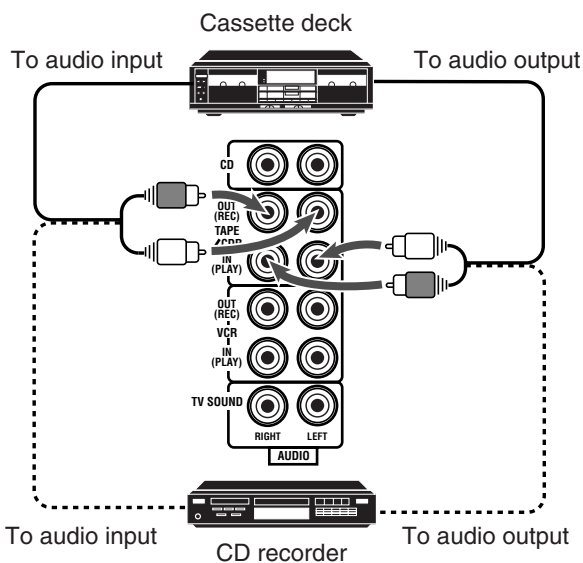

Note:

You can connect either a cassette deck or a CD recorder to the TAPE/CDR jacks. When connecting a CD recorder to the TAPE/CDR jacks, change the source name, which will be shown on the display when selected as the source. See page 11 for details.

If your audio components have a COMPU LINK jack

See also page 31 for detailed information about the connection and the COMPU LINK remote control system.

Video component connections

Use the cables with RCA pin plugs (not supplied). Connect the white plug to the audio left jack, the red plug to the audio right jack, and the yellow plug to the video jack.

- If video components have S-video (Y/C-separation) and/or component video (Y, Pb/Cb, Pr/Cr) terminals, connect them using an S-video cable (not supplied) and/or component video cable (not supplied). By using these terminals, you can get a better picture quality in the order—Component video > S-video > Composite video.

IMPORTANT:

This unit is equipped with the following video terminals: composite video, S-video and component video terminals. You can use any of these three to connect a video component.

However, **remember that the video signals from one type of these input terminals are output only through the video output terminals of the same type.**

Therefore, if a recording video component and a playing video component are connected to the unit through the different types of video terminals, you cannot record the picture from the playing component onto the recording component. In addition, if the TV and a playing video component are connected to the unit through the different types of video terminals, you cannot view the playback picture from the playing component on the TV.

VCR

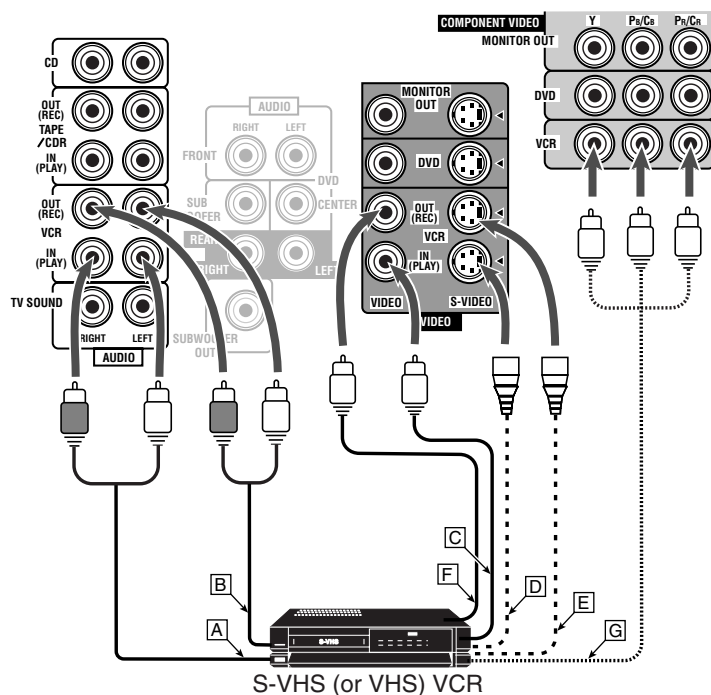

- A To left/right channel audio output
- B To left/right channel audio input
- C To composite video output
- D To S-video output
- E To S-video input
- F To composite video input
- G To component video output

Note:

See "Selecting the Video Input Terminal" on page 16 for details.

Getting Started

TV

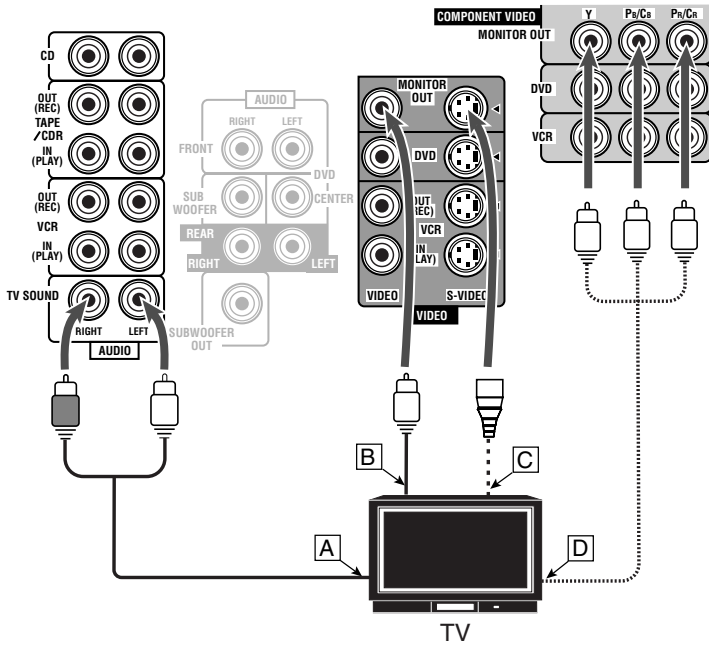

- A To audio output
- B To composite video input
- C To S-video input
- D To component video input

DVD player

- When you connect the DVD player with stereo output jacks:

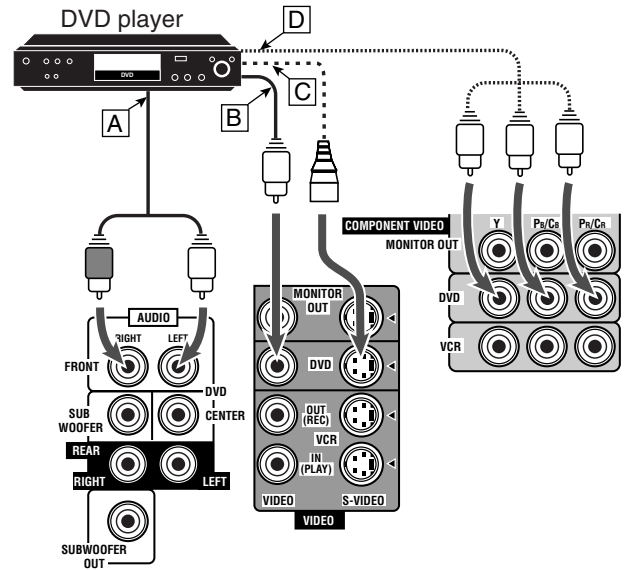

- A To front left/right channel audio output
- B To composite video output
- C To S-video output
- D To component video output

For enjoying DVD MULTI Playback Mode—

- When you connect the DVD player with its analog discrete output (5.1 CH reproduction) jacks:

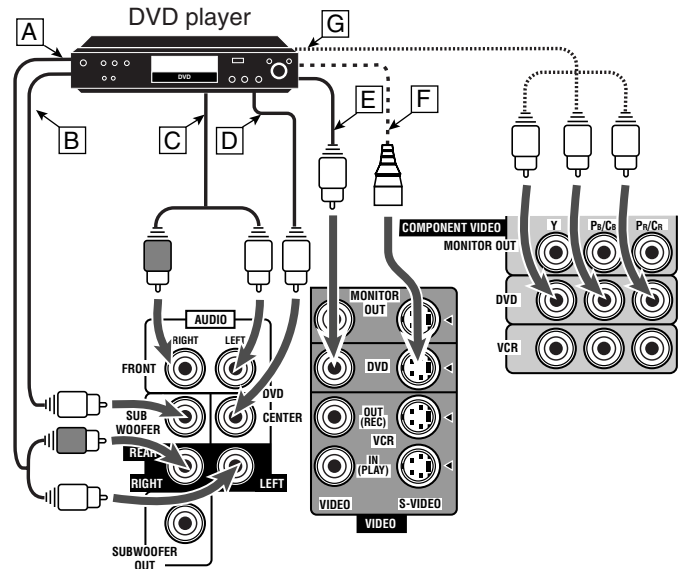

- A To rear left/right channel audio output
- B To subwoofer audio output
- C To front left/right channel audio output
- D To center channel audio output
- E To composite video output
- F To S-video output
- G To component video output

Digital connections

This receiver is equipped with two DIGITAL IN terminals—one digital coaxial terminal and one digital optical terminal. You can connect any digital component to one of the digital terminals using a digital coaxial cable (not supplied).

IMPORTANT:

- When connecting the DVD player or digital TV using the digital terminals, you also need to connect it to the video jack on the rear. Without connecting it to the video jack, you can view no playback picture.
- After connecting the components using the DIGITAL IN terminals, set the following correctly if necessary:
 - Set the digital input (DIGITAL IN) terminal setting correctly. For details, see “Setting the Digital Input (DIGITAL IN) Terminals” on page 14.
 - Select the digital input mode correctly. For details, see “Selecting the Analog or Digital Input Mode” on page 14.

Digital input terminals

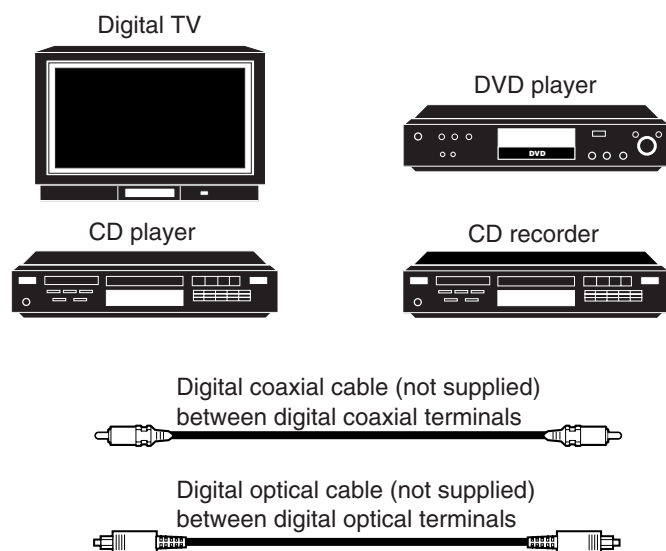

When the component has a digital coaxial output terminal, connect it to the DIGITAL 1 (DVD) terminal with the digital coaxial cable (not supplied).

When the component has a digital optical output terminal, connect it to the DIGITAL 2 (CD) terminal, using the digital optical cable (not supplied).

Before connecting a digital optical cable, unplug the protective plug.

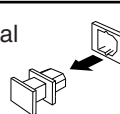

Notes:

- When shipped from the factory, the DIGITAL IN terminals have been set for use with the following components:
 - DIGITAL 1 (coaxial): For DVD player
 - DIGITAL 2 (optical): For CD player
- When you want to operate the CD player or CD recorder using the COMPU LINK remote control system, connect the target component also as described in “Analog connections” (see pages 6 and 7).
- When you want to operate the DVD player using the AV COMPU LINK remote control system, connect the DVD player also as described in “Analog connections” (see page 8).

Connecting the Power Cord

Before plugging the receiver into an AC outlet, make sure that all connections have been made.

Plug the power cord into an AC outlet.

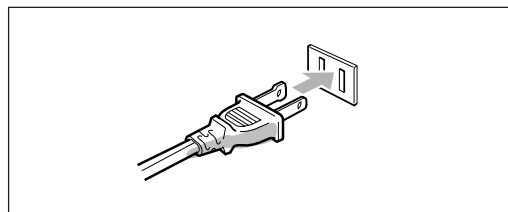

Keep the power cord away from the connecting cables and the antenna. The power cord may cause noise or screen interference. We recommend that you use a coaxial cable to connect the antenna, since it is well-shielded against interference.

CAUTIONS:

- Do not touch the power cord with wet hands.
- Do not pull on the power cord to unplug the cord. When unplugging the cord, always grasp the plug so as not to damage the cord.

Basic Operations

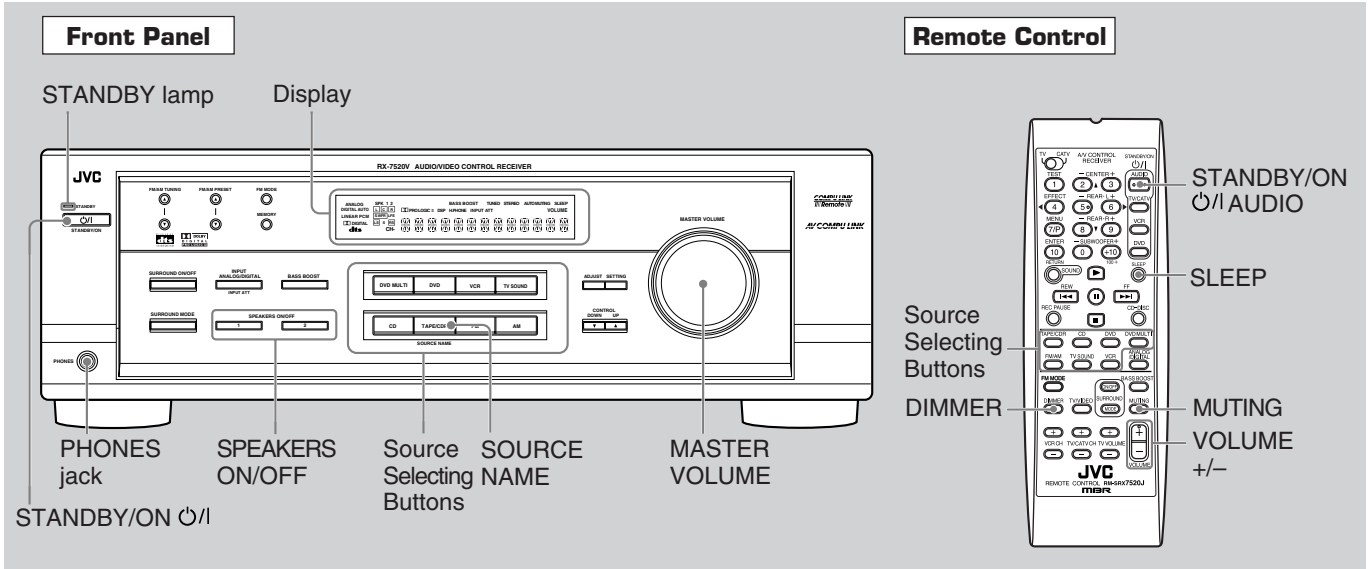

Turning On the Power

Press STANDBY/ON \odot /I (or STANDBY/ON \odot /I/AUDIO on the remote control).



The STANDBY lamp goes off. The name of the current source (or station frequency) appears on the display.

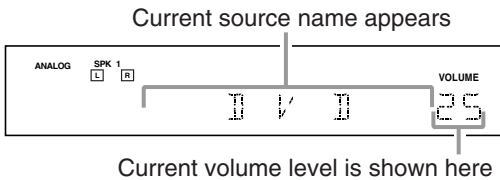

To turn off the power (into standby mode)

Press STANDBY/ON \odot /I (or STANDBY/ON \odot /I/AUDIO on the remote control) again. The STANDBY lamp lights up.

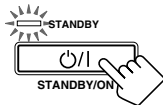

Note:

A small amount of power is consumed in standby mode. To turn the power off completely, unplug the AC power cord.

Selecting the Source to Play

Press one of the source selecting buttons. The selected source name appears on the display.

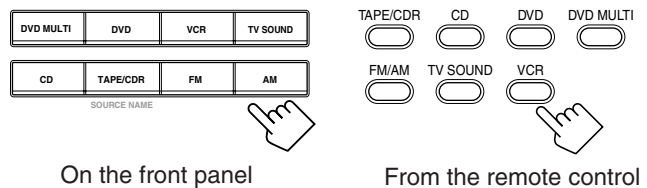

- DVD MULTI** : Select the DVD player for viewing the digital video disc using the analog discrete output mode (5.1 ch reproduction). To enjoy the DVD MULTI playback, see page 30.
- DVD** : Select the DVD player.
- VCR** : Select the VCR.
- TV SOUND** : Select the TV sound.
- CD *** : Select the CD player.
- TAPE/CDR *** : Select the cassette deck (or the CD recorder).
- FM and AM (FM/AM) *** : Select an FM or AM broadcast.
 - Each time you press FM/AM on the remote control, the band alternates between FM and AM.

Notes:

- When connecting a CD recorder (to the TAPE/CDR jacks), change the source name that appears on the display. See "Changing the source name" on page 11.
- When you have connected some digital source components using the digital terminals (see page 9), you need to select the digital input mode (see page 14).
- When you press one of the source selecting buttons on the remote control marked above with an asterisk (*), the receiver automatically turns on.

Changing the source name

When you connect a CD recorder to the TAPE/CDR jacks on the rear panel, change the source name shown on the display.



- 1 Press TAPE/CDR (SOURCE NAME).
 - Make sure "TAPE" appears on the display.



- 2 Press and hold SOURCE NAME (TAPE/CDR) until "ASSIGN CDR" appears on the display.



To change the source name from "CDR" to "TAPE," repeat the same procedure above (in step **1**, make sure "CDR" appears on the display).

Note:

Without changing the source name, you can still use the connected component. However, there may be some inconvenience:

- "TAPE" will appear on the display when you select the CD recorder.
- You cannot use the digital input (see page 14) for the CD recorder.
- You cannot use the COMPU LINK remote control system (see page 31) to operate the CD recorder.

Selecting different sources for picture and sound

You can watch picture from a video component while listening to sound from another component.

Press one of the audio source selecting buttons— CD, TAPE/CDR, FM, AM (or FM/AM on the remote control), while watching the picture from a video component such as the VCR, or DVD player, etc.

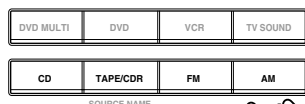

On the front panel

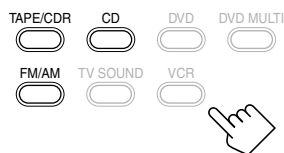

From the remote control

Notes:

- Once you have selected a video source, pictures of the selected source are sent to the TV until you select another video source.
- This function can use only when selecting the S-video or composite video input terminal.

Adjusting the Volume

On the front panel:

To increase the volume, turn MASTER VOLUME clockwise.

To decrease the volume, turn it counterclockwise.

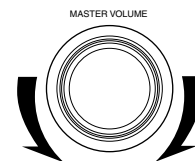

From the remote control:

To increase the volume, press VOLUME +.

To decrease the volume, press VOLUME –.



CAUTION:

Always set the volume to the minimum before starting any source. If the volume is set at its high level, the sudden blast of sound energy can permanently damage your hearing and/or ruin your speakers.

Note:

The volume level can be adjusted within the range of "0" (minimum) to "50" (maximum).

Selecting the Front Speakers



When you have connected two pairs of the front speakers, you can select which to use.

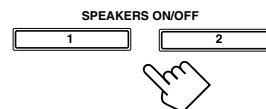

To use the speakers connected to the FRONT SPEAKERS ① terminals, press SPEAKERS ON/OFF 1 so that the SPK 1 indicator lights up on the display. (Make sure that the SPK 2 is not lit on the display.)

To use the speakers connected to the FRONT SPEAKERS ② terminals, press SPEAKERS ON/OFF 2 so that the SPK 2 indicator lights up on the display. (Make sure that the SPK 1 is not lit on the display.)

To use both set of the speakers, press SPEAKERS ON/OFF 1 and 2 so that the SPK 1 and SPK 2 indicators light up on the display.

To use neither set of the speakers, press SPEAKERS ON/OFF 1 and 2 so that the SPK 1 and SPK 2 indicators disappear from the display.

Notes:

- If you select any of the Surround modes while using both the speakers connected to the FRONT SPEAKERS ① and ② terminals, the speakers connected to the FRONT SPEAKERS ② terminals are deactivated.
- While the Surround mode is in use, you can only select either the speakers connected to the FRONT SPEAKERS ① or ② terminals.
- If you select DVD MULTI as the source while using both the speakers connected to the FRONT SPEAKERS ① and ② terminals, the speakers connected to the FRONT SPEAKERS ② terminals are deactivated.
- When selecting "DVD MULTI" as the source, you can only select either the speakers connected to the FRONT SPEAKERS ① or ② terminals.

Basic Operations

Listening Only with Headphones

You must turn off both pairs of speakers when you listen with headphones.

- 1 Connect a pair of headphones to the PHONES jack on the front panel.
- 2 Press SPEAKERS ON/OFF 1 and SPEAKERS ON/OFF 2 so that neither the SPK 1 nor SPK 2 indicator appears on the display.
 - “HEADPHONE” appears and H. PHONE indicator lights up on the display.

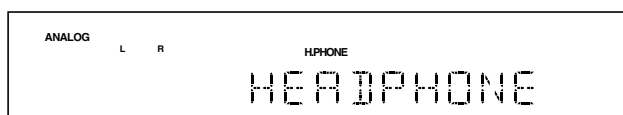

This cancels the Surround modes currently selected and activates the HEADPHONE mode (see below).

HEADPHONE mode

When using the headphones, the following signals are output regardless of your speaker setting:

- For 2 channel sources, the front left and right channel signals are output directly from the headphones.
- For multichannel sources, the front left and right, center, and rear channel signals are down-mixed and then output from the headphones.

You can enjoy multichannel sound sources using the headphones.

Notes:

- While in the HEADPHONE mode, you cannot use any Surround modes (see page 23).
- Activating the speakers cancels the HEADPHONE mode and turns on the Surround modes previously selected.

CAUTION:

Be sure to turn down the volume:

- Before connecting or putting on headphones, as high volume can damage both the headphones and your hearing.
- Before turning on speakers again, as high volume may output from the speakers.

Turning Off the Sounds Temporarily—Muting



You can turn off the volume temporarily.

Press **MUTING on the remote control** to mute the sound through all speakers and headphones connected.



- “MUTING” appears on the display and the volume turns off (the volume level indicator goes off).

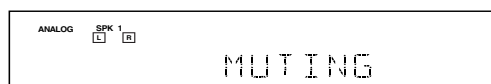

To restore the sound, press MUTING again.

- Turning MASTER VOLUME on the front panel or pressing VOLUME +/- on the remote control also restores the sound.

Changing the Display Brightness



You can dim the display.

Press **DIMMER on the remote control**.

- Each time you press the button, the display dims and brightens alternately.



Turning Off the Power with the Sleep Timer



You can fall asleep while listening to music—Sleep Timer.

Press **SLEEP on the remote control** repeatedly.

- The SLEEP indicator lights up on the display and the shut-off time changes in 10 minutes intervals.

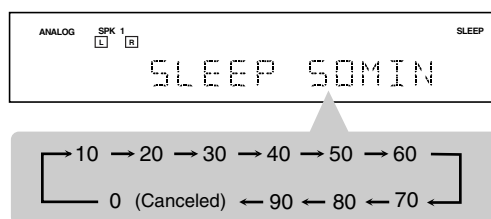

When the shut-off time comes

The receiver turns off automatically.

To check or change the remaining time until the shut-off time

Press SLEEP once.

The remaining time (in minutes) until the shut-off time appears.

- To change the shut-off time, press SLEEP repeatedly until the preferred remaining time appears on the display.

To cancel the Sleep Timer

Press SLEEP repeatedly until “SLEEP 0 MIN” appears on the display. (The SLEEP indicator goes off.)

- Turning off the power also cancels the Sleep Timer.

Basic adjustment auto memory

This receiver memorizes sound settings for each source when—:

- turning off the power,
- changing the source, and
- assigning the source name.

When you change the source, the memorized settings for the newly selected source are automatically recalled.

The following can be stored for each source:

- Input attenuator mode (see page 19)
- Balance (see page 19)
- Tone adjustment (see page 20)
- Subwoofer output level (see page 20)
- Surround mode selection (see pages 26 – 29)
- Bass boost (see page 20)

Notes:

- You cannot assign and store different settings for digital input mode and analog input mode.
- If the source is FM or AM, you can assign a different setting for each band.

For recording

You can record any source through the receiver to —:

- the cassette deck (or CD recorder) connected to the TAPE/CDR jacks, and
- the VCR connected to the VCR jacks at the same time.

While recording, you can listen to the selected sound source at whatever sound level you like without affecting the sound levels of the recording.

Note:

The output volume level, bass boost (see page 20), tone adjustment (see page 20), and Surround modes (see page 23) cannot affect the recording.

Signal and speaker indicators on the display

Signal indicators

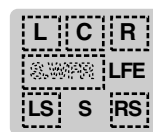

Speaker indicators

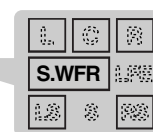

The following signal indicators light up—:

- L** : •When **digital input** is selected: Lights up when the left channel signal comes in.
 •When **analog input** is selected: Always lights up.
- R** : •When **digital input** is selected: Lights up when the right channel signal comes in.
 •When **analog input** is selected: Always lights up.
- C** : When the center channel signal comes in.
- LS** : When the left rear channel signal comes in.
- RS** : When the right rear channel signal comes in.
- S** : When the monaural rear channel signal or 2 ch Dolby Surround encoded signal comes in.
- LFE**: When the LFE channel signal comes in.

The speaker indicators light up when—:

- The corresponding speaker is activated, and
- The corresponding speaker is required for the current playback.

Notes:

- When you select "DVD MULTI," all the signal indicators except "S" light up.
- When "SUBWOOFER" is set to "YES" (see page 16), **S.WFR** lights up.

Basic Settings

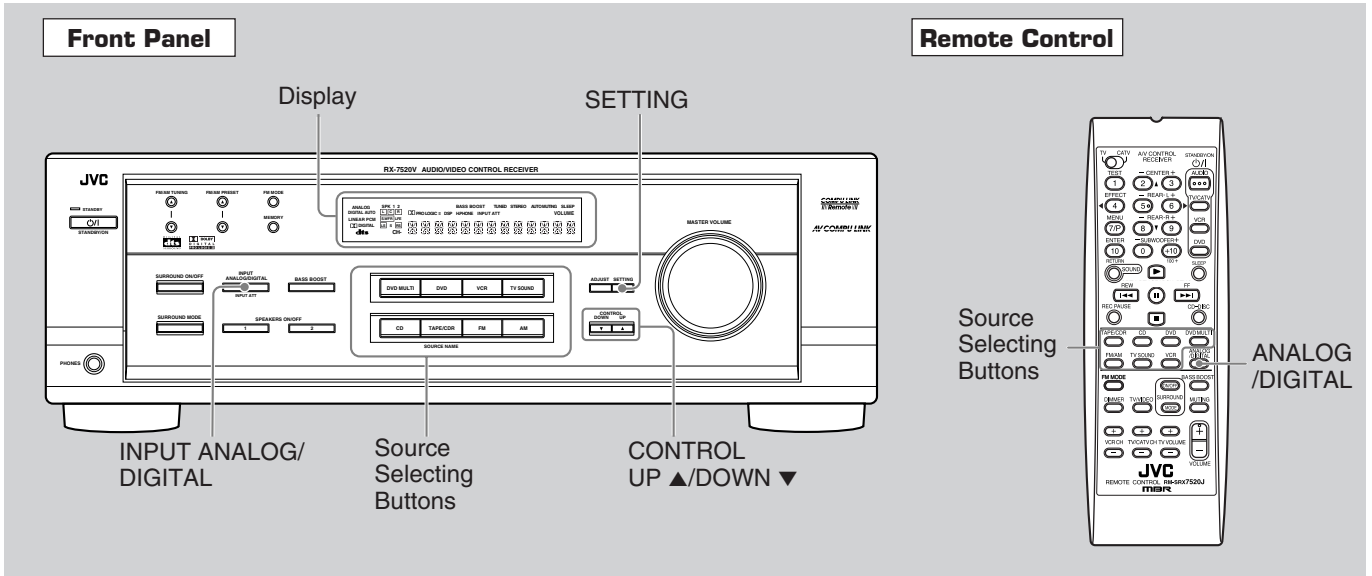

Setting the Digital Input [DIGITAL IN] Terminals



When you use the digital input terminals, register what components are connected to which terminals (DIGITAL IN 1/2) so that the correct source name will appear when you select the digital source.

Before you start, remember...

There is a time limit in doing the following steps. If the setting is canceled before you finish, start from step 1 again.

- 1 Press **SETTING** repeatedly until **“DIGITAL IN”** appears on the display.

Then the display changes to show the current setting.

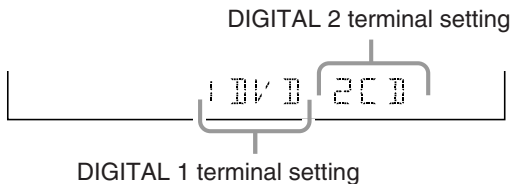

* “1DVD 2CD” is the initial setting. If you have already changed the setting, another combination will be shown.

- 2 Press **CONTROL UP ▲/DOWN ▼** to select the appropriate digital terminal setting.

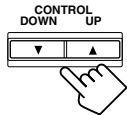

- Each time you press the button, the display changes as follows:

1 DVD 2 CD	↔	1 DVD 2 TV	↔	1 DVD 2 CDR	↔
1 CD 2 DVD	↔	1 CD 2 TV	↔	1 CD 2 CDR	↔
1 TV 2 DVD	↔	1 TV 2 CD	↔	1 TV 2 CDR	↔
1 CDR 2 DVD	↔	1 CDR 2 CD	↔	1 CDR 2 TV	↔

(back to the beginning)

Note:

When shipped from the factory, the DIGITAL IN terminals have been set for use with the following components:

- DIGITAL 1 (coaxial): For DVD player
- DIGITAL 2 (optical): For CD player

Selecting the Analog or Digital Input Mode

When you have connected digital source components using both the analog connections (see page 6) and the digital connections (see page 9) methods, you need to select the input mode correctly.

Before you start, remember...

There is a time limit in doing the following steps. If the setting is canceled before you finish, start from step 1 again.

- 1 Press one of the source selecting buttons—**DVD, TV SOUND, CD, or TAPE/CDR***—for which you want to change the input mode.

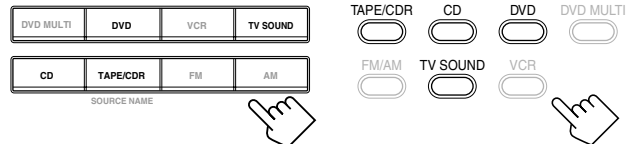

On the front panel

From the remote control

Note:

* Among the sources listed above, you can select the digital input only for the sources which you have selected the digital input terminals for. (See “Setting the Digital Input (DIGITAL IN) Terminals” on the left column.)

2 Press INPUT ANALOG/DIGITAL (or ANALOG/DIGITAL on the remote control) to select the digital input mode.

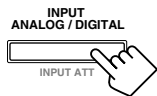

On the front panel



From the remote control

- Each time you press the button, the input mode alternates between the analog input ("ANALOG") and the digital input ("DIGITAL AUTO").

DIGITAL AUTO : Select this for the digital input mode. The receiver automatically detects the incoming signal format. (The DIGITAL AUTO indicator lights up on the display, then the digital signal indicator for the detected signals lights up.)

ANALOG : Select this for the analog input mode. (Initial setting when shipped from the factory.)

If the following symptoms occur while playing Dolby Digital or DTS Digital Surround software with "DIGITAL AUTO" selected, follow the procedure below:

- Sound does not come out at the beginning of playback.
- Noise comes out while searching or skipping chapters or tracks.

1 Press INPUT ANALOG/DIGITAL (or ANALOG/DIGITAL on the remote control).

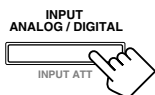

On the front panel



From the remote control

2 Press CONTROL UP ▲/DOWN ▼ to select "DOLBY DIGITAL" or "DTS SURROUND" while "DIGITAL AUTO" still remains on the display.



- Each time you press the button, the digital input mode changes as follows:

When "DOLBY DIGITAL" or "DTS SURROUND" is selected, "DIGITAL AUTO" goes off.

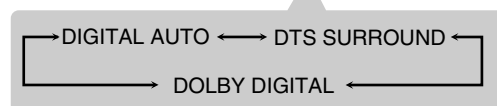
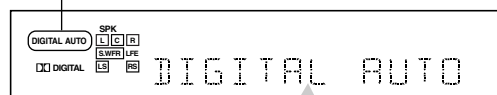

- To play back software encoded with Dolby Digital, select "DOLBY DIGITAL."
- To play back software encoded with DTS Digital Surround, select "DTS SURROUND."

Note:

When you turn off the power or select another source, "DOLBY DIGITAL" and "DTS SURROUND" are canceled and the digital input mode is automatically reset to "DIGITAL AUTO."

The following are the analog/digital signal indicators on the display to indicate what type of the signal comes into the receiver.

- ANALOG** : Lights when the analog input is selected.
- LINEAR PCM** : Lights when Linear PCM signals come in.
- DIGITAL** : Lights when Dolby Digital signals come in.
- Flashes when "DOLBY DIGITAL" is selected for software not encoded with Dolby Digital signals.
- dts** : Lights when DTS signals come in.
- Flashes when "DTS SURROUND" is selected for software not encoded with DTS signals.

Note:

When "DIGITAL AUTO" cannot recognize the incoming signals, no digital signal indicators light up on the display.

Basic Settings

Selecting the Video Input Terminal



This receiver is equipped with the component video input terminals for the DVD player which give you higher picture quality. When you use the component video input terminals for the DVD player, change the video input terminal setting.

Before you start, remember...

There is a time limit in doing the following steps. If the setting is canceled before you finish, start from step 1 again.

1 Press SETTING repeatedly until "VIDEO IN DVD" or "VIDEO IN VCR" appears on the display.



- Select "VIDEO IN DVD" to select the video input terminal for the DVD player and "VIDEO IN VCR" for the VCR.

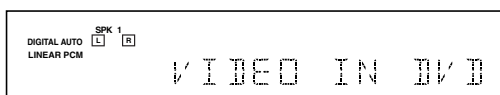

After 2 seconds, the display changes to show the current setting.

2 Press CONTROL UP ▲/DOWN ▼ to select the appropriate type of the video input terminal.

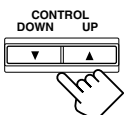

- Each time you press the button, the display changes as follows:

COMPONENT ← S/C
(Component) (S-video/Composite)

COMPONENT : Select this when you connect the DVD player or VCR to the component video input terminals.

S/C : Select this when you connect the DVD player or VCR to the S-video or composite video input terminal.

Note:

Without changing the video input terminal setting, you can see the picture through the video input terminals, but cannot use the AV COMPU LINK remote control system correctly (see page 32).

"NO" for the subwoofer, "LARGE" for the front speakers, and "SMALL" for the center and rear speakers are initial settings. To get best possible sound, change the subwoofer and speaker settings to fit your listening conditions.

Setting the Speaker Information



To obtain the best possible sound or effect from Surround modes (see pages 26 to 29), register the following speakers and subwoofer information after all connections are completed.

The following are items you can set:

- Subwoofer information—SUBWOOFER
- Speaker size—FRNT SP, CNTR SP, REAR SP
- Speaker distance—UNIT, FRNT DIS, CNTR DIS, REAR DIS
- Crossover frequency—CROSS
- Low frequency effect attenuator—LFE ATT
- Dynamic range compression—D. COMP

Before you start, remember...

There is a time limit in doing the following steps. If the setting is canceled before you finish, start from step 1 again.

Subwoofer information

Register whether you have connected a subwoofer or not.

1 Press SETTING repeatedly until "SUBWOOFER" (with the current setting)* appears on the display.

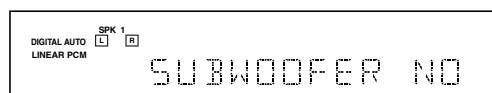

* "NO" is the initial setting. If you have already changed the setting, "YES" will be shown.

2 Press CONTROL UP ▲/DOWN ▼ to register whether you have connected a subwoofer or not.

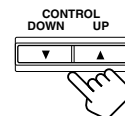

- Each time you press the button, the subwoofer setting alternates between "YES" and "NO."

YES : Select this when you have connected a subwoofer. You can adjust the subwoofer output level (see page 20).

NO : Select this when you have not connected or have disconnected a subwoofer.

Speaker size

Register the sizes of all the connected speakers.

- When you change your speakers, register the information about the speakers again.

- 1 Press **SETTING** repeatedly until “FRNT SP (Front Speaker),” “CNTR SP (Center Speaker)” or “REAR SP (Rear Speaker)” (with the current setting)* appears on the display.

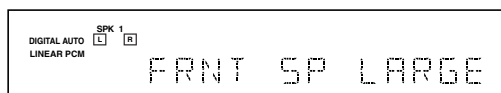

- * “LARGE” is the initial setting for the front speakers and “SMALL” is for the center and rear speakers. If you have already changed the setting, another size will be shown.

- 2 Press **CONTROL UP ▲/DOWN ▼** to select the appropriate item about the speaker selected in the above step.

- Each time you press the button, the display changes as follows:

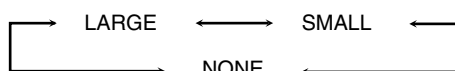

LARGE : Select this when the speaker size is relatively large.
(See “Notes” below.)

SMALL : Select this when the speaker size is relatively small.
(See “Notes” below.)

NONE : Select this when you have not connected a speaker.
(Not selectable for the front speakers)

- 3 Repeat steps 1 and 2 to select the appropriate items for other speakers.

Notes:

- Keep the following comment in mind as reference when adjusting.
 - If the size of the cone speaker unit built in your speaker is greater than 12 cm (4 3/4 inches), select “LARGE,” and if it is smaller than 12 cm (4 3/4 inches), select “SMALL.”
- If you have selected “NO” for the subwoofer setting, you can only select “LARGE” for the front speaker setting.
- If you have selected “SMALL” for the front speaker setting, you cannot select “LARGE” for the center and rear speaker settings.

Speaker distance

Register the unit you use, then the speaker distance from your listening point.

- If you have set the unit before, start from step 3.
- Speaker distance is not valid for the DVD MULTI playback mode.

- 1 Press **SETTING** repeatedly until “UNIT” (with the current setting)* appears on the display.

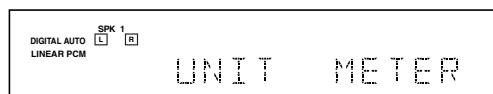

- * “METER” is the initial setting. If you have already changed the setting, “FEET” will be shown.

- 2 Press **CONTROL UP ▲/DOWN ▼** to select the unit.

- Each time you press the button, the setting alternates between “METER” and “FEET.”

METER : Speaker distance is shown in meters.

FEET : Speaker distance is shown in feet.

- 3 Press **SETTING** repeatedly until “FRNT DIS (Front distance),” “CNTR DIS (Center distance)” or “REAR DIS (Rear distance)” (with the current setting)* appears on the display.

- The display shows the current setting in the unit selected in step 2.

- * “3.0m” is the initial setting for meter and “10FT” is for feet. If you have already changed the setting, another value will be shown.

- 4 Press **CONTROL UP ▲/DOWN ▼** to select the appropriate speaker distance.

- If you select “METER” in step 2, the value is changed from “0.3m” to “9.0m” by 0.3 m step.
- If you select “FEET” in step 2, the value is changed from “1FT” to “30FT” by 1 foot step.

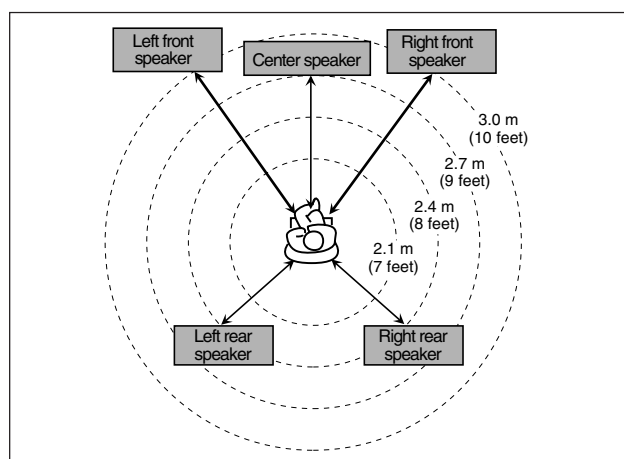

Example: In this case, set “FRNT DIS” to “3.0m” or “10FT,” set “CNTR DIS” to “2.7m” or “9FT,” and set “REAR DIS” to “2.4m” or “8FT.”

Note:

If you have selected “NONE” for the center and rear speakers setting, you cannot set the speaker distance for the center and rear speakers.

Basic Settings

Crossover frequency

Small speakers cannot reproduce the bass sounds efficiently. If you use a small speaker in any position, this receiver automatically reallocates the bass sound elements assigned from the small speaker to large speakers.

To use this function properly, set this crossover frequency level according to the size of the small speaker connected.

- If you have selected "LARGE" for all speakers, this function will not take effect.
- Crossover frequency is not valid for the DVD MULTI playback mode and HEADPHONE mode.

- 1 Press **SETTING** repeatedly until "**CROSS (Crossover)**" (with the current setting)* appears on the display.

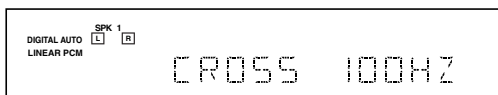

* "100HZ" is the initial setting. If you have already changed the setting, another frequency will be shown.

- 2 Press **CONTROL UP ▲/DOWN ▼** to select the crossover frequency level you like to use.

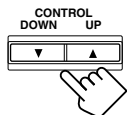

- Each time you press the button, the crossover frequency level changes as follows:

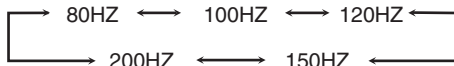

Low frequency effect attenuator

If the bass sound is distorted while playing back software using **Dolby Digital** or **DTS Digital Surround**, follow the procedure below:

- Low frequency effect attenuator is not valid for DVD MULTI playback mode.
- This function takes effect only when the subwoofer (LFE) signals come in (with "SUBWOOFER" set to "YES").

- 1 Press **SETTING** repeatedly until "**LFE ATT (Low Frequency Effect Attenuator)**" (with the current setting)* appears on the display.

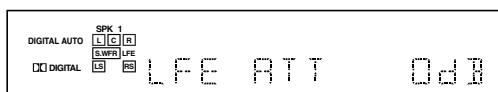

* "0dB" is the initial setting. If you have already changed the setting, "-10dB" will be shown.

- 2 Press **CONTROL UP ▲/DOWN ▼** to select the low frequency effect attenuator level.

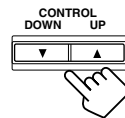

- Each time you press the button, the setting alternates between "0dB" and "-10dB."

0dB : Normally select this.

-10dB : Select this when the bass sound is distorted.

Dynamic range compression

You can compress the dynamic range (difference between maximum sound and minimum sound) of the reproduced sound. This is useful when enjoying surround sound at night.

- This function takes effect only when playing back a source encoded with **Dolby Digital**.

- 1 Press **SETTING** repeatedly until "**D. COMP (Dynamic range compression)**" (with the current setting)* appears on the display.



* "MID" is the initial setting. If you have already changed the setting, another setting will be shown.

- 2 Press **CONTROL UP ▲/DOWN ▼** to select the appropriate compression level.

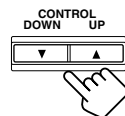

- Each time you press the button, the display changes as follows:

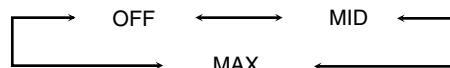

OFF : Select this when you want to enjoy surround with its full dynamic range. (No effect applied.)

MID : Select this when you want to reduce the dynamic range a little.

MAX : Select this when you want to apply the compression effect fully. (Useful at night.)

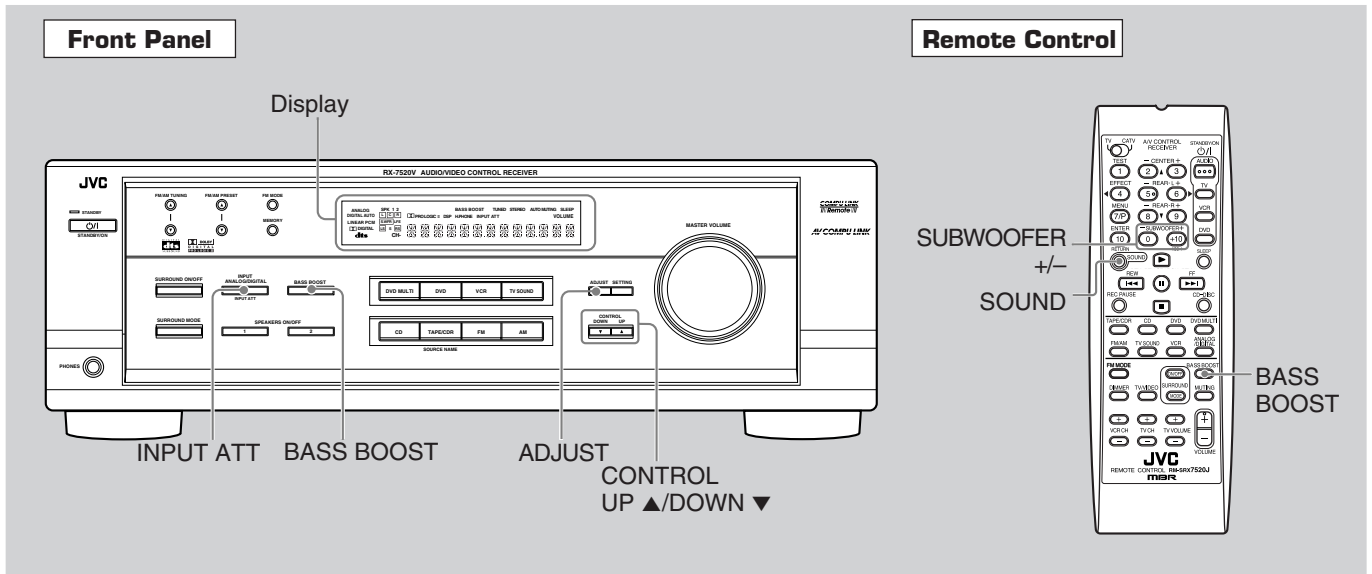

Once each of following settings has been adjusted, this receiver memorizes the adjustment for each source.

Attenuating the Input Signal



When the input level of the **analog source** is too high, the sounds will be distorted. If this happens, you need to attenuate the input signal level to prevent the sound distortion.

- 1 Press and hold **INPUT ATT** (INPUT ANALOG/DIGITAL) so that the **INPUT ATT** indicator lights up on the display.

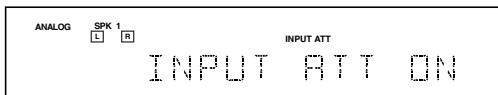
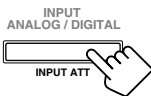

- Each time you press and hold the button, the Input Attenuator mode turns on (“INPUT ATT ON”) or off (“INPUT NORMAL”).

Note:

When selecting “DVD MULTI” as the source, this effect does not work.

Adjusting the Front Speakers Output Balance



If the sounds you hear from the front right and left speakers are unequal, you can adjust the speakers output balance.

Before you start, remember...

There is a time limit in doing the following steps. If the setting is canceled before you finish, start from step 1 again.

- 1 Press **ADJUST** repeatedly until “**BALANCE**” (with the current setting)* appears on the display.

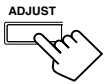

- * “CNTR (Center)” is the initial setting. If you have already changed the setting, another setting will be shown.

- 2 Press **CONTROL UP ▲/DOWN ▼** to adjust the balance.

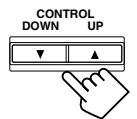

- Pressing **CONTROL UP ▲** decreases the left channel output from “CNTR” (Center) to “L-21.”
- Pressing **CONTROL DOWN ▼** decreases the right channel output from “CNTR” (Center) to “R-21.”

Sound Adjustments

Adjusting the Tone



You can adjust the bass and treble sounds as you like.

Before you start, remember...

There is a time limit in doing the following steps. If the setting is canceled before you finish, start from step 1 again.

- 1 Press **ADJUST** repeatedly until “**BASS**” or “**TREBLE**” (with the current setting)* appears on the display.

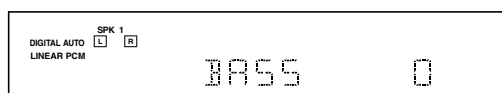

* “0” is the initial setting. If you have already changed the setting, another number (level) will be shown.

BASS : To adjust the bass.

TREBLE : To adjust the treble.

- 2 Press **CONTROL UP ▲/DOWN ▼** to adjust the bass or treble sounds level (–10 to +10).

- Each time you press the button, the sound level changes by ± 2 steps.

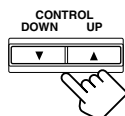

Adjusting the Subwoofer Output Level

You can adjust the subwoofer output level if you have connected a subwoofer and set the subwoofer information correctly—“YES.”

On the front panel:

Before you start, remember...

There is a time limit in doing the following steps. If the setting is canceled before you finish, start from step 1 again.

- 1 Press **ADJUST** repeatedly until “**SUBWFR**” (with the current setting)* appears on the display.

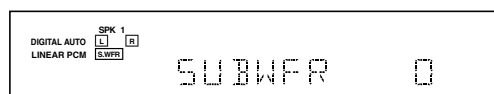

* “0” is the initial setting. If you have already changed the setting, another number (level) will be shown.

- 2 Press **CONTROL UP ▲/DOWN ▼** to adjust the subwoofer output level (–10 to +10).

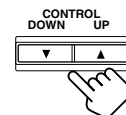

From the remote control:

- 1 Press **SOUND**.

The 10 keys are activated for sound adjustments.



- 2 Press **SUBWOOFER +/-** to adjust the subwoofer output level (–10 to +10).

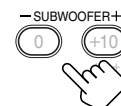

Note:

Subwoofer output level cannot be adjusted when using headphones.

Reinforcing the Bass

You can boost the bass level.

Press **BASS BOOST** to select the bass boost function.

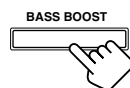

On the front panel



From the remote control

- Each time you press the button, the bass boost function turns on (“BASSBOOST ON”) and off (“BASSBOOST OFF”).
 - Select “BASSBOOST ON” to activate the bass boost function. The BASS BOOST indicator lights up on the display.
 - Select “BASSBOOST OFF” to cancel it. The indicator goes off.

Note:

This function affects the front speaker sounds only.

Tuner Operations

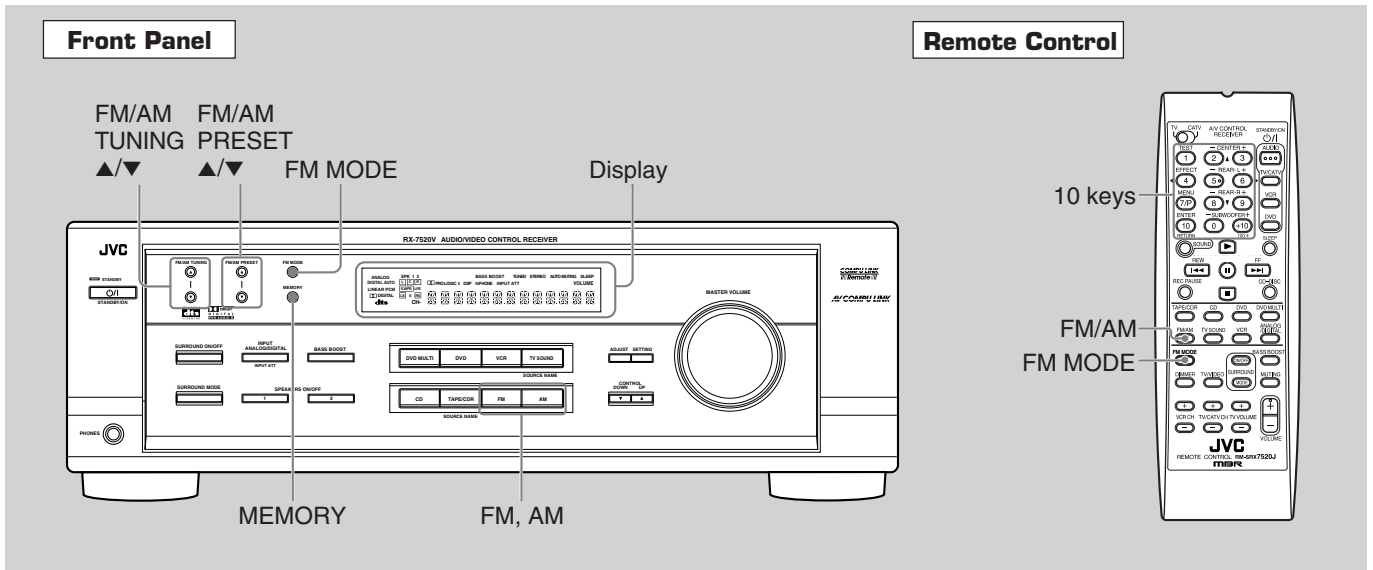

Tuning in Stations Manually

1 Press FM or AM (FM/AM).

The last received station of the selected band is tuned in.



On the front panel



From the remote control

- Each time you press the button on the remote control (FM/AM), the band alternates between FM and AM.

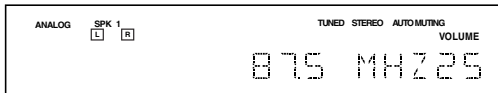

Ex.: When the FM band is selected

2 Press FM/AM TUNING ▲/▼ repeatedly until you find the frequency you want.

- Pressing FM/AM TUNING ▲ increases the frequency.
- Pressing FM/AM TUNING ▼ decreases the frequency.



FM/AM TUNING

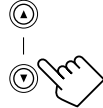

Notes:

- When you hold FM/AM TUNING ▲/▼ in step 2, the frequency keeps changing until a station is tuned in.
- When a station of sufficient signal strength is tuned in, the TUNED indicator lights up on the display.
- When an FM stereo program is received, the STEREO indicator also lights up.

Using Preset Tuning

Once a station is assigned to a channel number, the station can be quickly tuned. You can preset up to 30 FM and 15 AM stations.

To store the preset stations

Before you start, remember...

There is a time limit in doing the following steps. If the setting is canceled before you finish, start from step 2 again.



1 Tune in the station you want to preset (see "Tuning in Stations Manually").

If you want to store the FM reception mode for this station, select the FM reception mode you want. See "Selecting the FM Reception Mode" on page 22.

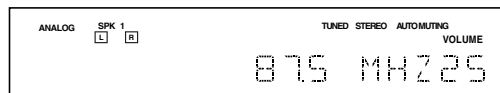

2 Press MEMORY.

The CH- indicator lights up and the channel number position starts flashing for about 5 seconds.

MEMORY

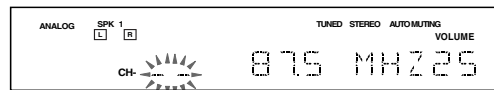

3 Press FM/AM PRESET ▲/▼ to select a channel number while the channel number position is flashing.

FM/AM PRESET

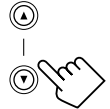

Tuner Operations

4 Press MEMORY again while the selected channel number is flashing on the display.

The selected channel number stops flashing.
The station is assigned to the selected channel number.

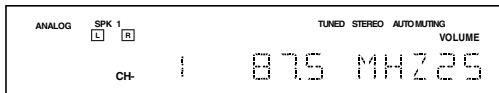

5 Repeat steps 1 to 4 until you store all the stations you want.

To erase a stored preset station

Storing a new station on a used number erases the previously stored one.

To tune in a preset station

On the front panel:

1 Press FM or AM.

The last received station of the selected band is tuned in.

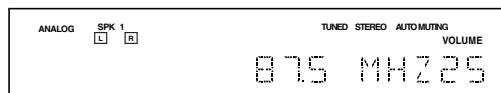
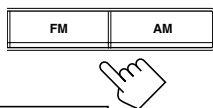

2 Press FM/AM PRESET ▲/▼ repeatedly until you find the channel you want.

- Pressing FM/AM PRESET ▲ increases the channel numbers.
- Pressing FM/AM PRESET ▼ decreases the channel numbers.

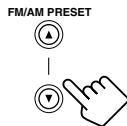

From the remote control:

1 Press FM/AM to select the band —FM or AM.

The last received station of the selected band is tuned in and the 10 keys now work for tuner operation.

- Each time you press the button, the band alternates between FM and AM.



2 Press 10 keys to select a preset channel number.

- For channel number 5, press 5.
- For channel number 15, press +10 then 5.
- For channel number 20, press +10 then 10.
- For channel number 30, press +10, +10, then 10.



Note:

When you use 10 keys on the remote control, be sure that they are activated for the tuner, not for the CD and others. (See page 34).

Selecting the FM Reception Mode

When an FM stereo broadcast is hard to receive or noisy, you can change the FM reception mode while receiving an FM broadcast.

- You can store the FM reception mode for each preset station. (See page 21).

1 While listening to an FM station, press FM MODE.

- Each time you press the button, the FM reception mode alternates between “AUTO*” and “MONO.”



On the front panel



From the remote control

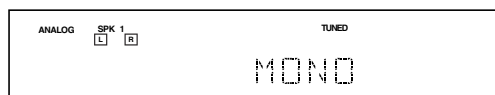
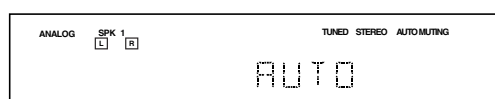

* “AUTO” is the initial setting.

AUTO

: Normally select this.

When a program is broadcasted in stereo, you will hear stereo sound; when in monaural, you will hear monaural sounds. This mode is also useful to suppress static noise between stations. The AUTO MUTING indicator lights up on the display.

MONO

: Select this to improve the reception (but stereo effect will be lost).

In this mode, you will hear noise while tuning into the stations. The AUTO MUTING indicator goes off from the display. (The STEREO indicator also goes off.)

You can use the following Surround modes to reproduce a realistic sound field:

- Dolby Surround
 - Dolby Pro Logic II
 - Dolby Digital
- DTS Digital Surround
- DAP modes
- All Channel Stereo

■ Dolby Surround

Dolby Pro Logic II*

Dolby Pro Logic II has a newly developed multichannel playback format to decode all 2 channel sources—stereo source and Dolby Surround encoded source—into 5.1 channel.

Matrix-based encoding/decoding method for Dolby Pro Logic II makes no limitation for the cutoff frequency of the rear treble and enables stereo rear sound compared to conventional Dolby Pro Logic.

Dolby Pro Logic II enables to reproduce spacious sound from original sound without adding any new sounds and tonal colorations. Dolby Pro Logic II has two modes—**Movie mode** and **Music mode**:

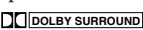
Pro Logic II Movie (PL II MOVIE)—suitable for reproduction of Dolby Surround encoded sources bearing the mark . You can enjoy soundfield very close to the one created with discrete 5.1 channel sounds.

Pro Logic II Music (PL II MUSIC)—suitable for reproduction of any 2 channel stereo music sources. You can enjoy wide and deep sound by using this mode. For this mode, Panorama control can be selected, which gives “wraparound” sound effect with side-wall image.

- When Dolby Pro Logic II is activated, the  PRO LOGIC II indicator lights up on the display.

Dolby Digital*

Used to reproduce multichannel sound tracks of the software encoded with Dolby Digital ().

- To enjoy the software encoded with Dolby Digital, connect the source component using the digital terminal on the rear of this receiver. (See page 9.)

Dolby Digital 5.1 ch encoding method (so-called discrete multichannel digital audio format) records and digitally compresses the left front channel, right front channel, center channel, left rear channel, right rear channel, and LFE channel signals. Since each channel is completely independent from the other channel signals to avoid interference, you can obtain much better sound quality with much stereo and surround effect.

Note:

Dolby Digital software can be roughly grouped into two categories—multichannel (up to “5.1” ch) and 2 channel software. To enjoy surround sounds while playing Dolby Digital 2 ch software, you can use Dolby Pro Logic II.

■ DTS Digital Surround**

Used to reproduce multichannel sound tracks of the software encoded with DTS Digital Surround ().

- To enjoy the software encoded with DTS Digital Surround, connect the source component using the digital terminal on the rear of this receiver. (See page 9.)

DTS Digital Surround is another discrete multichannel digital audio format available on CD, LD, and DVD software. Compared to Dolby Digital, audio compression ratio is relatively low. This fact allows DTS Digital Surround format to add breadth and depth to the reproduced sounds. As a result, DTS Digital Surround features natural, solid and clear sound.

Typical Multichannel (5.1 ch) reproduction

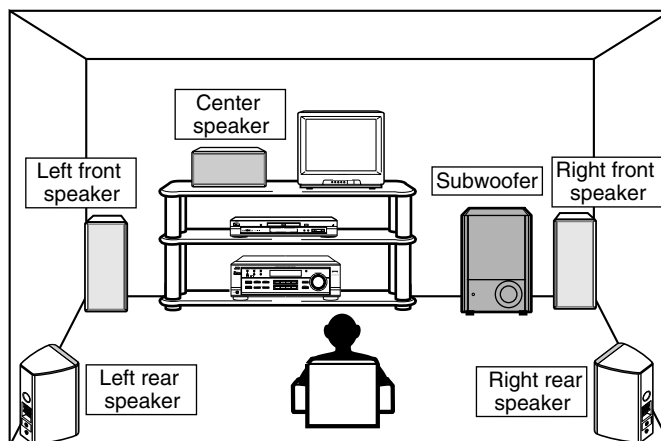

* Manufactured under license from Dolby Laboratories. “Dolby,” “Pro Logic,” and the double-D symbol are trademarks of Dolby Laboratories. Confidential unpublished works. ©1992–1997 Dolby Laboratories, Inc. All rights reserved.

** Manufactured under license from Digital Theater Systems, Inc. US PAT. No. 5,451,942 and other world-wide patents issued and pending. “DTS” and “DTS Digital Surround” are trademarks of Digital Theater Systems, Inc. Copyright 1996 Digital Theater Systems, Inc. All rights reserved.

Creating Realistic Sound Fields

■ DAP (Digital Acoustic Processor) modes

DAP modes have been designed to create important acoustic surround elements.

The sound heard in a live club, dance club, hall or pavilion consists of direct sound and indirect sound—early reflections and reflections from behind. Direct sounds reach the listener directly without any reflection. On the other hand, indirect sounds are delayed by the distances of the ceiling and walls (see the diagram below). These indirect sounds are important elements of the acoustic surround effects. The DAP mode can reproduce a realistic sound field by adding these indirect sounds.

DAP modes can be used when the front and rear speakers are connected to this receiver (without respect to the center speaker connection: no sound comes out of the center speaker even if it is connected).

The following DAP modes are provided with this receiver:

LIVE CLUB	: Gives the feeling of a live music club with a low ceiling.
DANCE CLUB	: Gives a throbbing bass beat.
HALL	: Gives clear vocal and the feeling of a concert hall.
PAVILION	: Gives the spacious feeling of a pavilion with a high ceiling.

These DAP modes can be used to add the acoustic surround effects while reproducing 2 channel stereo software—either analog or digital except Dolby Digital and DTS Digital Surround—and can give you a real “being there” feeling.

- When one of the DAP modes is selected, the DSP indicator lights up on the display.

Creating sound field

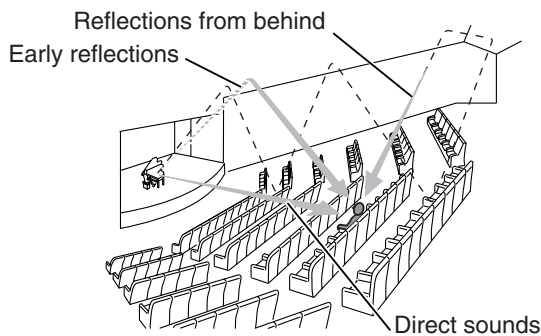

■ All Channel Stereo

This mode can reproduce a larger stereo sound field using all the connected (and activated) speakers.

All Channel Stereo can be used when the front and rear speakers are connected to this receiver without respect to the center speaker connection.

If the center speaker is connected and activated, the same phase of the front left and right signals are output through the center speaker.

All Channel Stereo can be used while reproducing 2 channel stereo software, either analog or digital except Dolby Digital and DTS Digital Surround.

- When All Channel Stereo is selected, the DSP indicator lights up on the display.

All Channel Stereo reproduction

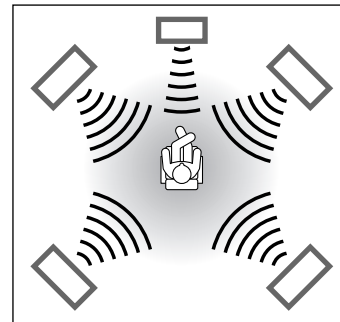

Sound reproduced from All Channel Stereo

DVD MULTI Playback Mode

This receiver provides the DVD MULTI playback mode for reproducing the analog discrete 5.1 channel output mode of the DVD player or other equipment.

You can adjust speaker output levels while playing back a video software such as a DVD using the analog discrete 5.1 channel output mode.

- For connecting analog discrete output jacks, see page 8.
- For details on the DVD MULTI playback mode, see page 30.

Note:

When you select “DVD MULTI” as the source to play, Surround mode is canceled, and the SURROUND ON/OFF and SURROUND MODE buttons do not work.

Available Surround modes for each input signal

○: Possible / ×: Impossible









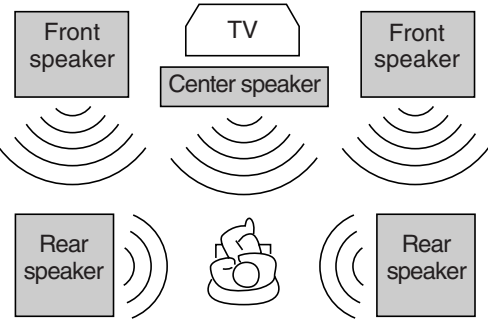

Mode Signals	SURROUND OFF (stereo)	DOLBY DIGITAL	DTS SURROUND	PLII MOVIE	PLII MUSIC	LIVE CLUB	DANCE CLUB	HALL	PAVILION	ALL CH STEREO
Dolby Digital (Multichannel)	○	○	×	×	×	×	×	×	×	×
Dolby Digital (2 channel)	○	×	×	○	○	×	×	×	×	×
DTS Digital Surround (Multichannel)	○	×	○	×	×	×	×	×	×	×
DTS Digital Surround (2 channel)	○	×	×	○	○	×	×	×	×	×
Linear PCM	○	×	×	○	○	○	○	○	○	○
Analog	○	×	×	○	○	○	○	○	○	○

About Relations between Speaker Layouts and Surround Modes

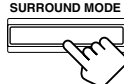
Available Surround modes will vary depending on how many speakers are used with this receiver.

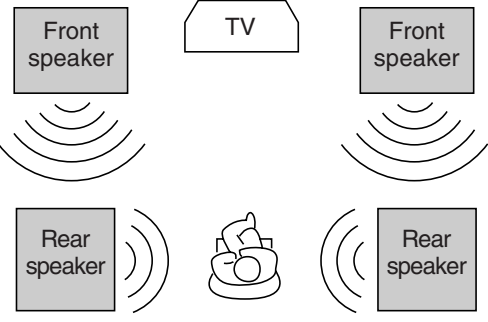
Make sure that you have set the speaker information correctly (see pages 16 to 18).

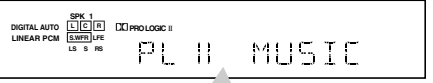
- If only front speakers are connected, you cannot use Surround modes.
- If rear speakers are not connected, you cannot use DAP modes and All Channel Stereo.

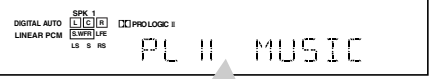
Speaker Layouts	Available Surround modes																
<p>When the center and rear speakers are connected (5 channels):</p> 	<h3>Turning on or off the Surround modes</h3> <p>Each time you press SURROUND ON/OFF, Surround modes turn on or off.</p>  (Remote)  (Front panel)  <p>Last selected Surround mode → SURROUND OFF</p> <p>Ex.: "PL II MUSIC" has been selected.</p> <h3>Selecting the Surround modes</h3> <p>Each time you press SURROUND MODE, Surround modes change as follows:</p>  (Remote)  (Front panel)  <table border="1" data-bbox="1015 981 1449 1122"> <tr> <td>PL II MOVIE</td> <td>→</td> <td>PL II MUSIC</td> <td>→</td> </tr> <tr> <td>LIVE CLUB</td> <td>→</td> <td>DANCE CLUB</td> <td>→</td> </tr> <tr> <td>HALL</td> <td>→</td> <td>PAVILION</td> <td>→</td> </tr> <tr> <td>ALL CH STEREO</td> <td>→</td> <td>(Back to the beginning)</td> <td>→</td> </tr> </table> <p>Note: When the digital multichannel software such as Dolby Digital or DTS Digital Surround is played back, the appropriate multichannel Surround mode is activated ("DOLBY DIGITAL" or "DTS SURROUND") by pressing SURROUND ON/OFF (with the digital input mode selected).</p> <ul style="list-style-type: none"> • For Dolby Digital 2 ch software, you need to select "PLII MUSIC" or "PLII MOVIE" by pressing SURROUND MODE. • For more details, see the table on page 24. 	PL II MOVIE	→	PL II MUSIC	→	LIVE CLUB	→	DANCE CLUB	→	HALL	→	PAVILION	→	ALL CH STEREO	→	(Back to the beginning)	→
PL II MOVIE	→	PL II MUSIC	→														
LIVE CLUB	→	DANCE CLUB	→														
HALL	→	PAVILION	→														
ALL CH STEREO	→	(Back to the beginning)	→														
<p>When the rear speakers are connected (4 channels):</p> 	<h3>Turning on or off the Surround modes</h3> <p>Each time you press SURROUND ON/OFF, the Surround modes turn on or off.</p>  (Remote)  (Front panel)  <p>PL II MOVIE or PL II MUSIC → SURROUND OFF</p> <p>Ex.: "PL II MUSIC" has been selected.</p> <h3>Selecting the Surround modes</h3> <p>Each time you press SURROUND MODE, Surround modes change as follows:</p>  (Remote)  (Front panel)  <table border="1" data-bbox="1015 1877 1449 1921"> <tr> <td>PL II MOVIE</td> <td>↔</td> <td>PL II MUSIC</td> </tr> </table> <p>Note: When the digital multichannel software such as Dolby Digital or DTS Digital Surround is played back, the appropriate multichannel Surround mode is activated ("DOLBY DIGITAL" or "DTS SURROUND") by pressing SURROUND ON/OFF (with the digital input mode selected).</p> <ul style="list-style-type: none"> • For Dolby Digital 2 ch software, you need to select "PLII MUSIC" or "PLII MOVIE" by pressing SURROUND MODE. • For more details, see the table on page 24. 	PL II MOVIE	↔	PL II MUSIC													
PL II MOVIE	↔	PL II MUSIC															

Creating Realistic Sound Fields

Before you start, remember...

- Make sure that you have set the speaker information correctly (see pages 16 to 18).
- You cannot adjust the center speaker output level when you have set "CNTR SP" to "NONE."
- You cannot adjust the rear speaker output levels when you have set "REAR SP" to "NONE."
- Remember not to change the speaker setting while using any Surround modes; otherwise, it may be canceled when you deactivate the speakers required for the Surround mode.

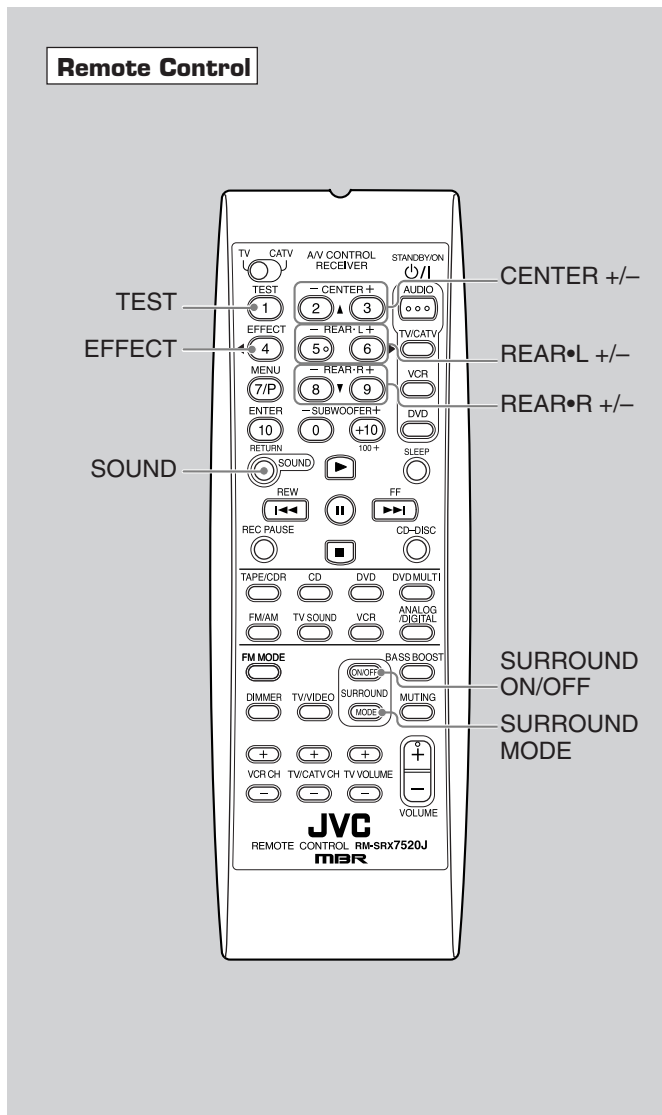
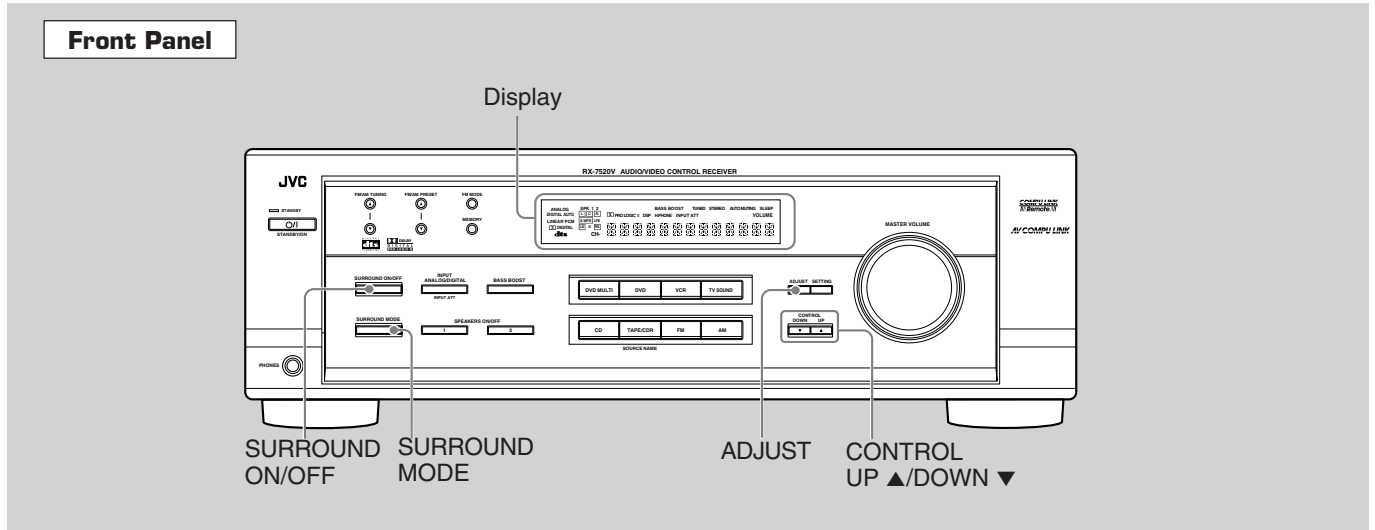

Using Dolby Pro Logic II, Dolby Digital and DTS Digital Surround

Once you have adjusted the Surround modes, the adjustment is memorized for each source.

- When playing back digital multichannel software (Dolby Digital 5.1 ch or DTS Digital Surround), the SURROUND MODE button does not work.

From the remote control:

It will be convenient for you to use the remote control for adjustments, since you can make adjustments from your listening point, by using the test signal.

- For selecting Panorama mode for Pro Logic II Music, use the button on the front panel.

1 Set the analog or digital input mode for the source you like to listen and start playing.

When playing back software encoded with Dolby Digital and DTS Digital Surround, select the digital input mode (see page 14).

2 Press SURROUND ON/OFF to activate Surround mode.

Each time you press the button, Surround mode turns on and off alternately.

- If you are playing back software encoded with Dolby Digital multichannel, "DOLBY DIGITAL" is selected.
- If you are playing back software encoded with DTS Digital Surround, "DTS SURROUND" is selected.
- If you are playing back any software other than above, you can select "PL II MUSIC" or "PL II MOVIE" according to the source by pressing SURROUND MODE. (PRO LOGIC II indicator lights up on the display.)

If you like to adjust sound, go to step 3.

3 Press SOUND.

The 10 keys are activated for sound adjustments.



4 Press TEST to check if you can hear the sounds through all the speakers at the equal level.

“TEST TONE L” starts flashing on the display and a test tone comes out of the speakers in the following order:

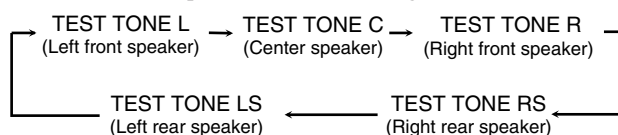

Notes:

- You can adjust the speaker output levels without outputting the test tone.
- No test tone comes out of the center speaker when “CNTR SP” is set to “NONE.”
- No test tone comes out of the rear speakers when “REAR SP” is set to “NONE.”

5 Adjust the speaker output levels (-10 to +10).

Adjust the center speaker and rear speakers levels comparing to the sound from the front speakers.

- To adjust the center speaker level, press CENTER +/-.

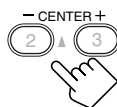

- To adjust the left rear speaker level, press REAR•L +/-.

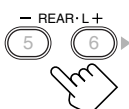

- To adjust the right rear speaker level, press REAR•R +/-.



6 Press TEST again to stop the test tone.



On the front panel:

You can also use the buttons on the front panel to adjust the Surround modes. However, no test tone is available when using the buttons on the front panel. So make adjustments while listening to the sound of the source played back.

1 Set the analog or digital input mode for the source you like to hear and start playing.

When playing back software encoded with Dolby Digital and DTS Digital Surround, select the digital input mode (see page 14).

2 Press SURROUND ON/OFF to activate Surround mode.

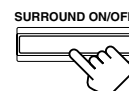

Each time you press the button, Surround mode turns on and off alternately.

- If you are playing back software encoded with Dolby Digital multichannel, “DOLBY DIGITAL” is selected.
- If you are playing back software encoded with DTS Digital Surround, “DTS SURROUND” is selected.
- If you are playing back any software other than above, you can select “PL II MUSIC” or “PL II MOVIE” according to the source by pressing SURROUND MODE. (PRO LOGIC II indicator lights up on the display.)

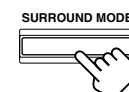

If you like to adjust sound, go to step 3.

3 Adjust the speaker output levels.

- 1) Press ADJUST repeatedly until one of the following indications (with the current setting)* appears on the display.

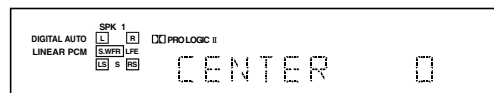
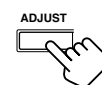

* “0” is the initial setting. If you have already changed the setting, another number (level) will be shown.

CENTER : To adjust the center speaker output level (-10 to +10).

REAR L : To adjust the left rear speaker output level (-10 to +10).

REAR R : To adjust the right rear speaker output level (-10 to +10).

- 2) Press CONTROL UP ▲/DOWN ▼ to adjust the selected speaker output levels.

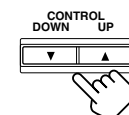

- 3) Repeat steps 1) and 2) to adjust the other speaker levels.

Creating Realistic Sound Fields

When you select “PL II MUSIC,” you can go to the following adjustment.



4 Turn Panorama control on or off.

- 1) Press ADJUST repeatedly until “PANORAMA” (with the current setting)* appears on the display.

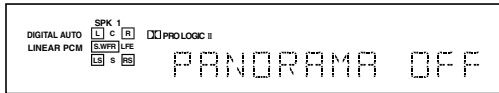
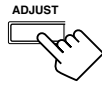

* “OFF” is the initial setting. If you have already changed the setting, “ON” will be shown.

- 2) Press CONTROL UP ▲/DOWN ▼ to turn on or off Panorama control.

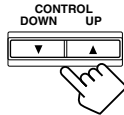

- Each time you press the button, “ON” and “OFF” change alternately.

ON	: Select this when you like to enjoy “wraparound” sound effect with side-wall image.
OFF	: Select this when you like to enjoy originally recorded sounds.

To cancel Surround mode

Press SURROUND ON/OFF again so that “SURROUND OFF” appears on the display.

- If Surround mode is canceled while playing back multichannel digital software, all channel signals are mixed and output through the front speakers (and subwoofer if you have connected a subwoofer and set the subwoofer setting correctly—“YES”).

Using DAP Modes and All Channel Stereo

Once you have adjusted the DAP modes and All Channel Stereo, the adjustment is memorized for each source.

- You cannot use the DAP modes and All Channel Stereo if no rear speakers are connected.
- You cannot adjust the effect level for “ALL CH STEREO.”

From the remote control:

It will be convenient for you to use the remote control for adjustments, since you can make adjustments from your listening point.

- 1 Start playing 2 channel software—either analog or Linear PCM—and select the source.

- 2 Press SURROUND ON/OFF to activate Surround mode.



When the Surround mode turns on, the last selected Surround mode will be activated.

- Each time you press the button, Surround mode turns on and off alternately.

- 3 Press SURROUND MODE repeatedly until one of the DAP modes—“LIVE CLUB,” “DANCE CLUB,” “HALL” and “PAVILION”—or “ALL CH STEREO” appears on the display.



The DSP indicator also lights up on the display.

If you like to adjust sound, go to step 4.

- 4 Press SOUND.

The 10 keys are activated for sound adjustments.



- 5 Adjust the speakers output levels (–10 to +10).

- To adjust the left rear speaker level, press REAR•L +/-.

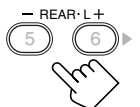

- To adjust the right rear speaker level, press REAR•R +/-.



For “ALL CH STEREO” only:

- To adjust the center speaker level, press CENTER +/-.



- 6 For DAP modes only: Press EFFECT to select the effect level (1 to 5) you want.

- Each time you press the button, the effect level changes as follows:

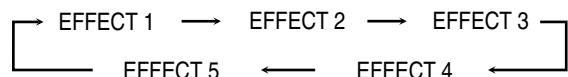

As the number increases, the selected mode becomes stronger (normally set it to “EFFECT 3”).

On the front panel:

1 Start playing 2 channel software—either analog or Linear PCM—and select the source.

2 Press SURROUND ON/OFF to activate Surround mode.

When Surround mode turns on, the last selected Surround mode will be activated.

- Each time you press the button, Surround mode turns on and off alternately.



3 Press SURROUND MODE repeatedly until one of the DAP modes—“LIVE CLUB,” “DANCE CLUB,” “HALL” and “PAVILION”—or “ALL CH STEREO” appears on the display.

The DSP indicator also lights up on the display.

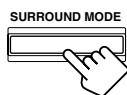

If you like to adjust sound, go to step 4.

4 Adjust the speaker output levels.

1) Press ADJUST repeatedly until one of the following indications (with the current setting)* appears on the display.



REAR L : To adjust the left rear speaker output level (–10 to +10).

REAR R : To adjust the right rear speaker output level (–10 to +10).

CENTER : For “ALL CH STEREO” only—to adjust the center speaker output level (–10 to +10).

* “0” is the initial setting. If you have already changed the setting, another number (level) will be shown.

2) Press CONTROL UP ▲/DOWN ▼ to adjust the selected speaker output levels.

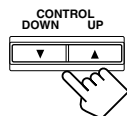

3) Repeat steps 1) and 2) to adjust the other speaker levels.

5 For DAP modes only: Adjust the effect level.

1) Press ADJUST repeatedly until “EFFECT” (with the current setting)* appears on the display.



* “EFFECT 3” is the initial setting. If you have already changed the setting, another setting will be shown.

2) Press CONTROL UP ▲/DOWN ▼ to select the effect level (1 to 5) you want.

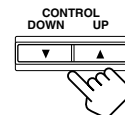

• Each time you press the button, the effect level changes as follows:

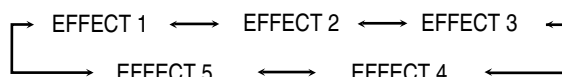

As the number increases, the selected mode becomes stronger (normally set it to “EFFECT 3”).

To cancel DAP modes and All Channel Stereo

Press SURROUND ON/OFF again so that “SURROUND OFF” appears on the display. The DSP indicator goes off.

Using DVD MULTI Playback Mode

This receiver provides the DVD MULTI playback mode for reproducing the analog discrete output mode of the DVD player. Before playing back a DVD, refer also to the manual supplied with the DVD player.

Activating DVD MULTI Playback Mode

You can adjust the DVD MULTI playback mode while playing back a DVD using the analog discrete output mode on the DVD player. Once you have made adjustments, the receiver memorizes the adjustments until you change them.

You also need to set the DVD player to the analog discrete output mode.

Before you start, remember....

There is a time limit in doing the following steps. If the setting is canceled before you finish, start from step **1** again.

On the front panel:

1 Press DVD MULTI.



Notes:

- When you select "DVD MULTI" as the source to play, the Surround mode is canceled, and the SURROUND ON/OFF and SURROUND MODE buttons do not work.
- If you select DVD MULTI as the source while using both the speakers connected to the FRONT SPEAKERS ① and ② terminals, the speakers connected to the FRONT SPEAKERS ② terminals are deactivated.
- When selecting "DVD MULTI" as the source, you can only select either the speakers connected to the FRONT SPEAKERS ① or ② terminals.

2 Select the analog discrete output mode on the DVD player, and start playing a DVD.

- Refer also to the manual supplied with the DVD player.

If you need to make any adjustments, go to the following steps.

3 Adjust the speaker output levels.

1) Press ADJUST repeatedly until one of the following indications appears on the display.

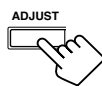

CENTER : To adjust the center speaker output level (-10 to +10).

REAR L : To adjust the left rear speaker output level (-10 to +10).

REAR R : To adjust the right rear speaker output level (-10 to +10).

2) Press CONTROL UP ▲/DOWN ▼ to adjust the selected speaker output levels.

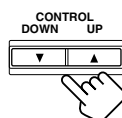

3) Repeat steps 1) and 2) to adjust the other speaker output levels.

From the remote control:

1 Press DVD MULTI.

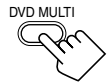

Note:

When you select "DVD MULTI" as the source to play, Surround mode is canceled, and the SURROUND ON/OFF and SURROUND MODE buttons do not work.

2 Select the analog discrete output mode on the DVD player, and start playing a DVD.

- Refer also to the manual supplied with the DVD player.

If you need to make any adjustments, go to the following steps.

3 Press SOUND.

The 10 keys are activated for adjusting the sound.



4 Adjust the speaker output levels.

- To adjust the center speaker level, press CENTER +/- (-10 to +10).
- To adjust the left rear speaker level, press REAR•L +/- (-10 to +10).
- To adjust the right rear speaker level, press REAR•R +/- (-10 to +10).

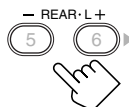
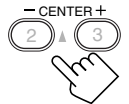

The COMPU LINK remote control system allows you to operate JVC's audio components through the remote sensor on the receiver. To use this remote control system, you need to connect JVC's audio components through the COMPU LINK-4 (SYNCHRO) jacks (see below) in addition to the connections using cables with RCA pin plugs (see pages 6 and 7).

- Make sure that the AC power cords of these components are unplugged before connection. Plug the AC power cords only after all connections are completed.

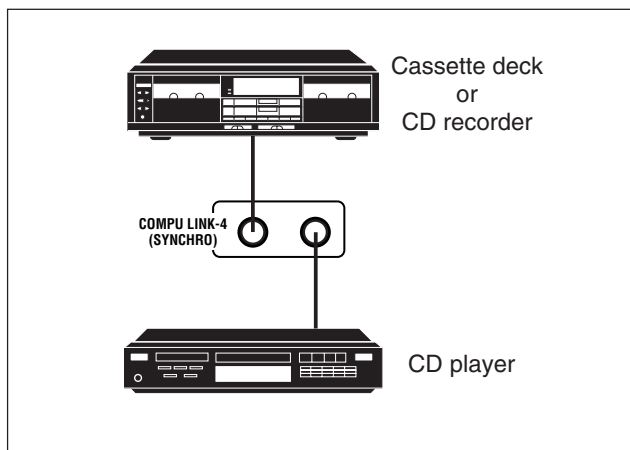

Notes:

- There are four versions of COMPU LINK remote control system. This receiver is equipped with the fourth version—COMPU LINK-4. This version is added systematic operations with the CD recorder to the previous version—COMPU LINK-3.
- If your audio component has two COMPU LINK jacks, you can use either one. If it has only one COMPU LINK jack, connect it so that it is the last item in the series of components.
- To operate the cassette deck or CD recorder using the COMPU LINK remote control system, set the source name correctly. (See page 11.)
- Refer also to the manuals supplied with your audio components.

This remote control system allows you to use four functions listed below.

Remote Control through the Remote Sensor on the Receiver

You can control the connected audio components through the remote sensor on the receiver using this remote control. Aim the remote control directly at the remote sensor on the receiver. For details, see pages 34 and 35.

Automatic Source Selection

When you press the play (▶) button on a connected component or on its own remote control, the receiver automatically turns on and changes the source to the component. On the other hand, if you select a new source on the receiver or on the remote control, the selected component begins playing immediately. In both cases, the previously selected source continues playing without sound for a few seconds.

Automatic Power On/Off (Standby): only possible with the COMPU LINK-3 and COMPU LINK-4

Both the CD player and cassette deck (or CD recorder) turn on and off (standby) along with the receiver. When you turn on the receiver, the CD player or cassette deck (or CD recorder) will turn on automatically, depending on which component has been previously selected. When you turn off the receiver, both the CD player and cassette deck (or CD recorder) will turn off (standby).

Synchronized Recording

Synchronized recording means the cassette deck starts recording as soon as a CD begins playing.

To use synchronized recording, follow these steps:

1 Put a tape in the cassette deck and a disc in the CD player.

2 Press the record (●) button and the pause (II) button on the cassette deck at the same time.

This puts the cassette deck into recording pause.

If you do not press the record (●) button and pause (II) button at the same time, the synchronized recording feature will not operate.

3 Press the play (▶) button on the CD player.

The source changes on the receiver, and as soon as play starts, the cassette deck starts recording. When the play ends, the cassette deck enters recording pause, and stops about 4 seconds later.

Notes:

- During synchronized recording, the selected source cannot be changed.
- If the power of any component is shut off during synchronized recording, the COMPU LINK remote control system may not operate properly. In this case, you must start again from the beginning.

AV COMPU LINK Remote Control System

The AV COMPU LINK remote control system allows you to operate JVC's video components (TV, VCR, and DVD player) through the receiver.

This receiver is equipped with the AV COMPU LINK-III, which added a function to operate JVC's video components through the video components terminals. To use this remote control system, you need to connect the video components you want to operate, following the diagrams below and the procedure on the next page.

CONNECTIONS 1: AV COMPU LINK Connection

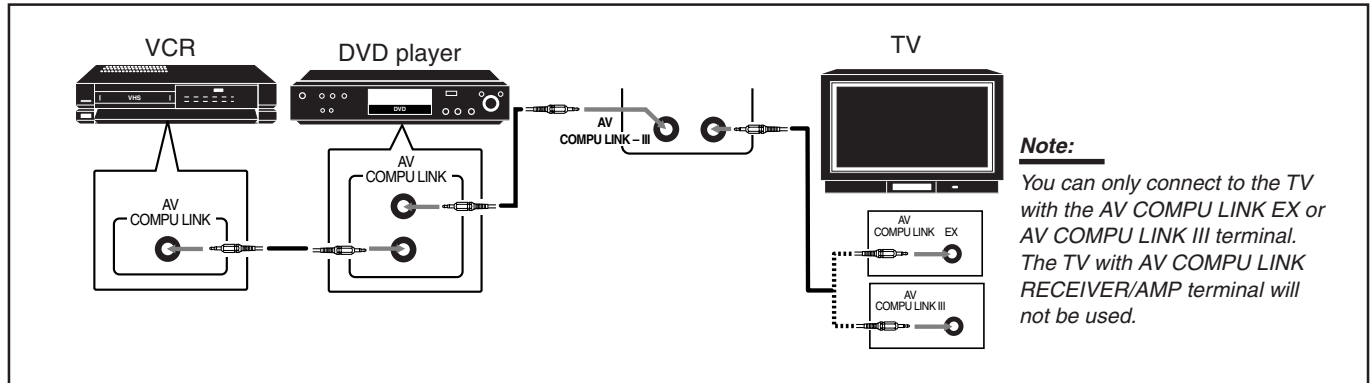

Notes:

- When connecting the receiver and a TV with the AV COMPU LINK EX or AV COMPU LINK III terminal by using a component video cable, you cannot use Automatic Selection of TV's Input Mode (see page 33).
- When connecting only the VCR or DVD player to this receiver, connect it directly to the receiver using cables with the monaural mini-plugs.
- Make sure that the remote control code of the VCR connected to the VCR jacks is set to code "A".
- Refer also to the manuals supplied with your video components.

CONNECTIONS 2: Video Cable Connections

This receiver is equipped with three types of video terminals—S-video, composite video, and component video, and the signals coming into this receiver through one type of video terminal can output only through the same type of the terminal. So you need to connect the VCR and/or DVD player to the TV using one of the following three ways:

<p>CASE 1</p>	<p>When connecting the source equipment to the receiver using the S-video terminals, connect also this receiver to the TV's Video Input 1 terminal using S-video cables.</p> <p>Note: If you connect the DVD player and the VCR to this receiver using the S-video terminals, change the video input terminal setting to "S/C" (see page 16).</p>
<p>CASE 2</p>	<p>When connecting the source equipment to the receiver using the composite video terminals, connect also this receiver to the TV's Video Input 2 terminal (composite video input) using composite video cables.</p> <p>Note: If you connect the DVD player and the VCR to this receiver using the composite video terminals, change the video input terminal setting to "S/C" (see page 16).</p>
<p>CASE 3</p>	<p>When connecting the source equipment to the receiver using the component video terminals, connect also this receiver to the TV's Video Input 2 terminals (component video input) using component video cables.</p> <p>Note: If you connect the DVD player and the VCR to this receiver using the component video terminals, change the video input terminal setting to "COMPONENT" (see page 16).</p>

1. **If you have already plugged your VCR, DVD player, TV and this receiver into the AC outlets, unplug their AC power cords first.**
2. **Connect your VCR, DVD player, TV and this receiver as follows, using the cables with the monaural mini-plugs (not supplied).**
 - See "CONNECTIONS 1" on the previous page.
3. **Connect the audio input/output jacks on VCR, DVD player, TV and this receiver, using the cables with RCA pin plugs.**
 - See pages 7 and 8.
4. **Connect the video input/output jacks on VCR, DVD player, TV and this receiver, using the cables with RCA pin plugs, with S-video plug or with component video plugs.**
 - See "CONNECTIONS 2" on the previous page.
5. **Plug the AC power cords of the components into the AC outlets.**
6. **When turning on the TV for the first time after the AV COMPU LINK connection, turn the TV volume to the minimum using the TV volume control on the TV.**
7. **Turn on the other connected components first, then turn on this receiver.**
 - When turning on the VCR, use the remote control supplied with this receiver (press STANDBY/ON  VCR).

The AV COMPU LINK remote control system allows you to use the five basic functions listed below.

Remote Control of the TV, DVD player, and VCR Using This Remote Control

See page 36 for details.

- Aim the remote control directly at the remote sensor on each target component.

One-Touch Video Play

Simply by inserting a video cassette without its safety tab into the VCR, you can enjoy the video playback without setting other switches manually. The receiver automatically turns on and changes the source to "VCR."

The TV automatically turns on and changes the input mode to the appropriate position so that you can view the playback picture. When you insert a video cassette with its safety tab, press the play () button on the VCR or on the remote control. So, you can get the same result.

One-Touch DVD Play

Simply by starting playback on the DVD player, you can enjoy the DVD playback without setting other switches manually.

- When the DVD player is connected through the analog input jacks on this receiver (and analog input is selected), the receiver automatically turns on and changes the source to "DVD" or "DVD MULTI."
- When the DVD player is connected through the digital input terminal on this receiver (and digital input is selected), the receiver automatically turns on and changes the source to "DVD DIGITAL."

The TV automatically turns on and changes the input mode to the appropriate position so that you can view the playback picture.

Automatic Selection of TV's Input Mode

- When you select "TV" as the source to play on the receiver, the TV automatically changes the input mode to the TV tuner so that you can watch TV.
- When you select "DVD," "DVD MULTI," or "VCR" as the source to play on the receiver, the TV automatically changes the input mode to the appropriate position (either Video Input 1 or Video Input 2) so that you can view the playback picture.

Note:

When connecting a TV with the AV COMPU LINK EX or AV COMPU LINK III terminal to this receiver, you cannot use a component video cable (as in case 3 on page 32). Connect the TV using a S-video or composite video cable (as in cases 1 and 2).

Automatic Power On/Off

The TV, VCR, and DVD player turn on and off along with the receiver.

When you turn on the receiver;

- If the previously selected source is "VCR," the TV and VCR will turn on automatically.
- If the previously selected source is "TV SOUND," only the TV will turn on automatically.
- If the previously selected source is "DVD" or "DVD MULTI," the TV and DVD player will turn on automatically.

When you turn off the receiver, the TV, VCR and DVD player will turn off.

Note:

If you turn off the receiver while recording on the VCR, the VCR will not turn off, but continue recording.

Operating JVC's Audio/Video Components

You can use the remote control to operate other JVC's components.

Operating Audio Components

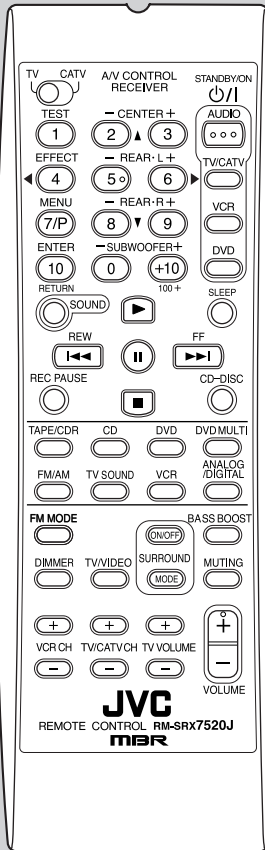

IMPORTANT:

To operate JVC's audio components using this remote control:

- You need to connect JVC's audio components through the COMPU LINK-4 (SYNCHRO) jacks (see page 31) in addition to the connections using cables with RCA pin plugs (see pages 6 and 7).
- Aim the remote control directly at the remote sensor on the receiver.
- If you use the buttons on the front panel, the remote control will not operate that source. To operate a source with the remote control, the source must be selected using source selecting buttons on the remote control.
- To operate the cassette deck or CD recorder using the COMPU LINK remote control system, set the source name correctly. (See page 11.)
- Refer also to the manuals supplied with your audio components.

Sound Adjustment

You can always use the following buttons:

SURROUND ON/OFF : Turn on or off the Surround modes.

SURROUND MODE : Select the Surround modes.

After pressing SOUND, you can use the following buttons for sound adjustment:

SUBWOOFER +/- : Adjust the subwoofer output level.

CENTER +/- : Adjust the center speaker output level.

REAR•L +/- : Adjust the left rear speaker output level.

REAR•R +/- : Adjust the right rear speaker output level.

EFFECT : Select the DAP effect level.

TEST : Turn on or off the test tone output.

Note:

After adjusting sounds, press the corresponding source selecting button or CD-DISC to operate your target source by using the 10 keys; otherwise, the 10 keys cannot be used for operating your target source.

Tuner

You can always use the following buttons:

FM/AM : Alternate between FM and AM.

FM MODE : Change the FM reception mode.

After pressing FM/AM, you can use the following buttons for tuner operations:

1 - 10, +10 : Select a preset channel number directly.

- For channel number 5, press 5.
- For channel number 15, press +10, then 5.
- For channel number 20, press +10, then 10.

CD player

After pressing CD, you can use the following buttons for CD operations:

▶ : Start playback.

◀◀ : Return to the beginning of the current (or previous) track.

▶▶ : Skip to the beginning of the next track.

■ : Stop playback.







|| : Pause playback. To release it, press ▶.

1 - 10, +10 : Select a track number directly.

- For track number 5, press 5.
- For track number 15, press +10, then 5.
- For track number 20, press +10, then 10.

CD changer

After pressing CD-DISC, you can use the following buttons for CD changer operations:



	: Start playback.
	: Return to the beginning of the current (or previous) track.
	: Skip to the beginning of the next track.
	: Stop playback.
	: Pause playback. To release it, press  .
1 – 6, 7/P	: Select the number of a disc installed in a CD changer.

If your CD changer is of 200-disc loading capability (except for XL-MC100 and XL-MC301),

you can do the following operations using the number buttons after pressing CD:





- 1** Select a disc number.
- 2** Then select a track number (always enter two digits).
- 3** Start playback.

Examples:

- Selecting disc number 3, track number 2, and starting playback.
Press 3, then, 0, 2, then .
- Selecting disc number 10, track number 5, and starting playback.
Press 1, 0, then, 0, 5, then .
- Selecting disc number 105, track number 12, and starting playback.
Press 1, 0, 5, then 1, 2, then .

Cassette deck

After pressing TAPE/CDR, you can use the following buttons for cassette deck operations:







	: Start playback.
FF	: Fast wind a tape from left to right.
REW	: Fast wind a tape from right to left.
	: Stop playback or recording.
	: Pause playback. To release it, press  .
REC PAUSE	: Press this button to enter recording pause. Press this button then  to start recording.

Note:

Before starting the above operations, make sure that you have changed the source name correctly. See page 11.

CD recorder

After pressing TAPE/CDR, you can use the following buttons for CD recorder operations:

	: Start playback.
	: Return to the beginning of the current (or previous) track.
	: Skip to the beginning of the next track.
	: Stop playback or recording.
	: Pause playback. To release it, press  .
REC PAUSE	: Press this button to enter recording pause. Press this button then  to start recording.

Note:

Before starting the above operations, make sure that you have changed the source name correctly. See page 11.

Operating JVC's Audio/Video Components

Operating Video Components

IMPORTANT:

To operate JVC's video components using this remote control:

- You need to connect JVC's video components through the AV COMPU LINK terminals (see page 32) in addition to the connections using cables with RCA pin plugs (see pages 7 and 8).
- Some JVC's VCRs can accept two types of the control signals—remote code "A" and "B." Before using this remote control, make sure that the remote control code of the VCR connected to the VCR jacks is set to code "A."
- When using the remote control:
 - For the DVD player and VCR operations, aim the remote control directly at the remote sensor on each component, not on the receiver.
 - For the TV having the AV COMPU LINK terminal, aim the remote control directly at the remote sensor on the TV.

VCR

You can always perform the following operations:

STANDBY/ON DVD

: Turn on or off a VCR.

VCR CH +/-

: Change the TV channels on the VCR.



After pressing VCR (source selecting button), you can use the following buttons for VCR operations:

 : Start playback.

FF : Fast wind a tape.

REW : Rewind a tape.

 : Stop playback or recording.

 : Pause playback. To release it, press .

REC PAUSE : Press this button to enter recording pause.
Press this button then  to start recording

DVD player

You can always perform the following operations:

STANDBY/ON DVD

: Turn on or off a DVD player.

After pressing DVD or DVD MULTI (source selecting button), you can use the following buttons for DVD operations:

 : Start playback.

 : Return to the beginning of the current (or previous) chapter.

 : Skip to the beginning of the next chapter.

 : Stop playback.

 : Pause playback. To release it, press .

DVD menu operations

After pressing DVD or DVD MULTI (source selecting button), you can use the following buttons for DVD menu operations:

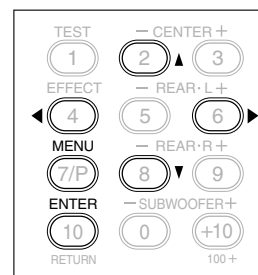

MENU : Display or erase the menu screen.

 : Select an item on the menu screen.

ENTER : Enter a selected item.

TV

Before operating, set TV/CATV selector to TV.

You can always perform the following operations:

STANDBY/ON TV/CATV

: Turn on or off a TV or a CATV converter.

TV/VIDEO : Change the input mode (TV tuner and video input).

TV VOLUME +/- : Adjust the volume.

TV/CATV CH +/- : Change the channels.

After pressing TV SOUND (source selecting button), you can use the following buttons for TV operations:

1 - 9, 0, +10 (100+) : Select a channel.

RETURN (10) : Function as the RETURN button.

By changing the transmittable signals, you can use the remote control supplied for this unit to operate other manufacturers' equipment.

- Refer also to the manuals supplied for the other products.
- To operate these components with the remote control, first you need to set the manufacturers' code each for TV, CATV converter, VCR and DVD player.
- After replacing batteries of the remote control, set the manufacturers' codes again.

To change the transmittable signals for operating a TV

- 1 Set TV/CATV selector to TV.
- 2 Press and hold STANDBY/ON \odot /TV/CATV.
- 3 Press TV SOUND.
- 4 Enter manufacturer's codes using buttons 1 – 9, and 0.
- 5 Release STANDBY/ON \odot /TV/CATV.

Now, you can perform the following operations on the TV.

STANDBY/ON \odot /TV/CATV	: Turn on or off the TV.
TV/VIDEO	: Set the input mode (either TV or VIDEO).
TV VOLUME +/-	: Adjust the volume.
TV/CATV CH +/-	: Change the channels.

After pressing TV SOUND (source selecting button), you can use the following buttons on the TV:

1 – 10, +10 (100+)	: Select a channel. +10 (100+) button will function as the ENTER button if your equipment requires pressing ENTER after selecting a channel number.
--------------------	---

Note:

Refer also to the manual supplied with your TV.

- 6 Try to operate your TV by pressing STANDBY/ON \odot /TV/CATV.

When your TV turns on or off, you have entered the correct code.

If there are more than one code listed for your brand of TV, try each one until the correct one is entered.

Manufacturers' codes for TV

Manufacturer	Codes
JVC	01*
Hitachi	10
Magnavox	02
Mitsubishi	03
Panasonic	04, 11
RCA	05
Samsung	12
Sanyo	13
Sharp	06
Sony	07
Toshiba	08
Zenith	09

* "01" is the initial setting.

To change the transmittable signals for operating a CATV converter

- 1 Set TV/CATV selector to CATV.
- 2 Press and hold STANDBY/ON \odot /TV/CATV.
- 3 Press TV SOUND.
- 4 Enter manufacturer's codes using buttons 1 – 9, and 0.
- 5 Release STANDBY/ON \odot /TV/CATV.

Now, you can perform the following operations on the CATV converter.

STANDBY/ON \odot /TV/CATV	: Turn on or off the CATV converter.
TV/CATV CH +/-	: Change the channels.

After pressing TV SOUND (source selecting button), you can use the following buttons on the CATV converter:

1 – 10, +10 (100+)	: Select a channel. +10 (100+) button will function as the ENTER button if your equipment requires pressing ENTER after selecting a channel number.
--------------------	---

Note:

Refer also to the manual supplied with your CATV converter.

Operating Other Manufacturers' Video Equipment

6 Try to operate your CATV converter by pressing STANDBY/ON \odot /TV/CATV.

When your CATV converter turns on or off, you have entered the correct code.

If there are more than one code listed for your brand of CATV converter, try each one until the correct one is entered.

Manufacturers' codes for CATV converter

Manufacturer	Codes
Echostar	01*
General Instrument	02, 03, 04, 05, 06, 07, 08, 09
Hamlin	16, 17, 18, 19
Pioneer	14, 15
RCA	20
Scient	10, 11
Sony	21
Zenith	12, 13

* "01" is the initial setting.

To change the transmittable signals for operating a VCR

1 Press and hold STANDBY/ON \odot /VCR.

2 Press VCR.

3 Enter manufacturer's codes using buttons 1 – 9, and 0.

4 Release STANDBY/ON \odot /VCR.

Now, you can perform the following operations on the VCR.

STANDBY/ON \odot /VCR : Turn on or off the VCR.

VCR CH +/- : Change the channels.

After pressing VCR (source selecting button), you can use the following buttons on the VCR:

▶ : Start playback.

FF : Fast-wind a tape.

REW : Rewind a tape.

■ : Stop playback or recording.

|| : Pause playback. To release it, press ▶.

REC PAUSE : Press this button to enter recording pause.
Press this button then press ▶ to start recording.

Note:

Refer also to the manual supplied with your VCR.

5 Try to operate your VCR by pressing STANDBY/ON \odot /VCR.

When your VCR turns on or off, you have entered the correct code.

If there are more than one code listed for your brand of VCR, try each one until the correct one is entered.

Manufacturers' codes for VCR

Manufacturer	Codes
JVC	01*, 02, 03
Emerson	10, 22
Gold Star	11
Hitachi	04
Mitsubishi	12
NEC	21
Panasonic	07, 13
Philips	09
RCA	05, 06
Samsung	20
Sanyo	17, 18, 19
Sony	14, 15, 16
Zenith	08

* "01" is the initial setting.







To change the transmittable signals for operating a DVD player

- 1** Press and hold STANDBY/ON \odot /I/DVD.
- 2** Press DVD.
- 3** Enter manufacturer's codes using buttons 1 – 9, and 0.
- 4** Release STANDBY/ON \odot /I/DVD.

Now, you can use the following buttons on the DVD player.

STANDBY/ON \odot /I/DVD : Turn on or off the DVD player.

After pressing DVD (source selecting button), you can use the following buttons on the DVD player:

	: Start playback.
	: Stop playback.
	: Return to the beginning of the current (or previous) chapter.
	: Skip to the beginning of the next chapter.
	: Pause playback. To release it, press  .

DVD menu operations

After pressing DVD (source selecting button), you can use the following buttons for DVD menu operations:

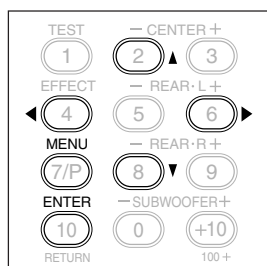

MENU : Display or erase the menu screen.

 : Select an item on the menu screen.

ENTER : Enter a selected item.

- 5** Try to operate your DVD player by pressing STANDBY/ON \odot /I/DVD.

When your DVD player turns on or off, you have entered the correct code.

If there are more than one code listed for your brand of DVD player, try each one until the correct one is entered.

Manufacturers' codes for DVD player

Manufacturer	Codes
JVC	01*
Panasonic	02
Philips	04
Pioneer	03
Sony	05
Toshiba	06
Yamaha	07

* "01" is the initial setting.

Manufacturers' codes are subject to change without notice. If they are changed, this remote control cannot operate the equipment.

Troubleshooting

Use this chart to help you solve daily operational problems. If there is any problem you cannot solve, contact your JVC's service center.

PROBLEM	POSSIBLE CAUSE	SOLUTION
The power does not come on.	The power cord is not plugged in.	Plug the power cord into an AC outlet.
No sound from speakers.	Speaker signal cables are not connected.	Check speaker wiring and reconnect if necessary.
	The SPEAKERS ON/OFF 1 and 2 buttons are not set correctly.	Press SPEAKERS ON/OFF 1 and 2 buttons correctly.
	An incorrect source is selected.	Select the correct source.
	Muting is activated.	Press MUTING to cancel the mute.
	An incorrect input mode (analog or digital) is selected.	Select the correct input mode (analog or digital).
Sound from one speaker only.	Connections are incorrect.	Check connections. For analog connections, see pages 6 – 8. For digital connections, see page 9.
	Speaker signal cables are not connected properly.	Check speaker wiring and reconnect if necessary.
Continuous hiss or buzzing during FM reception.	The balance is set to one extreme.	Adjust the balance properly (see page 19).
	Incoming signal is too weak.	Connect an outdoor FM antenna or contact your dealer.
	The station is too far away.	Select a new station.
Occasional cracking noise during FM reception.	An incorrect antenna is used.	Check with your dealer to be sure you have the correct antenna.
	Antennas are not connected properly.	Check connections.
Howling during record playing	Ignition noise from automobiles.	Move the antenna farther from automobile traffic.
Noise is heard.	Your turntable is too close to speakers.	Move speakers away from the turntable.
"OVERLOAD" starts flashing on the display.	An earth (⏏) cable is not connected to the AM (⏏) terminal on the rear panel.	Connect the cable to the AM (⏏) terminal on the rear panel.
	Speakers are overloaded because of high volume.	<ol style="list-style-type: none"> 1. Press STANDBY/ON ⏏ on the front panel to turn off the receiver. 2. Stop the playback source. 3. Turn on the receiver again, and adjust the volume.
"DSP MICOM NG" starts flashing on the display.	Speakers are overloaded because of short circuit of speaker terminals.	Press STANDBY/ON ⏏ on the front panel, then check the speaker wiring. If "OVERLOAD" does not disappear, unplug the AC power cord, then plug it back again. If speaker wiring is not short-circuited, contact your dealer.
	The built-in microcomputer is not functioning correctly.	Press STANDBY/ON ⏏ on the front panel to turn off the receiver. After unplugging the power cord, consult your dealer.
The STANDBY lamp lights up after turning on the power, but soon the receiver turns off (into standby mode).	The receiver is overloaded because of a high voltage.	Press STANDBY/ON ⏏ on the front panel to turn off the receiver. After unplugging the power cord, consult your dealer.
Remote control does not work.	There is an obstruction in front of the remote sensor on the receiver.	Remove the obstruction.
	Batteries are weak.	Replace batteries.
Remote control does not operate as you intend.	The remote control is not ready for your intended operation.	Press SOUND or source selecting buttons first, then press the button you want to use. (See pages 20, 27, 28, 34 – 39).

Amplifier

Output Power

At Stereo operation:

Front channels: **100 W per channel, min. RMS, driven into 8 Ω, 40 Hz to 20 kHz with no more than 0.8% total harmonic distortion.**

At Surround operation:

Front channels: 100 W per channel, min. RMS, driven into 8 Ω at 1 kHz, with no more than 0.8% total harmonic distortion.

Center channel: 100 W, min. RMS, driven into 8 Ω at 1 kHz, with no more than 0.8% total harmonic distortion.

Rear channels: 100 W per channel, min. RMS, driven into 8 Ω at 1 kHz, with no more than 0.8% total harmonic distortion.

Audio

Audio Input Sensitivity/Impedance (1 kHz):	CD, TAPE/CDR, VCR, TV SOUND, DVD:	220 mV/47 kΩ
Audio Input (DIGITAL IN)* :	Coaxial: DIGITAL 1 (DVD):	0.5 V (p-p)/75 Ω
	Optical: DIGITAL 2 (CD):	-21 dBm to -15 dBm (660 nm ±30 nm)
* Corresponding to Linear PCM, Dolby Digital, and DTS Digital Surround (with sampling frequency — 32 kHz, 44.1 kHz, 48 kHz).		
Audio Output Level:	TAPE/CDR, VCR:	220 mV
Signal-to-Noise Ratio ('66 IHF/'78 IHF):	CD, TAPE/CDR, VCR, TV SOUND, DVD:	87 dB/78 dB
Frequency Response (8 Ω):	CD, TAPE/CDR, VCR, TV SOUND, DVD:	20 Hz to 20 kHz (±1 dB)
Bass boost:		+3 dB ±1 dB at 100 Hz
Tone Control:	Bass (100 Hz):	±10 dB
	Treble (10 kHz):	±10 dB

Video

Video Input Sensitivity/Impedance:			
Composite video:	DVD, VCR:		1 V(p-p)/75 Ω
S-video:	DVD, VCR:	(Y: luminance):	1 V(p-p)/75 Ω
		(C: chrominance, burst):	0.286 V(p-p)/75 Ω
Component video:	DVD, VCR:	(Y: luminance):	1 V(p-p)/75 Ω
		(Pb/Cb, Pr/Cr):	0.7 V(p-p)/75 Ω
Video Output Level/Impedance:			
Composite video:	VCR, MONITOR OUT:		1 V(p-p)/75 Ω
		(Y: luminance):	1 V(p-p)/75 Ω
S-video:	VCR, MONITOR OUT:	(C: chrominance, burst):	0.286 V(p-p)/75 Ω
		(Y: luminance):	1 V(p-p)/75 Ω
Component video:	MONITOR OUT:	(Pb/Cb, Pr/Cr):	1 V(p-p)/75 Ω
Synchronization:	Negative		
Signal-to-Noise Ratio:	45 dB		

Specifications

FM tuner (IHF)

Tuning Range:	87.5 MHz to 108.0 MHz	
Usable Sensitivity:	Monaural:	12.8 dBf (1.2 μ V/75 Ω)
50 dB Quieting Sensitivity:	Monaural:	21.3 dBf (3.2 μ V/75 Ω)
	Stereo:	41.3 dBf (31.5 μ V/75 Ω)
Signal-to-Noise Ratio (IHF-A weighted):	Monaural:	78 dB at 85 dBf
	Stereo:	73 dB at 85 dBf
Total Harmonic Distortion:	Monaural:	0.4% at 1 kHz
	Stereo:	0.6% at 1 kHz
Stereo Separation at REC OUT:	35 dB at 1 kHz	
Alternate Channel Selectivity:	45 dB: (\pm 400 kHz)	
Frequency Response:	30 Hz to 15 kHz: (+0.5 dB, -3 dB)	

AM tuner

Tuning Range:	530 kHz to 1 710 kHz	
Usable Sensitivity:	Loop antenna:	400 μ V/m
Signal-to-Noise Ratio:	50 dB (100 mV/m)	

General

Power Requirements:	AC 120V \sim , 60 Hz	
Power Consumption:	180 W/230 VA (at operation)	
	2 W (in standby mode)	
Dimensions (W x H x D):	435 mm x 146.5 mm x 416 mm	
	(17 ³ / ₁₆ in. x 5 ¹³ / ₁₆ in. x 16 ⁷ / ₁₆ in.)	
Mass:	8.8 kg (19.5 lbs)	

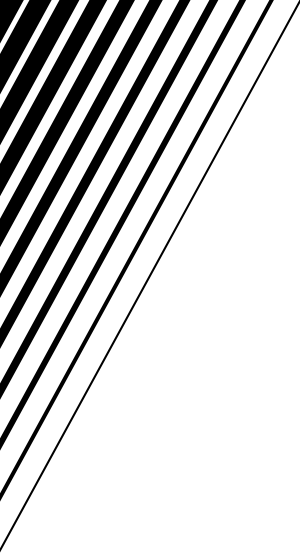

Free Manuals Download Website

<http://myh66.com>

<http://usermanuals.us>

<http://www.somanuals.com>

<http://www.4manuals.cc>

<http://www.manual-lib.com>

<http://www.404manual.com>

<http://www.luxmanual.com>

<http://aubethermostatmanual.com>

Golf course search by state

<http://golfingnear.com>

Email search by domain

<http://emailbydomain.com>

Auto manuals search

<http://auto.somanuals.com>

TV manuals search

<http://tv.somanuals.com>