

# JVC

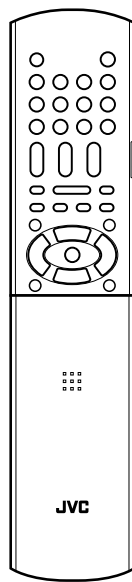

## AUDIO / VIDEO CONTROL RECEIVER

# RX-D211S / RX-D212B

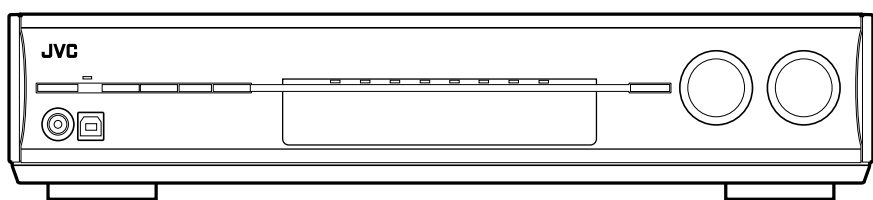

**AV COMPU LINK**

# INSTRUCTIONS

**For Customer Use:**

Enter below the Model No. and Serial No. which are located either on the rear, bottom or side of the cabinet. Retain this information for future reference.

Model No. \_\_\_\_\_

Serial No. \_\_\_\_\_

LVT1557-001A  
[J]

# Warnings, Cautions, and Others

## Mises en garde, précautions et indications diverses

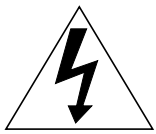

The lightning flash with arrowhead symbol, within an equilateral triangle is intended to alert the user to the presence of uninsulated "dangerous voltage" within the product's enclosure that may be of sufficient magnitude to constitute a risk of electric shock to persons.



The exclamation point within an equilateral triangle is intended to alert the user to the presence of important operating and maintenance (servicing) instructions in the literature accompanying the appliance.

**WARNING: TO REDUCE THE RISK OF FIRE OR ELECTRIC SHOCK, DO NOT EXPOSE THIS APPLIANCE TO RAIN OR MOISTURE.**

### CAUTION

To reduce the risk of electrical shocks, fire, etc.:

1. Do not remove screws, covers or cabinet.
2. Do not expose this appliance to rain or moisture.

### ATTENTION

Afin d'éviter tout risque d'électrocution, d'incendie, etc.:

1. Ne pas enlever les vis ni les panneaux et ne pas ouvrir le coffret de l'appareil.
2. Ne pas exposer l'appareil à la pluie ni à l'humidité.

### Caution— STANDBY/ON button!

Disconnect the mains plug to shut the power off completely (the standby lamp goes off). When installing the apparatus, ensure that the plug is easily accessible. The  STANDBY/ON button in any position does not disconnect the mains line.

- When the unit is on standby, the standby lamp lights red.
- When the unit is turned on, the standby lamp goes off.

The power can be remote controlled.

### Attention—Touche STANDBY/ON!

Déconnectez la fiche secteur pour mettre l'appareil complètement hors tension (le témoin d'attente s'éteint). Lors de l'installation de l'appareil, assurez-vous que la fiche soit facilement accessible. La touche  STANDBY/ON dans n'importe quelle position ne déconnecte pas l'appareil du secteur.

- Quand l'appareil est en mode d'attente, le témoin d'attente s'allume en rouge.
- Quand l'appareil est sous tension, le témoin d'attente s'éteint.

L'alimentation ne peut pas être commandée à distance.

### Note to CATV system installer:

This reminder is provided to call the CATV system installer's attention to Section 820-40 of the NEC which provides guidelines for proper grounding and, in particular, specifies that the cable ground shall be connected to the grounding system of the building, as close to the point of cable entry as practical.

### CAUTION

Changes or modifications not approved by JVC could void the user's authority to operate the equipment.

### ATTENTION

Des changements ou modifications non approuvés par JVC pourront invalider l'autorité de l'utilisateur à opérer cet appareil.

### For U.S.A

This equipment has been tested and found to comply with the limits for a Class B digital device, pursuant to part 15 of the FCC Rules. These limits are designed to provide reasonable protection against harmful interference in a residential installation.

This equipment generates, uses and can radiate radio frequency energy and, if not installed and used in accordance with the instructions, may cause harmful interference to radio communications. However, there is no guarantee that interference will not occur in a particular installation. If this equipment does cause harmful interference to radio or television reception, which can be determined by turning the equipment off and on, the user is encouraged to try to correct the interference by one or more of the following measures:

Reorient or relocate the receiving antenna.

Increase the separation between the equipment and receiver.

Connect the equipment into an outlet on a circuit different from that to which the receiver is connected.

Consult the dealer or an experienced radio/TV technician for help.

### Declaration of Conformity:

Trade Name: JVC

Model Number: RX-D211S/RX-D212B

Responsible Party: JVC Americas Corp.

Address: 1700 Valley Road, Wayne New Jersey 07470

Telephone Number: 973-317-5000

This device complies with Part 15 of the FCC Rules. Operation is subject to the following two conditions:

- (1) This device may not cause harmful interference.
- (2) This device must accept any interference received, including interference that may cause undesired operation.

### For Canada/pour Le Canada

THIS DIGITAL APPARATUS DOES NOT EXCEED THE CLASS B LIMITS FOR RADIO NOISE EMISSIONS FROM DIGITAL APPARATUS AS SET OUT IN THE INTERFERENCE-CAUSING EQUIPMENT STANDARD ENTITLED "DIGITAL APPARATUS," ICES-003 OF THE DEPARTMENT OF COMMUNICATIONS.

CET APPAREIL NUMERIQUE RESPECTE LES LIMITES DE BRUITS RADIOELECTRIQUES APPLICABLES AUX APPAREILS NUMERIQUES DE CLASSE B PRESCRITES DANS LA NORME SUR LE MATERIEL BROUILLEUR; "APPAREILS NUMERIQUES", NMB-003 EDICTEE PAR LE MINISTRE DES COMMUNICATIONS.

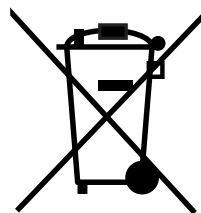

[European Union Only]

[Union européenne seulement]

# Table of Contents

---

<b>Parts identification .....</b>	<b>2</b>
<b>Getting started .....</b>	<b>4</b>
Before Installation .....	4
Checking the supplied accessories .....	4
Putting batteries in the remote control .....	4
Connecting antennas .....	5
Connecting the speakers .....	6
Connecting audio/video components .....	7
Connecting the power cord .....	10
USB connection .....	11
<b>Basic operations .....</b>	<b>12</b>
1 Turn on the power .....	12
2 Select the source to play .....	12
3 Adjust the volume .....	13
Turning off the sounds temporarily .....	14
Changing the display brightness .....	14
Turning off the power with the Sleep Timer .....	14
<b>FM/AM tuner operations .....</b>	<b>15</b>
Tuning in to FM/AM stations manually .....	15
Using preset tuning .....	15
Selecting the FM reception mode .....	16
<b>XM Satellite Radio operations .....</b>	<b>17</b>
Preparation .....	17
Listening to XM Satellite Radio .....	18
Using preset tuning .....	19
Changing the channel information .....	19
<b>Basic settings .....</b>	<b>20</b>
Setting the speaker information easily	
—Quick Speaker Setup .....	20
Basic setting items .....	21
Operating procedure .....	22
Setting the speakers .....	22
Activating the EX/ES/PLIIX setting—EX/ES/PLIIX .....	23
Selecting the main or sub channel—DUAL MONO .....	24
Setting bass sound .....	24
Using the Midnight mode—MIDNIGHT MODE .....	24
Setting the digital input (DIGITAL IN) terminals	
—DIGITAL IN 1/2/3 .....	25
Selecting the component video input mode	
—DVD VIDEO IN/VCR VIDEO IN/DBS VIDEO IN .....	25
<b>Sound adjustments .....</b>	<b>26</b>
Basic adjustment items .....	26
Operating procedure .....	26
Adjusting the speaker output levels .....	27
Adjusting the equalization patterns	
—D EQ 63Hz/250Hz/1kHz/4kHz/16kHz .....	27
Adjusting the bass sounds .....	28
Adjusting the sound parameters for the	
Surround/DSP modes .....	28
<b>Creating realistic sound fields .....</b>	<b>30</b>
Reproducing theater ambience .....	30
Introducing the Surround modes .....	30
Introducing the DSP modes .....	32
Using the Surround/DSP modes .....	33
Activating the Surround/DSP modes .....	34
<b>AV COMPU LINK remote control system .....</b>	<b>35</b>
<b>Operating other JVC products .....</b>	<b>37</b>
<b>Operating other manufacturers' products .....</b>	<b>39</b>
<b>Troubleshooting .....</b>	<b>42</b>
<b>Specifications .....</b>	<b>43</b>

# Parts identification

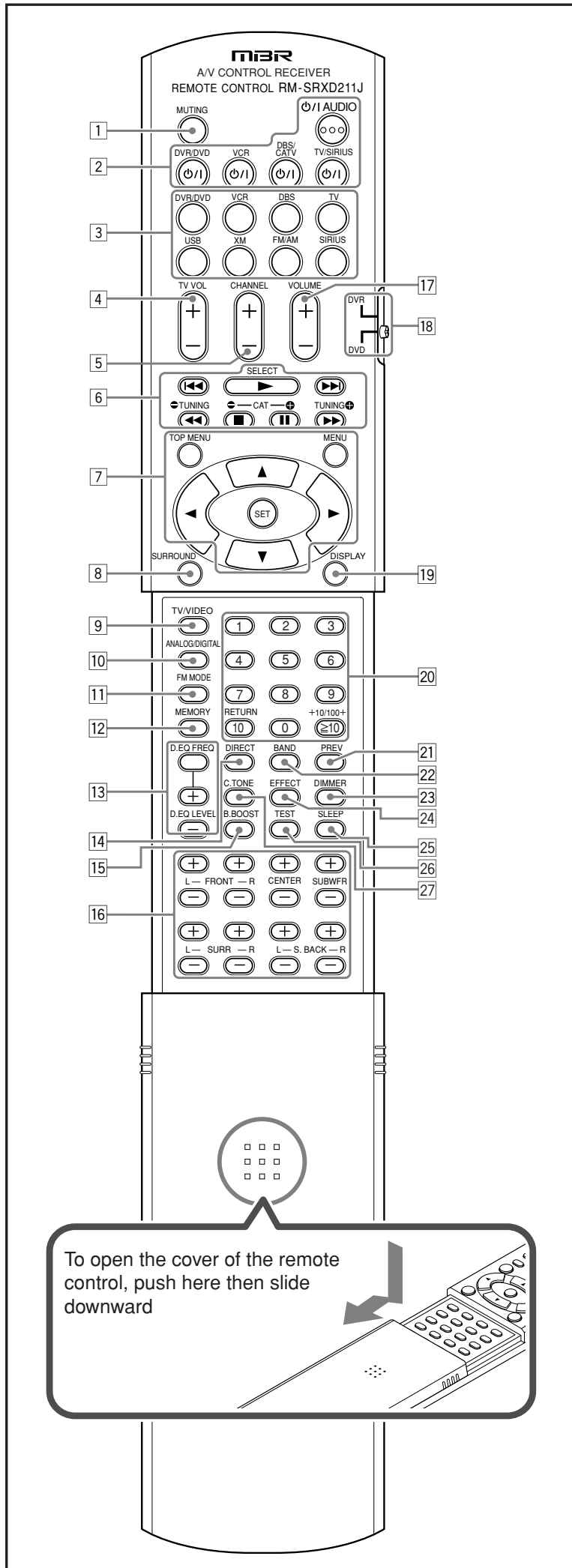

## Remote control

See pages in parentheses for details.

- 1 MUTING button (14)
- 2 Standby/on buttons (12, 37 – 41)  
⏻/I AUDIO, DVR/DVD ⏻/I, VCR ⏻/I, DBS/CATV ⏻/I, TV/SIRIUS ⏻/I
- 3 Source selecting buttons (12, 16, 17, 34, 37 – 41)  
DVR/DVD, VCR, DBS, TV, USB, XM, FM/AM, SIRIUS
- 4 TV VOL (volume) +/- button (37, 39)
- 5 CHANNEL +/- button (37 – 41)
- 6
  - Operating buttons for video components (37, 38, 40, 41)  
◀◀, ▶▶, ▶▶▶, ◀◀◀, ■, II, ▶▶▶
  - Operating buttons for FM/AM tuner (15)  
⊖ TUNING, TUNING ⊕
  - Operating buttons for XM Satellite Radio or SIRIUS Satellite Radio (18, 37)  
SELECT\*, ⊖ CAT, CAT ⊕
- 7 Operating buttons for DVD recorder or DVD player\*\* (38, 41)  
TOP MENU, MENU, cursor buttons (▶, ◀, ▲, ▼), SET
- 8 SURROUND button (34)
- 9 TV/VIDEO button (37, 39)
- 10 ANALOG/DIGITAL button (13)
- 11 FM MODE button (16)
- 12 MEMORY button (15, 19)
- 13 Adjusting buttons for Digital Equalizer (27)  
D.EQ FREQ, D.EQ LEVEL +/-
- 14 DIRECT button (18)
- 15 B (bass). BOOST button (28)
- 16 Adjusting buttons for speaker and subwoofer output levels (27)  
FRONT L +/-, FRONT R +/-, CENTER +/-, SUBWFR +/-,  
SURR L +/-, SURR R +/-, S.BACK L +/-, S.BACK R +/-
- 17 VOLUME +/- button (13)
- 18 DVR/DVD mode selector (38, 41)
- 19 DISPLAY button (19, 37)
- 20
  - Numeric buttons (16, 18, 19, 37 – 41)  
1 – 10, 0, ≥10, +10/100+
  - RETURN button (37)
- 21 PREV\* button (37)
- 22 BAND\* button (37)
- 23 DIMMER button (14)
- 24 EFFECT button (28)
- 25 SLEEP button (14)
- 26 TEST button (27)
- 27 C (center).TONE button (29)

\* For SIRIUS Satellite Radio only

\*\* These buttons can be used for operating a DVD recorder (JVC product ONLY) or DVD player with the mode selector set to "DVR" or "DVD" (see page 38).

If these buttons do not function normally, use the remote control supplied with your DVD recorder or DVD player. Refer also to the manuals supplied with the DVD recorder or DVD player for details.

- When operating a DVD recorder (for JVC products ONLY), set the mode selector (18) to "DVR."
- When operating a DVD player, set the mode selector (18) to "DVD."

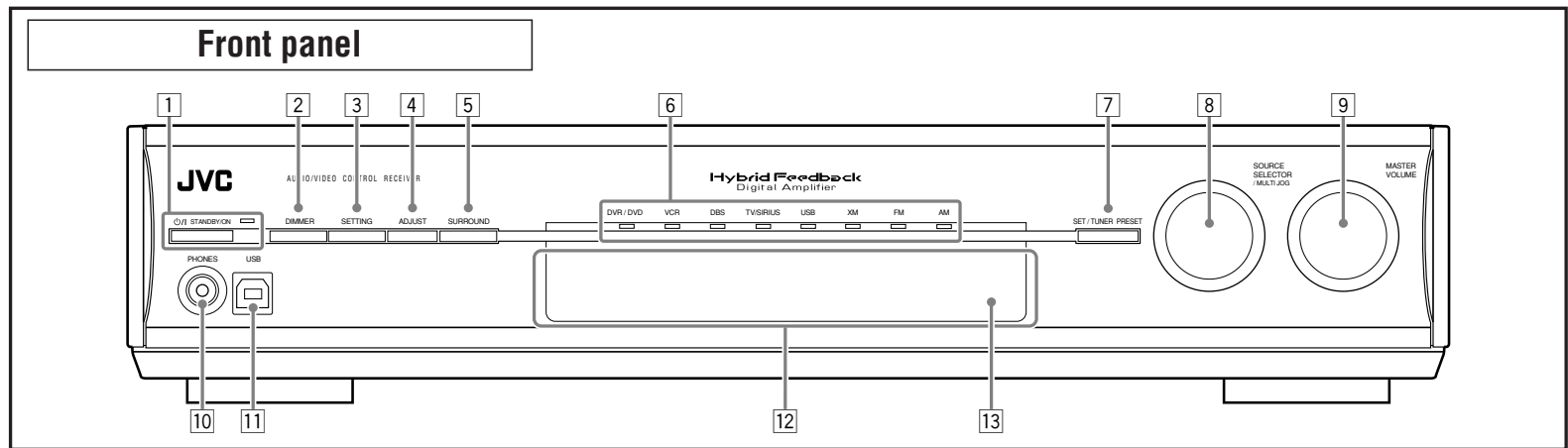

- 1  $\mathcal{O}$ /I STANDBY/ON button and standby lamp (12)
- 2 DIMMER button (14)
- 3 SETTING button (20, 22)
- 4 ADJUST button (26)
- 5 SURROUND button (34)
- 6 Source lamps  
DVR/DVD, VCR, DBS, TV/SIRIUS, USB, XM, FM, AM
- 7 • SET button (20, 22, 26)  
• TUNER PRESET button (16, 19)
- 8 • SOURCE SELECTOR (12, 16, 17)  
• MULTI JOG (16, 19, 20, 22, 26, 34)
- 9 MASTER VOLUME control (13)
- 10 PHONES jack (13)
- 11 USB terminal (11)
- 12 Display window (see below)
- 13 Remote sensor (4)

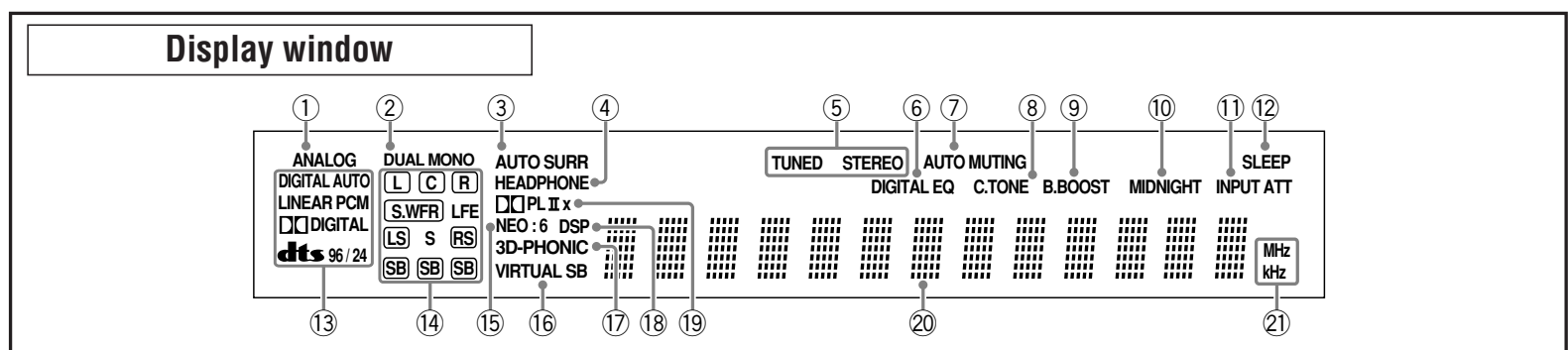

- 1 ANALOG indicator (13)
- 2 DUAL MONO indicator (24)
- 3 AUTO SURR (surround) indicator (34)
- 4 HEADPHONE indicator (13, 31)
- 5 FM/AM tuner operation indicators (15)  
TUNED, STEREO
- 6 DIGITAL EQ indicator (27)
- 7 AUTO MUTING indicator (16)
- 8 C.TONE indicator (29)
- 9 B (bass).BOOST indicator (28)
- 10 MIDNIGHT indicator (24)
- 11 INPUT ATT (attenuate) indicator (28)
- 12 SLEEP indicator (14)
- 13 Digital signal format indicators (13, 30, 31)  
DIGITAL AUTO, LINEAR PCM,  $\square\square$ DIGITAL, **dts**, 96/24
- 14 Signal and speaker indicators (14)
- 15 NEO:6 indicator (31)
- 16 VIRTUAL SB indicator (33)
- 17 3D-PHONIC indicator (31, 32)
- 18 DSP indicator (31, 32)
- 19  $\square\square$  PL II and  $\square\square$  PL IIx indicator (30 – 32)
- 20 Main display
- 21 Frequency unit indicators  
MHz (for FM stations), kHz (for AM stations)

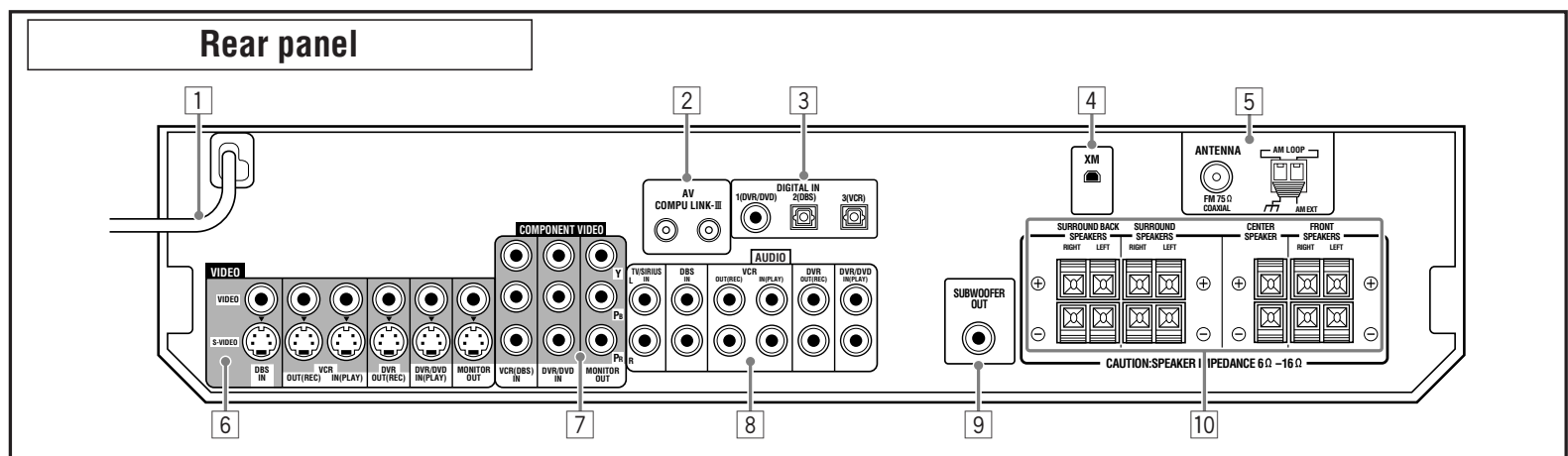

- 1 Power cord (10)
- 2 AV COMPU LINK-III terminals (35)
- 3 DIGITAL IN terminals (10)  
• Coaxial: 1(DVR/DVD)  
• Optical: 2(DBS)  
• Optical: 3(VCR)
- 4 XM jack (5)
- 5 FM/AM ANTENNA terminals (5)
- 6 VIDEO jacks (7– 9)  
VIDEO (composite video) jacks, S-VIDEO jacks  
• Input: DBS IN, VCR IN (PLAY), DVR/DVD IN (PLAY)  
• Output: VCR OUT (REC), DVR OUT (REC), MONITOR OUT
- 7 COMPONENT VIDEO (Y, Pb, Pr) jacks (7– 9)  
VCR (DBS) IN, DVR/DVD IN, MONITOR OUT
- 8 AUDIO jacks (7 – 9)  
• Input: TV/SIRIUS IN, DBS IN, VCR IN (PLAY),  
DVR/DVD IN (PLAY)  
• Output: VCR OUT (REC), DVR OUT (REC)
- 9 SUBWOOFER OUT jack (6)
- 10 Speakers terminals (6)  
SURROUND BACK SPEAKERS, SURROUND SPEAKERS,  
CENTER SPEAKER, FRONT SPEAKERS



# Getting started

## Before Installation

### General precautions

- Be sure your hands are dry.
- Turn the power off to all components.
- Read the manuals supplied with the components you are going to connect.

### Locations

- Install the receiver in a location that is level and protected from moisture and dust.
- The temperature around the receiver must be between  $-5^{\circ}\text{C}$  and  $35^{\circ}\text{C}$  ( $23^{\circ}\text{F}$  and  $95^{\circ}\text{F}$ ).
- Make sure there is good ventilation around the receiver. Poor ventilation could cause overheating and damage the receiver.
- Leave sufficient distance between the receiver and the TV.

### Handling the receiver

- Do not insert any metal object into the receiver.
- Do not disassemble the receiver or remove screws, covers, or cabinet.
- Do not expose the receiver to rain or moisture.
- Do not pull on the power cord to unplug the cord. When unplugging the cord, always grasp the plug so as not to damage the cord.
- When you are away on travel or otherwise for an extended period or time, remove the plug from the wall outlet. A small amount of power is always consumed while the power cord is connected to the wall outlet.

**The receiver has a built-in cooling fan which operates while the receiver is turned on. Be sure to leave enough ventilation to obtain sufficient cooling effect.**

### CAUTION:

Do not connect the AC power plug to the wall outlet until all connections are completed.

## Checking the supplied accessories

Check to be sure you have all of the following supplied accessories. If anything is missing, contact your dealer immediately.

- Remote control (× 1)
- Batteries (× 2)
- AM loop antenna (× 1)
- FM antenna (× 1)

## Putting batteries in the remote control

Before using the remote control, put two supplied batteries first.

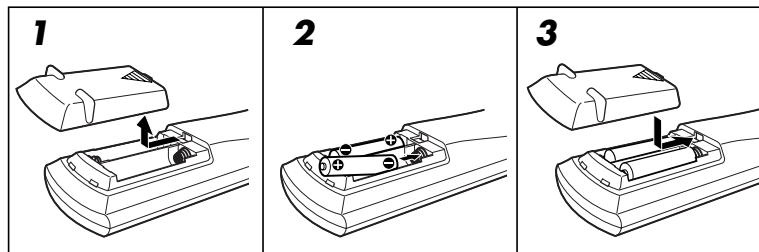

**1 Press and slide the battery cover on the back of the remote control.**

**2 Insert batteries.**

Make sure to match the polarity: (+) to (+) and (-) to (-).

**3 Replace the cover.**

If the range or effectiveness of the remote control decreases, replace the batteries. Use two R6(SUM-3)/AA(15F) type dry-cell batteries.

- Supplied batteries are for initial setup. Replace for continued use.

### CAUTION:

Follow these precautions to avoid leaking or cracking cells:

- Place batteries in the remote control so they match the polarity: (+) to (+) and (-) to (-).
- Use the correct type of batteries. Batteries that look similar may differ in voltage.
- Always replace both batteries at the same time.
- Do not expose batteries to heat or flame.

When using the remote control, aim the remote control directly at the remote sensor on the front panel.

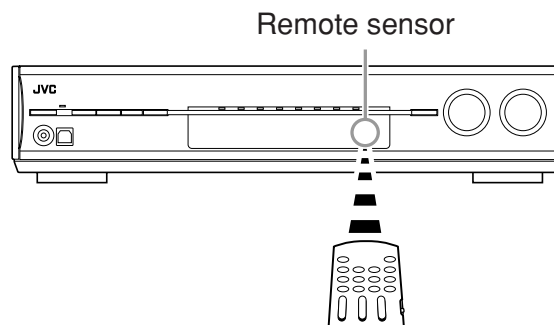

# Connecting antennas

**Do not connect the AC power plug to the wall outlet until all connections are completed.**

## ■ Connecting FM and AM antennas

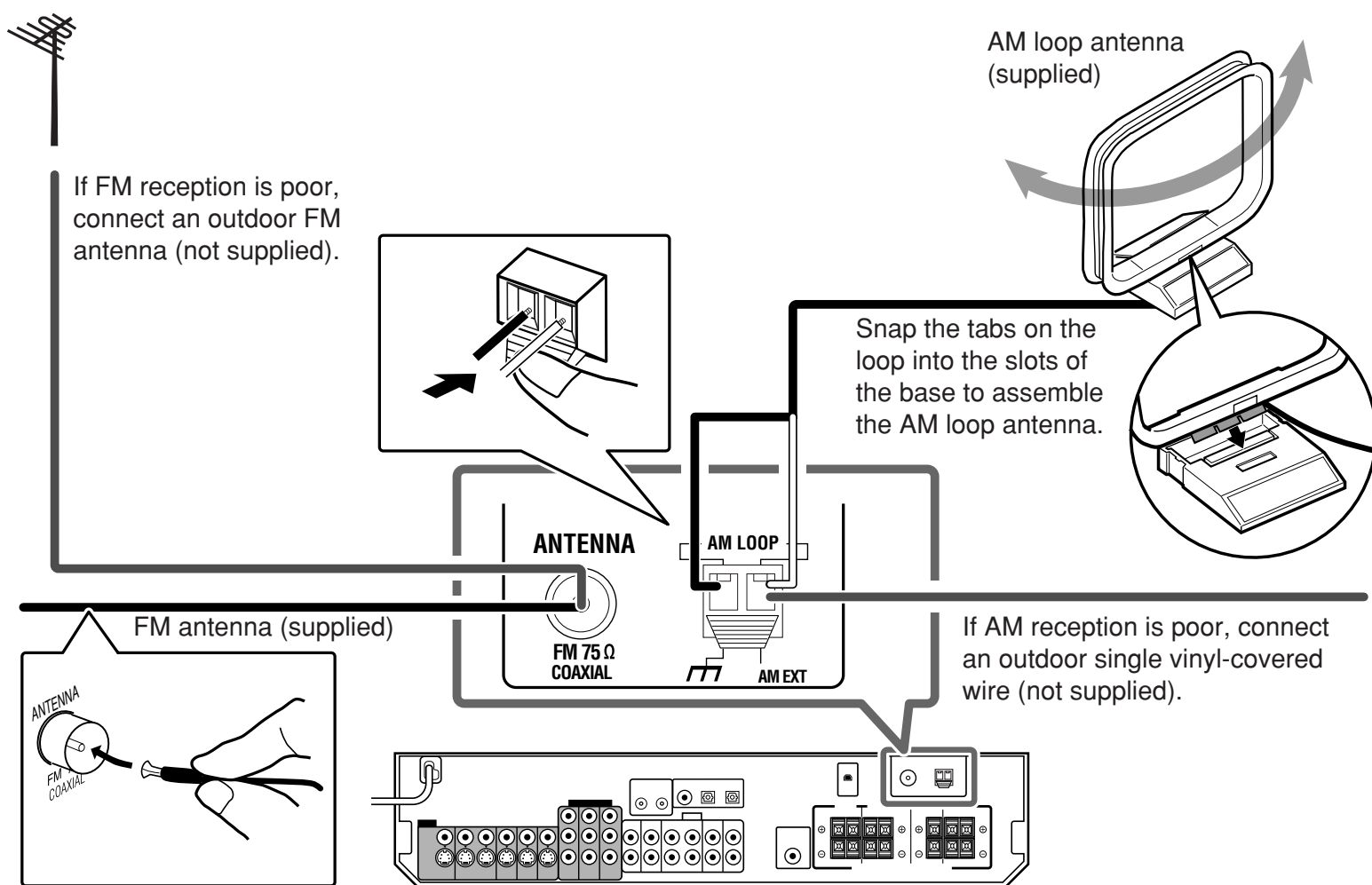

### AM antenna connection

Connect the AM loop antenna supplied to the AM LOOP terminals. Connect the white cord to the AM EXT terminal, and connect the black cord to the  $\mp$  terminal.

Turn the loop until you have the best reception.

- If the reception is poor, connect an outdoor single vinyl-covered wire (not supplied) to the AM EXT terminal. Keep the AM loop antenna connected.

### NOTES

- If the AM loop antenna wire is covered with vinyl, remove the vinyl while twisting it as shown on the right.
- Make sure the antenna conductors do not touch any other terminals, connecting cords and power cord. This could cause poor reception.

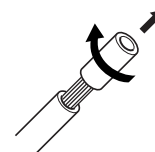

### FM antenna connection

Connect the FM antenna supplied to the FM 75 Ω COAXIAL terminal as a temporary measure.

Extend the supplied FM antenna horizontally.

- If the reception is poor, connect an outdoor FM antenna (not supplied). Before attaching a 75 Ω coaxial cable with a connector, disconnect the supplied FM antenna.

## ■ Connecting the XM Connect and Play Digital Antenna

To enjoy XM Satellite Radio, connect the XM Connect and Play Digital Antenna (not supplied) to the XM jack.

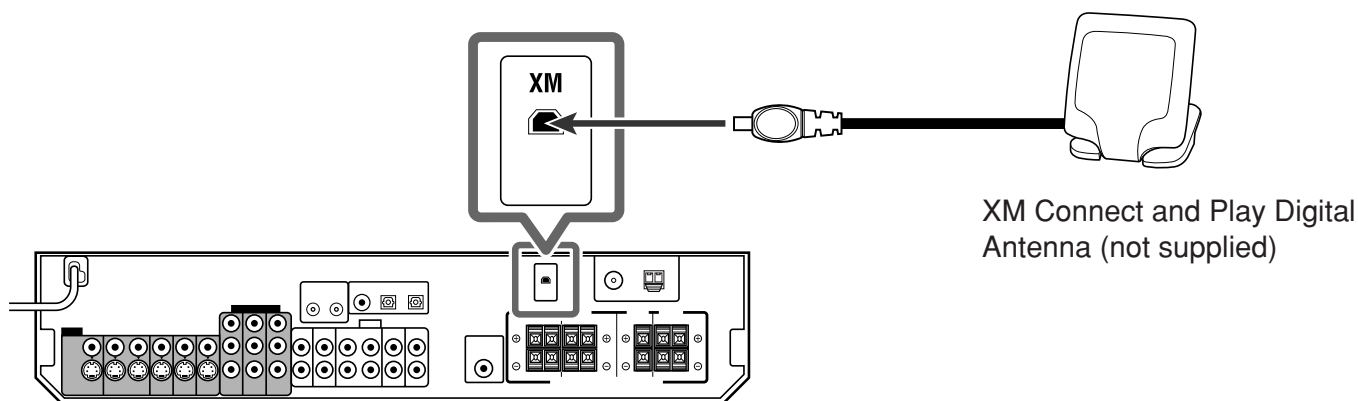

### NOTE

For the best reception:

- Place the XM Connect and Play Digital Antenna near a south-facing window or where “Channel 1” can be heard clearly (see page 17).
- Make sure there is no obstruction between the XM Connect and Play Digital Antenna and the sky.

# Connecting the speakers

*Do not connect the AC power plug to the wall outlet until all connections are completed.*

## Speaker Layout Diagram

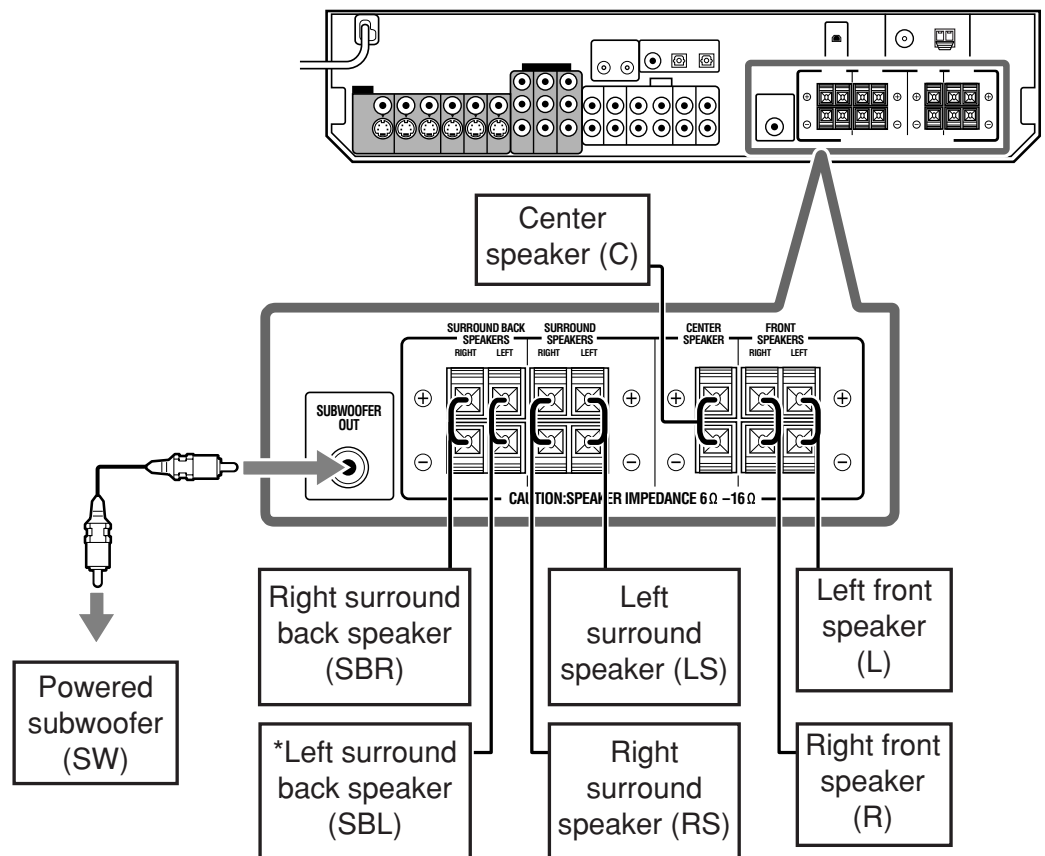
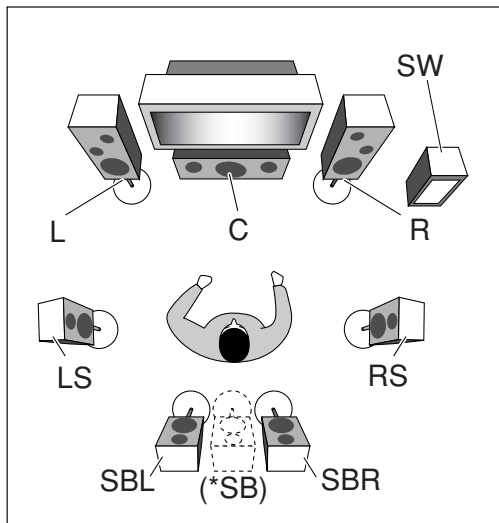

### CAUTIONS:

- Use speakers with the **SPEAKER IMPEDANCE** indicated by the speaker terminals ( $6\ \Omega - 16\ \Omega$ ).
- **DO NOT** connect more than one speaker to one speaker terminal.

## Connecting the speakers

Turn off all components before making connections.

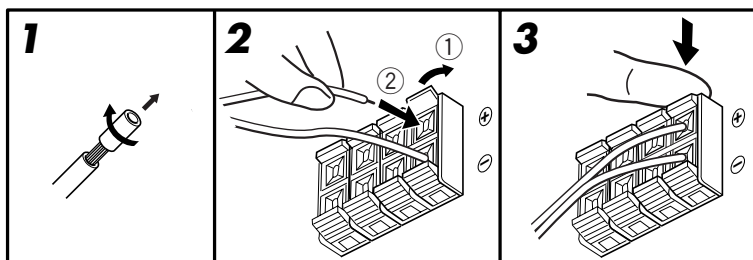

**1** Twist and remove the insulation at the end of each speaker cord.

**2** Open the terminal (1), then insert the speaker cord (2).

- For each speaker, connect the (+) and (-) terminals on the rear panel to the (+) and (-) terminals marked on the speakers.

**3** Close the terminal.

### \*When using a single speaker for the surround back speaker

You can enjoy the surround sound by one surround back speaker. When using one surround back speaker, – set “SB OUT” to “<1SPK>” (see page 22) and – connect the surround back speaker to the left surround back speaker terminal. **(No sound comes from the speaker if you connect it to the right surround back speaker terminal.)**

## Connecting the powered subwoofer

By connecting a subwoofer, you can enhance the bass or reproduce the original LFE signals recorded in digital software.

**Connect the input jack of a powered subwoofer to the SUBWOOFER OUT jack on the rear panel, using a cord with RCA pin plugs (not supplied).**

- Refer also to the manual supplied with your subwoofer.

After connecting all the speakers and/or a subwoofer, set the speaker setting information properly to obtain the best possible surround effect. For details, see pages 20 to 24.

### NOTE

You can place a subwoofer wherever you like since bass sound is non-directional. Normally place it in front of you.



# Connecting audio/video components

**Do not connect the AC power plug to the wall outlet until all connections are completed.**

This receiver is equipped with the following video terminals—composite video, S-video, and component video terminals.

- If your video components have S-video (Y/C-separation) and/or component video (Y, Pb, Pr) jacks, connect them using an S-video cable (not supplied) or component video cable (not supplied). By using these terminals, you can get better picture quality in the order:

Component > S-video > Composite

## IMPORTANT:

This receiver can convert video signals as follows:

- Composite video signals can be converted into both S-video signals and component signals.
- S-video signals can be converted into component signals.
- Component signals cannot be converted.

When converting video signals, there are some points to observe. For details, see “About video signal conversion” on page 10.

## Turn off all components before making connections.

- When you connect other components, refer also to their manuals.

**DO NOT use a TV through a VCR or a TV with a built-in VCR; otherwise, the picture may be distorted.**

## CAUTION:

If you connect a sound-enhancing device such as a graphic equalizer between the source components and this receiver, the sound output through this receiver may be distorted.

## If your video components have AV COMPU LINK terminal

See also page 35 for detailed information about the connection and the AV COMPU LINK remote control system.

## ■ Connecting a DVD recorder or DVD player

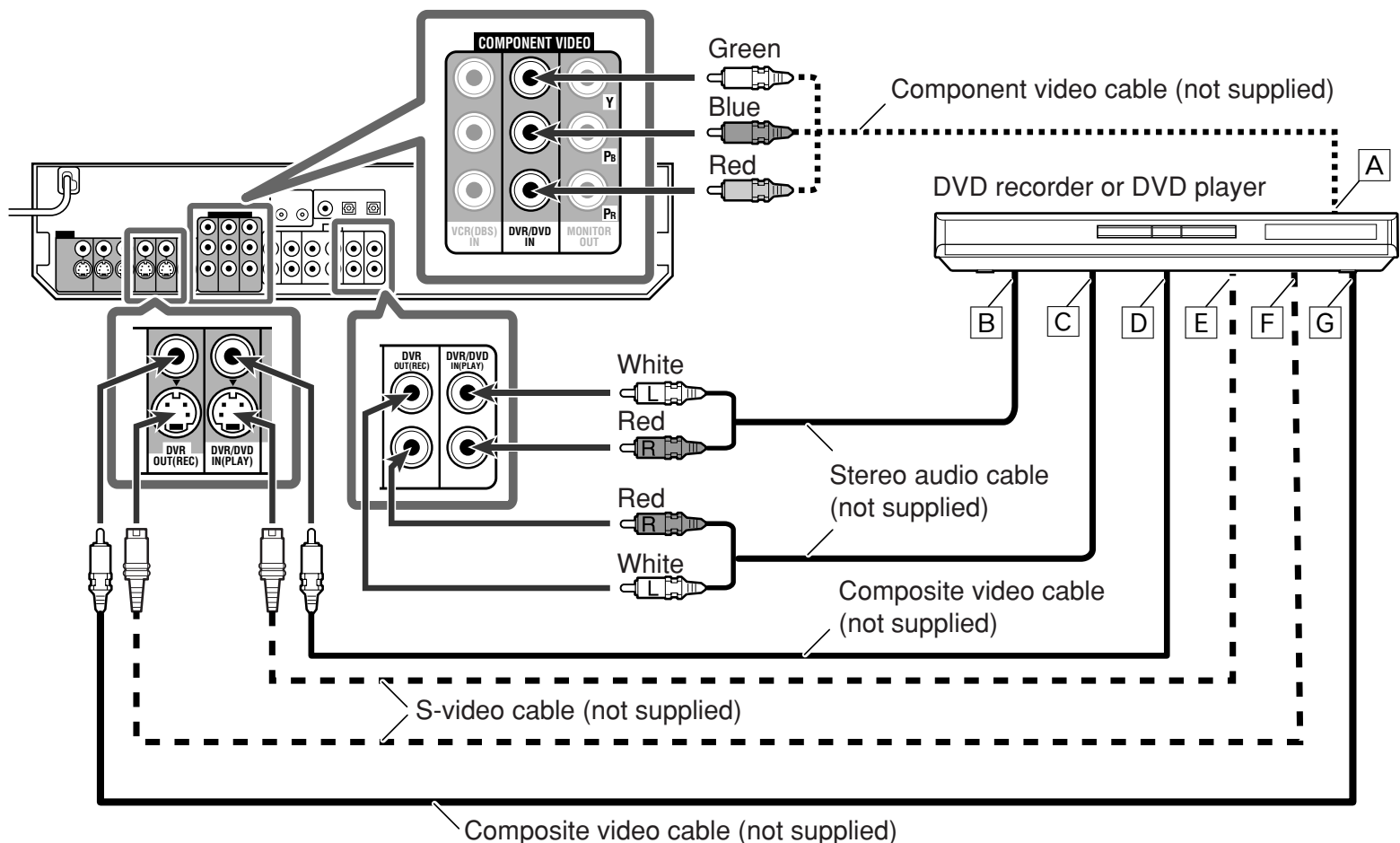

## NOTES

- When connecting a DVD recorder or DVD player to the component video input jacks, select the component video input mode (DVD VIDEO IN) correctly. If you do not, you cannot view the playback picture on the TV or the AV COMPU LINK remote control system cannot operate properly. See page 25 for details.
- When using a stereo audio cable as the illustration above, set the audio input mode to “ANALOG.” For details, see “Selecting the analog or digital input mode” on page 12.
- You can enjoy digital sound if using a digital coaxial or optical cable. When shipped from the factory, the digital input terminal setting for a DVD recorder and DVD player is set to use the digital coaxial terminal (DIGITAL IN 1 (DVR/DVD)). For details of digital connection, see page 10.

- Ⓐ To component video output
  - Connect Y, Pb, and Pr correctly.
- Ⓑ To left/right audio channel output
- Ⓒ **Only for DVD recorder:** To left/right audio channel input
- Ⓓ To composite video output
- Ⓔ To S-video output
- Ⓕ **Only for DVD recorder:** To S-video input
- Ⓖ **Only for DVD recorder:** To composite video input

**Do not connect the AC power plug to the wall outlet until all connections are completed.**

■ **Connecting a VCR**

**Turn off all components before making connections.**

- When you connect other components, refer also to their manuals.

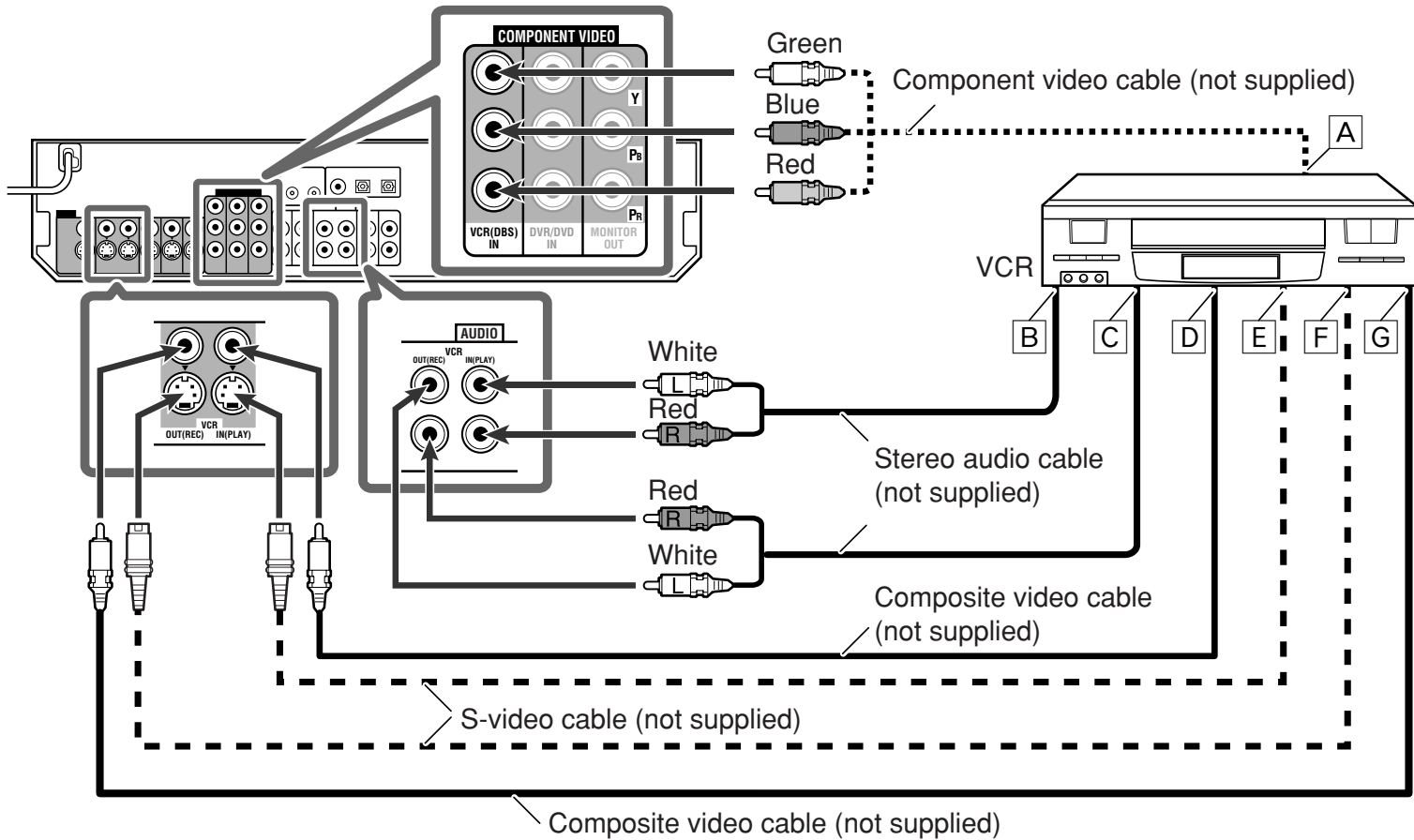

**NOTES**

- When connecting a VCR to the component video input jacks, select the component video input mode (VCR VIDEO IN) correctly. If you do not, you cannot view the playback picture on the TV or the AV COMPU LINK remote control system cannot operate properly. See page 25 for details.
- When using a stereo audio cable as the illustration above, set the audio input mode to "ANALOG." For details, see "Selecting the analog or digital input mode" on page 12.
- You can enjoy digital sound if using a digital coaxial or optical cable. When shipped from the factory, the digital input terminal setting for a VCR is set to use the digital optical terminal (DIGITAL IN 3 (VCR)). For details of digital connection, see page 10.

- A To component video output
  - Connect Y, Pb, and Pr correctly.
- B To left/right audio channel output
- C To left/right audio channel input
- D To composite video output
- E To S-video output
- F To S-video input
- G To composite video input

■ **Connecting a DBS tuner**

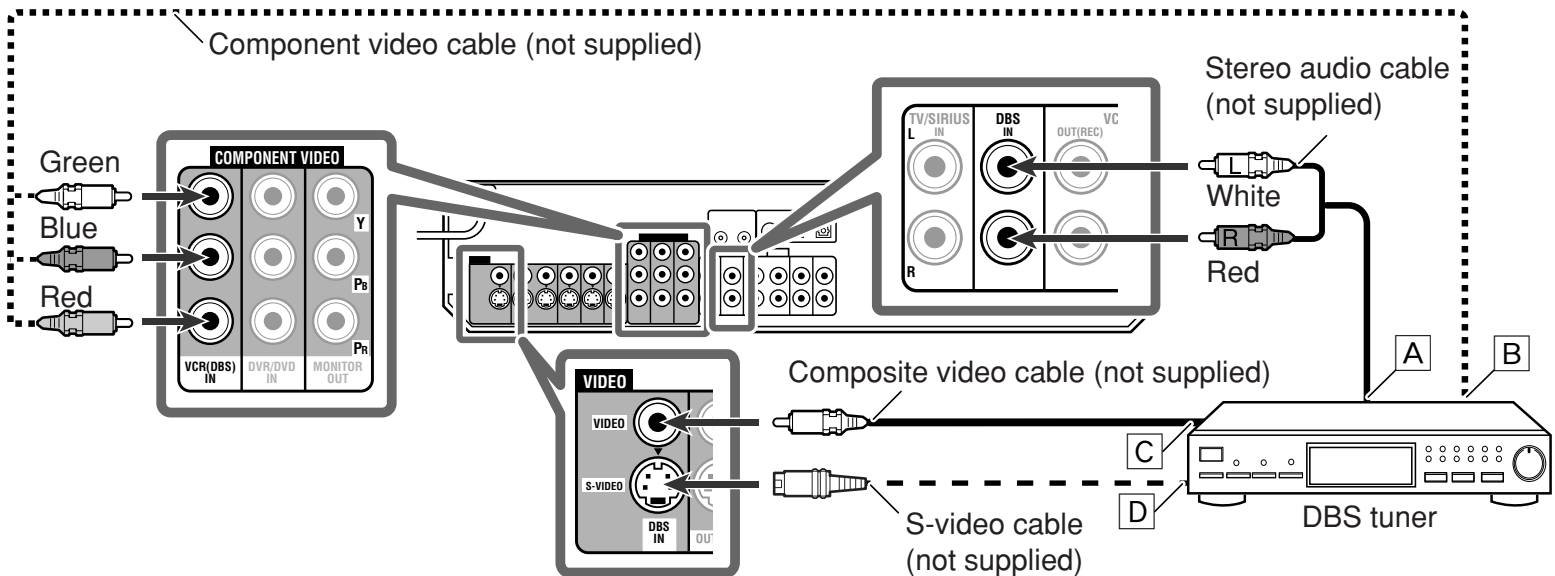

**NOTES**

- When connecting a DBS tuner to the component video input jacks, select the component video input mode (DBS VIDEO IN) correctly. If you do not, you cannot view the playback picture on the TV. See page 25 for details.
- When using a stereo audio cable as the illustration above, set the audio input mode to "ANALOG." For details, see "Selecting the analog or digital input mode" on page 12.
- You can enjoy digital sound if using a digital coaxial or optical cable. When shipped from the factory, the digital input terminal setting for a DBS tuner is set to use the digital optical terminal (DIGITAL IN 2 (DBS)). For details of digital connection, see page 10.

- A To left/right audio channel output
- B To component video output
  - Connect Y, Pb, and Pr correctly.
- C To composite video output
- D To S-video output

**Do not connect the AC power plug to the wall outlet until all connections are completed.**

### ■ Connecting a TV

Connect the TV to the appropriate MONITOR OUT jacks to view the playback picture from any other connected video components.

**Turn off all components before making connections.**

- When you connect other components, refer also to their manuals.

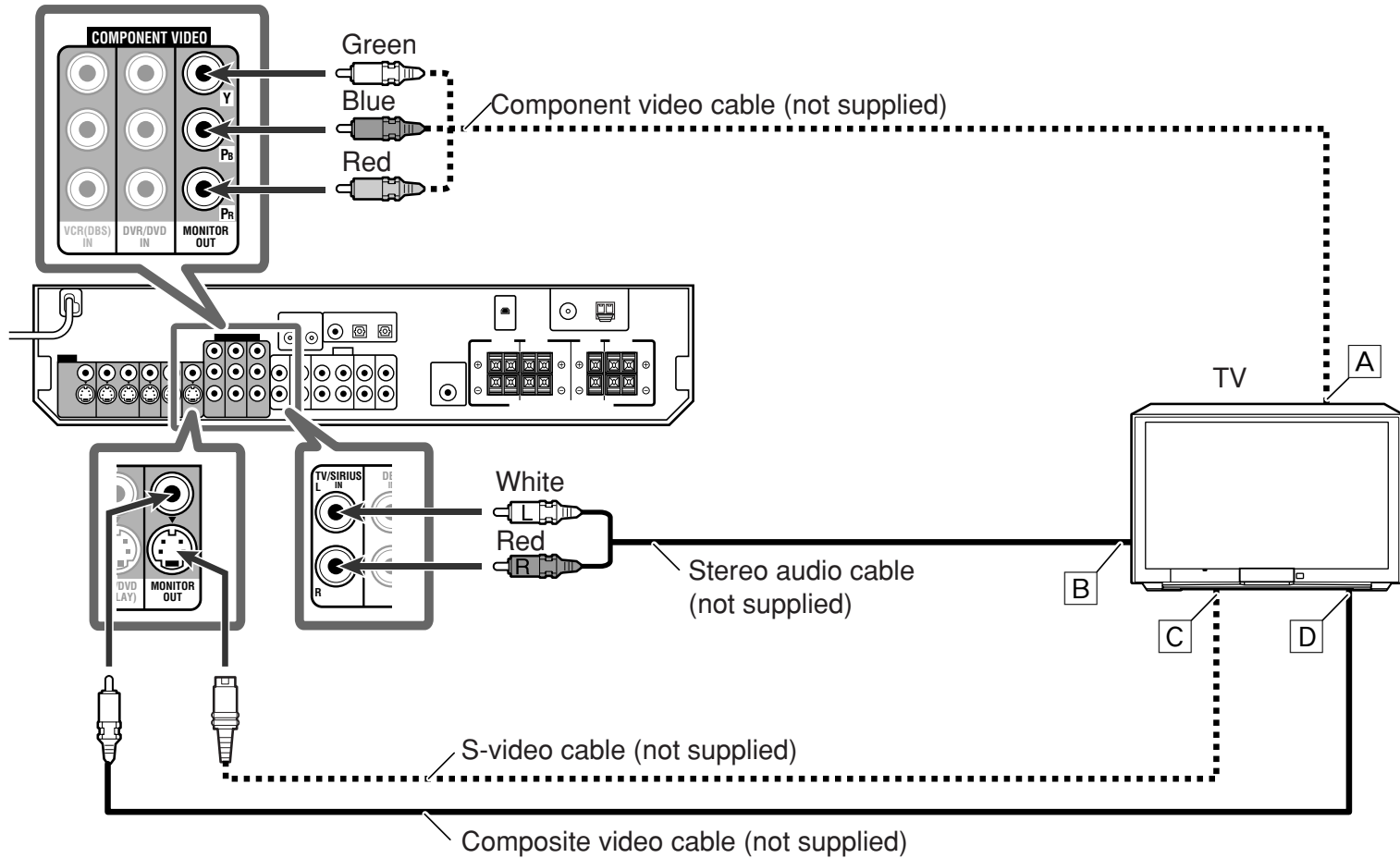

#### NOTES

- When using a stereo audio cable as the illustration above, set the audio input mode to "ANALOG." For details, see "Selecting the analog or digital input mode" on page 12.
- You can enjoy digital sound if using a digital coaxial or optical cable. For details of digital connection, see page 10.

- A** To component video input
  - Connect Y, Pb, and Pr correctly.
- B** To left/right audio channel output
- C** To S-video input
- D** To composite video input

### ■ Connecting a SIRIUS Satellite Radio

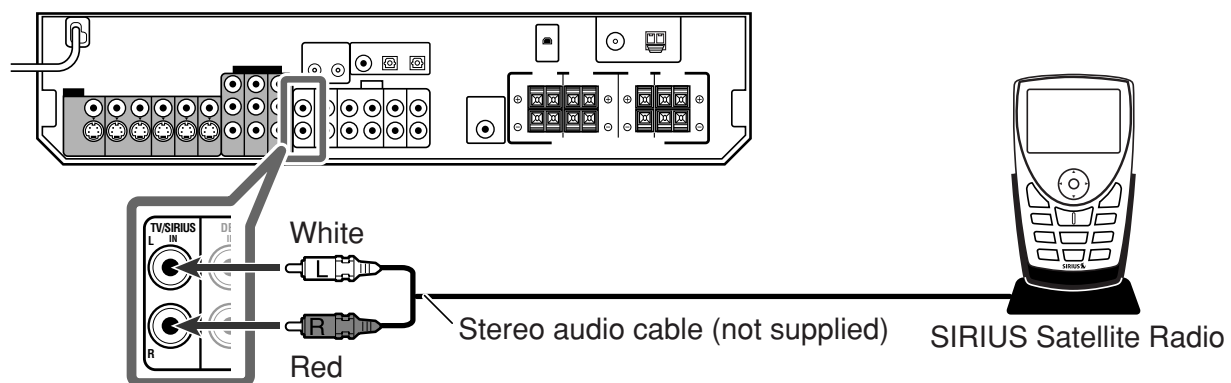

#### NOTES

- To connect KT-SR2000 (JVC SIRIUS Satellite Radio) to this receiver, it is required to separately purchase KS-K6013 Home Docking Kit.
- You cannot use a digital audio cable (coaxial or optical) to connect a SIRIUS Satellite Radio to this receiver.
- After connecting a SIRIUS Satellite Radio to the TV IN jacks, change the source name to "SIRIUS." See page 12 for details.

## About video signal conversion

This receiver can convert video signals. See the table below about video signal conversion.

Video Input	Converted	Video Output
Component	→	Component
S-video	→	S-video
Video (composite)	→	Video (composite)

To convert composite video and S-video signal into component video signal, set the "DVD VIDEO IN," "VCR VIDEO IN," or "DBS VIDEO IN" to "<S/C>" (see page 25).

- If using composite video cable for connecting to the video input and using S-video cable for connecting to the video output, the video signal is converted into S-video signal automatically. The signal is emitted through the S-video output jacks of MONITOR OUT, VCR OUT (REC), and DVR OUT (REC).
- Pictures may be distorted if the signals are converted. If this happens, connect the playback source component and TV using the cords of the same type.
- Incoming signal of component can be emitted only through the component output jacks.

## Digital connection

This receiver is equipped with three DIGITAL IN terminals—one digital coaxial terminal and two digital optical terminals. To reproduce the digital sound, use the digital connection in addition to the analog connection methods described on pages 7 to 9.

Digital coaxial cable (not supplied)



Digital optical cable (not supplied)



### Turn off all components before making connections.

- When you connect other components, refer also to their manuals.

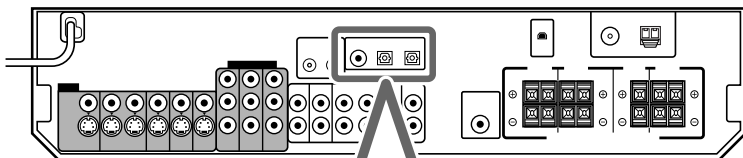

When the component has a digital coaxial output terminal, connect it to the 1(DVR/DVD) terminal, using a digital coaxial cable (not supplied).

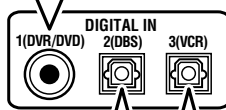

When the component has a digital optical output terminal, connect it to the 2(DBS) or 3(VCR) terminal, using a digital optical cable (not supplied).

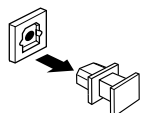

Before connecting a digital optical cable, unplug the protective plug.

## NOTES

- When shipped from the factory, the DIGITAL IN terminals have been set for use with the following components:
  - 1(DVR/DVD): For DVD recorder or DVD player
  - 2(DBS): For DBS tuner
  - 3(VCR): For VCR
 If you connect other components, change the digital input (DIGITAL IN) terminal setting correctly. See "Setting the digital input (DIGITAL IN) terminals—DIGITAL IN 1/2/3" on page 25.
- Select the correct digital input mode. See "Selecting the analog or digital input mode" on page 12.
- When you want to operate the connected component (except DBS tuner) using the AV COMPU LINK remote control system (see pages 35 and 36), connect them also as described on pages 7 to 9.

## Connecting the power cord

When all the audio/video connections have been made, connect the AC power plug to the wall outlet. Make sure that the plugs are inserted firmly. The standby lamp lights in red.

### CAUTIONS:

- Do not touch the power cord with wet hands.
- Do not alter, twist or pull the power cord, or put anything heavy on it, which may cause fire, electric shock, or other accidents.
- If the cord is damaged, consult a dealer and have the power cord replaced with a new one.

## NOTES

- Keep the power cord away from the connecting cables and the antenna. The power cord may cause noise or screen interference.
- The preset settings such as preset channels and sound adjustment may be erased in a few days in the following cases:
  - When you unplug the power cord.
  - When a power failure occurs.
- When you unplug the power cord with the receiver on and connect the power cord again, the receiver enters standby mode.



## USB connection

This receiver is equipped with a USB terminal. You can enjoy sound reproduced through your PC.

When you connect your PC for the first time, follow the procedure below.

- Remember you cannot send any signal or data to your PC from this receiver.

### IMPORTANT:

Check if your PC equipped with the CD-ROM drive is running on Windows® 98 SE\*, Windows® Me\*, Windows® 2000\* or Windows® XP\* and prepare its CD-ROM.

### Preparation

1. **Turn on your PC.**
  - If the PC has been turned on, quit all the applications now running.
2. **Turn on the receiver, and select the source as “USB.”**
3. **Set the volume to minimum.**

### IMPORTANT:

Always set volume to “0” when connecting or disconnecting other equipment.

4. **Connect the receiver to the PC using a USB cable (not supplied).**

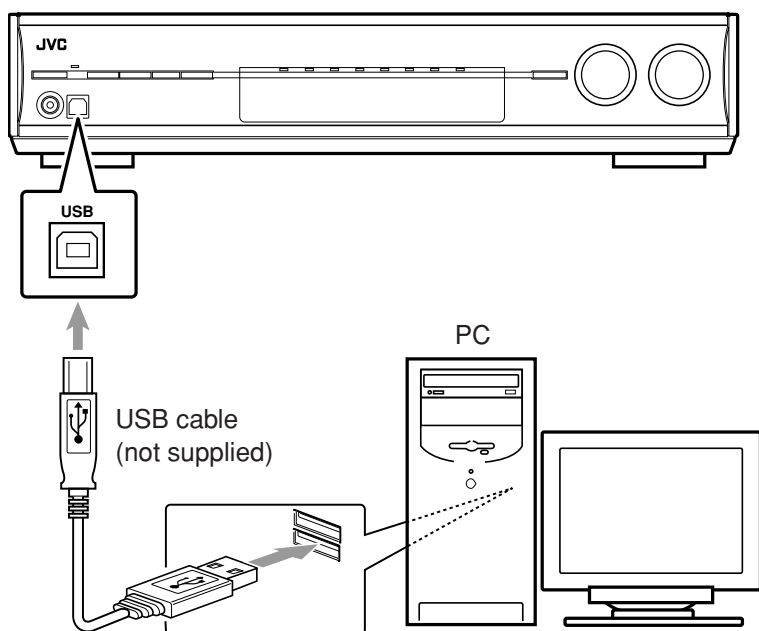

- Use “USB series A plug to B plug” cable when connecting.

### How to install the USB drivers

The following procedure is described using the English version of Windows® XP. If your PC is running on a different version of operation system or language, the screens shown on your PC's monitor will differ from the ones used in the following procedure.

1. **The USB drivers are installed automatically.**
  - If the USB drivers are not installed automatically, install the USB drivers by following the instructions on the PC's monitor.

### 2. Check if the drivers are correctly installed.

1. Open the Control Panel on your PC:  
Select [Start] → [Control Panel].
  2. Select [System] → [Hardware] → [Device Manager] → [Sound, video and game controllers] and [Universal Serial Bus controllers].
- The following window appears, and you can check whether the drivers are installed.

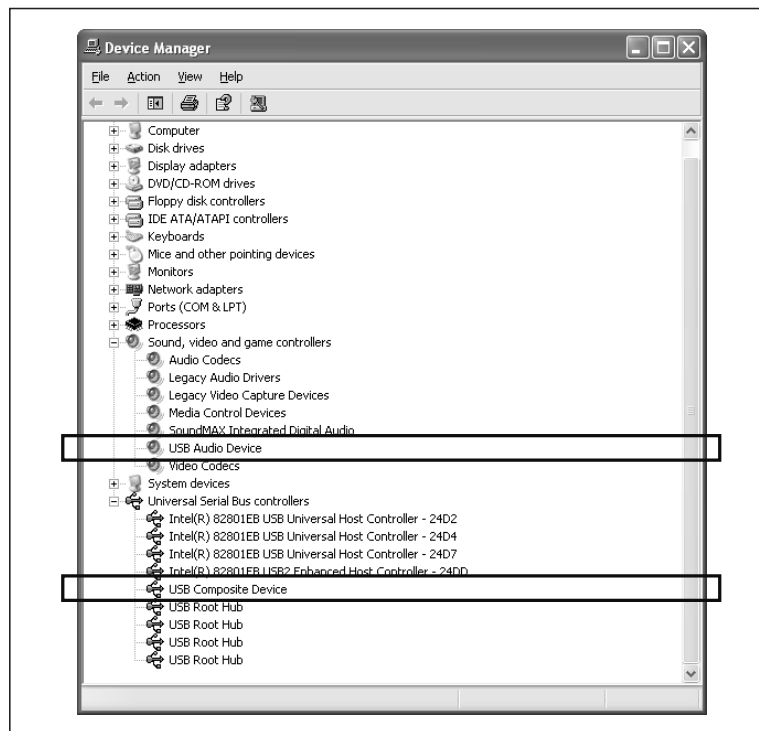

Now the PC is ready for playback through the USB connection.

After installation is completed, you can use your PC as the playback source. The PC automatically recognizes the receiver whenever the USB cable is connected between the PC and the receiver while the receiver is turned on.

- When not using the PC as the playback source, disconnect the transmitter or the USB cable.

To play back sounds on the PC, refer to the manuals supplied with the sound reproduction application installed in the PC. Start the application after the USB device is recognized.

### If no sound comes from the speakers, check the following items:

- check if the USB device is recognized properly.
- check if the playback software in your PC is compatible with the USB device.
- open the Control Panel on your PC, select [Sounds and Audio Devices] → [Audio] tab → [Sound playback] → [Default device], and check if [Default device] is set to [USB Audio DAC].
- select “USB” as the source.
- connect the USB cable correctly.

### NOTES

- DO NOT turn off the receiver or disconnect the USB cable while installing the drivers and for several seconds while your PC is recognizing the receiver.
- If your PC does not recognize the receiver, disconnect the USB cable and connect it again. If it does not work yet, restart Windows®.
- The installed drivers can be recognized only when the USB cable is connected between the receiver and your PC.
- The sound may not be played back correctly—interrupted or degraded—due to your PC settings and PC specifications.
- Use a USB cable (version 1.1 or later). Recommended cord length is 1.5 m.

\* Microsoft®, Windows® 98 SE, Windows® Me, Windows® 2000, and Windows® XP are registered trademarks of Microsoft corporation.



# Basic operations

## 2 Select the source to play

### On the front panel:

Turn **SOURCE SELECTOR** until the source name you want appears on the display.

The source lamp corresponding to the selected source lights in red.

- As you turn SOURCE SELECTOR, the source changes as follows:

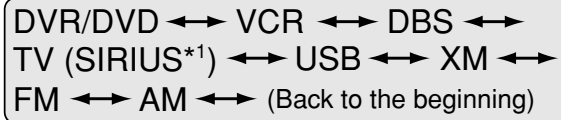
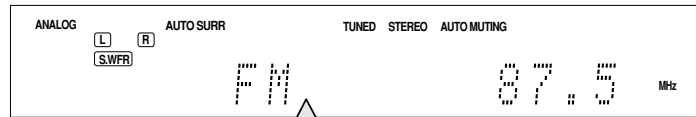

- DVR/DVD\*2: Select this for the DVD recorder or DVD player.
- VCR\*2: Select this for the VCR.
- DBS\*2: Select this for the DBS tuner.
- TV\*1,2: Select this for the TV.
- SIRIUS\*1: Select this for the SIRIUS Satellite Radio.
- USB: Select this for the PC component.
- XM: Select this for the XM Satellite Radio.
- FM: Select this for an FM broadcast.
- AM: Select this for an AM broadcast.

### From the remote control:

Press one of the source selecting buttons.

- For "FM" and "AM," press FM/AM. Each time you press FM/AM, the mode alternates between "FM" and "AM."

### \*1 Changing the source name of TV/SIRIUS input

#### On the front panel only:

Press **SET** when "TV" is selected as the source.

- "ASSIGN SIRIUS" appears on the display for a while.

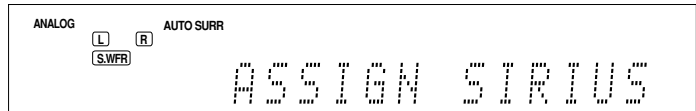

- When you change the source name to "TV," press SET when "SIRIUS" is selected as the source. "ASSIGN TV" appears on the display for a while.

#### NOTE

When you change the source name to "SIRIUS," you cannot select "TV" as the source.

### \*2 Selecting the analog or digital input mode

You need to select the proper input mode according to the connection method (analog or digital) on pages 7 to 10.

- In case of digital connection, you also need to select the correct digital input terminal. (See "Setting the digital input (DIGITAL IN) terminals—DIGITAL IN 1/2/3" on page 25.)
- "DIGITAL AUTO" and "ANALOG" setting are memorized for each source.

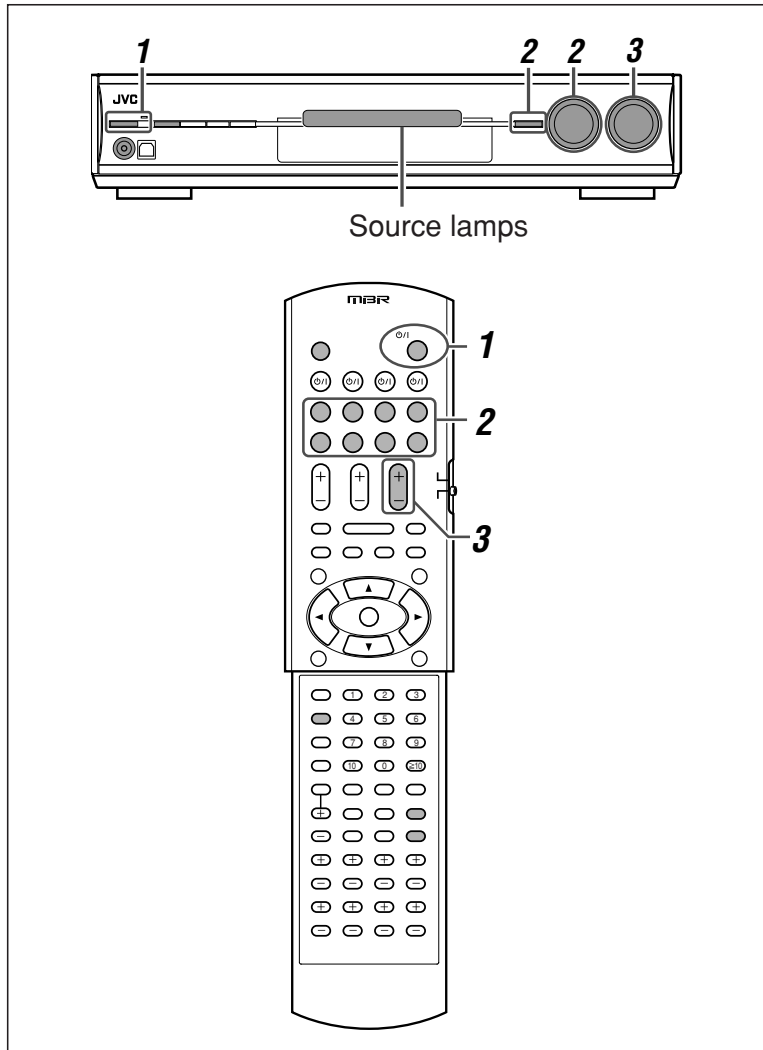

Source lamps

## 1 Turn on the power

Press **O/I STANDBY/ON** (or **O/I AUDIO** on the remote control).

The standby lamp goes off and the source lamp of the current source lights in red.

Current source name appears.

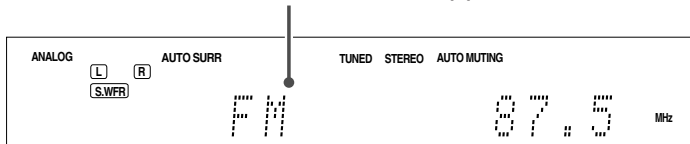

### To turn off the power (into standby)

Press **O/I STANDBY/ON** (or **O/I AUDIO** on the remote control) again.

The standby lamp lights in red.

#### NOTE

A small amount of power is consumed in standby mode. To turn the power off completely, unplug the AC power cord.

## From the remote control ONLY:

Press **ANALOG/DIGITAL** to select the analog or digital input mode.

- Each time you press the button, the input mode changes as follows:

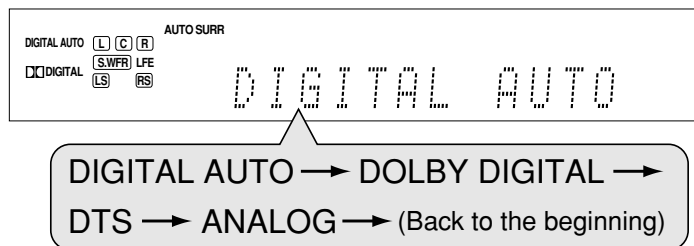

<b>DIGITAL AUTO:</b>	Select for the digital input mode. The receiver automatically detects the incoming signal format, then the digital signal format indicator (LINEAR PCM, <b>DIGITAL</b> , <b>dts</b> , or <b>dts</b> 96/24) for the detected signal lights up.
<b>DOLBY DIGITAL</b> <sup>*3</sup> :	Select to play back software encoded with Dolby Digital.
<b>DTS</b> <sup>*3</sup> :	Select to play back software encoded with DTS.
<b>ANALOG:</b>	Select for the analog input mode. The ANALOG indicator lights up on the display.

**Initial setting:** DIGITAL AUTO

<sup>\*3</sup> If the following symptoms occur while playing Dolby Digital or DTS software with "DIGITAL AUTO" selected, select "DOLBY DIGITAL" or "DTS."

- Sound does not come out at the beginning of playback.
- Noise comes out while searching for or skipping chapters or tracks.

**Ex.: When "DOLBY DIGITAL" is selected:**

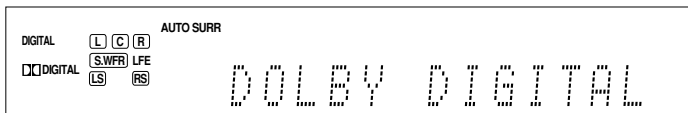

### NOTES

- You cannot select the digital input mode when selecting "FM," "AM," or "SIRIUS" as the source.
- The input mode is fixed to "DIGITAL AUTO" when selecting "USB" or "XM" as the source.
- When you turn off the power or select another source, "DOLBY DIGITAL" or "DTS" is canceled and the digital mode is automatically reset to "DIGITAL AUTO."

The following digital signal format indicators on the display indicate what type of signal comes into the receiver.

- LINEAR PCM:** Lights up when Linear PCM signal comes in.
- DIGITAL:**
- Lights up when Dolby Digital signal comes in.
  - Flashes when "DOLBY DIGITAL" is selected for any software other than Dolby Digital.
- dts:**
- Lights up when conventional DTS signal comes in.
  - Flashes when "DTS" is selected for any software other than DTS.
- dts 96/24:** Lights up when DTS 96/24 signal comes in.

### NOTE

When "DIGITAL AUTO" cannot recognize the incoming signal, no digital signal format indicator lights up on the display.

## 3 Adjust the volume

To increase the volume, turn **MASTER VOLUME** control clockwise (or press **VOLUME +** on the remote control).

To decrease the volume, turn **MASTER VOLUME** control counterclockwise (or press **VOLUME -** on the remote control).

- When you adjust the volume, the volume level indication appears on the display for a while.

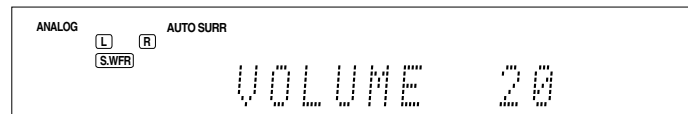

### CAUTION:

Always set the volume to the minimum before starting any sources. If the volume is set at its high level, the sudden blast of sound energy can permanently damage your hearing and/or ruin your speakers.

### NOTE

The volume level can be adjusted within the range of "0" (minimum) to "50" (maximum).

## Listening with headphones

You can enjoy not only stereo software but also multi-channel software through the headphones. (Sounds are down-mixed to the front channels while playing multi-channel software.)

**Connect a pair of headphones to the PHONES jack on the front panel to activate the HEADPHONE mode.**

The HEADPHONE indicator lights up on the display.

- You can also enjoy the Surround/DSP mode through the headphones—3D HEADPHONE mode. For details, see page 31.
- Disconnecting a pair of headphones from the PHONES jack cancels the HEADPHONE (or 3D HEADPHONE) mode and activates the speakers.

### CAUTION:

Be sure to turn down the volume:

- Before connecting or putting on headphones, as high volume can damage both the headphones and your hearing.
- Before removing headphones, as high volume may output from the speakers.

## Turning off the sounds temporarily

**From the remote control ONLY:**

**Press MUTING to turn off the sound through all connected speakers and headphones.**

"MUTING" appears on the display and the volume turns off.

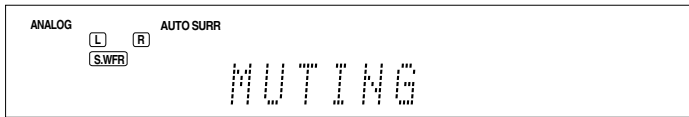

**To restore the sound,** press MUTING again.

- Pressing VOLUME +/- (or turning MASTER VOLUME control on the front panel) also restores the sound.

## Changing the display brightness

You can dim the display—Dimmer.

**Press DIMMER repeatedly.**

- Each time you press the button, the display brightness changes as follows:

- DIMMER 1: Dims the display.
- DIMMER 2: Dims the display more than DIMMER 1.
- DIMMER 3: Turns off the display.  
(Temporarily canceled when you operate the receiver.)
- DIMMER OFF: Cancels the Dimmer (normal display).

## Turning off the power with the Sleep Timer

You can fall asleep while listening to music—Sleep Timer.

**From the remote control ONLY:**

**Press SLEEP repeatedly.**

- Each time you press the button, the shut-off time changes in 10 minute intervals. The SLEEP indicator lights up on the display.

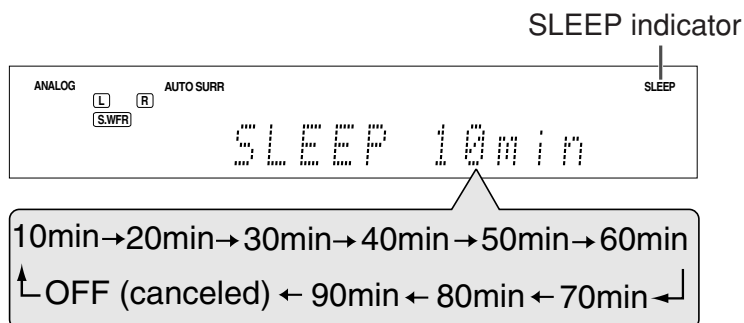

**When the shut-off time comes:**

The receiver turns off automatically.

**To check or change the remaining time until the shut-off time:**

Press SLEEP once.

The remaining time (in minutes) until the shut-off time appears.

- To change the shut-off time, press SLEEP repeatedly.

**To cancel the Sleep Timer:**

Press SLEEP repeatedly so that "SLEEP OFF" appears on the display. (The SLEEP indicator goes off.)

- The Sleep Timer is also canceled when you turn off the receiver.

## Basic adjustment of auto memory

This receiver memorizes sound settings for each source:

- when you turn off the power, and
- when you change the source.

When you change the source, the memorized settings for the newly selected source are automatically recalled.

The following can be stored for each source:

- Analog/digital input mode (see page 12)
- Bass boost (see page 28)
- Digital equalization pattern (see page 27)
- Input attenuator mode (see page 28)
- Midnight mode (see page 24)
- Speaker output level (see page 27)
- Surround/DSP mode selection (see page 34)

### NOTE

If the source is "FM" or "AM," you can assign a different setting for each band.

## Signal and speaker indicators on the display

Signal indicators

Speaker indicators

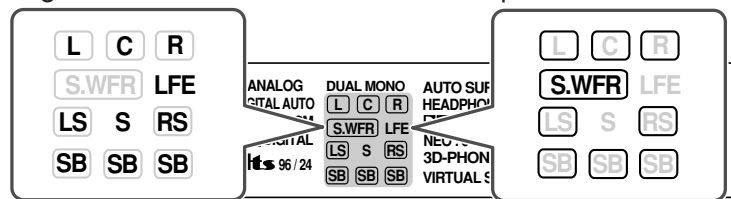

**The signal indicators light up as follows:**

- L:**
  - When digital input is selected: Lights up when the left channel signal comes in.
  - When analog input is selected: Always lights up.
- R:**
  - When digital input is selected: Lights up when the right channel signal comes in.
  - When analog input is selected: Always lights up.
- C:** Lights up when the center channel signal comes in.
- LS:** Lights up when the left surround channel signal comes in.
- RS:** Lights up when the right surround channel signal comes in.
- S:** Lights up when monaural surround signal comes in.
- SB:** Lights up when the surround back channel signal comes in.
- LFE:** Lights up when the LFE channel signal comes in.

**The speaker indicators light up as follows:**

- The subwoofer indicator (**S.WFR**) lights up when "SUBWOOFER" is set to "SUBWFR <YES>." For details, see page 22.
- The other speaker indicators light up only when the corresponding speaker is set to "SML (small)" or "LRG (large)," and also when required for the current playback.

# FM/AM tuner operations

FM/AM tuner operations are mainly done from the remote control.

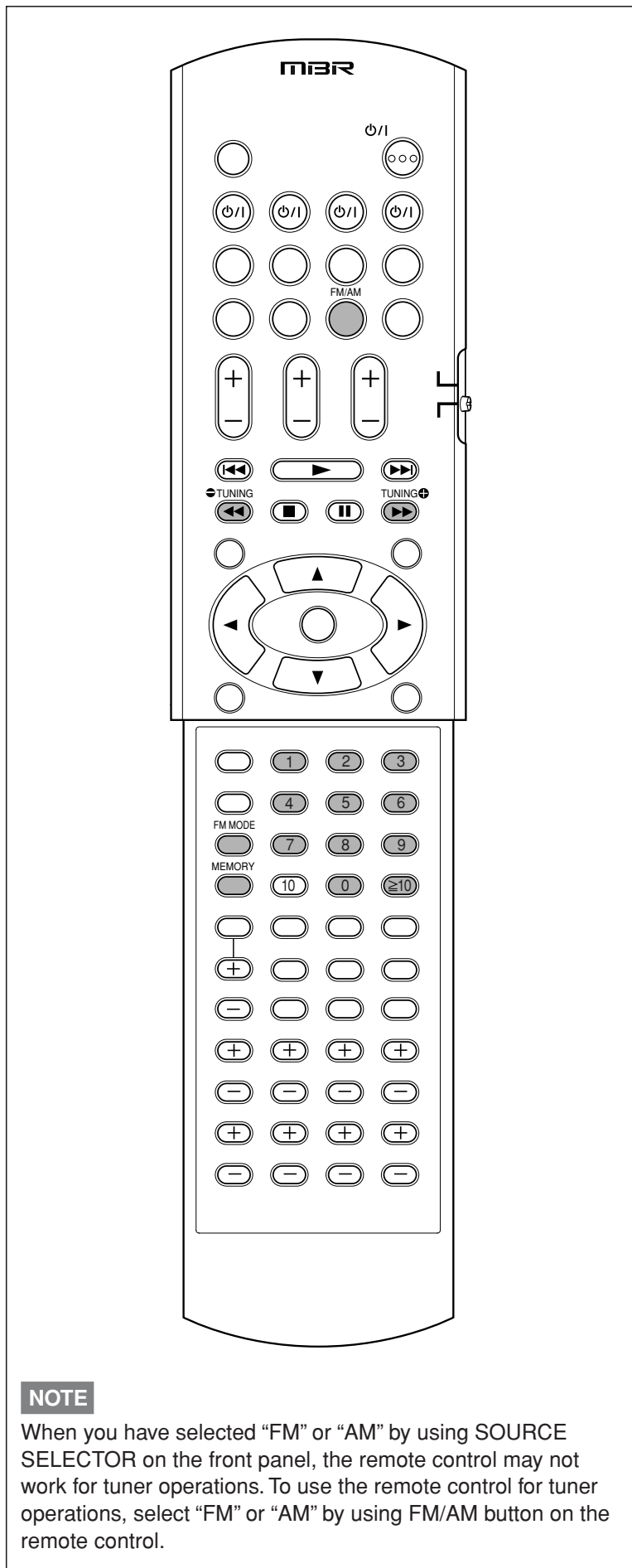

## NOTE

When you have selected "FM" or "AM" by using SOURCE SELECTOR on the front panel, the remote control may not work for tuner operations. To use the remote control for tuner operations, select "FM" or "AM" by using FM/AM button on the remote control.

## Tuning in to FM/AM stations manually

From the remote control **ONLY**:

### 1 Press FM/AM to select the band.

The last received station of the selected band is tuned in.

- Each time you press the button, the band alternates between "FM" and "AM."

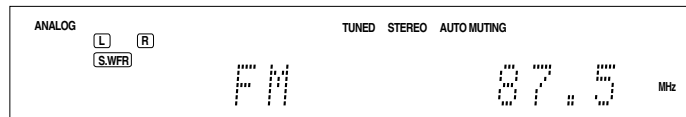

### 2 Press repeatedly or hold TUNING + or TUNING - until the station you want is tuned in.

- Pressing (or holding) TUNING + increases the frequency.
- Pressing (or holding) TUNING - decreases the frequency.

## NOTES

- When you hold and release TUNING + or TUNING -, the frequency keeps changing until a station is tuned in.
- When a station of sufficient signal strength is tuned in, the TUNED indicator lights up on the display.
- When an FM stereo program is received, the STEREO indicator also lights up.

## Using preset tuning

Once a station is assigned a channel number, the station can be quickly tuned simply by selecting the number. You can preset up to 30 FM and 15 AM stations.

### To store the preset stations

Before you start, remember...

There is a time limit in doing the following steps. If the setting is canceled before you finish, start from step 2 again.

From the remote control **ONLY**:

### 1 Tune in to the station you want to preset (see "Tuning in to FM/AM stations manually" above).

- If you want to store the FM reception mode for this station, select the FM reception mode you want. See "Selecting the FM reception mode" on page 16.

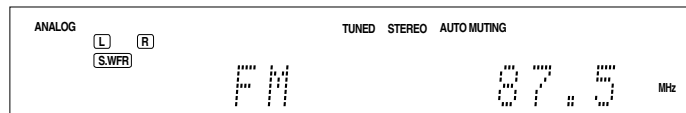

### 2 Press MEMORY.

The channel number position starts flashing on the display for about 5 seconds.

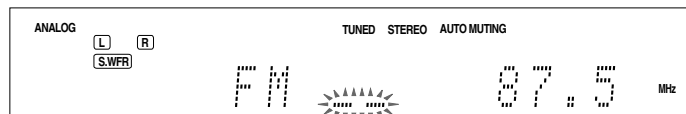

CONTINUED ON THE NEXT PAGE

**3 Press the numeric buttons (0 – 9,  $\geq 10$ ) to select a channel number while the channel number position is flashing.**

- For channel number 5, press 5.
- For channel number 10, press  $\geq 10$ , 1, then 0.
- For channel number 15, press  $\geq 10$ , 1, then 5.

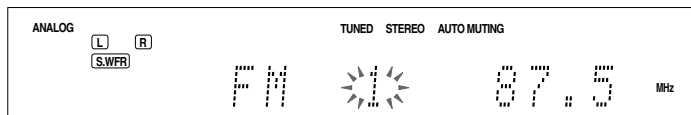

**4 Press MEMORY again while the selected channel number is flashing on the display.**

The selected channel number stops flashing.  
The station is assigned to the selected channel number.

**5 Repeat steps 1 to 4 until you store all the stations you want.**

**To erase a stored preset station**

Storing a new station on a used channel number erases the previously stored one.

**To tune in to a preset station**

**From the remote control:**

**1 Press FM/AM to select the band.**

The last received station of the selected band is tuned in and the numeric buttons now work for tuner operations.

- Each time you press the button, the band alternates between “FM” and “AM.”

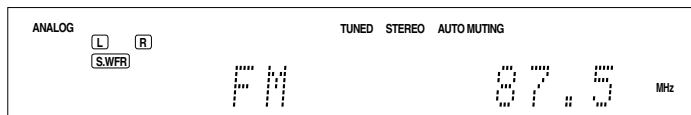

**2 Press the numeric buttons (0 – 9,  $\geq 10$ ) to select a preset channel number.**

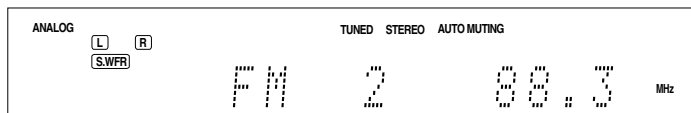

- For channel number 5, press 5.
- For channel number 10, press  $\geq 10$ , 1, then 0.
- For channel number 15, press  $\geq 10$ , 1, then 5.

**On the front panel:**

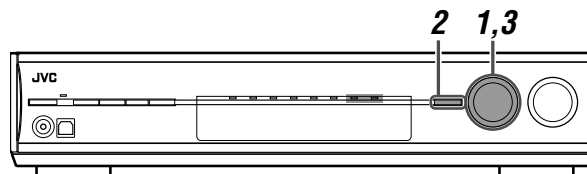

**Before you start, remember...**

There is a time limit in doing the following steps. If the setting is canceled before you finish, start from step 2 again.

**1 Turn SOURCE SELECTOR to select “FM” or “AM.”**

The last received station of the selected band is tuned in.

**2 Press TUNER PRESET.**

“P” appears on the display, and MULTI JOG now works for selecting preset channels.

**3 Turn MULTI JOG to select a preset channel number.**

- To increase the preset channel numbers, turn MULTI JOG clockwise.
- To decrease the preset channel numbers, turn MULTI JOG counterclockwise.

---

## Selecting the FM reception mode

When an FM stereo broadcast is hard to receive or noisy, you can change the FM reception mode while receiving an FM broadcast.

- You can store the FM reception mode for each preset station (see page 15).

**From the remote control ONLY:**

**While listening to an FM station, press FM MODE.**

- Each time you press the button, the FM reception mode alternates between “AUTO MUTING” and “MONO.”

---

**AUTO MUTING**

Normally select this.

When a program is broadcast in stereo, you will hear stereo sound; when in monaural, you will hear monaural sound. This mode is also useful to suppress static noise between stations. The AUTO MUTING indicator lights up on the display.

---

**MONO**

Select this to improve the reception (but stereo effect will be lost).

In this mode, you will hear noise while tuning in to the stations. The AUTO MUTING indicator goes off from the display. (The STEREO indicator also goes off.)

---

**Initial setting:** AUTO MUTING



# XM Satellite Radio operations

This is an XM Ready® receiver.

- Before operating, refer also to the manuals of your XM Connect and Play Digital Antenna (not supplied).

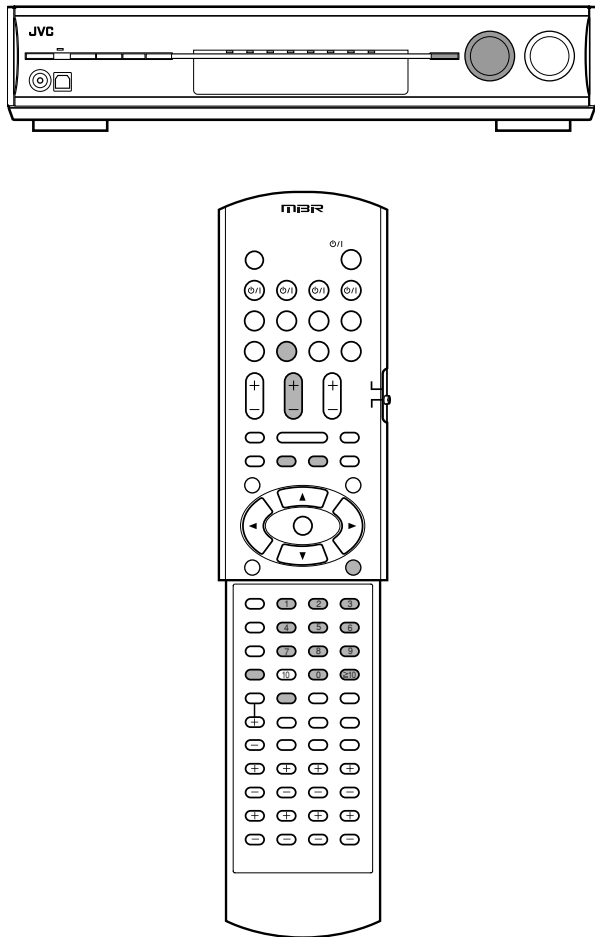

## NOTE

When you have selected "XM" by using SOURCE SELECTOR on the front panel, the remote control may not work for XM Satellite Radio operations. To use the remote control for XM Satellite Radio operations, select "XM" by using XM button on the remote control.

## About XM Satellite Radio

XM Satellite Radio is a satellite radio with digital-quality sound and over 100 digital channels—100% commercial-free music channels, over 30 channels of news, sports, talk and entertainment, and over 20 channels of traffic and weather. For the latest channel listings and programming information, or to sign up, visit <<http://www.xmradio.com>>.

XM Ready® is a registered trademark of XM Satellite Radio Inc. All rights reserved.

## Preparation

To listening to XM Satellite Radio, you need the following:

- The XM Connect and Play Digital Antenna (not supplied)\*
- Subscription to XM Satellite Radio\*\*.

\* To connect the XM Connect and Play Digital Antenna with this receiver, see page 5.

\*\*The following channels are available without subscription:

- Channel 0: This channel is for checking the XM Satellite Radio ID number.
- Channel 1: This is "XM Preview" channel.

## How to subscribe

XM Satellite radio is a subscription service.

To subscribe to XM Satellite Radio, visit the XM Satellite Radio's web site at <<http://xmradio.com/activation/>>, or you can call 1-800-XM-RADIO (1-800-967-2346).

For subscription, you need to have the XM Satellite radio ID number. To check the ID number, follow the procedure below:

## How to check the XM Satellite Radio ID number

After connection:

- 1 Press XM on the remote control or turn SOURCE SELECTOR on the front panel to select "XM" as the source.**
- 2 Tune in to "Channel 0" (see "Tune in to channels" on page 18) to check your XM Satellite Radio ID number.**

The display alternately shows "RADIO ID" and the 8-digit (alphanumeric) ID number.

**To cancel the ID number display**

Select any channel other than "Channel 0."

## Listening to XM Satellite Radio

- 1 Press XM on the remote control or turn SOURCE SELECTOR on the front panel to select "XM" as the source.**

The last received channel is tuned in.

"XM" appears and then the channel name appears on the display.

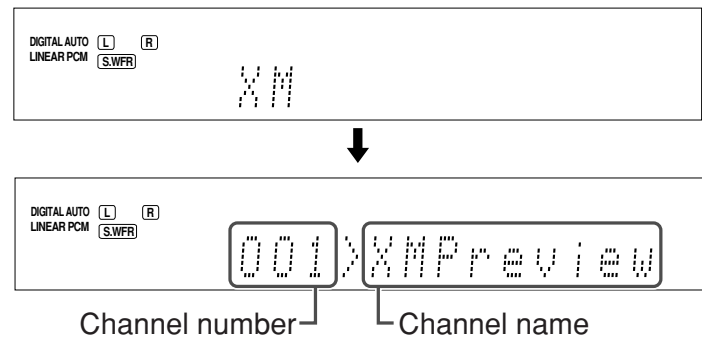

- 2 Tune in to the desired channel.**

You can tune in to channels with one of the following methods:

- Channel Search
- Category Search
- Direct Channel Access

For details, see "Tune in to channels" on page 18.

## Tuning in to channels

### From the remote control ONLY:

#### ■ Channel Search

You can search and tune in to all channels (including non-categorized channels).

- 1 Press **XM** to select “XM” as the source.
- 2 Press repeatedly or hold **CHANNEL +/-** until the desired channel number appears on the display.

- Pressing (or holding) **CHANNEL +** increases the channel number.
- Pressing (or holding) **CHANNEL -** decreases the channel number.

#### NOTE





While searching, the invalid and unsubscribed channels are skipped.

#### ■ Category Search

You can select the channel category and tune in to only the channels included in the selected category.

#### Before you start, remember...

There is a time limit in doing the following steps. If the setting is canceled before you finish, start from step **2** again.

- 1 Press **XM** to select “XM” as the source.
- 2 Press **CAT**  or **CAT** . The receiver enters the Category Search mode. The category name of the currently selected channel appears and “>” starts flashing on the display for about 15 seconds.
- 3 Press **CAT**  or **CAT**  repeatedly to display the desired category name on the display while “>” is flashing.

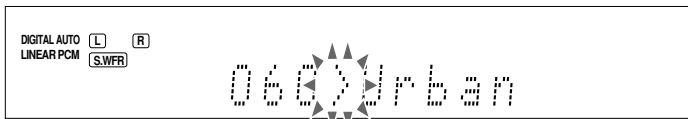
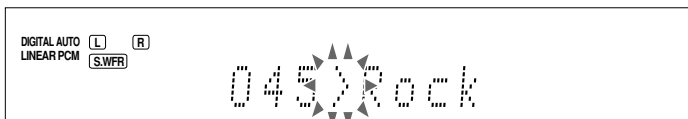

- 4 Press repeatedly or hold **CHANNEL +/-** until the desired channel is tuned in.
- Pressing (or holding) **CHANNEL +** increases the channel number included in the selected category.
  - Pressing (or holding) **CHANNEL -** decreases the channel number included in the selected category.

#### NOTE

While searching, the invalid and unsubscribed channels are skipped.

#### ■ Direct Channel Access

You can tune in to the desired channel directly by entering the channel number.

#### Before you start, remember...

There is a time limit in doing the following steps. If the setting is canceled before you finish, start from step **2** again.

- 1 Press **XM** to select “XM” as the source.
- 2 Press **DIRECT**.

The receiver enters the Direct Access mode and the numeric buttons now work for entering channel numbers.

The channel number position starts flashing on the display for about 5 seconds.

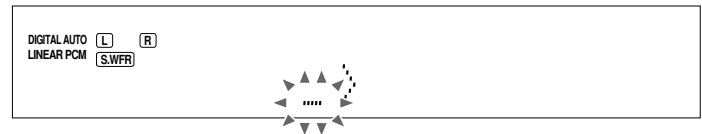

- 3 Press the numeric buttons (0 – 9,  $\geq 10$ ) to enter the desired channel number while the channel number position is flashing.

- For channel number 005, press 5.
- For channel number 010, press  $\geq 10$ , 1, then 0.
- For channel number 015, press  $\geq 10$ , 1, then 5.
- For channel number 115, press  $\geq 10$ ,  $\geq 10$ , 1, 1, then 5.

## Using preset tuning

Once a channel is assigned a preset number, the channel can be quickly tuned simply by selecting the number. You can preset up to 30 channels.

### To store the preset channels

#### Before you start, remember...

There is a time limit in doing the following steps. If the setting is canceled before you finish, start from step **2** again.

### From the remote control ONLY:

- 1 Tune in to the channel you want to preset (see “Tune in to channels” above).

- 2 Press **MEMORY**.

The preset number position starts flashing on the display for about 5 seconds.

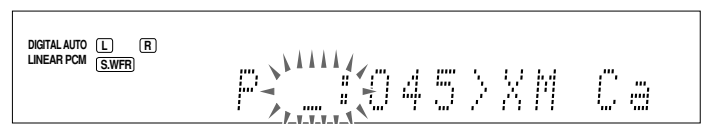

- 3 Press the numeric buttons (0 – 9,  $\geq 10$ ) to select a preset number while the preset number position is flashing.

- For preset number 5, press 5.
- For preset number 10, press  $\geq 10$ , 1, then 0.
- For preset number 15, press  $\geq 10$ , 1, then 5.

**4** Press **MEMORY** again while the selected preset number is flashing on the display.

**5** Repeat steps **1** to **4** until you store all the desired channels.

**To erase a stored preset channel**

Storing a new channel on a used preset number erases the previously stored one.

**To tune in a preset channel**

**From the remote control:**

**1 Press XM.**

The last received channel is tuned in.

**2 Press the numeric buttons (0 – 9, ≥10) to select a preset channel number.**

- For preset number 5, press 5.
- For preset number 10, press ≥10, 1, then 0.
- For preset number 15, press ≥10, 1, then 5.

**On the front panel:**

**Before you start, remember...**

There is a time limit in doing the following steps. If the setting is canceled before you finish, start from step **2** again.

**1 Turn SOURCE SELECTOR to select “XM.”**

The last received channel is tuned in.

**2 Press TUNER PRESET.**

“P” flashes on the display, and MULTI JOG now works for selecting preset channels.

**3 Turn MULTI JOG to select a preset number.**

- To increase the preset numbers, turn MULTI JOG clockwise.
- To decrease the preset numbers, turn MULTI JOG counterclockwise.

## Changing the channel information

While listening to XM Satellite Radio, the currently selected channel information appears on the display. You can change the kind of channel information.

**From the remote control ONLY:**

**Press DISPLAY.**

Each time you press the button, the channel information changes as follows:

CHAN (channel name)\* → NAME (artist name/feature) → TITLE (song/program title) → CAT (category name) → Back to the beginning

\* “CHAN” is the initial setting.

**EX.: When the category name is selected:**

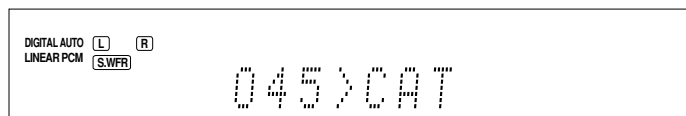

↓ After one second

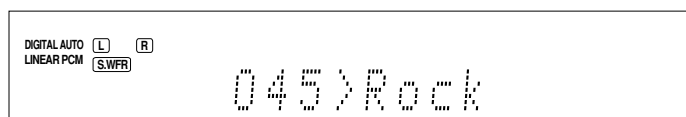

**NOTES**

- If you turn off the power or select another source, the display is changed back to the initial setting.
- When you tune in to another channel, the channel name appears on the display and then the channel information you have selected appears.
- When all the text information cannot be shown on the display at the same time, the text scrolls.
- Some characters cannot be displayed correctly.

### Messages on the display

When problems occur, a message appears on the display. In this case, refer to the following solution.

Message	Possible cause	Solution
NO SIGNAL	Signals are too weak.	Move the XM Connect and Play Digital Antenna near a south-facing window or where “Channel 1” can be heard clearly.
CHECK ANTENNA	The XM Connect and Play Digital Antenna is not connected properly.	Check the connection (see page 5).
LOADING	This receiver is loading the channel information and audio data.	It takes a few minutes to complete. Wait until loading is finished.
OFF AIR	Selected channel is not currently broadcasting any signal.	Select another channel.
UPDATING	The latest encryption code is being updated.	Wait until updating is finished.
• Channel number and “-----” • Preset number, channel number, and “-----”	No text information for the selected channel is available.	_____
• Channel number and “CH---” • Preset number and “--->CH---”	Selected channel does not exist or is not subscribed yet.	_____

# Basic settings

To obtain the best possible sound effect from Surround/DSP modes (see pages 30 to 34), you need to set up the speaker and subwoofer information after all the connections are completed. From pages 20 to 25, how to set speakers and other basic items of the receiver are explained.

## Setting the speaker information easily—Quick Speaker Setup

Quick Speaker Setup helps you to easily and quickly register the speaker size, speaker distance, and output level of each speaker according to your listening room to create the best possible surround effect.

- You can also register each speaker's information manually. For details, see pages 23 and 27.

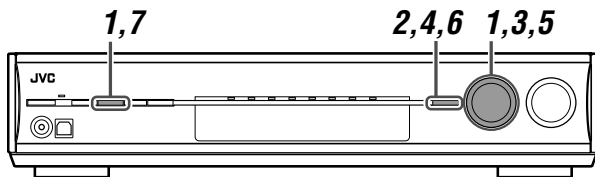

### Before you start, remember...

There is a time limit in doing the following steps. If the setting is canceled before you finish, start from step 1 again.

### On the front panel ONLY:

- 1 Press **SETTING** and turn **MULTI JOG** until "**QUICK SPK SET**" appears on the display.

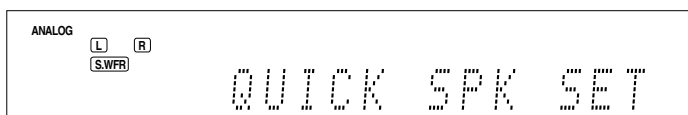

- 2 Press **SET**.

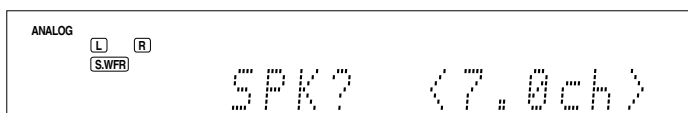

- 3 Turn **MULTI JOG** to select the appropriate number of connected speakers (speaker channel number).

As you turn the jog, the speaker channel number changes as follows.

- For the details of speaker channel number, see "Speakers (channels) number and the size" on page 21.

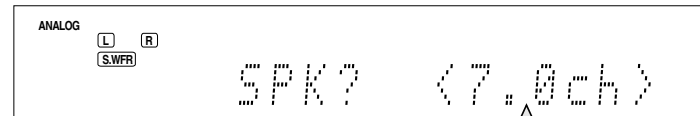

2.0ch ↔ 2.1ch ↔ 3.0ch ↔ 3.1ch ↔  
4.0ch ↔ 4.1ch ↔ 5.0ch ↔ 5.1ch ↔  
6.0ch ↔ 6.1ch ↔ 7.0ch\* ↔ 7.1ch ↔  
(Back to the beginning)

\* "7.0ch" is the initial setting.

- 4 Press **SET**.

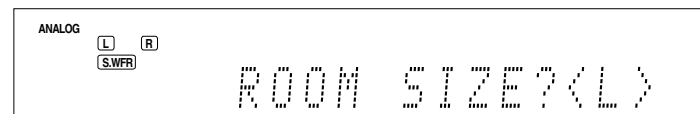

- 5 Turn **MULTI JOG** to select the appropriate room size to match to your listening room.

As you turn the jog, the room size changes as follows.

- To select your appropriate room size, see "Room size and the speaker distance/output level" on page 21.

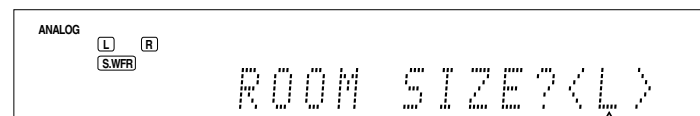

S ↔ M ↔ L\* ↔ (Back to the beginning)

\* "L" is the initial setting.

- 6 Press **SET**.

QUICK SPEAKER SETUP is now completed, then the display goes back to SETTING menu.

- 7 Press **SETTING**.

### NOTES

- This procedure will not be completed if you stop in the middle of the setting process.
- Once Quick Speaker Setup is performed, the speaker output levels are also set to appropriate values automatically (common to all sources). If you want to set the speaker output levels separately for each source, see "Adjusting the speaker output levels" on page 27.

## Speakers (channels) number and the size

You can find how each of the speaker size is defined according to the number of connected speakers (speaker channel "ch" number) you select.

- Subwoofer is counted as 0.1 channel.

CH	The size of connected speakers				
	L/R	C	LS/RS	SB	SUBWFR
2.0CH	LRG (large)	NO	NO	NO	NO
2.1CH	SML (small)	NO	NO	NO	YES
3.0CH	LRG	SML	NO	NO	NO
3.1CH	SML	SML	NO	NO	YES
4.0CH	LRG	NO	SML	NO	NO
4.1CH	SML	NO	SML	NO	YES
5.0CH	LRG	SML	SML	NO	NO
5.1CH	SML	SML	SML	NO	YES
6.0CH	LRG	SML	SML	SML (1SPK)	NO
6.1CH	SML	SML	SML	SML (1SPK)	YES
7.0CH	LRG	SML	SML	SML (2SPK)	NO
7.1CH	SML	SML	SML	SML (2SPK)	YES

## Room size and the speaker distance/output level

According to the selected room size, speaker distance and speaker output level for each activated speaker is set as follows:

Room size	Speaker	Distance	Output level
<b>L</b> (Large)	L/R	3.0 m (10 ft)	0 dB
	C	3.0 m (10 ft)	0 dB
	LS/RS	3.0 m (10 ft)	0 dB
	SBL(SB)/SBR	3.0 m (10 ft)	0 dB
<b>M</b> (Medium)	L/R	2.7 m (9 ft)	0 dB
	C	2.4 m (8 ft)	-2 dB
	LS/RS	2.1 m (7 ft)	-3 dB
	SBL(SB)/SBR	1.8 m (6 ft)	-4 dB
<b>S</b> (Small)	L/R	2.4 m (8 ft)	0 dB
	C	2.1 m (7 ft)	-2 dB
	LS/RS	1.5 m (5 ft)	-4 dB
	SBL(SB)/SBR	1.2 m (4 ft)	-6 dB

### NOTE

Abbreviations used in the tables above stand for the following speakers and the subwoofer:

- L: Left front speaker
- R: Right front speaker
- C: Center speaker
- LS: Left surround speaker
- RS: Right surround speaker
- SB: Surround back speaker
- SBL: Left surround back speaker
- SBR: Right surround back speaker
- SUBWFR: Subwoofer

## Basic setting items

You can adjust the following items. See pages in parentheses for details.

- You cannot select the items which is not available with the current setting. For example, when the speaker channel number is set to "<5.1ch>" in Quick Speaker Setup, you cannot select the following items:  
S BACK OUT, S BACK DIST, S BACK L DIST, S BACK R DIST

Items	To do
<b>QUICK SPK SET</b>	Register the number of speakers you connect and the size of your listening room. (20)
<b>SUBWOOFER*</b>	Register your subwoofer. (22)
<b>FRONT SPK*</b>	Register your front speaker size. (22)
<b>CENTER SPK*</b>	Register your center speaker size. (22)
<b>SURROUND SPK*</b>	Register your surround speaker size. (22)
<b>S BACK SPK*</b>	Register your surround back speaker size. (22)
<b>S BACK OUT*</b>	Register the number of your surround back speaker(s). (22)
<b>DIST UNIT</b>	Select the measuring unit for the speaker distance. (23)
<b>FRONT L DIST*</b>	Register the distance from the left front speaker to your listening point. (23)
<b>FRONT R DIST*</b>	Register the distance from the right front speaker to your listening point. (23)
<b>CENTER DIST*</b>	Register the distance from the center speaker to your listening point. (23)
<b>SURR L DIST*</b>	Register the distance from the left surround speaker to your listening point. (23)
<b>SURR R DIST*</b>	Register the distance from the right surround speaker to your listening point. (23)
<b>S BACK DIST*</b>	Register the distance from the surround back speaker to your listening point. (23)
<b>S BACK L DIST*</b>	Register the distance from the left surround back speaker to your listening point. (23)
<b>S BACK R DIST*</b>	Register the distance from the right surround back speaker to your listening point. (23)
<b>EX/ES/PLIIX</b>	Select the EX/ES/PLIIX reproduction mode. (23)
<b>DUAL MONO</b>	Select the Dual Mono sound channel. (24)
<b>SUBWOOFER OUT</b>	Select sounds emitted from the subwoofer. (24)
<b>CROSSOVER</b>	Select the cutoff frequency to the subwoofer. (24)
<b>LFE ATT</b>	Attenuate the bass (LFE) sounds. (24)
<b>MIDNIGHT MODE</b>	Reproduce a powerful sound at night. (24)
<b>DIGITAL IN 1</b>	Select the component connected to the digital coaxial terminal—1(DVR/DVD). (25)
<b>DIGITAL IN 2</b>	Select the component connected to the digital optical terminal—2(DBS). (25)
<b>DIGITAL IN 3</b>	Select the component connected to the digital optical terminal—3(VCR). (25)
<b>DVD VIDEO IN</b>	Select the type of video terminal used for the DVD recorder or DVD player. (25)
<b>VCR VIDEO IN</b>	Select the type of video terminal used for the VCR. (25)
<b>DBS VIDEO IN</b>	Select the type of video terminal used for the DBS tuner. (25)

- \* If you have used Quick Speaker Setup on page 20, these settings are not required.



## Operating procedure

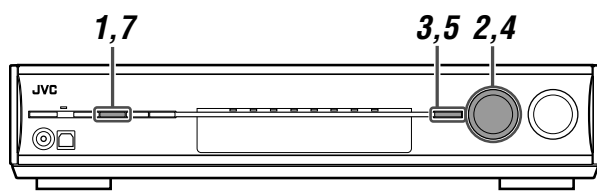

### On the front panel ONLY:

#### Before you start, remember...

There is a time limit in doing the following steps. If the setting is canceled before you finish, start from step **1** again.

Ex.: When setting DIGITAL IN 1 terminal.

### 1 Press SETTING.

MULTI JOG now works for the setting operation.

### 2 Turn MULTI JOG until the item you want to set appears on the display.

- As you turn MULTI JOG, the setting items change as follows:

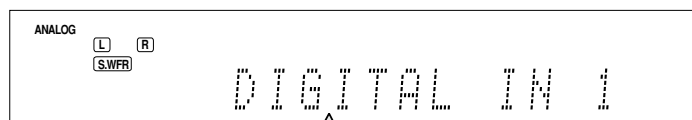

QUICK SPK SET	↔	SUBWOOFER	↔
FRONT SPK	↔	CENTER SPK	↔
SURROUND SPK	↔	S BACK SPK	↔
S BACK OUT	↔	DIST UNIT	↔
FRONT L DIST	↔	FRONT R DIST	↔
CENTER DIST	↔	SURR L DIST	↔
SURR R DIST	↔	S BACK DIST	↔
S BACK L DIST	↔	S BACK R DIST	↔
EX/ES/PLIix	↔	DUAL MONO	↔
SUBWOOFER OUT	↔	CROSSOVER	↔
LFE ATT	↔	MIDNIGHT MODE	↔
DIGITAL IN 1	↔	DIGITAL IN 2	↔
DIGITAL IN 3	↔	DVD VIDEO IN	↔
VCR VIDEO IN	↔	DBS VIDEO IN	↔
(Back to the beginning)			

### 3 Press SET.

The current setting of the selected item appears.

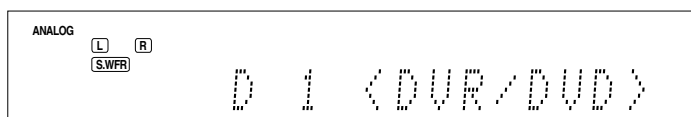

### 4 Turn MULTI JOG to select the appropriate setting.

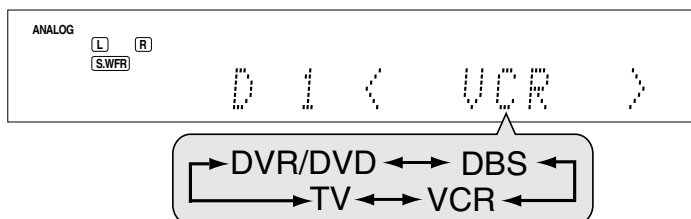

Your setting is stored.

### 5 Press SET.

### 6 Repeat steps 2 to 5 to set other items if necessary.

### 7 Press SETTING.

The source indication resumes on the display.

## Setting the speakers

To obtain the best possible surround effect from the Surround and DSP modes, register the setting about the speaker after all connections are completed.

- If you have used Quick Speaker Setup on page 20, this setting is not required.

### Setting subwoofer information—SUBWOOFER

Select whether you have connected a subwoofer or not.

<b>SUBWFR &lt;YES&gt;</b>	Select when you have connected a subwoofer. The subwoofer indicator ( <b>S.WFR</b> ) lights up on the display. You can adjust the subwoofer output level (see page 27).
<b>SUBWFR &lt;NO&gt;</b>	Select when you have disconnected a subwoofer. Selecting this changes the front speaker size to "LRG" (see below).

Initial setting: SUBWFR <NO>

### Setting the speaker size—FRONT SPK (front speakers), CENTER SPK (center speaker), SURROUND SPK (surround speakers), S BACK SPK (surround back speakers)

Register the sizes of all the connected speakers.

<b>&lt;LRG&gt; (large)</b>	Select when the cone speaker size is larger than 12 cm (4 3/4 inches).
<b>&lt;SML&gt; (small)</b>	Select when the cone speaker size is smaller than 12 cm (4 3/4 inches).
<b>&lt;NO&gt;</b>	Select when you have disconnected a speaker. (Not selectable for the front speakers.)

Initial setting: <LRG> (for the front speakers)  
<SML> (for other speakers)

### Setting the surround back speaker(s)—S BACK OUT

Register the number of surround back speaker(s).

<b>SB OUT &lt;1SPK&gt;</b>	Select when you use one surround back speaker.
<b>SB OUT &lt;2SPK&gt;</b>	Select when you use two surround back speakers.

Initial setting: SB OUT <2SPK>

#### NOTES

- If you have selected "SML (small)" for the front speaker size, you cannot select "LRG (large)" for other speakers.
- When "SUBWOOFER" is set to "SUBWFR <NO>," the front speaker size is fixed to "LRG" (and you cannot select "SML").
- When "SURROUND SPK" is set to "SML (small)," you cannot select "LRG (large)" for the surround back speaker.
- When "SURROUND SPK" is set to "NO," the surround back speaker is fixed to "NO."
- When "S BACK SPK" is set to "NO," you cannot select "S BACK OUT."
- When "SB OUT" is set to "<1SPK>," connect the surround back speaker to the left surround back speaker terminal (see page 6). No sound comes from the surround back speaker if you connect it to the right surround back speaker terminal.

## Setting the speaker distance

The distance from your listening point to the speakers is one of the important elements to obtain the best possible sound effect from the Surround/DSP modes.

By referring to the speaker distance, the receiver automatically sets the delay time of the sound through each speaker so that sounds through all the speakers can reach you at the same time.

### ■ Measuring unit—DIST UNIT

Select which measuring unit you use.

**D UNIT <meter>** Select to set the distance in meters.

**D UNIT <feet>** Select to set the distance in feet.

**Initial setting:** D UNIT <meter>

### ■ Speaker distance—

**FRONT L DIST (for the left front speaker),**  
**FRONT R DIST (for the right front speaker),**  
**CENTER DIST (for the center speaker),**  
**SURR L DIST (for the left surround speaker),**  
**SURR R DIST (for the right surround speaker),**  
**S BACK L DIST (for the left surround back speaker),**  
**S BACK R DIST (for the right surround back speaker)**

**Adjustable range:** 0.3 m to 9.0 m in 0.3 m intervals  
 (1 ft to 30 ft in 1 ft intervals)

**Initial setting:** 3.0 m (10 ft) for all speakers

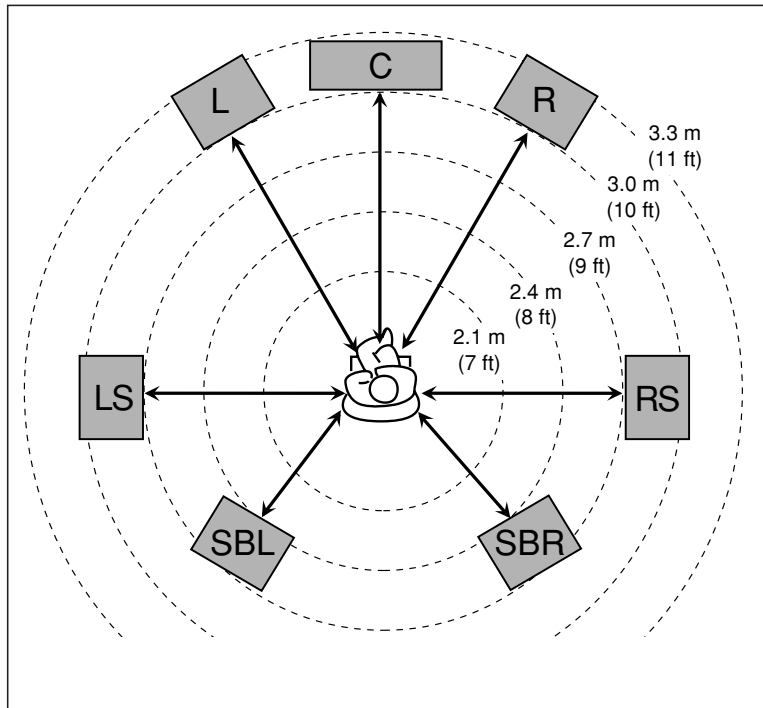

In this case, set the distance as follows:

Left front speaker (L): "FRONT L <3.0m> (10ft)"  
 Right front speaker (R): "FRONT R <3.0m> (10ft)"  
 Center speaker (C): "CENTER <3.0m> (10ft)"  
 Left surround speaker (LS): "SURR L <2.7m> (9ft)"  
 Right surround speaker (RS): "SURR R <2.7m> (9ft)"  
 Left surround back speaker (SBL): "SBACK L <2.4m> (8ft)"  
 Right surround back speaker (SBR): "SBACK R <2.4m> (8ft)"

### NOTES

- You cannot set the speaker distance for the speakers you have set to "NO."
- If you have selected "<1SPK>" for "S BACK OUT" (see page 22), "S BACK DIST" appears instead of "S BACK L DIST" and "S BACK R DIST."

## Activating the EX/ES/PLIIX setting—EX/ES/PLIIX

Depending on this setting, available Surround modes for digital multi-channel software vary—EX/ES/PLIIX reproduction or 5.1-channel reproduction. Select an appropriate setting for your enjoyment.

- For details about relation between EX/ES/PLIIX setting and available Surround mode, see page 33.
- To activate the Surround mode, see page 34.

**<AUTO>** According to the incoming signal, an appropriate Surround mode is applied.

- For Dolby Digital Surround EX and DTS-ES software, 7.1-channel reproduction is applied\*.
- For other multi-channel (4 channel or more) encoded software, 5.1-channel reproduction is applied.

**<ON>** Select to apply 7.1-channel reproduction to both 5.1-channel and 6.1-channel encoded software.

**<PLIIX MOVIE>** Select to apply PLIIX MOVIE reproduction to both 5.1-channel and 6.1-channel encoded software.

**<PLIIX MUSIC>** Select to apply PLIIX MUSIC reproduction to both 5.1-channel and 6.1-channel encoded software.

**<OFF>** Select to cancel the EX/ES/PLIIX reproduction.

**Initial setting:** <AUTO>

\* For some Dolby Digital Surround EX software, Dolby Digital 5.1-channel reproduction ("DOLBY DIGITAL") may be applied even though you have selected "<AUTO>." In this case, select "<ON>" to apply "DOLBY D EX."

### NOTES

- When "SURROUND SPK" is set to "NO" (see page 22), this function is not available.
- When "S BACK SPK" is set to "NO" (see page 22), the Virtual Surround Back (see page 33) is applied for EX/ES/PLIIX reproduction.

## Selecting the main or sub channel —DUAL MONO

You can select the playback sound (channel) you want while playing digital software recorded (or broadcasted) in Dual Mono mode (see page 31), which includes two monaural channels separately. When the receiver detects Dual mono signals, the DUAL MONO indicator lights up on the display.

**D MONO <MAIN>** Select to play back the main channel (Ch 1).  
Signal indicator “L” lights up while playing back this channel.

**D MONO <SUB>** Select to play back the sub-channel (Ch 2).  
Signal indicator “R” lights up while playing back this channel.

**D MONO <ALL>** Select to play back both the main and sub-channels (Ch 1/Ch 2).  
Signal indicators “L” and “R” light up while playing back these channels.

**Initial setting:** D MONO <MAIN>

\* Dual Mono signals can be heard from the following speakers—L (left front speaker), R (right front speaker), and C (center speaker), with respect to the current Surround setting:

Dual Mono setting	Without Surround		With Surround Activated				
			Center speaker setting				
	L	R	SML/LRG		NO		
<b>MAIN</b>	Ch 1	Ch 1	—	Ch 1	—	Ch 1	Ch 1
<b>SUB</b>	Ch 2	Ch 2	—	Ch 2	—	Ch 2	Ch 2
<b>ALL</b>	Ch 1	Ch 2	—	Ch 1+Ch 2	—	Ch 1+Ch 2	Ch 1+Ch 2

### NOTE

The Dual Mono format is not identical with bilingual broadcasting for TV programs. So this setting does not take effect while watching such bilingual programs.

## Setting bass sound

### Setting subwoofer output—SUBWOOFER OUT

The subwoofer emits the LFE signals\* and the bass elements of each speaker set to “SML.”

You can make the bass elements of the front speaker channels (MAIN) emitted through the subwoofer.

**SW <LFE>** Select to emit the LFE signals and the bass elements of each speaker set to “SML.”

**SW <LFE+MAIN>** Select to emit the bass elements of the front speakers’ channels (MAIN) when no bass elements are emitted through the subwoofer in “SW <LFE>.”

**Initial setting:** SW <LFE>

### NOTE

- When “SUBWOOFER” is set to “SUBWFR <NO>” (see page 22), this function is not available.
- \* The LFE signals are emitted only when playing the following software with the LFE signals:
  - Dolby Digital multi channel software
  - DTS multi channel software
 When playing analog source or linear PCM software, no LFE signals are emitted.

## Setting the crossover frequency—CROSSOVER

Small speakers cannot reproduce the bass sounds efficiently. If you use a small speaker in any position, this receiver automatically reallocates the bass sound elements assigned to the small speaker to the large speakers.

To use this function properly, set this crossover frequency level according to the size of the small speaker connected.

- If you have selected “LRG (large)” for all speakers (see page 22), this function will not take effect (“CROSS OFF” appears).

**CROSS <80Hz>** Select when the cone speaker unit built in the speaker is about 12 cm (4 <sup>3</sup>/<sub>4</sub> inches).

**CROSS <100Hz>** Select when the cone speaker unit built in the speaker is about 10 cm (3 <sup>15</sup>/<sub>16</sub> inches).

**CROSS <120Hz>** Select when the cone speaker unit built in the speaker is about 8 cm (3 <sup>3</sup>/<sub>16</sub> inches).

**CROSS <150Hz>** Select when the cone speaker unit built in the speaker is about 6 cm (2 <sup>3</sup>/<sub>8</sub> inches).

**CROSS <200Hz>** Select when the cone speaker unit built in the speaker is less than 5 cm (2 inches).

**Initial setting:** CROSS <100Hz>

### NOTE

Crossover frequency is not valid for the HEADPHONE and 3D HEADPHONE modes.

## Setting the low frequency effect attenuator—LFE ATT

If the bass sound is distorted while playing back software encoded with **Dolby Digital** or **DTS**, set the LFE level to eliminate distortion.

- This function takes effect only when the LFE signals come in.

**LFE <0dB>** Normally select this.

**LFE <-10dB>** Select when the bass sound is distorted.

**Initial setting:** LFE <0dB>

## Using the Midnight mode —MIDNIGHT MODE

You can enjoy a powerful sound at night using the Midnight mode. When the Midnight mode is activated, the MIDNIGHT indicator lights up on the display.

**MIDNIGHT <OFF>** Select when you want to enjoy surround with its full dynamic range. (No effect applied.)

**MIDNIGHT <1>** Select when you want to reduce the dynamic range a little.

**MIDNIGHT <2>** Select when you want to apply the compression effect fully (useful at night).

**Initial setting:** MIDNIGHT <OFF>

## Setting the digital input (DIGITAL IN) terminals—DIGITAL IN 1/2/3

When you use the digital input terminals, register what components are connected to which terminals—DIGITAL IN 1/2/3 (see page 10) so that the correct source name will appear when you select the digital source.

Select one of the following components for each terminal:

<b>DVR/DVD</b>	For the DVD player (or DVD recorder).
<b>DBS</b>	For the DBS tuner.
<b>VCR</b>	For the VCR.
<b>TV</b>	For the TV.

**Initial setting:** For "DIGITAL IN 1": DVR/DVD  
 For "DIGITAL IN 2": DBS  
 For "DIGITAL IN 3": VCR

### NOTES

- You cannot assign the same component for different terminals. The priority order for assignment is as follows:  
 "DIGITAL IN 1" > "DIGITAL IN 2" > "DIGITAL IN 3."

Ex.: When "DIGITAL IN 1" is set to "DVR/DVD."

<b>DIGITAL IN 1</b>	DVR/DVD	DBS	VCR	TV
---------------------	---------	-----	-----	----



For "DIGITAL IN 2," "DBS," "VCR," and "TV" are selectable.  
 • In this case, "VCR" is selected.

<b>DIGITAL IN 2</b>	DVR/DVD	DBS	VCR	TV
---------------------	---------	-----	-----	----



For "DIGITAL IN 3," "DBS" and "TV" are selectable.

<b>DIGITAL IN 3</b>	DVR/DVD	DBS	VCR	TV
---------------------	---------	-----	-----	----

: Selectable    : Not selectable

- Setting "DIGITAL IN 1" affects "DIGITAL IN 2" and "DIGITAL IN 3" settings. When you have changed "DIGITAL IN 1," confirm the components assigned to "DIGITAL IN 2" and "DIGITAL IN 3."

## Selecting the component video input mode—DVD VIDEO IN/VCR VIDEO IN/DBS VIDEO IN

When you use the component video inputs for connecting the DVD recorder (or DVD player), VCR, or DBS, register the type of video input jacks.

If you have not selected the appropriate video input jacks, you cannot view the playback picture on the TV or the AV COMPU LINK remote control system cannot operate properly (see page 35).

When "<S/C>" is selected for each setting, either composite or S-video signals is converted into component signals (see page 10).

### For the DVD recorder or DVD player (DVD VIDEO IN):

<b>DVD &lt;S/C&gt;</b>	Select when connecting the DVD recorder (or DVD player) to the composite video or S-video input jacks.
<b>DVD &lt;CMPNT&gt;</b>	Select when connecting the DVD recorder (or DVD player) to the component video input jacks.

**Initial setting:** DVD <CMPNT>

### For the VCR (VCR VIDEO IN):

<b>VCR &lt;S/C&gt;</b>	Select when connecting the VCR to the composite video or S-video input jacks.
<b>VCR &lt;CMPNT&gt;</b>	Select when connecting the VCR to the component video input jacks.

**Initial setting:** VCR <CMPNT>

### For the DBS (DBS VIDEO IN):

<b>DBS &lt;S/C&gt;</b>	Select when connecting the DBS to the composite video or S-video input jacks.
<b>DBS &lt;CMPNT&gt;</b>	Select when connecting the DBS to the component video input jacks.

**Initial setting:** DBS <S/C>

### NOTE

You cannot select "CMPNT" for both the VCR and the DBS at the same time. If you select "CMPNT" for the VCR, the setting for the DBS is fixed to "S/C" and vice versa.



# Sound adjustments

You can make sound adjustment to your preference after completing basic setting.

## Basic adjustment items

You can adjust the following items. See pages in parentheses for details.

- You cannot select the items which are not available with the current setting.

Items	To do
<b>SUBWFR LVL</b> *1	Adjust the subwoofer output level. (27)
<b>FRONT L LVL</b> *1*2	Adjust the left front speaker output level. (27)
<b>FRONT R LVL</b> *1*2	Adjust the right front speaker output level. (27)
<b>CENTER LVL</b> *1*2	Adjust the center speaker output level. (27)
<b>SURR L LVL</b> *1*2	Adjust the left surround speaker output level. (27)
<b>SURR R LVL</b> *1*2	Adjust the right surround speaker output level. (27)
<b>S BACK LVL</b> *1*2	Adjust the surround back speaker output level. (27)
<b>S BACK L LVL</b> *1*2	Adjust the left surround back speaker output level. (27)
<b>S BACK R LVL</b> *1*2	Adjust the right surround back speaker output level. (27)
<b>D EQ 63Hz</b> *1	Adjust the equalization pattern of each band. (27)
<b>D EQ 250Hz</b> *1	
<b>D EQ 1kHz</b> *1	
<b>D EQ 4kHz</b> *1	
<b>D EQ 16kHz</b> *1	
<b>BASS BOOST</b> *1	Boost the bass level. (28)
<b>INPUT ATT</b>	Attenuate the input level of analog source. (28)
<b>EFFECT</b> *1	Adjust the effect level. (28)
<b>ROOM SIZE</b>	Select the room size for your virtual listening room. (28)
<b>LIVENESS</b>	Select the liveness level for your virtual listening room. (28)
<b>PANORAMA</b>	Add "wraparound" sound effect with side-wall image. (28)
<b>CENTER WIDTH</b>	Adjust the center channel localization between the center speaker and the left/right speakers. (29)
<b>DIMENSION</b>	Adjust sound localization pattern. (29)
<b>CENTER GAIN</b>	Adjust the sound localization of the center channel. (29)
<b>CENTER TONE</b> *1	Make the center tone soft or sharp. (29)
<b>CENTER ALIGN</b>	Align the vertical localization of the center channel signals. (29)

\*1 You can also use the remote control for the adjustment.

\*2 If you have used Quick Speaker Setup on page 20, these settings are not required.

## Operating procedure

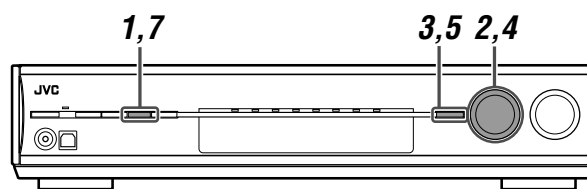

### On the front panel:

#### Before you start, remember...

There is a time limit in doing the following steps. If the setting is canceled before you finish, start from step **1** again.

Ex.: When adjusting subwoofer output level.

#### 1 Press ADJUST.

MULTI JOG now works for the sound adjustment.

#### 2 Turn MULTI JOG until the item you want to adjust appears on the display.

- As you turn MULTI JOG, the adjustment items change as follows:

ANALOG		L	R
		(S.WFR)	
SUBWFR LVL			
SUBWFR LVL	↔	FRONT L LVL	↔
FRONT R LVL	↔	CENTER LVL	↔
SURR L LVL	↔	SURR R LVL	↔
S BACK LVL	↔	S BACK L LVL	↔
S BACK R LVL	↔	D EQ 63Hz	↔
D EQ 250Hz	↔	D EQ 1kHz	↔
D EQ 4kHz	↔	D EQ 16kHz	↔
BASS BOOST	↔	INPUT ATT	↔
EFFECT	↔	ROOM SIZE	↔
LIVENESS	↔	PANORAMA	↔
CENTER WIDTH	↔	DIMENSION	↔
CENTER GAIN	↔	CENTER TONE	↔
CENTER ALIGN	↔	(Back to the beginning)	

#### 3 Press SET.

The current setting for the selected item appears.

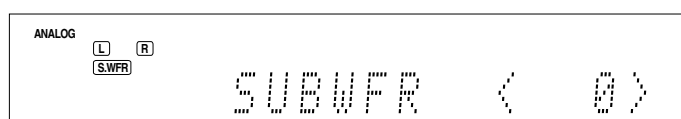

#### 4 Turn MULTI JOG to adjust the selected item.

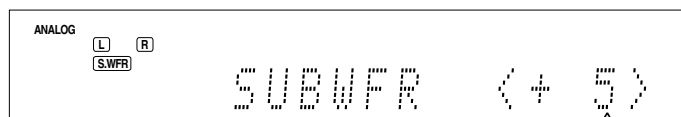

-10 ↔ 0 ↔ +10

Your adjustment is stored.

#### 5 Press SET.

#### 6 Repeat steps 2 to 5 to adjust other items if necessary.

#### 7 Press ADJUST.

The source indication resumes on the display.



## Adjusting the speaker output levels

- SUBWFR LVL (subwoofer output level),
- FRONT L LVL (left front speaker output level),
- FRONT R LVL (right front speaker output level),
- CENTER LVL (center speaker output level),
- SURR L LVL (left surround speaker output level),
- SURR R LVL (right surround speaker output level),
- S BACK L LVL (left surround back speaker output level),
- S BACK R LVL (right surround back speaker output level)

You can adjust the speaker output levels.

Adjust all the speakers' output levels so that you can listen to the sounds from all the speakers at the same level.

- Once you have made an adjustment, it is memorized for each source.

**Adjustable range:** -10 (dB) to +10 (dB) (in 1 step intervals)

**Initial setting:** 0 (dB) for all speakers

### NOTES

- If you have selected "NO" for a speaker (see page 22), the output level for the corresponding speaker is not adjustable.
- If you have selected "<1SPK>" for "S BACK OUT" (see page 22), "S BACK LVL" appears instead of "S BACK L LVL" and "S BACK R LVL."
- While using the headphones, you can adjust only the left and right front speakers' output level.

### From the remote control:

#### 1 Press TEST to check the speakers' output balance.

"TEST FL" starts flashing on the display, and a test tone comes out of the speakers clockwise.

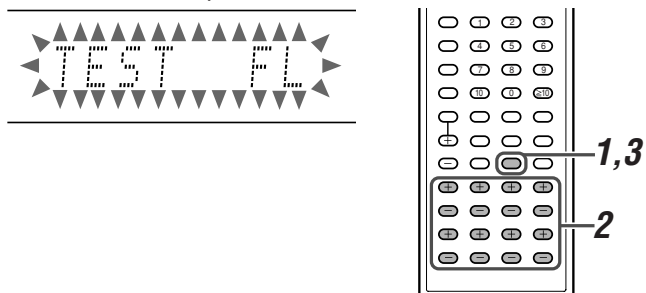

- You can adjust the speaker output levels without the test tone.

#### 2 Adjust the speaker output levels.

Press the + or - button corresponding to the speaker you want to adjust.

#### 3 Press TEST again to stop the test tone.

### NOTES

- No test tone comes out of the speakers for which the speaker setting is set to "NO" (see page 22).
- No test tone is available when the headphones are in use.
- If you have selected "<1SPK>" for "S BACK OUT" (see page 22), press + or - button for L - S. BACK to adjust the output level.

## Adjusting the equalization patterns— D EQ 63Hz/250Hz/1kHz/4kHz/16kHz

You can adjust equalization patterns in five frequency bands (center frequency: 63 Hz, 250 Hz, 1 kHz, 4 kHz, 16 kHz) for the front speakers.

- Once you have made an adjustment, it is memorized for each source.

**Adjustable range:** -8 (dB) to +8 (dB) (in 2 dB intervals)

**Initial setting:** 0 (dB) for all bands

- When adjustment is made, the DIGITAL EQ indicator lights up on the display.

**If no adjustment is required,** set all the frequency bands to "0 (dB)."

- The DIGITAL EQ indicator goes off from the display.

### From the remote control:

#### Before you start, remember...

There is a time limit in doing the following steps. If the setting is canceled before you finish, start from step 1 again.

- 1 Press D. EQ FREQ repeatedly to select the band you want to adjust.
- 2 Press D. EQ LEVEL + or - to adjust the equalization pattern of the selected band.
- 3 Repeat steps 1 and 2 to adjust other bands.

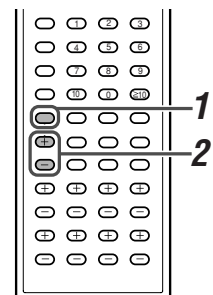

## Adjusting the bass sounds

### Reinforcing the bass—BASS BOOST

You can boost the bass level—Bass Boost.

- Once you have made an adjustment, it is memorized for each source.

---

**B BOOST <ON>** Select to boost the bass level.  
The B.BOOST indicator lights up on the display.

---

**B BOOST <OFF>** Select to deactivate the Bass Boost.

---

**Initial setting:** B BOOST <OFF>

#### NOTE

This function affects only the sound coming out through the front speakers.

#### From the remote control:

Press B.BOOST to select either one of the above.

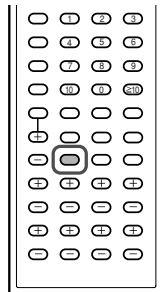

### Attenuating the input signal—INPUT ATT

When the input level of the **analog source** is too high, the sound will be distorted. If this happens, you need to attenuate the input signal level to prevent the sound distortion.

- Once you have made an adjustment, it is memorized for each source.
- You cannot use the remote control for this setting.

---

**ATT <ON>** Select to attenuate the input signal level.  
The INPUT ATT indicator lights up on the display.

---

**ATT <NORMAL>** Select to deactivate attenuation.

---

**Initial setting:** ATT <NORMAL>

## Adjusting the sound parameters for the Surround/DSP modes

You can adjust the Surround/DSP sound parameters to your preference.

- For details about the Surround/DSP modes, see pages 30 to 34.

### Adjusting the effect level for DSP modes—EFFECT

This setting is available only when one of the DSP modes (except ALL CH STEREO) is in use. To activate DSP mode, see page 34.

- Once you have made an adjustment, it is memorized for each DSP mode.

**Adjustable range:** 1 to 5 (in 1 step intervals)

**Initial setting:** EFFECT <3>

As the number increases, the effect becomes stronger.  
Normally, select “3.”

#### From the remote control:

Press EFFECT to select the level you want to adjust.

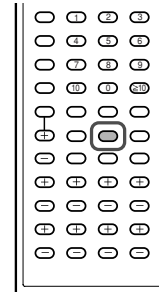

### Adjusting the virtual room size for DSP modes—ROOM SIZE

This setting is available only when one of the DSP modes (except ALL CH STEREO) is in use. To activate DSP mode, see page 34.

- If “SURROUND SPK” is set to “<NO>” (see page 22), this item is not adjustable.
- Once you have made an adjustment, it is memorized for each DSP mode.
- You cannot use the remote control for this setting.

**Adjustable range:** 1 to 5 (in 1 step intervals)

**Initial setting:** ROOM SIZE <3>

As the number increases, the interval between reflections increases so that you will feel as if you were in a larger room.  
Normally, select “3.”

### Adjusting the liveness effect for DSP modes—LIVENESS

This setting is available only when one of the DSP modes (except ALL CH STEREO) is in use. To activate DSP mode, see page 34.

- If “SURROUND SPK” is set to “<NO>” (see page 22), this item is not adjustable.
- Once you have made an adjustment, it is memorized for each DSP mode.
- You cannot use the remote control for this setting.

**Adjustable range:** 1 to 5 (in 1 step intervals)

**Initial setting:** LIVENESS <3>

As the number increases, the attenuation level of reflections over time decreases so that acoustics change from “Dead” to “Live.”  
Normally, select “3.”

### Adjusting the panorama control for Pro Logic IIx Music and Pro Logic II Music—PANORAMA

This setting is available when Pro Logic IIx Music or Pro Logic II Music is activated for the analog or digital 2-channel sound signal. To activate Pro Logic IIx Music or Pro Logic II Music, see page 34.

- Once you have made an adjustment, it is memorized until you change the setting.
- You cannot use the remote control for this setting.

---

**PANORAMA <ON>** Select to add “wraparound” sound effect with side-wall image.

---

**PANORAMA <OFF>** Select to listen to originally recorded sound.

---

**Initial setting:** PANORAMA <OFF>

## Adjusting the center channel localization for Pro Logic IIx Music and Pro Logic II Music—CENTER WIDTH

This setting is available when Pro Logic IIx Music or Pro Logic II Music is activated for the analog or digital 2-channel sound signal. To activate Pro Logic IIx Music or Pro Logic II Music, see page 34.

- If “CENTER SPK” is set to “NO” (see page 22), this item is not adjustable.
- Once you have made an adjustment, it is memorized until you change the setting.
- You cannot use the remote control for this setting.

**Adjustable range:** OFF and 1 to 7 (in 1 step intervals)

**Initial setting:** C WIDTH <3>

As the number increases, the center channel sound moves toward the left and right speakers.

Normally, select “3.”

## Adjusting the sound localization position for Pro Logic IIx Music and Pro Logic II Music—DIMENSION

This setting is available when Pro Logic IIx Music or Pro Logic II Music is activated for the analog or digital 2-channel sound signal. To activate Pro Logic IIx Music or Pro Logic II Music, see page 34.

- Once you have made an adjustment, it is memorized until you change the setting.
- You cannot use the remote control for this setting.

**Adjustable range:** 1 to 7 (in 1 step intervals)

**Initial setting:** DIMENSION <4>

As the number increases, the sound localization moves towards forward from backward.

Normally, select “4.”

## Adjusting the sound localization of the center channel—CENTER GAIN

This setting is available only when Neo:6 Music is in use.

- If “CENTER SPK” is set to “NO” (see page 22), this item is not adjustable.
- Once you have made an adjustment, it is memorized until you change the setting.
- You cannot use the remote control for this setting.

**Adjustable range:** 0 to 1.0 (in 0.1 step intervals)

**Initial setting:** C GAIN <0.3>

As the number increases, the center channel will be localized clearly.

Normally, select “0.3.”

## Adjusting the center tone—CENTER TONE

This setting is available when one of the Surround/DSP modes is in use. To activate Surround/DSP mode, see page 34.

- If “CENTER SPK” is set to “NO” (see page 22), this item is not adjustable.
- This setting is common to all Surround modes, and is memorized separately for DSP modes.

**Adjustable range:** 1 to 5 (in 1 step intervals)

**Initial setting:** C TONE <3>

As the number increases, the dialogue becomes stronger.

Normally, select “3.”

- When the center tone is set to other than “C TONE <3>,” the C.TONE indicator lights up on the display.

### From the remote control:

Press C.TONE to select the level you want to adjust.

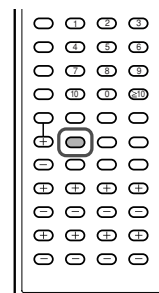

## Aligning the vertical localization of the center channel for Surround/DSP modes—CENTER ALIGN

This setting is available when one of the Surround/DSP modes (except PLIIX MUSIC, PLII MUSIC, NEO:6 MUSIC, and ALL CH STEREO) is in use. To activate Surround/DSP mode, see page 34.

- If “CENTER SPK” is set to “NO” (see page 22), this item is not adjustable.
- This setting is common to all Surround modes, and is memorized separately for DSP modes.
- You cannot use the remote control for this setting.

---

**C ALIGN <ON>** Select this when you cannot feel as if the actors or singers are speaking or singing on the screen.

---

**C ALIGN <OFF>** Center alignment is turned off.

---

**Initial setting:** C ALIGN <OFF>

# Creating realistic sound fields

## Reproducing theater ambience

In a movie theater, many speakers are located on the walls to reproduce impressive multi-channel sound, reaching you from all directions.

With these many speakers, sound localization and sound movement can be expressed.

Surround/DSP modes built in this receiver can create almost the same Surround sound as you can feel in a real movie theater.

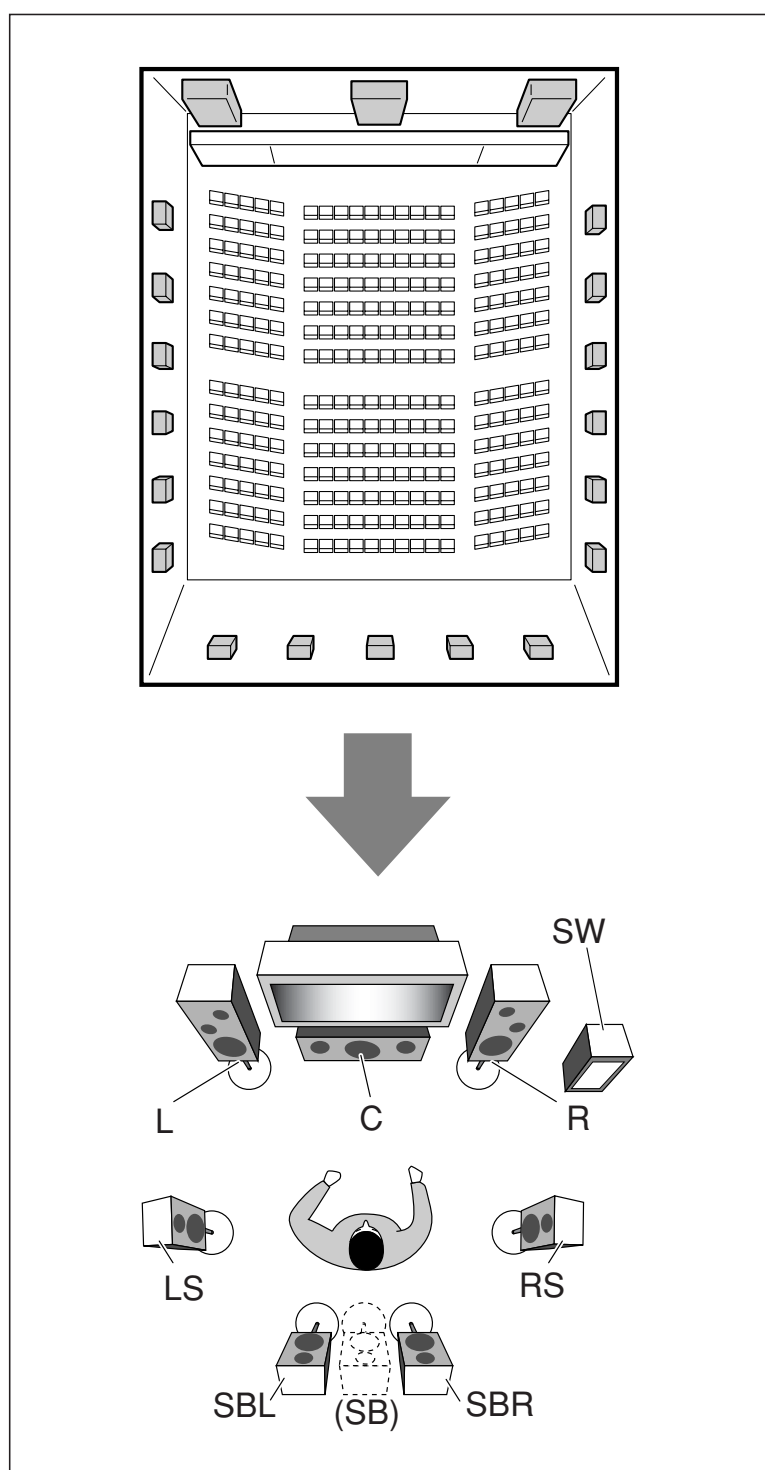

## Introducing the Surround modes

### ■ Dolby Digital\*

Dolby Digital is a digital signal compression method, developed by Dolby Laboratories, and enables multi-channel encoding and decoding.

- When Dolby Digital signal is detected through the digital input, the  DIGITAL indicator lights up on the display.

### Dolby Digital 5.1CH

**Dolby Digital 5.1CH** (DOLBY DIGITAL) encoding method records and digitally compresses the left front channel, right front channel, center channel, left surround channel, right surround channel, and LFE channel signals (total 6 channels, but the LFE channel is counted as 0.1 channel. Therefore, called 5.1 channel).

Dolby Digital enables stereo surround sounds, and sets the cutoff frequency of the surround treble at 20 kHz, compared to 7 kHz for Dolby Pro Logic. As such, the sound movement and “being-there” feeling are enhanced much more than Dolby Pro Logic.

### Dolby Digital EX

**Dolby Digital EX** (DOLBY D EX) is a digital surround encoding format that adds the third surround channels, called “surround back.”

Compared to the conventional Dolby Digital 5.1CH, these newly added surround back channels can reproduce more detailed movements behind you while viewing the video software. In addition, surround sound localization will become more stable.

### ■ Dolby Surround

#### Dolby Pro Logic II

**Dolby Pro Logic II** is a multi-channel playback format to convert 2-channel software into 5-channel (plus subwoofer). The matrix-based conversion method used for Dolby Pro Logic II makes no limitation for the cutoff frequency of the surround treble and enables stereo surround sound.

- This receiver provides three types of Dolby Pro Logic II modes—**Pro Logic II Movie** (PLII MOVIE), **Pro Logic II Music** (PLII MUSIC), and **Pro Logic II Game** (PLII GAME).  
When Dolby Pro Logic II is activated, the  PLII indicator lights up on the display.

**PLII MOVIE** Suitable for playing any Dolby Surround encoded software. You can enjoy a sound field very close to the one created with discrete 5.1-channel sounds.

**PLII MUSIC** Suitable for playing any 2-channel stereo software. You can enjoy wide and deep sounds.

**PLII GAME** Suitable for playing a video game. You can enjoy sounds with “being there” feeling.

\* Manufactured under license from Dolby Laboratories. “Dolby”, “Pro Logic”, and the double-D symbol are trademarks of Dolby Laboratories.



## Dolby Pro Logic IIx

**Dolby Pro Logic IIx** is a newly introduced multi-channel playback format to convert not only multi-channel software but 2-channel software into 7.1 channel (or 6.1 channel) that developed from Dolby Pro Logic II. The matrix-based conversion method used for Dolby Pro Logic IIx makes no limitation for the cutoff frequency of the surround treble.

- This receiver provides three types of Dolby Pro Logic IIx modes—**Pro Logic IIx Movie** (PLIIx MOVIE), **Pro Logic IIx Music** (PLIIx MUSIC), and **Pro Logic IIx Game** (PLIIx GAME). When Dolby Pro Logic IIx is activated, “PLIIx MOVIE,” “PLIIx MUSIC,” or “PLIIx GAME” appear and the **PL IIx** indicator lights up on the display.

---

**PLIIx MOVIE** Suitable for playing any Dolby Surround encoded software. You can enjoy a sound field with a natural wraparound effect.

---

**PLIIx MUSIC** Suitable for playing any 2-channel stereo software. You can enjoy wide and deep 7.1-channel sounds.

---

**PLIIx GAME** Suitable for playing a video game. You can enjoy 7.1-channel sounds with “being there” feeling. This model is available for both an analog and digital 2-channel signal.

---

- To enjoy software encoded with Dolby Digital, connect the source component using the digital terminal on the rear of this receiver. (See page 10.)

## ■ DTS\*\*

DTS is another digital signal compression method, developed by Digital Theater Systems, Inc., and enables multi-channel encoding and decoding (1ch up to 6.1ch).

- When DTS signal is detected through the digital input, the **dts** indicator lights up on the display.

## DTS Digital Surround

**DTS Digital Surround** (DTS) is another discrete 5.1 channel digital audio format available on CD, LD, and DVD software. Compared to Dolby Digital, the DTS Digital Surround format has a lower audio compression rate which enables it to add breadth and depth to the sounds reproduced. As such, DTS Digital Surround features natural, solid, and clear sound.

## DTS Extended Surround (DTS-ES)

**DTS-ES** is another multi-channel digital encoding format. It greatly improves the 360-degree surround impression and space expression by adding the third surround channel—surround back channel.

DTS-ES includes two signal formats with different surround signal recording methods—**DTS-ES Discrete 6.1ch** (ES DISCRETE) and **DTS-ES Matrix 6.1ch** (ES MATRIX).

**DTS-ES Discrete 6.1ch** has been designed to encode (and decode) a 6.1-channel signal discretely to avoid interference with each channel.

**DTS-ES Matrix 6.1ch** has been designed to add an extra surround channel to DTS Digital Surround 5.1-channel. By using a matrix encoding/decoding method, an additional “surround back” channel signal is encoded (and decoded) in both the left and right surround channel signals.

## DTS 96/24

In recent years, there has been increasing interest in higher sampling rates both for recording and for reproducing at home. Higher sampling rates allow wider frequency range and greater bit depths provide extended dynamic range.

**DTS 96/24** is a multi-channel digital signal format (fs 96 kHz/24 bits) introduced by Digital Theater Systems, Inc. to deliver “better-than-CD sound quality” into the home.

- When DTS 96/24 signal is detected, the **dts** and 96/24 indicators light up. You can enjoy its 5.1-channel sound with full-quality.

## DTS Neo:6

**DTS Neo:6** is another conversion method to create 6-channel (plus subwoofer) from analog/digital 2-channel software by using the high precision digital matrix decoder used for DTS-ES Matrix 6.1ch.

- This receiver provides the following DTS Neo:6 modes—**Neo:6 Cinema** (NEO:6 CINEMA) and **Neo:6 Music** (NEO:6 MUSIC). When one of them is activated, the NEO:6 indicator lights up on the display.

---

**NEO:6 CINEMA** Suitable for playing movies. You can get the same atmosphere with 2-channel software as with 6.1-channel software. It is also effective for playing software encoded with conventional surround formats.

---

**NEO:6 MUSIC** Suitable for playing music software. The front channel signals bypass the decoder (resulting in no loss of sound quality) and the surround signals transmitted through the other speakers expand the sound field naturally.

---

\*\* “DTS”, “DTS-ES”, “Neo:6” and “DTS 96/24” are trademarks of Digital Theater Systems, Inc.

**When using Surround mode, the sounds come out of the activated speakers which the Surround mode requires.**

- If either “**SURROUND SPK**” or “**CENTER SPK**” is set to “<NO>” in the speaker setting (see page 22), the corresponding channel signals are allocated to and emitted through the front speakers.
- If both “**SURROUND SPK**” and “**CENTER SPK**” are set to “<NO>” in the speaker setting (see page 22), JVC’s original 3D-PHONIC processing (which has been developed to create the surround effect through the front speakers only) is used. The 3D-PHONIC indicator lights up on the display.

## 3D HEADPHONE mode

If you connect a pair of headphones while one of the Surround modes is in use, the 3D HEADPHONE mode is activated regardless of the type of software played back. “3D HEADPHONE” appears on the display and the DSP and HEADPHONE indicators light up.

## About other digital signals

### Linear PCM

Uncompressed digital audio data used for DVDs, CDs, and Video CDs.

DVDs support 2 channels with sampling rates of 48/96 kHz, at quantization of 16/20/24 bits. On the other hand, CDs and Video CDs are limited to 2 channels with 44.1 kHz at 16 bits.

- When Linear PCM signal is detected, the LINEAR PCM indicator lights up.

### Dual Mono

Dual Mono can be easily understood when you think of the bilingual broadcast for TV programs (however, the Dual Mono format is not identical with those analog formats).

This format is now adopted in Dolby Digital, DTS, and so on. It allows two independent channels (called main channel and sub-channel) to be recorded separately.

- You can select either channel you want to listen to (see page 24).



## Introducing the DSP modes

The sound heard in a concert hall, club, etc. consists of direct sound and indirect sound—early reflections and reflections from behind. Direct sounds reach the listener directly without any reflection. On the other hand, indirect sounds are delayed by the distances of the ceiling and walls. These direct sounds and indirect sounds are the most important elements of the acoustic surround effects.

The DSP modes can create these important elements, and give you a real “being there” feeling.

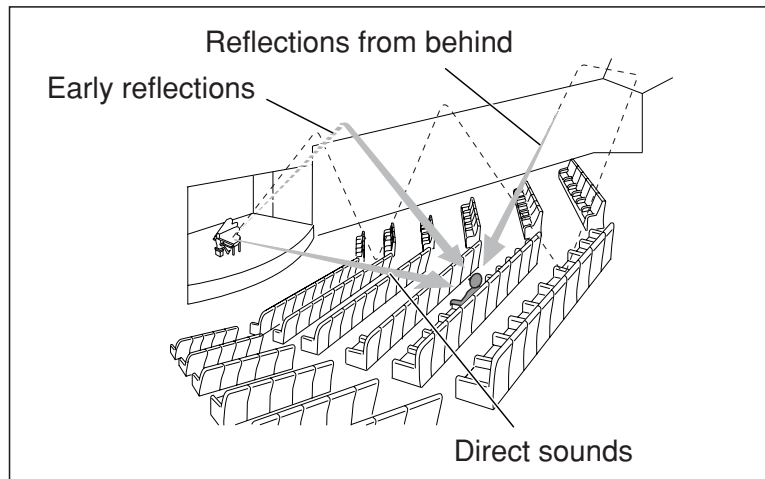

The DSP modes include the following modes:

- Digital Acoustic Processor (DAP) modes—HALL1, HALL2, LIVE CLUB, DANCE CLUB, PAVILION, THEATER1, THEATER2
- MONO FILM—Used for all types of 2-channel signals (including Dual Mono signal)
- All Channel Stereo mode (ALL CH STEREO)

When one of the DSP modes is activated, the DSP indicator lights up on the display.

### ■ Digital Acoustic Processor (DAP) modes

You can use the following DAP modes in order to reproduce a more acoustic sound field in your listening room.

<b>HALL1</b>	Reproduces the spatial feeling of a large shoebox-shaped hall designed primarily for classical concerts. (Its seating capacity is about 2000.)
<b>HALL2</b>	Reproduces the spatial feeling of a large vineyard-shaped hall designed primarily for classical concerts. (Its seating capacity is about 2000.)
<b>LIVE CLUB</b>	Reproduces the spatial feeling of a live music club with a low ceiling.
<b>DANCE CLUB</b>	Reproduces the spatial feeling of a rocking dance club.
<b>PAVILION</b>	Reproduces the spatial feeling of an exhibition hall with a high ceiling.
<b>THEATER1</b>	Reproduces the spatial feeling of a large theater where the seating capacity is about 600.
<b>THEATER2</b>	Reproduces the spatial feeling of a small theater where the seating capacity is about 300.

#### NOTE

When “THEATER1” or “THEATER2” is activated while playing back 2-channel analog or digital source, the built-in Dolby Pro Logic II decoder is activated and the **PL II** indicator lights up.

When using the DAP mode, the sounds come out of all the connected and activated speakers.

- If “SURROUND SPK” is set to “<NO>” in the speaker setting (see page 22), JVC’s original 3D-PHONIC processing (which has been developed to create the surround effect through the front speakers only) is used. The 3D-PHONIC indicator lights up on the display.

### ■ MONO FILM

In order to reproduce a more acoustic sound field in your listening room while viewing monaural sound video software (analog and 2-channel digital signals including Dual Mono signal), you can use this mode.

The surround effect will be added, and the sound localization of actor’s words will be improved.

**This mode cannot be used for multi-channel digital signals.**

When “MONO FILM” is used, sounds come out of all the connected (and activated) speakers.

- If “SURROUND SPK” is set to “<NO>” in the speaker setting (see page 22), JVC’s original 3D-PHONIC processing (which has been developed to create the surround effect through the front speakers only) is used. The 3D-PHONIC indicator lights up on the display.
- If incoming signals change from 2-channel digital signal to another digital signal type, “MONO FILM” is canceled and an appropriate Surround mode is activated.

### ■ All Channel Stereo mode (ALL CH STEREO)

This mode can reproduce a larger stereo sound field using all the connected (and activated) speakers. **This mode cannot be used if “SURROUND SPK” is set to “<NO>” in the speaker setting (see page 22).**

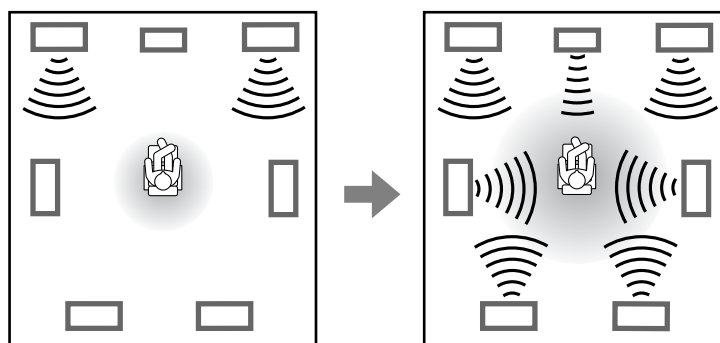

Sound reproduced from normal stereo

Sound reproduced from All Channel Stereo mode

# Using the Surround/DSP modes

Available Surround/DSP modes vary depending on the speaker settings and the incoming signals. See the table below.

- The numbers inside the parentheses following the incoming signal type indicate the number of the front channels and that of the surround channels. For example, (3/2) indicates that the signals are encoded with three front signals (left/right/center) and two (stereo) surround signals.
- For EX/ES/PLIIX setting, see page 23.

Incoming Signal Type		EX/ES/PLIIX setting				
		AUTO	ON	PLIIX MOVIE	PLIIX MUSIC	OFF
Dolby Digital	Dolby Digital Surround EX	DOLBY D EX*3,5	DOLBY D EX*3	ⓧ D+PLIIX MOVIE*2,3	ⓧ D+PLIIX MUSIC*3	DOLBY DIGITAL
	Dolby Digital (3/2, 2/2)	DOLBY DIGITAL	DOLBY D EX*3	ⓧ D+PLIIX MOVIE*2,3	ⓧ D+PLIIX MUSIC*3	DOLBY DIGITAL
	Dolby Digital (3/1, 2/1, 3/0, 1/0)	DOLBY DIGITAL				
	Dolby Digital (Dual Mono)	DUAL MONO				
DTS	DTS-ES Discrete*1	DTS-ES DSCRT*3	DTS-ES DSCRT*3	DTS+PLIIX MOVIE*2,3	DTS+PLIIX MUSIC*3	DTS SURROUND
	DTS-ES Matrix*1	DTS-ES MATRIX*3	DTS-ES MATRIX*3	DTS+PLIIX MOVIE*2,3	DTS+PLIIX MUSIC*3	DTS SURROUND
	DTS (3/2, 2/2)*1	DTS SURROUND	DTS+NEO:6*3	DTS+PLIIX MOVIE*2,3	DTS+PLIIX MUSIC*3	DTS SURROUND
	DTS (3/1, 2/1, 3/0, 1/0)	DTS				
	DTS (Dual Mono)	DUAL MONO				
Analog/LINEAR PCM Dolby Digital (2/0)		PLIIX MOVIE*4/ PLIIX MUSIC*4/ PLIIX GAME*4/ NEO:6 CINEMA/ NEO:6 MUSIC			PLII MOVIE/ PLII MUSIC/ PLII GAME/ NEO:6 CINEMA/ NEO:6 MUSIC	

\*1 DTS 96/24 processing is not applied when the EX/ES/PLIIX setting is activated. If you want to apply the processing, set the EX/ES/PLIIX setting to "OFF" (see page 23).

\*2 When "S BACK OUT" is set to "<1SPK>," ⓧ D+PLIIX MOVIE is changed to DOLBY D EX and DTS+PLIIX MOVIE is changed to DTS+ⓧ EX.

\*3 When "S BACK SPK" is set to "<NO>," Virtual Surround Back is activated for the modes and the VIRTUAL SB indicator lights up on the display.

\*4 When "S BACK SPK" is set to "<NO>," PLIIX MOVIE, PLIIX MUSIC, and PLIIX GAME are changed to PLII MOVIE, PLII MUSIC, and PLII GAME respectively.

\*5 For some Dolby Digital Surround EX software, Dolby Digital 5.1-channel reproduction ("DOLBY DIGITAL") may be applied even though you have selected "<AUTO>." In this case, select "<ON>" to apply "DOLBY D EX."

## About the DSP modes

- The following DSP modes are available regardless of incoming signal type.  
HALL1, HALL2, LIVE CLUB, DANCE CLUB, PAVILION, THEATER1, THEATER2
- If an incoming signal is a multi-channel (2 channel or more) digital signal, "MONO FILM" is not available.
- If "SURROUND SPK" is set to "<NO>," "ALL CH STEREO" is not available.

### Virtual Surround Back

This function creates a great surround effect from behind as if you have connected the surround back speaker. The VIRTUAL SB (Surround Back) indicator lights up on the display.

If you have connected (and activated) the surround speakers, you can use Virtual Surround Back without connecting the surround back speaker.

Virtual Surround Back is activated when EX/ES/PLIIX is set to other than "<OFF>" and when playing back the software including the following signals:

- Dolby Digital Surround EX
- DTS-ES
- Dolby Digital or DTS with 4 channel or more

# Activating the Surround/DSP modes

Available Surround/DSP modes vary depending on the speaker settings and the incoming signals. For details, see page 33.

**Activating one of the Surround/DSP modes automatically recalls the memorized settings and adjustments.**

- To adjust the speaker output level, see page 27.
- When activating one of the Surround/DSP modes, you can adjust CENTER TONE. (see page 29)
- When activating one of the Surround/DSP modes (except PLIIx MUSIC, PLII MUSIC, NEO:6 MUSIC, and ALL CH STEREO), you can adjust CENTER ALIGN. (see page 29)
- When activating NEO:6 MUSIC, you can adjust CENTER GAIN. (see page 29)
- When activating the DSP mode (except ALL CH STEREO), you can adjust the following settings:
  - EFFECT (see page 28)
  - LIVENESS (see page 28)
  - ROOM SIZE (see page 28)
- When activating "PLIIx MUSIC" and "PLII MUSIC," you can adjust the following settings:
  - CENTER WIDTH (see page 29)
  - DIMENSION (see page 29)
  - PANORAMA (see page 28)

## Selecting the Surround/DSP modes

### From the remote control:

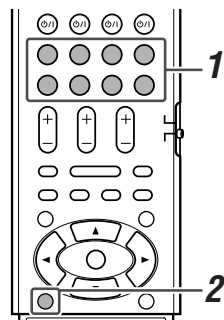

#### 1 Select and play any source.

- Make sure you have selected the input mode (analog or digital) correctly.

#### 2 Press SURROUND repeatedly to select the Surround/DSP mode you want.

Ex.: When "DOLBY DIGITAL" is selected for Dolby Digital multi-channel software:

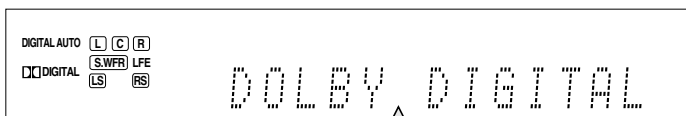

AUTO SURROUND\*1 → Surround modes\*2 →  
 HALL1 → HALL2 → LIVE CLUB → DANCE CLUB  
 → PAVILION → THEATER1 → THEATER2 →  
 MONO FILM\*3 → ALL CH STEREO\*4 →  
 SURROUND OFF → (Back to the beginning)

- \*1 "AUTO SURROUND" is the initial setting.
- \*2 Available Surround modes vary depending on the speaker settings and the incoming signals. For details, see page 33.
- \*3 If an incoming signal is a multi-channel (2 channel or more) digital signal, "MONO FILM" is not available.
- \*4 If "SURROUND SPK" is set to "<NO>," "ALL CH STEREO" is not available.

#### To cancel Surround/DSP modes

Press SURROUND repeatedly so that "SURROUND OFF" appears on the display.

### On the front panel:

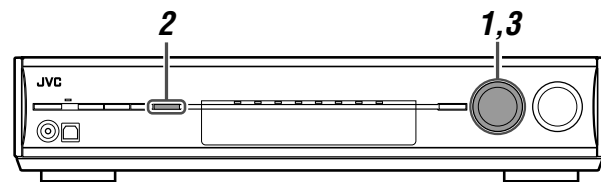

#### Before you start, remember...

There is a time limit in doing the following steps. If the setting is canceled before you finish, start from step 2 again.

#### 1 Select and play any source.

- Make sure you have selected the input mode (analog or digital) correctly.

#### 2 Press SURROUND.

MULTI JOG now works for selecting Surround/DSP modes.

#### 3 Turn MULTI JOG to select the Surround/DSP mode you want.

Ex.: When "DOLBY DIGITAL" is selected for Dolby Digital multi-channel software:



AUTO SURROUND\*1 ↔ Surround modes\*2 ↔  
 HALL1 ↔ HALL2 ↔ LIVE CLUB ↔ DANCE CLUB  
 ↔ PAVILION ↔ THEATER1 ↔ THEATER2 ↔  
 MONO FILM\*3 ↔ ALL CH STEREO\*4 ↔  
 SURROUND OFF ↔ (Back to the beginning)

- \*1 "AUTO SURROUND" is the initial setting.
- \*2 Available Surround modes vary depending on the speaker settings and the incoming signals. For details, see page 33.
- \*3 If an incoming signal is a multi-channel (2 channel or more) digital signal, "MONO FILM" is not available.
- \*4 If "SURROUND SPK" is set to "<NO>," "ALL CH STEREO" is not available.

#### To cancel Surround/DSP modes

Turn MULTI JOG so that "SURROUND OFF" appears on the display.

#### When you select "AUTO SURROUND"

You can enjoy the Surround mode easily.

- For details about the Surround modes, see page 33.
- When "AUTO SURROUND" is activated, the AUTO SURR indicator lights up on the display.

#### How does "AUTO SURROUND" work?

- If a multi-channel signal comes in, an appropriate Surround mode will be selected automatically.
- If a Dolby Digital 2-channel signal with surround signal comes in, "PLIIx MOVIE" or "PLII MOVIE" will be selected.
- If a Dolby Digital 2-channel signal without surround signal comes in, "SURROUND OFF (stereo)" will be selected.
- If a Linear PCM signal comes in, "SURROUND OFF (stereo)" will be selected.

#### NOTE

"AUTO SURROUND" does not take effect in the following cases:

- While playing an analog source,
- While selecting one of the fixed digital input mode—"DOLBY DIGITAL" or "DTS" (see page 12).

# AV COMPU LINK remote control system

The AV COMPU LINK remote control system allows you to operate JVC's video components (TV, DVD player\*, and VCR) through this receiver.

This receiver is equipped with the AV COMPU LINK-III, which has added a function to operate JVC's video components through the component video jacks. To use this remote control system, you need to connect the video components you want to operate, following the diagrams below and the procedures on page 36.

- Refer also to the manuals supplied with your video components.

\* "DVD player" on pages 35 and 36 can be replaced with "DVD recorder."

## Connections 1: AV COMPU LINK connection

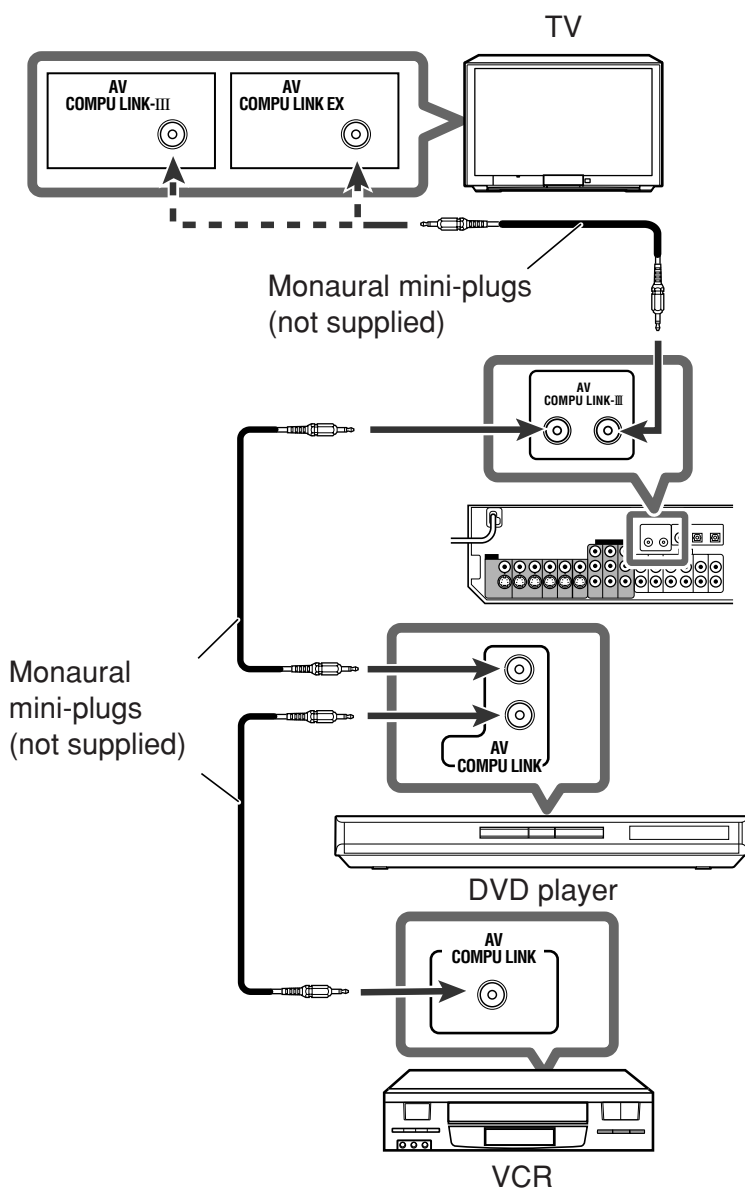

### IMPORTANT:

The AV COMPU LINK remote control system cannot control the DBS tuner connected to the DBS IN jacks.

### NOTES

- When connecting the receiver and a TV with the AV COMPU LINK EX terminal by using a component video cable, you cannot use Automatic selection of TV's input mode (see page 36).
- When connecting only the VCR or DVD player to this receiver, connect it directly to the receiver using cable with the monaural mini-plugs.
- You can connect only the TV with AV COMPU LINK EX or AV COMPU LINK-III terminal to the AV COMPU LINK-III terminal.

## Connections 2: Video cable connection

This receiver is equipped with three types of video terminals—composite video, S-video, and component video, and the signals coming into this receiver through one type of video terminals can output only through the terminal of the same type. So you need to connect the video components to this receiver using one of the following three ways.

- When using the AV COMPU LINK remote control system, set the video input for the DVD player and the VCR correctly (see "Selecting the component video input mode—DVD VIDEO IN/ VCR VIDEO IN/DBS VIDEO IN" on page 25); otherwise, the correct input for this receiver will not be selected on the TV.

### Case 1:

When connecting the source equipment to the receiver through the S-video terminals, connect this receiver to the TV's video input 1 terminal using S-video cables.

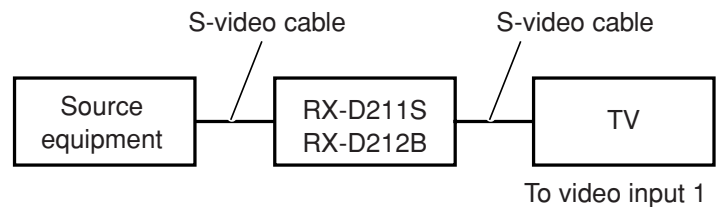

### Case 2:

When connecting the source equipment to the receiver through the composite video jacks, connect this receiver to the TV's video input 2 terminal (composite video input) using composite video cables.

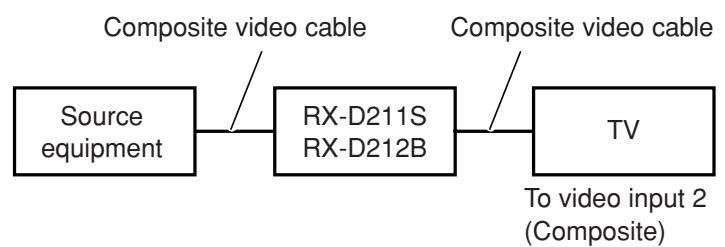

### Case 3:

When connecting the source equipment to the receiver through the component video jacks, connect this receiver to the TV's video input 2 terminals (component video input) using component video cables.

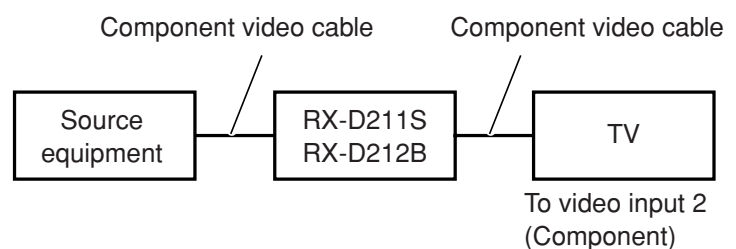



## Connecting procedure

- 1 If you have already plugged your VCR, DVD player, TV, or this receiver into the AC outlets, unplug their AC power cords first.**
- 2 Connect your VCR, DVD player, TV, and this receiver as follows, using the cables with the monaural mini-plugs (not supplied).**
  - See "Connections 1" on the previous page.
- 3 Connect the audio input/output jacks on the VCR, DVD player, TV, and this receiver using the audio cables.**
  - See pages 7 to 10.
- 4 Connect the video input/output jacks on the VCR, DVD player, TV, and this receiver using the S-video cables, composite video cables, or component video cables.**
  - See "Connections 2" on the previous page.
- 5 Plug the AC power cords of the connected components and this receiver into the AC outlets.**
- 6 When turning on the TV for the first time after the AV COMPU LINK connection, turn the TV volume to the minimum using the TV volume control on the TV.**
- 7 Turn on other connected components first, then turn on this receiver.**
  - When turning on the VCR, use the remote control supplied with this receiver (press VCR )

The AV COMPU LINK remote control system allows you to use the five basic functions listed below.

### **Remote control of the TV, DVD player, and VCR using this remote control**

See pages 37 and 38 for details.

- Aim the remote control directly at **the remote sensor on each component.**

### **One-touch video play**

Simply by inserting a video cassette without its safety tab into the VCR, you can enjoy the video playback without setting other switches manually. The receiver automatically turns on and changes the source to "VCR."

The TV automatically turns on and changes the input mode to the appropriate position so that you can view the playback picture.

When you insert a video cassette with its safety tab, press the play () button on the VCR or on the remote control. So, you can get the same result.

### **One-touch DVD play**

Simply by starting playback on the DVD player, you can enjoy the DVD playback without setting other switches manually.

- When the DVD player is connected through the analog input jacks on this receiver (and analog input is selected), the receiver automatically turns on and changes the source to "DVR/DVD."
- When the DVD player is connected through the digital input terminal on this receiver (and digital input is selected), the receiver automatically turns on and changes the source to "DVR/DVD."

The TV automatically turns on and changes the input mode to the appropriate position so that you can view the playback picture.

### **Automatic selection of TV's input mode**

- When you select "TV" as the source to play on the receiver, the TV automatically changes the input mode to the TV tuner so that you can watch TV.
- When you select "DVR/DVD," "VCR," or "DBS" as the source to play on the receiver, the TV automatically changes the input mode to the appropriate position (either video input 1 or video input 2) so that you can view the playback picture.

#### **NOTE**

This function does not work when you connect this receiver and the TV with the AV COMPU LINK EX terminal using a component video cable. In this case, reconnect the TV referring to Case 1 or Case 2 on page 35.

### **Automatic power on/off**

The TV, DVD player, and VCR turn on and off along with the receiver.

When you turn on the receiver;

- If the previously selected source is "TV" or "DBS," only the TV will turn on automatically.
- If the previously selected source is "DVR/DVD," the TV and DVD player will turn on automatically.
- If the previously selected source is "VCR," the TV and VCR will turn on automatically.

When you turn off the receiver, the TV, DVD player, and VCR will turn off.

#### **NOTE**

If you turn off the receiver while recording on the VCR, the VCR will not turn off, but continue recording.



# Operating other JVC products

You can use the supplied remote control to operate not only this receiver but also other JVC products.

- Refer also to the manuals supplied with the other products.
  - Some JVC VCRs can accept two types of control signals—remote codes “A” and “B.” This remote control can operate a VCR whose remote control code is set to “A.”
  - Some JVC DVD recorders can accept four types of control signals. This remote control can operate a DVD recorder whose remote control code is set to the initial code. For details, refer to the manual supplied with the DVD recorder.
- To operate other products, aim the remote control directly at the remote sensor on the target product.

## ■ TV

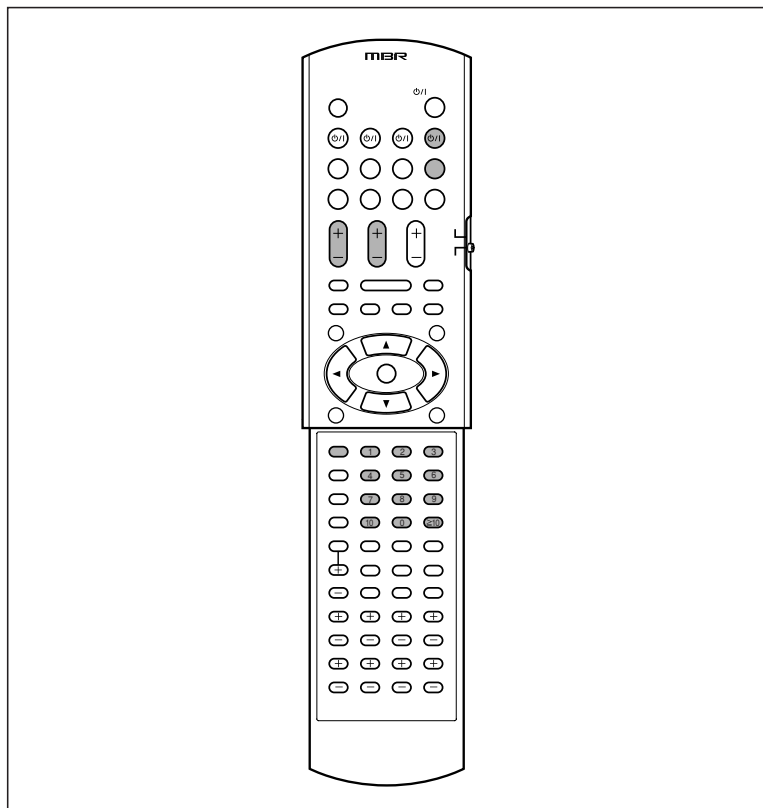

You can always perform the following operations:

<b>TV/SIRIUS <math>\phi</math>/I:</b>	Turn on or off the TV.
<b>TV VOL +/-:</b>	Adjust the volume on the TV.
<b>TV/VIDEO:</b>	Change the input mode (either video input or TV tuner) on the TV.

After pressing TV, you can perform the following operations on the TV.

<b>CHANNEL +/-:</b>	Change the channel numbers.
<b>1 – 9, 0, 100+ (<math>\geq 10</math>):</b>	Select the channel numbers.
<b>RETURN (10):</b>	Switch between the previous channel and the current channel.

## ■ VCR

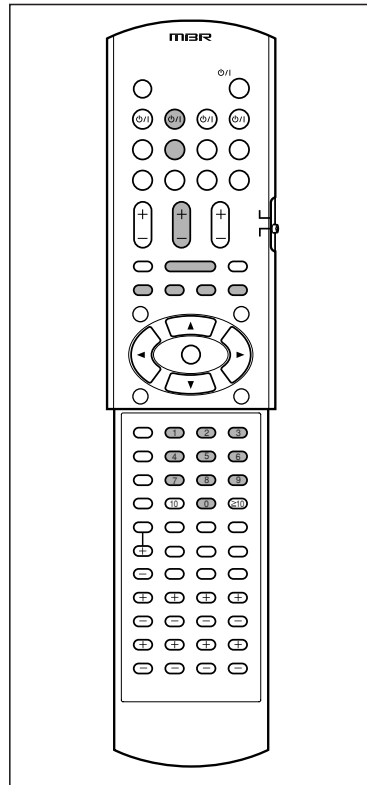

## ■ SIRIUS Satellite Radio

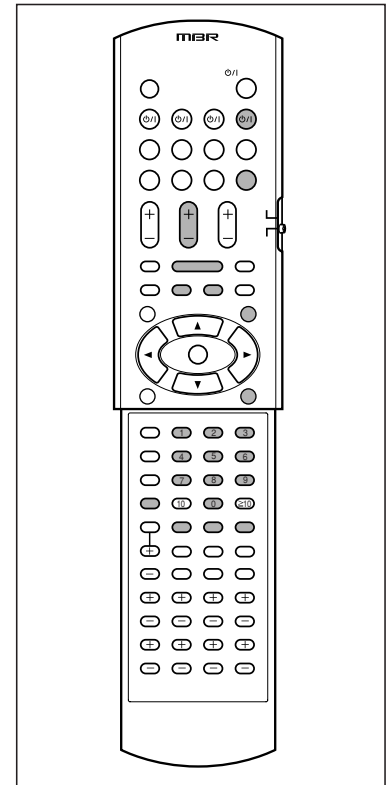

You can always perform the following operation:

<b>VCR <math>\phi</math>/I:</b>	Turn on or off the VCR.
---------------------------------	-------------------------

After pressing VCR, you can perform the following operations on the VCR.

<b>CHANNEL +/-:</b>	Change the channel numbers on the VCR.
---------------------	--

<b>1 – 9, 0:</b>	Select the channel numbers on the VCR.
------------------	--

<b>▶:</b>	Start playback.
-----------	-----------------

<b>■:</b>	Stop playback.
-----------	----------------

<b>  :</b>	Pause playback. To release it, press ▶.
------------	---

<b>▶▶:</b>	Fast-wind a tape.
------------	-------------------

<b>◀◀:</b>	Rewind a tape.
------------	----------------

After pressing SIRIUS, you can perform the following operations on the SIRIUS Satellite Radio.

<b>TV/SIRIUS <math>\phi</math>/I:</b>	Turn on or off the SIRIUS Satellite Radio.
---------------------------------------	--

<b>CHANNEL +/-:</b>	Change the channel numbers on the SIRIUS Satellite Radio.
---------------------	---

<b>SELECT:</b>	Select a highlighted item on the display of the SIRIUS Satellite Radio.
----------------	---

<b>CAT <math>\oplus</math>/<math>\ominus</math> CAT:</b>	Change the category of the program.
--	-------------------------------------

<b>MENU:</b>	Enter and exit from the Menu Option screen of the SIRIUS Satellite Radio.
--------------	---

<b>DISPLAY:</b>	Change the text size on the display of the SIRIUS Satellite Radio.
-----------------	--

<b>1 – 9, 0, BAND:</b>	Store or tune in to the preset channel.
------------------------	---

<b>MEMORY:</b>	Store information on the display of the SIRIUS Satellite Radio.
----------------	---

<b>DIRECT:</b>	Enable access to channels of the SIRIUS Satellite Radio directly by numeric buttons.
----------------	--

<b>PREV:</b>	Return to the previous channel.
--------------	---------------------------------

### NOTE

The remote control may not operate properly for a SIRIUS Satellite Radio other than KT-SR2000 (JVC SIRIUS Satellite Radio).

## ■ DVD recorder or DVD player

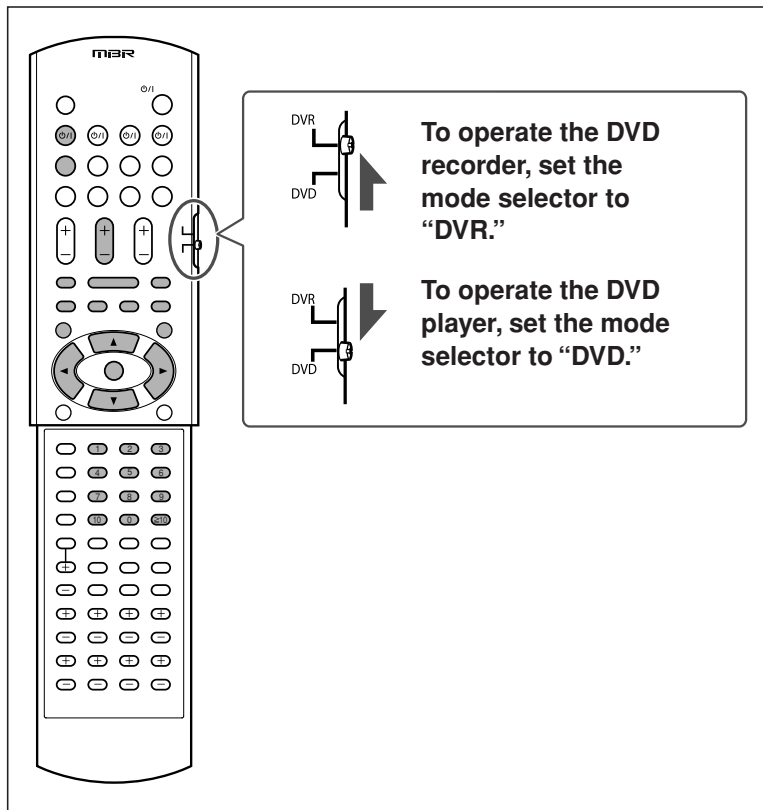

After setting the mode selector correctly, you can perform the following operations on the DVD recorder or DVD player.

See the instructions supplied with the DVD recorder or DVD player for details.

### ■ Changing the remote control code for DVD recorder

Some JVC DVD recorders can accept four types of control signals. You can assign one of the four codes to the remote control supplied with this receiver for operating your DVD recorder. For details, refer to the manual supplied with the DVD recorder.

Initial setting: 03

- 1 Set the mode selector to "DVR."
- 2 Press and hold DVR/DVD  $\odot/\text{I}$ .
- 3 Press DVR/DVD.
- 4 Enter the remote control code you want using buttons 1 – 4, and 0.

EX.: To enter the code "2," press 0, then 2.

Code for DVR	Number to enter
1	01
2	02
3	03
4	04

- 5 Release DVR/DVD  $\odot/\text{I}$ .

Now, the remote control code has been changed.

You can always perform the following operation:

<b>DVR/DVD <math>\odot/\text{I}</math>:</b>	Turn on or off the DVD recorder or DVD player.
---	--

After pressing DVR/DVD, you can perform the following operations on the DVD recorder and DVD player.

<b>▶:</b>	Start playback.
<b>■:</b>	Stop playback.
<b>II:</b>	Pause playback. To release it, press ▶.
<b>▶▶:</b>	Skip to the beginning of the next chapter.
<b>◀◀:</b>	Return to the beginning of the current (or previous) chapter.
<b>▶▶:</b>	Fast-forward playback.
<b>◀◀:</b>	Fast-reverse playback.
<b>TOP MENU/MENU:</b>	Display the menu recorded on discs.
<b>▲/▼/▶/◀:</b>	Select an item on the menu screen.
<b>SET:</b>	Enter the selected item, channel number, chapter/title number, or track number (if required).

#### Only for DVD recorder operations:

<b>CHANNEL +/-:</b>	Change the channel numbers.
<b>1 – 9, 0:</b>	Select a channel number (while stopped) or a chapter/title number, track number (while playing back). Press SET to enter the number.

#### Only for DVD player operations:

<b>1 – 10, 0, <math>\geq 10</math>:</b>	Select a chapter/title number, track number, menu item, etc.
---	--

If these buttons do not function normally, use the remote control supplied with your DVD recorder or DVD player. Refer also to the manuals supplied with the DVD recorder or DVD player for details.

# Operating other manufacturers' products

By changing the transmittable signals, you can use the supplied remote control to operate other manufacturers' products.

- Refer also to the manuals supplied with the other products.
- To operate those components with the remote control, first you need to set the manufacturers' codes each for the TV, VCR, CATV converter, DBS tuner, and DVD player.
- After replacing the batteries of the remote control, set the manufacturers' codes again.
- All the functions may not be assigned to the buttons for some equipment.

## □ Changing the transmittable signals for operating a TV

**1 Press and hold TV/SIRIUS**  $\odot/\text{I}$ .

**2 Press TV.**

**3 Enter the manufacturer's code using buttons 1 – 9, and 0.**

See "Manufacturers' codes for TV" on the right.

**4 Release TV/SIRIUS**  $\odot/\text{I}$ .

Now, you can perform the following operations on the TV.

TV/SIRIUS $\odot/\text{I}$ :	Turn on or off the TV.
TV VOL +/-:	Adjust the volume on the TV.
TV/VIDEO:	Change the input mode (either TV or VIDEO).

After pressing TV, you can perform the following operations on the TV.

CHANNEL +/-:	Change the channel numbers.
1 – 9, 0, 100+ ( $\geq 10$ ):	Select the channel numbers.

See the instructions supplied with the TV for details.

**5 Try to operate your TV by pressing TV**  $\odot/\text{I}$ .

When your TV turns on or off, you have entered the correct code.

If more than one code is listed for your brand of TV, try each one until the correct one is entered.

## Manufacturers' codes for TV

Manufacturer	Codes
JVC	01
Akai	02
Bell+Howell	03
Centurion	04
Coronad	05
Daewoo	06, 07, 08
Emerson	09, 10, 11, 12, 13
Fisher	14
GE•Pana	15, 16
GE•RCA	17
Gold Star	18, 19
Hitachi	20, 21
KTV	22, 23
Magnavox	24
Marantz	25
Mitsubishi	25
Panasonic	26, 27
Philips	24
Pioneer	28
Proscan	29
Quasar	30
Radioshack	31
RCA	02, 17, 32, 33, 34, 35
Samsung	36, 37, 45, 46, 47, 48
Sanyo	14
Sears	38
Sharp	39, 49, 50
Sony	40
Symphonic	41, 42
Toshiba	38
Zenith	43, 44

Initial setting: 01

**Manufacturers' codes are subject to change without notice. If they are changed, this remote control cannot operate the equipment.**

❑ **Changing the transmittable signals for operating a VCR**

**1 Press and hold VCR** .

**2 Press VCR.**

**3 Enter the manufacturer's code using buttons 1 – 9, and 0.**

See "Manufacturers' codes for VCR" on the right.

**4 Release VCR** .

Now, you can perform the following operation on the VCR.

---

**VCR** : Turn on or off the VCR.

---

After pressing VCR, you can perform the following operations on the VCR.

---

**CHANNEL +/-**: Change the channel numbers on the VCR.

---

**1 – 10, 0, ≥10**: Select the channel numbers on the VCR.

---

**▶**: Start playback.

---

**■**: Stop playback.

---

**||**: Pause playback.

---

**▶▶**: Fast-wind a tape.

---

**◀◀**: Rewind a tape.

---

See the instructions supplied with the VCR for details.

**5 Try to operate your VCR by pressing VCR** .

When your VCR turns on or off, you have entered the correct code.

**If more than one code is listed for your brand of VCR, try each one until the correct one is entered.**

**Manufacturers' codes for VCR**

Manufacturer	Codes
JVC	01, 02, 03, 04
Aiwa	05
Akai	06, 07, 08
Bell+Howell	09
Daewoo	10
Emerson	11, 12, 13, 14, 15
Fisher	16, 17, 18, 19
G.E.	20, 21
Go Video	22
Gold Star	23
Go-Video A	24
Go-Video B	25
Hitachi	20, 26
Magnavox	27, 28, 29
Mitsubishi	30, 31, 32, 33
NEC	34, 35
Panasonic	36, 37
Philips	27
RCA	38
Samsung	39, 40, 41
Sanyo	16, 17, 18, 19
Scott	42
Sharp	43, 44
Shintom	45
Sony	46, 47, 48, 49, 50, 51
Symphonic	52
Teknica	53, 54
Toshiba	55
Zenith	56

**Initial setting: 01**

**Manufacturers' codes are subject to change without notice. If they are changed, this remote control cannot operate the equipment.**

❑ **Changing the transmittable signals for operating a CATV converter or DBS tuner**

- 1 Press and hold DBS/CATV  $\odot$ /I.
- 2 Press DBS.
- 3 Enter the manufacturer's code using buttons 1 – 9, and 0.

See "Manufacturers' codes for CATV converter" or "Manufacturers' codes for DBS tuner" below.

4 **Release DBS/CATV  $\odot$ /I.**

Now, you can perform the following operation on the CATV converter or DBS tuner.

<b>DBS/CATV <math>\odot</math>/I:</b>	Turn on or off the CATV converter or DBS tuner.
---------------------------------------	---

After pressing DBS, you can perform the following operations on the CATV converter or DBS tuner.

<b>CHANNEL +/-:</b>	Change the channel numbers on the CATV converter or DBS tuner.
<b>1 – 10, 0:</b>	Select the channel numbers on the CATV converter or DBS tuner.

See the instructions supplied with the CATV converter or DBS tuner for details.

5 **Try to operate your CATV converter or DBS tuner by pressing DBS/CATV  $\odot$ /I.**

When your CATV converter or DBS tuner turns on or off, you have entered the correct code.

If more than one code is listed for your brand of CATV converter or DBS tuner, try each one until the correct one is entered.

**Manufacturers' codes for CATV converter**

Manufacturer	Codes
G.I.	01
Gemini	02
Hamlin	03, 04, 05, 06
Jerrold	07, 08, 09, 10, 11, 12, 13, 14, 15
Macom	16, 17, 18
Magnavox	19
Oak	20, 21, 22
Panasonic	23, 24
Philips	25, 26, 27, 28, 29, 30
Pioneer	31, 32
S. Atlanta	33, 34, 35
Samsung	36
Tocom	37
Zenith	38, 39

**Manufacturers' codes for DBS tuner**

Manufacturer	Codes
Echostar	40
G.I.	41
Hitachi	42
Hughes	43
Panasonic	44
Primestar	45
RCA	46
Sony	47
Toshiba	48

Initial setting: 01

❑ **Changing the transmittable signals for operating a DVD player**

- 1 Set the mode selector to "DVD."
- 2 Press and hold DVR/DVD  $\odot$ /I.
- 3 Press DVR/DVD.
- 4 Enter the manufacturer's code using buttons 1 – 9, and 0.

See "Manufacturers' codes for DVD player" below.

5 **Release DVR/DVD  $\odot$ /I.**

Now, you can perform the following operation on the DVD player.

<b>DVR/DVD <math>\odot</math>/I:</b>	Turn on or off the DVD player.
<b>▶:</b>	Start playback.
<b>▶▶:</b>	Skip to the beginning of the next chapter (or fast-forward for some models).
<b>◀◀:</b>	Return to the beginning of the current chapter (or fast-reverse for some models).
<b>■:</b>	Stop playback.
<b>  :</b>	Pause playback.
<b>TOP MENU/MENU:</b>	Display the menu recorded on DVD VIDEO discs.
<b>▲/▼/▶/◀:</b>	Select an item on the menu screen.
<b>SET:</b>	Enter the selected item.
<b>1 – 9, 0, <math>\geq</math>10:</b>	Select the chapter number.

See the instructions supplied with the DVD player for details.

6 **Try to operate your DVD player by pressing DVR/DVD  $\odot$ /I.**

When your DVD player turns on or off, you have entered the correct code.

**Manufacturers' codes for DVD player**

Manufacturer	Codes
JVC	01
Hitachi	02
Kenwood	03, 04
Magnavox	05
Marantz	06
Mitsubishi	07
Onkyo	08, 09
Panasonic	10
Philips	06
Pioneer	11
Proscan	12
RCA	12
Samsung	13
Sony	14
Toshiba	05
Yamaha	15
Zenith	05, 16

Initial setting: 01

**NOTE**

You cannot use this remote control to operate other manufacturers' DVD recorders than JVC.

**Manufacturers' codes are subject to change without notice. If they are changed, this remote control cannot operate the equipment.**



# Troubleshooting

Use this chart to help you solve daily operational problems. If there are any problems you cannot solve, contact your JVC's service center.

	PROBLEM	POSSIBLE CAUSE	SOLUTION
Power	The power does not come on.	The power cord is not plugged in.	Plug the power cord into an AC outlet.
	The receiver turns off (enters standby mode).	Speakers are overloaded because of high volume.	1. Stop the playback source. 2. Turn on the receiver again, then turn the volume down.
		Speakers are overloaded because of a short circuit at the speaker terminals.	Check the speaker wiring. If speaker wiring is not short-circuited, contact your dealer.
		The receiver is overloaded because of a high voltage.	Consult your dealer after unplugging the power cord.
"OVER HEAT" flashes on the display, then the receiver turns off.	The receiver is overloaded because of high volume or long time usage.	Turn the volume down or turn off the receiver for a while and turn it on again. If the receiver turns off soon after doing solutions above, consult your dealer after unplugging the power cord.	
Sound	No sound from speakers.	Speaker signal cables are not connected.	Check speaker wiring, then reconnect if necessary (see page 6) after unplugging the power cord.
		Connections are incorrect.	Check the audio connections (see pages 7 to 11) after unplugging the power cord.
		An incorrect source is selected.	Select the correct source.
		Muting is activated.	Press MUTING to cancel the mute (see page 14).
		An incorrect input mode (analog or digital) is selected.	Select the correct input mode (analog or digital).
	Sound from one speaker only.	Speaker signal cables are not connected properly.	Check speaker wiring and reconnect if necessary (see page 6) after unplugging the power cord.
Sounds are intermittently distorted by the outside noise such as a lightning discharge.	When you use the digital coaxial connection, the sounds may be intermittently distorted by the outside noise such as a lightning discharge but the sound will be restored automatically.	This is not a malfunction.	
Remote control	Remote control does not operate as you intend.	The remote control is not ready for your intended operation.	Set the mode selector correctly, then press the corresponding source selecting button before operation.
	Remote control does not work.	There is an obstruction blocking the remote sensor on the receiver.	Remove the obstruction.
		Batteries are weak.	Replace batteries.
FM/AM	Continuous hiss or buzzing during FM reception.	Incoming signal is too weak.	Connect an outdoor FM antenna or contact your dealer.
		The station is too far away.	Select another station.
		The wrong antenna is being used.	Check with your dealer to be sure you have the correct antenna.
		Antennas are not connected properly.	Check the connections.
	Occasional cracking noise during FM reception.	Ignition noise from automobiles.	Move the antenna farther from automobile traffic.

# Specifications

Designs and specifications are subject to change without notice.

## Amplifier

### Output Power

At stereo operation:

Front channels: **110 W per channel, min. RMS, driven into 6 Ω at 20 Hz to 20 kHz with no more than 0.8% total harmonic distortion.**

At surround operation:

Front channels: 110 W per channel, min. RMS, driven into 6 Ω at 1 kHz with no more than 0.8% total harmonic distortion.

Center channel: 110 W, min. RMS, driven into 6 Ω at 1 kHz, with no more than 0.8% total harmonic distortion.

Surround channels: 110 W per channel, min. RMS, driven into 6 Ω at 1 kHz, with no more than 0.8% total harmonic distortion.

Surround back channels:  
110 W per channel, min. RMS, driven into 6 Ω at 1 kHz, with no more than 0.8% total harmonic distortion.

## Audio

Audio Input Sensitivity/Impedance:

DVR/DVD, VCR, DBS, TV: 300 mV/47 kΩ

Audio Input (DIGITAL IN)\*:

Coaxial: DIGITAL IN 1 (DVR/DVD): 0.5 V(p-p)/75 Ω

Optical: DIGITAL IN 2 (DBS), 3 (VCR): -21 dBm to -15 dBm (660 nm ±30 nm)

USB: USB DIGITAL

\* Corresponding to Linear PCM, Dolby Digital, and DTS (with sampling frequency—32 kHz, 44.1 kHz, 48 kHz).

Audio Output Level:

DVR, VCR: 300 mV

Signal-to-Noise Ratio ('66 IHF/'78 IHF): 80 dB/70 dB

Frequency Response (6 Ω): 20 Hz to 20 kHz (±1 dB)

Bass Boost: +4 dB ±1 dB at 100 Hz

Equalization (at DSP operation):

Center frequency: 63 Hz, 250 Hz, 1 kHz, 4 kHz, 16 kHz

Control range: ±8 dB

## Video

Video Input Sensitivity/Impedance:

Composite video: DVR/DVD, VCR, DBS:  
1 V(p-p)/75 Ω

S-video: DVR/DVD, VCR, DBS:

Y (luminance): 1 V(p-p)/75 Ω

C (chrominance, burst): 0.286 V(p-p)/75 Ω

Component: DVR/DVD, VCR (DBS):

Y (luminance): 1 V(p-p)/75 Ω

PB, PR: 0.7 V(p-p)/75 Ω

Video Output Level/Impedance:

Composite video: DVR, VCR, MONITOR OUT:  
1 V(p-p)/75 Ω

S-video: DVR, VCR, MONITOR OUT:

Y (luminance): 1 V(p-p)/75 Ω

C (chrominance, burst): 0.286 V(p-p)/75 Ω

Component: MONITOR OUT:

Y (luminance): 1 V(p-p)/75 Ω

PB, PR: 0.7 V(p-p)/75 Ω

Synchronization: Negative

## FM tuner (IHF)

Tuning Range: 87.5 MHz to 108.0 MHz

Usable Sensitivity:

Monaural: 12.8 dBf (1.2 μV/75 Ω)

50 dB Quieting Sensitivity:

Monaural: 16.0 dBf (1.7 μV/75 Ω)

Stereo: 37.5 dBf (20.5 μV/75 Ω)

Stereo Separation at REC OUT: 35 dB at 1 kHz

## AM tuner

Tuning Range: 530 kHz to 1 710 kHz

## General

Power Requirements: AC 120 V~, 60 Hz

Power Consumption: 150 W/200 VA (at operation)  
0.9 W (in standby mode)

Dimensions (W x H x D): 435 mm x 91.5 mm x 360 mm  
(17<sup>3</sup>/<sub>16</sub> inches x 3<sup>5</sup>/<sub>8</sub> inches x 14<sup>3</sup>/<sub>16</sub> inches)

Mass: 6.7 kg (14.8 lbs)

# **TO OUR VALUED CUSTOMER** ———

THANK YOU FOR PURCHASING THIS JVC PRODUCT.  
WE WANT TO HELP YOU ACHIEVE A PERFECT EXPERIENCE.

**NEED HELP ON HOW TO HOOK UP?  
NEED ASSISTANCE ON HOW TO OPERATE?  
NEED TO LOCATE A JVC SERVICE CENTER?  
LIKE TO PURCHASE ACCESSORIES?**

**JVC<sup>®</sup> IS HERE TO HELP!**  
**TOLL FREE: 1(800)252-5722**  
**<http://www.jvc.com>**

Remember to retain your Bill of Sale for Warranty Service.

————— **Do not attempt to service the product yourself** —————

**Caution**

To prevent electrical shock, do not open the cabinet.  
There are no user serviceable parts inside.  
Please refer to qualified service personnel for repairs.

---



# LIMITED WARRANTY

AUDIO-2 **USA ONLY**

**ONLY FOR PRODUCT PURCHASED IN U.S.A.**

JVC COMPANY OF AMERICA (JVC) warrants this product and all parts thereof, except as set forth below ONLY TO THE ORIGINAL RETAIL PURCHASER to be FREE FROM DEFECTIVE MATERIALS AND WORKMANSHIP from the date of original purchase for the period shown below. ("The Warranty Period")

PARTS	<b>2 YRS</b>	LABOR	<b>2 YRS</b>
-------	--------------	-------	--------------

**THIS LIMITED WARRANTY IS VALID ONLY IN THE FIFTY (50) UNITED STATES, THE DISTRICT OF COLUMBIA AND IN THE COMMONWEALTH OF PUERTO RICO.**

### WHAT WE WILL DO:

If this product is found to be defective within the warranty period, JVC will repair or replace defective parts with new or rebuilt equivalents at no charge to the original owner. Such repair and replacement services shall be rendered by JVC during normal business hours at JVC authorized service centers. Parts used for replacement are warranted only for the remainder of the Warranty Period. All products may be brought to a JVC authorized service center on a carry-in basis. Color televisions with a screen size of 27" or greater qualify for in-home service. In such cases, a technician will come to your home and either repair the TV there or remove and return it if it cannot be repaired in your home.

### WHAT YOU MUST DO FOR WARRANTY SERVICE:

***Please do not return your product to the retailer***

**Instead, return your product to the JVC authorized service center nearest you. If shipping the product to the service center, please be sure to package it carefully, preferably in the original packaging, and include a brief description of the problem(s). Please call 1-800-252-5722 to locate the nearest JVC authorized service center. Service locations can also be obtained from our website <http://www.jvc.com>. If your product qualifies for in-home service, the service representative will require clear access to the product.**

If you have any questions concerning your JVC Product, please contact our Customer Relations Department at 800-252-5722

### WHAT IS NOT COVERED:

This limited warranty provided by JVC does not cover:

1. Products which have been subject to abuse, accident, alteration, modification, tampering, negligence, misuse, faulty installation, lack of reasonable care, or if repaired or serviced by anyone other than a service facility authorized by JVC to render such service, or if affixed to any attachment not provided with the products, or if the model or serial number has been altered, tampered with, defaced or removed;
2. Initial installation, installation and removal from cabinets or mounting systems.
3. Operational adjustments covered in the Owner's Manual, normal maintenance, video and audio head cleaning;
4. Damage that occurs in shipment, due to act of God, and cosmetic damage;
5. Signal reception problems and failures due to line power surge;
6. Video Pick-up Tubes/CCD Image Sensors are covered for 90 days from the date of purchase;
7. Accessories;
8. Batteries (except that Rechargeable Batteries are covered for 90 days from the date of purchase);
9. Products used for commercial purposes, including, but not limited to rental.

There are no express warranties except as listed above.

THE DURATION OF ANY IMPLIED WARRANTIES, INCLUDING THE IMPLIED WARRANTY OF MERCHANTABILITY, IS LIMITED TO THE DURATION OF THE EXPRESS WARRANTY HEREIN.

JVC SHALL NOT BE LIABLE FOR ANY LOSS OF USE OF THE PRODUCT, INCONVIENCE, OR ANY OTHER DAMAGES, WHETHER DIRECT, INCIDENTAL OR CONSEQUENTIAL (INCLUDING, WITHOUT LIMITATION, DAMAGE TO TAPES, RECORDS OR DISCS) RESULTING FROM THE USE OF THIS PRODUCT, OR ARISING OUT OF ANY BREACH OF THIS WARRANTY. ALL EXPRESS AND IMPLIED WARRANTIES, INCLUDING THE WARRANTIES OF MERCHANTABILITY AND FITNESS FOR PARTICULAR PURPOSE, ARE LIMITED TO THE WARRANTY PERIOD SET FORTH ABOVE.

Some states do not allow the exclusion of incidental or consequential damages or limitations on how long an implied warranty lasts, so these limitations or exclusions may not apply to you. This warranty gives you specific legal rights and you may also have other rights which vary from state to state.

**JVC COMPANY OF AMERICA**  
DIVISION OF JVC AMERICAS CORP.

1700 Valley Road  
Wayne, NJ 07470

<http://www.jvc.com>

REFURBISHED PRODUCTS CARRY A SEPARATE WARRANTY, THIS WARRANTY DOES NOT APPLY. FOR DETAIL OF REFURBISHED PRODUCT WARRANTY, PLEASE REFER TO THE REFURBISHED PRODUCT WARRANTY INFORMATION PACKAGED WITH EACH REFURBISHED PRODUCT.

### For customer use:

Enter below the Model No. and Serial No. which is located either on the rear, bottom or side of the cabinet. Retain this information for future reference.

Model No. : \_\_\_\_\_

Serial No. : \_\_\_\_\_

Purchase date : \_\_\_\_\_

Name of dealer : \_\_\_\_\_

**JVC**





## Free Manuals Download Website

<http://myh66.com>

<http://usermanuals.us>

<http://www.somanuals.com>

<http://www.4manuals.cc>

<http://www.manual-lib.com>

<http://www.404manual.com>

<http://www.luxmanual.com>

<http://aubethermostatmanual.com>

Golf course search by state

<http://golfingnear.com>

Email search by domain

<http://emailbydomain.com>

Auto manuals search

<http://auto.somanuals.com>

TV manuals search

<http://tv.somanuals.com>