

JVC

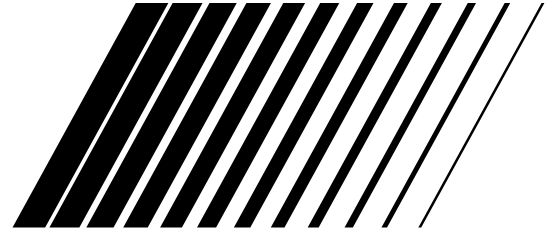

AUDIO/VIDEO CONTROL RECEIVER

RX-D411S/RX-D412B

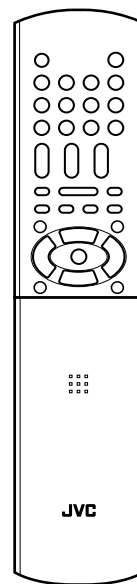
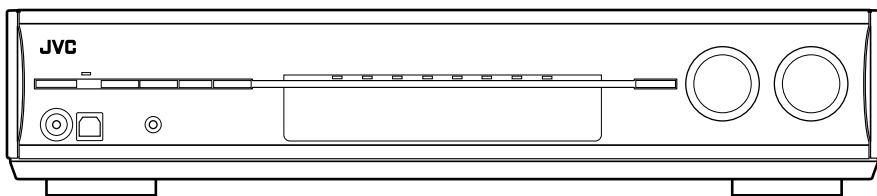

INSTRUCTIONS

For Customer Use:

Enter below the Model No. and Serial No. which are located either on the rear, bottom or side of the cabinet. Retain this information for future reference.

Model No. _____

Serial No. _____

LVT1572-001A
[J]

Warnings, Cautions, and Others

Mises en garde, précautions et indications diverses

	CAUTION RISK OF ELECTRIC SHOCK DO NOT OPEN	
CAUTION: TO REDUCE THE RISK OF ELECTRIC SHOCK, DO NOT REMOVE COVER (OR BACK). NO USER SERVICEABLE PARTS INSIDE. REFER SERVICING TO QUALIFIED SERVICE PERSONNEL.		

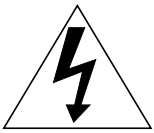

The lightning flash with arrowhead symbol, within an equilateral triangle is intended to alert the user to the presence of uninsulated "dangerous voltage" within the product's enclosure that may be of sufficient magnitude to constitute a risk of electric shock to persons.



The exclamation point within an equilateral triangle is intended to alert the user to the presence of important operating and maintenance (servicing) instructions in the literature accompanying the appliance.

WARNING: TO REDUCE THE RISK OF FIRE OR ELECTRIC SHOCK, DO NOT EXPOSE THIS APPLIANCE TO RAIN OR MOISTURE.

CAUTION

To reduce the risk of electrical shocks, fire, etc.:

1. Do not remove screws, covers or cabinet.
2. Do not expose this appliance to rain or moisture.

ATTENTION

Afin d'éviter tout risque d'électrocution, d'incendie, etc.:

1. Ne pas enlever les vis ni les panneaux et ne pas ouvrir le coffret de l'appareil.
2. Ne pas exposer l'appareil à la pluie ni à l'humidité.

Caution— STANDBY/ON button!

Disconnect the mains plug to shut the power off completely (the standby lamp goes off). When installing the apparatus, ensure that the plug is easily accessible. The  STANDBY/ON button in any position does not disconnect the mains line.

- When the unit is on standby, the standby lamp lights red.
- When the unit is turned on, the standby lamp goes off.

The power can be remote controlled.

Attention—Touche STANDBY/ON!

Déconnectez la fiche secteur pour mettre l'appareil complètement hors tension (le témoin d'attente s'éteint). Lors de l'installation de l'appareil, assurez-vous que la fiche soit facilement accessible. La touche  STANDBY/ON dans n'importe quelle position ne déconnecte pas l'appareil du secteur.

- Quand l'appareil est en mode d'attente, le témoin d'attente s'allume en rouge.
- Quand l'appareil est sous tension, le témoin d'attente s'éteint.

L'alimentation ne peut pas être commandée à distance.

Note to CATV system installer:

This reminder is provided to call the CATV system installer's attention to Section 820-40 of the NEC which provides guidelines for proper grounding and, in particular, specifies that the cable ground shall be connected to the grounding system of the building, as close to the point of cable entry as practical.

CAUTION

Changes or modifications not approved by JVC could void the user's authority to operate the equipment.

ATTENTION

Des changements ou modifications non approuvés par JVC pourront invalider l'autorité de l'utilisateur à opérer cet appareil.

For U.S.A

This equipment has been tested and found to comply with the limits for a Class B digital device, pursuant to part 15 of the FCC Rules. These limits are designed to provide reasonable protection against harmful interference in a residential installation.

This equipment generates, uses and can radiate radio frequency energy and, if not installed and used in accordance with the instructions, may cause harmful interference to radio communications. However, there is no guarantee that interference will not occur in a particular installation. If this equipment does cause harmful interference to radio or television reception, which can be determined by turning the equipment off and on, the user is encouraged to try to correct the interference by one or more of the following measures:

- Reorient or relocate the receiving antenna.
- Increase the separation between the equipment and receiver.
- Connect the equipment into an outlet on a circuit different from that to which the receiver is connected.
- Consult the dealer or an experienced radio/TV technician for help.

Declaration of Conformity:

Trade Name: JVC

Model Number: RX-D411S/RX-D412B

Responsible Party: JVC Americas Corp.

Address: 1700 Valley Road, Wayne New Jersey 07470

Telephone Number: 973-317-5000

This device complies with Part 15 of the FCC Rules. Operation is subject to the following two conditions:

- (1) This device may not cause harmful interference.
- (2) This device must accept any interference received, including interference that may cause undesired operation.

For Canada/pour Le Canada

THIS DIGITAL APPARATUS DOES NOT EXCEED THE CLASS B LIMITS FOR RADIO NOISE EMISSIONS FROM DIGITAL APPARATUS AS SET OUT IN THE INTERFERENCE-CAUSING EQUIPMENT STANDARD ENTITLED "DIGITAL APPARATUS," ICES-003 OF THE DEPARTMENT OF COMMUNICATIONS.

CET APPAREIL NUMERIQUE RESPECTE LES LIMITES DE BRUITS RADIOELECTRIQUES APPLICABLES AUX APPAREILS NUMERIQUES DE CLASSE B PRESCRITES DANS LA NORME SUR LE MATERIEL BROUILLEUR; "APPAREILS NUMERIQUES", NMB-003 EDICTEE PAR LE MINISTRE DES COMMUNICATIONS.



[European Union Only]

[Union européenne seulement]

Introduction

We would like to thank you for purchasing one of our JVC products.
Before operating this unit, read this manual carefully and thoroughly to obtain the best possible performance from your unit, and retain this manual for future reference.

Features

Hybrid Feedback Digital Amplifier

RX-D411S/RX-D412B features the JVC-exclusive Hybrid Feedback Digital Amplifier. Premium-grade parts and devices, and special internal construction assure you will enjoy superior sound.

Compatible with HDMI*

The HDMI (High-Definition Multimedia Interface) is the standard interface for the next-generation TV. By connecting the source components, this receiver, and TV with the HDMI cables, digital video signals and audio signals (including Dolby Digital, DTS) are transmitted through the cables. You can transmit digital video signal and audio signal without AD/DA conversion with easy connection.

As RX-D411S/RX-D412B supports up to HDMI version 1.1, this receiver can digitally receive 5.1-channel PCM with fs 96 kHz and 2-channel PCM with fs 192 kHz. (These PCM signals are referred to as "multi-channel PCM" in this instructions.) You can enjoy digital sound without deterioration. In addition, this receiver is compatible with HDCP** (High-bandwidth Digital Content Protection), and HDCP contents can be viewed if you connect an HDCP-compatible TV to this receiver.

* HDMI, the HDMI logo and High-Definition Multimedia Interface are trademarks or registered trademarks of HDMI Licensing LLC.

**HDCP is the abbreviation of "High-bandwidth Digital Content Protection," and is the high-reliable copy control technology licensed by Digital Content Protection, LLC.

7.1 channel DAP (Digital Acoustic Processor)

Sound field simulation technology allows precise ambience recreation of existing theatres and halls. Thanks to the high-performance DSP (Digital Signal Processor) and high-capacity memory, you can enjoy 7.1-channel surround by playing 2-channel or multi-channel software.

Precise Surround Setup

Precise Surround Setup is a newly-developed JVC solution for quick, easy and systematic optimization of surround sound. By using Precise Surround Setup, you can enjoy the best possible surround performance. Precise Surround Setup measures the listening environment accurately with the dedicated earphone-type microphones and adjusts the speaker settings automatically.

CC (Compression Compensative) Converter

CC Converter eliminates jitter and ripples, achieving a drastic reduction in digital distortion by processing the digital music data in 24 bit-quantization and by expanding the sampling frequency to 128 kHz (for fs 32 kHz signals)/176.4 kHz (for fs 44.1 kHz signals)/192 kHz (for fs 48 kHz signals). By using the CC Converter, you can obtain a natural sound field from any source.

DCDi technology

DCDi (Directional Correlational Deinterlacing) technology, developed by Faroudja, eliminates jagged edges generated in progressive scanning conversion. With DCDi, you can enjoy clear and smooth video images on your display. For RX-D411S/RX-D412B, this function is applied only when the NTSC analog video signals are transmitted to the receiver.

K2 technology

K2 technology has been designed to enable natural audio reproduction, achieving a drastic reduction in digital distortion and creating original sound ambience with high precision.

Precautions

Power sources

- When unplugging the receiver from the wall outlet, always pull the plug, not the AC power cord.
- Do not handle the AC power cord with wet hands.
- If you are not going to operate the receiver for an extended period of time, unplug the AC power cord from the wall outlet.

Ventilation

The seven high power amplifiers built in this receiver will generate heat inside the cabinet.

For safety, observe the following carefully:

- Make sure there is good ventilation around the receiver. Poor ventilation could overheat and damage the receiver.
- Do not block the ventilation openings or holes. (If the ventilation openings or holes are blocked by a newspaper or cloth, etc., the heat may not be able to get out.)

Others

- Should any metallic object or liquid fall into the receiver, unplug the receiver and consult your dealer before operating any further.
- Do not use this receiver in a bathroom or places with water.
- Do not place any containers filled with water or liquids (such as cosmetics or medicines, flower vases, potted plants, cups, etc.) on the top of this receiver.
- Do not disassemble the receiver since there are no user serviceable parts inside.

If anything goes wrong, unplug the AC power cord and consult your JVC dealer.

Table of Contents

Parts identification	3	Basic settings	29
Getting started	6	Basic setting items.....	29
Before installation	6	Operating procedure	30
Checking the supplied accessories	6	Setting the speakers	30
Putting the batteries in the remote control.....	6	Activating the EX/ES/PLIIx setting—EX/ES/PLIIx	32
Connecting the antennas.....	7	Selecting the main or sub channel—DUAL MONO	32
Connecting the speakers	8	Setting bass sound.....	33
Connecting video components.....	9	Using the Midnight mode—MIDNIGHT MODE	33
Connecting the power cord.....	14	Setting the digital input (DIGITAL IN) terminals—DIGITAL IN 1/2/3	34
USB connection	15	Setting the Audio delay level—AUDIO DELAY	34
Precise Surround Setup	16	Selecting the source for HDMI terminal and COMPONENT VIDEO jacks—HDMI SELECT/CMPNT SELECT.....	34
Setting the speakers automatically.....	16	Selecting the output video signals—VIDEO OUTPUT	34
Troubleshooting for Precise Surround Setup.....	19	Sound adjustments	35
Basic operations	20	Basic adjustment items	35
1 Turn on the power	20	Operating procedure	35
2 Select the source to play	20	Adjusting the speaker output levels.....	36
3 Adjust the volume	21	Adjusting the equalization patterns—D EQ 63Hz/250Hz/ 1kHz/4kHz/16kHz.....	36
Selecting the video and audio input settings	21	Adjusting the bass sounds	37
Selecting the digital decode mode.....	22	Adjusting the sound parameters for the Surround/DSP modes.....	37
Turning off the sounds temporarily.....	22	Creating realistic sound fields	39
Changing the display brightness.....	22	Reproducing theater ambience	39
Turning off the power with the Sleep Timer	23	Introducing the Surround modes.....	39
Making sounds natural.....	23	Introducing the DSP modes	41
FM/AM tuner operations	24	Using the Surround/DSP modes	42
Tuning in to stations manually	24	Activating the Surround/DSP modes	43
Using preset tuning	24	AV COMPU LINK remote control system	45
Selecting the FM reception mode	25	Operating other JVC products	47
XM Satellite Radio operations	26	Operating other manufacturers' products	49
Preparation	26	Troubleshooting	52
Listening to the XM Satellite Radio	26	Specifications	54
Using preset tuning	27		
Changing the channel information	28		

Parts identification

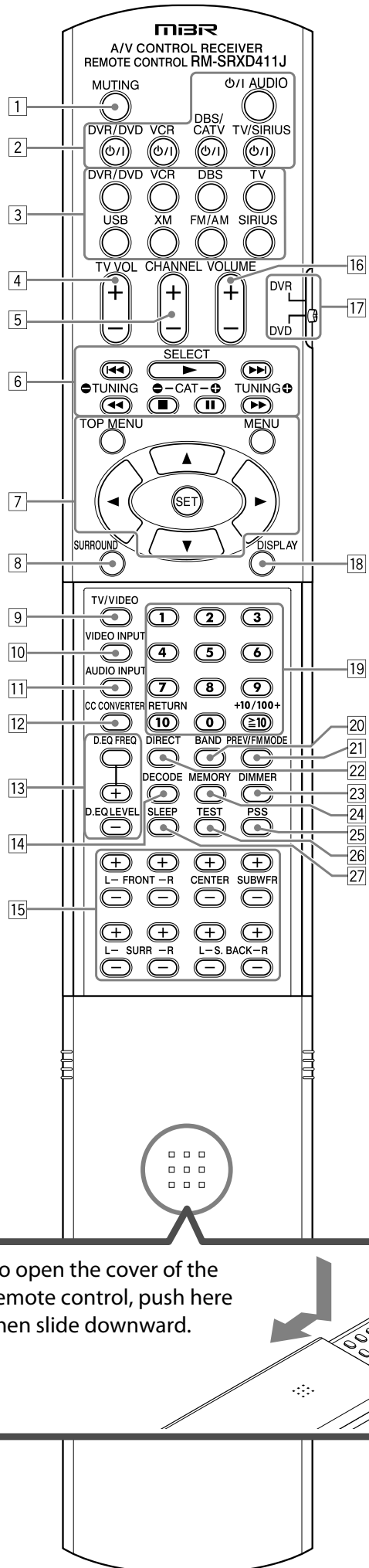

Remote control

See pages in parentheses for details.

- 1 MUTING button (22)
- 2 Standby/on buttons (16, 20, 47 – 51)
 ⏻ AUDIO, TV/SIRIUS ⏻, DBS/CATV ⏻, VCR ⏻, DVR/DVD ⏻
- 3 Source selecting buttons (20, 24, 26, 47 – 51)
 TV, DBS, VCR, DVR/DVD, SIRIUS, FM/AM, XM, USB
- 4 TV VOL (volume) +/- button (47, 49)
- 5 CHANNEL +/- button (27, 47 – 51)
- 6 • Operating buttons for video components (47 – 51)
 ◀▶▶▶, ▶▶▶▶, ▶▶▶▶▶▶, ▶▶▶▶▶▶▶▶▶▶
 • Operating buttons for FM/AM tuner (24)
 ⏻ TUNING, TUNING ⏹
 • Operating buttons for XM Satellite Radio or SIRIUS
 Satellite Radio (27, 47)
 SELECT*, ⏻ CAT, CAT ⏹
- 7 Operating buttons for DVD recorder or DVD player**
 (48, 51)
 TOP MENU, MENU, cursor buttons (▶, ◀, ▲, ▼), SET
- 8 SURROUND button (44)
- 9 TV/VIDEO button (47, 49)
- 10 VIDEO INPUT button (21)
- 11 AUDIO INPUT button (21)
- 12 CC CONVERTER button (23)
- 13 Adjusting buttons for Digital Equalizer (36)
 D.EQ FREQ, D.EQ LEVEL +/-
- 14 DECODE button (22)
- 15 Adjusting buttons for speaker and subwoofer output levels
 (36)
 FRONT L +/-, FRONT R +/-, CENTER +/-, SUBWFR +/-, SURR
 L +/-, SURR R +/-, S.BACK L +/-, S.BACK R +/-
- 16 VOLUME +/- button (21)
- 17 Mode selector (48, 51)
- 18 DISPLAY button (28, 47)
- 19 • Numeric buttons (25, 27, 47 – 51)
 1 – 10, 0, ≥10, +10/100+
 • RETURN button (47)
- 20 BAND* button (47)
- 21 PREV*/FM MODE button (25, 47)
- 22 DIRECT button (27)
- 23 DIMMER button (22)
- 24 MEMORY button (24, 27)
- 25 PSS (Precise Surround Setup) button (17)
- 26 TEST button (18, 36)
- 27 SLEEP button (23)

* For SIRIUS Satellite Radio only

**These buttons can be used for operating a DVD recorder (JVC products only) or DVD player, with the mode selector set to "DVR" or "DVD" (see page 48).

If these buttons do not function normally, use the remote control supplied with your DVD recorder or DVD player. Refer also to the manual supplied with the DVD recorder or DVD player for details.

- When operating a DVD recorder (for JVC products only), set the mode selector (17) to "DVR."
- When operating a DVD player, set the mode selector (17) to "DVD."

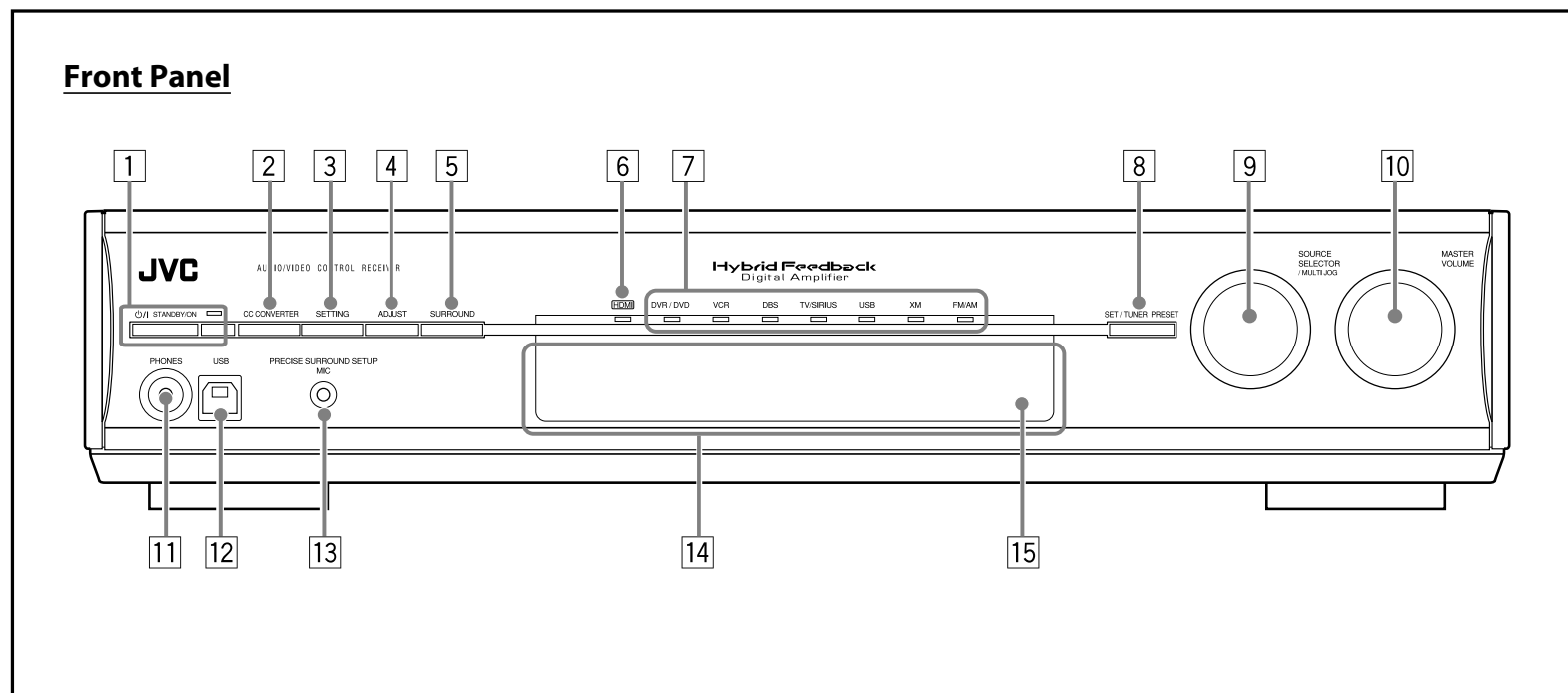

- 1 ⏻/STANDBY/ON button and standby lamp (16, 20)
- 2 CC CONVERTER button (23)
- 3 SETTING button (30)
- 4 ADJUST button (35)
- 5 SURROUND button (44)
- 6 HDMI lamp (9, 21)
- 7 Source lamps
DVR/DVD, VCR, DBS, TV/SIRIUS, USB, XM, FM/AM
- 8 • SET button (20, 30, 35)
• TUNER PRESET button (25, 28)
- 9 • SOURCE SELECTOR (20, 25, 26)
• MULTI JOG (25, 28, 30, 35, 44)
- 10 MASTER VOLUME control (21)
- 11 PHONES jack (21)
- 12 USB terminal (15)
- 13 PRECISE SURROUND SETUP MIC jack (16)
- 14 Display window (see below)
- 15 Remote sensor (6)

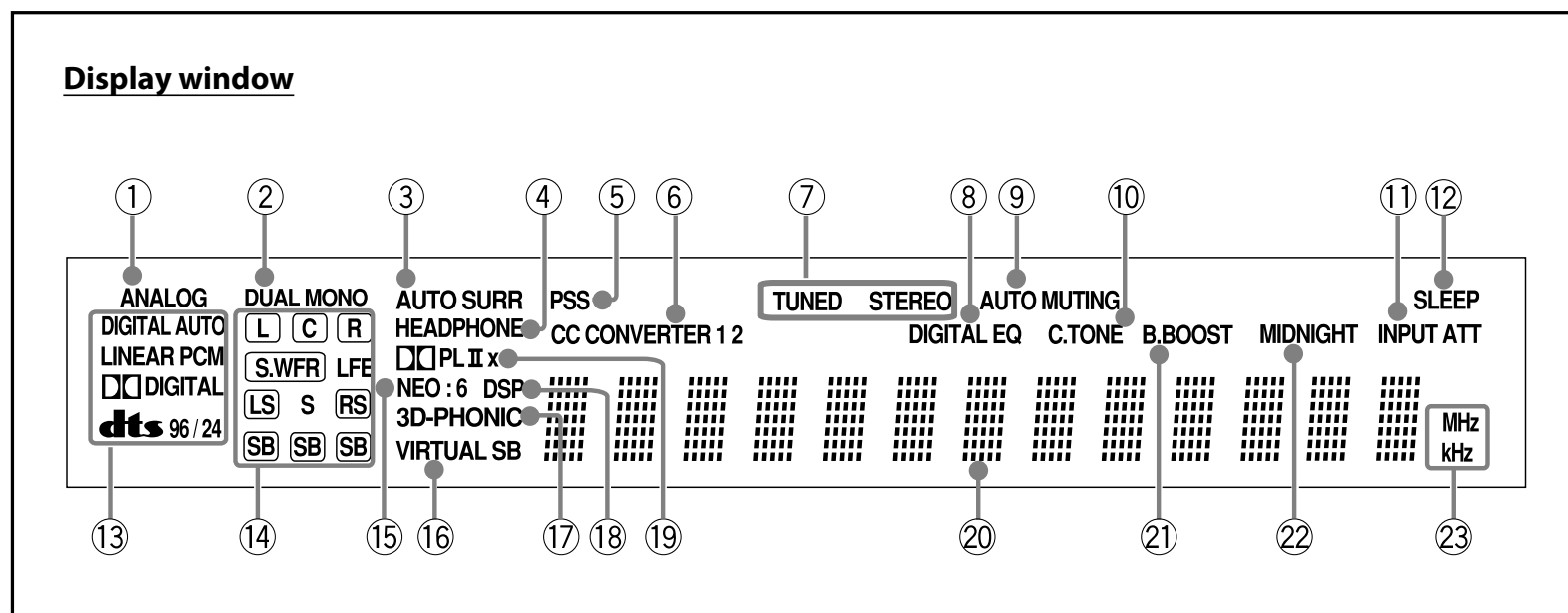

- 1 ANALOG indicator (21)
- 2 DUAL MONO indicator (32)
- 3 AUTO SURR (surround) indicator (43)
- 4 HEADPHONE indicator (21, 42)
- 5 PSS (Precise Surround Setup) indicator (17)
- 6 CC CONVERTER 1 and CC CONVERTER 2 indicators (23)
- 7 FM/AM tuner operation indicators (24)
TUNED, STEREO
- 8 DIGITAL EQ indicator (36)
- 9 AUTO MUTING indicator (25)
- 10 C (center).TONE indicator (38)
- 11 INPUT ATT (attenuate) indicator (37)
- 12 SLEEP indicator (23)
- 13 Digital signal format indicators (21, 22, 40, 41)
DIGITAL AUTO, LINEAR PCM, DIGITAL, **dts**, **dts** 96/24
- 14 Signal and speaker indicators (23)
- 15 NEO:6 indicator (40)
- 16 VIRTUAL SB (surround back) indicator (43)
- 17 3D-PHONIC indicator (40, 41)
- 18 DSP indicator (41)
- 19 PL II and PL IIx indicators (39 – 41)
- 20 Main display
- 21 B (bass).BOOST indicator (37)
- 22 MIDNIGHT indicator (33)
- 23 Frequency unit indicators
MHz (for FM stations), kHz (for AM stations)

See pages in parentheses for details.

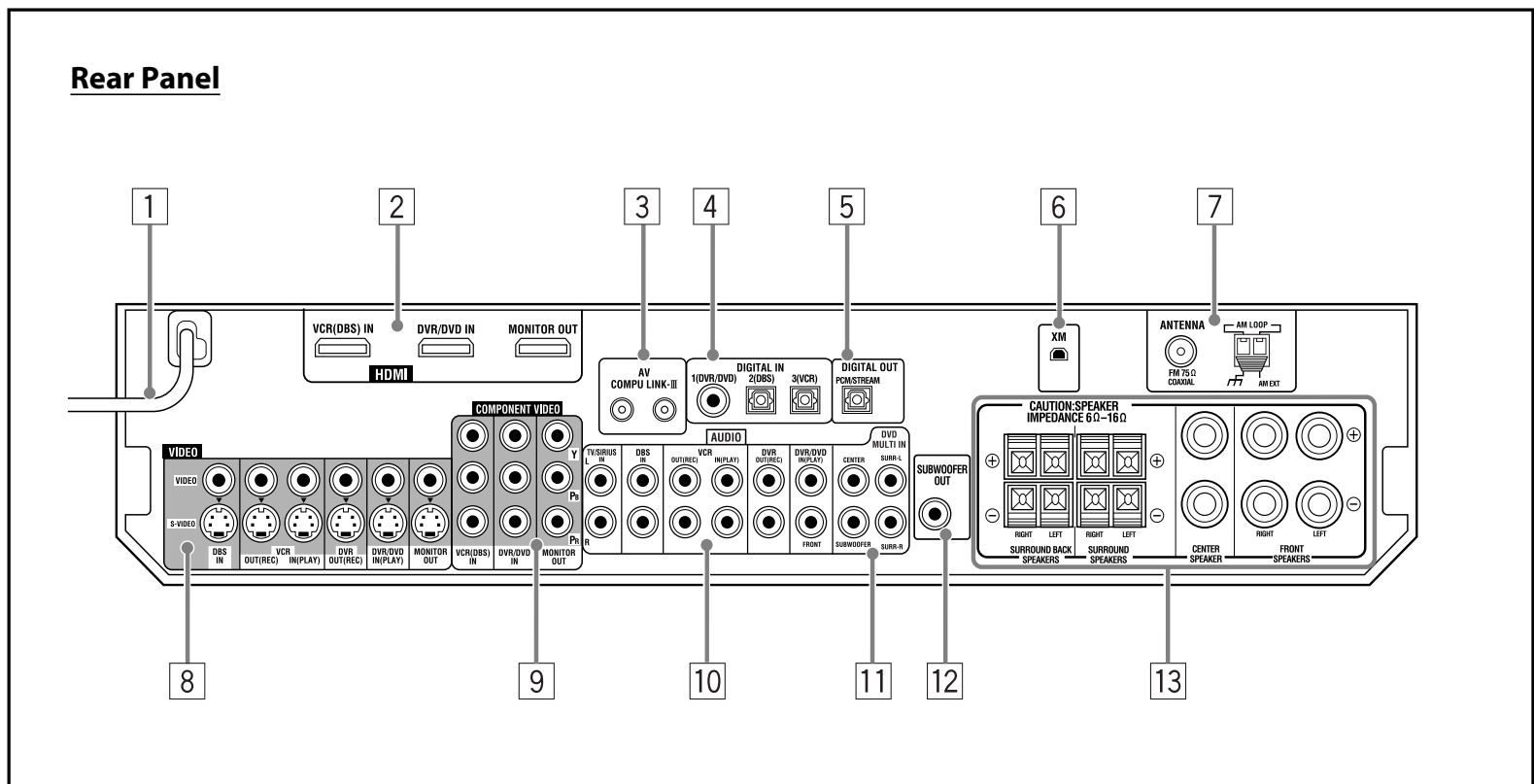

- | | |
|---|---|
| <p>1 Power cord (14)</p> <p>2 HDMI terminals (9)
VCR(DBS) IN, DVR/DVD IN, MONITOR OUT</p> <p>3 AV COMPU LINK-III terminals (45)</p> <p>4 DIGITAL IN terminals (14)
• Coaxial: 1(DVR/DVD)
• Optical: 2(DBS)
• Optical: 3(VCR)</p> <p>5 DIGITAL OUT terminal (14)</p> <p>6 XM jack (7)</p> <p>7 FM/AM ANTENNA terminals (7)</p> | <p>8 VIDEO jacks (10 – 13)
VIDEO (composite video) jacks, S-VIDEO jacks
• Input: DBS IN, VCR IN(PLAY), DVR/DVD IN(PLAY)
• Output: VCR OUT(REC), DVR OUT(REC), MONITOR OUT</p> <p>9 COMPONENT VIDEO (Y, Pb, Pr) jacks (10 – 13)
VCR(DBS) IN, DVR/DVD IN, MONITOR OUT</p> <p>10 AUDIO jacks (10 – 13)
• Input: TV/SIRIUS IN, DBS IN, VCR IN(PLAY), DVR/DVD IN(PLAY)
• Output: VCR OUT(REC), DVR OUT(REC)</p> <p>11 DVD MULTI IN jacks (11)
CENTER, SUBWOOFER, SURR-L, SURR-R</p> <p>12 SUBWOOFER OUT jack (8)</p> <p>13 Speaker terminals (8)
SURROUND BACK SPEAKERS, SURROUND SPEAKERS, CENTER SPEAKER, FRONT SPEAKERS</p> |
|---|---|

Getting started

Before installation

■ General precautions

- Be sure your hands are dry.
- Turn the power off to all components.
- Read the manuals supplied with the components you are going to connect.

■ Locations

- Install the receiver in a location that is level and protected from moisture and dust.
- The temperature around the receiver must be between -5°C and 35°C (23°F and 95°F).
- Make sure there is good ventilation around the receiver. Poor ventilation could cause overheating and damage the receiver.
- Leave sufficient distance between the receiver and the TV.

■ Handling the receiver

- Do not insert any metal object into the receiver.
- Do not disassemble the receiver or remove screws, covers, or cabinet.
- Do not expose the receiver to rain or moisture.
- Do not pull on the power cord to unplug the cord. When unplugging the cord, always grasp the plug so as not to damage the cord.
- When you are away on travel or otherwise for an extended period or time, remove the plug from the wall outlet. A small amount of power is always consumed while the power cord is connected to the wall outlet.

The receiver has a built-in cooling fan which operates while the receiver is turned on. Be sure to leave enough ventilation to obtain sufficient cooling effect.

CAUTION:

Do not connect the AC power cord until all other connections have been made.

Checking the supplied accessories

Check to be sure you have all of the following supplied accessories. If anything is missing, contact your dealer immediately.

- Remote control (× 1)
- Batteries (× 2)
- AM loop antenna (× 1)
- FM antenna (× 1)
- Dedicated earphone-type microphones (× 1)

Putting the batteries in the remote control

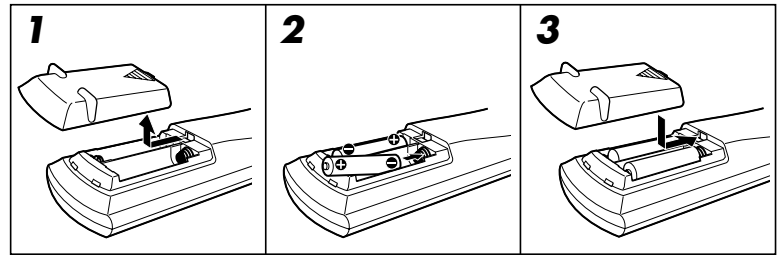

Before using the remote control, put two supplied batteries first.

1 Press and slide the battery cover on the back of the remote control.

2 Insert the batteries.

Make sure to match the polarity: (+) to (+) and (-) to (-).

3 Replace the cover.

If the range or effectiveness of the remote control decreases, replace the batteries. Use two R6(SUM-3)/AA(15F) type dry-cell batteries.

- Supplied batteries are for initial setup. Replace for continued use.

CAUTION:

Follow these precautions to avoid leaking or cracking cells:

- Place batteries in the remote control so they match the polarity: (+) to (+) and (-) to (-).
- Use the correct type of batteries. Batteries that look similar may differ in voltage.
- Always replace both batteries at the same time.
- Do not expose batteries to heat or flame.

When using the remote control, aim the remote control directly at the remote sensor on the front panel.

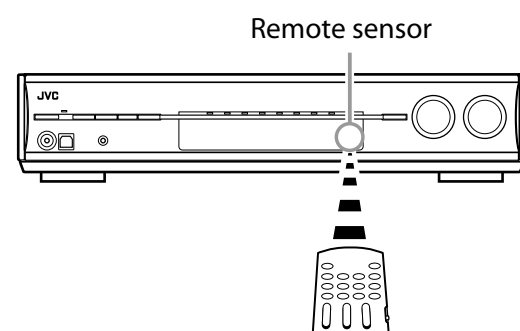

Connecting the antennas

Do not connect the AC power cord until all other connections have been made.

■ Connecting FM and AM antennas

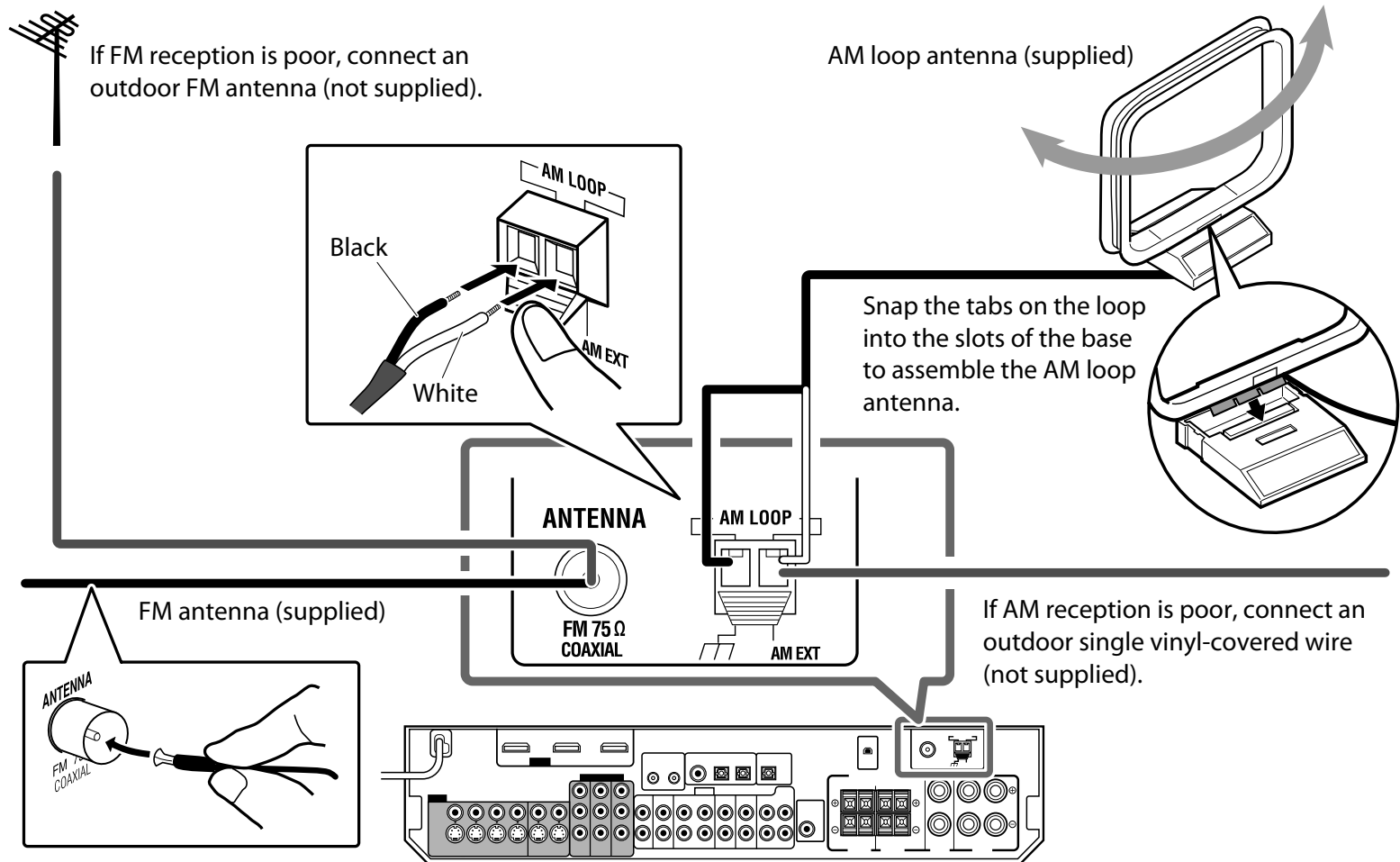

AM antenna connection

Connect the AM loop antenna (supplied) to the AM LOOP terminals: Connect the white cord to the AM EXT terminal, and connect the black cord to the ⏏ terminal.

Turn the loop until you have the best reception.

- If the reception is poor, connect an outdoor single vinyl-covered wire (not supplied) to the AM EXT terminal. Keep the AM loop antenna connected.

FM antenna connection

Connect the supplied FM antenna to the FM 75 Ω COAXIAL terminal as a temporary measure.

Extend the supplied FM antenna horizontally.

- If the reception is poor, connect an outdoor FM antenna (not supplied). Before attaching a 75 Ω coaxial cable with a connector, disconnect the supplied FM antenna.

NOTES

- If the AM loop antenna wire is covered with vinyl, remove the vinyl while twisting it as shown on the right.
- Make sure the antenna conductors do not touch any other terminals, connecting cords and power cord. This could cause poor reception.

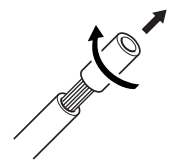

■ Connecting the XM Passport System (XM Passport and XM Passport Home Dock)*

To enjoy XM Satellite Radio, connect the XM Passport System (not supplied) to the receiver.

* You can also use the conventional XM Connect and Play Digital Antenna (not supplied) for the receiver.

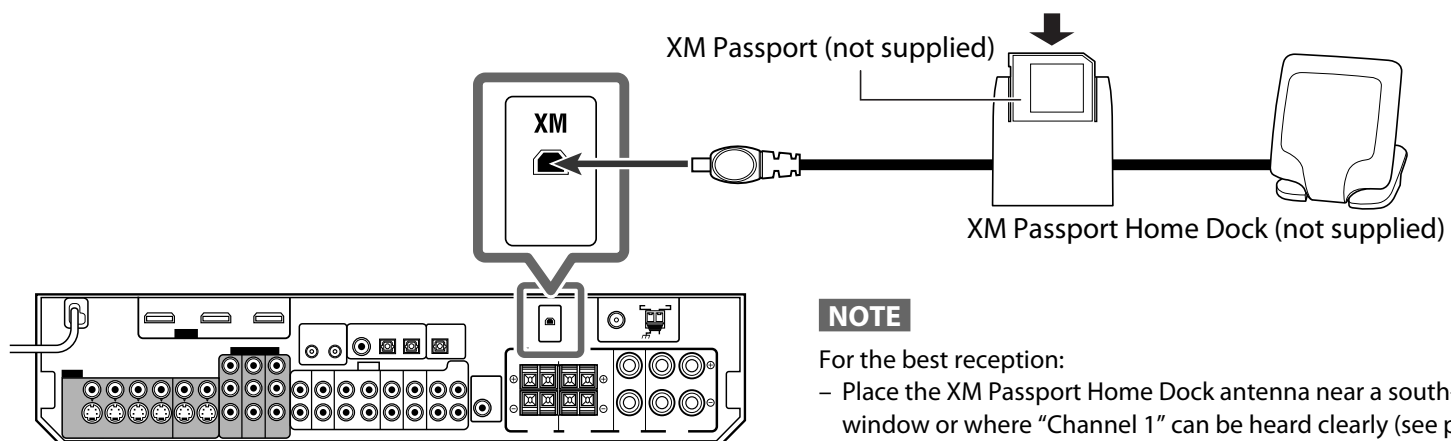

NOTE

For the best reception:

- Place the XM Passport Home Dock antenna near a south-facing window or where "Channel 1" can be heard clearly (see page 26).
- Make sure there is no obstruction between the XM Passport Home Dock antenna and the sky.

Connecting the speakers

Do not connect the AC power cord until all other connections have been made.

Speaker Layout Diagram

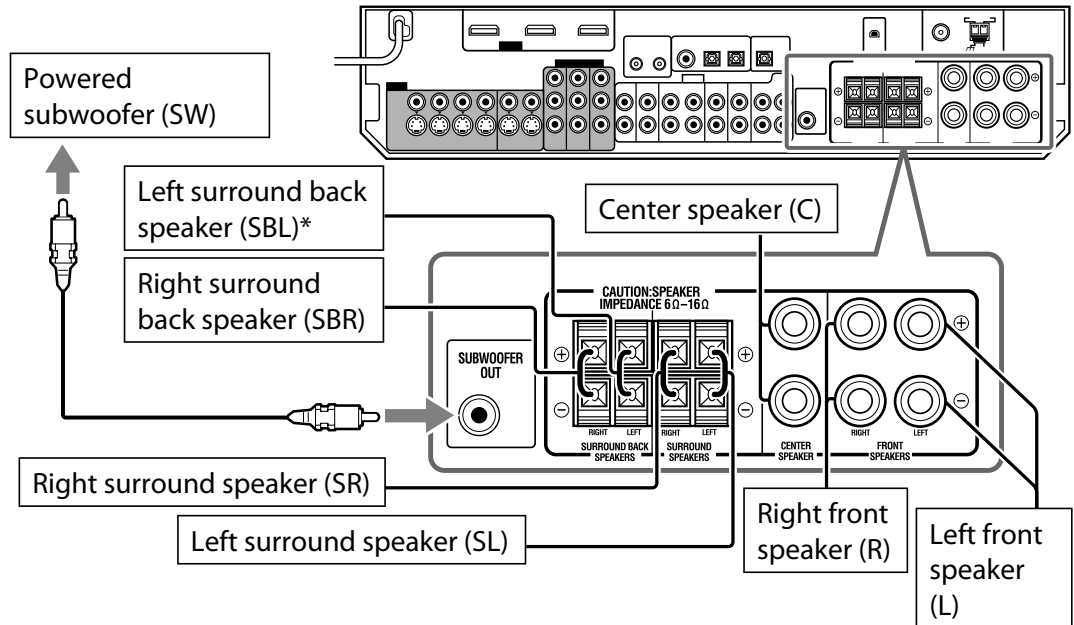
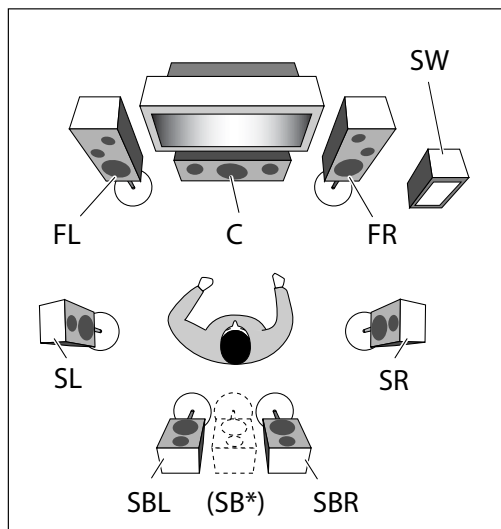

CAUTIONS:

- Use speakers with the SPEAKER IMPEDANCE indicated by the speaker terminals (6 Ω – 16 Ω).
- DO NOT connect more than one speaker to one speaker terminal.

Connecting the speakers

Turn off all components before making connections.

To connect the center speaker and the front speakers

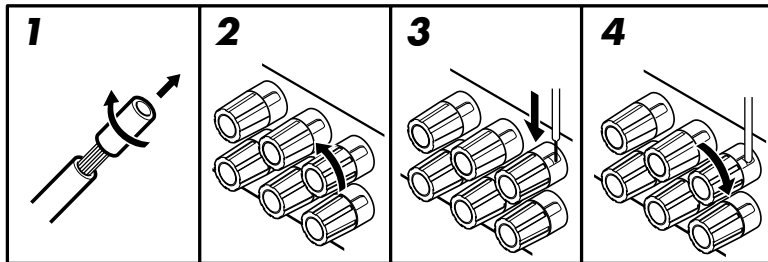

1 Cut, twist and remove the insulation at the end of each speaker cord.

2 Turn the knob counterclockwise.

3 Insert the speaker cord.

- For each speaker, connect the (+) and (-) terminals on the rear panel to the (+) and (-) terminals marked on the speakers.

4 Turn the knob clockwise.

To connect the surround speakers and the surround back speakers

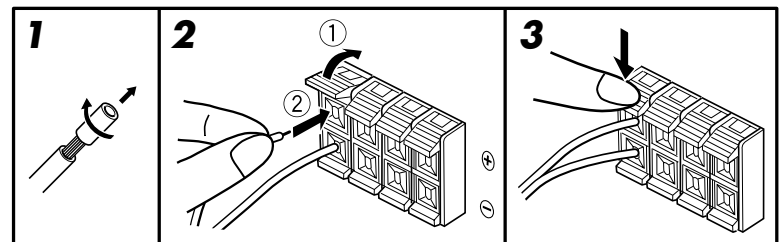

1 Cut, twist and remove the insulation at the end of each speaker cord.

2 Open the terminal (1), then insert the speaker cord (2).

- For each speaker, connect the (+) and (-) terminals on the rear panel to the (+) and (-) terminals marked on the speakers.

3 Close the terminal.

*** When using a single speaker for the surround back speaker**

You can enjoy the surround sound by one surround back speaker. When using one surround back speaker,

- set "S BACK OUT" to "1SPK" (see page 31) and
- connect the surround back speaker to the left surround back speaker terminal. **(No sound comes from the speaker if you connect it to the right surround back speaker terminal.)**

Connecting the powered subwoofer

By connecting a subwoofer, you can enhance the bass or reproduce the original LFE signals recorded in digital software. **Connect the input jack of a powered subwoofer to the SUBWOOFER OUT jack on the rear panel, using a cord with RCA pin plugs (not supplied).**

- Refer also to the manual supplied with your subwoofer.

After connecting all the speakers and/or subwoofer, perform Precise Surround Setup to adjust the speaker settings automatically (see pages 16 to 19).

NOTE

You can place a subwoofer wherever you like since bass sound is non-directional. Normally place it in front of you.

Connecting video components

Do not connect the AC power cord until all other connections have been made.

HDMI connection

IMPORTANT:

The HDMI video signals from the HDMI terminals are transmitted only through the HDMI MONITOR OUT terminal.

Therefore, you cannot view the playback picture on the TV:

- when the TV is connected to the receiver through the VIDEO jack (MONITOR OUT), S-VIDEO jack (MONITOR OUT), or COMPONENT VIDEO jacks (MONITOR OUT) and
- when a playing video component is connected to the receiver through the HDMI terminal—VCR(DBS) IN or DVR/DVD IN as well.

Turn off all components before making connections.

- When you connect the components, refer also to their manuals.

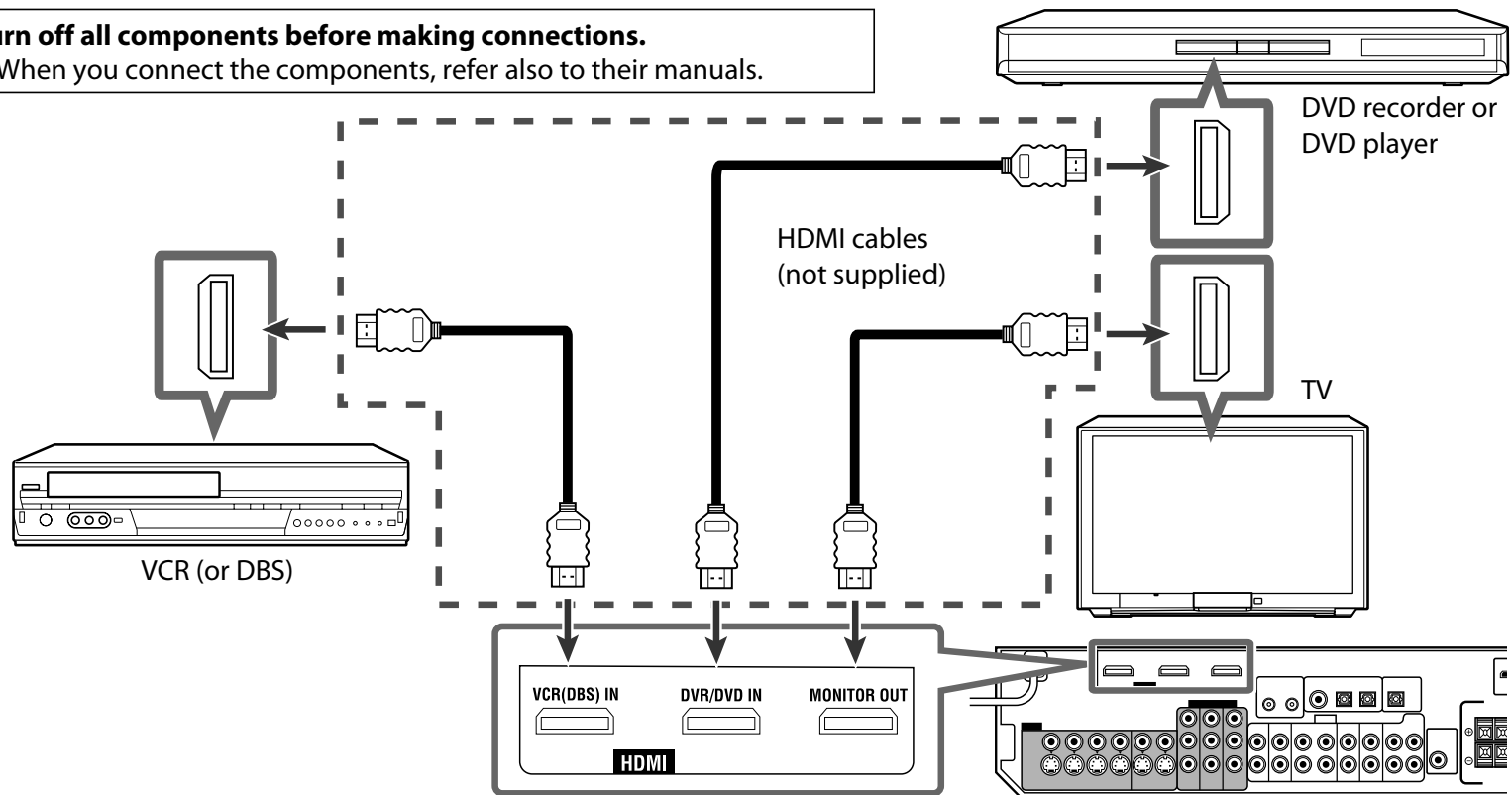

Converting video signals into HDMI signals

This receiver can convert composite video, S-video, and component video signals into HDMI signals and transmit the converted signals through the HDMI MONITOR OUT terminal. To use this function, you need to make the following procedure beforehand:

- ① Connect your TV and this receiver with the HDMI cable.
- ② Set the video output setting (see page 34) to "HDMI."
- ③ Set the video input setting (see page 21) according to the connection method for each video component.

NOTES

- When playing back audio and video with the HDMI connection, the HDMI lamp on the front panel is lit.
- Select "HDMI" for the audio input setting (see page 21) when you enjoy sound with the HDMI connection.
- With input video signals converted into HDMI signals, the playback picture may be distorted when you change the playback mode (fast-forward, rewind, or pause, for example).
- When connecting a VCR or DBS to the HDMI VCR(DBS) IN terminal, set the HDMI select setting (see page 34) correctly according to the equipment you connect. If you do not, you cannot view the playback picture on the TV.
- By using an HDMI-DVI conversion cable, you can connect the source components or the TV with DVI output. When connecting those components or TV, change the audio input setting to other than "HDMI." (See page 21.)
- This receiver is compatible with standard video formats. If non-standard video formats are coming in, the picture may not appear properly on TV.
- The picture on the TV may not be the same aspect ratio as the ratio set on the source components.
- HDMI (High-Definition Multimedia Interface) is an interface which makes it possible to transmit digital audio and video signals with one cable. However, when connecting a TV to this receiver with an HDMI cable, the sound coming into this receiver is not transmitted to the speakers of the TV. You can enjoy sound only from the speakers connected to this receiver.
- When connecting a TV to the receiver with an HDMI cable, the following may cause noise or interrupt the sound and picture:
 - Turning a source component on or off
 - Changing the audio or video input setting of this receiver frequentlyIn this case, turn the receiver off, then turn it on again.
- When enjoying multi-channel PCM sound and selecting "HDMI" for the audio input setting (see page 21), some functions are not available. See page 11 for details.
- When you enjoy HDCP contents, sound and picture may not be transmitted to the speakers and TV for a few seconds in the beginning for confirmation.

■ Audio/video connection

In addition to the HDMI terminals, this receiver is equipped with three video terminals—composite video, S-video, and component video terminals, and two audio jacks—analogue discrete 5.1 channel audio input jacks (DVD MULTI IN) and stereo audio jacks.

- If your video components have S-video (Y/C-separation) and/or component video (Y, Pb, Pr) jacks, connect them using an S-video cable (not supplied) or component video cable (not supplied). By using these terminals, you can get a better picture quality in the order:

Component > S-video > Composite

IMPORTANT:

The video signals from one type of these input jacks are transmitted only through the video output jacks of the same type. Therefore, if a recording video component and a playing video component are connected to the receiver through the video terminals of different type, you cannot record the picture. In addition, if the TV and a playing video component are connected to the receiver through the video terminals of different type, you cannot view the playback picture on the TV.*

DO NOT use a TV through a VCR or a TV with a built-in VCR; otherwise, the picture may be distorted.

CAUTION:

If you connect a sound-enhancing device such as a graphic equalizer between the source components and this receiver, the sound output through this receiver may be distorted.

If your video components have AV COMPU LINK terminals

See also page 45 for detailed information about the connection and the AV COMPU LINK remote control system.

- * When connecting the TV to the receiver through the HDMI MONITOR OUT terminal and selecting "HDMI" for the video output setting, you can view the playback picture on the TV.

Do not connect the AC power cord until all other connections have been made.

Connecting a DVD recorder or DVD player with its stereo output jacks:

Turn off all components before making connections.

- When you connect the components, refer also to their manuals.

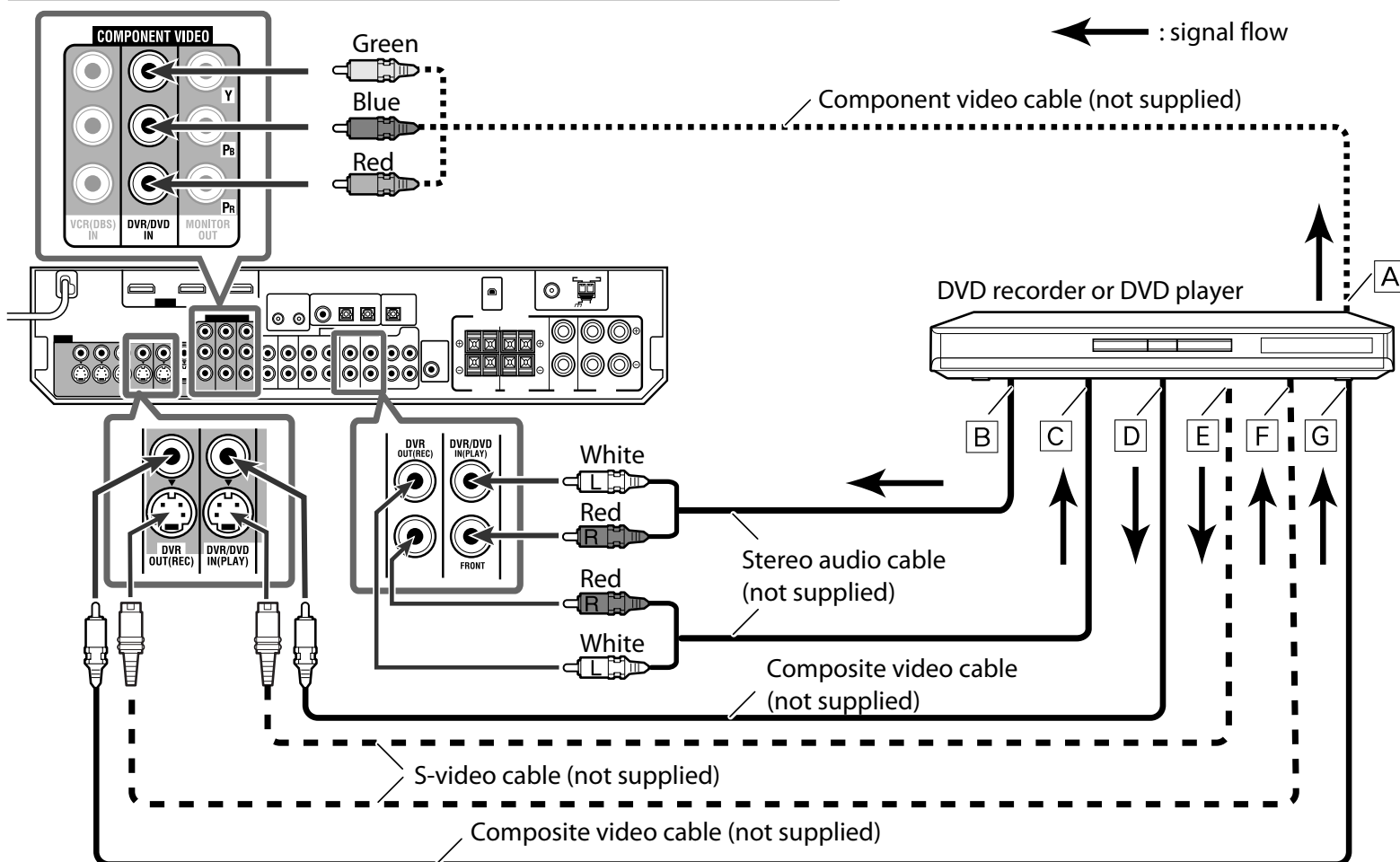

NOTES

- Select the audio and video input setting according to the connection method. See page 21 for details.
- You can enjoy digital sound if using a digital coaxial or optical cable. When shipped from the factory, the digital coaxial terminal—DIGITAL IN 1 (DVR/DVD) on the rear of the receiver is set for a DVD recorder and DVD player. For details of digital audio connection, see page 14.

- A To component video output
 - Connect Y, Pb, and Pr correctly.
- B To left/right audio channel output
- C **Only for DVD recorder:** To left/right audio channel input
- D To composite video output
- E To S-video output
- F **Only for DVD recorder:** To S-video input
- G **Only for DVD recorder:** To composite video input

Do not connect the AC power cord until all other connections have been made.

Connecting a DVD recorder or DVD player with its analog discrete output jacks (DVD MULTI IN):

If your DVD recorder or DVD player has analog 5.1 channel output jacks, use the connection below. When a DVD-Audio disc is played back, the original high-quality multi-channel sounds can be reproduced by using this connection.

Turn off all components before making connections.

- When you connect the components, refer also to their manuals.

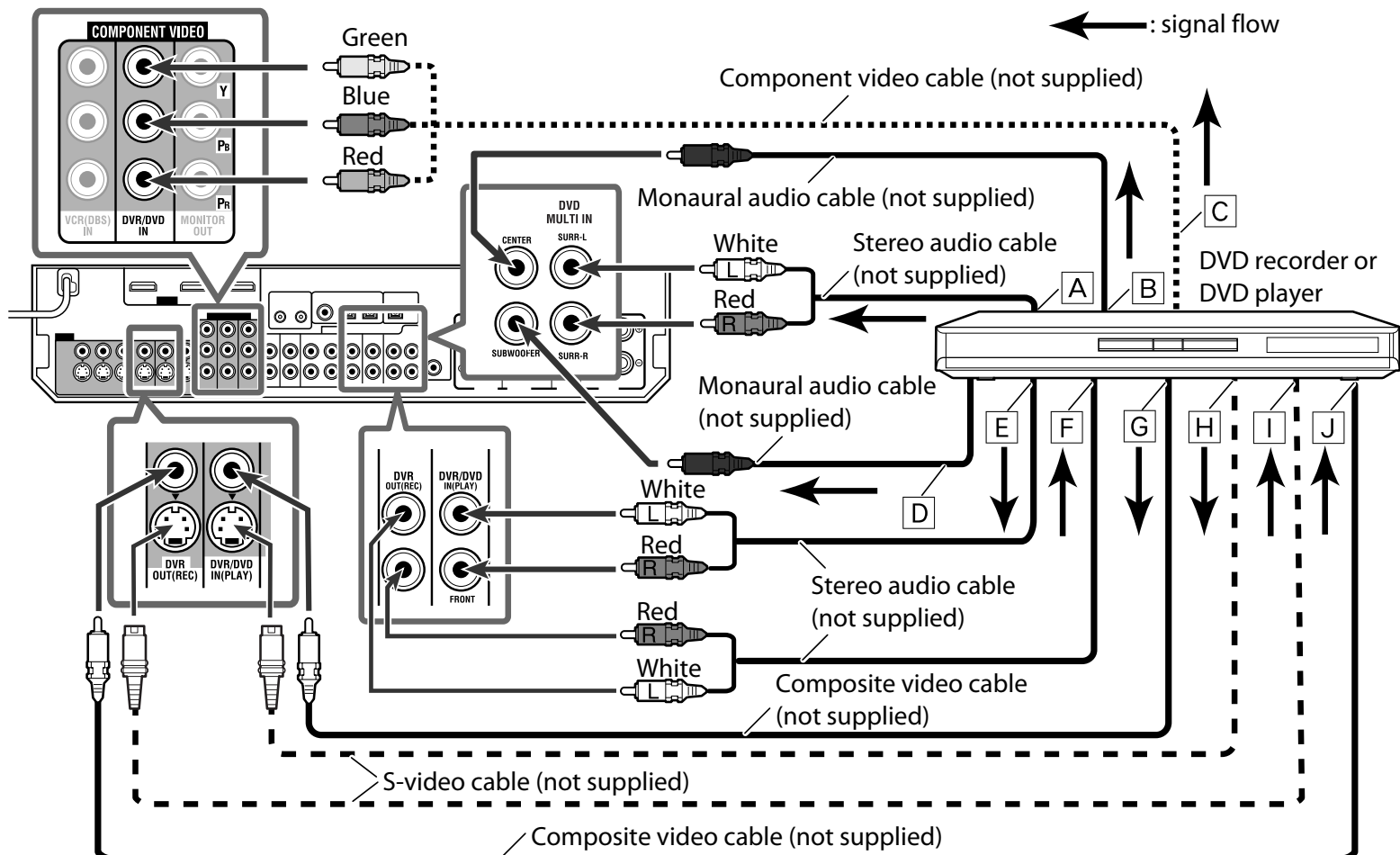

- A To left/right surround channel audio output
- B To center channel audio output
- C To component video output
 - Connect Y, Pb, and Pr correctly.
- D To subwoofer output
- E To left/right front channel audio output

- F **Only for DVD recorder:** To left/right front channel audio input
- G To composite video output
- H To S-video output
- I **Only for DVD recorder:** To S-video input
- J **Only for DVD recorder:** To composite video input

When you enjoy the sound recorded in DVD-Audio...

You can enjoy the sound recorded in DVD-Audio with either analog or digital methods.

– With analog method:

1. Connect your DVD recorder or DVD player to this receiver according to the diagram above.
2. Select "A MULTI" for the audio input setting. (See page 21.)

– With digital method:

1. Connect your DVD recorder or DVD player and TV to this receiver with the HDMI cables. (See page 9.)
2. Select "HDMI" for the audio input setting. (See page 21.)

NOTES

- When selecting "A MULTI" for the audio input setting and using the headphones, you can listen to the front channel sounds (left and right) only. The 3D HEADPHONE mode (see page 42) is not available.
- When selecting "A MULTI" for the audio input setting or when multi-channel PCM signals (see page 41) are coming in with selecting "HDMI" for the audio input setting, the following items are not available:
 - Precise Surround Setup (see pages 16 to 19)
 - Decode mode (see page 22)
 - CC Converter (see page 23)
 - EX/ES/PLIIX (see page 32)
 - Dual Mono (see page 32)
 - Subwoofer output (see page 33)
 - Crossover frequency (see page 33)
 - Low frequency effect attenuator (see page 33)
 - Midnight mode (see page 33)
 - Digital equalization patterns (see page 36)
 - Bass Boost (see page 37)
 - Input attenuator mode (see page 37)
 - Sound parameters for Surround/DSP modes (see pages 37 and 38)
 - Surround/DSP mode selection (see page 44)
- The audio delay level setting (see page 34) does not take effect when selecting "A MULTI" for the audio input setting.
- When you enjoy the sound recorded in DVD-Audio through the HDMI connection, use a DVD recorder or DVD player compatible with HDMI version 1.1.

Do not connect the AC power cord until all other connections have been made.

Turn off all components before making connections.

- When you connect the components, refer also to their manuals.

Connecting a VCR:

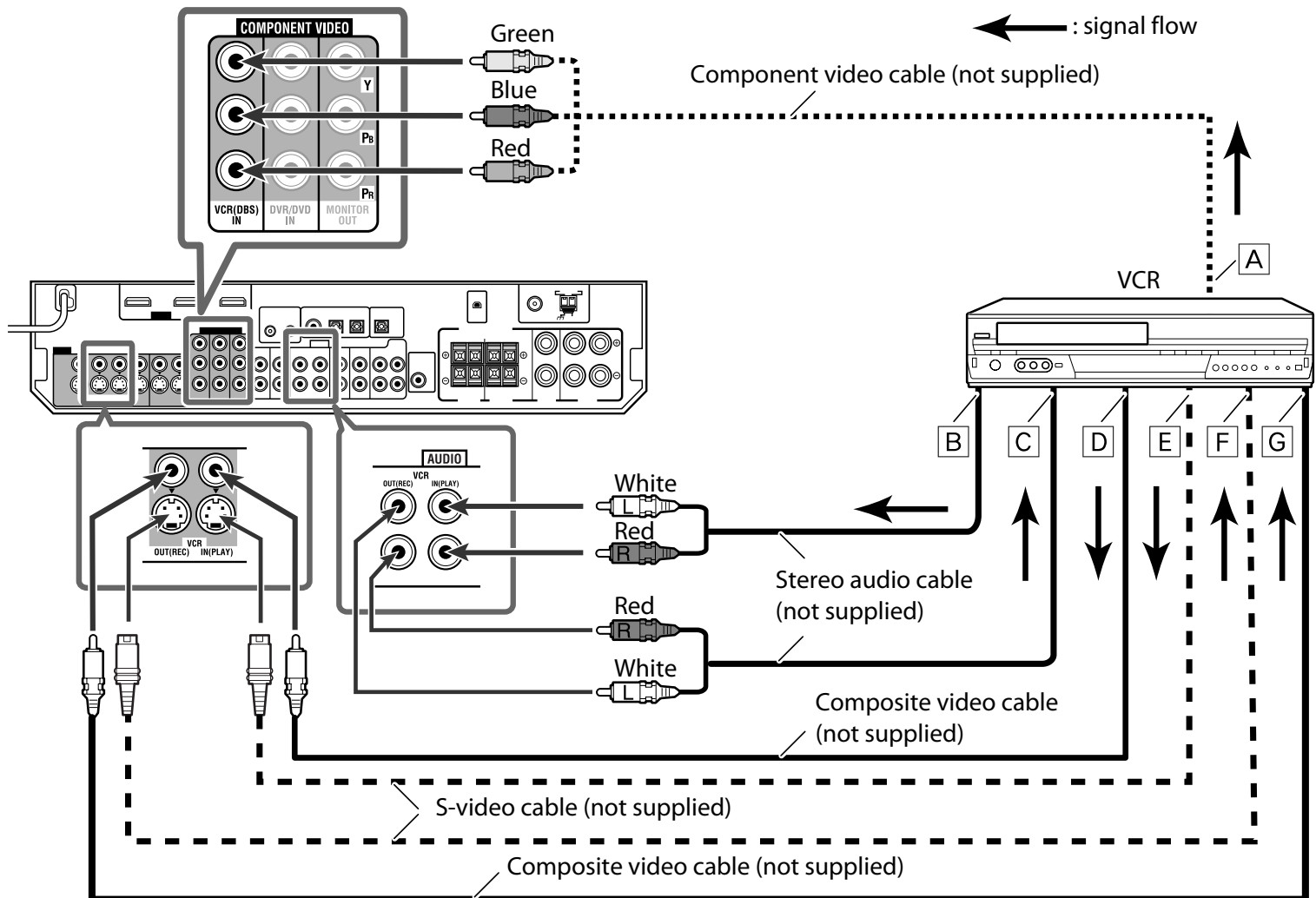

NOTES

- Select the audio and video input settings according to the connection method. See page 21 for details.
- When connecting a VCR to the COMPONENT VIDEO jacks, select "VCR" for the COMPONENT select setting (see page 34); otherwise, the following occurs:
 - You cannot view the playback picture on the TV.
 - The AV COMPU LINK remote control system (see pages 45 and 46) cannot operate properly.
- You can enjoy digital audio if using a digital coaxial or optical cable. When shipped from the factory, the digital optical terminal—DIGITAL IN 3(VCR) on the rear of the receiver is set for a VCR. For details of the digital audio connection, see page 14.

- A** To component video output
 - Connect Y, Pb, and Pr correctly.
- B** To left/right audio channel output
- C** To left/right audio channel input
- D** To composite video output
- E** To S-video output
- F** To S-video input
- G** To composite video input

Connecting a SIRIUS Satellite Radio

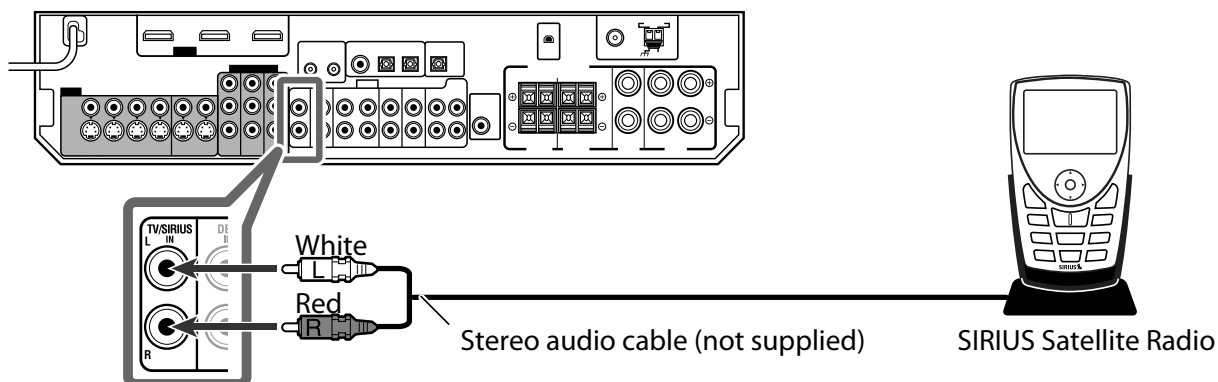

NOTES

- To connect KT-SR2000 (JVC SIRIUS Satellite Radio) to this receiver, it is required to separately purchase KS-K6013 Home Docking Kit.
- You cannot use a digital audio cable (coaxial or optical) to connect a SIRIUS Satellite Radio to this receiver.
- After connecting a SIRIUS Satellite Radio to the TV/SIRIUS IN jacks, change the source name to "SIRIUS." See page 20 for details.

Do not connect the AC power cord until all other connections have been made.

Turn off all components before making connections.

- When you connect the components, refer also to their manuals.

Connecting a DBS tuner:

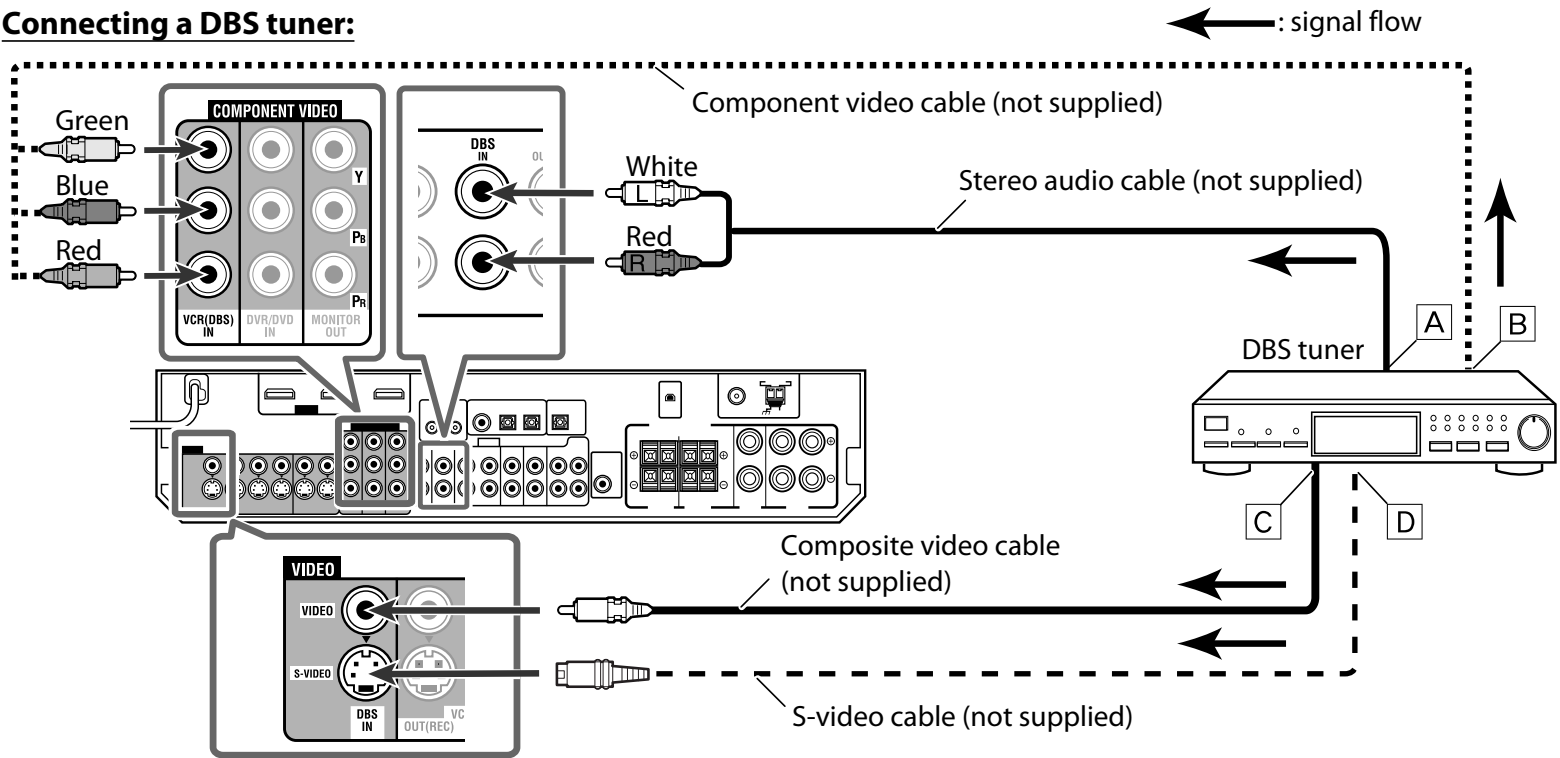

NOTES

- Select the audio and video input setting according to the connection method. See page 21 for details.
- When connecting a DBS tuner to the COMPONENT VIDEO jacks, select "DBS" for the COMPONENT select setting (see page 34); otherwise, you cannot view the playback picture on the TV.
- You can enjoy digital sound if using a digital coaxial or optical cable. When shipped from the factory, the digital optical terminal—DIGITAL IN 2(DBS) on the rear of the receiver is set for a DBS tuner. For details of digital audio connection, see page 14.

- A** To left/right audio channel output
- B** To component video output
 - Connect Y, Pb, and Pr correctly.
- C** To composite video output
- D** To S-video output

Connecting a TV:

Connect the TV to the appropriate MONITOR OUT jacks to view the playback picture from any other connected video components.

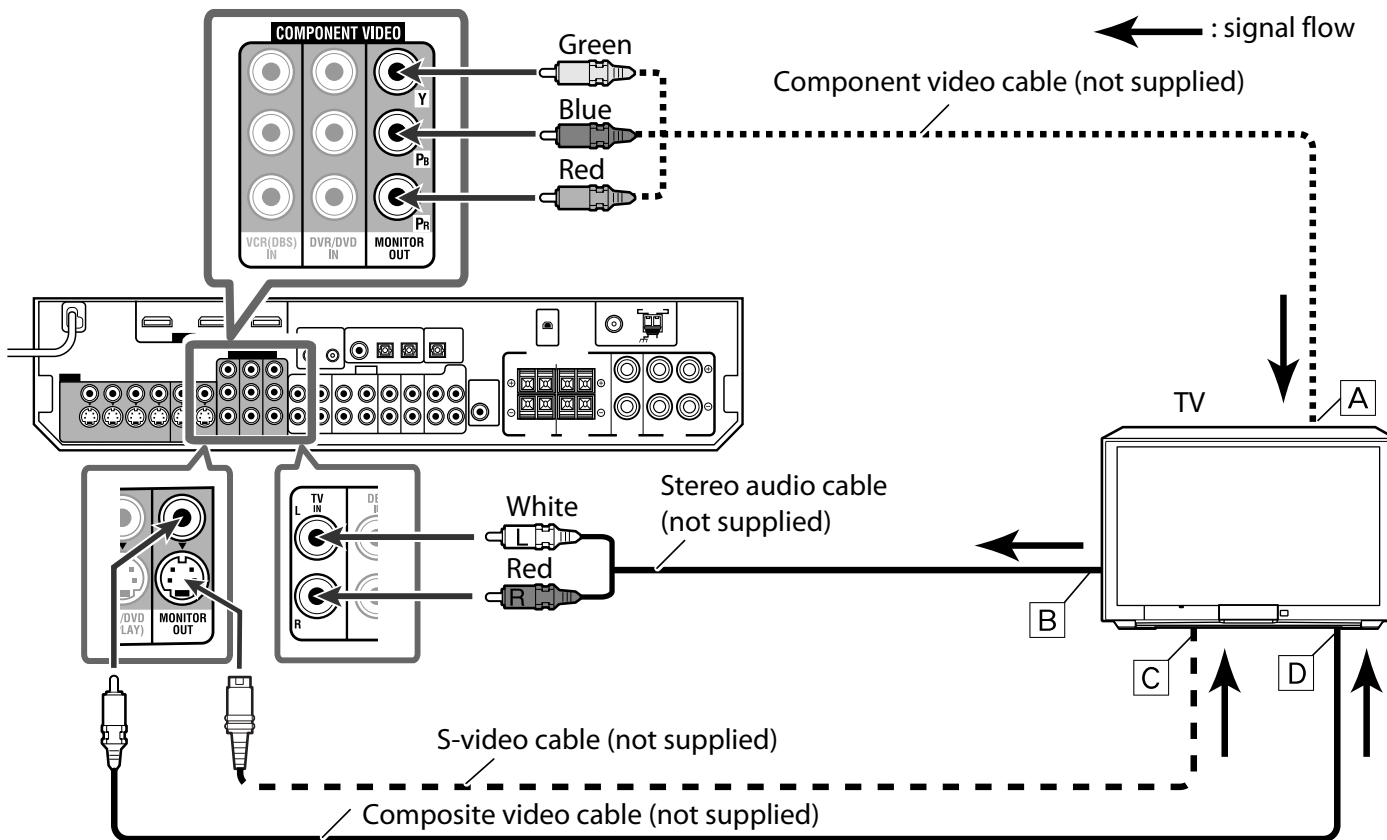

NOTES

- Select the audio input setting according to the connection method. See page 21 for details.
- You can enjoy digital sound if using a digital coaxial or optical cable. For details of the digital audio connection, see page 14.
- Select "OTHER" for the video output setting (see page 34).

- A** To component video input
 - Connect Y, Pb, and Pr correctly.
- B** To left/right audio channel output
- C** To S-video input
- D** To composite video input

Digital audio connection

This receiver is equipped with three DIGITAL IN terminals—one digital coaxial terminal and two digital optical terminals—and one DIGITAL OUT terminal.

To reproduce the digital sound, use the digital audio connection in addition to the analog audio connection methods described on pages 10 to 13.

Digital coaxial cable (not supplied)



Digital optical cable (not supplied)



Turn off all components before making connections.

- When you connect the components, refer also to their manuals.

Digital input terminals:

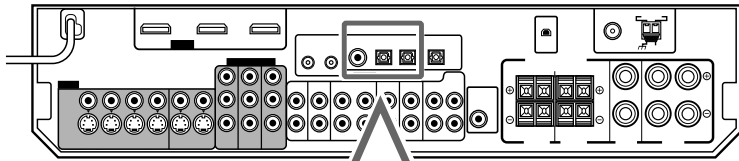

When the component has a digital coaxial output terminal, connect it to the 1(DVR/DVD) terminal, using a digital coaxial cable (not supplied).

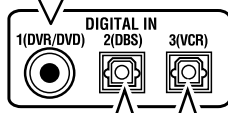

When the component has a digital optical output terminal, connect it to the 2(DBS) or 3(VCR) terminal, using a digital optical cable (not supplied).

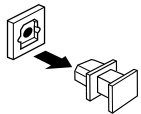

Before connecting a digital optical cable, unplug the protective plug.

NOTES

- When shipped from the factory, the DIGITAL IN terminals have been set for use with the following components:
 - 1(DVR/DVD): For DVD recorder or DVD player
 - 2(DBS): For DBS tuner
 - 3(VCR): For VCR
- If you connect the components, change the digital input (DIGITAL IN) terminal setting correctly. See "Setting the digital input (DIGITAL IN) terminals—DIGITAL IN 1/2/3" on page 34.
- Select "DIGITAL" for the audio input setting (see page 21).

Digital output terminal:

You can connect any digital components which have an optical digital input terminal.

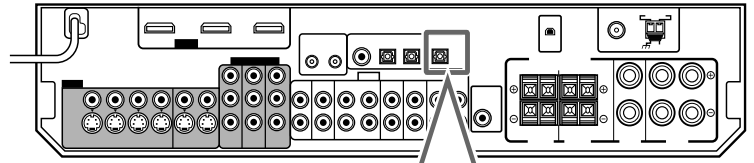

Connecting digital recording equipment to the DIGITAL OUT terminal enables you to perform digital-to-digital recording.

NOTES

- The digital signal format transmitted through the DIGITAL OUT terminal is the same as that of the input signal. For example, when the DTS signals are input, the DTS signals are transmitted.
- The digital signal coming through the USB terminal, HDMI input terminal and XM jack cannot be output from the DIGITAL OUT terminal.

Connecting the power cord

When all the audio/video connections have been made, connect the AC power plug to the wall outlet. Make sure that the plugs are inserted firmly.

- The standby lamp lights in red.

CAUTIONS:

- Do not touch the power cord with wet hands.
- Do not alter, twist or pull the power cord, or put anything heavy on it, which may cause fire, electric shock, or other accidents.
- If the cord is damaged, consult a dealer and have the power cord replaced with a new one.

NOTES

- Keep the power cord away from the connecting cables and the antennas. The power cord may cause noise or screen interference.
- The preset settings such as preset channels and sound adjustment may be erased in a few days in the following cases:
 - When you unplug the power cord.
 - When a power failure occurs.
- When you unplug the power cord with the receiver on and connect the power cord again, the receiver enters standby mode.

USB connection

This receiver is equipped with a USB terminal on the front panel. You can connect your PC to this terminal and enjoy sound reproduced through your PC.

When you connect your PC for the first time, follow the procedure below.

- Remember you cannot send any signal or data to your PC from this receiver.

IMPORTANT:

Check if your PC equipped with the CD-ROM drive is running on Windows® 98 SE*, Windows® Me*, Windows® 2000*, or Windows® XP* and prepare its CD-ROM.

How to install the USB drivers

The following procedure is described using the English version of Windows® XP*. If your PC is running on a different version or language of operating system, the windows shown on your PC monitor will differ from the ones used in the following procedure.

See pages 20 and 21 for the operations of the receiver.

1 Turn on your PC.

- If the PC has been turned on, quit all the applications now running.

2 Turn on the receiver, and select the source as "USB."

3 Set the volume to minimum.

IMPORTANT:

Always set the volume to "0" when connecting or disconnecting the other equipment.

4 Connect the receiver to the PC using a USB cable (not supplied).

- Use "USB series A plug to B plug" cable when connecting.

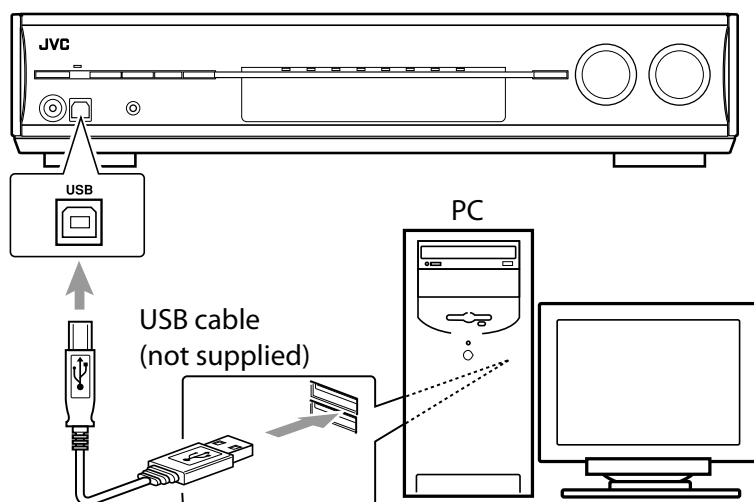

The USB drivers are installed automatically.

- If the USB drivers are not installed automatically, install the USB drivers by following the instructions on the PC monitor.

5 Check if the drivers are correctly installed.

1. Open the Control Panel on your PC:
Select [Start] → [Control Panel].
 2. Select [System] → [Hardware] → [Device Manager] → [Sound, video and game controllers] and [Universal Serial Bus controllers].
- The following window appears, and you can check if the drivers are installed.

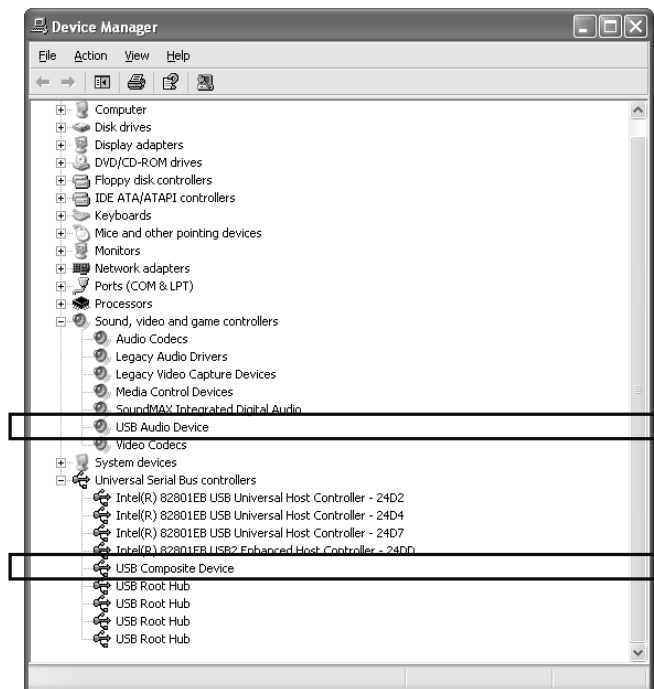

Now your PC is ready for playback through the USB connection.

After installation is completed, you can use your PC as the playback source. The PC automatically recognizes the receiver whenever the receiver is connected by a USB cable and turned on.

- When not using the PC as the playback source, disconnect the USB cable from the receiver.

To play back sounds on the PC, refer to the manual supplied with the sound reproduction application installed in the PC.

If no sound comes from the speakers, check the following:

- Select "USB" as the source.
- Connect the USB cable correctly.
- Check the receiver is recognized by the PC properly (see above).
- Check the playback software is compatible with the PC.
- Open the Control Panel on your PC, select [Sounds and Audio Devices] → [Audio] tab → [Sound playback] → [Default device], and check [Default device] is set to [USB Audio DAC].

NOTES

- DO NOT turn off the receiver or disconnect the USB cable while installing the drivers and while your PC is recognizing the receiver.
- Use a USB cable (version 1.1 or later). Recommended cord length is less than 1.5 m.
- If your PC does not recognize the receiver, disconnect the USB cable and connect it again. If it does not work yet, restart Windows®*.
- The installed drivers can be recognized only when the USB cable is connected between the receiver and your PC.
- The sound may not be played back correctly—interrupted or degraded—due to your PC settings and PC specifications.

* Microsoft®, Windows® 98 SE, Windows® Me, Windows® 2000, and Windows® XP are registered trademarks of Microsoft corporation.

Precise Surround Setup

By using Precise Surround Setup, you can optimize the speaker settings easily, quickly and systematically without troublesome adjustments. To obtain the best possible sound effect from the Surround/DSP modes, set up the speaker and subwoofer information after all the connections are completed.

Setting the speakers automatically

Precise Surround Setup detects the sound from the speakers to measure your listening environment with dedicated earphone-type microphones (supplied), and automatically adjusts the following in less than 1 minute:

- Speaker size*
- Speaker distance*
- Speaker output level*
- Crossover frequency*
- Frequency response

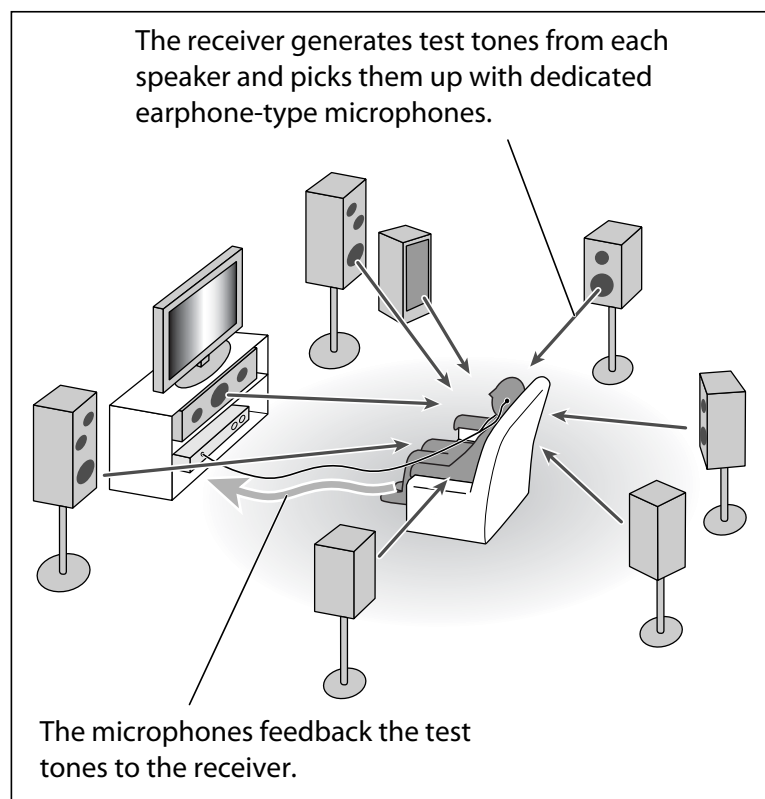

* You can also adjust the settings manually. (See pages 29 to 31, and 33.)

Before starting Precise Surround Setup

- Connect all of your speakers and subwoofer correctly and confirm their position.
- When subwoofer has a built-in volume and crossover frequency controls, adjust them as follows:
 - Set the volume level to the medium.
 - Set the crossover frequency to the highest level.
- Precise Surround Setup is not available in the following cases:
 - While headphones are connected
 - When selecting "A MULTI" for the audio input setting (see page 11)
 - When multi-channel PCM signals (see page 41) are coming in with selecting "HDMI" for the audio input setting (see page 11)
- Do not block between the earphone-type microphones and speakers while the microphones are picking up test tones from the speakers.
- If the microphone cord is not long enough to make a connection between the receiver and your listening position, use a stereo extension cord (not supplied).
 - You cannot get correct results with a monaural extension cord.

CAUTION:

Be sure that loud test tones will be generated from speakers during Precise Surround Setup.

- The volume of test tones is not adjustable.

Operating procedure

1 Plug the dedicated earphone-type microphones into the PRECISE SURROUND SETUP MIC jack.

- Keep the connection until Precise Surround Setup is completed.

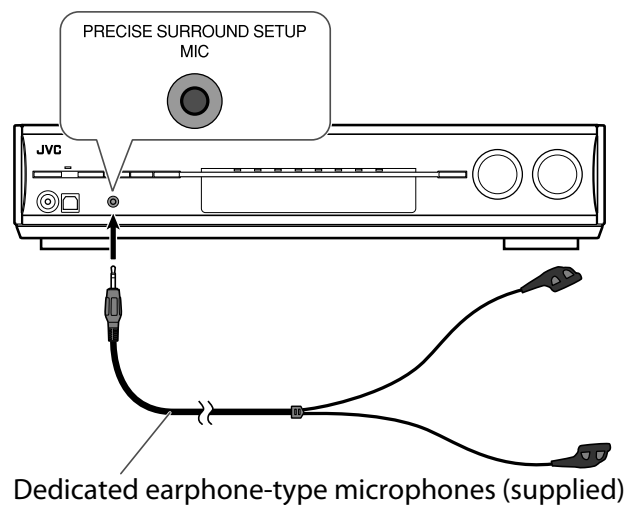

2 Press **⏻/I STANDBY/ON** (or **⏻/I AUDIO** on the remote control) to turn the power on.

- Set the volume level to the medium or lower turning the MASTER VOLUME control (see page 21).

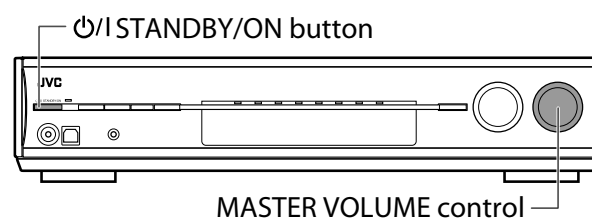

3 Put on the microphones.

- Insert the microphone with "L" into your left ear, the microphone with "R" your right ear.

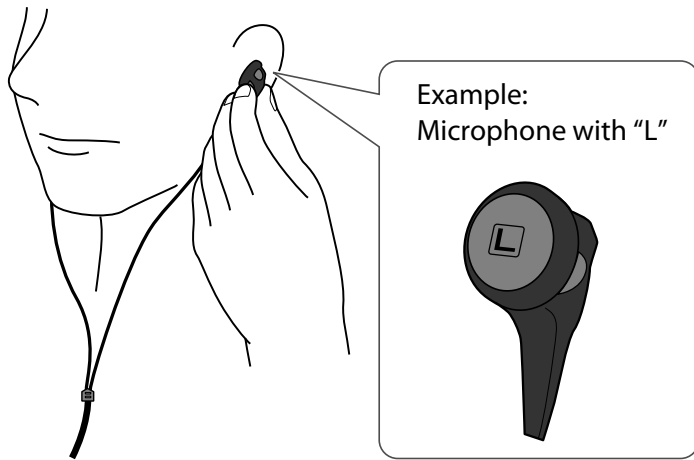

4 Take your usual listening position with the microphones and the remote control.

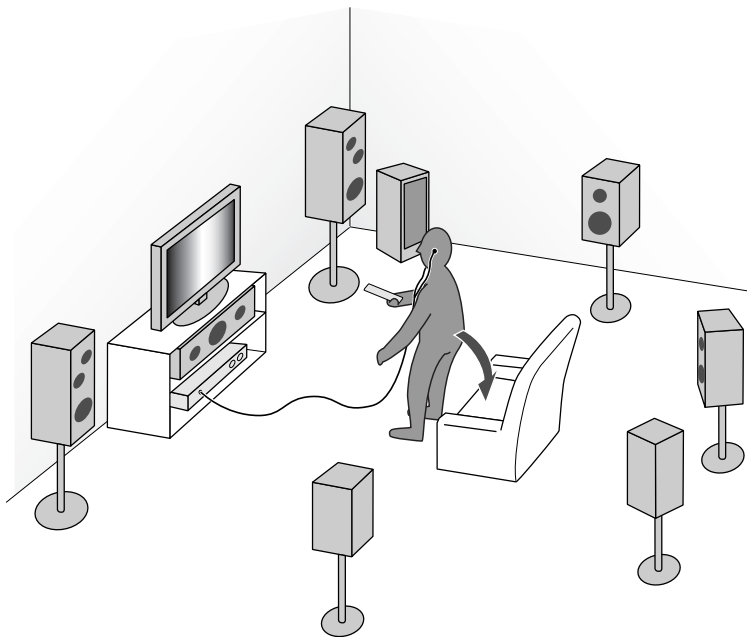

CAUTION:

Keep quiet so that Precise Surround Setup can detect test tones properly.

5 Press and hold PSS on the remote control for about 4 seconds until "PSS START" starts flashing on the display.

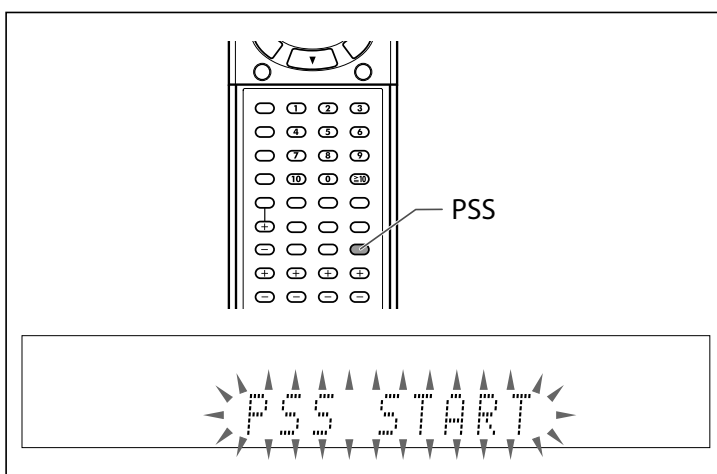

• If Precise Surround Setup is not completed properly...

An error message will appear on the display. In such a case, see "Troubleshooting for Precise Surround Setup" on page 19.

Precise Surround Setup starts detecting the speaker and subwoofer information.

- When starting Precise Surround Setup, the muting mode and Dimmer are automatically canceled.
- "MEASURING 1" flashes on the display.

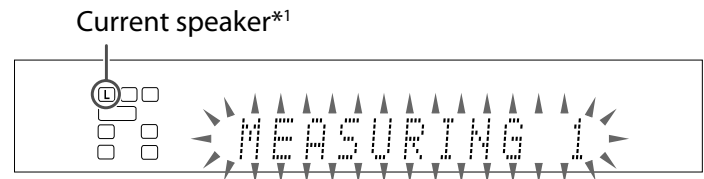

- *1 When the current speaker is the right or left surround back speaker, two surround back speaker indicators (SB) light up at a time.

A test tone comes out of each speaker in the following order, then the microphones pick up the test tones and feedback it to the receiver:

FL (Left front speaker) → C (Center speaker) → FR (Right front speaker) → SR (Right surround speaker) → SBR (Right surround back speaker)*2 → SBL (Left surround back speaker)*2 → SL (Left surround speaker) → SW (Subwoofer)

- *2 When using a single speaker for the surround back speaker, the test tone comes out of "SB (Surround back speaker)" instead of "SBR" and "SBL."

- Do not touch the microphones while the microphones are picking up the test tones.



The receiver generates test tones again. Precise Surround Setup starts detecting, adjusts the sound output level from each speaker, and corrects the frequency response of each speaker.

- "MEASURING 2" flashes on the display.

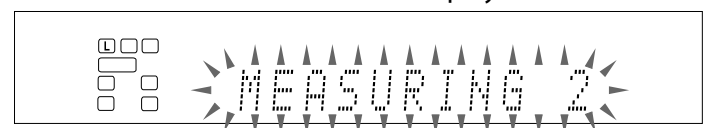

When Precise Surround Setup is completed, "COMPLETE" appears and the PSS indicator lights up on the display.

PSS indicator

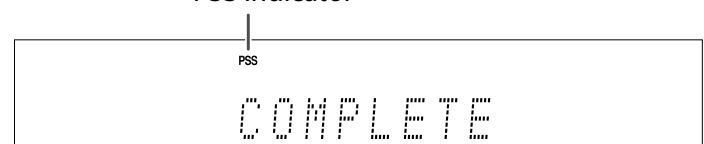

An optimized test tone comes out of each speaker so that you can confirm the results of Precise Surround Setup, and the corrected frequency response of each speaker appears on the display at the same time.

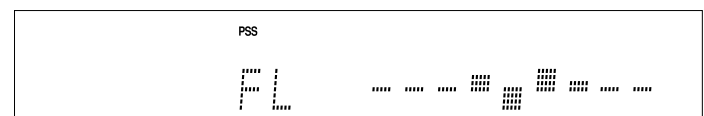

- See "Checking the frequency responses corrected by Precise Surround Setup" on page 18 about the frequency responses on the display.



The receiver automatically returns to the normal operation mode after all the test tones have been output from the speakers.

Continued on the next page

6 Unplug the earphone-type microphones.

- When unplugging the microphones, pull on the plug, not the cord itself.

NOTES

- Do not press any buttons on the remote control or the front panel of the receiver during Precise Surround Setup; otherwise, the receiver stops setting and returns to the normal operation mode.
 - After "COMPLETE" is displayed, the Precise Surround Setup results are applied to the speaker settings.
- The speaker size measured by Precise Surround Setup may be different from that of the manual setting recommendation (see page 30). Precise Surround Setup measures the speaker size not only by the cone speaker size but also by the other speaker features.
- There may be a case that the receiver fails to detect subwoofer and does not activate it (no optimized test tone comes out of the subwoofer).
In such a case, set the volume level of the subwoofer higher and perform Precise Surround Setup again.
- When you change your listening environment, such as speakers, speaker position, your listening position or so, perform Precise Surround Setup again to optimize the speaker settings.
- Depending on the listening environment, Precise Surround Setup may not measure the speaker settings accurately. In such a case, adjust the settings manually. See pages 29 to 31, and 33.
- The supplied earphone-type microphones cannot be used as headphones.
- When the AV COMPU LINK remote control system works during Precise Surround Setup, this receiver stops setting and returns to the normal operation mode.

Turning the frequency optimizing function off

After performing Precise Surround Setup, the receiver optimizes the frequency response for each speaker. You can turn the frequency optimizing function off.

Press PSS to turn the frequency optimizing function off.

- Each time you press the button, the frequency optimizing function alternates between on and off. When the function is activated, the PSS indicator is lit.

NOTE

This function is not available:

- Until Precise Surround Setup has been completed at least once; otherwise, "NO PSS" appears on the display.
- When selecting "A MULTI" for the audio input setting (see page 11).
- When multi-channel PCM signals (see page 41) are coming in with selecting "HDMI" for the audio input setting (see page 11).

Checking the frequency responses corrected by Precise Surround Setup

You can check the current settings of the frequency responses with test tones from speakers and the indications on the display when the frequency optimizing function is activated.

From the remote control ONLY:

1 Press TEST to check the frequency response of each speaker on the display.

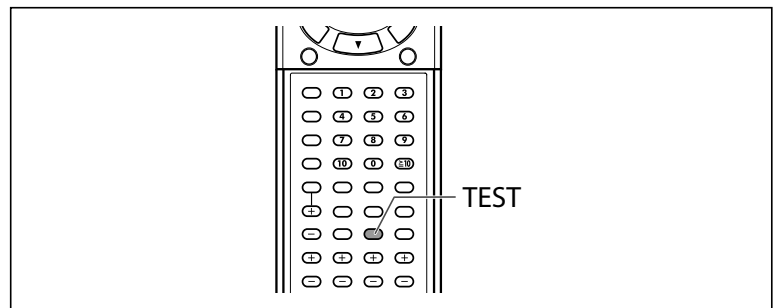

- A test tone also comes from each speaker in the following order:

FL (Left front speaker) → C (Center speaker) → FR (Right front speaker) → SR (Right surround speaker) → SBR (Right surround back speaker)* → SBL (Left surround back speaker)* → SL (Left surround speaker) → SW (Subwoofer)
* When using a single speaker for the surround back speaker, the test tone comes out of "SB (Surround back speaker)" instead of "SBR" and "SBL."

- The frequency response of each speaker appears on the display as follows:

EX. 1: When a test tone comes from the left front speaker

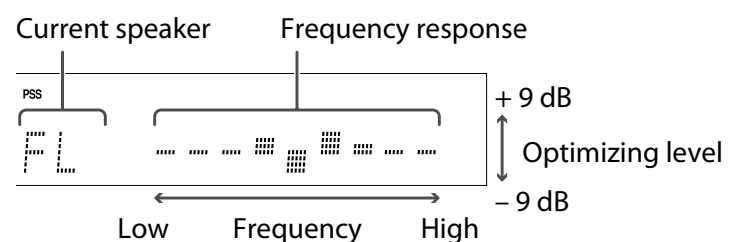

EX. 2: When a test tone comes from the subwoofer



2 Press TEST again to stop the test tone.

NOTE

While the PSS indicator is off, pressing TEST generates test tones without showing frequency responses. See page 36.

Troubleshooting for Precise Surround Setup

When problems occur, a message appears on the display during Precise Surround Setup. In this case, refer to the following solution, then perform Precise Surround Setup again.

- **To restart Precise Surround Setup**, press PSS on the remote control; however, when you have turned the receiver off for the solution, start from step **2** again.

Error message	Possible cause	Solution
E01 HEADPHONE	Headphones are connected to the PHONES jack.	Unplug the headphones.
E02 NO MIC	The dedicated earphone-type microphones are not connected correctly.	Plug the microphones into the PRECISE SURROUND SETUP MIC jack on the front panel firmly.
E03 NOISY	There is some background noise.	<ul style="list-style-type: none"> • Restart in a quiet environment. • If some electronic equipment is used near the listening position, turn off the equipment such as air conditioners, etc.
E04 MIC LEVEL	The speaker is too close to the listening position.	Place the speakers farther from the listening position.
E05 NO FRONT	<ul style="list-style-type: none"> • Any of the front speakers is not connected or its connection is loose. • The microphone connection is loose. 	<ul style="list-style-type: none"> • Check the left and right front speakers connections. • Plug the microphones into the PRECISE SURROUND SETUP MIC jack on the front panel firmly.
E06 SW LEVEL	The built-in volume control of the powered subwoofer is set to too high.	Set the volume level of the subwoofer lower.
E07 LEV OVER*	The speaker is too far from the listening position or the speaker angle is inappropriate.	Adjust the speaker position and angle.
E08 DIST OVER*	The speaker is too far from the listening position.	The speaker distance is adjustable up to 9 m (30 ft). Place the speaker within the adjustable range from the listening position.
E09 F=S SW=NO*	<ul style="list-style-type: none"> • When the size of the front speakers is small, no subwoofer is detected. • The receiver might have failed to detect subwoofer. 	<ul style="list-style-type: none"> • Check the connection of the subwoofer and turn it on, or replace the front speakers with larger ones. • Set the volume level of the subwoofer higher.
E10 FRNT<SURR*	The front speakers are smaller than the surround speakers.	<ul style="list-style-type: none"> • Change the front speakers with the larger ones than the surround speakers. • Change the surround speakers with the smaller ones than the front speakers.
E11 SURR<SB*	The surround speakers are smaller than the surround back speakers.	<ul style="list-style-type: none"> • Change the surround speakers with the larger ones than the surround back speakers. • Change the surround back speakers with the smaller ones than the surround speakers.
E12 UNBALANCE*	The right-and-left front speaker size is unproportioned.	Rearrange the front speakers as their size is proportioned.
E13 UNBALANCE*	<ul style="list-style-type: none"> • Any of the surround speakers is not connected or its connection is loose. • The right-and-left surround speaker size is unproportioned. 	<ul style="list-style-type: none"> • Check the connection of the surround speakers. • Rearrange the surround speakers as their size is proportioned.
E14 UNBALANCE*	<ul style="list-style-type: none"> • The left surround back speaker is not connected or its connection is loose even though the right surround back speaker is detected. • The right-and-left surround back speaker size is unproportioned. 	<ul style="list-style-type: none"> • Check the connection of the left surround back speaker. • When using a single speaker as the surround back speaker, connect it to the left surround back speaker terminal (see page 8). • Rearrange the surround back speakers as their size is proportioned.
Warning message	Possible cause	Solution
W01 PHASE INV*	The polarity of the speaker connection is wrong.	Match the polarity of the speaker terminals (see page 8).

* The signal indicator of the corresponding speaker lights up with the error/warning message.

NOTES

- Before making speaker connections, turn the receiver off and unplug the power cord.
- If you press the source selecting button for the current source on the remote control while an error message is displayed, the receiver cancels Precise Surround Setup and returns to the normal operation mode.
- If multiple errors are detected during Precise Surround Setup, only the most serious error will be shown on the display.
- The warning message is displayed for about 10 seconds and the receiver automatically returns to Precise Surround Setup.
- Depending on the speaker performance or the listening position, there may be a case that the warning message appears even though speaker connections are correct. In such a case, there is no effect on the results of Precise Surround Setup.

Basic operations

2 Select the source to play

On the front panel:

Turn **SOURCE SELECTOR** until the source name you want appears on the display.

The source lamp corresponding to the selected source lights in red.

- As you turn SOURCE SELECTOR, the source changes as follows:

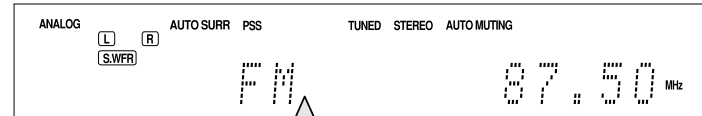

DVR/DVD ↔ VCR ↔ DBS ↔ TV(SIRIUS)* ↔ USB ↔ XM ↔ FM ↔ AM ↔ (Back to the beginning)

- DVR/DVD: Select this for the DVD recorder or DVD player.
- VCR: Select this for the VCR.
- DBS: Select this for the DBS tuner.
- TV*: Select this for the TV.
- SIRIUS*: Select this for the SIRIUS Satellite Radio.
- USB: Select this for the PC component.
- XM: Select this for the XM Satellite Radio.
- FM: Select this for the FM broadcast.
- AM: Select this for the AM broadcast.

From the remote control:

Press one of the source selecting buttons.

- For "FM" and "AM," press FM/AM. Each time you press the button, the band alternates between "FM" and "AM."

NOTE

When you connect a VCR or DBS to the HDMI VCR(DBS) IN terminal or COMPONENT VIDEO jacks on the rear of the receiver, you need to select either "VCR" or "DBS" for each terminal according to the component you connect (see page 34).

* Changing the source name of TV/SIRIUS input

On the front panel ONLY:

Press **SET** when "TV" is selected as the source.

- "ASSIGN SIRIUS" appears on the display for a while.

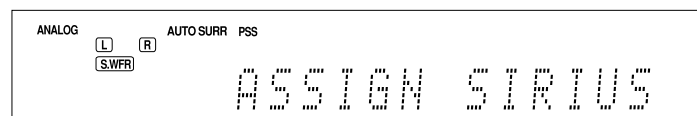

- To change the source name to "TV," press SET when "SIRIUS" is selected as the source. "ASSIGN TV" appears on the display for a while.

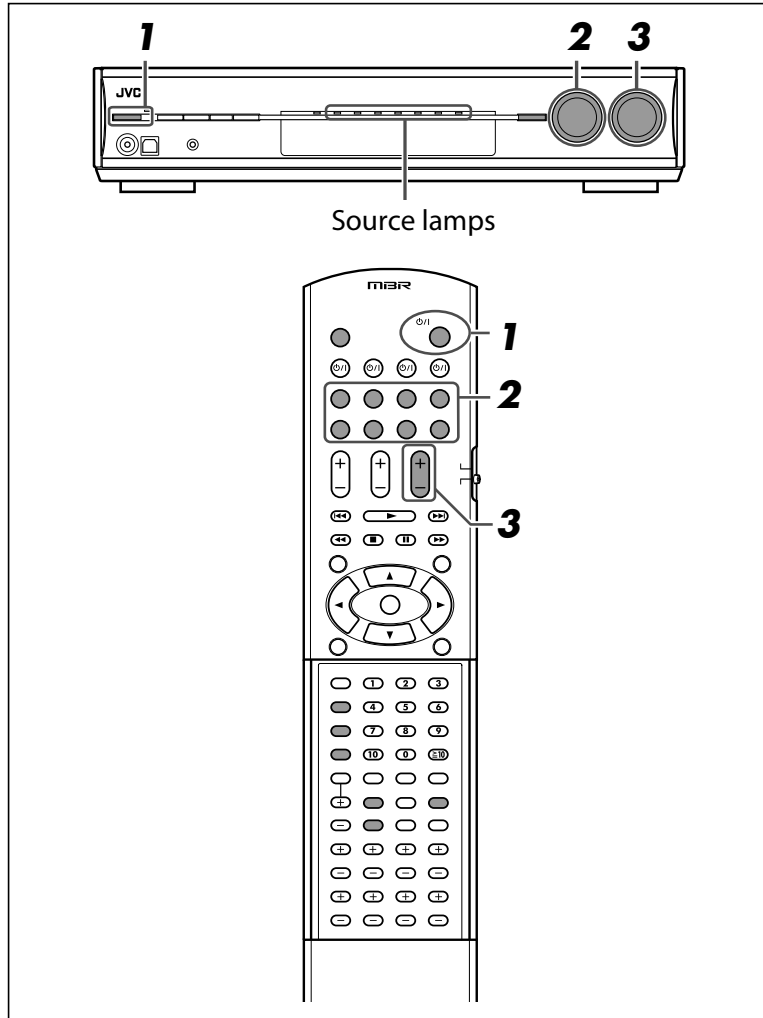

1 Turn on the power

Press **⏻/I STANDBY/ON** (or **⏻/I AUDIO** on the remote control).

The standby lamp goes off and the current source lamp lights in red.

Current source name appears.

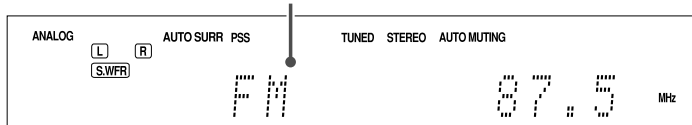

To turn off the power (into standby):

Press **⏻/I STANDBY/ON** (or **⏻/I AUDIO** on the remote control) again.

The standby lamp lights in red.

NOTES

- A small amount of power is consumed in standby mode. To turn the power off completely, unplug the AC power cord.
- Turning a source component on before turning the receiver on may cause a noise or interrupt the sound and picture. In this case, turn both the source component and the receiver off, then turn the receiver on before turning the source component on.

3 Adjust the volume

To increase the volume, turn **MASTER VOLUME** control clockwise (or press **VOLUME +** on the remote control).

To decrease the volume, turn **MASTER VOLUME** control counterclockwise (or press **VOLUME –** on the remote control).

- When you adjust the volume, the volume level indication appears on the display for a while.

CAUTION:

Always set the volume to the minimum before starting any sources. If the volume is set at its high level, the sudden blast of sound energy can permanently damage your hearing and/or ruin your speakers.

NOTE

The volume level can be adjusted within the range between "0" (minimum) and "50" (maximum).

■ Listening with headphones

You can enjoy not only stereo software but also multi-channel software through the headphones. (Sounds are down-mixed to the front channels while playing multi-channel software.)

Connect a pair of headphones to the PHONES jack on the front panel to activate the HEADPHONE mode.

The HEADPHONE indicator lights up on the display.

- You can also enjoy the Surround/DSP mode through the headphones—3D HEADPHONE mode (see page 42).
- Disconnecting a pair of headphones from the PHONES jack cancels the HEADPHONE (or 3D HEADPHONE) mode and activates the speakers.

CAUTIONS:

- Be sure to turn down the volume:
 - Before connecting or putting on headphones, as high volume can damage both the headphones and your hearing.
 - Before removing headphones, as high volume may output from the speakers.
- Do not plug headphones into the PRECISE SURROUND SETUP MIC jack; otherwise, loud tones may come out of the headphones.

NOTES

- When using the headphones, the speaker settings does not take effect temporarily.
- The supplied earphone-type microphones cannot be used as headphones.

Selecting the video and audio input settings

You need to select the proper video and audio input settings for each source according to the connection methods on pages 9 to 14.

- In case of digital audio connection using the DIGITAL IN terminals on the rear of the receiver, you also need to select the correct digital input terminal (see page 34).
- Once you have made an adjustment, it is memorized for each source.

■ Selecting the video input setting

From the remote control ONLY:

1 Press one of the source selecting buttons to select the source you want.

2 Press VIDEO INPUT to select the video input setting.

- Each time you press the button, the input setting changes as follows. This setting is memorized for each source.

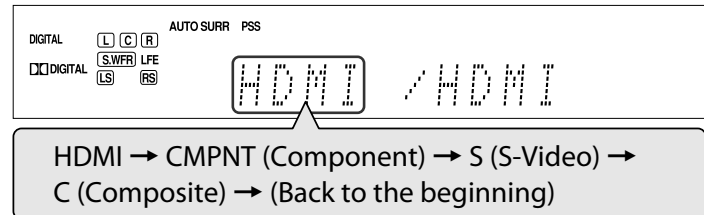

NOTE

For "VCR" and "DBS," set the HDMI select and COMPONENT select settings correctly if necessary (see page 34).

■ Selecting the audio input setting

From the remote control ONLY:

1 Press one of the source selecting buttons to select the source you want.

2 Press AUDIO INPUT to select the audio input setting.

- Each time you press the button, the audio input setting changes as follows. This setting is memorized for each source.

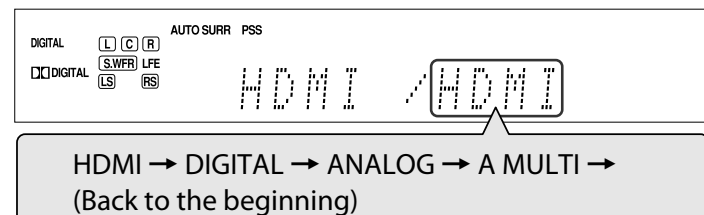

HDMI (for "DVR/DVD," "VCR" and "DBS"):

Select for the source with HDMI connection. The receiver automatically detects the incoming signal format, then the digital signal format indicator (LINEAR PCM, DIGITAL, **dts**, or **dts** 96/24) for the detected signal lights up, and the HDMI lamp on the front panel lights up.

DIGITAL*: Select for the digital input setting. The receiver automatically detects the incoming signal format, then the digital signal format indicator (LINEAR PCM, DIGITAL, **dts**, or **dts** 96/24) for the detected signal lights up.

ANALOG*: Select for the analog input setting. The ANALOG indicator lights up on the display.

A MULTI (Only for "DVR/DVD"):

Select when connecting a DVD recorder or DVD player to DVD MULTI IN jacks (see page 11). The ANALOG indicator lights up on the display.

- * When "TV" is selected as the source, only "DIGITAL" and "ANALOG" are available.

Continued on the next page

NOTES

- "HDMI" is selectable only when the video input setting is also to "HDMI" (see page 21).
The audio input setting may automatically change if you change the video input setting to or from "HDMI." In such a case, make sure that the appropriate setting is selected.
- "DIGITAL" is available for the source which is assigned for "DIGITAL IN 1," "DIGITAL IN 2," or "DIGITAL IN 3." See page 34 for details.

Initial setting of the video and audio input for each source:

Source \ Setting	Video input	Audio input
DVR/DVD	HDMI	HDMI
VCR	HDMI	HDMI
DBS	S	DIGITAL
TV	—	ANALOG
SIRIUS	—	ANALOG (fixed)
USB	—	DIGITAL (fixed)
XM	—	DIGITAL (fixed)
FM	—	ANALOG (fixed)
AM	—	ANALOG (fixed)

Selecting the digital decode mode

When "HDMI" or "DIGITAL" is selected for the audio input setting (see page 21), this receiver automatically detects the incoming digital signal format and sets the digital decode mode to "DGTL AUTO."

- The DIGITAL AUTO indicator lights up on the display.

If the following symptoms occur while playing Dolby Digital or DTS software with "DGTL AUTO" selected, follow the procedure below:

- Sound does not come out at the beginning of playback.
- Noise comes out while searching for or skipping chapters or tracks.

From the remote control ONLY:

Press DECODE to select "DOLBY DIGITAL" or "DTS."

- Each time you press DECODE, the digital decode mode changes as follows:

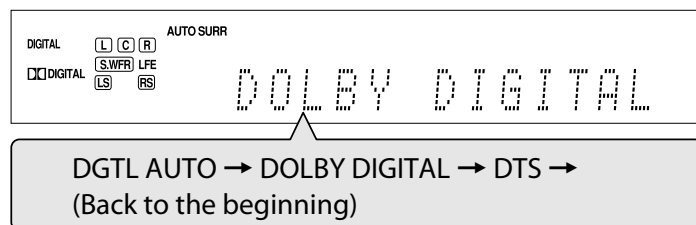

- To play back software encoded with Dolby Digital, select "DOLBY DIGITAL."
- To play back software encoded with DTS, select "DTS."

NOTES

- The digital decode mode is fixed to "DGTL AUTO" when selecting "USB" or "XM" as the source.
- "DOLBY DIGITAL" or "DTS" is automatically reset to "DGTL AUTO" in the following cases:
 - When you turn off the receiver.
 - When you select another source.
 - When you change the audio input setting (see page 21).

The following digital signal format indicators on the display indicate what type of signal comes into the receiver. See pages 39 to 41 for the details of each digital signal format.

- LINEAR PCM:**
 - Lights up when Linear PCM signal comes in.
 - When the multi-channel PCM signal comes in, "MULTI CH PCM" appears on the display for a while.

- DIGITAL:** Lights up when Dolby Digital signal comes in.
 - Flashes when "DOLBY DIGITAL" is selected for any software other than Dolby Digital.

- dts:** Lights up when conventional DTS signal comes in.
 - Flashes when "DTS" is selected for any software other than DTS.

- dts 96/24:** Lights up when DTS 96/24 signal comes in.

NOTE

When "DGTL AUTO" cannot recognize the incoming signal, no digital signal format indicator lights up on the display.

Turning off the sounds temporarily

From the remote control ONLY:

Press MUTING to turn off the sound through all connected speakers and headphones.

"MUTING" appears on the display and the volume turns off.

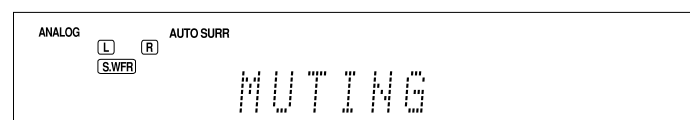

To restore the sound, press MUTING again.

- Pressing VOLUME +/- (or turning MASTER VOLUME control on the front panel) also restores the sound.

NOTE

When performing Precise Surround Setup or turning the power off, muting is automatically canceled.

Changing the display brightness

You can dim the display—Dimmer.

From the remote control ONLY:

Press DIMMER repeatedly.

- Each time you press the button, the display brightness changes as follows:

DIMMER 1	Dims the display.
DIMMER 2	Dims the display more than DIMMER 1.
DIMMER 3	Turns off the display. (Temporarily canceled when you operate the receiver.)
DIMMER OFF	Cancels the Dimmer (normal display).

NOTE

When performing Precise Surround Setup, Dimmer is automatically canceled.

Turning off the power with the Sleep Timer

You can fall asleep while listening to music—Sleep Timer.

From the remote control ONLY:

Press SLEEP repeatedly.

- Each time you press the button, the shut-off time changes in 10-minute intervals. The SLEEP indicator lights up on the display.

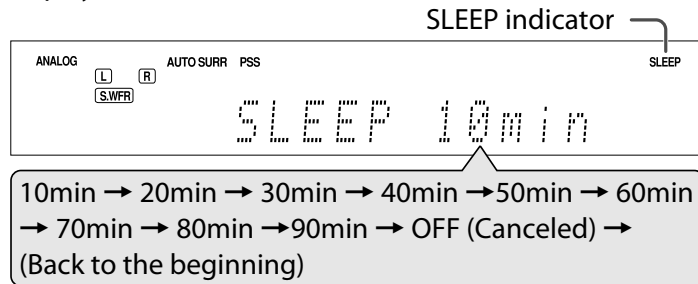

When the shut-off time comes:

The receiver turns off automatically.

To check the remaining time until the shut-off time:

Press SLEEP once.

The remaining time (in minutes) until the shut-off time appears.

- To change the shut-off time, press SLEEP repeatedly.

To cancel the Sleep Timer:

Press SLEEP repeatedly so that "SLEEP OFF" appears on the display. (The SLEEP indicator goes off.)

- The Sleep Timer is also canceled when you turn off the receiver.

Making sounds natural

JVC's CC (Compression Compensative) Converter eliminates jitter and ripples, achieving a drastic reduction in digital distortion by processing the digital music data in 24 bit-quantization and by expanding the sampling frequency to 176.4 kHz (for fs 44.1 kHz signals)/192 kHz (for fs 48 kHz signals) on the front speakers.

By using the CC Converter, you can obtain a natural sound field from both digital and analog sources.

- Once you have made an adjustment, it is memorized for each source.

Press CC CONVERTER repeatedly.

- Each time you press the button, the mode changes as follows:

CC CNVRTR 1	Select when playing back an analog source or a digital source with non compressed digital sound signal (Linear PCM). The CC CONVERTER 1 indicator lights up on the display.
CC CNVRTR 2	Select when playing back a source with compressed digital sound signal (Dolby Digital or DTS). The CC CONVERTER 2 indicator lights up on the display.
CC CNVRTR OFF	Select when not using the CC Converter.

Basic adjustment of auto memory

This receiver memorizes sound settings for each source:

- When you turn off the power
- When you change the source

When you change the source, the memorized settings for the newly selected source are automatically recalled.

The following can be stored for each source:

- Video input setting (see page 21)
- Audio input setting (see page 21)
- CC Converter (see the left column)
- Midnight mode (see page 33)
- Digital equalization patterns (see page 36)
- Bass Boost (see page 37)
- Input attenuator mode (see page 37)
- Surround/DSP mode selection (see page 44)

NOTE

If the source is "FM" or "AM," you can assign a different setting for each band.

Signal and speaker indicators on the display

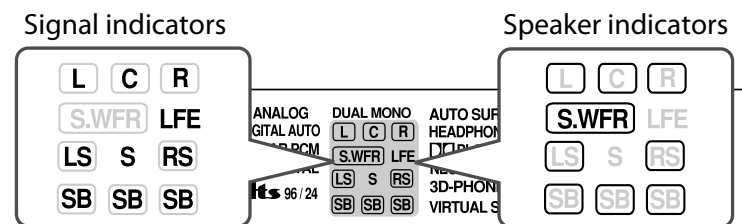

The signal indicators light up as follows:

- L:**
 - When digital input is selected: Lights up when the left channel signal comes in.
 - When analog input is selected: Always lights up.
- R:**
 - When digital input is selected: Lights up when the right channel signal comes in.
 - When analog input is selected: Always lights up.
- C:** Lights up when the center channel signal comes in.
- LS:** Lights up when the left surround channel signal comes in.
- RS:** Lights up when the right surround channel signal comes in.
- S:** Lights up when monaural surround signal comes in.
- SB:** Lights up when the surround back channel signal comes in.
- LFE:** Lights up when the LFE channel signal comes in.

NOTES

- When "A MULTI" is selected for the audio input setting (see page 21), all the signal indicators except "SB" and "S" light up.
- When playing back multi-channel digital sound recorded in DVD-Audio with HDMI connection (see pages 9 and 21), the signal indicators may not light up correctly.

The speaker indicators light up as follows:

- The subwoofer indicator (**S.WFR**) lights up when "SUBWOOFER" is set to "YES." For details, see page 30.
- The other speaker indicators light up only when the corresponding speaker is set to "SML (small)" or "LRG (large)," and also required for the current playback.

FM/AM tuner operations

FM/AM tuner operations are mainly done from the remote control.

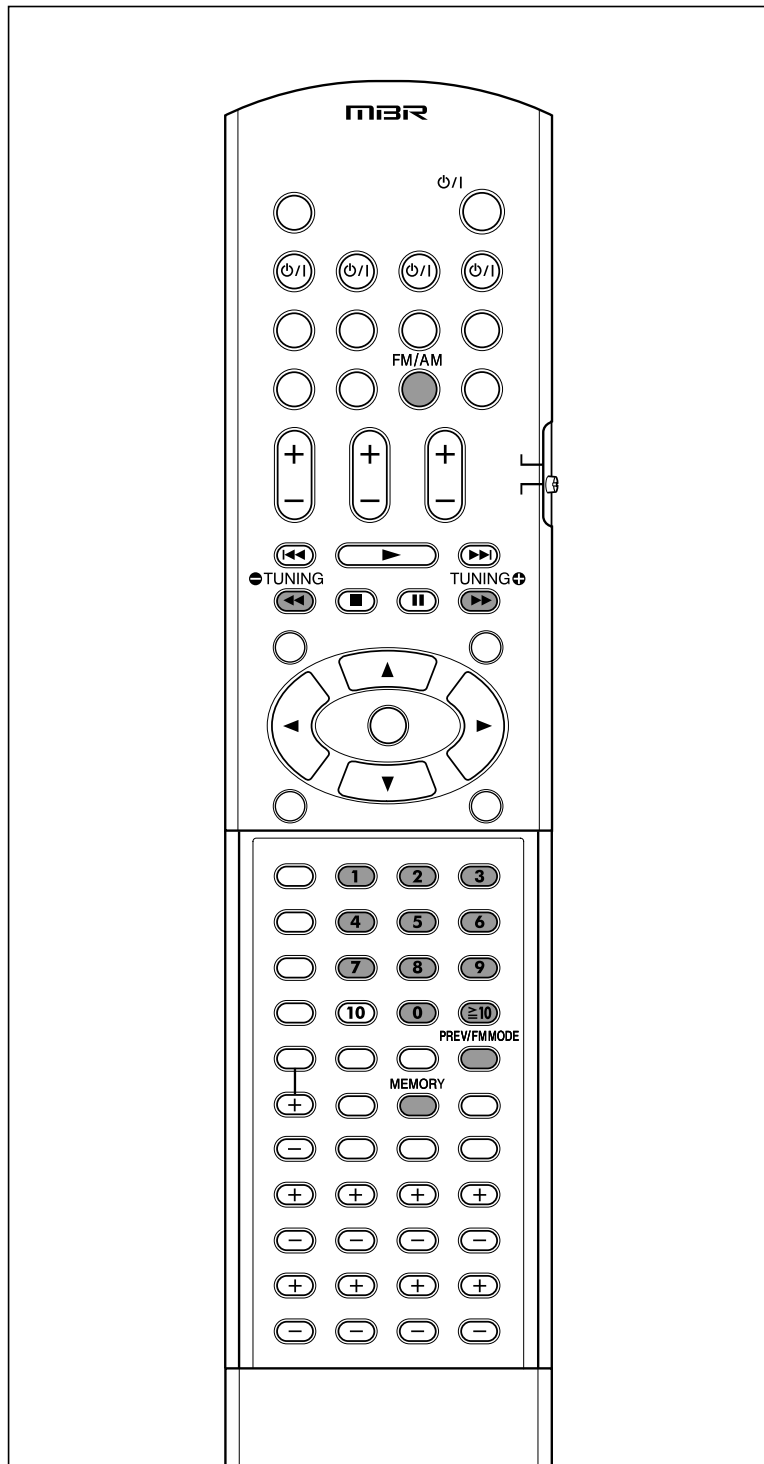

NOTE

When you have selected "FM" or "AM" by using SOURCE SELECTOR on the front panel, the remote control may not work for tuner operations. To use the remote control for tuner operations, select "FM" or "AM" by using the FM/AM button on the remote control.

Tuning in to stations manually

From the remote control ONLY:

1 Press FM/AM to select the band.

The last received station of the selected band is tuned in.

- Each time you press the button, the band alternates between "FM" and "AM."

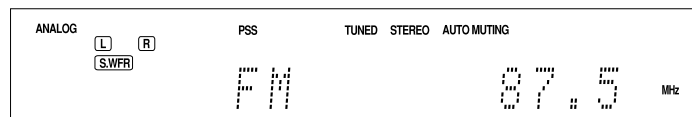

2 Press repeatedly or hold TUNING + or - TUNING until the station you want is tuned in.

- Pressing (or holding) TUNING + increases the frequency.
- Pressing (or holding) - TUNING decreases the frequency.

NOTES

- When you hold and release TUNING + or - TUNING, the frequency keeps changing until a station is tuned in.
- When a station of sufficient signal strength is tuned in, the TUNED indicator lights up on the display.
- When an FM stereo program is received, the STEREO indicator also lights up.

Using preset tuning

Once a channel number is assigned to a station, the station can be quickly tuned in by selecting the number. You can preset up to 30 FM and 15 AM stations.

■ To store the preset stations

Before you start, remember...

There is a time limit in doing the following steps. If the setting is canceled before you finish, start from step 2 again.

From the remote control ONLY:

1 Tune in to the station you want to preset (see "Tuning in to stations manually" above).

- If you want to store the FM reception mode for this station, select the FM reception mode you want. See "Selecting the FM reception mode" on page 25.

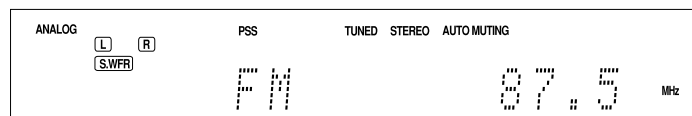

2 Press MEMORY.

The channel number position starts flashing on the display for about 5 seconds.

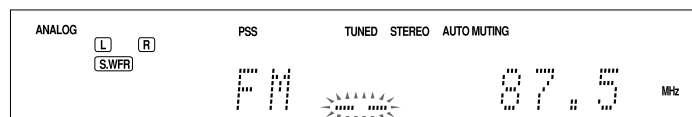

3 Press the numeric buttons (0 – 9, ≥ 10) to select a channel number while the channel number position is flashing.

- For channel number 5, press 5.
- For channel number 10, press ≥ 10 , 1, then 0.
- For channel number 25, press ≥ 10 , 2, then 5.

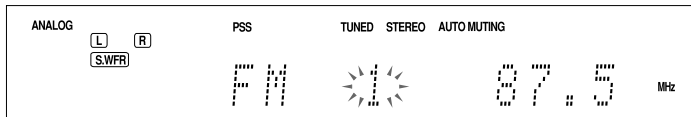

4 Press MEMORY again while the selected channel number is flashing on the display.

The selected channel number stops flashing.
The channel number is assigned to the station.

5 Repeat steps 1 to 4 until you store all the stations you want.

To erase a stored preset station:

Storing a new station on a used channel number erases the previously stored one.

■ To tune in a preset station

From the remote control:

1 Press FM/AM to select the band.

The last received station of the selected band is tuned in and the numeric buttons now work for selecting preset channels.

- Each time you press FM/AM, the band alternate between "FM" and "AM."

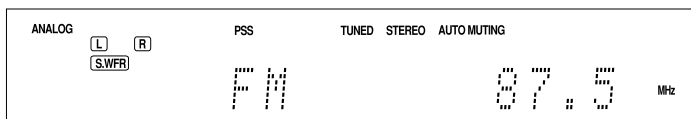

2 Press the numeric buttons (0 – 9, ≥ 10) to select a preset channel number.

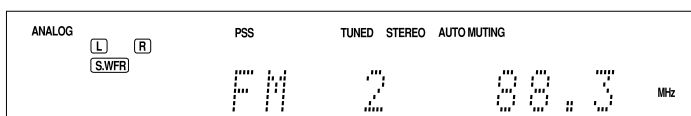

- For channel number 5, press 5.
- For channel number 10, press ≥ 10 , 1, then 0.
- For channel number 25, press ≥ 10 , 2, then 5.

On the front panel:

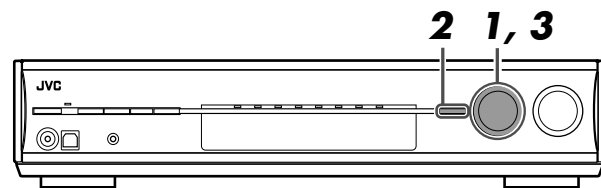

Before you start, remember...

There is a time limit in doing the following steps. If the setting is canceled before you finish, start from step 2 again.

1 Turn SOURCE SELECTOR to select "FM" or "AM."

The last received station of the selected band is tuned in.

2 Press TUNER PRESET.

"P" appears on the display, and MULTI JOG now works for selecting preset channels.

3 Turn MULTI JOG to select a preset channel number.

- To increase the preset channel numbers, turn MULTI JOG clockwise.
- To decrease the preset channel numbers, turn MULTI JOG counterclockwise.

Selecting the FM reception mode

When an FM stereo broadcast is hard to receive or noisy, you can change the FM reception mode.

- You can store the FM reception mode for each preset station (see page 24).

From the remote control ONLY:

While listening to an FM station, press FM MODE.

- Each time you press the button, the FM reception mode alternates between "AUTO MUTING" and "MONO."

AUTO MUTING Normally select this.

When a program is broadcast in stereo, you will hear stereo sound; when in monaural, you will hear monaural sound. This mode is also useful to suppress static noise between stations. The AUTO MUTING indicator lights up on the display.

MONO

Select this to improve the reception (but stereo effect will be lost). In this mode, you will hear noise while tuning in to the stations. The AUTO MUTING indicator goes off from the display. (The STEREO indicator also goes off.)

Initial setting: AUTO MUTING

XM Satellite Radio operations

This is an XM Ready® receiver.

- Before operating, refer also to the manual of your XM Passport System (not supplied).

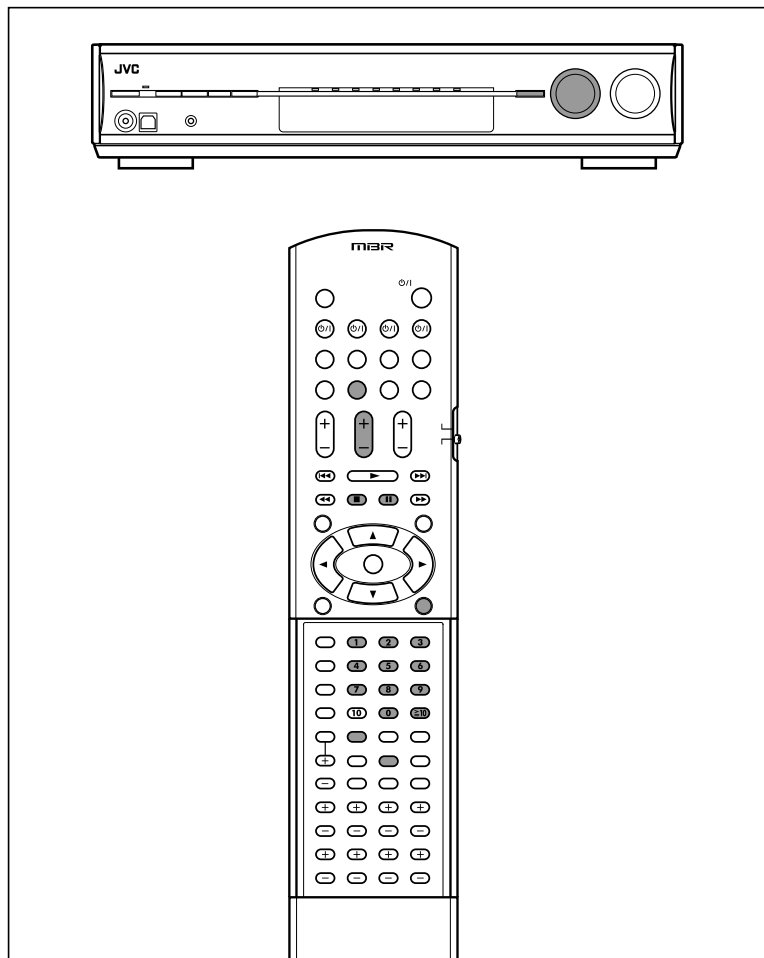

NOTE

When you have selected "XM" by using SOURCE SELECTOR on the front panel, the remote control may not work for XM Satellite Radio operations. To use the remote control for the XM Satellite Radio operations, select "XM" by using the XM button on the remote control.

About XM Satellite Radio

XM Satellite Radio is a satellite radio service with digital-quality sound and over 170 digital channels, the most commercial-free music in satellite radio services, live concerts plus exclusive original programming, the biggest names in news, talk, and entertainment, the most sports play-by-play including Major League Baseball®. For the latest channel listings and programming information, or to sign up, visit <<http://www.xmradio.com>>.

XM Ready® is a registered trademark of XM Satellite Radio Inc. All rights reserved.

Major League Baseball® is a registered trademark of Major League Baseball Properties, Inc.

For SIRIUS Satellite Radio operations, see page 47.

Preparation

To listening to XM Satellite Radio, you need the following:

- The XM Passport System*¹ (not supplied)—XM Passport and XM Passport Home Dock
- Subscription to XM Satellite Radio*²

*¹ To connect the XM Passport System with this receiver, see page 7.

*² The following channels are available without subscription:

- Channel 0: This channel is for checking the XM Satellite Radio ID code.
- Channel 1: This is "XM Preview" channel.

How to subscribe

XM Satellite radio is a subscription service.

To subscribe to the XM Satellite Radio, visit the XM Satellite Radio's web site at <<http://xmradio.com/activation/>>, or you can call 1-800-XM-RADIO (1-800-967-2346).

For subscription, you need to have the XM Satellite radio ID code. To check the ID code, follow the procedure below:

How to check the XM Satellite Radio ID code

After connection:

- 1 Press XM on the remote control or turn SOURCE SELECTOR on the front panel to select "XM" as the source.**
- 2 Tune in to "Channel 0" (see "To tune in to channels" on page 27) to check your XM Satellite Radio ID code.**

The display alternately shows "RADIO ID" and the 8-digit (alphanumeric) ID code.

To cancel the ID code display

Select any channel other than "Channel 0."

Listening to the XM Satellite Radio

- 1 Press XM on the remote control or turn SOURCE SELECTOR on the front panel to select "XM" as the source.**

The last received channel is tuned in.

"XM" appears and then the channel name appears on the display.

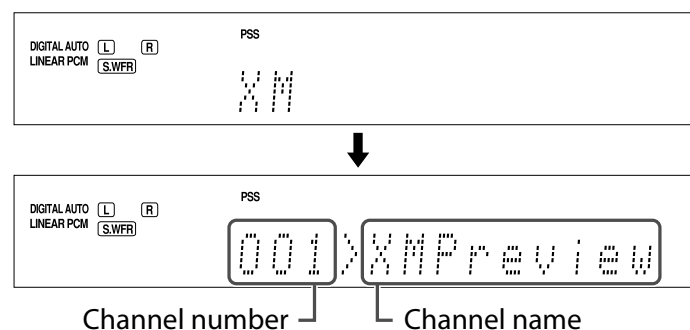

- 2 Tune in to the desired channel.**

You can tune in to channels with one of the following methods:

- Channel Search
- Category Search
- Direct Channel Access

For details, see "To tune in to channels" on page 27.

■ To tune in to channels

From the remote control ONLY:

Channel Search

You can search and tune in to all channels.

1 Press XM to select "XM" as the source.

2 Press repeatedly or hold CHANNEL +/- until the desired channel number appears on the display.

- Pressing (or holding) CHANNEL + increases the channel number.
- Pressing (or holding) CHANNEL – decreases the channel number.

NOTE

While searching, the invalid and unsubscribed channels are skipped.

Category Search

You can select the channel category and tune in to only the channels included in the selected category.

Before you start, remember...

There is a time limit in doing the following steps. If the setting is canceled before you finish, start from step **2** again.

1 Press XM to select "XM" as the source.

2 Press CAT ⊕ or ⊖ CAT.

The receiver enters the Category Search mode. The category name of the currently selected channel appears and ">" starts flashing on the display for about 15 seconds.

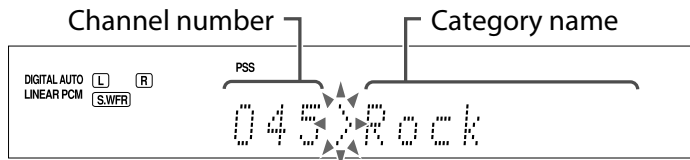

3 Press CAT ⊕ or ⊖ CAT repeatedly to display the desired category name on the display while ">" is flashing.

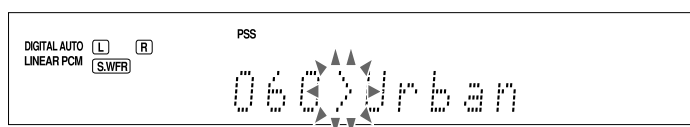

4 Press repeatedly or hold CHANNEL +/- until the desired channel is tuned in.

- Pressing (or holding) CHANNEL + increases the channel number included in the selected category.
- Pressing (or holding) CHANNEL – decreases the channel number included in the selected category.

NOTE

While searching, the invalid and unsubscribed channels are skipped.

Direct Channel Access

You can tune in to the desired channel directly by entering the channel number.

Before you start, remember...

There is a time limit in doing the following steps. If the setting is canceled before you finish, start from step **2** again.

1 Press XM to select "XM" as the source.

2 Press the DIRECT button.

The receiver enters the Direct Access mode and the numeric buttons now work for entering channel numbers. The channel number position starts flashing on the display for about 5 seconds.

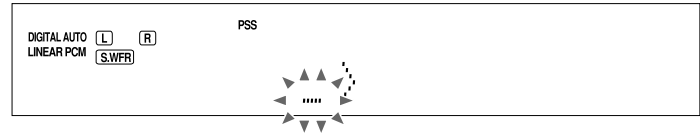

3 Press the numeric buttons (0 – 9, ≥10) to enter the desired channel number while the channel number position is flashing.

- For channel number 005, press 5.
- For channel number 010, press ≥10, 1, then 0.
- For channel number 025, press ≥10, 2, then 5.
- For channel number 115, press ≥10, ≥10, 1, 1, then 5.

Using preset tuning

Once a preset number is assigned to a channel, the channel can be quickly tuned in by selecting the number. You can preset up to 30 channels.

■ To store the preset channels

Before you start, remember...

There is a time limit in doing the following steps. If the setting is canceled before you finish, start from step **2** again.

From the remote control ONLY:

1 Tune in to the channel you want to preset (see "To tune in to channels" on the left column).

2 Press MEMORY.

The preset number position starts flashing on the display for about 5 seconds.



3 Press the numeric buttons (0 – 9, ≥10) to select a preset number while the preset number position is flashing.

- For preset number 5, press 5.
- For preset number 10, press ≥10, 1, then 0.
- For preset number 25, press ≥10, 2, then 5.

Continued on the next page

4 Press **MEMORY** again while the selected preset number is flashing on the display.

5 Repeat steps **1** to **4** until you store all the desired channels.

To erase a stored preset channel

Storing a new channel on a used preset number erases the previously stored one.

■ To tune in a preset channel

From the remote control:

1 Press **XM**.

The last received channel is tuned in.

2 Press the numeric buttons (**0 – 9, ≥10**) to select a preset channel number.

- For preset number 5, press 5.
- For preset number 10, press ≥10, 1, then 0.
- For preset number 25, press ≥10, 2, then 5.

On the front panel:

Before you start, remember...

There is a time limit in doing the following steps. If the setting is canceled before you finish, start from step **2** again.

1 Turn **SOURCE SELECTOR** to select **“XM.”**

The last received channel is tuned in.

2 Press **TUNER PRESET**.

“P” flashes on the display, and **MULTI JOG** now works for selecting preset channels.

3 Turn **MULTI JOG** to select a preset number.

- To increase the preset numbers, turn **MULTI JOG** clockwise.
- To decrease the preset numbers, turn **MULTI JOG** counterclockwise.

Changing the channel information

While listening to the XM Satellite Radio, the currently selected channel information appears on the display. You can change the type of channel information.

From the remote control ONLY:

Press **DISPLAY**.

Each time you press the button, the channel information changes as follows:

CHAN (channel name)* → NAME (artist name/feature) → TITLE (song/program title) → CAT (category name) → (Back to the beginning)

* CHAN (channel name) is the initial setting.

EX.: When the category name is selected:

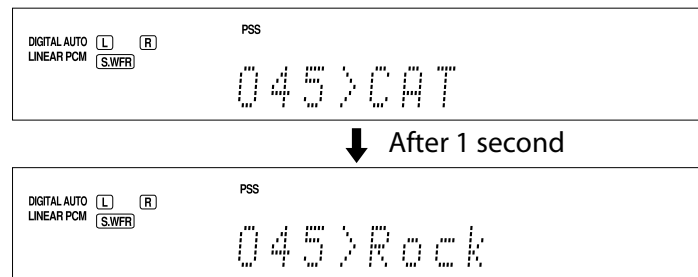

NOTES

- If you turn off the power or select another source, the display is changed back to the initial setting.
- When you tune in to another channel, the channel name appears on the display and then the channel information you have selected appears.
- When all the text information cannot be shown on the display at a time, the text scrolls.
- Some characters cannot be displayed correctly.

■ Messages on the display

When problems occur, a message appears on the display. In this case, refer to the following solution.

Message	Possible cause	Solution
NO SIGNAL	Signals are too weak.	Move the XM Passport Home Dock antenna near a south-facing window or where “Channel 1” can be heard clearly.
CHECK ANTENNA	The XM Passport Home Dock antenna is not connected properly.	Check the connection (see page 7).
LOADING	This receiver is loading the channel information and audio data.	It takes a few minutes to complete. Wait until loading is finished.
OFF AIR	Selected channel is not currently broadcasting any signal.	Select another channel.
UPDATING	The latest encryption code is being updated.	Wait until updating is finished.
• Channel number and “----” • Preset number, channel number, and “----”	No text information for the selected channel is available.	—
• Channel number and “CH--” • Preset number and “---<CH--”	Selected channel does not exist or is not subscribed yet.	—

Basic settings

To obtain the best possible sound effect from the Surround/DSP modes (see pages 39 to 44), you need to set up the speaker and subwoofer information after all the connections are completed. From pages 29 to 34, how to set speakers and other basic items of the receiver are explained.

Basic setting items

You can adjust the following items. See pages in parentheses for details.

- You cannot select the items which is not available with the current setting. For example, when "S BACK SPK" is set to "NO," you cannot select the following items:
S BACK OUT, S BACK DIST, S BACK L DIST, S BACK R DIST

Items	To do
SUBWOOFER*	Register your subwoofer. (30)
FRONT SPK*	Register your front speaker size. (30)
CENTER SPK*	Register your center speaker size. (30)
SURROUND SPK*	Register your surround speaker size. (30)
S BACK SPK*	Register your surround back speaker size. (30)
S BACK OUT*	Register the number of your surround back speaker(s). (31)
DIST UNIT	Select the measuring unit for the speaker distance. (31)
FRONT L DIST*	Register the distance from the left front speaker to your listening point. (31)
FRONT R DIST*	Register the distance from the right front speaker to your listening point. (31)
CENTER DIST*	Register the distance from the center speaker to your listening point. (31)
SURR L DIST*	Register the distance from the left surround speaker to your listening point. (31)
SURR R DIST*	Register the distance from the right surround speaker to your listening point. (31)
S BACK DIST*	Register the distance from the surround back speaker to your listening point when using a single speaker for the surround back speaker. (31)
S BACK L DIST*	Register the distance from the left surround back speaker to your listening point. (31)
S BACK R DIST*	Register the distance from the right surround back speaker to your listening point. (31)

Items	To do
EX/ES/PLIIx	Select the EX/ES/PLIIx reproduction mode. (32)
DUAL MONO	Select the Dual Mono sound channel. (32)
SUBWOOFER OUT	Select sounds emitted from the subwoofer. (33)
CROSSOVER*	Select the cutoff frequency to the subwoofer. (33)
LFE ATT	Attenuate the bass (LFE) sounds. (33)
MIDNIGHT MODE	Reproduce a powerful sound at night. (33)
DIGITAL IN 1	Select the component connected to the digital coaxial terminal—1(DVR/DVD). (34)
DIGITAL IN 2	Select the component connected to the digital optical terminal—2(DBS). (34)
DIGITAL IN 3	Select the component connected to the digital optical terminal—3(VCR). (34)
AUDIO DELAY	Set the audio delay time to correct synchronization between video and audio signals. (34)
HDMI SELECT	Select the source for HDMI VCR (DBS) IN terminal. (34)
CMPNT SELECT	Select the source for COMPONENT VCR (DBS) IN jacks. (34)
VIDEO OUTPUT	Select the output video signal. (34)

* If you have performed Precise Surround Setup on pages 16 to 18, these settings are not required.

NOTE

Some items above are not available in the following cases below:

- When selecting "A MULTI" for the audio input setting (see page 11)
- When multi-channel PCM signals (see page 41) are coming in with selecting "HDMI" for the audio input setting (see page 11)

Operating procedure

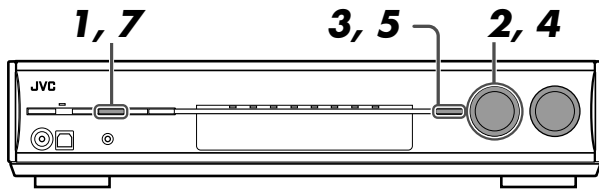

On the front panel ONLY:

Before you start, remember...

There is a time limit in doing the following steps. If the setting is canceled before you finish, start from step **1** again.

Ex.: When setting the DIGITAL IN 1 terminal

1 Press SETTING.

MULTI JOG now works for the setting operation.

2 Turn MULTI JOG until the item you want to set appears on the display.

- As you turn MULTI JOG, the setting items change as follows:



SUBWOOFER ↔ FRONT SPK ↔ CENTER SPK ↔
 SURROUND SPK ↔ S BACK SPK ↔ S BACK OUT ↔
 DIST UNIT ↔ FRONT L DIST ↔ FRONT R DIST ↔
 CENTER DIST ↔ SURR L DIST ↔ SURR R DIST ↔
 S BACK DIST ↔ S BACK L DIST ↔ S BACK R DIST ↔
 EX/ES/PLIIx ↔ DUAL MONO ↔ SUBWOOFER OUT
 ↔ CROSSOVER ↔ LFE ATT ↔ MIDNIGHT MODE ↔
 DIGITAL IN 1 ↔ DIGITAL IN 2 ↔ DIGITAL IN 3 ↔
 AUDIO DELAY ↔ HDMI SELECT ↔ CMPNT SELECT
 ↔ VIDEO OUTPUT ↔ (Back to the beginning)

3 Press SET.

The current setting of the selected item appears.

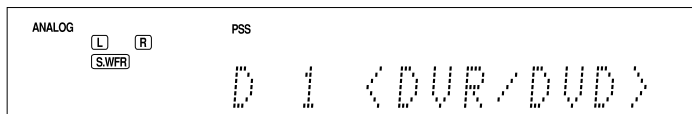

4 Turn MULTI JOG to select the appropriate setting.

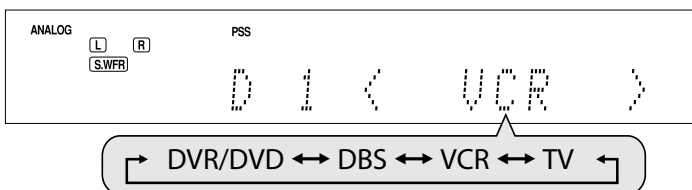

5 Press SET.

Your setting is stored.

6 Repeat steps 2 to 5 to set other items if necessary.

7 Press SETTING.

The source indication resumes on the display.

Setting the speakers

To obtain the best possible surround effect from the Surround and DSP modes, register the setting about the speaker after all connections are completed.

- If you have performed Precise Surround Setup on pages 16 to 18, the following settings are not required.

Setting subwoofer information— SUBWOOFER

Select if you have connected a subwoofer or not.

SUBWFR YES Select when you have connected a subwoofer.
 The subwoofer indicator (S.WFR) lights up on the display. You can adjust the subwoofer output level (see page 36).

SUBWFR NO Select when you have not connected a subwoofer. Selecting this changes the front speaker size to "LRG" (see below).

Initial setting: NO

Setting the speaker size—FRONT SPK (front speakers), CENTER SPK (center speaker), SURROUND SPK (surround speakers), S BACK SPK (surround back speakers)

Register the sizes of all the connected speakers.

LRG (large) Select when the cone speaker size is larger than 12 cm (4 3/4 inches).

SML (small) Select when the cone speaker size is smaller than 12 cm (4 3/4 inches).

NO Select when you have not connected the speaker. (Not selectable for the front speakers.)

Initial setting: LRG (for the front speakers)
 SML (for the other speakers)

NOTES

- If you have selected "SML (small)" for the front speaker size, you cannot select "LRG (large)" for other speakers.
- When "SUBWOOFER" is set to "NO," the front speaker size is fixed to "LRG (large)" (and you cannot select "SML (small)").
- When "SURROUND SPK" is set to "SML (small)," you cannot select "LRG (large)" for the surround back speaker.
- When "SURROUND SPK" is set to "NO," the surround back speaker is fixed to "NO."

■ Setting the surround back speaker(s)— S BACK OUT

Register the number of the surround back speaker(s).

SB OUT 1SPK Select when you use a single surround back speaker.

SB OUT 2SPK Select when you use 2 surround back speakers.

Initial setting: 2SPK

NOTES

- When "S BACK SPK" is set to "NO," you cannot select "S BACK OUT."
- When "S BACK OUT" is set to "1SPK," connect the surround back speaker to the left surround back speaker terminal (see page 8). No sound comes from the surround back speaker if you connect it to the right surround back speaker terminal.

■ Setting the speaker distance

The distance from your listening position to the speakers is one of the important elements to obtain the best possible sound effect from the Surround/DSP modes.

By referring to the speaker distance, the receiver automatically sets the delay time of the sound through each speaker so that sounds through all the speakers can reach you at the same time.

• Measuring unit—DIST UNIT

Select which measuring unit you use.

D UNIT meter Select to set the distance in meters.

D UNIT foot Select to set the distance in feet.

Initial setting: meter

• Speaker distance—

FRONT L DIST (for the left front speaker), FRONT R DIST (for the right front speaker), CENTER DIST (for the center speaker), SURR L DIST (for the left surround speaker), SURR R DIST (for the right surround speaker), S BACK L DIST (for the left surround back speaker), S BACK R DIST (for the right surround back speaker)

Adjustable range: 0.3 m to 9.0 m in 0.15 m intervals
(1 ft to 30 ft in 0.5 ft intervals)

Initial setting: 3.0 m (10 ft) for all speakers

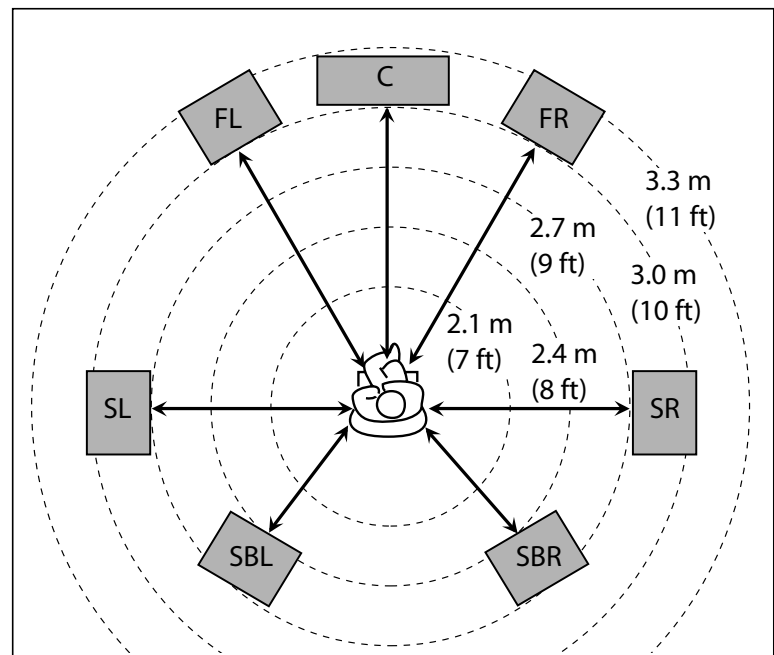

In this case, set the distance as follows:

Left front speaker (FL):	3.0 m (10 ft)
Right front speaker (FR):	3.0 m (10 ft)
Center speaker (C):	3.0 m (10 ft)
Left surround speaker (SL):	2.7 m (9 ft)
Right surround speaker (SR):	2.7 m (9 ft)
Left surround back speaker (SBL):	2.4 m (8 ft)
Right surround back speaker (SBR):	2.4 m (8 ft)

NOTES

- You cannot set the speaker distance for the speakers you have set to "NO."
- If you have selected "1SPK" for "S BACK OUT" (see the left column), "S BACK DIST" appears instead of "S BACK L DIST" and "S BACK R DIST."

Activating the EX/ES/PLIIx setting—EX/ES/PLIIx

Depending on this setting, available Surround modes for digital multi-channel software vary—EX/ES/PLIIx (7.1-channel) reproduction or 5.1-channel reproduction. Select an appropriate setting for your enjoyment.

- For details about relation between EX/ES/PLIIx setting and available Surround mode, see page 42.
- To activate the Surround mode, see page 43.

AUTO	According to the incoming signal, an appropriate Surround mode is applied. <ul style="list-style-type: none"> • For Dolby Digital Surround EX and DTS-ES software, 7.1-channel reproduction is applied*. • For other multi-channel (4 channels or more) encoded software, 5.1-channel reproduction is applied.
ON	Select to apply 7.1-channel reproduction to both 5.1-channel and 6.1-channel encoded software.
PLIIx MOVIE	Select to apply PLIIx MOVIE (7.1-channel) reproduction to both 5.1-channel and 6.1-channel encoded software.
PLIIx MUSIC	Select to apply PLIIx MUSIC (7.1-channel) reproduction to both 5.1-channel and 6.1-channel encoded software.
OFF	Select to cancel the EX/ES/PLIIx (7.1-channel) reproduction.

Initial setting: AUTO

* For some Dolby Digital Surround EX software, Dolby Digital 5.1-channel reproduction ("DOLBY DIGITAL") may be applied even though you have selected "AUTO." In this case, select "ON" to apply "DOLBY D EX." (See page 42.)

NOTES

- This function is not available when "SURROUND SPK" is set to "NO" (see page 30).
- When "S BACK SPK" is set to "NO" (see page 30), the Virtual Surround Back (see page 43) is applied for EX/ES/PLIIx (7.1-channel) reproduction.

Selecting the main or sub channel—DUAL MONO

You can select the playback sound (channel) you want while playing digital software recorded (or broadcasted) in Dual Mono mode (see page 41), which includes two monaural channels separately. When the receiver detects Dual Mono signals, the DUAL MONO indicator lights up on the display.

D MONO MAIN	Select to play back the main channel (Ch 1).* Signal indicator "L" lights up while playing back this channel.
D MONO SUB	Select to play back the sub-channel (Ch 2).* Signal indicator "R" lights up while playing back this channel.
D MONO ALL	Select to play back both the main and sub-channels (Ch 1/Ch 2).* Signal indicators "L" and "R" light up while playing back these channels.

Initial setting: MAIN

* Dual Mono signals can be heard from the following speakers—L (left front speaker), R (right front speaker), and C (center speaker), with respect to the current Surround setting:

Dual Mono setting	Without Surround		With Surround Activated				
			Center speaker setting				
			SML/LRG			NO	
	L	R	L	C	R	L	R
MAIN	Ch 1	Ch 1	—	Ch 1	—	Ch 1	Ch 1
SUB	Ch 2	Ch 2	—	Ch 2	—	Ch 2	Ch 2
ALL	Ch 1	Ch 2	—	Ch 1+Ch 2	—	Ch 1+Ch 2	Ch 1+Ch 2

NOTE

The Dual Mono format is not identical with bilingual broadcasting for TV programs. So this setting does not take effect while watching such bilingual programs.

Setting bass sound

■ Setting subwoofer output—SUBWOOFER OUT

The subwoofer emits the LFE signals* and the bass elements of each speaker set "SML (small)."

You can also make the bass elements of the front speakers (MAIN) emitted through the subwoofer.

SW LFE	The subwoofer emits the LFE signals and the bass elements of the speakers set to "SML (small)."
SW LFE+MAIN	The subwoofer emits the LFE signals and the bass elements of the speakers set to "SML (small)." The subwoofer also emits the bass elements of front speakers (MAIN) when no LFE signal nor the bass elements of "SML (small)" speakers exist.

Initial setting: LFE

- * The LFE signals are emitted only when playing the following software with the LFE signals:
- Dolby Digital multi-channel software
 - DTS multi-channel software
- When playing analog source or linear PCM software, no LFE signal is emitted.

NOTE

When "SUBWOOFER" is set to "NO" (see page 30), you cannot select "SUBWOOFER OUT."

■ Setting the crossover frequency—CROSSOVER

Small speakers cannot reproduce the bass sounds efficiently. If you use a small speaker in any position, this receiver automatically reallocates the bass sound elements assigned to the small speaker to the large speakers.

To use this function properly, set this crossover frequency level according to the size of the small speaker connected.

- If you have selected "LRG (large)" for all speakers (see page 30), this function will not take effect ("CROSS OFF" appears).
- If you have performed Precise Surround Setup on pages 16 to 18, this setting is not required.

Adjustable range: 80 Hz to 200 Hz (in 10 Hz intervals)

Initial setting: 100 Hz

The following are examples of the setting:

CROSS 80Hz	Select when the cone speaker unit built in the speaker is about 12 cm (4 ³ / ₄ inches).
CROSS 100Hz	Select when the cone speaker unit built in the speaker is about 10 cm (3 ¹⁵ / ₁₆ inches).
CROSS 120Hz	Select when the cone speaker unit built in the speaker is about 8 cm (3 ³ / ₁₆ inches).
CROSS 150Hz	Select when the cone speaker unit built in the speaker is about 6 cm (2 ³ / ₈ inches).
CROSS 200Hz	Select when the cone speaker unit built in the speaker is less than 5 cm (2 inches).

NOTE

Crossover frequency is not valid for the HEADPHONE and 3D HEADPHONE modes.

■ Setting the low frequency effect attenuator—LFE ATT

If the bass sound is distorted while playing back software encoded with **Dolby Digital** or **DTS**, set the LFE level to eliminate distortion.

- This function takes effect only when the LFE signals come in.

LFE 0dB	Normally select this.
LFE -10dB	Select when the bass sound is distorted.
Initial setting:	0 dB

Using the Midnight mode—MIDNIGHT MODE

You can enjoy a powerful sound at night using the Midnight mode.

When the Midnight mode is activated, the MIDNIGHT indicator lights up on the display.

MIDNIGHT OFF	Select when you want to enjoy surround with its full dynamic range. (No effect applied.)
MIDNIGHT 1	Select when you want to reduce the dynamic range a little.
MIDNIGHT 2	Select when you want to apply the compression effect fully (useful at night).
Initial setting:	OFF

Setting the digital input (DIGITAL IN) terminals—DIGITAL IN 1/2/3

When you use the digital input terminals, register what components are connected to which terminals—DIGITAL IN 1/2/3 (see page 14) so that the correct source name will appear when you select the digital source.

Select one of the following components for each terminal:

DVR/DVD	For the DVD player (or DVD recorder)
DBS	For the DBS tuner
VCR	For the VCR
TV	For the TV
Initial setting:	DVR/DVD (for "DIGITAL IN 1") DBS (for "DIGITAL IN 2") VCR (for "DIGITAL IN 3")

NOTES

- You cannot assign the same component for different terminals. The priority order for assignment is as follows:
"DIGITAL IN 1" > "DIGITAL IN 2" > "DIGITAL IN 3"
Ex.: When "DIGITAL IN 1" is set to "DVR/DVD."

DIGITAL IN 1	DVR/DVD	DBS	VCR	TV
---------------------	----------------	-----	-----	----



For "DIGITAL IN 2," "DBS," "VCR," and "TV" are selectable.

- In this case, "VCR" is selected.

DIGITAL IN 2	DVR/DVD	DBS	VCR	TV
---------------------	----------------	-----	------------	----



For "DIGITAL IN 3," "DBS" and "TV" are selectable.

DIGITAL IN 3	DVR/DVD	DBS	VCR	TV
---------------------	----------------	------------	-----	-----------

: Selectable : Not selectable

- Setting "DIGITAL IN 1" affects "DIGITAL IN 2" and "DIGITAL IN 3" settings. When you have changed "DIGITAL IN 1," confirm the components assigned to "DIGITAL IN 2" and "DIGITAL IN 3."

Setting the Audio delay level—AUDIO DELAY

Synchronization between audio and video reproduction can be possibly disturbed because video signal decoding is time-consuming compared to the audio signal decoding.

On this setting, you can correct synchronization between video and audio signals by delaying the audio signal timing.

Adjustable range: OFF and 10 ms to 150 ms (in 10 ms intervals)

Initial setting: OFF

NOTE

The audio delay level setting does not take effect when selecting "A MULTI" for the audio input setting (see page 11).

Selecting the source for HDMI terminal and COMPONENT VIDEO jacks—HDMI SELECT/CMPNT SELECT

When you connect a VCR or DBS to the HDMI VCR(DBS) IN terminal or COMPONENT VIDEO jacks on the rear of the receiver, you need to select either "VCR" or "DBS" for each terminal according to the component you connect.

If you have not selected an appropriate source, you cannot view the playback picture on the TV.

For the HDMI terminal:

HDMI VCR	Select this when connecting a VCR to the HDMI terminal.
HDMI DBS	Select this when connecting a DBS tuner to the HDMI terminal.

Initial setting: VCR

For the COMPONENT VIDEO jacks:

CMPNT VCR	Select this when connecting a VCR to the COMPONENT VIDEO jacks.
CMPNT DBS	Select this when connecting a DBS tuner to the COMPONENT VIDEO jacks.

Initial setting: VCR

Selecting the output video signals—VIDEO OUTPUT

When you connect your TV and this receiver with the HDMI cable, set this setting to "HDMI."

With this setting, this receiver converts incoming composite video, S-video, and component video signals from video components and transmits the converted signals through the HDMI cable.

VIDEO HDMI	Select this when connecting a TV to the HDMI terminal.
VIDEO OTHER	Select this when connecting a TV to any video jack other than the HDMI terminal.

Initial setting: HDMI

NOTE

When selecting "HDMI," the AV COMPU LINK remote control system is restricted (see page 45).

Sound adjustments

You can make sound adjustment to your preference after completing basic setting.

Basic adjustment items

You can adjust the following items. See pages in parentheses for details.

- You cannot select the items which is not available with the current setting.

Items	To do
SUBWFR LVL * ¹	Adjust the subwoofer output level. (36)
FRONT L LVL * ^{1,2}	Adjust the left front speaker output level. (36)
FRONT R LVL * ^{1,2}	Adjust the right front speaker output level. (36)
CENTER LVL * ^{1,2}	Adjust the center speaker output level. (36)
SURR L LVL * ^{1,2}	Adjust the left surround speaker output level. (36)
SURR R LVL * ^{1,2}	Adjust the right surround speaker output level. (36)
S BACK LVL * ^{1,2}	Adjust the surround back speaker output level when using a single speaker for the surround back speaker. (36)
S BACK L LVL * ^{1,2}	Adjust the left surround back speaker output level. (36)
S BACK R LVL * ^{1,2}	Adjust the right surround back speaker output level. (36)
D EQ 63Hz * ¹	Adjust the equalization pattern of each band. (36)
D EQ 250Hz * ¹	
D EQ 1kHz * ¹	
D EQ 4kHz * ¹	
D EQ 16kHz * ¹	
BASS BOOST	Boost the bass level. (37)
INPUT ATT	Attenuate the input level of analog source. (37)
EFFECT	Adjust the effect level. (37)
ROOM SIZE	Select the room size for your virtual listening room. (37)
LIVENESS	Select the liveness level for your virtual listening room. (37)
PANORAMA	Add "wraparound" sound effect with sidewall image. (37)
CENTER WIDTH	Adjust the center channel localization between the center speaker and the left/right speakers. (38)
DIMENSION	Adjust sound localization pattern. (38)
CENTER GAIN	Adjust the sound localization of the center channel. (38)
CENTER TONE	Make the center tone soft or sharp. (38)
CENTER ALIGN	Align the vertical localization of the center channel signals. (38)

*¹ You can adjust these items directly from the remote control.

*² If you have performed Precise Surround Setup on pages 16 to 18, these settings are not required.

NOTE

Some items above are not available in the following cases below:

- When selecting "A MULTI" for the audio input setting (see page 11)
- When multi-channel PCM signals (see page 41) are coming in with selecting "HDMI" for the audio input setting (see page 11)

Operating procedure

On the front panel:

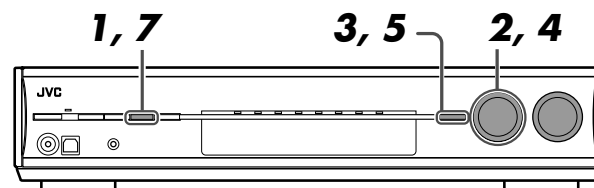

Before you start, remember...

There is a time limit in doing the following steps. If the setting is canceled before you finish, start from step **1** again.

Ex.: When adjusting subwoofer output level.

1 Press ADJUST.

MULTI JOG now works for the sound adjustment.

2 Turn MULTI JOG until the item you want to adjust appears on the display.

- As you turn MULTI JOG, the adjustment items change as follows:

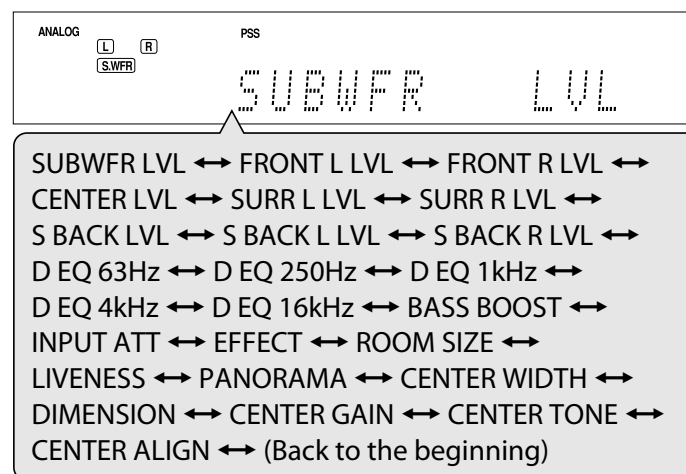

3 Press SET.

The current setting for the selected item appears.

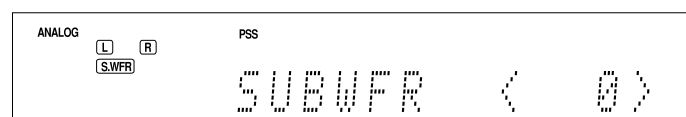

4 Turn MULTI JOG to adjust the selected item.

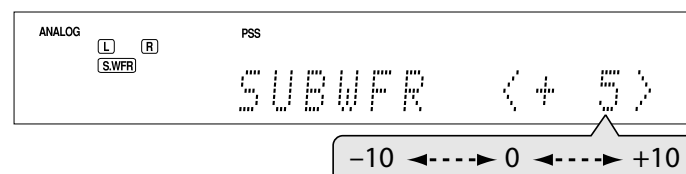

5 Press SET.

Your adjustment is stored.

6 Repeat steps 2 to 5 to adjust other items if necessary.

7 Press ADJUST.

The source indication resumes on the display.

Adjusting the speaker output levels

- SUBWFR LVL (subwoofer output level)
- FRONT L LVL (left front speaker output level)
- FRONT R LVL (right front speaker output level)
- CENTER LVL (center speaker output level)
- SURR L LVL (left surround speaker output level)
- SURR R LVL (right surround speaker output level)
- S BACK LVL (surround back speaker output level)
- S BACK L LVL (left surround back speaker output level)
- S BACK R LVL (right surround back speaker output level)

You can adjust the speaker output levels.

By using Precise Surround Setup (see pages 16 to 18), you can set the output levels of all the speakers to the same levels.

Adjustable range: -10 (dB) to +10 (dB) (in 1 dB intervals)

Initial setting: 0 (dB) for all speakers

NOTES

- If you have selected "NO" for a speaker (see page 30), the output level for the corresponding speaker is not adjustable.
- If you have selected "1SPK" for "S BACK OUT" (see page 31), "S BACK LVL" appears instead of "S BACK L LVL" and "S BACK R LVL."
- While using the headphones, you cannot adjust the speaker output levels.

From the remote control:

1 Press TEST to check the speaker output balance.

"TEST FL" starts flashing on the display, and test tones come out of the speakers clockwise.

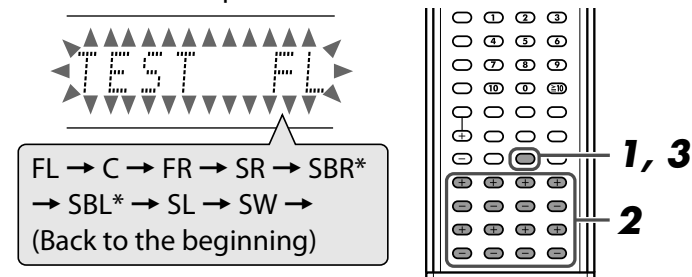

- You can adjust the speaker output levels without the test tone.

2 Adjust the speaker output levels.

Press the + or - button corresponding to the speaker you want to adjust.

3 Press TEST again to stop the test tone.

- * When using a single speaker for the surround back speaker, the test tone comes out of "SB" instead of "SBR" and "SBL."

NOTES

- No test tone comes out of the speakers for which the speaker setting is set to "NO" (see page 30).
- No test tone is available when the headphones are in use.
- If you have selected "1SPK" for "S BACK OUT" (see page 31), press S. BACK L +/- to adjust the output level.
- When the PSS indicator is lit, the frequency response of each channel appears on the display with the test tone. (See page 18.)

Adjusting the equalization patterns—D EQ 63Hz/250Hz/1kHz/4kHz/16kHz

You can adjust equalization patterns in five frequency bands (center frequency: 63 Hz, 250 Hz, 1 kHz, 4 kHz, 16 kHz) for the front speakers.

- Once you have made an adjustment, it is memorized for each source.

Adjustable range: -8 (dB) to +8 (dB) (in 2 dB intervals)

Initial setting: 0 (dB) for all bands

- When making an adjustment, the DIGITAL EQ indicator lights up on the display.

If no adjustment is required, set all the frequency bands to "0 (dB)."

- The DIGITAL EQ indicator goes off from the display.

From the remote control:

Before you start, remember...

There is a time limit in doing the following steps. If the setting is canceled before you finish, start from step 1 again.

1 Press D. EQ FREQ repeatedly to select the band you want to adjust.

2 Press D. EQ LEVEL + or - to adjust the equalization pattern of the selected band.

3 Repeat steps 1 and 2 to adjust other bands.

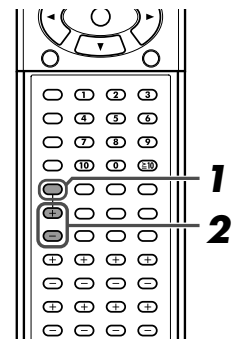

Adjusting the bass sounds

- You cannot adjust these items directly from the remote control.

■ Reinforcing the bass—BASS BOOST

You can boost the bass level—Bass Boost.

- Once you have made an adjustment, it is memorized for each source.

B BOOST ON	Select to boost the bass level. The B.BOOST indicator lights up on the display.
-------------------	---

B BOOST OFF	Select to deactivate the Bass Boost.
--------------------	--------------------------------------

Initial setting: OFF

NOTE

This function affects only the sound coming out through the front speakers.

■ Attenuating the input signal—INPUT ATT

When the input level of analog source is too high, the sound will be distorted. If this happens, you need to attenuate the input signal level to prevent the sound distortion.

- Once you have made an adjustment, it is memorized for each source.

ATT ON	Select to attenuate the input signal level. The INPUT ATT indicator lights up on the display.
---------------	---

ATT NORMAL	Select to deactivate attenuation.
-------------------	-----------------------------------

Initial setting: NORMAL

Adjusting the sound parameters for the Surround/DSP modes

You can adjust the Surround/DSP sound parameters to your preference.

- For details about the Surround/DSP modes, see pages 39 to 44.
- You cannot adjust these items directly from the remote control.

■ Adjusting the effect level for DSP modes—EFFECT

This setting is available only when one of the DSP modes (except All Channel Stereo) is in use. To activate DSP mode, see pages 43 and 44.

- Once you have made an adjustment, it is memorized for each DSP mode.

Adjustable range: 1 to 5 (in 1 step intervals)

Initial setting: 3

As the number increases, the effect becomes stronger. Normally, select "3."

■ Adjusting the virtual room size for DSP modes—ROOM SIZE

This setting is available only when one of the DSP modes (except All Channel Stereo) is in use. To activate DSP mode, see pages 43 and 44.

- If "SURROUND SPK" is set to "NO" (see page 30), this item is not adjustable.
- Once you have made an adjustment, it is memorized for each DSP mode.

Adjustable range: 1 to 5 (in 1 step intervals)

Initial setting: 3

As the number increases, the interval between reflections increases so that you will feel as if you were in a larger room. Normally, select "3."

■ Adjusting the liveness effect for DSP modes—LIVENESS

This setting is available only when one of the DSP modes (except All Channel Stereo) is in use. To activate DSP mode, see pages 43 and 44.

- If "SURROUND SPK" is set to "NO" (see page 30), this item is not adjustable.
- Once you have made an adjustment, it is memorized for each DSP mode.

Adjustable range: 1 to 5 (in 1 step intervals)

Initial setting: 3

As the number increases, the attenuation level of reflections over time decreases so that acoustics change from "Dead" to "Live."

Normally, select "3."

■ Adjusting the panorama control for Pro Logic IIx Music and Pro Logic II Music—PANORAMA

This setting is available when Pro Logic IIx Music or Pro Logic II Music is activated for the analog or digital 2-channel sound signal.

To activate Pro Logic IIx Music or Pro Logic II Music, see pages 43 and 44.

- Once you have made an adjustment, it is memorized until you change the setting.

PANORAMA ON	Select to add "wraparound" sound effect with side-wall image.
--------------------	---

PANORAMA OFF	Select to listen to originally recorded sound.
---------------------	--

Initial setting: OFF

■ Adjusting the center channel localization for Pro Logic IIx Music and Pro Logic II Music—CENTER WIDTH

This setting is available when Pro Logic IIx Music or Pro Logic II Music is activated for the analog or digital 2-channel sound signal.

To activate Pro Logic IIx Music or Pro Logic II Music, see pages 43 and 44.

- If "CENTER SPK" is set to "NO" (see page 30), this item is not adjustable.
- Once you have made an adjustment, it is memorized until you change the setting.

Adjustable range: OFF and 1 to 7 (in 1 step intervals)

Initial setting: 3

As the number increases, the center channel sound moves toward the left and right speakers.

Normally, select "3."

■ Adjusting the sound localization position for Pro Logic IIx Music and Pro Logic II Music—DIMENSION

This setting is available when Pro Logic IIx Music or Pro Logic II Music is activated for the analog or digital 2-channel sound signal.

To activate Pro Logic IIx Music or Pro Logic II Music, see pages 43 and 44.

- Once you have made an adjustment, it is memorized until you change the setting.

Adjustable range: 1 to 7 (in 1 step intervals)

Initial setting: 4

As the number increases, the sound localization moves towards forward from backward.

Normally, select "4."

■ Adjusting the sound localization of the center channel—CENTER GAIN

This setting is available only when Neo:6 Music is in use.

- If "CENTER SPK" is set to "NO" (see page 30), this item is not adjustable.
- Once you have made an adjustment, it is memorized until you change the setting.

Adjustable range: 0 to 1.0 (in 0.1 step intervals)

Initial setting: 0.3

As the number increases, the center channel will be localized clearly.

Normally, select "0.3."

■ Adjusting the center tone—CENTER TONE

This setting is available when one of the Surround/DSP modes is in use. To activate Surround/DSP mode, see pages 43 and 44.

- If "CENTER SPK" is set to "NO" (see page 30), this item is not adjustable.
- This setting is common to all Surround modes, and is memorized separately for DSP modes.

Adjustable range: 1 to 5 (in 1 step intervals)

Initial setting: 3

As the number increases, the dialogue becomes stronger. Normally, select "3."

- When the center tone is set to other than "3," the C.TONE indicator lights up on the display.

■ Aligning the vertical localization of the center channel for Surround/DSP modes—CENTER ALIGN

This setting is available when one of the Surround/DSP modes (except Pro Logic IIx Music, Pro Logic II Music, Neo:6 Music, and All Channel Stereo) is in use. To activate Surround/DSP mode, see pages 43 and 44.

- If "CENTER SPK" is set to "NO" (see page 30), this item is not adjustable.
- Once you have made an adjustment, it is memorized for each Surround/DSP mode.

C ALIGN ON Select this when you cannot feel as if the actors or singers are speaking or singing on the screen.

C ALIGN OFF Center alignment is turned off.

Initial setting: OFF

Creating realistic sound fields

Reproducing theater ambiance

In a movie theater, many speakers are located on the walls to reproduce impressive multi-channel sound, reaching you from all directions.

With these many speakers, sound localization and sound movement can be expressed.

Surround/DSP modes built in this receiver can create almost the same Surround sound as you can feel in a real movie theater.

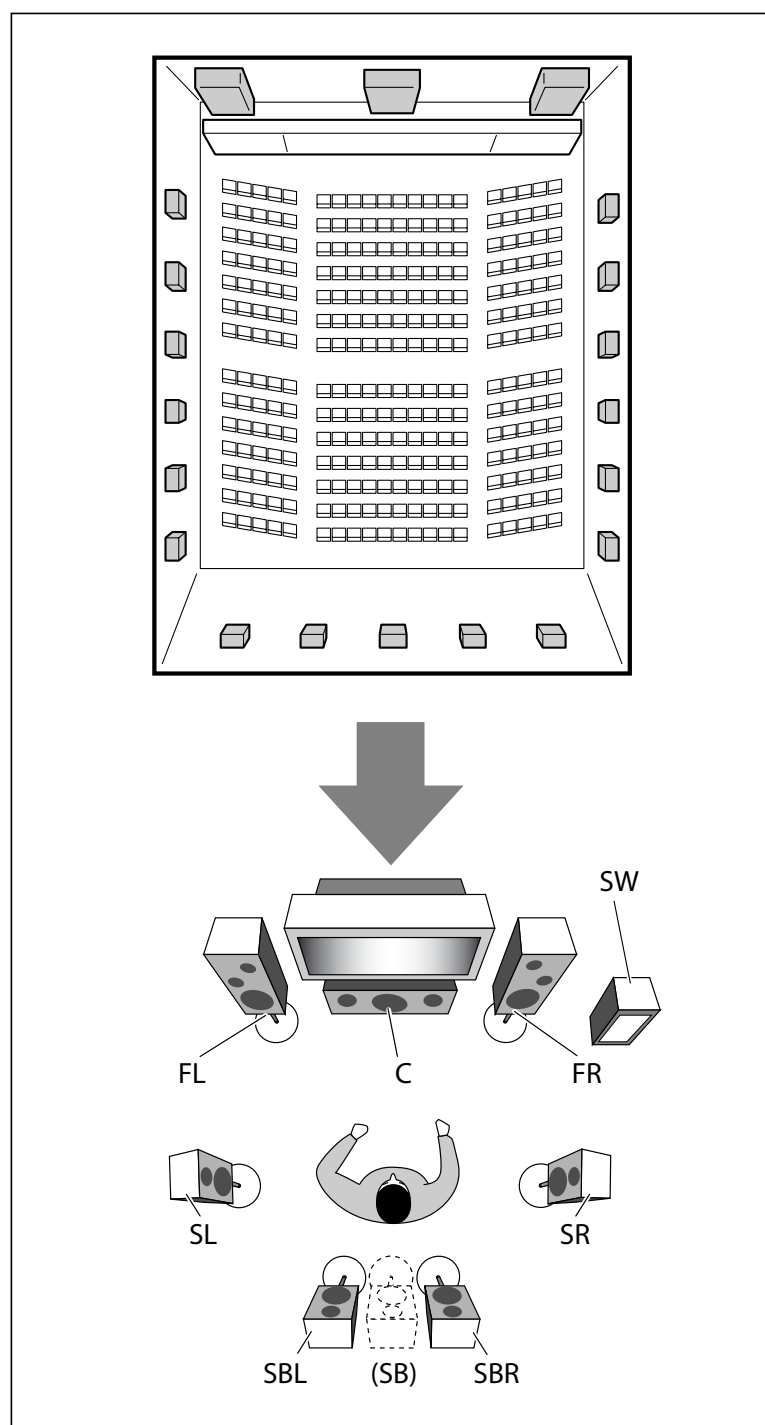

Introducing the Surround modes

■ Dolby Digital*

Dolby Digital is a digital signal compression method, developed by Dolby Laboratories, and enables multi-channel encoding and decoding.

- When Dolby Digital signal is detected through the digital input, the **DIGITAL** indicator lights up on the display.

Dolby Digital 5.1CH

Dolby Digital 5.1CH (DOLBY DIGITAL) encoding method records and digitally compresses the left front channel, right front channel, center channel, left surround channel, right surround channel, and LFE channel signals (total 6 channels, but the LFE channel is counted as 0.1 channel; therefore, called 5.1 channel).

Dolby Digital enables stereo surround sounds, and sets the cutoff frequency of the surround treble at 20 kHz, compared to 7 kHz for Dolby Pro Logic. As such, the sound movement and "being-there" feeling are enhanced much more than Dolby Pro Logic.

Dolby Digital EX

Dolby Digital EX (DOLBY D EX) is a digital surround encoding format that adds the third surround channels, called "surround back."

Compared to the conventional Dolby Digital 5.1CH, these newly added surround back channels can reproduce more detailed movements behind you while viewing the video software. In addition, surround sound localization will become more stable.

■ Dolby Surround

Dolby Pro Logic II

Dolby Pro Logic II is a multi-channel playback decoder to convert 2-channel software into 5-channel (plus subwoofer). The matrix-based conversion method used for Dolby Pro Logic II makes no limitation for the cutoff frequency of the surround treble and enables stereo surround sound.

- This receiver provides three types of Dolby Pro Logic II modes—**Pro Logic II Movie** (PLII MOVIE), **Pro Logic II Music** (PLII MUSIC), and **Pro Logic II Game** (PLII GAME). When Dolby Pro Logic II is activated, the **PL II** indicator lights up on the display.

PLII MOVIE Suitable for playing any Dolby Surround encoded software. You can enjoy a sound field very close to the one created with discrete 5.1-channel sounds.

PLII MUSIC Suitable for playing any 2-channel stereo software. You can enjoy wide and deep sounds.

PLII GAME Suitable for when playing a video game. You can enjoy sounds with "being there" feeling.

* Manufactured under license from Dolby Laboratories. "Dolby", "Pro Logic", and the double-D symbol are trademarks of Dolby Laboratories.

Continued on the next page

Dolby Pro Logic IIx

Dolby Pro Logic IIx is another multi-channel playback decoder to convert not only multi-channel software but 2-channel software into 7.1 channel (or 6.1 channel) that developed from Dolby Pro Logic II. The matrix-based conversion method used for Dolby Pro Logic IIx makes no limitation for the cutoff frequency of the surround treble.

- This receiver provides three types of Dolby Pro Logic IIx modes—**Pro Logic IIx Movie** (PLIIx MOVIE), **Pro Logic IIx Music** (PLIIx MUSIC), and **Pro Logic IIx Game** (PLIIx GAME). When Dolby Pro Logic IIx is activated, “PLIIx MOVIE,” “PLIIx MUSIC,” or “PLIIx GAME” appear and the  indicator lights up on the display.

PLIIx MOVIE Suitable for playing any Dolby Surround encoded software. You can enjoy a sound field with a natural wraparound effect.

PLIIx MUSIC Suitable for playing any 2-channel stereo software. You can enjoy wide and deep 7.1-channel sounds.

PLIIx GAME Suitable for when playing a video game. You can enjoy 7.1-channel sounds with “being there” feeling. This mode is available only for an analog 2-channel signal.

■ **DTS***

DTS is another digital signal compression method, developed by Digital Theater Systems, Inc., and enables multi-channel encoding and decoding (1ch up to 6.1ch).

- When DTS signal is detected through the digital input, the  indicator lights up on the display.

DTS Digital Surround

DTS Digital Surround (DTS) is a discrete 5.1-channel digital audio format available on CD, LD, and DVD software. Compared to Dolby Digital, the DTS Digital Surround format has a lower audio compression rate which enables it to add breadth and depth to the sounds reproduced. As such, DTS Digital Surround features natural, solid, and clear sound.

DTS Extended Surround (DTS-ES)

DTS-ES is another multi-channel digital encoding format. It greatly improves the 360-degree surround impression and space expression by adding the third surround channel—surround back channel.

DTS-ES includes two signal formats with different surround signal recording methods—**DTS-ES Discrete 6.1ch** (ES DISCRETE) and **DTS-ES Matrix 6.1ch** (ES MATRIX).

DTS-ES Discrete 6.1ch has been designed to encode (and decode) a 6.1-channel signal discretely to avoid interference with each channel.

DTS-ES Matrix 6.1ch has been designed to add an extra surround channel to DTS Digital Surround 5.1-channel. By using a matrix encoding/decoding method, an additional “surround back” channel signal is encoded (and decoded) in both the left and right surround channel signals.

DTS 96/24

In recent years, there has been increasing interest in higher sampling rates both for recording and for reproducing at home. Higher sampling rates allow wider frequency range and greater bit depths provide extended dynamic range.

DTS 96/24 is a multi-channel digital signal format (fs 96 kHz/24 bits) introduced by Digital Theater Systems, Inc. to deliver “better-than-CD sound quality” into the home.

- When DTS 96/24 signal is detected, the  indicator lights up. You can enjoy its 5.1-channel sound with full-quality.

DTS Neo:6

DTS Neo:6 is another conversion method to create 6-channel (plus subwoofer) from analog/digital 2-channel software by using the high precision digital matrix decoder used for DTS-ES Matrix 6.1ch.

- This receiver provides the following DTS Neo:6 modes—**Neo:6 Cinema** (NEO:6 CINEMA) and **Neo:6 Music** (NEO:6 MUSIC).

When one of them is activated, the NEO:6 indicator lights up on the display.

NEO:6 CINEMA Suitable for playing movies. You can get the same atmosphere with 2-channel software as with 6.1-channel software. It is also effective for playing software encoded with conventional surround formats.

NEO:6 MUSIC Suitable for playing music software. The front channel signals bypass the decoder (resulting in no loss of sound quality) and the surround signals transmitted through the other speakers expand the sound field naturally.

* “DTS”, “DTS-ES”, “Neo:6” and “DTS 96/24” are trademarks of Digital Theater Systems, Inc.

When using Surround mode, the sounds come out of the activated speakers which the Surround mode requires.

- **If either “SURROUND SPK” or “CENTER SPK” is set to “NO” in the speaker setting (see page 30)**, the corresponding channel signals are allocated to and emitted through the front speakers.
- **If both “SURROUND SPK” and “CENTER SPK” are set to “NO” in the speaker setting (see page 30)**, JVC’s original 3D-PHONIC processing (which has been developed to create the surround effect through the front speakers only) is used. The 3D-PHONIC indicator lights up on the display.

About other digital signals

Linear PCM—Uncompressed digital audio data used for DVDs, CDs, and Video CDs

DVDs support 2 channels with sampling rates of 48/96 kHz, at quantization of 16/20/24 bits. On the other hand, CDs and Video CDs are limited to 2 channels with 44.1 kHz at 16 bits.

- When Linear PCM signal is detected, the LINEAR PCM indicator lights up.

Multi-channel PCM—Uncompressed multi-channel digital audio data used for DVD-Audios

DVD-Audios support up to 5.1 channels with sampling rates of 44.1/48/88.2/96 kHz and 2 channels with sampling rates of 44.1/48/88.2/96/176/192 kHz, at quantization of 16/20/24 bits.

- When the Multi-channel PCM signal is detected, the LINEAR PCM indicator lights up and "MULTI CH PCM" appears on the display for a while.

Dual Mono

Dual Mono can be easily understood when you think of the bilingual broadcast for TV programs (however, the Dual Mono format is not identical with those analog formats). This format is now adopted in Dolby Digital, DTS, and so on. It allows two independent channels (called main channel and sub-channel) to be recorded separately.

- You can select either channel you want to listen to (see page 32).

■ Digital Acoustic Processor (DAP) modes

You can use the following DAP modes in order to reproduce a more acoustic sound field in your listening room.

HALL1	Reproduces the spatial feeling of a large shoebox-shaped hall designed primarily for classical concerts. (Its seating capacity is about 2000.)
HALL2	Reproduces the spatial feeling of a large vineyard-shaped hall designed primarily for classical concerts. (Its seating capacity is about 2000.)
LIVE CLUB	Reproduces the spatial feeling of a live music club with a low ceiling.
DANCE CLUB	Reproduces the spatial feeling of a rocking dance club.
PAVILION	Reproduces the spatial feeling of an exhibition hall with a high ceiling.
THEATER1	Reproduces the spatial feeling of a large theater where the seating capacity is about 600.
THEATER2	Reproduces the spatial feeling of a small theater where the seating capacity is about 300.

NOTE

When "THEATER1" or "THEATER2" is activated while playing back 2-channel analog or digital source, the built-in Dolby Pro Logic II decoder is activated and the  PL II indicator lights up.

Introducing the DSP modes

The sound heard in a concert hall, club, etc. consists of direct sound and indirect sound—early reflections and reflections from behind. Direct sounds reach the listener directly without any reflection. On the other hand, indirect sounds are delayed by the distances of the ceiling and walls. These direct sounds and indirect sounds are the most important elements of the acoustic surround effects.

The DSP modes can create these important elements, and give you a real "being there" feeling.

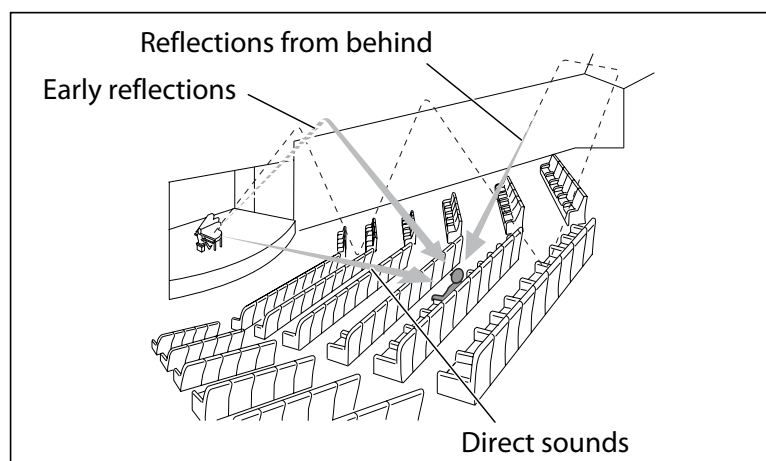

The DSP modes include the following modes:

- Digital Acoustic Processor (DAP) modes—HALL1, HALL2, LIVE CLUB, DANCE CLUB, PAVILION, THEATER1, THEATER2
- MONO FILM—Used for all types of 2-channel signals (including Dual Mono signal)
- All Channel Stereo mode (ALL CH STEREO)

When one of the DSP modes is activated, the DSP indicator lights up on the display.

When using the DAP mode, the sounds come out of all the connected and activated speakers.

- If "SURROUND SPK" is set to "NO" in the speaker setting (see page 30), JVC's original 3D-PHONIC processing (which has been developed to create the surround effect through the front speakers only) is used. The 3D-PHONIC indicator lights up on the display.

■ MONO FILM

In order to reproduce a more acoustic sound field in your listening room while viewing monaural sound video software (analog and 2-channel digital signals including Dual Mono signal), you can use this mode.

The surround effect will be added, and the sound localization of actor's words will be improved.

This mode cannot be used for multi-channel digital signals.

When "MONO FILM" is used, sounds come out of all the connected (and activated) speakers.

- If "SURROUND SPK" is set to "NO" in the speaker setting (see page 30), JVC's original 3D-PHONIC processing (which has been developed to create the surround effect through the front speakers only) is used. The 3D-PHONIC indicator lights up on the display.
- If incoming signals change from 2-channel digital signal to another digital signal type, "MONO FILM" is canceled and an appropriate Surround mode is activated.

Continued on the next page

■ All Channel Stereo mode (ALL CH STEREO)

This mode can reproduce a larger stereo sound field using all the connected (and activated) speakers. **This mode cannot be used if "SURROUND SPK" is set to "NO" in the speaker setting (see page 30).**

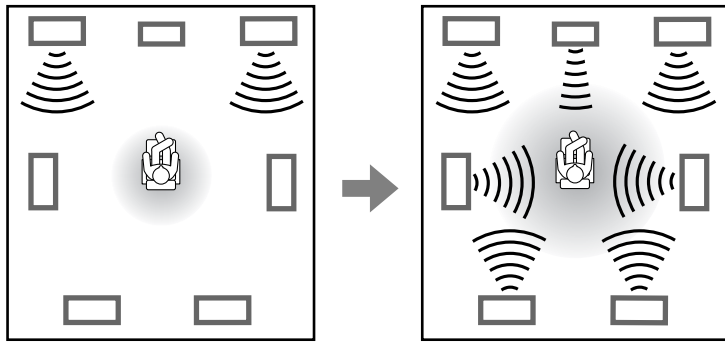

Sound reproduced from normal stereo

Sound reproduced from All Channel Stereo mode

3D HEADPHONE mode

If you connect a pair of headphones while one of the Surround/DSP modes is in use, the 3D HEADPHONE mode is activated without respect to the type of software played back.

- "3D HEADPHONE" appears on the display and the DSP and HEADPHONE indicators light up.

Using the Surround/DSP modes

Available Surround/DSP modes vary depending on the speaker settings and the incoming signals. See the table below.

- The numbers inside the parentheses following the incoming signal type indicate the number of the front channels and that of the surround channels. For example, (3/2) indicates that the signals are encoded with three front signals (left/right/center) and two (stereo) surround signals.
- For EX/ES/PLIIX setting, see page 32.

Incoming Signal Type		EX/ES/PLIIX setting				
		AUTO	ON	PLIIX MOVIE	PLIIX MUSIC	OFF
Dolby Digital	Dolby Digital Surround EX	DOLBY D EX*2,4	DOLBY D EX*2	□□ D+PLIIX MOVIE*1,2	□□ D+PLIIX MUSIC*2	DOLBY DIGITAL
	Dolby Digital (3/2, 2/2)	DOLBY DIGITAL	DOLBY D EX*2	□□ D+PLIIX MOVIE*1,2	□□ D+PLIIX MUSIC*2	DOLBY DIGITAL
	Dolby Digital (3/1, 2/1, 3/0, 1/0)	DOLBY DIGITAL				
	Dolby Digital (Dual Mono)	DUAL MONO				
DTS	DTS-ES Discrete	DTS-ES DSCRT*2	DTS-ES DSCRT*2	DTS+PLIIX MOVIE*1,2	DTS+PLIIX MUSIC*2	DTS SURROUND
	DTS-ES Matrix	DTS-ES MATRIX*2	DTS-ES MATRIX*2	DTS+PLIIX MOVIE*1,2	DTS+PLIIX MUSIC*2	DTS SURROUND
	DTS (3/2, 2/2)	DTS SURROUND	DTS+NEO:6*2	DTS+PLIIX MOVIE*1,2	DTS+PLIIX MUSIC*2	DTS SURROUND
	DTS (3/1, 2/1, 3/0, 1/0)	DTS				
	DTS (Dual Mono)	DUAL MONO				
Analog/LINEAR PCM/Dolby Digital/DTS (2/0)		PLIIX MOVIE*3/ PLIIX MUSIC*3/ PLIIX GAME*3/ NEO:6 CINEMA/ NEO:6 MUSIC			PLII MOVIE/ PLII MUSIC/ PLII GAME/ NEO:6 CINEMA/ NEO:6 MUSIC	

*1 When "S BACK OUT" is set to "1SPK," "□□ D+PLIIX MOVIE" is changed to "DOLBY D EX" and "DTS+PLIIX MOVIE" is changed to "DTS+ □□ EX."

*2 When "S BACK SPK" is set to "NO," Virtual Surround Back is activated for the modes and the VIRTUAL SB indicator lights up on the display.

*3 When "S BACK SPK" is set to "NO," "PLIIX MOVIE," "PLIIX MUSIC," and "PLIIX GAME" are changed to "PLII MOVIE," "PLII MUSIC," and "PLII GAME."

*4 For some Dolby Digital Surround EX software, Dolby Digital 5.1-channel reproduction ("DOLBY DIGITAL") may be applied even though you have selected "AUTO." Select "ON" to apply "DOLBY D EX."

■ About the DSP modes

- The following DSP modes are available regardless of incoming signal type:
HALL1, HALL2, LIVE CLUB, DANCE CLUB, PAVILION, THEATER1, THEATER2
- If multi-channel (more than 2 channels) digital signals are coming in, "MONO FILM" is not available.
- If "SURROUND SPK" is set to "NO," "ALL CH STEREO" is not available.

Virtual Surround Back

If you have connected (and activated) the surround speakers, you can use Virtual Surround Back. This function creates the great surround effect from the behind without using a surround back speaker as if you have connected it.

- The VIRTUAL SB indicator lights up on the display.

Virtual Surround Back is activated when selecting any setting other than "OFF" for the EX/ES/PLIIX setting and playing back the software including the following signals:

- Dolby Digital Surround EX
- DTS-ES
- Dolby Digital or DTS with 4 channels or more

Activating the Surround/DSP modes

Available Surround/DSP modes vary depending on the speaker settings and the incoming signals. For details about the Surround modes, see page 42.

Activating one of the Surround/DSP modes automatically recalls the memorized settings and adjustments.

- **To adjust the speaker output level**, see page 36.
- **When activating one of the Surround/DSP modes**, you can adjust the center tone (see page 38).
- **When activating one of the Surround/DSP modes (except PLIIX MUSIC, PLII MUSIC, NEO:6 MUSIC, and ALL CH STEREO)**, you can align the vertical localization of the center channel (see page 38).
- **When activating "NEO:6 MUSIC,"** you can adjust the sound localization of the center channel (see page 38).
- **When activating the DSP mode (except ALL CH STEREO)**, you can adjust the following settings:
 - Effect level (see page 37)
 - Liveness effect (see page 37)
 - Virtual room size (see page 37)
- **When activating "PLIIX MUSIC" and "PLII MUSIC,"** you can adjust the following settings:
 - Center channel localization (see page 38)
 - Sound localization position (see page 38)
 - Panorama control (see page 37)

■ AUTO SURROUND

You can enjoy the Surround mode easily while playing a digital source.

- For the Surround/DSP mode selection, see page 44.

How does "AUTO SURROUND" work?

- If a multi-channel signal comes in, an appropriate Surround mode will be selected automatically.
- If a Dolby Digital 2-channel signal with surround signal comes in, "PLIIX MOVIE" or "PLII MOVIE" will be selected.
- If a Dolby Digital 2-channel signal without surround signal comes in, "SURROUND OFF (stereo)" will be selected.
- If a Linear PCM signal comes in, "SURROUND OFF (stereo)" will be selected.

- When "AUTO SURROUND" is activated, the AUTO Surr indicator lights up on the display.

NOTE

"AUTO SURROUND" does not take effect in the following cases:

- While playing an analog source,
- While selecting one of the fixed digital decode mode—"DOLBY DIGITAL" or "DTS" (see page 22).

■ Selecting the Surround/DSP modes

From the remote control:

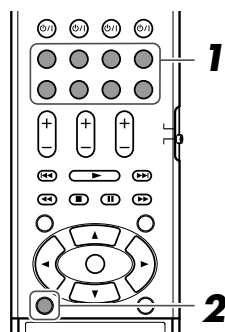

1 Select and play any source.

- Surround/DSP modes are not available when multi-channel PCM (see page 41) signals recorded in DVD-Audio are coming in. See page 11 for details.
- Make sure you have selected the audio input mode (analog or digital) correctly (see page 21).

2 Press SURROUND repeatedly to select the Surround/DSP mode you want.

Ex.: When "DOLBY DIGITAL" is selected for Dolby Digital multi-channel software:

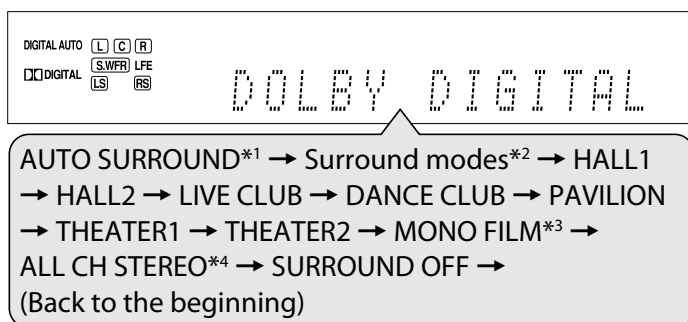

*1 "AUTO SURROUND" is the initial setting.

*2 Available Surround modes vary depending on the speaker settings and the incoming signals. For details, see page 42.

*3 If an incoming signal is a multi-channel (more than 2 channel) digital signal, "MONO FILM" is not available.

*4 If "SURROUND SPK" is set to "NO," "ALL CH STEREO" is not available.

To cancel Surround/DSP modes

Press SURROUND repeatedly so that "SURROUND OFF" appears on the display.

On the front panel:

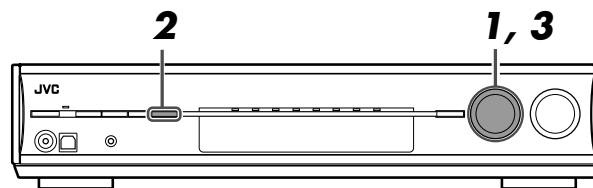

Before you start, remember...

There is a time limit in doing the following steps. If the setting is canceled before you finish, start from step 2 again.

1 Select and play any source.

- Surround/DSP modes are not available when multi-channel PCM (see page 41) signals recorded in DVD-Audio are coming. See page 11 for details.
- Make sure you have selected the audio input setting (analog or digital) correctly (see page 21).

2 Press SURROUND.

MULTI JOG now works for selecting Surround/DSP modes.

3 Turn MULTI JOG to select the Surround/DSP mode you want.

Ex.: When "DOLBY DIGITAL" is selected for Dolby Digital multi-channel software:

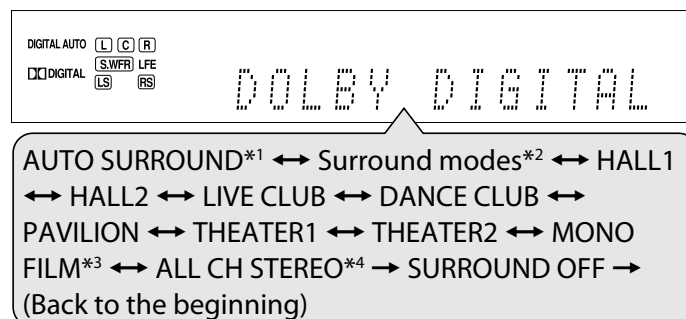

*1 "AUTO SURROUND" is the initial setting.

*2 Available Surround modes vary depending on the speaker settings and the incoming signals. For details, see page 42.

*3 If an incoming signal is a multi-channel (more than 2 channels) digital signal, "MONO FILM" is not available.

*4 If "SURROUND SPK" is set to "NO," "ALL CH STEREO" is not available.

To cancel Surround/DSP modes

Turn MULTI JOG so that "SURROUND OFF" appears on the display.

AV COMPU LINK remote control system

The AV COMPU LINK remote control system allows you to operate JVC's video components (TV, DVD player*, and VCR) through this receiver.

This receiver is equipped with the AV COMPU LINK-III, which has added a function to operate JVC's video components through the component video jacks. To use this remote control system, you need to connect the video components you want to operate, following the diagrams below and the procedures on page 46.

- Refer also to the manuals supplied with your video components.

* "DVD player" on pages 45 and 46 can be replaced with "DVD recorder."

Connections 1: AV COMPU LINK connection

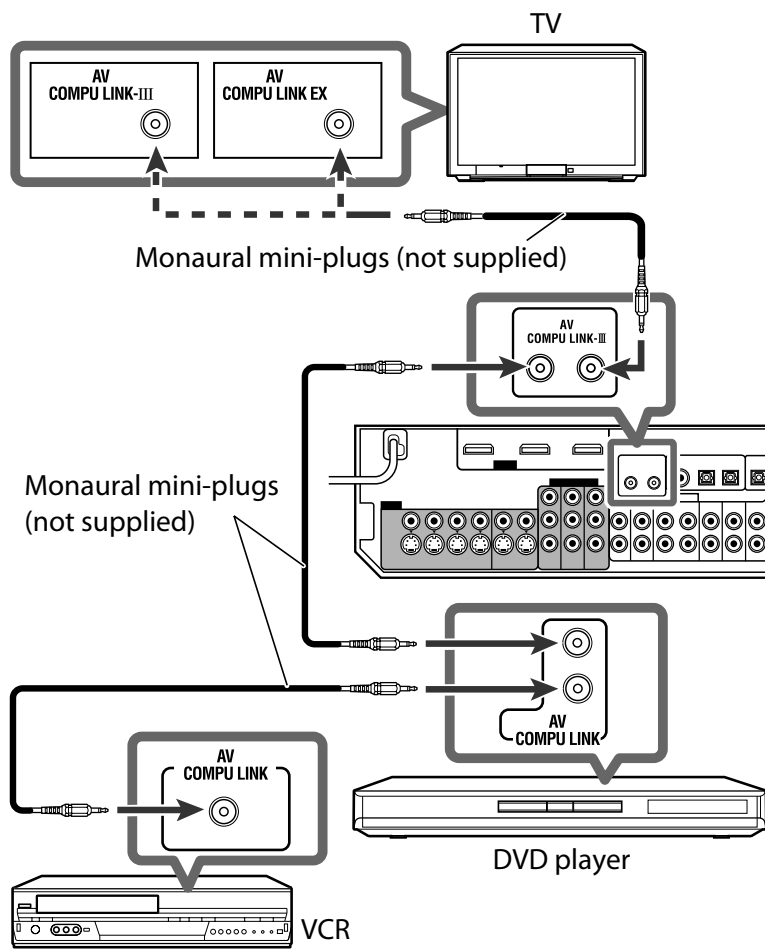

IMPORTANT:

- The AV COMPU LINK remote control system cannot control the DBS tuner connected to the DBS IN jacks.
- To use the AV COMPU LINK remote control system, select "OHTER" for the video output setting (see page 34); otherwise, the AV COMPU LINK remote control system is restricted to turning the video component on and off. See "Automatic power on/off" on page 46.

NOTES

- When connecting the receiver and a TV with the AV COMPU LINK EX terminal by using a component video cable, you cannot use Automatic selection of TV input mode (see page 46).
- When connecting only the VCR or DVD player to this receiver, connect it directly to the receiver using a cable with the monaural mini-plugs.
- You can connect only the TV with AV COMPU LINK EX or AV COMPU LINK-III terminal to the AV COMPU LINK-III terminal.

Connections 2: Video cable connection

This receiver is equipped with three types of the video terminals as well as the HDMI terminals—composite video, S-video, and component video—and the signals coming into this receiver through one type of video terminals can output only through the terminal of the same type. So you need to connect the video components to this receiver using one of the following three ways.

- When using the AV COMPU LINK remote control system, set the video input and video output setting for the DVD player and the VCR correctly (see "Selecting the video input setting" on page 21 and "Selecting the output video signals—VIDEO OUTPUT" on page 34); otherwise, the correct input for this receiver will not be selected on the TV.

Case 1:

When connecting the source equipment to the receiver through the S-video terminals, connect this receiver to the TV video input 1 terminal using S-video cables.

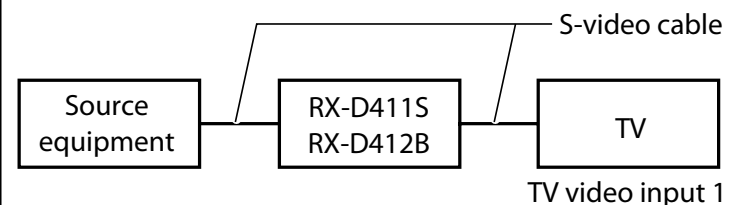

Case 2:

When connecting the source equipment to the receiver through the composite video jacks, connect this receiver to the TV video input 2 terminal (composite video input) using composite video cables.

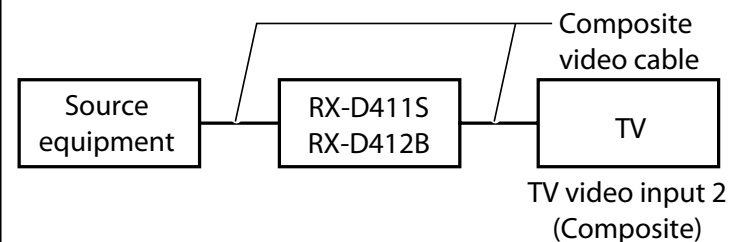

Case 3:

When connecting the source equipment to the receiver through the component video jacks, connect this receiver to the TV video input 2 terminals (component video input) using component video cables.

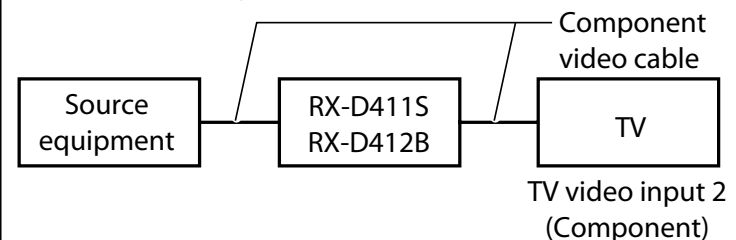

■ Connecting procedure

1 If you have already plugged your VCR, DVD player, TV, and this receiver into the AC outlets, unplug their AC power cords first.

2 Connect your VCR, DVD player, TV, and this receiver, using the cables with the monaural mini-plugs (not supplied).

- See "Connections 1" on the previous page.

3 Connect the audio input/output jacks on the VCR, DVD player, TV, and this receiver using the audio cables.

- See pages 10 to 13.

4 Connect the video input/output jacks on the VCR, DVD player, TV, and this receiver using the S-video cables, composite video cables, or component video cables.

- See "Connections 2" on the previous page.

5 Plug the AC power cords of the connected components and this receiver into the AC outlets.

6 When turning on the TV for the first time after the AV COMPU LINK connection, turn the TV volume to the minimum using the TV volume control on the TV.

7 Turn on the connected components first, then turn on this receiver.

- When turning on the VCR, use the remote control supplied with this receiver (press VCR \odot /I).

The AV COMPU LINK remote control system allows you to use the five basic functions listed below.

Remote control of the TV, DVD player, and VCR using this remote control

See pages 47 to 51 for details.

- Aim the remote control directly at the remote sensor on each component.

One-touch video play

Simply by inserting a video cassette without its safety tab into the VCR, you can enjoy the video playback without setting other switches manually. The receiver automatically turns on and changes the source to "VCR."

The TV automatically turns on and changes the input mode to the appropriate position so that you can view the playback picture.

When you insert a video cassette with its safety tab, press the play (\blacktriangleright) button on the VCR or on the remote control. So, you can get the same result.

One-touch DVD play

Simply by starting playback on the DVD player, you can enjoy the DVD playback without setting other switches manually. The following is set automatically:

- Turning on the receiver.
- Changing the source to "DVR/DVD."

The TV automatically turns on and changes the input mode to the appropriate position so that you can view the playback picture.

Automatic selection of TV input mode

- When you select "TV" as the source to play on the receiver, the TV automatically changes the input mode to the TV tuner so that you can watch TV.
- When you select "DVR/DVD," "VCR," or "DBS" as the source to play on the receiver, the TV automatically changes the input mode to the appropriate position (either video input 1 or video input 2) so that you can view the playback picture.

NOTE

This function does not work when you connect this receiver and the TV with the AV COMPU LINK EX terminal using a component video cable. In this case, reconnect the TV referring to Case 1 or Case 2 on page 45.

Automatic power on/off

The TV, DVD player, and VCR turn on and off along with the receiver.

When you turn on the receiver;

- If the previously selected source is "TV" or "DBS," only the TV will turn on automatically.
- If the previously selected source is "DVR/DVD," the TV and DVD player will turn on automatically.
- If the previously selected source is "VCR," the TV and VCR will turn on automatically.

When you turn off the receiver, the TV, DVD player, and VCR will turn off.

NOTES

- When "VIDEO OUTPUT" is set to "HDMI" (see page 34), the AV COMPU LINK remote control system is restricted to turning the video component on and off.
- If you turn off the receiver while recording on the VCR, the VCR will not turn off, but continue recording.

Operating other JVC products

You can use the supplied remote control to operate not only this receiver but also other JVC products.

- Refer also to the manuals supplied with the other products.
 - Some JVC VCRs can accept two types of the control signals—remote codes “A” and “B.” This remote control can operate a VCR whose remote control code is set to “A.”
 - Some JVC DVD recorders can accept four types of the control signals. Select an appropriate code for your DVD recorder (see page 48).
- To operate other products, aim the remote control directly at the remote sensor on the target product.

■ TV

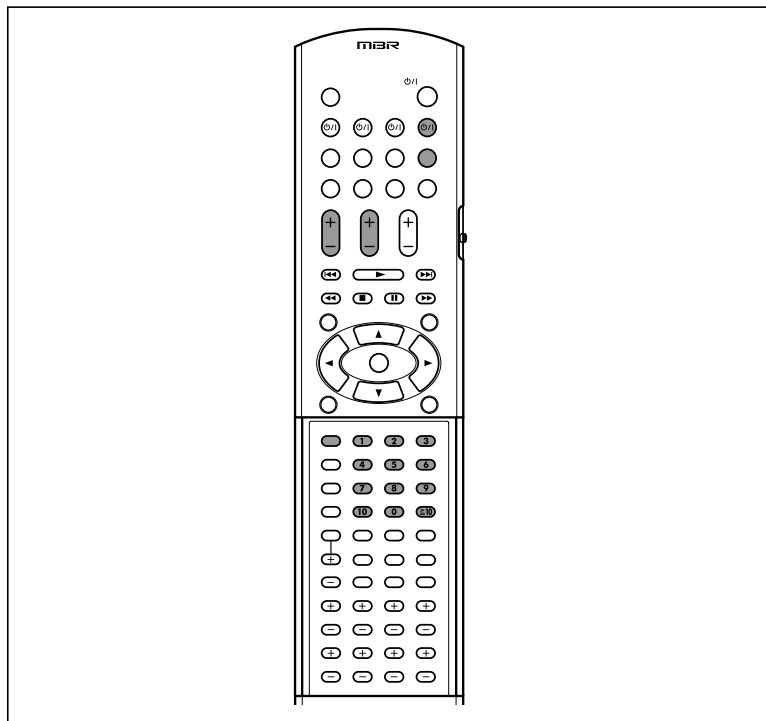

You can always perform the following operations:

TV VOL +/-:	Adjust the volume on the TV.
TV/VIDEO:	Change the input mode (either video input or TV tuner) on the TV.

After pressing TV, you can perform the following operations on the TV:

TV/SIRIUS ϕ/I:	Turn on or off the TV.
CHANNEL +/-:	Change the channel numbers.
1 – 9, 0, 100+ (≥ 10):	Select the channel numbers.
RETURN (10):	Switch between the previous channel and the current channel.

■ VCR

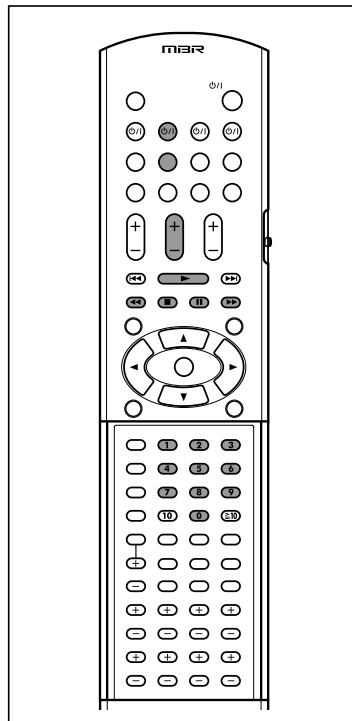

■ SIRIUS Satellite Radio

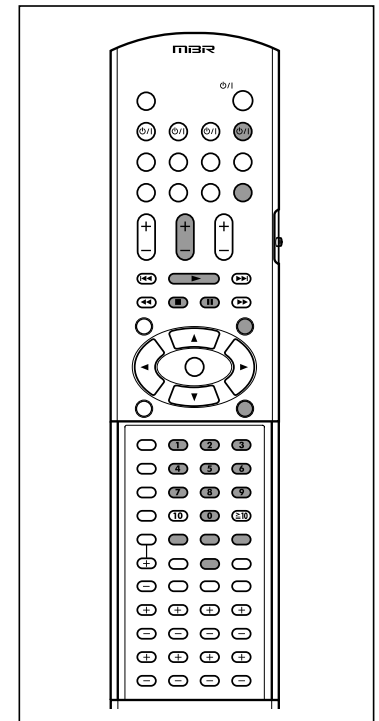

You can always perform the following operation:

VCR ϕ/I:	Turn on or off the VCR.
---------------------------------	-------------------------

After pressing VCR, you can perform the following operations on the VCR:

CHANNEL +/-:	Change the channel numbers on the VCR.
1 – 9, 0:	Select the channel numbers on the VCR.
▶:	Start playback.
■:	Stop playback.
 :	Pause playback. To release it, press ▶.
▶▶:	Fast-forward a tape.
◀◀:	Rewind a tape.

After pressing SIRIUS, you can perform the following operations on the SIRIUS Satellite Radio:

TV/SIRIUS ϕ/I:	Turn on or off the SIRIUS Satellite Radio.
CHANNEL +/-:	Change the channel numbers on the SIRIUS Satellite Radio.
SELECT:	Select a highlighted item on the display of the SIRIUS Satellite Radio.
CAT \oplus/\ominus CAT:	Change the category of the program.
MENU:	Enter and exit from the Menu Option screen of the SIRIUS Satellite Radio.
DISPLAY:	Change the text size on the display of the SIRIUS Satellite Radio.
1 – 9, 0, BAND:	Store or tune in to the preset channel.
MEMORY:	Store information on the display of the SIRIUS Satellite Radio.
DIRECT:	Enable access to channels of the SIRIUS Satellite Radio directly by numeric buttons.
PREV:	Return to the previous channel.

NOTE

The remote control may not operate a SIRIUS Satellite Radio properly if it is not KT-SR2000 (JVC SIRIUS Satellite Radio).

■ DVD recorder or DVD player

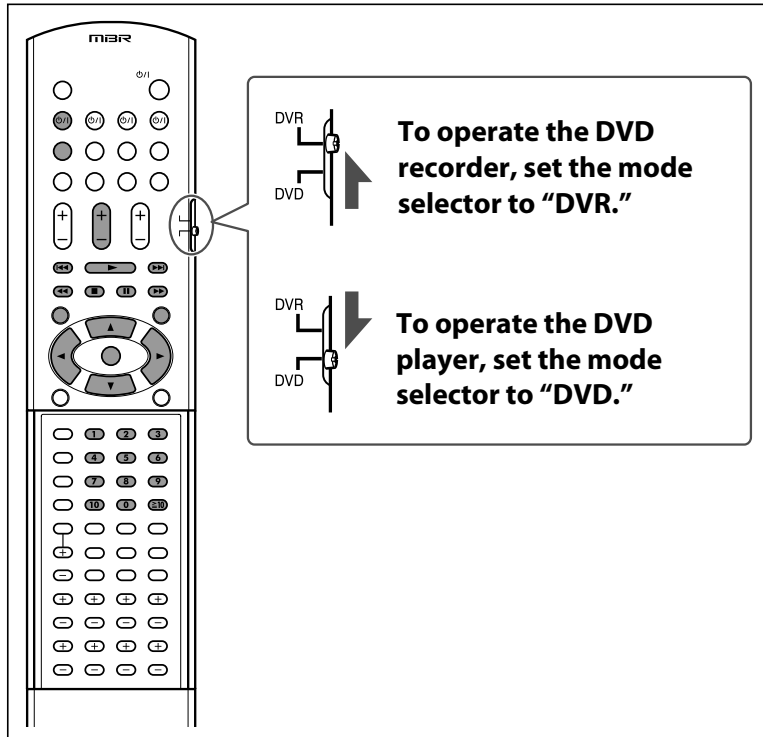

After setting the mode selector correctly, you can perform the following operations on the DVD recorder or DVD player. See the manual supplied with the DVD recorder or DVD player for details.

To change the remote control code for DVD recorder
Some JVC DVD recorders can accept four types of control signals. You can assign one of the four codes to the remote control supplied for this receiver to operate your DVD recorder. For details, refer to the manual supplied with the DVD recorder.

Initial setting: 3

- 1 Set the mode selector to "DVR."**
- 2 Press and hold DVR/DVD ϕ/I .**
 - Keep the button pressed until step **4** is finished.
- 3 Press DVR/DVD.**
- 4 Enter the remote control code you want using the numeric buttons (1 – 4, 0).**

EX.: To enter the code "2," press 0, then 2.

Code for DVR	Number to enter
1	01
2	02
3	03
4	04

- 5 Release DVR/DVD ϕ/I .**

Now, the remote control code has been changed.

You can always perform the following operation:

DVR/DVD ϕ/I : Turn on or off the DVD recorder or DVD player.

After pressing DVR/DVD, you can perform the following operations on the DVD recorder and DVD player.

▶: Start playback.

■: Stop playback.

||: Pause playback. To release it, press ▶.

▶▶: Skip to the beginning of the next chapter.

◀◀: Return to the beginning of the current (or previous) chapter.

▶▶▶: Fast-forward playback.

◀◀◀: Fast-reverse playback.

TOP MENU/MENU: Display the menu recorded on discs.

▲/▼/▶/◀: Select an item on the menu screen.

SET: Enter the selected item, channel number, chapter/title number, or track number (if required).

Only for DVD recorder operations:

CHANNEL +/-: Change the TV channel numbers on the DVD recorder.

1 – 9, 0: Select a TV channel number (while stopped) or a chapter/title number, track number (while playing back). Press SET to enter the number.

Only for DVD player operations:

1 – 10, 0, ≥ 10 : Select a chapter/title number, track number, menu item, etc.

If these buttons do not function normally, use the remote control supplied with your DVD recorder or DVD player. Refer also to the manual supplied with the DVD recorder or DVD player for details.

Operating other manufacturers' products

By changing the transmittable signals, you can use the supplied remote control to operate other manufacturers' products.

- Refer also to the manuals supplied with the other products.
- To operate those components with the remote control, first you need to set the manufacturer codes each for the TV, VCR, CATV converter, DBS tuner, and DVD player.
- After replacing the batteries of the remote control, set the manufacturer codes again.
- All the functions may not be assigned to the buttons for some equipment.

To change the transmittable signals for operating a TV

1 Press and hold TV/SIRIUS \odot /I.

- Keep the button pressed until step **3** is finished.

2 Press TV.

3 Enter the manufacturer code using the numeric buttons (1 – 9, 0).

See "Manufacturer codes for TV" on the right.

4 Release TV/SIRIUS \odot /I.

Now, you can perform the following operations on the TV:

TV VOL +/-:	Adjust the volume on the TV.
TV/VIDEO:	Change the input mode (either video input or TV tuner) on the TV.

After pressing TV, you can perform the following operations on the TV:

TV/SIRIUS \odot/I:	Turn on or off the TV.
CHANNEL +/-:	Change the channel numbers.
1 – 9, 0, 100+ (≥ 10):	Select the channel numbers.

See the manual supplied with the TV for details.

5 Try to operate your TV by pressing TV/SIRIUS \odot /I.

Your TV turns on or off when you have entered the correct code.

If more than one code is listed for your brand of TV, try each one until the correct one is entered.

Manufacturer codes for TV:

Manufacturer	Codes
JVC	01
Akai	02
Bell+Howell	03
Centurion	04
Coronad	05
Daewoo	06, 07, 08
Emerson	09, 10, 11, 12, 13
Fisher	14
GE•Pana	15, 16
GE•RCA	17
Gold Star	18, 19
Hitachi	20, 21
KTV	22, 23
Magnavox	24
Marantz	25
Mitsubishi	25
Panasonic	26, 27
Philips	24
Pioneer	28
Proscan	29
Quasar	30
Radioshack	31
RCA	02, 17, 32, 33, 34, 35
Samsung	36, 37, 45, 46, 47, 48
Sanyo	14
Sears	38
Sharp	39, 49, 50
Sony	40
Symphonic	41, 42
Toshiba	38
Zenith	43, 44

Initial setting: 01

Manufacturer codes are subject to change without notice. If they are changed, this remote control cannot operate the equipment.

To change the transmittable signals for operating a VCR

1 Press and hold VCR \odot/I .

- Keep the button pressed until step **3** is finished.

2 Press VCR.

3 Enter the manufacturer code using the numeric buttons (1 – 9, 0).

See "Manufacturer codes for VCR" on the right.

4 Release VCR \odot/I .

Now, you can perform the following operation on the VCR:

VCR \odot/I:	Turn on or off the VCR.
---	-------------------------

After pressing VCR, you can perform the following operations on the VCR:

CHANNEL +/-:	Change the TV channel numbers on the VCR.
---------------------	---

1 – 10, 0, ≥ 10:	Select the TV channel numbers on the VCR.
---	---

▶:	Start playback.
-----------	-----------------

■:	Stop playback.
-----------	----------------

 :	Pause playback. To release it, press ▶.
------------	---

▶▶:	Fast-forward a tape.
------------	----------------------

◀◀:	Rewind a tape.
------------	----------------

See the manual supplied with the VCR for details.

5 Try to operate your VCR by pressing VCR \odot/I .

Your VCR turns on or off when you have entered the correct code.

If more than one code is listed for your brand of VCR, try each one until the correct one is entered.

Manufacturer codes for VCR:

Manufacturer	Codes
JVC	01, 02, 03, 04
Aiwa	05
Akai	06, 07, 08
Bell+Howell	09
Daewoo	10
Emerson	11, 12, 13, 14, 15
Fisher	16, 17, 18, 19
G.E.	20, 21
Go Video	22
Gold Star	23
Go-Video A	24
Go-Video B	25
Hitachi	20, 26
Magnavox	27, 28, 29
Mitsubishi	30, 31, 32, 33
NEC	34, 35
Panasonic	36, 37
Philips	27
RCA	38
Samsung	39, 40, 41
Sanyo	16, 17, 18, 19
Scott	42
Sharp	43, 44
Shintom	45
Sony	46, 47, 48, 49, 50, 51
Symphonic	52
Teknica	53, 54
Toshiba	55
Zenith	56

Initial setting: 01

Manufacturer codes are subject to change without notice. If they are changed, this remote control cannot operate the equipment.

To change the transmittable signals for operating a CATV converter or DBS tuner

1 Press and hold DBS/CATV \odot /I.

- Keep the button pressed until step **3** is finished.

2 Press DBS.

3 Enter the manufacturer code using the numeric buttons (1 – 9, 0).

See “Manufacturer codes for CATV converter” or “Manufacturer codes for DBS tuner” below.

4 Release DBS/CATV \odot /I.

Now, you can perform the following operation on the CATV converter or DBS tuner:

DBS/CATV \odot/I:	Turn on or off the CATV converter or DBS tuner.
---------------------------------------	---

After pressing DBS, you can perform the following operations on the CATV converter or DBS tuner:

CHANNEL +/-:	Change the channel numbers on the CATV converter or DBS tuner.
---------------------	--

1 – 10, 0:	Select the channel numbers on the CATV converter or DBS tuner.
-------------------	--

See the manual supplied with the CATV converter or DBS tuner for details.

5 Try to operate your CATV converter or DBS tuner by pressing DBS/CATV \odot /I.

When your CATV converter or DBS tuner turns on or off, you have entered the correct code.

If more than one code is listed for your brand of CATV converter or DBS tuner, try each one until the correct one is entered.

Manufacturer codes for CATV converter:

Manufacturer	Codes
G.I.	01
Gemini	02
Hamlin	03, 04, 05, 06
Jerrold	07, 08, 09, 10, 11, 12, 13, 14, 15
Macom	16, 17, 18
Magnavox	19
Oak	20, 21, 22
Panasonic	23, 24
Philips	25, 26, 27, 28, 29, 30
Pioneer	31, 32
S. Atlanta	33, 34, 35
Samsung	36
Tocom	37
Zenith	38, 39

Manufacturer codes for DBS tuner:

Manufacturer	Codes
Echostar	40
G.I.	41
Hitachi	42
Hughes	43
Panasonic	44
Primestar	45
RCA	46
Sony	47
Toshiba	48

Initial setting: 01

To change the transmittable signals for operating a DVD player

1 Set the mode selector to “DVD.”

2 Press and hold DVR/DVD \odot /I.

- Keep the button pressed until step **4** is finished.

3 Press DVR/DVD.

4 Enter the manufacturer code using the numeric buttons (1 – 9, 0).

See “Manufacturer codes for DVD player” below.

5 Release DVR/DVD \odot /I.

Now, you can perform the following operations on the DVD player:

DVR/DVD \odot/I:	Turn on or off the DVD player.
▶:	Start playback.
▶▶:	Skip to the beginning of the next chapter (or fast-forward for some models).
◀◀:	Return to the beginning of the current chapter (or fast-reverse for some models).
■:	Stop playback.
 :	Pause playback. To release it, press ▶.
MENU:	Display the menu recorded on DVD VIDEO discs.
▲/▼/▶/◀:	Select an item on the menu screen.
SET:	Enter the selected item.
1 – 9, 0, \geq10:	Select the chapter number.

See the manual supplied with the DVD player for details.

6 Try to operate your DVD player by pressing DVR/DVD \odot /I.

Your DVD player turns on or off when you have entered the correct code.

Manufacturer codes for DVD player:

Manufacturer	Codes
JVC	01
Hitachi	02
Kenwood	03, 04
Magnavox	05
Marantz	06
Mitsubishi	07
Onkyo	08, 09
Panasonic	10
Philips	06
Pioneer	11
Proscan	12
RCA	12
Samsung	13
Sony	14
Toshiba	05
Yamaha	15
Zenith	05, 16

Initial setting: 01

NOTE

You cannot use this remote control to operate any manufacturers’ DVD recorders other than JVC’s.

Manufacturer codes are subject to change without notice. If they are changed, this remote control cannot operate the equipment.

Troubleshooting

Use this chart to help you solve daily operational problems. If there are any problems you cannot solve, contact your JVC service center.

For Precise Surround Setup and XM Satellite Radio operations, see the separated troubleshooting on pages 19 and 28.

	PROBLEM	POSSIBLE CAUSE	SOLUTION
Power	The power does not come on.	The power cord is not plugged in.	Plug the power cord into an AC outlet.
	The receiver turns off (enters standby mode).	Speakers are overloaded because of high volume.	1. Stop the playback source. 2. Turn on the receiver again, then turn the volume down.
		Speakers are overloaded because of a short circuit at the speaker terminals.	Check the speaker wiring. If the speaker wiring is not short-circuited, contact your dealer.
		The receiver is overloaded because of high voltage.	Consult your dealer after unplugging the power cord.
"OVER HEAT" flashes on the display, then the receiver turns off.	The receiver is overloaded because of high volume or long time usage.	Turn the volume down or turn off the receiver for a while and turn it on again. If the receiver turns off soon after doing solutions above, consult your dealer after unplugging the power cord.	
Sound and picture	No sound from speakers.	Speaker signal cables are not connected.	Check the speaker wiring, then reconnect if necessary (see page 8) after unplugging the power cord.
		Connections are incorrect.	Check the audio connections (see pages 9 to 15) after unplugging the power cord.
		An incorrect source is selected.	Select the correct source.
		Muting is activated.	Press MUTING to cancel the mute (see page 22).
		An incorrect input mode (analog or digital) is selected.	Select the correct input mode (analog or digital).
	Sound from one speaker only.	Speaker signal cables are not connected properly.	Check the speaker wiring and reconnect if necessary (see page 8) after unplugging the power cord.
	Sounds are intermittently distorted by the outside noise such as a lightning discharge.	When you use the digital coaxial connection, the sounds may be intermittently distorted by the outside noise such as a lightning discharge but the sound will be restored automatically.	This is not a malfunction.
	No picture on the TV screen.	Either the video input setting or video output setting is incorrect.	Select the correct settings (see page 21 or 34).
	HDMI signals do not come on.	A video or audio format incompatible with this receiver and/or TV is played.	Check the video or audio format of the signal to see if it is compatible with this receiver and/or TV.
		An HDCP-compatible TV is not connected.	Connect an HDCP-compatible TV.
The receiver failed to recognize HDMI-connected components.		Disconnect the HDMI cable and connect it again after unplugging the power cord.	
An HDMI cable longer than 5 m (15 ft) is used.		Use an HDMI cable shorter than 5 m (15 ft) to assure stable operation and picture quality.	

	PROBLEM	POSSIBLE CAUSE	SOLUTION
Remote control	The remote control does not operate as you intend.	The remote control is not ready for your intended operation.	Set the mode selector correctly, then press the corresponding source selecting button before operation.
	The remote control does not work.	There is an obstruction blocking the remote sensor on the receiver.	Remove the obstruction.
		Batteries are weak.	Replace batteries.
		The mode selector is set to the incorrect position.	Set the mode selector to the proper position.
FM/AM	Continuous hiss or buzzing during FM reception.	Incoming signal is too weak.	Connect an outdoor FM antenna (not supplied) after unplugging the power cord, or contact your dealer.
		The station is too far away.	Select another station.
		A wrong antenna is being used.	Check with your dealer to be sure you have the correct antenna.
		Antennas are not connected properly.	Check the connections.
	Occasional cracking noise during FM reception.	Ignition noise from automobiles.	Move the antenna farther from automobile traffic.

Specifications

Designs and specifications are subject to change without notice.

■ Amplifier

Output Power

At stereo operation:

Front channels: **110 W per channel, min. RMS, driven into 6 Ω at 20 Hz to 20 kHz with no more than 0.8% total harmonic distortion.**

At surround operation:

Front channels: 110 W per channel, min. RMS, driven into 6 Ω at 1 kHz with no more than 0.8% total harmonic distortion.

Center channel: 110 W, min. RMS, driven into 6 Ω at 1 kHz, with no more than 0.8% total harmonic distortion.

Surround channels: 110 W per channel, min. RMS, driven into 6 Ω at 1 kHz, with no more than 0.8% total harmonic distortion.

Surround back channels: 110 W per channel, min. RMS, driven into 6 Ω at 1 kHz, with no more than 0.8% total harmonic distortion.

Audio

Audio Input Sensitivity/Impedance:

DVR/DVD, VCR, DBS, TV: 300 mV/47 k Ω

Audio Input (DIGITAL IN)*:

Coaxial: DIGITAL IN 1(DVR/DVD): 0.5 V(p-p)/75 Ω

Optical: DIGITAL IN 2(DBS), 3(VCR): -21 dBm to -15 dBm (660 nm \pm 30 nm)

USB: USB

* Corresponding to Linear PCM, Dolby Digital, and DTS (with sampling frequency—32 kHz, 44.1 kHz, 48 kHz).

Audio Output Level:

DVR, VCR: 300 mV

Signal-to-Noise Ratio ('66 IHF/'78 IHF): 80 dB/70 dB

Frequency Response (6 Ω): 20 Hz to 20 kHz (\pm 1 dB)

Bass Boost: +4 dB \pm 1 dB at 100 Hz

Equalization (at DSP operation):

Center frequency: 63 Hz, 250 Hz, 1 kHz, 4 kHz, 16 kHz

Control range: \pm 8 dB

Video

Video Input Sensitivity/Impedance:

Composite video: DVR/DVD, VCR, DBS: 1 V(p-p)/75 Ω

S-video: DVR/DVD, VCR, DBS:

Y (luminance): 1 V(p-p)/75 Ω

C (chrominance, burst): 0.286 V(p-p)/75 Ω

Component: DVR/DVD, VCR (DBS):

Y (luminance): 1 V(p-p)/75 Ω

PB, PR: 0.7 V(p-p)/75 Ω

Video Output Level/Impedance:

Composite video: DVR, VCR, MONITOR OUT: 1 V(p-p)/75 Ω

S-video: DVR, VCR, MONITOR OUT:

Y (luminance): 1 V(p-p)/75 Ω

C (chrominance, burst): 0.286 V(p-p)/75 Ω

Component: MONITOR OUT:

Y (luminance): 1 V(p-p)/75 Ω

PB, PR: 0.7 V(p-p)/75 Ω

Synchronization: Negative

■ HDMI

HDMI Input (Ver. 1.1): VCR(DBS), DVR/DVD
HDMI Output (Ver. 1.0): MONITOR OUT

■ FM tuner (IHF)

Tuning Range: 87.5 MHz to 108.0 MHz
Usable Sensitivity:
 Monaural: 12.8 dBf (1.2 μ V/75 Ω)
50 dB Quieting Sensitivity:
 Monaural: 16.0 dBf (1.7 μ V/75 Ω)
 Stereo: 37.5 dBf (20.5 μ V/75 Ω)
Stereo Separation at OUT (REC): 35 dB at 1 kHz

■ AM tuner

Tuning Range: 530 kHz to 1 710 kHz

■ General

Power Requirements: AC 120 V \sim , 60 Hz
Power Consumption: 160 W/245 VA (at operation)
1.1 W (in standby mode)
Dimensions (W x H x D): 435 mm x 91.5 mm x 371 mm
(17 ³/₁₆ inches x 3 ⁵/₈ inches x 14 ⁵/₈ inches)
Mass: 6.9 kg (15.3 lbs)

TO OUR VALUED CUSTOMER ———

THANK YOU FOR PURCHASING THIS JVC PRODUCT.
WE WANT TO HELP YOU ACHIEVE A PERFECT EXPERIENCE.

**NEED HELP ON HOW TO HOOK UP?
NEED ASSISTANCE ON HOW TO OPERATE?
NEED TO LOCATE A JVC SERVICE CENTER?
LIKE TO PURCHASE ACCESSORIES?**

JVC[®] IS HERE TO HELP!
TOLL FREE: 1(800)252-5722
<http://www.jvc.com>

Remember to retain your Bill of Sale for Warranty Service.

————— **Do not attempt to service the product yourself** —————

Caution

To prevent electrical shock, do not open the cabinet.
There are no user serviceable parts inside.
Please refer to qualified service personnel for repairs.



LIMITED WARRANTY

AUDIO-2 **USA ONLY**

ONLY FOR PRODUCT PURCHASED IN U.S.A.

JVC COMPANY OF AMERICA (JVC) warrants this product and all parts thereof, except as set forth below ONLY TO THE ORIGINAL RETAIL PURCHASER to be FREE FROM DEFECTIVE MATERIALS AND WORKMANSHIP from the date of original purchase for the period shown below. ("The Warranty Period")

PARTS	2 YRS	LABOR	2 YRS
-------	--------------	-------	--------------

THIS LIMITED WARRANTY IS VALID ONLY IN THE FIFTY (50) UNITED STATES, THE DISTRICT OF COLUMBIA AND IN THE COMMONWEALTH OF PUERTO RICO.

WHAT WE WILL DO:

If this product is found to be defective within the warranty period, JVC will repair or replace defective parts with new or rebuilt equivalents at no charge to the original owner. Such repair and replacement services shall be rendered by JVC during normal business hours at JVC authorized service centers. Parts used for replacement are warranted only for the remainder of the Warranty Period. All products may be brought to a JVC authorized service center on a carry-in basis. Color televisions with a screen size of 27" or greater qualify for in-home service. In such cases, a technician will come to your home and either repair the TV there or remove and return it if it cannot be repaired in your home.

WHAT YOU MUST DO FOR WARRANTY SERVICE:

Please do not return your product to the retailer

Instead, return your product to the JVC authorized service center nearest you. If shipping the product to the service center, please be sure to package it carefully, preferably in the original packaging, and include a brief description of the problem(s). Please call 1-800-252-5722 to locate the nearest JVC authorized service center. Service locations can also be obtained from our website <http://www.jvc.com>. If your product qualifies for in-home service, the service representative will require clear access to the product.

If you have any questions concerning your JVC Product, please contact our Customer Relations Department at 800-252-5722

WHAT IS NOT COVERED:

This limited warranty provided by JVC does not cover:

1. Products which have been subject to abuse, accident, alteration, modification, tampering, negligence, misuse, faulty installation, lack of reasonable care, or if repaired or serviced by anyone other than a service facility authorized by JVC to render such service, or if affixed to any attachment not provided with the products, or if the model or serial number has been altered, tampered with, defaced or removed;
2. Initial installation, installation and removal from cabinets or mounting systems.
3. Operational adjustments covered in the Owner's Manual, normal maintenance, video and audio head cleaning;
4. Damage that occurs in shipment, due to act of God, and cosmetic damage;
5. Signal reception problems and failures due to line power surge;
6. Video Pick-up Tubes/CCD Image Sensors are covered for 90 days from the date of purchase;
7. Accessories;
8. Batteries (except that Rechargeable Batteries are covered for 90 days from the date of purchase);
9. Products used for commercial purposes, including, but not limited to rental.

There are no express warranties except as listed above.

THE DURATION OF ANY IMPLIED WARRANTIES, INCLUDING THE IMPLIED WARRANTY OF MERCHANTABILITY, IS LIMITED TO THE DURATION OF THE EXPRESS WARRANTY HEREIN.

JVC SHALL NOT BE LIABLE FOR ANY LOSS OF USE OF THE PRODUCT, INCONVIENCE, OR ANY OTHER DAMAGES, WHETHER DIRECT, INCIDENTAL OR CONSEQUENTIAL (INCLUDING, WITHOUT LIMITATION, DAMAGE TO TAPES, RECORDS OR DISCS) RESULTING FROM THE USE OF THIS PRODUCT, OR ARISING OUT OF ANY BREACH OF THIS WARRANTY. ALL EXPRESS AND IMPLIED WARRANTIES, INCLUDING THE WARRANTIES OF MERCHANTABILITY AND FITNESS FOR PARTICULAR PURPOSE, ARE LIMITED TO THE WARRANTY PERIOD SET FORTH ABOVE.

Some states do not allow the exclusion of incidental or consequential damages or limitations on how long an implied warranty lasts, so these limitations or exclusions may not apply to you. This warranty gives you specific legal rights and you may also have other rights which vary from state to state.

JVC COMPANY OF AMERICA
DIVISION OF JVC AMERICAS CORP.

1700 Valley Road
Wayne, NJ 07470

<http://www.jvc.com>

REFURBISHED PRODUCTS CARRY A SEPARATE WARRANTY, THIS WARRANTY DOES NOT APPLY. FOR DETAIL OF REFURBISHED PRODUCT WARRANTY, PLEASE REFER TO THE REFURBISHED PRODUCT WARRANTY INFORMATION PACKAGED WITH EACH REFURBISHED PRODUCT.

For customer use:

Enter below the Model No. and Serial No. which is located either on the rear, bottom or side of the cabinet. Retain this information for future reference.

Model No. : _____

Serial No. : _____

Purchase date : _____

Name of dealer : _____

JVC



Free Manuals Download Website

<http://myh66.com>

<http://usermanuals.us>

<http://www.somanuals.com>

<http://www.4manuals.cc>

<http://www.manual-lib.com>

<http://www.404manual.com>

<http://www.luxmanual.com>

<http://aubethermostatmanual.com>

Golf course search by state

<http://golfingnear.com>

Email search by domain

<http://emailbydomain.com>

Auto manuals search

<http://auto.somanuals.com>

TV manuals search

<http://tv.somanuals.com>