

# JVC

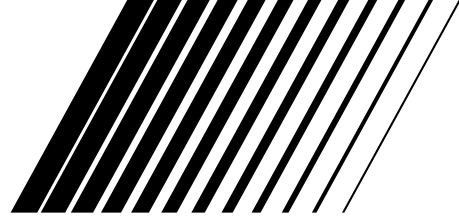

## COMPACT COMPONENT SYSTEM

# EX-A1

Consists of CA-EXA1 and SP-EXA1

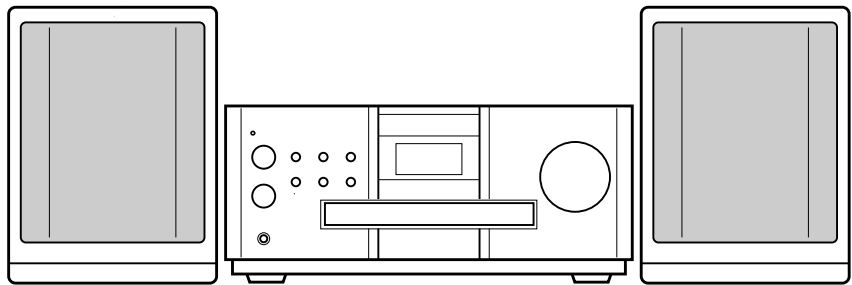
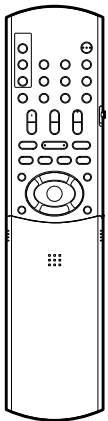

## INSTRUCTIONS

LVT1095-015A  
[UJ]

# Warnings, cautions and others

## CAUTION

To reduce the risk of electrical shocks, fire, etc.:

1. Do not remove screws, covers or cabinet.
2. Do not expose this appliance to rain or moisture.

## CAUTION – button!

Disconnect the mains plug to shut the power off completely (the STANDBY lamp goes off).

The  button in any position does not disconnect the mains line.

- When the system is on standby, the STANDBY lamp lights red.
- When the system is turned on, the STANDBY lamp goes off. The power can be remote controlled.

## CAUTION

- Do not block the ventilation openings or holes. (If the ventilation openings or holes are blocked by a newspaper or cloth, etc., the heat may not be able to get out.)
- Do not place any naked flame sources, such as lighted candles, on the apparatus.
- When discarding batteries, environmental problems must be considered and local rules or laws governing the disposal of these batteries must be followed strictly.
- Do not expose this apparatus to rain, moisture, dripping or splashing and that no objects filled with liquids, such as vases, shall be placed on the apparatus.

## IMPORTANT FOR LASER PRODUCTS

1. CLASS 1 LASER PRODUCT
2. **CAUTION:** Do not open the top cover. There are no user serviceable parts inside the unit; leave all servicing to qualified service personnel.
3. **CAUTION:** Visible and invisible laser radiation when open and interlock failed or defeated. Avoid direct exposure to beam.
4. REPRODUCTION OF LABEL: CAUTION LABEL, PLACED INSIDE THE UNIT.

|   |  |  |  |
|---|--|--|--|
| <b>CAUTION :</b> Visible and invisible laser radiation when open and interlock failed or defeated. AVOID DIRECT EXPOSURE TO BEAM. | <b>ADVARSEL :</b> Synlig og usynlig laserstråling når maskinen er åben eller interlocken fejler. Undgå direkte eksponering til stråling. (e) | <b>WARNING :</b> Synlig och osynlig laserstrålning när den öppnas och spärren är urkopplad. Betrakta ej strålen. (s) | <b>VARO :</b> Avattaessa ja suoja lukitus ohitettuna tai viallisena olet alttiina näkyvälle ja näkymättömälle lasersäteilylle. Vältä säteen kohdistumista suoraan itseesi. (f) |
|---|--|--|--|

**CAUTION – Proper Ventilation**

To avoid risk of electric shock and fire and to protect from damage, locate the apparatus as follows:

Top/Front/Back/Sides: No obstructions should be placed in the areas shown by the dimensions below.

Bottom: Place on the level surface. Maintain adequate air path for ventilation by placing on a stand with a height of 10 cm more.

In addition, maintain the best possible air circulation.

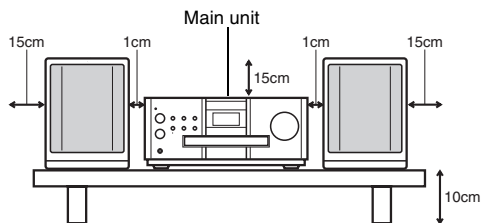
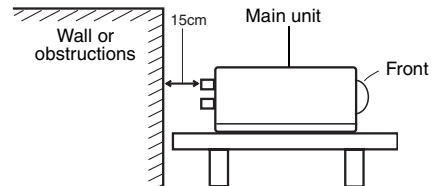
**Front view****Side view**

# Table of contents

## Introduction

|                                    |     |
|------------------------------------|-----|
| Warnings, cautions and others..... | G-1 |
| Special cautions .....             | 2   |
| About discs.....                   | 3   |
| Description of parts .....         | 6   |

## Getting started

|  |   |
|--|---|
| Using the remote control .....                   | 7 |
| Putting the batteries in the remote control..... | 7 |
| Operating the TV using the remote control.....   | 8 |
| Connecting up .....                              | 9 |

## Basic operations

|  |    |
|--|----|
| Playing discs .....  | 13 |
| Playback .....   | 13 |
| To switch the display .....  | 14 |
| Select what you want to play by using<br>the number buttons.....           | 15 |
| To stop playback.....  | 15 |
| To pause playback.....   | 15 |
| To advance picture frame-by-frame.....                                     | 15 |
| Fast reverse/Fast forward search .....                                     | 15 |
| Playing back from a position 10 seconds<br>before (One Touch Replay) ..... | 16 |
| Slow Motion Playback.....  | 16 |
| Skip to the beginning of the selection .....                               | 16 |
| To change the brightness of the<br>display window (DIMMER).....            | 17 |
| Adjusting the volume .....   | 17 |
| Adjusting sound quality.....   | 17 |
| Turning off the sound temporarily (MUTING) ...                             | 17 |

## Advanced operations

|  |    |
|--|----|
| Playing MP3 and JPEG discs.....                      | 17 |
| Resume Playback .....                                | 19 |
| Select the scene to be played .....                  | 20 |
| Program Playback/Random Playback.....                | 21 |
| Repeat Playback .....                                | 23 |
| Other convenient functions.....                      | 25 |
| Selecting the subtitles.....                         | 25 |
| Selecting the audio language .....                   | 25 |
| Selecting a view angle.....                          | 25 |
| Enlarging the picture (ZOOM).....                    | 26 |
| Adjusting the picture quality (VFP) .....            | 26 |
| Creating realistic sound<br>(VIRTUAL SURROUND) ..... | 27 |
| Adjusting playback level (DVD LEVEL) .....           | 27 |
| Enjoying better pictures (PROGRESSIVE).....          | 27 |

|   |    |
|---|----|
| Functions specific to DVD AUDIO.....    | 28 |
| Playing the Bonus Group.....            | 28 |
| Browsable Still Pictures (B.S.P.) ..... | 28 |
| Using the menu bar .....                | 29 |
| Preferences .....                       | 30 |
| Country/Area codes.....                 | 32 |

## Listening to radio

|                                      |    |
|--------------------------------------|----|
| Listening to a radio broadcast ..... | 33 |
| Tuning in to a preset station .....  | 34 |

## Convenient functions

|   |    |
|---|----|
| Listening to the sound of<br>other audio device ..... | 35 |
| Auto Standby.....                                     | 35 |
| Sleep Timer .....                                     | 36 |
| Tray Lock.....  | 36 |
| Using AV COMPU LINK .....                             | 37 |

## Reference

|                      |    |
|----------------------|----|
| Troubleshooting..... | 38 |
| Language codes.....  | 39 |
| Specifications ..... | 40 |

### How to read this manual

- Operations are described by mainly using the remote control buttons. If there are the same marks on the main unit, the buttons on the main unit can also be used.
- The following marks tell you for which type of the discs the operation can be made.



- The illustrations and TV screens may be different between the actual case and the description.
- "VCD" is an abbreviation of "Video CD".
- "SVCD" is an abbreviation of "Super Video CD".

## Notes on handling

### ■ Important cautions

#### Installation of the system

- Select a place which is level, dry and neither too hot nor too cold; between 5°C and 35°C.
- Leave sufficient distance between the system and the TV.
- Do not use the system in a place subject to vibration.

#### Power cord

- Do not handle the power cord with wet hands!
- A small amount of power is always consumed while the power cord is connected to the wall outlet.
- When unplugging the power cord from the wall outlet, always pull on the plug, not the power cord.

#### To prevent malfunctions of the system

- There are no user-serviceable parts inside. If anything goes wrong, unplug the power cord and consult your dealer.
- Do not insert any metallic object into the system.
- Do not use any non-standard shape disc (like a heart, flower or credit card, etc.) available on the market, because it may damage the system.
- Do not use a disc with tape, stickers, or paste on it, because it may damage the system.

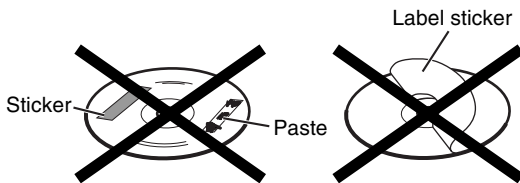

#### Note about copyright laws

Check the copyright laws in your country before recording from DVDs, Super Video CDs (SVCDs), VCDs and CDs. Recording of copyrighted material may infringe copyright laws.

#### Note about copy guard system

DVDs are protected by copy guard system. When you connect the system to your VCR directly, the copy guard system activates and the picture may not be played back correctly.

### ■ Safety precautions

#### Avoid moisture, water and dust

Do not place the system in moist or dusty places.

#### Avoid high temperatures

Do not expose the system to direct sunlight and do not place it near a heating device.

#### When you are away

When away on travel or for other reasons for an extended period of time, disconnect the power cord plug from the wall outlet.

#### Do not block the vents

Blocking the vents may damage the system.

#### Care of the cabinet

When cleaning the system, use a soft cloth and follow the relevant instructions on the use of chemically-coated cloths. Do not use benzene, thinner or other organic solvents including disinfectants. These may cause deformation or discoloring.

#### If water gets inside the system

Turn the system off and disconnect the power cord plug from the wall outlet, then call the store where you made your purchase. Using the system in this condition may cause fire or electrical shock.

#### ■ When condensation or water drops adhere to the lens

In any of the following cases, condensation or water drops may adhere to the lens to prevent the system from working properly:

- Immediately after roomheating starts
- When the system is installed in a steamy or damp space
- When the system is suddenly moved from a cold place to a warm space

In any of these cases, leave the system turned on for 1 or 2 hours before use.

## Supplied accessories

Check to be sure you have all of the supplied accessories.

The number in parentheses is the quantity of the pieces supplied. If anything is missing, contact your dealer immediately.

- Remote control (1)
- Batteries (2)
- FM antenna (1)
- AM loop antenna (1)
- Power cord (1)
- Composite video cord (1)
- Speaker cords (2)
- AC plug adaptor (1)

- *Manufactured under license from Dolby Laboratories. "Dolby", "MLP Lossless", and the double-D symbol are trademarks of Dolby Laboratories.*
- *"DTS" and "DTS 2.0+DIGITAL OUT" are registered trademarks of Digital Theater Systems, Inc.*
- *This product incorporates copyright protection technology that is protected by method claims of certain U.S. patents and other intellectual property rights owned by Macrovision Corporation and other rights owners. Use of this copyright protection technology must be authorized by Macrovision Corporation, and is intended for home and other limited viewing uses only unless otherwise authorized by Macrovision Corporation. Reverse engineering or disassembly is prohibited.*

# About discs

## Playable disc types

This system has been designed to play back the following discs:

DVD VIDEO, DVD AUDIO, VCD, SVCD, CD

This system can also play back the following discs:

- Finalized DVD-R/RW discs recorded in the DVD VIDEO format.
- CD-R/RW discs recorded in the following formats
  - Music CDs (finalized discs)
  - VCDs
  - SVCDs
  - MP3/JPEG discs recorded in ISO 9660 (for details, refer to "About MP3/JPEG discs")

However, some discs may not be played back because of their disc characteristics, recording conditions, or damage or stain on them.

Only sounds can be played back from the following discs:

MIX-MODE CD      CD-G  
CD-EXTRA          CD TEXT

### Discs you can play:

| Disc Type | Mark (Logo)   | Video Format | Region Code Number* |
|-----------|---|--------------|---------------------|
| DVD VIDEO |    | NTSC         | 1/ALL               |
| DVD AUDIO |    | —            | —                   |
| VCD       |   | NTSC         | —                   |
| SVCD      |  | NTSC         | —                   |
| CD        |  | —            | —                   |
| CD-R      |  | —            | —                   |
| CD-RW     |  | —            | —                   |

### \* Note on Region Code

DVD players and DVD VIDEOS have their own Region Code numbers. This system can only play back a DVD VIDEO recorded with the Region Code number and video format mentioned above.

#### Examples:



If a DVD VIDEO with an improper Region Code number is loaded, "REGION CODE ERROR!" appears on the TV screen and playback cannot start.

- On some DVD VIDEOS, DVD AUDIOS, VCDs or SVCDs, their actual operation may be different from what is explained in this manual. This is due to the disc programming and disc structure, not a malfunction of this system.

### Discs that cannot be played back

- The following discs cannot be played back: DVD-ROM, DVD-RAM, DVD-RW (recorded in VR format), CD-ROM, CD-I (CD-I Ready), Photo CD, SACD, etc.

Playing back these discs will generate noise and damage the speakers.

Damaged discs and discs in an extraordinary shape (other than a disc of 12 cm or 8 cm in diameter) cannot be played back.

### About MP3/JPEG discs

Playable MP3/JPEG discs and files

- Discs recorded in the ISO 9660 format are playable (except discs recorded in the "packet write" format (UDF format)).
- Discs recorded in the multi-session format are also playable.
- Files with an extension of ".mp3" ".jpg" or ".jpeg" (extensions with uppercase and lowercase letters mixed are also acceptable) are playable.

### Notes on MP3/JPEG discs and files

- A disc may not be played, or reading it may take a long time depending on its recording conditions or properties.
- The time needed for reading varies with the number of groups or tracks (files) recorded on the disc.
- If a character other than single byte English characters is used in the file name of an MP3/JPEG file, the track/file name will not be displayed correctly.
- The order of tracks/groups displayed on the MP3 Control screen, and the order of files/groups displayed on the JPEG Control screen may be different from that of files/folders displayed on PC's monitor screen.
- In the case of MP3 discs, since groups/tracks are played in alphabetical order, an off-the-shelf MP3 disc may be played in an order different from that indicated on the label attached to the disc.
- Playing an MP3 file including a still image may take a long time. The elapsed time is not displayed until playing starts. If playing starts, the elapsed time may not be displayed correctly.
- This system does not handle the ID3 tag of the MP3 file.
- For an MP3 file, a disc with a sampling frequency of 44.1 kHz and transmission rate of 128 kbps is recommended.
- This system can play a baseline JPEG file, excluding monochromatic JPEG files.
- This system can play JPEG data taken with a digital camera conforming to the DCF (Design Rule for Camera File System) standard (when a function is applied such as the automatic rotation function of a digital camera, data goes beyond the DCF standard, so the image may not be displayed).
- If data has been processed, edited and restored with PC image editing software, the data may not be displayed.
- This system cannot play animations such as MOTION JPEG, or still images (TIFF etc.) other than JPEG, and image data with sound.
- The resolution of 640 x 480 is recommended for JPEG files. If a file has been recorded at a resolution of more than 640 x 480, display may take a long time. An image with a horizontal resolution of more than 2,400 pixels cannot be displayed.

## Disc structure

### DVD VIDEO

A DVD VIDEO consists of “titles” and each title may be divided into “chapters”.

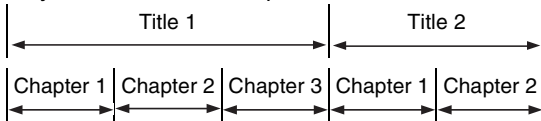

### DVD AUDIO

A DVD AUDIO consists of “groups” and each group may be divided into “tracks”.

Some discs include a “bonus group” that requires a password for playing (see page 28).

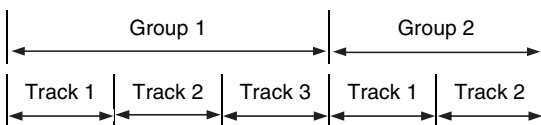

### VCD/SVCD/CD

VCD, SVCD and CD consist of “tracks”.

In general, each track has its own track number.

(On some discs, each track may also be further divided by indexes.)

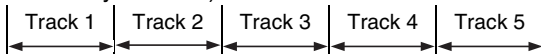

### MP3 [JPEG] discs

On an MP3 [JPEG] disc, each still picture (material) is recorded as a track [file]. Tracks [Files] are usually grouped into a folder. Folders can also include other folders, creating hierarchical folder layers.

This unit simplifies the hierarchical construction of a disc and manages folders by “groups”.

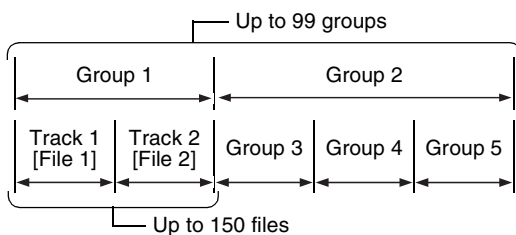

This unit can recognize up to 150 tracks [files] per group and up to 99 groups per disc (up to 14,850 files in total). Since the unit ignores the tracks [files] whose numbers are exceeding 150 and the groups whose numbers are exceeding 99, they cannot be played back.

- If there is any type of files other than MP3 [JPEG] files in a folder, those files are also counted in the total file number.

# Memo

---



The numbers represent the page numbers.

## Front panel

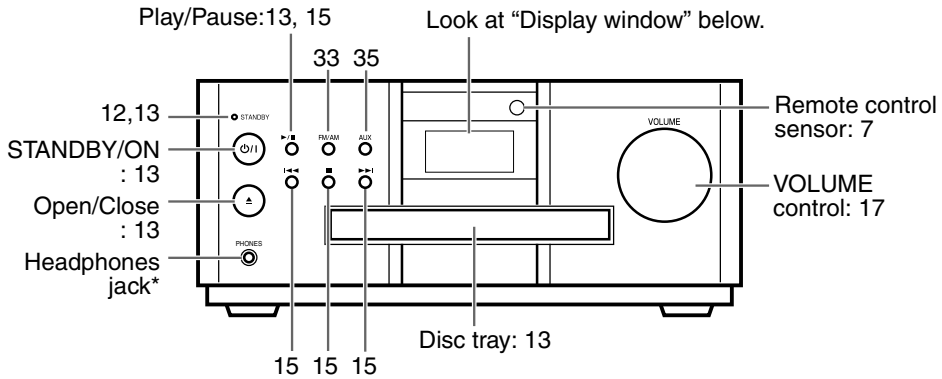

\* Connect a pair of headphones (commercially available) with a stereo mini plug. If the headphones are connected, the speakers and subwoofer will not produce any sound.

## Display window

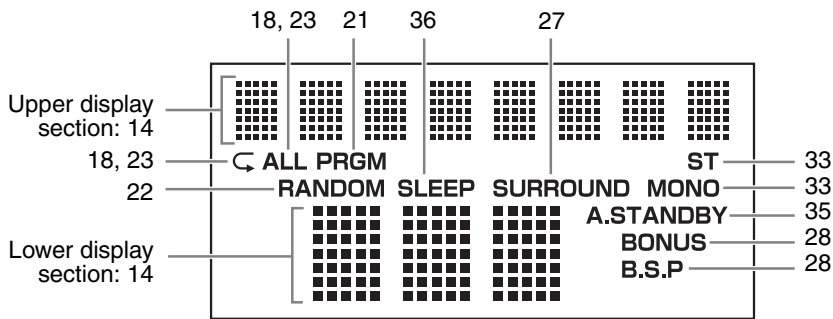

## Rear panel

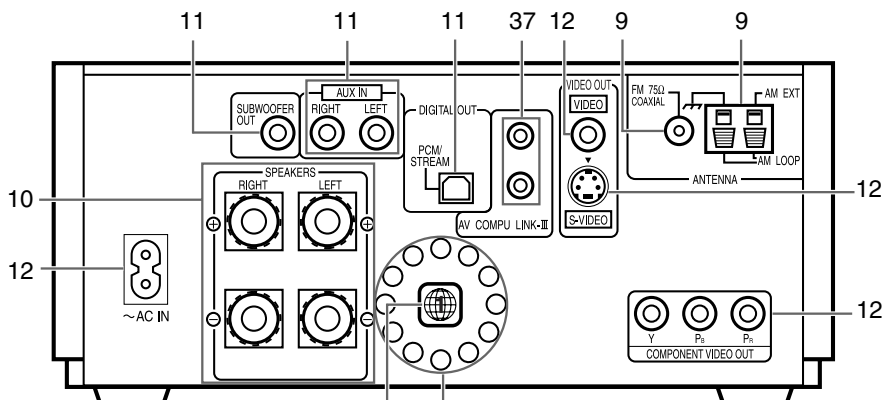

Region Code Number: 3

Cooling fan (inside)

The fan rotates and stops automatically.  
This discharges heat generated inside the unit.  
Do not cover up these holes.

# Using the remote control

The numbers represent the page numbers.

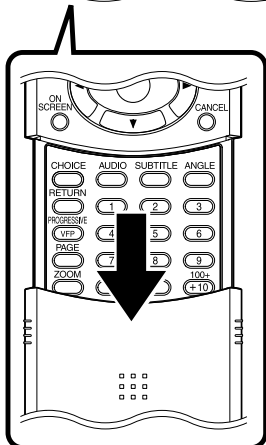
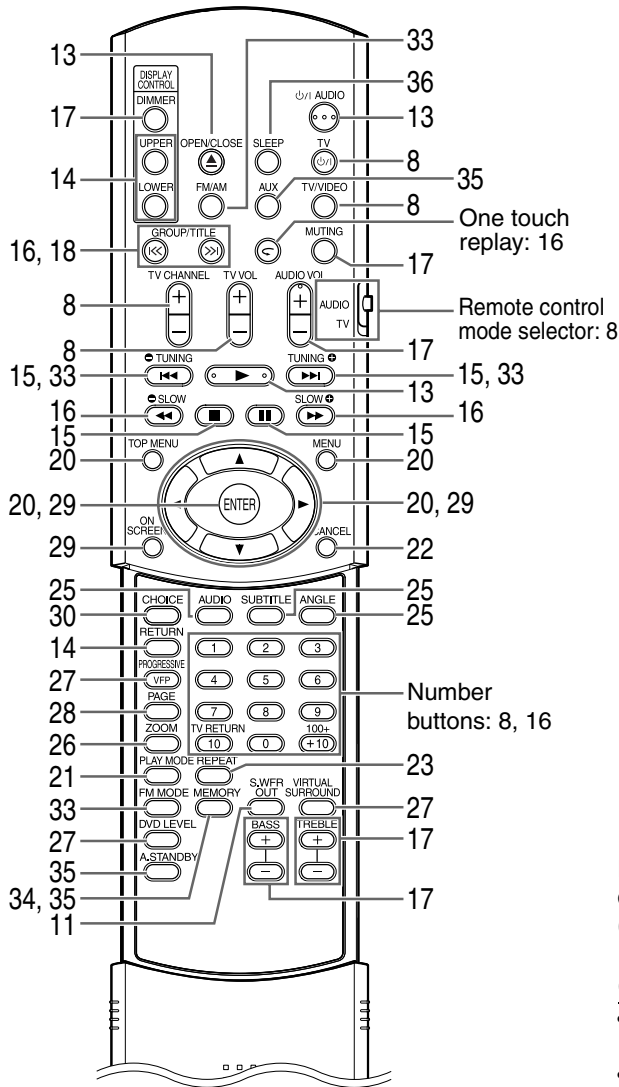

## Putting the batteries in the remote control

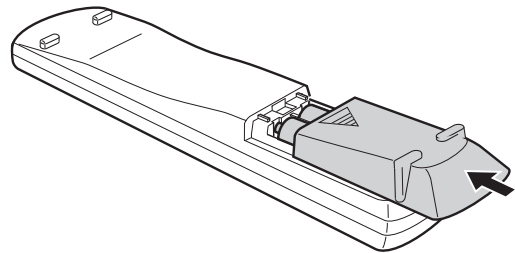
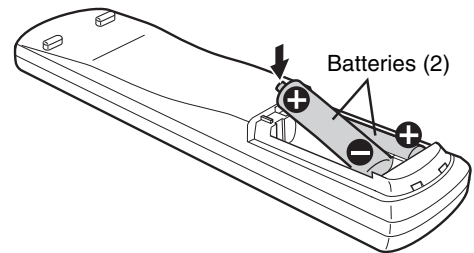
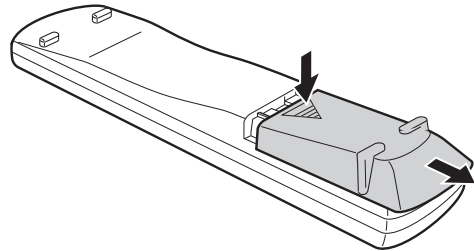

If the range or effectiveness of the remote control decreases, replace the batteries. Use two R6P (SUM-3)/AA(15F) type dry-cell batteries.

### CAUTION

- Do not use a used battery and a new battery together.
- Do not use different types of batteries at the same time.
- Take out the batteries if the remote control is not to be used for a long time. Otherwise it may cause a leakage.

### Remote control operation

When operating the remote control, point it towards the front panel of the main unit. If the remote control is operated from a direction that is extremely oblique or when there is an obstacle in the way, signals may not be transmitted.

If the remote control sensor is exposed to a strong light such as direct sunlight, correct operation may not be carried out.

This page is for when operating your TV using the remote control of this product.

## Operating the TV using the remote control

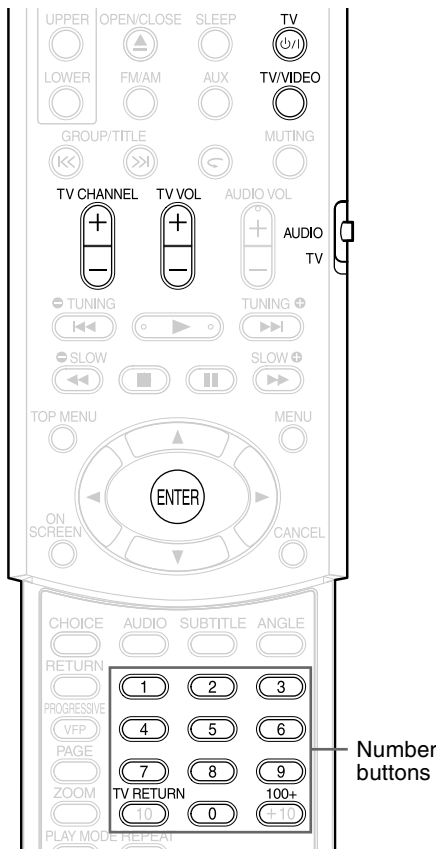

### Setting the manufacturer's code

- Slide the remote control mode selector to the TV side.



- Keep pressing down **TV**.

**NOTE**

Keep pressing down **TV** until Step 4 is complete.

- Press **ENTER** and release.

- Press number buttons (1-9, 0).

**Examples:**

For a Hitachi TV: Press 1, then 0.

For a Toshiba TV: Press 0, then 8.

If there are more than one manufacturer's codes, try them in turn and select the one that causes the product to work properly.

| Manufacturer | Code   | Manufacturer | Code |
|--------------|--------|--------------|------|
| JVC          | 01     | Samsung      | 12   |
| Hitachi      | 10     | Sanyo        | 13   |
| Magnavox     | 02     | Sharp        | 06   |
| Mitsubishi   | 03     | Sony         | 07   |
| Panasonic    | 04, 11 | Toshiba      | 08   |
| RCA          | 05     | Zenith       | 09   |

- Release **TV**.

### For TV operation

Operate the remote control by pointing it towards the TV.

|  |   |
|--|---|
|  | Turn ON/OFF the power.  |
|  | Change channels.  |
|  | Adjust volume.  |
|  | Select channels.<br><small>*1</small>                                       |
|  | Alternates between the previously selected channel and the current channel. |
|  | Switch TV and video input.  |

\*1 Make sure to slide the remote control mode selector to the TV side in advance.

**NOTE**

When the batteries are replaced, perform the manufacturer's code setting again.

## Connecting antennas

### Connecting AM loop antenna (supplied)

1 Set up the AM loop antenna.

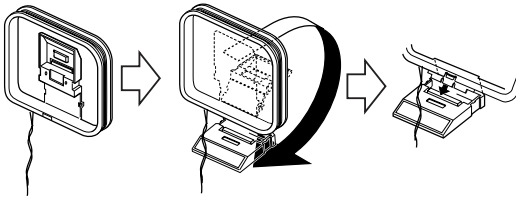

2 Connect antenna cords.

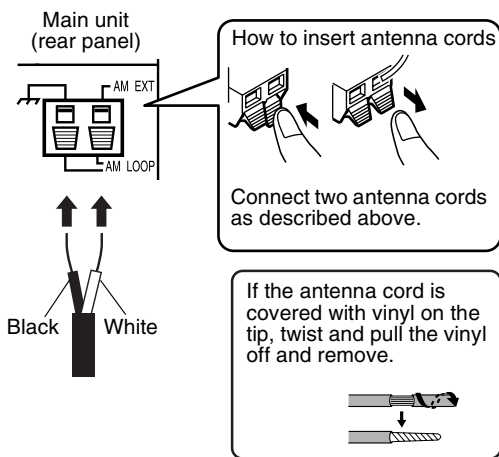

3 Turn the AM loop antenna to the direction of the best radio reception.

Locate the AM loop antenna as far away from the main unit as possible.

- Do not locate the AM loop antenna on a metallic table or close to a TV, personal computer, etc. Otherwise it may result in bad radio reception.

#### When good radio reception cannot be obtained with the supplied AM loop antenna

Electric wire: 3 - 5m (commercially available)

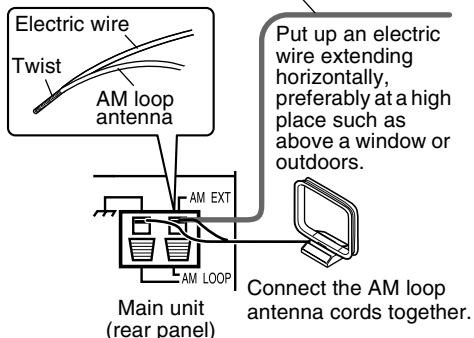

### Connecting FM antenna (supplied)

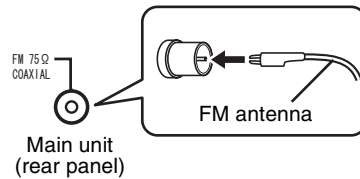

Put the antenna up straight in the direction where the best radio reception can be obtained, and fix by using tape.

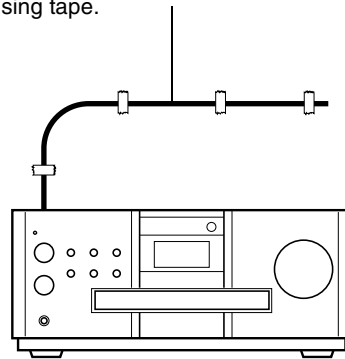

#### When good radio reception cannot be obtained with the supplied antenna or when using a communal antenna

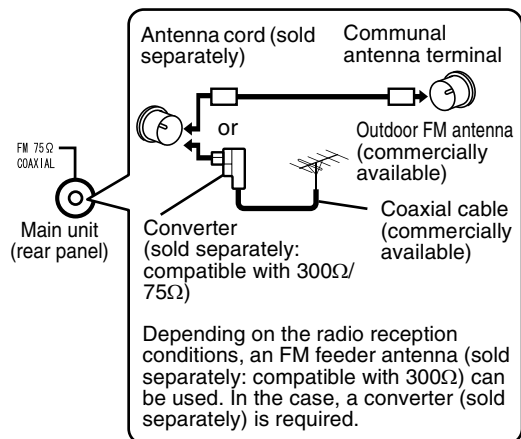

For details of connecting a separately sold antenna, refer to the user guide for the antenna or converter.

When positioning the antenna, listen to an actual radio program (refer to "Listening to a radio broadcast" on page 33).

## Connecting speakers

There is no difference between the left and right speakers.

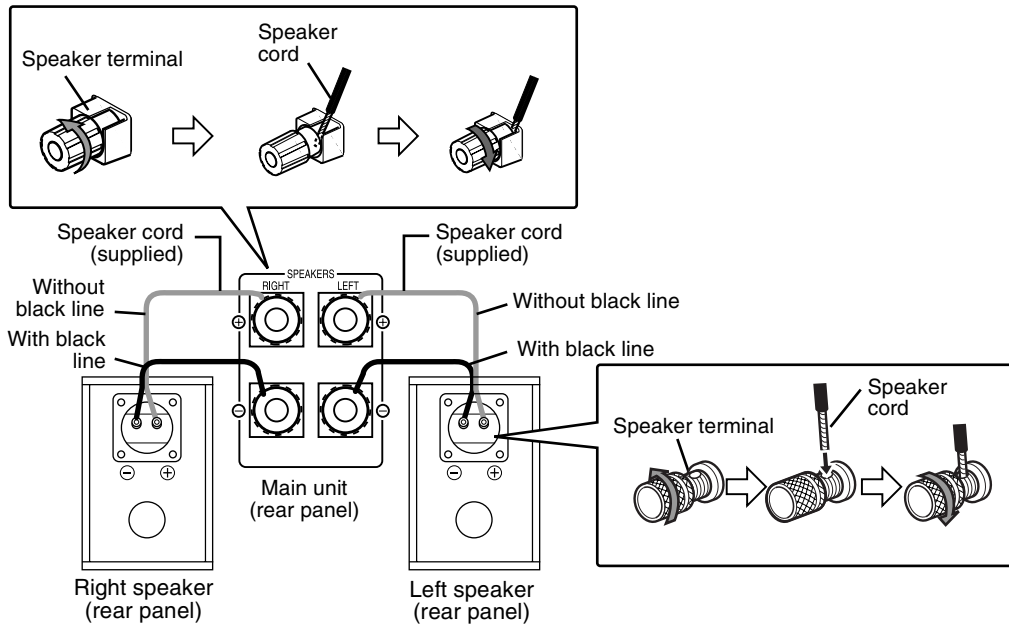

### CAUTION

- **DO NOT** connect more than one speaker to one speaker terminal.
- The speakers of this product are magnetically shielded, but color irregularities may occur on the TV depending on how the speakers are installed. Keep in mind the following.
  1. Turn off the main power of your TV before installing the speakers. Wait for about 30 minutes before turning on the TV again.
  2. If color irregularity occurs in pictures, keep a distance of more than 10 cm between the TV and the speakers.

The speakers employ natural wood for the diaphragm and the cabinet in order to reproduce the original sound faithfully. The appearance will therefore be different for each unit.

Speaker cover can be detached.

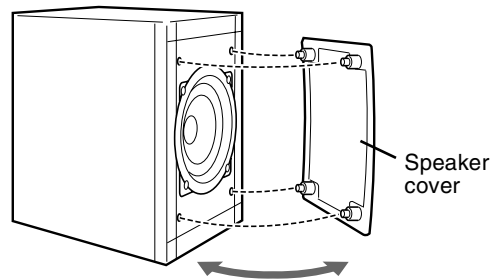

### NOTE

- Impedance of speaker that can be connected to the main unit is within a range of  $4\Omega$  to  $16\Omega$ .
- In order to have a sufficient cooling effect, leave a space of more than 1cm between the main unit and the speakers or other objects.

## Connecting other devices

This page is for when connecting the main unit with other devices.

### Connecting subwoofer

With an amplifier-built in subwoofer (sold separately), you can enjoy a more dynamic bass sound. Refer to the manual of the subwoofer for details.

Amplifier-built in subwoofer  
(sold separately)

Audio cord (sold separately)  
(If an audio cord comes with the amplifier-built in subwoofer,  
you can use the cord.)

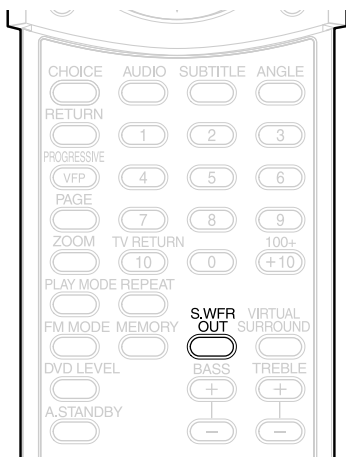
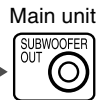
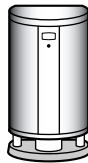

When you want to hear sound from the subwoofer, press **S.WFR OUT** on the remote control to display "SUB WFR ON" (Sub Woofer ON) on the display window on the main unit. Each time you press the button, the display toggles between "ON" and "OFF".

#### NOTE

When "SUB WFR ON" is selected, bass sound from the left and right speakers will be automatically lowered and the bass sound will be emitted mainly from the subwoofer.

### Connecting with a digital device

### Connecting with other audio device

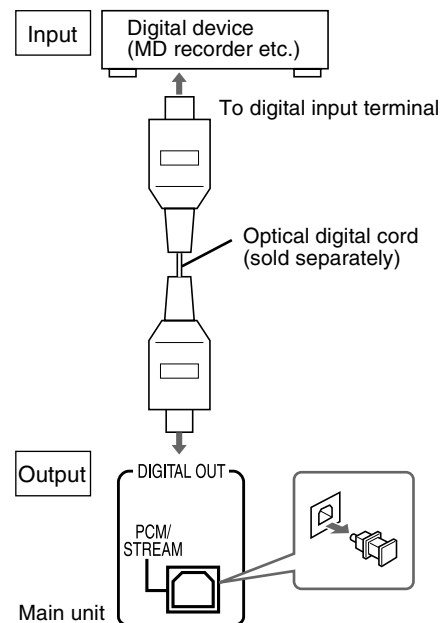
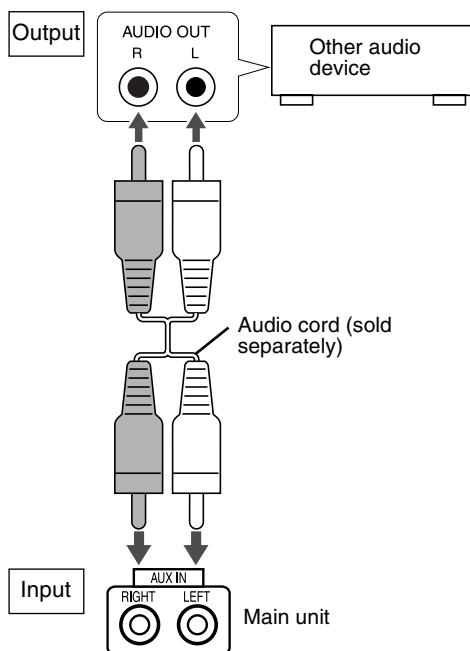

#### CAUTION

- For details of signals to be output, refer to page 31.
- If connecting the main unit with equipment with the function of a Dolby Digital decoder, the setting in "D. RANGE COMPRESSION" of "AUDIO" (page 31) will be invalid regarding sound from the digital audio output of the main unit.

## Connecting with TV

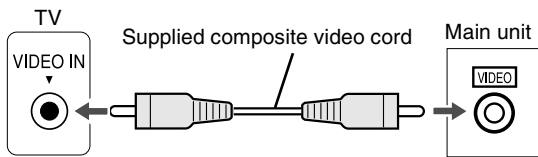

### CAUTION

Connect the main unit directly with a TV (or a monitor) without routing through a VCR. Otherwise it may cause picture distortion while playing.

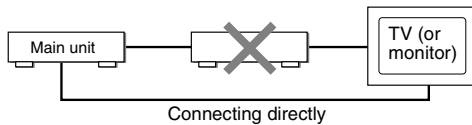

Also, when connecting the main unit to a TV with a VCR built in, there may be picture distortion while playing.

## When a clearer picture is desired

You can enjoy pictures of better quality using the following cord instead of the supplied video cord.

### Connecting by using the S-Video cord

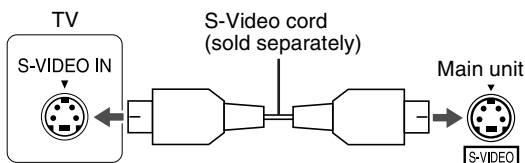

## Connecting by using the component video cord

You can enjoy better quality pictures than when using the S-Video cord.

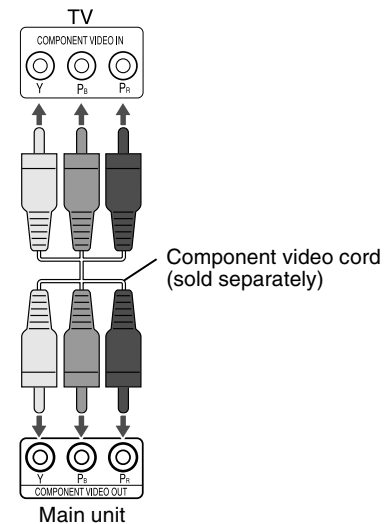

### CAUTION

Use one of either the S-Video cord or the component video cord. If both cords are used, pictures may not be played properly.

### NOTE

- In order to enjoy pictures with Progressive mode (page 27), the TV is required to have Progressive video input.
- If the component video input jacks of your TV are BNC type, use a plug adapter (not supplied) to convert the plugs.

## Connecting the power cord

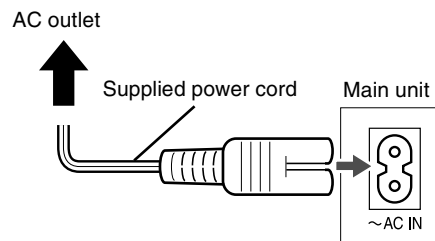

- Connect the power cord after all other connections are complete.
- The STANDBY lamp (on the front panel) will be lit.

# Playing discs

## Playback

**DVD VIDEO** **DVD AUDIO** **VCD** **SVCD** **C D** (Refer to page 17 for playing MP3 and JPEG.)

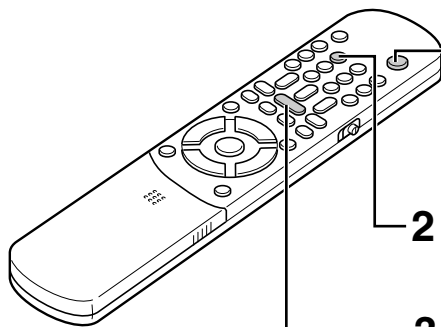
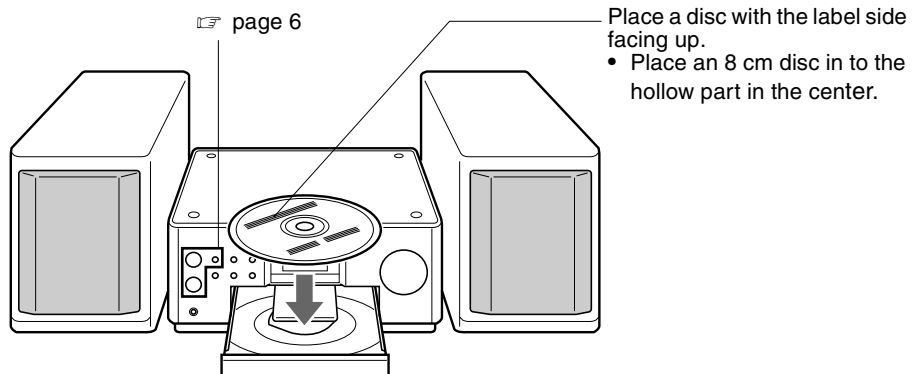

### 1 Press AUDIO.

- The power will be turned on and the STANDBY lamp will go off.
- Press AUDIO again to turn off the power.

### 2 Press OPEN/CLOSE to open the disc tray to load a disc.

### 3 Press (play).

The disc tray will close and playback will start.

- The power will be turned on when any of , , or on the main unit and , , or on the remote control is pressed while the power is off.

If any button other than or is pressed, the source will also be changed (if there is a disc loaded, playback will start).

### NOTE

- A menu screen may be displayed after starting playback of a DVD. In this case, select a desired item to playback by using the following buttons on the remote control.
  - Select a desired item using and press .
  - Select a desired item using the number buttons.
  - Depending on the disc, actual operation may be different from the description.



### Screens displayed on the TV when the power is turned ON.

The following messages appear depending on the status of the system. (When FM/AM or AUX is selected as a source, the messages do not appear.)

|                    |   |
|--------------------|---|
| NOW READING        | Appears when the system is reading the disc information. Wait for a while.                    |
| REGION CODE ERROR! | Appears when the Region Code of the DVD does not match the code the system supports. (page 3) |
| NO DISC            | Appears when no disc is loaded.   |
| OPEN               | Appears when opening the disc tray.   |
| CLOSE              | Appears when closing the disc tray.   |



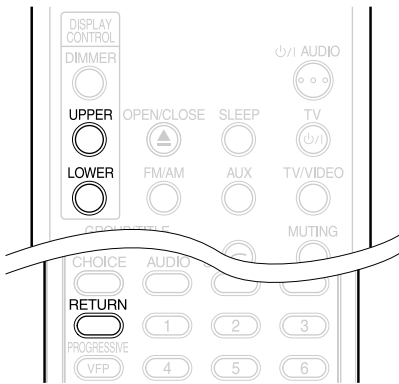

### Display window during disc playback

**Example:** When a DVD VIDEO or DVD AUDIO is played

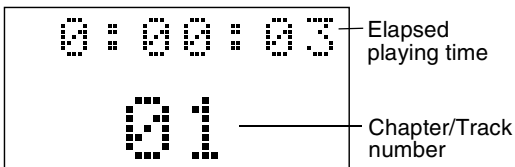

If "BONUS" or "B.S.P." is displayed during a DVD AUDIO playback, refer to page 28.

**Example:** When a SVCD or VCD is played

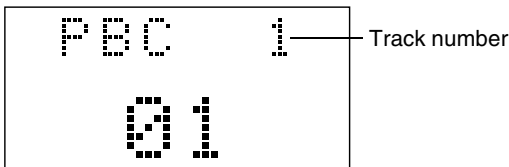

- PBC (Play Back Control): A signal recorded in a VCD (version 2.0) for controlling playback. It is possible to enjoy interactive software or software with a search function using a menu screen recorded in a PBC compatible VCD. To play a disc with the PBC function OFF, carry out the following operations.

- Designate the track number using the number buttons while the disc is stopped.
- Designate the track number using ◀◀ or ▶▶ while the disc is stopped, and then press ▶ (play).
- Press **RETURN** to go back to the upper layer during the PBC playback of a VCD or SVCD.

**Example:** When a CD is played

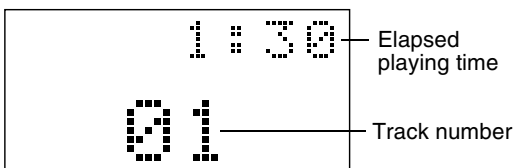

**Example:** When an MP3 disc is played

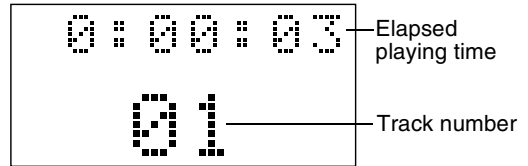

**Example:** When a JPEG disc is played

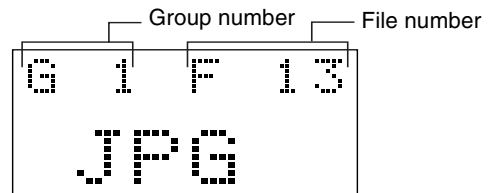

## To switch the display

Press **UPPER** or **LOWER**. Each time you press the button, the display will be alternated.

### Display examples

#### DVD VIDEO

UPPER: →0:00:03 (Elapsed playing time) → T1 C3 (Title and Chapter number)  
No display ←

LOWER: →03 (Chapter number) → T1 (Title number) → DVD

#### DVD AUDIO

UPPER: →0:00:03 (Elapsed playing time) → G1 T3 (Group and Track number)  
No display ←

LOWER: →03 (Track number) → G1 (Group number) → DVD

#### VCD/SVCD

UPPER: →0:03 (Elapsed playing time) → No display  
PBC 2 (PBC and Track number appear only when PBC function is played) ←

LOWER: →02 (Track number) → VCD

#### CD

UPPER: →0:03 (Elapsed playing time) → No display

LOWER: →02 (Track number) → CD

#### MP3 disc

UPPER: →0:00:03 (Elapsed playing time) → G1 T3 (Track number)  
No display ←

LOWER: →G1 (Group number) → MP3 → 03 (Track number)

#### JPEG disc

UPPER: →G1 F3 (Group number and File number) → No display

LOWER: JPG

### NOTE

#### Abbreviations

G: Group

T: Title (DVD VIDEO)

Track (DVD AUDIO and MP3)

C: Chapter

F: File

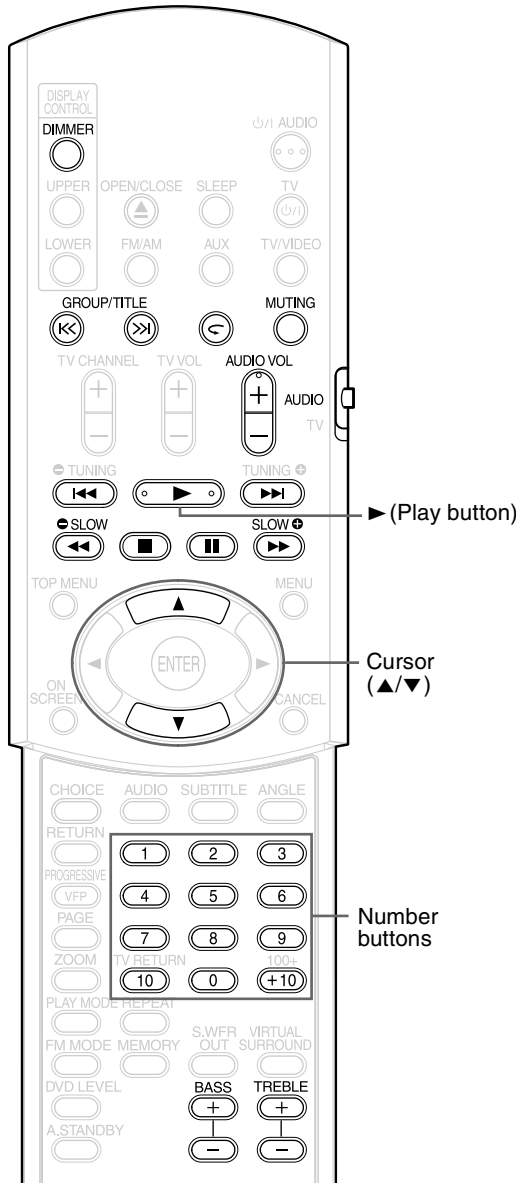

## Select what you want to play by using the number buttons

DVD VIDEO DVD AUDIO VCD SVCD CD MP3 JPEG

### NOTE

- Set the remote control mode selector to **AUDIO** before using the number buttons.
- For a VCD or SVCD, this operation can be carried out when the disc is stopped, or during playback without the PBC function.
- For a DVD AUDIO, CD, MP3 or JPEG, this operation can also be carried out when the disc is stopped.
- This operation may not be carried out for some discs.

## Designate the chapter number or track number to play during playback.

Refer to "How to use the number buttons" on page 16.

## To stop playback

DVD VIDEO DVD AUDIO VCD SVCD CD MP3 JPEG

Press **■** during playback.

## To pause playback

DVD VIDEO DVD AUDIO VCD SVCD CD MP3 JPEG

Press **⏸** during playback.

- To resume normal playback, press **▶** (play).
- Press **⏸** to pause during JPEG disc slide-show. Press **▶** (play) to start playback from the next file.
- It is not possible to pause by pressing **▶/⏸** on the main unit during JPEG disc slide-show.

## To advance picture frame-by-frame

DVD VIDEO SVCD VCD

Press **⏪** during pause.

Each time you press the button, picture will be advanced frame-by-frame.

## Fast reverse/Fast forward search

DVD VIDEO DVD AUDIO VCD SVCD CD

There are two methods.

- Press **⏪** or **⏩** during playback.

Each time you press the button, the speed increases (×2, ×5, ×10, ×20, ×60). To restore the normal speed, press **▶** (play).

- Hold down **⏪** or **⏩**.

Fast reverse/Fast forward search can be carried out only while the button is pressed (×2→×5).

### NOTE

- Fast reverse/Fast forward search cannot be carried out for MP3 and JPEG.
- For a DVD VIDEO, SVCD or VCD, no sound comes out during fast reverse/fast forward search.
- For a CD or DVD AUDIO, sound is intermittent during fast reverse/fast forward search.

## Playing back from a position 10 seconds before (One Touch Replay)



Press during playback.

### NOTE

- This operation may not be carried out for some discs.
- It is not possible to go back to the immediately previous title.

## Slow Motion Playback



Press **SLOW** or **SLOW** during pause.

- Each time you press the button, the speed increases.
- Press to pause playback, and press (play) to resume normal playback.

### NOTE

- No sound will be produced.
- The picture motion in the reverse direction may not be smooth.
- For a VCD or SVCD, Slow Motion Playback can be carried out in the forward direction only.

## Skip to the beginning of the selection



Press or during playback\*.

- Each time you press the button, the previous or next beginning of chapter/track/file to the current position will be skipped to.
- Press once to skip back to the beginning of the chapter or track currently being played (except for JPEG).
- Press **GROUP/TITLE** or to select the title or group.
- During playback of a JPEG disc, press or cursor to play the next file, or press or cursor to play the previous file.

### NOTE

- \* For a VCD or SVCD, this operation can be carried out during playback without the PBC function.
- Except for a DVD VIDEO, this operation can also be carried out while the disc is stopped.
- This operation may not be carried out for some discs.

## How to use the number buttons

Examples:

5:

15: →

20: →

25: → →



### Guide icons displayed on the TV screen (On-screen guide)



: Play



: Pause



: Fast reverse/Fast forward search



: Slow Motion Playback (reverse/forward directions)



: Containing multi-angle views  
( page 25)



: Containing multi-audio languages  
( page 25)



: Containing multi-subtitle languages  
( page 25)



: The disc cannot accept the operation you have attempted.

**To change the brightness of the display window (DIMMER)**

Press **DIMMER** repeatedly.

- The modified brightness will be stored even after the power is turned off.

The items below can be carried out for all sources.

**Adjusting the volume**

Press **AUDIO VOL +/-**.

**NOTE**

The volume can be adjusted by turning the **VOLUME** control on the main unit.

**Adjusting sound quality**

**Bass:** Press **BASS +/-**.

**Treble:** Press **TREBLE +/-**.

**Turning off the sound temporarily (MUTING)**

Press **MUTING**.

- No sound will come out from the speakers, headphones and the subwoofer.
- Press **MUTING** again to restore the sound. When the power is tuned off once and turned on again, the sound will be restored.

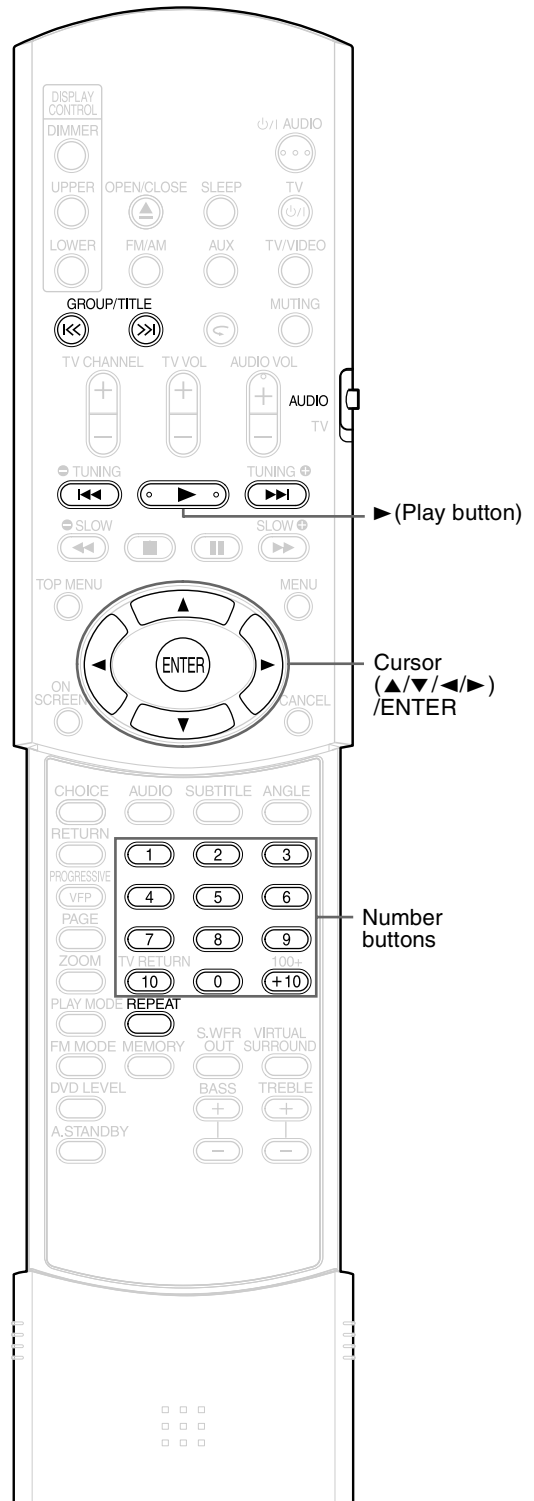

**NOTE**

Set the remote control mode selector to **AUDIO** before using the number buttons.



# Playback

**MP3** **JPEG**

Display of an MP3 disc is described here as an example.

For a JPEG disc, read “track” as “file”.

**NOTE**

When playing a disc containing both MP3 and JPEG files, set one of them to be played (☞ page 30).

## 1 Load a disc.

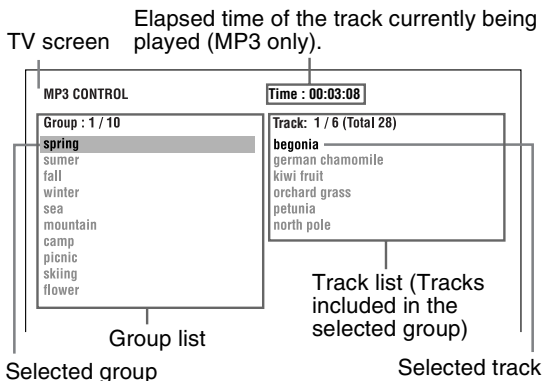

## 2 Press cursor ▲/▼ to select a group.

## 3 Press cursor ► to move to the track list.

- Press cursor ◀ to go back to the group list.

## 4 Press cursor ▲/▼ to select a track.

## 5 Press ►(play) or ENTER.

**NOTE**

- **GROUP/TITLE** ◀◀, ▶▶ can also be used in Step 2.
- The number buttons can also be used in Step 4. In this case, Steps 3 and 5 are not needed. (For how to use the number buttons, refer to page 16).
- ◀◀◀ or ▶▶▶ can also be used in Step 4. In this case, Step 3 is not needed.

# Repeat playback

**MP3** **JPEG**

## 1 Press REPEAT while the disc is stopped.

Each time you press the button, the Repeat type will be alternated.

| Repeat types  | Display on the TV screen | Display on the display window on the main unit |
|---|--------------------------|--|
| Repeats the current track (only for MP3).                                       | REPEAT TRACK             |  |
| Repeats the current group.  | REPEAT GROUP             |  |
| Repeats the entire disc.  | REPEAT ALL               |  |
| Cancels repeat.   | No display               | No display                                     |
| Repeats the current track during a Program or Random Playback (only for MP3).   | REPEAT STEP              |  |
| Repeats all programmed tracks or the all tracks for Random play (only for MP3). | REPEAT ALL               |  |

\* represents blinking.

## 2 Press ►(play).

**NOTE**

- The Repeat types can be changed during playback.
- The Repeat mode will be automatically cancelled if there is a file that cannot be played (☞ page 3).

### Slide-Show Playback **JPEG**

- In Step 5, for a JPEG disc, when ►(play) is pressed, files will be continuously played from the selected file (Slide-Show Playback), and when **ENTER** is pressed, only a selected file will be played.
- Display time for a file in Slide-Show Playback is about 3 seconds.
- When all files are played through, the playback will be automatically stopped.

# Resume Playback

DVD VIDEO DVD AUDIO VCD SVCD

When playback is stopped in the middle, playback can be started from the stopped scene. This is called Resume function.

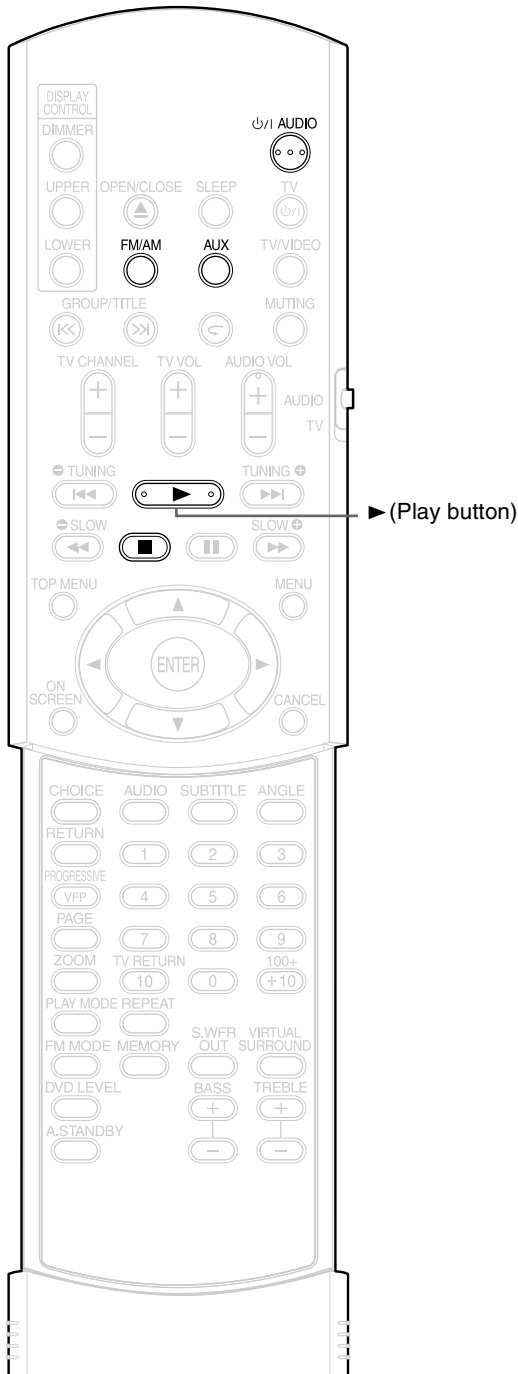

## How to suspend playback

Perform any of the following operations during playback.

Press ■ once.\*

Press ⏻/AUDIO to turn off the power.

Change the source to FM/AM or AUX.\*

\* Even if the power is turned off by pressing ⏻/AUDIO after this, the position where playback has been stopped will be stored.



## To start playback from the stored position

Press ▶ (play).

### NOTE

- This function does not work in Program Playback or Random Playback.
- The position where playback starts again may be a little different from the stopped position.
- When a disc menu is displayed, the Resume function may not work.
- The audio language, the subtitle language and the angle at that time are stored as well as the stopped position.
- The stored position will be cleared if the disc tray is opened. Further, if ■ is pressed during playback, "RESUME" will be displayed. If ■ is pressed at this time, "RESUME OFF" will be displayed and the stored information will be cleared.
- At the time of purchase, Resume is set to ON. Resume can be set to OFF (☞ page 31).

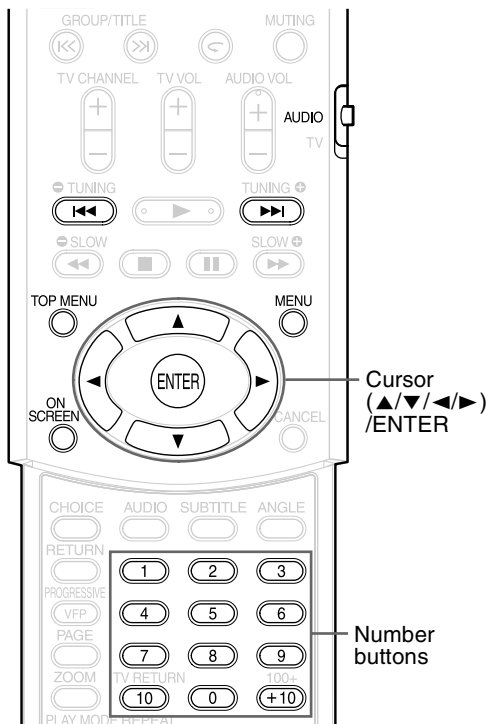

### NOTE

Set the remote control mode selector to **AUDIO** before using the number buttons.



## Select from the menu

DVD VIDEO DVD AUDIO VCD SVCD

- 1 Press **MENU** or **TOP MENU** while the disc is stopped or during playback\*<sup>1</sup>.

The disc menu screen will be displayed.

- 2 Press cursor **▲/▼/◀/▶** (only for a DVD VIDEO or DVD AUDIO) or the number buttons to select the scene to be played.

- Refer to "How to use the number buttons" (page 16).
- When the menu screen has a couple of pages, press **◀◀** or **▶▶** to change the page (only for a VCD and SVCD).

- 3 Press **ENTER**.

### NOTE

\*<sup>1</sup> For a VCD and SVCD, this operation can be carried out only when the PBC function is off.

- This operation cannot be carried out for a disc

without a menu screen.

- Playback may start for some discs without pressing **ENTER**.

## Designate the time (Time search)

DVD VIDEO DVD AUDIO VCD CD

- 1 Press **ON SCREEN** twice during playback\*<sup>2</sup>.

The menu bar will be displayed (page 29).

- 2 Press cursor **◀/▶** to select **⏪**.

- 3 Press **ENTER**.

- 4 Input the time\*<sup>3</sup> using the number buttons (1-9, 0).

- Input "hours", "minutes" and "seconds" for a DVD VIDEO and DVD AUDIO, and input "minutes" and "seconds" for a CD and VCD. "minutes" and "seconds" can be omitted.

**Example:** When you want to play a DVD VIDEO from the position of (0 hour) 23 minutes 45 seconds, press the buttons in the order:

0 → 2 → 3 → 4 → 5

- If you input wrong numbers, press cursor **◀** to delete the numbers and re-input.

- 5 Press **ENTER**.

To delete the menu bar, press **ON SCREEN**.

### NOTE

- This function does not work for a DVD VIDEO with no time information recorded.
- This function does not work during Program or Random Playback.

\*<sup>2</sup> For a CD, this operation can always be carried out, while, for a VCD, the operation can be carried out when the disc is stopped or during playback without the PBC function.

\*<sup>3</sup> Time search for a DVD VIDEO is from the beginning of the title, for a DVD AUDIO from the beginning of the track being played. Time search for a VCD and a CD is as follows:

- When the disc is stopped, time search is from the beginning of the disc.
- When the disc is being played, time search is within the track currently being played.

# Program Playback/Random Playback

DVD VIDEO DVD AUDIO VCD SVCD CD MP3

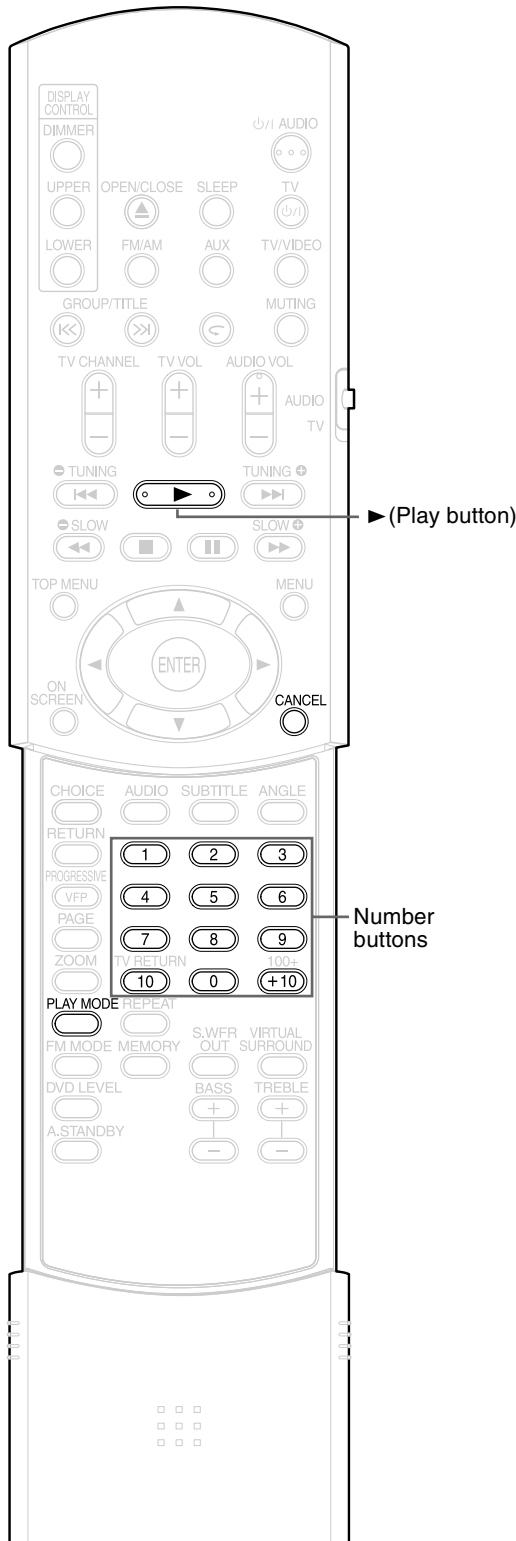

## Play the disc in the desired order (Program Playback)

It is possible to program a maximum of 99 chapters or tracks. The same chapter or track can be programmed more than once.

### 1 While the disc is stopped, press PLAY MODE repeatedly to display "PRGM" on the display window on the main unit.

"PRGM" is an abbreviation for PROGRAM.

**Example:** For DVD VIDEO

PROGRAM TV screen

| No | Group/Title | Track/Chapter |
|----|-------------|---------------|
| 1  |             |               |
| 2  |             |               |
| 3  |             |               |
| 4  |             |               |
| 5  |             |               |
| 6  |             |               |
| 7  |             |               |
| 8  |             |               |

Program screen

### 2 Create a program following the description on the TV screen.

Refer to "How to use the number buttons" (page 16).

- The input content varies depending on the disc type.
  - DVD VIDEO: Titles and chapters
  - VCD, SVCD, CD: Tracks
  - DVD AUDIO, MP3: Groups and tracks
- To select a DVD AUDIO bonus group, carry out the operations of "Playing the Bonus Group" on page 28 in advance to erase the display "BONUS".
- If the number of chapters or tracks input is greater than 99, "FULL" will be displayed.
- In the case of a CD, SVCD or VCD, when the total playback time reaches 99 minutes 59 seconds, "--:--" will be displayed on the display window (It is possible to continue programming).

#### NOTE

Set the remote control mode selector to **AUDIO** before using the number buttons.





To program on the display window on the main unit, operate as follows.

- (1) Select a title/group using the number buttons.  
Display example of the upper display window: T2 C--
- (2) Designate a chapter/track number using the number buttons.  
Display example of the upper display window: T2 C3
  - Refer to “How to use the number buttons” (☞ page 16).
  - The program number will be displayed on the lower display window (Example: “P2”).
- (3) Repeat the above operations (1) and (2) to complete the program. Then, advance to Step 3.

### 3 Press ►(play).

- To resume normal playback, press **PLAY MODE** repeatedly to display “NORMAL” on the display window on the main unit while the disc is stopped. The program content will not be erased.
- The following operations erase the program content.
  - Hold down **CANCEL** until “CLEAR!” appears on the display window with the program preference screen displayed (if **CANCEL** is pressed and released quickly, programs will be erased one by one).
  - Open the disc tray
  - Turn off the power

## Playing the disc in a random order (Random Playback)

### 1 Press **PLAY MODE** repeatedly to display “RANDOM” on the display window on the main unit while the disc is stopped.

- “RANDOM” will also be displayed on the TV screen.

### 2 Press ►(play).

- The same chapter or track will not be played twice.
- To resume normal playback, press **PLAY MODE** repeatedly to display “NORMAL” on the display window on the main unit while the disc is stopped.
- Random Playback will also be cancelled by carrying out the following operations.
  - Open the disc tray
  - Turn off the power
- The previous track will not be returned to even if ◀◀ is pressed repeatedly during Random Playback (the beginning of the current chapter or track will be returned to).

# Repeat Playback

Refer to page 18 for Repeat Playback of MP3 and JPEG files.

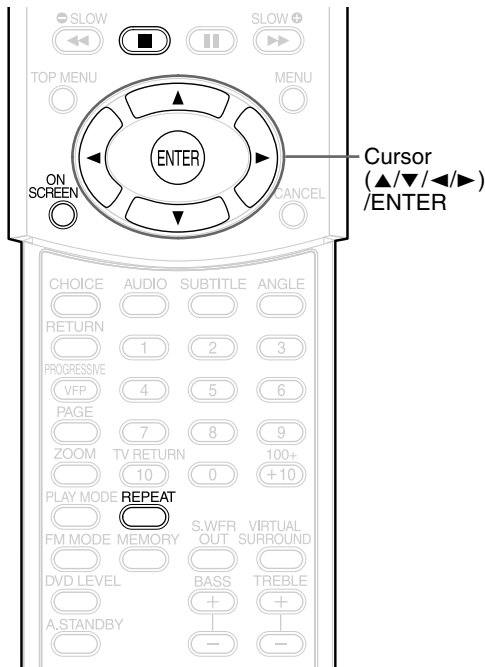

For CD/VCD/SVCD

| Repeat types              | Display on the TV screen | Display on the main unit |
|---------------------------|--------------------------|--------------------------|
| Repeats the current track | TRACK                    |                          |
| Repeats all tracks        | ALL                      | ALL                      |
| Cancels repeat            | OFF                      | No display               |

## NOTE

- For a DVD AUDIO and CD, this operation can always be carried out, while, for a VCD and SVCD, the operation can be carried out when the disc is stopped or during playback without the PBC function.
- It is possible to set Repeat on the menu bar. For how to operate, refer to "Playing the designated part repeatedly (A-B Repeat Playback)" (page 24).
- The abbreviations displayed on the main unit are as follows.  
 TRK : Track  
 CHP : Chapter  
 TI. : Title  
 GR. : Group
- For a DVD VIDEO and DVD AUDIO, if the source is switched to FM/AM or AUX, the Repeat mode will be cancelled.

## Playing the title/chapter/group/track/all tracks repeatedly (REPEAT)

DVD VIDEO DVD AUDIO VCD SVCD CD

### 1 Press REPEAT during playback.

Each time you press the button, the Repeat type will be alternated.

#### Example:

TV screen      Display window on the main unit

CHAP     

For DVD VIDEO

| Repeat types                | Display on the TV screen | Display on the main unit |
|-----------------------------|--------------------------|--------------------------|
| Repeats the current chapter | CHAP.                    |                          |
| Repeats the current title   | TITLE                    | ALL *                    |
| Cancels repeat              | OFF                      | No display               |

For DVD AUDIO

| Repeat types              | Display on the TV screen | Display on the main unit |
|---------------------------|--------------------------|--------------------------|
| Repeats the current track | TRACK                    |                          |
| Repeats the current group | GROUP                    | ALL *                    |
| Cancels repeat            | OFF                      | No display               |

\* represents blinking.

## Repeat Playback during Program or Random Playback

| Repeat types   | Display on the TV screen | Display on the main unit |
|--|--------------------------|--------------------------|
| Repeats the current chapter or track                               | STEP or REPEAT STEP      |                          |
| Repeats all programmed tracks or all the tracks in Random Playback | ALL or REPEAT ALL        | ALL                      |
| Cancels repeat   | OFF or No display        | No display               |

## Playing the designated part repeatedly (A-B Repeat Playback)

DVD VIDEO DVD AUDIO VCD CD

### 1 Press ON SCREEN twice during playback.

The menu bar (☰ page 29) will be displayed.

### 2 Press cursor ◀/▶ to select

☰ OFF.

### 3 Press ENTER.

### 4 Press cursor ▲/▼ to display

A-B.

Other Repeat modes can be selected here. For other Repeat modes, refer to “Playing the title/chapter/group/track/all tracks repeatedly (REPEAT)” (☰ page 23).

### 5 Press ENTER at the start point of the part to be repeated (designating A point).

- The icon on the menu bar will be ☰ A-.

### 6 Press ENTER at the end point of the part to be repeated (designating B point).

- The icon on the menu bar will be ☰ A-B. ☰ will appear blinking on the display window on the main unit and the part between A and B points will be played repeatedly.
- A-B Repeat Playback will be cancelled by carrying out the following operations.
  - Press ■.
  - Select ☰ A-B and press ENTER twice.

#### NOTE

A-B Repeat Playback is possible only within the same title or track. A-B Repeat Playback cannot be carried out during PBC playback, Program Playback, Random Playback and Repeat Playback.

# Other convenient functions

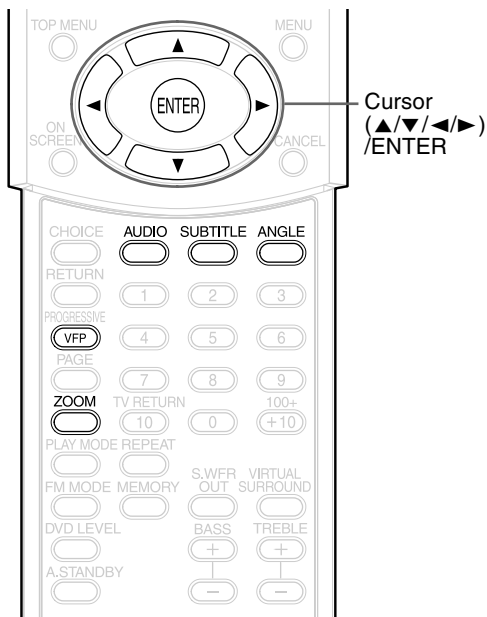

## Selecting the audio language

DVD VIDEO DVD AUDIO VCD SVCD

### 1 Press AUDIO during playback of a disc containing several audio languages.

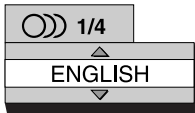
Example:  TV screen

- Each time you press the button, the audio language will be alternated. Also, the audio language can be changed by pressing cursor ▲/▼.
- For a language code such as “AA”, refer to “Language codes” (page 39).
- “ST”, “L” and “R” displayed when playing a VCD or SVCD respectively represent “Stereo”, “left sound” and “right sound”.

### 2 Wait for a few seconds or press ENTER.

#### NOTE

It is possible to operate by using the menu bar (page 29).

## Selecting the subtitles

DVD VIDEO SVCD DVD AUDIO

(only for moving image)

### 1 Press SUBTITLE during playback of a disc containing subtitles in several languages.

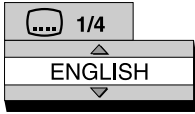
Example:  TV screen

- Each time you press the button, the subtitle will be alternated between ON/OFF.

### 2 Press cursor ▲/▼ to select a subtitle language.

- For a language code such as “AA”, refer to “Language codes” (page 39).
- The manner of displaying subtitle languages may be different depending on the disc.

### 3 Wait for a few seconds or press ENTER.

#### NOTE

- It is possible to operate by using the menu bar (page 29).
- For a SVCD, each time you press SUBTITLE in Step 1, the subtitle type and ON/OFF will be alternated.

## Selecting a view angle

DVD VIDEO DVD AUDIO

(only for moving image)

### 1 Press ANGLE during playback of a scene containing multi-view angles.

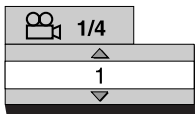
Example:  TV screen

- Each time you press the button, the angle will be alternated. Also, the angle can be changed by pressing cursor ▲/▼.

### 2 Wait for a few seconds or press ENTER.

#### NOTE

It is possible to operate by using the menu bar (page 29).

## Enlarging the picture (ZOOM)

DVD VIDEO VCD SVCD DVD AUDIO

(only for moving image)

### 1 Press ZOOM during playback or while paused.

- Each time you press the button, the picture magnification will be changed ( $\times 1.5$  only for a VCD and SVCD).

### 2 Select the portion you want to see by using cursor $\blacktriangle/\blacktriangledown/\blacktriangleleft/\blacktriangleright$ .

- This operation cannot be carried out when the magnification is  $\times 1$ .
- To resume normal playback, select  $\times 1$  in Step 1.

## Adjusting the picture quality (VFP)

DVD VIDEO DVD AUDIO VCD SVCD JPEG

### 1 Press VFP during playback or while paused.

“VFP SET” will appear on the display window on the main unit and the current setting will be displayed on the TV screen.

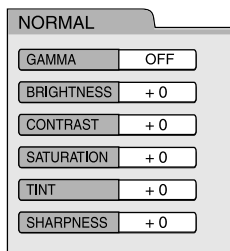

- Gamma: Controls brightness of neutral tints while maintaining brightness of dark and bright portions.
- Sharpness: Controls screen sharpness.

### 2 Press cursor $\blacktriangleleft/\blacktriangleright$ to select VFP mode.

- It is recommended to select “NORMAL” usually, or “CINEMA” in a dark room. When either “NORMAL” or “CINEMA” is selected, go to Step 7.
- When either “USER 1” or “USER 2” is selected, the adjustment can be carried out in detail in the operations after Step 3.

### 3 Press cursor $\blacktriangle/\blacktriangledown$ to select an item to be adjusted.

### 4 Press ENTER.

Example:

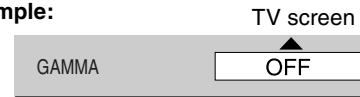

### 5 Press cursor $\blacktriangle/\blacktriangledown$ to change the value.

### 6 Press ENTER.

To adjust other items, go back to Step 3.

### 7 Press VFP.

#### NOTE

- If no operation is made for several seconds during the procedure, the settings made so far will be automatically stored.
- “VFP” is an abbreviation of “Video Fine Processor”.

## Other convenient functions (continued)

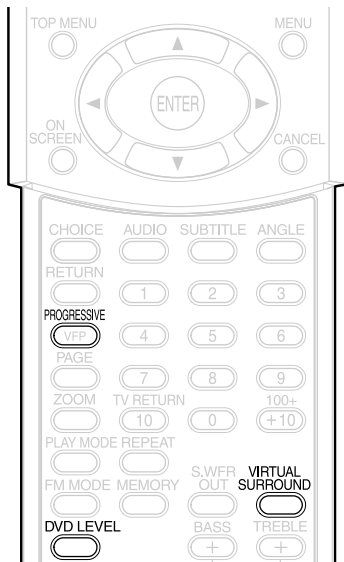

### Creating realistic sound (VIRTUAL SURROUND)



#### NOTE

Virtual Surround can be set only for multi-channel sound (AC3, LPCM, PPCM and DTS). Virtual Surround cannot be set for 2 channel audio such as PCM stereo or Dolby Surround.

### 1 Press VIRTUAL SURROUND during playback.

Example: TV screen



- Each time you press the button, the Surround mode will be alternated between ON/OFF.
- When ON, "SURROUND" appears on the display window.
- When switching the Surround mode, the sound will be intermittent.

#### NOTE

- Virtual Surround is effective for the speakers and headphones.
- "V.SUR." displayed on the display window is an abbreviation of "Virtual Surround".

### Adjusting playback level (DVD LEVEL)



The audio of a DVD VIDEO and DVD AUDIO may be recorded at a lower level (volume) than for other

types of disc. If the difference is not to your liking, adjust the DVD Level.

### 1 Press DVD LEVEL during playback.

- Each time you press the button, the level will be alternated among "NOR" (Normal), "MID" (Middle) and "HIG" (High).
- Select the level while listening to the sound played.

#### NOTE

- DVD Level is effective only for playback of a DVD.
- Even if the DVD Level is changed, the output level from the digital audio output terminal will not be changed.
- This operation can be carried out while the disc is stopped or paused.

### Enjoying better pictures (PROGRESSIVE)

In the Progressive mode, better pictures can be enjoyed.

#### CAUTION

- In order to enjoy pictures in the Progressive mode, the following requirements should be met.
    - There must be a component video input terminal on the TV set connected to the main unit.
    - The main unit and the TV set must be connected using a component video cord (see page 12).
- When the above requirements are not satisfied, leave the main unit in the Interlace mode. If the Progressive mode is set, pictures may be distorted.

#### NOTE

Progressive mode:

All scanned lines will be displayed at once. Pictures of higher resolution than those in the Interlace mode can be realized.

Interlace mode:

This is a conventional image method. Half of the scanned lines displayed in the Progressive mode will appear, alternating with the other half.

### Display "PROGRESS" by holding down PROGRESSIVE during playback or while the disc is stopped, or when there is no disc loaded.

- Each time you hold down the button, the mode will be alternated between the Progressive mode and the Interlace mode.
- The display window displays "PROGRESS" when in the Progressive mode, and "INTER." when in the Interlace mode.

**DVD  
AUDIO**

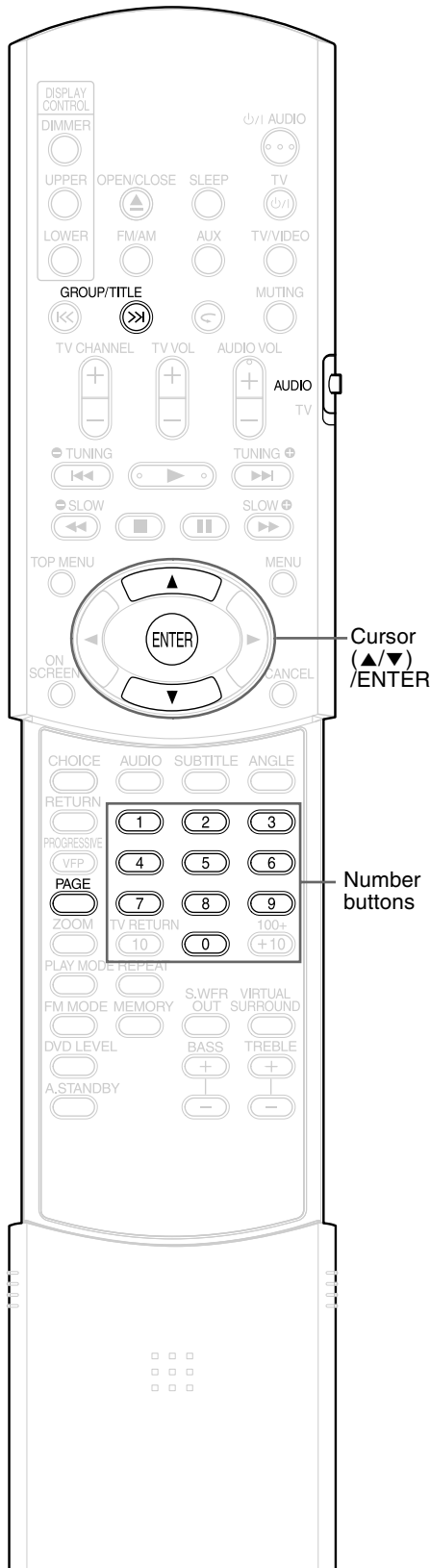

### NOTE

Set the remote control mode selector to **AUDIO** before using the number buttons. 

## Playing the Bonus Group

There are some DVD AUDIO discs with a special group, called "Bonus Group", recorded.

### NOTE

This operation can be carried out when "BONUS" is lit on the display window on the main unit.

### 1 Press GROUP/TITLE >> repeatedly during playback to select a bonus group.

"KEY\_ \_ \_ \_" appears on the TV screen, and on the display window on the main unit.

### 2 Press the number buttons to enter a pin code (4 digits).

The method of getting a pin code may be different depending on the disc.

### 3 Press ENTER.

- When a correct pin code is entered, "BONUS" disappears and the playback of the bonus group starts.
- If an incorrect pin code is entered, try entering a correct pin code again.

## Browsable Still Pictures (B.S.P.)

There are some DVD AUDIO discs with still pictures recorded. Among the still pictures, there are pictures called B.S.P. (Browsable Still Pictures). With these pictures, it is possible to switch a picture as if turning over pages.

### NOTE

This operation can be carried out when "B.S.P." is lit on the display window on the main unit.

### 1 Press PAGE during playback.

Each time you press the button, the still picture will be switched over. It is also possible to switch the picture using cursor ▲/▼.

Example:

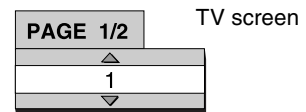

### 2 Wait for a few seconds or press ENTER.

# Using the menu bar

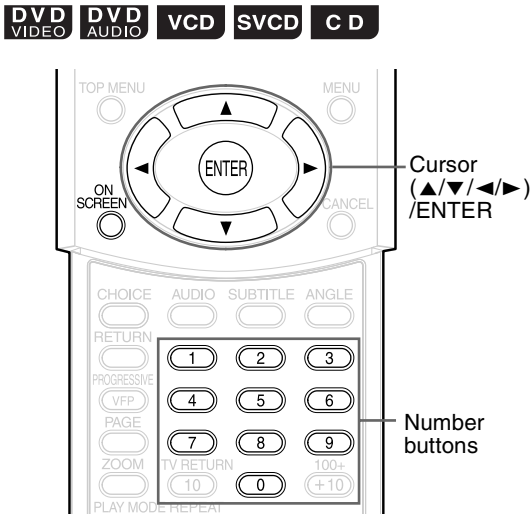

## NOTE

- Set the remote control mode selector to **AUDIO** before using the number buttons.
- This operation can be carried out when there is a disc loaded. There are some functions that may not work while the disc is stopped.

## 1 Press ON SCREEN twice.

“ON SCREEN” will appear on the display window on the main unit. The status bar and the menu bar will appear on the TV screen.

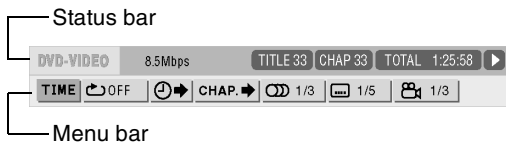

The above is an example for a DVD VIDEO.

## 2 Press cursor ◀/▶ to select an item to be operated.

## 3 Press ENTER.

- The selected function can be set. For the setting content, refer to the following “Functions list”.
- The currently active function shows blue.
- To delete the menu bar, press **ON SCREEN**.

## Functions list

For the functions with no special description for the operations, press cursor ▲/▼ to select, and press **ENTER** to determine.

|   |  |
|---|--|
| <b>TIME</b><br>Time display selection                                 | Select this to change time information displayed on the display window on the main unit and the status bar. Each time <b>ENTER</b> is pressed, the display will be alternated.<br><b>DVD VIDEO/DVD AUDIO (operating during playback)</b><br>TOTAL : Elapsed playing time of current title/group.<br>T.REM : Remaining time of current title/group<br>TIME : Elapsed playing time of current chapter/track.<br>REM : Remaining time of current chapter/track<br><b>CD (operating during playback)/VCD/SVCD</b><br>TIME : Elapsed playing time of current track.<br>REM : Remaining time of current track.<br>TOTAL : Elapsed playing time of disc.<br>T.REM : Remaining time of disc. |
| Repeat mode   | ⇨ page 23  |
| Time search   | ⇨ page 20  |
| CHAP▶ / TRACK▶<br>Chapter search (DVD VIDEO)/Track search (DVD AUDIO) | Select a chapter/track. Press the number buttons to input the chapter/track number and press <b>ENTER</b> .<br>Examples:<br>5: (5)    24: (2) → (4)  |
| Audio language/Audio (DVD VIDEO/DVD AUDIO/VCD/SVCD)                   | ⇨ page 25  |
| Subtitle language (DVD VIDEO/SVCD)                                    | ⇨ page 25  |
| 1/3<br>View angle (DVD VIDEO/DVD AUDIO)                               | ⇨ page 25  |
| PAGE -/-<br>Page switch (DVD AUDIO)                                   | Switch the still pictures (B.S.P.) recorded on a DVD AUDIO disc. (⇨ page 28)   |

## Information displayed on the status bar

DVD VIDEO/DVD AUDIO (the example below is for a DVD VIDEO)

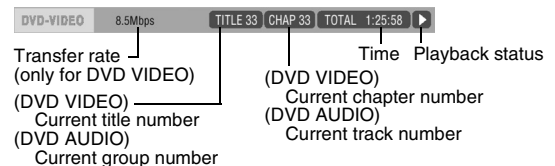

VCD/SVCD/CD (the example below is for a CD)

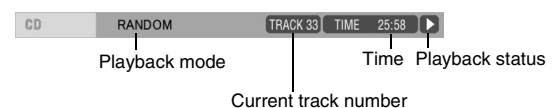

## NOTE

The playback status mark has the same meaning of the mark on the On-screen guide (⇨ page 16).



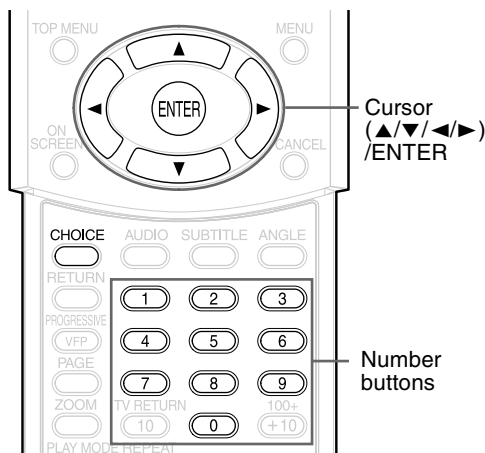

The initial settings of the system can be changed according to the environment the system is used in.

### NOTE

- Set the remote control mode selector to **AUDIO** before using the number buttons.
- The top and bottom of the preference screen may not be displayed on a wide TV. Adjust the picture size on the TV.

## Basic operations

### 1 Press CHOICE while the disc is stopped or no disc is loaded (“NO DISC” is displayed).

- “SETTING” will appear on the display window on the main unit and the following screen will be displayed on the TV.

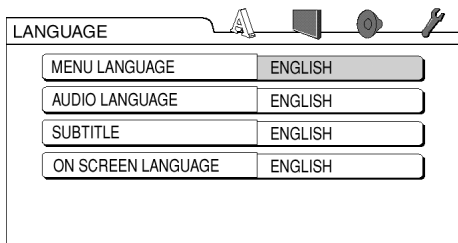

- Proceed with operations by following the description on the TV screen.



## LANGUAGE





### NOTE

- If the selected language is not recorded on the disc, the optimum language set for the disc will be displayed.
- For a language code such as “AA”, refer to the “Language codes” (page 39).

| Items                     | Contents   |
|---------------------------|--|
| <b>MENU LANGUAGE</b>      | Select the language for the DVD VIDEO menu.              |
| <b>AUDIO LANGUAGE</b>     | Select the audio language for the DVD VIDEO.             |
| <b>SUBTITLE</b>           | Select the subtitle language for the DVD VIDEO.          |
| <b>ON SCREEN LANGUAGE</b> | Select the language displayed on the preference screens. |



## PICTURE

| Items               | Contents (  : initial setting)   |
|---------------------|--|
| <b>MONITOR TYPE</b> | <p>Select a <b>display method suitable for your TV.</b></p> <p><b>16 : 9 NORMAL:</b><br/>Select this when the aspect ratio of your wide TV is fixed to 16:9 (when playing a DVD VIDEO recorded at 4:3, the system automatically adjusts the screen width of the output signal).</p>  <p><b>16 : 9 AUTO:</b><br/>Select this when your TV is an ordinary wide TV.</p>  <p><b>4 : 3 LB (Letter Box) :</b><br/>Select this when the aspect ratio of your TV is conventional 4:3. While viewing a wide screen picture, the black bars appear on the top and bottom of the screen.</p>  <p><b>4 : 3 PS (Pan Scan):</b><br/>Select this when the aspect ratio of your TV is conventional 4:3. While viewing a wide screen picture, the left and right edges of the picture will not be shown on the screen. (If the disc is not compatible with Pan Scan, the picture will be displayed at the Letter Box ratio.)</p>  |
| <b>SCREEN SAVER</b> | Select the Screen Saver mode between <b>ON</b> / <b>OFF</b> (Screen Saver activates when there is no operation made for about 5 minutes since a still picture was last displayed).   |
| <b>MP3/JPEG</b>     | If there are both <b>MP3</b> and <b>JPEG</b> files on a disc, you can select which files to play. When the preference has been changed, open/close the tray and turn on the power again. (A disc with only one of MP3 file or JPEG file recorded can be played regardless of this preference.)   |

## Preferences (continued)



### AUDIO

| Items                                 | Contents ( [ ] : initial setting)   |
|---------------------------------------|---|
| <b>DIGITAL AUDIO OUTPUT</b>           | <p>Select an output signal type from the following in accordance with the device connected to the digital audio output terminal (AV amplifier, etc.). (See the list below for the preference items and output signal.)</p> <p><b>PCM ONLY:</b><br/>Device corresponding only to linear PCM.</p> <p><b>DOLBY DIGITAL/PCM:</b><br/>Dolby digital decoder or a device having the same function.</p> <p><b>STREAM/PCM :</b><br/>DTS/Dolby digital decoder or a device having the same function.</p> |
| <b>DOWN MIX</b>                       | <p>Switch signal from the digital output terminal of the DVD VIDEO according to the connected device. Select this when Digital Audio Output is set to "PCM ONLY".</p> <p><b>DOLBY SURROUND :</b><br/>A Dolby Pro Logic decoder-built-in device.</p> <p><b>STEREO:</b><br/>An ordinary device.</p> <ul style="list-style-type: none"> <li>When Virtual Surround is ON, Down Mix does not work.</li> </ul>  |
| <b>D (Dynamic). RANGE COMPRESSION</b> | <p>To make adjustments for the difference between a high volume and a low volume when playing back with low volume (only for a DVD recorded with Dolby digital).</p> <p><b>AUTO :</b><br/>D. Range Compression automatically works.</p> <p><b>ON:</b><br/>D. Range Compression always works.</p>  |



### OTHERS

| Items                    | Contents ( [ ] : initial setting)  |
|--------------------------|--|
| <b>RESUME</b>            | Select <b>ON</b> /OFF. (⇨ page 19)   |
| <b>ON SCREEN GUIDE</b>   | Select <b>ON</b> /OFF. (⇨ page 16)   |
| <b>AV COMPULINK MODE</b> | <p>(⇨ page 37)</p> <p><b>DVD1 :</b><br/>Connect to the video-3 input on the TV set or the DVD input on the AV amplifier.</p> <p><b>DVD2:</b><br/>Connect to the video-1 input of the TV set.</p> <p><b>DVD3:</b><br/>Connect to the video-2 input of the TV set.</p>   |
| <b>PARENTAL LOCK</b>     | <p>Set the Parental Lock function to cut off violent scenes or replace the scenes with others. (This is effective only for discs equipped with the Parental Lock function.)</p> <p><b>COUNTRY CODE (⇨ page 32)</b><br/>Select your country.</p> <p><b>SET LEVEL:</b><br/>The restriction is stricter as the number becomes smaller. "NONE" is no restriction.</p> <p><b>PASSWORD (essential):</b><br/>Enter four-digit number as your password using the number buttons (1-9, 0) every time. (Enter "8888" if you forget your password.) The password is required at the time of playback.</p> <ul style="list-style-type: none"> <li>If you enter a wrong password three times, "EXIT" will be automatically selected.</li> </ul> |

## List of relationships of DIGITAL AUDIO OUTPUT preference items and output signal

| Playback disc  | DIGITAL AUDIO OUTPUT preference                               |                                   |                                   |
|--|---|-----------------------------------|-----------------------------------|
|  | Stream/PCM  | DOLBY DIGITAL/PCM                 | PCM only                          |
| 48 kHz, 16/20/24 bits<br>Linear PCM DVD VIDEO<br>96 kHz linear PCM DVD VIDEO | 48 kHz, 16 bits stereo linear PCM                             |                                   |                                   |
| 48/96/192 kHz,<br>16/20/24 bits linear PCM DVD AUDIO                         | 48 kHz, 16 bits stereo linear PCM                             |                                   |                                   |
| 44.1/88.2/176.4k Hz,<br>16/20/24 bits linear PCM DVD AUDIO                   | 44.1 kHz, 16 bits stereo linear PCM                           |                                   |                                   |
| DTS DVD VIDEO  | DTS bit stream  | 48 kHz, 16 bits stereo linear PCM |                                   |
| DOLBY DIGITAL DVD VIDEO/<br>DVD AUDIO  | DOLBY DIGITAL bit stream                                      |                                   | 48 kHz, 16 bits stereo linear PCM |
| CD/VCD/SVCD  | 44.1 kHz, 16 bits stereo linear PCM/48kHz, 16 bits linear PCM |                                   |                                   |
| DTS CD   | DTS bit stream  | 44.1 kHz, 16 bits linear PCM      |                                   |
| MP3 disc   | No output   |                                   |                                   |

### NOTE

- For a DVD VIDEO without content protection set, there is a 20 bit or 24 bit output at the digital audio output terminal.

|    |                          |
|----|--------------------------|
| AD | Andorra                  |
| AE | United Arab Emirates     |
| AF | Afghanistan              |
| AG | Antigua and Barbuda      |
| AI | Anguilla                 |
| AL | Albania                  |
| AM | Armenia                  |
| AN | Netherlands Antilles     |
| AO | Angola                   |
| AQ | Antarctica               |
| AR | Argentina                |
| AS | American Samoa           |
| AT | Austria                  |
| AU | Australia                |
| AW | Aruba                    |
| AZ | Azerbaijan               |
| BA | Bosnia and Herzegovina   |
| BB | Barbados                 |
| BD | Bangladesh               |
| BE | Belgium                  |
| BF | Burkina Faso             |
| BG | Bulgaria                 |
| BH | Bahrain                  |
| BI | Burundi                  |
| BJ | Benin                    |
| BM | Bermuda                  |
| BN | Brunei Darussalam        |
| BO | Bolivia                  |
| BR | Brazil                   |
| BS | Bahamas                  |
| BT | Bhutan                   |
| BV | Bouvet Island            |
| BW | Botswana                 |
| BY | Belarus                  |
| BZ | Belize                   |
| CA | Canada                   |
| CC | Cocos (Keeling) Islands  |
| CF | Central African Republic |
| CG | Congo                    |
| CH | Switzerland              |
| CI | Côte d'Ivoire            |
| CK | Cook Islands             |
| CL | Chile                    |
| CM | Cameroon                 |
| CN | China                    |
| CO | Colombia                 |
| CR | Costa Rica               |
| CU | Cuba                     |
| CV | Cape Verde               |
| CX | Christmas Island         |
| CY | Cyprus                   |
| CZ | Czech Republic           |
| DE | Germany                  |
| DJ | Djibouti                 |
| DK | Denmark                  |
| DM | Dominica                 |
| DO | Dominican Republic       |
| DZ | Algeria                  |
| EC | Ecuador                  |
| EE | Estonia                  |
| EG | Egypt                    |
| EH | Western Sahara           |
| ER | Eritrea                  |

|    |  |
|----|--|
| ES | Spain  |
| ET | Ethiopia                                     |
| FI | Finland                                      |
| FJ | Fiji   |
| FK | Falkland Islands (Malvinas)                  |
| FM | Micronesia (Federated States of)             |
| FO | Faeroe Islands                               |
| FR | France                                       |
| FX | France, Metropolitan                         |
| GA | Gabon  |
| GB | United Kingdom                               |
| GD | Grenada                                      |
| GE | Georgia                                      |
| GF | French Guiana                                |
| GH | Ghana  |
| GI | Gibraltar                                    |
| GL | Greenland                                    |
| GM | Gambia                                       |
| GN | Guinea                                       |
| GP | Guadeloupe                                   |
| GQ | Equatorial Guinea                            |
| GR | Greece                                       |
| GS | South Georgia and the South Sandwich Islands |
| GT | Guatemala                                    |
| GU | Guam   |
| GW | Guinea-Bissau                                |
| GY | Guyana                                       |
| HK | Hong Kong                                    |
| HM | Heard Island and McDonald Islands            |
| HN | Honduras                                     |
| HR | Croatia                                      |
| HT | Haiti  |
| HU | Hungary                                      |
| ID | Indonesia                                    |
| IE | Ireland                                      |
| IL | Israel                                       |
| IN | India  |
| IO | British Indian Ocean Territory               |
| IQ | Iraq   |
| IR | Iran (Islamic Republic of)                   |
| IS | Iceland                                      |
| IT | Italy  |
| JM | Jamaica                                      |
| JO | Jordan                                       |
| JP | Japan  |
| KE | Kenya  |
| KG | Kyrgyzstan                                   |
| KH | Cambodia                                     |
| KI | Kiribati                                     |
| KM | Comoros                                      |
| KN | Saint Kitts and Nevis                        |
| KP | Korea, Democratic People's Republic of       |
| KR | Korea, Republic of                           |
| KW | Kuwait                                       |
| KY | Cayman Islands                               |
| KZ | Kazakhstan                                   |
| LA | Lao People's Democratic Republic             |
| LB | Lebanon                                      |

|    |                           |
|----|---------------------------|
| LC | Saint Lucia               |
| LI | Liechtenstein             |
| LK | Sri Lanka                 |
| LR | Liberia                   |
| LS | Lesotho                   |
| LT | Lithuania                 |
| LU | Luxembourg                |
| LV | Latvia                    |
| LY | Libyan Arab Jamahiriya    |
| MA | Morocco                   |
| MC | Monaco                    |
| MD | Moldova, Republic of      |
| MG | Madagascar                |
| MH | Marshall Islands          |
| ML | Mali                      |
| MM | Myanmar                   |
| MN | Mongolia                  |
| MO | Macau                     |
| MP | Northern Mariana Islands  |
| MQ | Martinique                |
| MR | Mauritania                |
| MS | Montserrat                |
| MT | Malta                     |
| MU | Mauritius                 |
| MV | Maldives                  |
| MW | Malawi                    |
| MX | Mexico                    |
| MY | Malaysia                  |
| MZ | Mozambique                |
| NA | Namibia                   |
| NC | New Caledonia             |
| NE | Niger                     |
| NF | Norfolk Island            |
| NG | Nigeria                   |
| NI | Nicaragua                 |
| NL | Netherlands               |
| NO | Norway                    |
| NP | Nepal                     |
| NR | Nauru                     |
| NU | Niue                      |
| NZ | New Zealand               |
| OM | Oman                      |
| PA | Panama                    |
| PE | Peru                      |
| PF | French Polynesia          |
| PG | Papua New Guinea          |
| PH | Philippines               |
| PK | Pakistan                  |
| PL | Poland                    |
| PM | Saint Pierre and Miquelon |
| PN | Pitcairn                  |
| PR | Puerto Rico               |
| PT | Portugal                  |
| PW | Palau                     |
| PY | Paraguay                  |
| QA | Qatar                     |
| RE | Réunion                   |
| RO | Romania                   |
| RU | Russian Federation        |
| RW | Rwanda                    |
| SA | Saudi Arabia              |
| SB | Solomon Islands           |
| SC | Seychelles                |

|    |                                      |
|----|--------------------------------------|
| SD | Sudan                                |
| SE | Sweden                               |
| SG | Singapore                            |
| SH | Saint Helena                         |
| SI | Slovenia                             |
| SJ | Svalbard and Jan Mayen               |
| SK | Slovakia                             |
| SL | Sierra Leone                         |
| SM | San Marino                           |
| SN | Senegal                              |
| SO | Somalia                              |
| SR | Suriname                             |
| ST | Sao Tome and Principe                |
| SV | El Salvador                          |
| SY | Syrian Arab Republic                 |
| SZ | Swaziland                            |
| TC | Turks and Caicos Islands             |
| TD | Chad                                 |
| TF | French Southern Territories          |
| TG | Togo                                 |
| TH | Thailand                             |
| TJ | Tajikistan                           |
| TK | Tokelau                              |
| TM | Turkmenistan                         |
| TN | Tunisia                              |
| TO | Tonga                                |
| TP | East Timor                           |
| TR | Turkey                               |
| TT | Trinidad and Tobago                  |
| TV | Tuvalu                               |
| TW | Taiwan                               |
| TZ | Tanzania, United Republic of         |
| UA | Ukraine                              |
| UG | Uganda                               |
| UM | United States Minor Outlying Islands |
| US | United States                        |
| UY | Uruguay                              |
| UZ | Uzbekistan                           |
| VA | Vatican City State (Holy See)        |
| VC | Saint Vincent and the Grenadines     |
| VE | Venezuela                            |
| VG | Virgin Islands (British)             |
| VI | Virgin Islands (U.S.)                |
| VN | Viet Nam                             |
| VU | Vanuatu                              |
| WF | Wallis and Futuna Islands            |
| WS | Samoa                                |
| YE | Yemen                                |
| YT | Mayotte                              |
| YU | Yugoslavia                           |
| ZA | South Africa                         |
| ZM | Zambia                               |
| ZR | Zaire                                |
| ZW | Zimbabwe                             |

# Listening to a radio broadcast

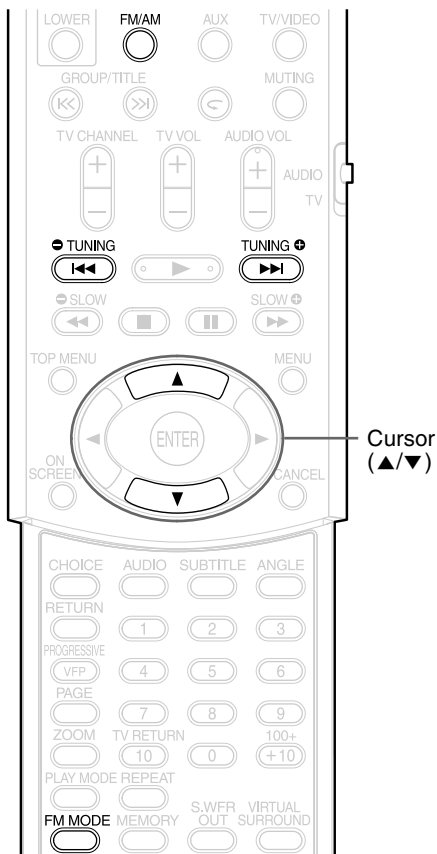

You can tune in to FM or AM.

## Selecting a station

### 1 Press FM/AM.

Each time you press the button, the band will be alternated between FM and AM.

**Example:**

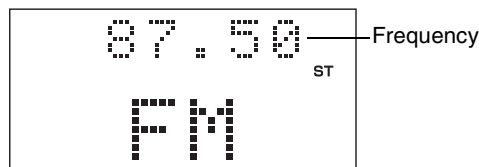

### 2 Press TUNING - or TUNING + to select the station (frequency).

**Automatic tuning:**

Hold down **TUNING -** or **TUNING +** until the system starts searching, and then release the button.

When a station of sufficient signal strength is tuned in to, the system stops searching automatically.

To stop searching manually, press **TUNING -** or **TUNING +**.

**Manual tuning:**

Each time you press **TUNING -** or **TUNING +**, the frequency changes.

- When an FM stereo program is received, the "ST" (Stereo) indicator lights.
- You can also select the station with cursor ▲/▼.

## Setting the AM tuner interval spacing

Some countries space AM stations 9 kHz apart, and other countries use 10 kHz spacing.

**On the main unit ONLY:**

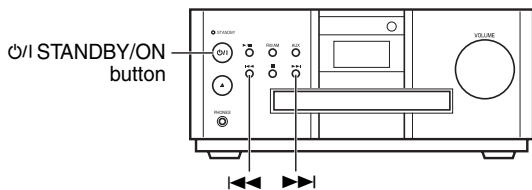

To select 10 kHz intervals, while holding down ►► on the main unit in Standby mode, press **STANDBY/ON** on the main unit to turn on the power. "10 kHz" appears on the display window.

To select 9 kHz intervals, while holding down ◀◀ on the main unit in Standby mode, press **STANDBY/ON** on the main unit to turn on the power. "9 kHz" appears on the display window.

### NOTE

*If the interval spacing is switched, the memory in which the radio stations were stored will be erased.*

### NOTE

*If the stereo FM program currently tuned in to is noisy, you can improve the reception by pressing **FM MODE** to switch to the monaural mode ("MONO" lights). If you press **FM MODE** again, or tune in to another station, the receiving mode returns automatically to the stereo mode.*

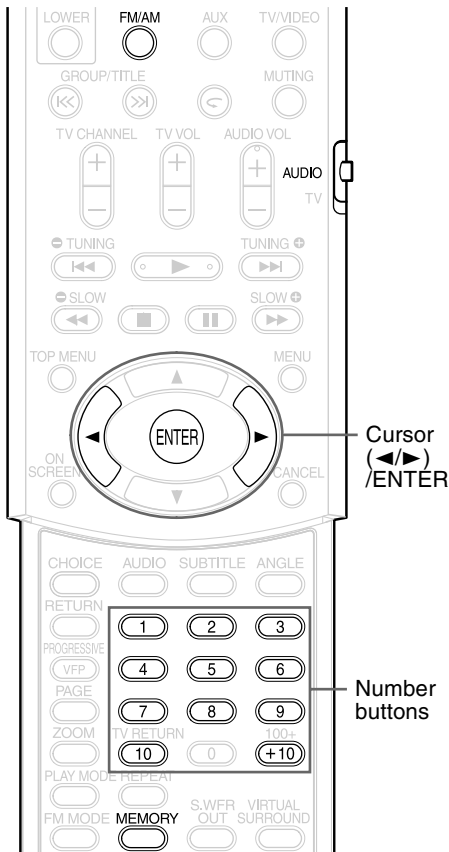

**3** Select the number you want to store by pressing cursor **</>** while the memory number is blinking.

- You can also select the number by using the number buttons.
- Refer to “How to use the number buttons” (page 16).

**4** Press **MEMORY** or **ENTER** while the selected number is blinking.

“SET” will be displayed and the selected station will be stored.

**NOTE**

Storing a new station to a used number erases the previously stored station.

## Tuning in to a preset station

**1** Press **FM/AM** repeatedly to select either **FM** or **AM**.

**2** Press the number buttons to select the memory number of a station you want to tune in to.

Refer to “How to use the number buttons” (page 16).

You can also select by pressing cursor **</>**.

Presetting stations in the system allows you to easily tune in to a station.

**NOTE**

Set the remote control mode selector to **AUDIO** before using the number buttons.



## Presetting stations

The system stores up to 30 FM stations and up to 15 AM stations.

**1** Select a station you want to store (page 33 for how to select).

**2** Press **MEMORY**.

Figures (memory number) blink on the display window for about 5 seconds.

## Listening to the sound of other audio device

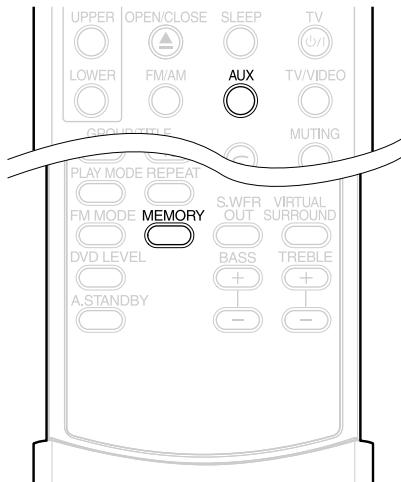

Connect the other audio device to this system in advance (☞ page 11).

### 1 Press AUX.

The source changes to AUX.

### 2 Play the other audio device.

For details, refer to the manual of the device connected.

### 3 Adjust the volume and the sound quality of the system (☞ page 17).

## Adjust the sound input level of the audio device

You can adjust the sound input level of another audio device connected to the AUX jack.

### 1 Press AUX.

The source changes to AUX.

### 2 Hold down MEMORY until an input level is displayed.

Each time you hold down the button, it switches as follows:

LEVEL 1: Select this normally.



LEVEL 2: Select this when the input level from the other device is too high and the sound is distorted.

The initial setting is "LEVEL1".

## Auto Standby

DVD VIDEO DVD AUDIO VCD SVCD C D MP3 JPEG

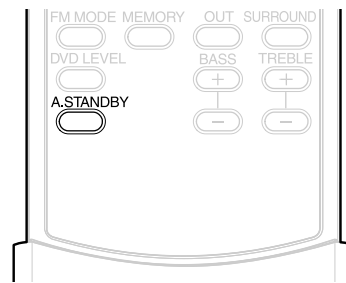

If there is no operation for 3 minutes while the disc is stopped, the power will be automatically turned off.

### 1 Press A.STANDBY during playback or while the disc is stopped, or no disc is loaded ("NO DISC" is displayed).

"A.S.ON" (Auto Standby On) and "A.STANDBY" will be lit on the display window on the main unit.

When a stopped state is entered (after playback is finished, for example), "A.STANDBY" starts blinking.

This means that the power will be turned off automatically if there is no operation for 3 minutes. And, 20 seconds before the power is turned off, "POWER OFF" will appear blinking.

## Releasing Auto Standby

Press A.STANDBY.

"A.S.OFF" (Auto Standby Off) will appear and "A.STANDBY" will be turned off on the display window on the main unit.

### NOTE

When the source is FM/AM or AUX, Auto Standby does not work.

# Sleep Timer

---

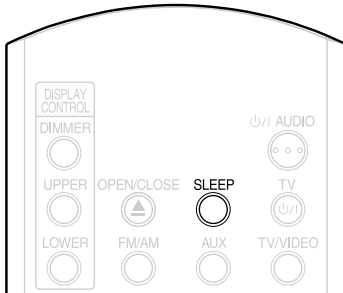

When the time you specify elapses, the system will be turned off by itself.

## Press SLEEP.

Each time you press the button, the time indicated on the display window on the main unit changes (in minutes).

**Example:** When Sleep Timer is set to 60 minutes

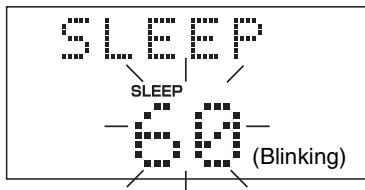

Sleep Timer will be automatically set in a few seconds, and the indication will disappear.

### **NOTE**

When Sleep Timer is set, the display window darkens automatically.

## Changing the time

---

Reselect the time by pressing **SLEEP** repeatedly.

## Confirming the time

---

Press **SLEEP** once while Sleep Timer is set.

## Releasing

---

Press **SLEEP** repeatedly until "OFF" appears.

### **NOTE**

Sleep Timer will also be released when the power is turned off.

# Tray Lock

---

You can lock the disc tray to prevent the disc from being ejected.

## Setting

---

Turn off the power. And while holding down ■ (Stop) on the main unit, press ▲ (Open/Close).

"LOCKED" appears on the display window on the main unit.

## Releasing

---

Carry out the same operations as those for setting. "UNLOCKED" appears on the display window on the main unit.

# Using AV COMPU LINK

When the TV set or device to be connected is a JVC product equipped with the AV COMPU LINK-II or -III jack, connecting them to the AV COMPU LINK jack on the system will allow you to control the other devices by operating one device.

## Connection and setting

### NOTE

- Refer to "Others" (page 31) to set the AV COMPU LINK mode.
- Also carefully read manuals of devices to be connected.

### Connection with a TV set

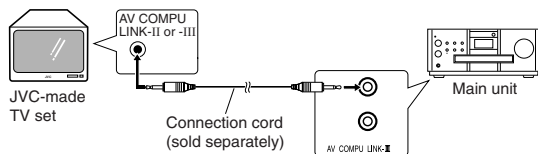

| TV input jack | Setting of AV COMPU LINK mode |
|---------------|-------------------------------|
| Video 3       | DVD 1                         |

- Connect to the Video 3 (DVD) input jack on your TV set. If Video 3 is for DV/Movie input, read the following descriptions:

### Connection with a TV set and a VCR

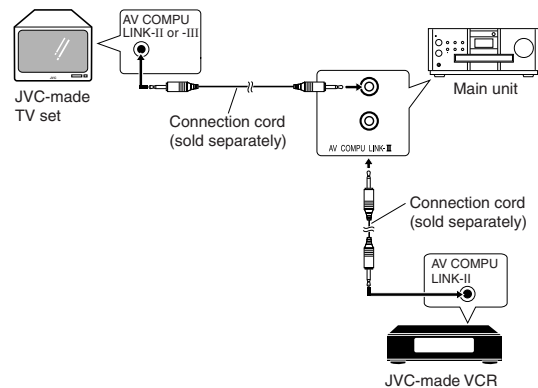

| TV input jack | AV COMPU LINK mode | Remote-control code of VCR |
|---------------|--------------------|----------------------------|
| Video 1       | DVD 2              | B                          |
| Video 2       | DVD 3              | A                          |

- When using with initial settings, connect to Video 3 (if not set to DV/Movie input). Set the remote-control code to "A".

### Connection with a TV set and an AV amplifier

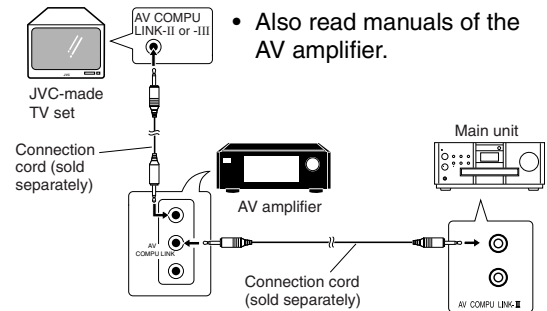

- Also read manuals of the AV amplifier.

| Input jack of AV amplifier | AV COMPU LINK mode |
|----------------------------|--------------------|
| DVD                        | DVD 1              |

### NOTE

- Connecting DVD sound output to a sound input jack for any device other than a DVD disables proper operation.
- When connecting component video output to a TV set, change setting of the AV COMPU LINK mode in this system to "DVD 1". Do not connect to the S-video jack on the AV amplifier.

## Operations

- 1 Turn on the main power of the TV set.
- 2 Insert a disc or videotape into the source device (the system or a VCR).
- 3 Press the play button on the source device.

- The TV set will be turned on.
- TV input will be switched to external input (Video 1, 2 or 3) of the source device.
- The AV amplifier will be turned on.
- The source of the AV amplifier will be switched to the device on which the play button has been pressed.



When you encounter a problem that seems to be a fault, check the following points before contacting your JVC service center:

## Power source

---

### ■ Power does not come on.

- The power cord is not connected to the main unit or an AC outlet.  
→ Connect the power cord correctly. (☞ page 12)

## Operation

---

### ■ You cannot operate any button.

- Some specific operations may be inhibited for some discs.

### ■ The remote control does not work.

- The dry-cell batteries have run out.  
→ Replace the batteries. (☞ page 7)

### ■ A disc cannot be played back.

- In the case of DVD VIDEO discs  
→ Check the Region Code number of the disc. (☞ page 3)
- “PLAYABLE Err” is displayed on the display window.  
It is not a disc that can be played on this system.  
→ Check the disc type. (☞ page 3)
- Parental Lock is set. (☞ page 31)

## About images

---

### ■ No picture appears.

- The video cord is not connected correctly.  
→ ☞ page 12
- Both of the component video jack and S-video jack are connected.  
→ Connect either. (☞ page 12)

### ■ The picture is distorted.

- A VCR is connected between the main unit and the TV set.  
→ Connect the main unit directly to the TV set. (☞ page 12)
- Although this system is connected to a non-Progressive TV set, DVD's scan mode is set to “PROGRESS”.  
→ Set the scan mode to “INTER.”.  
(☞ page 27)

### ■ The screen size is abnormal.

- The screen size is set improperly.  
→ Set “MONITOR TYPE” according to the TV set you are using. (☞ page 30)

### ■ The TV screen darkens.

- “SCREEN SAVER” is set.  
→ If set, press any button. (☞ page 30)

### ■ The screen cannot be switched.

- The Progressive mode is applied only to component video output.

## About sound

---

### ■ There is no sound.

- Speakers are not connected correctly.  
→ ☞ page 10
- The sound is muted.  
→ ☞ page 17
- “NO AUDIO” is displayed on the display window.  
The disc may have been produced through illegal copying.  
→ Confirm at the store where you bought the disc.

### ■ The sound is weak compared with TV or Video.

- “DVD LEVEL” is set to “NOR”.  
→ Set to other than “NOR”. (☞ page 27)

### ■ The sound is distorted.

- The volume is turned up too high.  
→ Turn down the volume. (☞ page 17)

### ■ No sound comes out of the subwoofer.

- “SUB WFR” is turned off.  
→ Press **S.WFR OUT** to turn on.  
(☞ page 11)

## About radio

---

### ■ The sound is noisy while receiving./Receiving is disabled.

- The antenna is not connected correctly.  
→ Connect the antenna correctly.  
(☞ page 9)

### Others

#### ■ It is not possible to switch audio or subtitles between languages.

- The disc does not contain 2 or more languages.  
→ If only a single language is recorded on the disc, switching to another language is impossible. (☞ page 25)

#### ■ No subtitle is displayed.

- The disc does not contain any subtitles.  
→ A DVD VIDEO without subtitles cannot display any subtitles.
- The subtitle language is set to "OFF".  
→ Specify a language. (☞ page 30)
- Before or after A point or B point in A-B Repeat Playback, no subtitle may be displayed.

#### ■ The disc cannot be ejected.

- Tray Lock is set.  
→ ☞ page 36

#### ■ "TRAY Err" is displayed on the display window.

- The tray is not open fully due to an obstacle.  
→ Close the tray and remove the obstacle.

#### ■ "LR ONLY" is displayed on the display window (for a DVD AUDIO).

- Because, for the track being played back, down mix is inhibited for multi-channel sound, the sound of L and R is output directly (a normal action).

### If the system does not work properly despite correction measures above

Many functions of this system are implemented by microcomputers. If pressing any button does not result in the normal action, disconnect the power plug from the outlet, wait for a while, and reconnect the system.

## Language codes

| Code | Language         | Code | Language       |
|------|------------------|------|----------------|
| AA   | Afar             | MK   | Macedonian     |
| AB   | Abkhazian        | ML   | Malayalam      |
| AF   | Afrikaans        | MN   | Mongolian      |
| AM   | Ameharic         | MO   | Moldavian      |
| AR   | Arabic           | MR   | Marathi        |
| AS   | Assamese         | MS   | Malay (MAY)    |
| AY   | Aymara           | MT   | Maltese        |
| AZ   | Azerbaijani      | MY   | Burmese        |
| BA   | Bashkir          | NA   | Nauru          |
| BE   | Byelorussian     | NE   | Nepali         |
| BG   | Bulgarian        | NL   | Dutch          |
| BH   | Bihari           | NO   | Norwegian      |
| BI   | Bislama          | OC   | Occitan        |
| BN   | Bengali, Bangla  | OM   | (Afan) Oromo   |
| BO   | Tibetan          | OR   | Oriya          |
| BR   | Breton           | PA   | Panjabi        |
| CA   | Catalan          | PL   | Polish         |
| CO   | Corsican         | PS   | Pashto, Pushto |
| CS   | Czech            | PT   | Portuguese     |
| CY   | Welsh            | QU   | Quechua        |
| DA   | Danish           | RM   | Rhaeto-Romance |
| DZ   | Bhutani          | RN   | Kirundi        |
| EL   | Greek            | RO   | Rumanian       |
| EO   | Esperanto        | RU   | Russian        |
| ET   | Estonian         | RW   | Kinyarwanda    |
| EU   | Basque           | SA   | Sanskrit       |
| FA   | Persian          | SD   | Sindhi         |
| FI   | Finnish          | SG   | Sangho         |
| FJ   | Fiji             | SH   | Serbo-Croatian |
| FO   | Faroese          | SI   | Singhalese     |
| FY   | Frisian          | SK   | Slovak         |
| GA   | Irish            | SL   | Slovenian      |
| GD   | Scots Gaelic     | SM   | Samoan         |
| GL   | Galician         | SN   | Shona          |
| GN   | Guarani          | SO   | Somali         |
| GU   | Gujarati         | SQ   | Albanian       |
| HA   | Hausa            | SR   | Serbian        |
| HI   | Hindi            | SS   | Siswati        |
| HR   | Croatian         | ST   | Sesotho        |
| HU   | Hungarian        | SU   | Sundanese      |
| HY   | Armenian         | SV   | Swedish        |
| IA   | Interlingua      | SW   | Swahili        |
| IE   | Interlingue      | TA   | Tamil          |
| IK   | Inupiak          | TE   | Telugu         |
| IN   | Indonesian       | TG   | Tajik          |
| IS   | Icelandic        | TH   | Thai           |
| IW   | Hebrew           | TI   | Tigrinya       |
| JI   | Yiddish          | TK   | Turkmen        |
| JW   | Javanese         | TL   | Tagalog        |
| KA   | Georgian         | TN   | Setswana       |
| KK   | Kazakh           | TO   | Tonga          |
| KL   | Greenlandic      | TR   | Turkish        |
| KM   | Cambodian        | TS   | Tsonga         |
| KN   | Kannada          | TT   | Tatar          |
| KO   | Korean (KOR)     | TW   | Twi            |
| KS   | Kashmiri         | UK   | Ukrainian      |
| KU   | Kurdish          | UR   | Urdu           |
| KY   | Kirghiz          | UZ   | Uzbek          |
| LA   | Latin            | VI   | Vietnamese     |
| LN   | Lingala          | VO   | Volapuk        |
| LO   | Laothian         | WO   | Wolof          |
| LT   | Lithuanian       | XH   | Xhosa          |
| LV   | Latvian, Lettish | YO   | Yoruba         |
| MG   | Malagasy         | ZU   | Zulu           |
| MI   | Maori            |      |                |

## General

|                                     |   |
|-------------------------------------|---|
| Power source:                       | AC 110 – 240 V $\sim$ ,<br>50 Hz/60 Hz    |
| Power consumption:                  | 24 W (in operation)<br>1.1 W (on standby) |
| Weight:                             | 3.0 kg                                    |
| External dimensions<br>(W × H × D): | 232 mm × 100 mm × 269 mm                  |

## DVD player

|                 |  |
|-----------------|--|
| Playable discs: | DVD VIDEO, DVD AUDIO, VCD,<br>Super VCD, CD, CD-R/RW (CD,<br>VCD, MP3, JPEG format), DVD-R/<br>RW (video format) |
|-----------------|--|

## Video output

|                        |  |
|------------------------|--|
| Color system:          | NTSC   |
| Horizontal resolution: | 500 lines  |
| Composite ×1:          | 1.0 V (p-p)/75 $\Omega$ ,<br>synchronization negative  |
| S-video ×1:            | Y output: 1.0 V (p-p)/75 $\Omega$ ,<br>synchronization negative<br>C output: 0.286 V (p-p)/75 $\Omega$ |
| Component ×1:          | Y output: 1.0 V (p-p)/75 $\Omega$<br>P <sub>B</sub> /P <sub>R</sub> output: 0.7 V (p-p)/75 $\Omega$    |

## Audio output

|                              |   |
|------------------------------|---|
| Analog sound output:         |   |
| Speakers ×2                  |   |
| Output power<br>(IEC 268-3): | 60 W (30 W + 30 W)<br>at 4 $\Omega$ (10% THD) |
| Fitting impedance:           | 4 $\Omega$ to 16 $\Omega$                     |
| Headphones ×1:               | 11 mW/32 $\Omega$                             |
| Fitting impedance:           | 16 $\Omega$ to 1 k $\Omega$                   |
| Subwoofer ×1:                | 500 mVrms/10 k $\Omega$                       |
| Digital sound output:        |   |
| Optical ×1:                  | –21 dBm to –15 dBm                            |

## Other output

|                                |
|--------------------------------|
| AV COMPU LINK ×2 ( $\phi$ 3.5) |
|--------------------------------|

## Audio input

|              |                      |
|--------------|----------------------|
| Sound input: | AUX × 1              |
| Level 1:     | 250 mV/50 k $\Omega$ |
| Level 2:     | 500 mV/50 k $\Omega$ |

## Tuner

|                      |   |
|----------------------|---|
| FM tuner:            |   |
| Receiving frequency: | 87.50 MHz to 108.00 MHz   |
| Antenna:             | 75 $\Omega$ - unbalanced type   |
| AM tuner:            |   |
| Receiving frequency: | 531 kHz to 1710 kHz<br>(at 9 kHz interval space)<br>530 kHz to 1710 kHz<br>(at 10 kHz interval space) |
| Antenna:             | External antenna jack (loop antenna)  |

## Speaker

|                          |  |
|--------------------------|--|
| Type:                    | 1-way bass-reflex type<br>Magnetically shielded type |
| Speaker:                 | 8 cm cone × 1  |
| Power handling capacity: | 30 W   |
| Impedance:               | 4 $\Omega$   |
| Sound pressure level:    | 81 dB/W·m  |
| Dimension (W × H × D):   | 120 mm × 161 mm × 239 mm                             |
| Weight (1 unit):         | 1.6 kg   |

Designs and Specifications are subject to change without notice.



## Free Manuals Download Website

<http://myh66.com>

<http://usermanuals.us>

<http://www.somanuals.com>

<http://www.4manuals.cc>

<http://www.manual-lib.com>

<http://www.404manual.com>

<http://www.luxmanual.com>

<http://aubethermostatmanual.com>

Golf course search by state

<http://golfingnear.com>

Email search by domain

<http://emailbydomain.com>

Auto manuals search

<http://auto.somanuals.com>

TV manuals search

<http://tv.somanuals.com>