

JVC

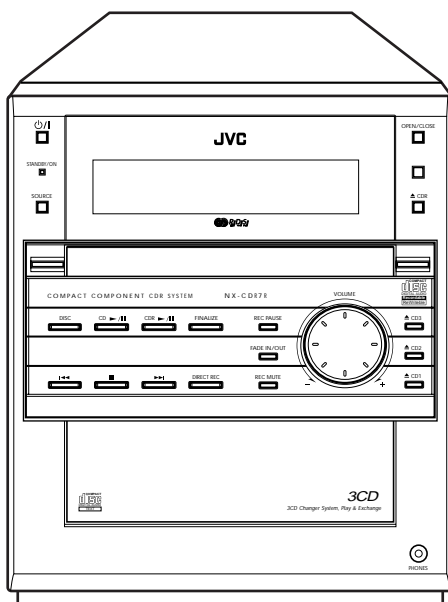

COMPACT COMPONENT CDR SYSTEM

CA-NXCDR7R

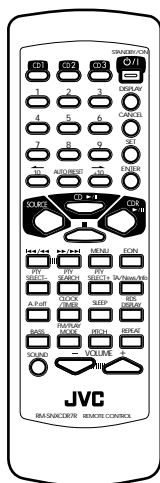

INSTRUCTIONS

For Customer Use:

Enter below the Model No. and Serial No. which are located either on the rear, bottom or side of the cabinet. Retain this information for future reference.

Model No. _____

Serial No. _____

LVT0749-003A

[B]

Warnings, Cautions and Others

IMPORTANT for the U.K.

DO NOT cut off the mains plug from this equipment. If the plug fitted is not suitable for the power points in your home or the cable is too short to reach a power point, then obtain an appropriate safety approved extension lead or consult your dealer.

BE SURE to replace the fuse only with an identical approved type, as originally fitted.

If nonetheless the mains plug is cut off ensure to remove the fuse and dispose of the plug immediately, to avoid a possible shock hazard by inadvertent connection to the mains supply.

If this product is not supplied fitted with a mains plug then follow the instructions given below:

IMPORTANT:

DO NOT make any connection to the terminal which is marked with the letter E or by the safety earth symbol or coloured green or green-and-yellow.

The wires in the mains lead on this product are coloured in accordance with the following code:

Blue : Neutral
Brown : Live

As these colours may not correspond with the coloured markings identifying the terminals in your plug proceed as follows:

The wire which is coloured blue must be connected to the terminal which is marked with the letter N or coloured black.

The wire which is coloured brown must be connected to the terminal which is marked with the letter L or coloured red.

IF IN DOUBT - CONSULT A COMPETENT ELECTRICIAN.

Caution — switch!

Disconnect the mains plug to shut the power off completely (the STANDBY/ON lamp goes off).

The  switch in any position does not disconnect the mains line.

- When the unit is on standby, the STANDBY/ON lamp lights red.
- When the unit is turned on, the STANDBY/ON lamp lights green.

The power can be remote controlled.

CAUTION

To reduce the risk of electrical shocks, fire, etc.:

1. Do not remove screws, covers or cabinet.
2. Do not expose this appliance to rain or moisture.

CAUTION

- Do not block the ventilation openings or holes.
(If the ventilation openings or holes are blocked by a newspaper or cloth, etc., the heat may not be able to get out.)
- Do not place any naked flame sources, such as lighted candles, on the apparatus.
- When discarding batteries, environmental problems must be considered and local rules or laws governing the disposal of these batteries must be followed strictly.
- Do not use this apparatus in a bathroom or places with water. Also do not place any containers filled with water or liquids (such as cosmetics or medicines, flower vases, potted plants, cups, etc.) on top of this apparatus.

Caution: Proper Ventilation

To avoid risk of electric shock and fire, and to prevent damage, locate the apparatus as follows:

1 Front:

No obstructions and open spacing.

2 Sides/ Top/ Back:

No obstructions should be placed in the areas shown by the dimensions below.

3 Bottom:

Place on the level surface. Maintain an adequate air path for ventilation by placing on a stand with a height of 10 cm or more.

Front view

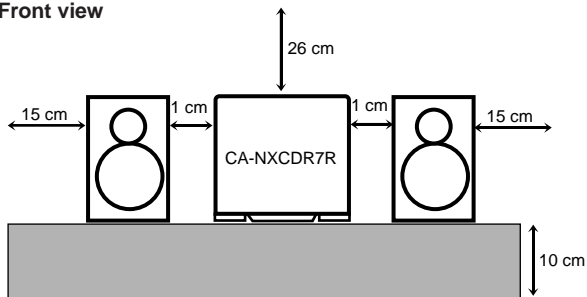

Side view

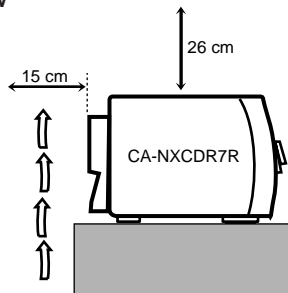

IMPORTANT FOR LASER PRODUCTS

REPRODUCTION OF LABELS

① CLASSIFICATION LABEL, PLACED ON REAR ENCLOSURE

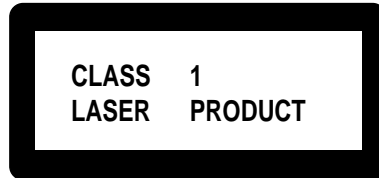

1. CLASS 1 LASER PRODUCT
2. **CAUTION:** Invisible laser radiation when open and interlock failed or defeated. Avoid direct exposure to beam.
3. **CAUTION:** Do not open the top cover. There are no user serviceable parts inside the Unit; leave all servicing to qualified service personnel.

② WARNING LABEL, PLACED INSIDE THE UNIT

CAUTION: Invisible laser radiation when open and interlock failed or defeated.
AVOID DIRECT EXPOSURE TO BEAM. (e)

ADVARSEL: Usynlig laserstråling ved åbning, når sikkerhedsafbrydere er ude af funktion. Undgåudsætelse for stråling (d)

WARNING: Osynlig laserstråling når denna del är öppen och spärren är urkopplad. Betrakta ej strålen. (s)

VARO: Avattaessa ja suojalukitus ohitettaessa olet alltiina näkymättömälle lasersäteilylle. Älä katso säteeseen. (f)

SAFETY INSTRUCTIONS

“SOME DOS AND DON'TS ON THE SAFE USE OF EQUIPMENT”

This equipment has been designed and manufactured to meet international safety standards but, like any electrical equipment, care must be taken if you are to obtain the best results and safety is to be assured.

Do read the operating instructions before you attempt to use the equipment.

Do ensure that all electrical connections (including the mains plug, extension leads and interconnections between pieces of equipment) are properly made and in accordance with the manufacturer's instructions. Switch off and withdraw the mains plug when making or changing connections.

Do consult your dealer if you are ever in doubt about the installation, operation or safety of your equipment.

Do be careful with glass panels or doors on equipment.

DON'T continue to operate the equipment if you are in any doubt about it working normally, or if it is damaged in any way – switch off, withdraw the mains plug and consult your dealer.

DON'T remove any fixed cover as this may expose dangerous voltages.

DON'T leave equipment switched on when it is unattended unless it is specifically stated that it is designed for unattended operation or has a standby mode.

Switch off using the switch on the equipment and make sure that your family know how to do this.

Special arrangements may need to be made for infirm or handicapped people.

DON'T use equipment such as personal stereos or radios so that you are distracted from the requirements of traffic safety. It is illegal to watch television whilst driving.

DON'T listen to headphones at high volume as such use can permanently damage your hearing.

DON'T obstruct the ventilation of the equipment, for example with curtains or soft furnishings.

Overheating will cause damage and shorten the life of the equipment.

DON'T use makeshift stands and NEVER fix legs with wood screws — to ensure complete safety always fit the manufacturer's approved stand or legs with the fixings provided according to the instructions.

DON'T allow electrical equipment to be exposed to rain or moisture.

ABOVE ALL

- NEVER let anyone, especially children, push anything into holes, slots or any other opening in the case — this could result in a fatal electrical shock.
- NEVER guess or take chances with electrical equipment of any kind — it is better to be safe than sorry!

Contents



Introduction	2	Playing Back a Disc on CD Recorder	29
About This Manual	2	Playing Back a Disc—Normal Play	30
Precautions	2	Basic Disc Operations	30
Precautions on Disc Playback and Recording	3	Repeating Tracks—Repeat Play	30
Location of the Buttons and Controls	4	Recording on a CD-R/CD-RW	31
Remote Control	4	Before You Start Recording	32
Main Unit	5	Recording Any Sound Source	
Display Window	6	—Standard Recording	34
Getting Started	8	Recording from 3-CD Changer	
Unpacking	8	—CD Synchronized Recording	36
Connecting Antennas	8	• CD Direct Recording	36
Connecting Speakers	9	• First Track Recording	38
Connecting Other Components	10	• Listening Edit Recording	39
Putting the Batteries into the Remote Control	12	Recording the External Components	
Basic and Common Operations	13	—Sound Synchronized Recording	40
Turning On the Power	14	Recording a Single Track during Play	41
Saving the Power Consumption while		Finalizing a Disc—CD-R/CD-RW	41
On Standby	14	Other Convenient CDR Functions	42
Selecting the Sources and Starting Play	14	Recording Track Marks Manually	
Adjusting the Volume	15	—Manual Track-Marking	43
Changing the Display Information	15	Separating Recorded Tracks Automatically	
Reinforcing the Bass Sound	15	—Auto-Track Space	44
Selecting the Sound Modes	16	Turning On or Off Sampling Frequency Rate	
Creating Your Own Sound Modes		Converter	44
—MANUAL Modes	16	Recording Skip Marks onto a CD-R/CD-RW	45
Listening to FM and AM (MW/LW)		Erasing Tracks (Only for CD-RW)	45
Broadcasts	17	Erasing All Tracks (Only for CD-RW)	46
Tuning into a Station	18	Unfinalizing a Disc (Only for CD-RW)	46
Presetting Stations	18	Using the Timers	47
Tuning into a Preset Station	19	Setting the Clock	48
Receiving FM Stations with RDS	19	Using Recording Timer	48
Changing the RDS Information	20	Using Daily Timer	50
Searching for Programs by PTY Codes		Using Sleep Timer	52
(PTY Search)	20	Using Auto Power Off	52
Switching to a Program of Your Choice		Maintenance	53
Automatically	21	Glossary	54
• How the EON function actually works	21	Messages	55
• Description of the PTY codes	22	Troubleshooting	56
Playing Back Discs on 3-CD Changer	23	Specifications	57
Loading Discs	24		
Playing Back the Entire Discs			
—Continuous Play	24		
Basic Disc Operations	25		
Programing the Playing Order of the Tracks			
—Program Play	25		
Playing at Random—Random Play	26		
Repeating Tracks or Discs—Repeat Play	27		
Other Convenient Functions	27		

We would like to thank you for purchasing one of our JVC products. Before operating this unit, read this manual carefully and thoroughly to obtain the best possible performance from your unit, and retain this manual for future reference.

About This Manual

This manual is organized as follows:

- **This manual mainly explains playback operations using the remote control, and the other operation such as recording and editing operations using the buttons and controls on the unit. You can use the buttons and controls both on the remote control and on the unit for the same operations if they have the same or similar names (or marks), unless mentioned otherwise.**
- Basic and common information that is the same for many functions is grouped in one place, and is not repeated in each procedure. For instance, we do not repeat the information about turning on/off the unit, setting the volume, changing the sound effects, and others, which are explained in the section “Basic and Common Operations” on pages 13 – 16.
- The following marks are used in this manual:

	<p>Gives you warning and caution to prevent from damage or risk of fire/electric shock. Furthermore, gives you information which is not good for obtaining the best possible performance from the unit.</p>
	<p>Gives you information and hints you had better know.</p>

Precautions

Installation

- Install in a place which is level, dry and neither too hot nor too cold—between 5°C (41°F) and 35°C (95°F).
- Install the unit in a location with adequate ventilation to prevent internal heat buildup in the unit.
- Leave sufficient distance between the unit and the TV.
- Keep the speakers away from the TV to avoid interference with TV.



DO NOT install the unit in a location near heat sources, or in a place subject to direct sunlight, excessive dust or vibration.

Power sources

- When unplugging the unit from the wall outlet, always pull the plug, not the AC power cord.



DO NOT handle the AC power cord with wet hands.

Moisture condensation

Moisture may condense on the lens inside the unit in the following cases:

- After starting heating in the room
 - In a damp room
 - If the unit is brought directly from a cold to a warm place
- Should this occur, the unit may malfunction. In this case, leave the unit turned on for a few hours until the moisture evaporates, unplug the AC power cord, then plug it in again.

Others

- Should any metallic object or liquid fall into the unit, unplug the AC power cord and consult your dealer before operating any further.
- If you are not going to operate the unit for an extended period of time, unplug the AC power cord from the wall outlet.



DO NOT disassemble the unit since there are no user serviceable parts inside.

If anything goes wrong, unplug the AC power cord and consult your dealer.

Precautions on Disc Playback and Recording

Playback

This unit has been designed to play back discs bearing the following logos:



CD ReWritable (CD-RW)



CD Recordable (CD-R)



Audio CD



CD Text
(Text information can be shown only when playing on 3-CD Changer.)

In addition to the above discs, this unit can play back audio data recorded on CD-G (CD Graphics) and CD-Extra.

Notes on playing a CD-R or CD-RW:

- The built-in CD Recorder can play back both finalized and unfinalized CD-Rs/CD-RWs.
- The built-in 3-CD Changer can also play back both finalized and unfinalized CD-Rs/CD-RWs. **However, some unfinalized discs cannot be played back because of their disc characteristics.**
- Either on 3-CD Changer or on CD Recorder, you can play back CD-Rs or CD-RWs recorded on a personal computer only if they have been recorded in the CD audio format.
- Neither on 3-CD Changer nor on CD Recorder, you can play back MP3 discs.
- Some CD-Rs and CD-RWs may not be played back either on 3-CD Changer or on CD Recorder because of their disc characteristics, damage or stains.

Important notice:

- Continuous use of irregular-shaped discs (heart-shape, octagonal, etc.) can damage the disc rotating mechanism.

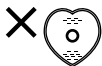

- CD-RWs may require a longer readout time. This is caused by the fact that the reflectance of CD-RWs is lower than for regular CDs.

Recording

This unit has been designed to record on the discs bearing the following logos:



CD ReWritable (CD-RW)



CD Recordable (CD-R)

In addition to the logos shown above, the words shown below or their equivalent should also be indicated somewhere on the package or accompanying documentation.

- **FOR CONSUMER**
- **FOR CONSUMER USE**
- **FOR MUSIC USE ONLY**

The following discs cannot be used for recording:

- **Discs bearing logos other than the above.**
- **Discs intended for professional use.**
- **Discs intended for recording computer data.**

Important notice:

- The manufacturer assumes no liability whatsoever for any damage resulting from missed opportunity or accidental erasure that occurs while conducting recording or playback operations due to malfunctioning of or trouble in the unit, or for any incidental damage.
- Before recording on a CD-R, it is recommended to make a test recording using a CD-RW.
- If PCA (Power Calibration Area) or PMA (Program Memory Area) of the disc is recorded fully, recording cannot be performed on this disc even though there are still unused memory spaces on the disc.



- DO NOT subject the unit to any shock or vibration while recording.
- DO NOT use a dusty or scratched CD-R/CD-RW for recording; otherwise, you cannot obtain the satisfactory recording quality.

It should be noted that it may be unlawful to re-record pre-recorded tapes, records, or discs without the consent of the owner of copyright in the sound or video recording, broadcast or cable programme and in any literary, dramatic, musical, or artistic embodied therein.

Location of the Buttons and Controls

Become familiar with the buttons and controls on your unit.

Remote Control

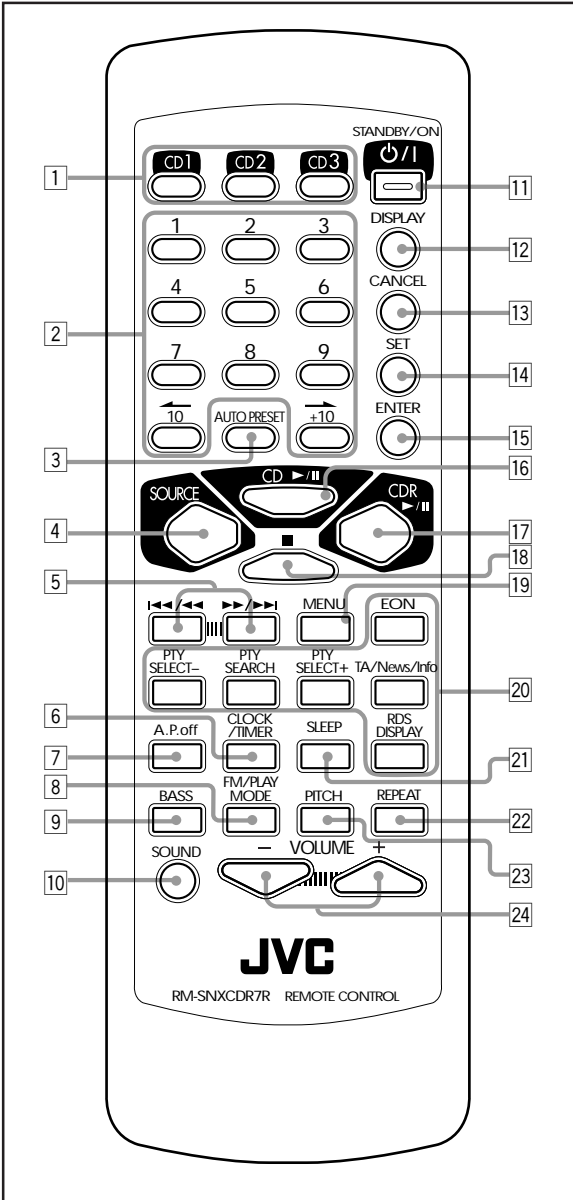

See pages in the parentheses for details.

Remote Control

- 1 Disc number buttons (24, 25)
 - CD1, CD2, and CD3
 - *Pressing one of these buttons also turns on the unit.*
- 2 Number buttons
 - 1 – 10, +10 buttons (19, 25, 30)
 - ← / → buttons (16)
- 3 AUTO PRESET button (18)
- 4 SOURCE button (14, 18)
 - *Pressing this button also turns on the unit.*
- 5 ◀◀ / ◀◀ (reverse search/fast-reverse) button (16, 18, 25, 26, 28, 30, 43 – 45, 48 – 51)
 - ▶▶ / ▶▶ (fast-forward/forward search) button (16, 18, 25, 26, 28, 30, 43 – 45, 48 – 51)
- 6 CLOCK/TIMER button (48 – 51)
- 7 A.P.off (auto power off) button (52)
- 8 FM/PLAY MODE button (18, 25, 26)
- 9 BASS button (15)
- 10 SOUND button (16)
- 11 ⏻/⏻ (STANDBY/ON) button (14)
- 12 DISPLAY button (14, 15, 28, 35)
- 13 CANCEL button (26, 43, 48 – 51)
- 14 SET button (14, 16, 19, 48 – 51)
- 15 ENTER button (43 – 46)
- 16 CD ▶ / ⏻ (play/pause) button (14, 24)
 - *Pressing this button also turns on the unit.*
- 17 CDR ▶ / ⏻ (play/pause) button (14, 30)
 - *Pressing this button also turns on the unit.*
- 18 ■ (stop) button (14, 24, 30, 34)
- 19 MENU button (43)
- 20 RDS operation buttons (20 – 22)
 - PTY SELECT + / –, PTY SEARCH, EON, TA/News/Info, and RDS DISPLAY buttons
- 21 SLEEP button (52)
- 22 REPEAT button (27, 30)
- 23 PITCH button (28)
- 24 VOLUME + / – buttons (15)

Main Unit

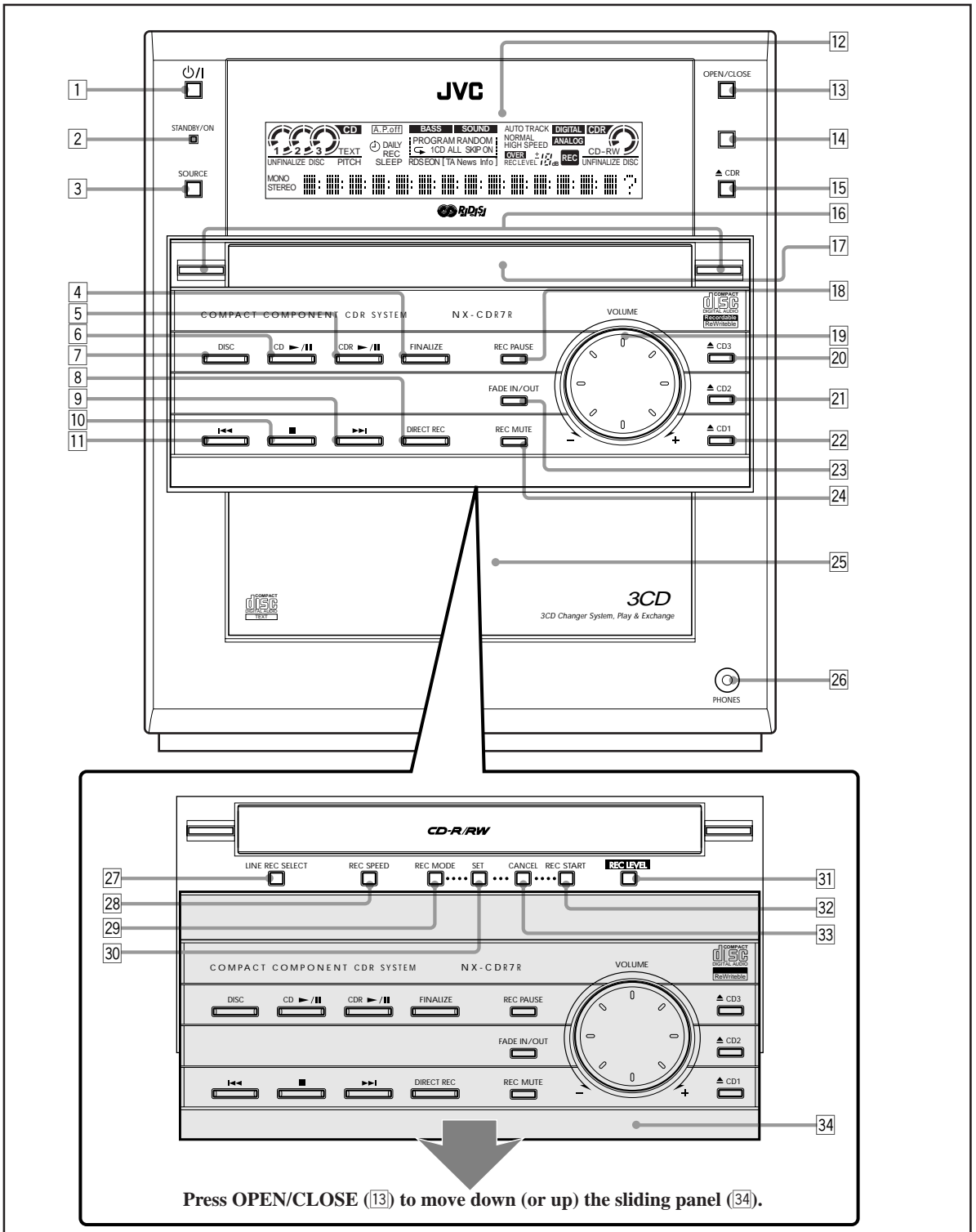

Main Unit

- 1 O/I (Standby/On) button (14)
- 2 STANDBY/ON lamp (14)
- 3 SOURCE button (14, 18)
 - Pressing this button also turns on the unit.
- 4 FINALIZE button (34, 41)
- 5 CDR \blacktriangleright / \parallel (play/pause) button (14, 30, 34)
 - Pressing this button also turns on the unit.
- 6 CD \blacktriangleright / \parallel (play/pause) button (14, 24)
 - Pressing this button also turns on the unit.
- 7 DISC button (24, 25, 27)
- 8 DIRECT REC button (36)
- 9 $\blacktriangleright\blacktriangleright$ (forward skip) button (18, 25, 30, 43 – 45)
- 10 \blacksquare (stop) button (14, 24, 28, 30, 34)
- 11 $\blacktriangleleft\blacktriangleleft$ (reverse skip) button (18, 25, 30, 43 – 45)
- 12 Display window
- 13 OPEN/CLOSE button
 - Pressing this button also turns on the unit.
- 14 Remote sensor
- 15 \blacktriangle (open/close) CDR button (30, 34)
 - Pressing this button also turns on the unit.

- 16 CDR lamps (14, 30)
- 17 CDR disc tray
- 18 REC PAUSE button (28, 34)
- 19 VOLUME control (15, 35)
- 20 \blacktriangle (open/close) CD3 button (24)
 - Pressing this button also turns on the unit.
- 21 \blacktriangle (open/close) CD2 button (24)
 - Pressing this button also turns on the unit.
- 22 \blacktriangle (open/close) CD1 button (24)
 - Pressing this button also turns on the unit.
- 23 FADE IN/OUT button (34)
- 24 REC MUTE button (35)
- 25 Disc tray compartment—CD1, CD2, and CD3
- 26 PHONES jack—stereo mini type (15)
- 27 LINE REC SELECT button (34)
- 28 REC SPEED button (36 – 39)
- 29 REC MODE button (37 – 41)
- 30 SET button (14, 39, 43 – 46)
- 31 REC LEVEL button (35)
- 32 REC START button (37 – 41)
- 33 CANCEL button (26, 39, 43)
- 34 Sliding panel

Display Window

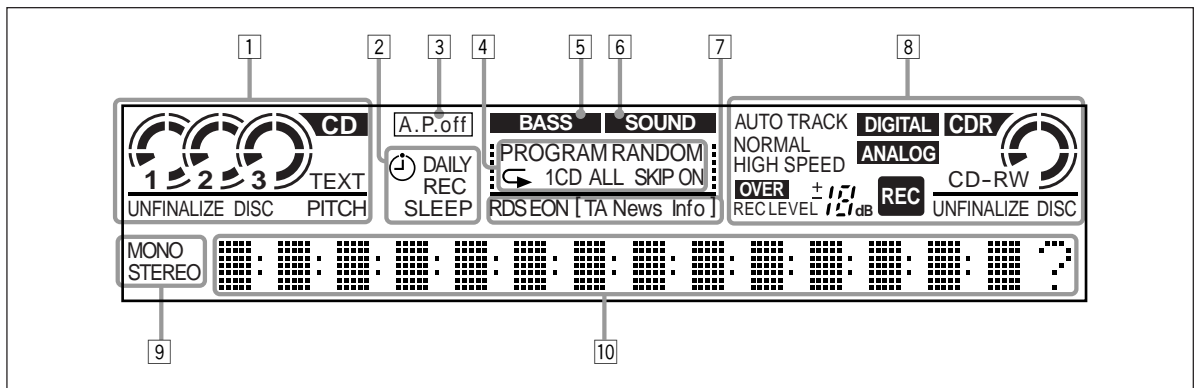

Display Window

- 1 CD indicators

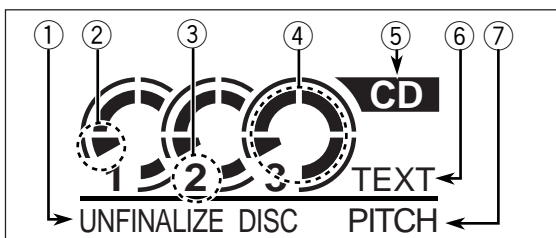

- 1 UNFINALIZE DISC indicator: lights when an unfinalized disc is loaded.
- 2 Current disc indicator: indicates the currently selected disc.

- 3 Disc number indicator
- 4 Disc loading indicator
 - Flashes while the corresponding disc is playing or pausing.
 - Goes off (except numbers) when the unit has detected that there is no CD on the corresponding disc tray.
 - Lights while a disc is loaded and detected.
- 5 CD source indicator: lights when 3-CD Changer is selected as the playback source.
- 6 TEXT indicator (28)
- 7 PITCH indicator (28)

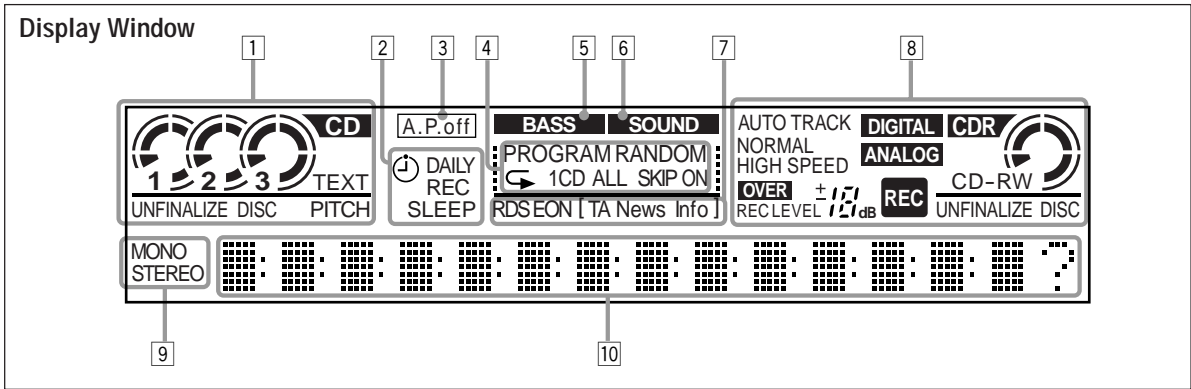

2 Timer mode indicators (48 – 52)



- ⑧ ⌚ (Timer) indicator (48)
- ⑨ DAILY (Daily Timer) indicator (50)
- ⑩ REC (Recording Timer) indicator (48)
- ⑪ SLEEP (Sleep Timer) indicator (52)

- ③ A.P.off (Auto Power off) indicator (52)
- ④ CD/CDR play mode indicators (25 – 27, 45)
 - PROGRAM, RANDOM, and ↺ (repeat)—1/CD/ALL, and SKIP ON indicators
- ⑤ BASS indicator (15)
- ⑥ SOUND indicator (16)
- ⑦ RDS operation indicators (19 – 21)
 - RDS, EON, and TA/News/Info indicators

8 CDR and recording mode indicators

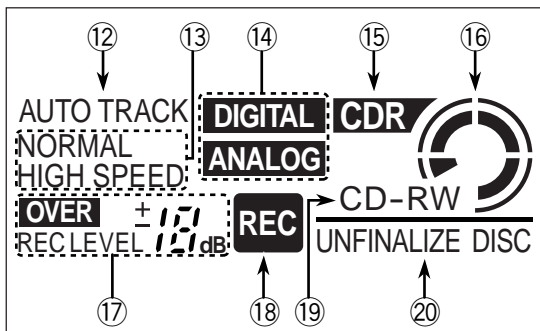

- ⑫ AUTO TRACK indicator (32)
- ⑬ Recording speed indicator (NORMAL SPEED/HIGH SPEED)

- ⑭ Recording source (input) indicator
 - DIGITAL lights while digital recording is performed.
 - ANALOG lights while analog recording is performed.
- ⑮ CDR source indicator: lights when the CD Recorder is selected as the playback source.
- ⑯ Disc indicator: lights when a disc is loaded on the CDR disc tray.
- ⑰ REC LEVEL indicator
 - OVER lights when the input level is too high.
- ⑱ REC (recording) indicator
 - Flashes while in recording pause.
 - Lights while recording.
- ⑲ Disc type indicators (CD, CD-R, CD-RW)
- ⑳ UNFINALIZE DISC indicator: lights when an unfinalized disc is loaded.
- ⑨ Tuner mode indicators (18)
 - MONO and STEREO indicators
- ⑩ Main display
 - Shows the source name, track number, and other information.

Getting Started

Unpacking

After unpacking, check to be sure that you have all the following items.

The numbers in the parentheses indicate the quantity of the pieces supplied.

- AM (MW/LW) loop antenna (1)
- FM antenna (1)
- Remote control (1)
- Batteries (2)

If any item is missing, consult your dealer immediately.

Connecting Antennas

FM antenna

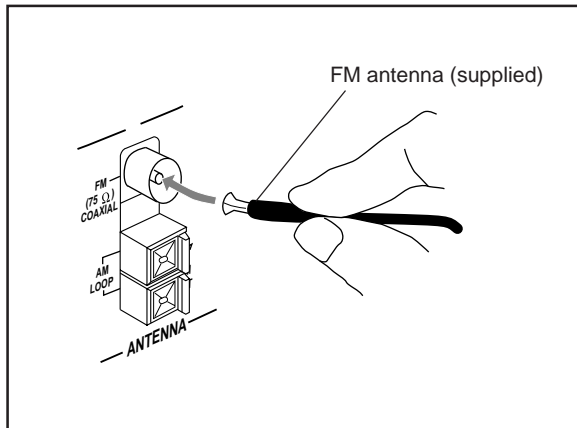

- 1 Attach the FM antenna to the FM (75 Ω) COAXIAL terminal.**
- 2 Extend the FM antenna.**
- 3 Fasten it up in the position which gives you the best reception.**



About the supplied FM antenna

The FM antenna supplied with this unit can be used as temporary measure. If reception is poor, you can connect an outdoor FM antenna.

To connect an outdoor FM antenna

Before connecting it, disconnect the supplied FM antenna.

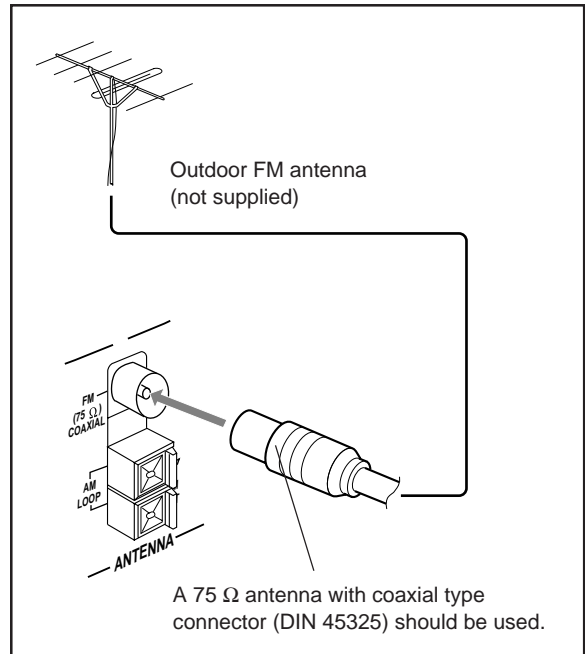

AM (MW/LW) antenna

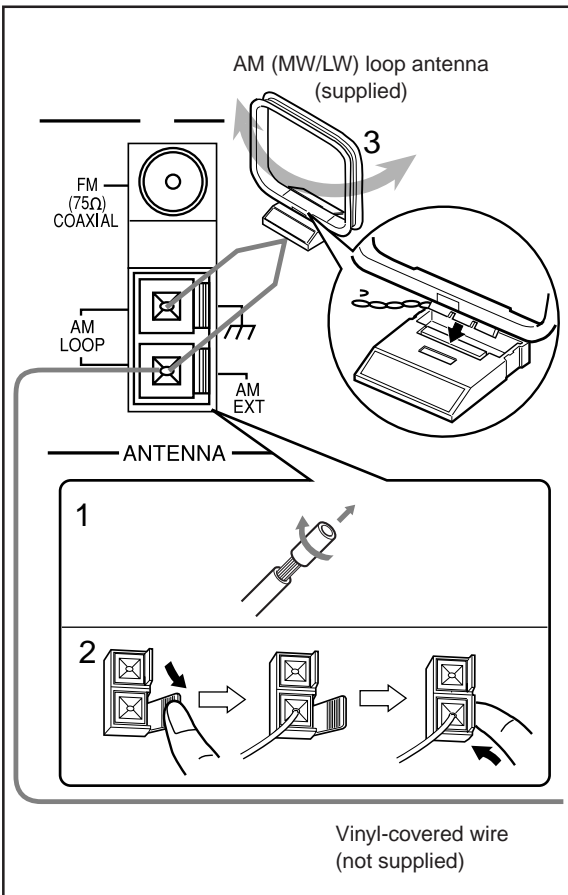

- 1 If cords are covered with insulation, twist the core of the cord at the end of each cord, then remove the insulation.
- 2 Connect the AM (MW/LW) loop antenna to the AM LOOP terminals as illustrated.
- 3 Turn the AM (MW/LW) loop antenna until you have the best reception.

To connect an outdoor AM (MW/LW) antenna

When reception is poor, connect a single vinyl-covered wire to the AM EXT terminal and extend it horizontally. Keep the AM (MW/LW) loop antenna connected.



For better reception of both FM and AM (MW/LW)

- Make sure the antenna conductors do not touch any other terminals and connecting cords.
- Keep the antennas away from metallic parts of the unit, connecting cords, and the AC power cord.

Connecting Speakers

You can connect the speakers using the speaker cords.

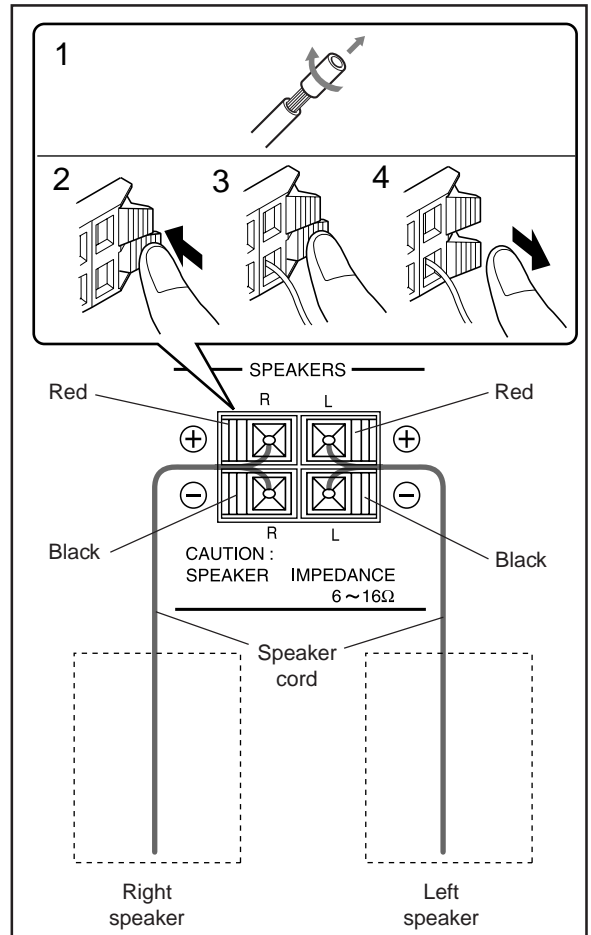

- 1 If cords are covered with insulation, twist the core of the cord at the end of each cord, then remove the insulation.
- 2 Hold the clamp of the speaker terminal.
- 3 Insert the end of the speaker cord to the terminal. Match the polarity of the speaker terminals: Red (+) to red (+) and black (-) to black (-).
- 4 Release the finger from the clamp.

Use only speakers with the same speaker impedance as indicated by the speaker terminals on the rear of the unit.

Connecting Other Components

When you connect and use other components, refer also to the manuals supplied with them.



- DO NOT connect other components while the power is on.
- DO NOT plug in any component until all connections are complete.

To connect an analog component such as a cassette deck

Be sure that the plugs of the audio cords and the jacks on the rear of the unit are color-coded: White plugs and jacks are for left audio signals, and red ones for right audio signals.

You can enjoy playback and recording on the other connected component.

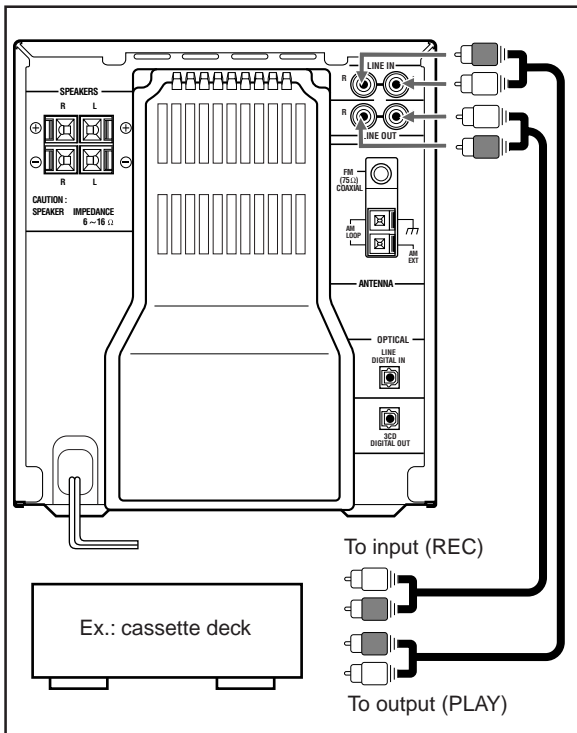

By using audio cords (not supplied), connect:

- Between the audio input jacks on the cassette deck and the LINE OUT jacks.
- Between the audio output jacks on the cassette deck and the LINE IN jacks.

To connect digital components

- When connecting a digital component equipped with an optical digital output terminal

The following connection allows you to perform digital-to-digital recording (through the digital terminals) and playback of the connected digital component (through the analog terminals.)

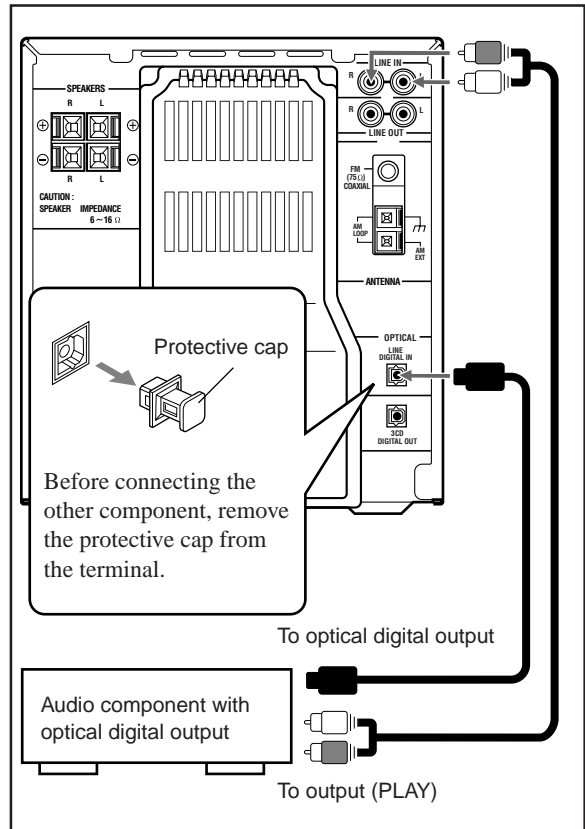

By using an optical digital cord (not supplied) and an audio cord (not supplied), connect:

- Between the optical digital output terminal on the other component and the LINE DIGITAL IN terminal.
- Between the audio output jacks on the other component and the LINE IN jacks. (This connection is required to play back sounds through this unit when the source is "LINE.")

The digital connection through the LINE DIGITAL IN terminal can be only used for recording.

- When connecting a digital component to this unit, always connect it both the LINE DIGITAL IN terminal and the LINE IN jacks.

- **When connecting a digital component equipped with an optical digital input terminal**

You can record playback sounds of 3-CD Changer onto the other component—digital-to-digital recording.

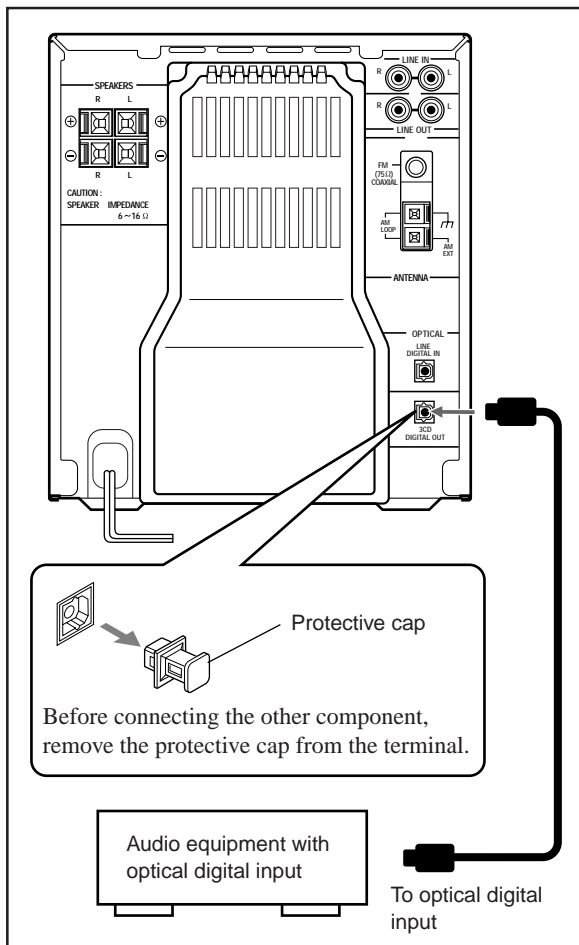

NOW, you can plug in the unit and other connected components FINALLY!

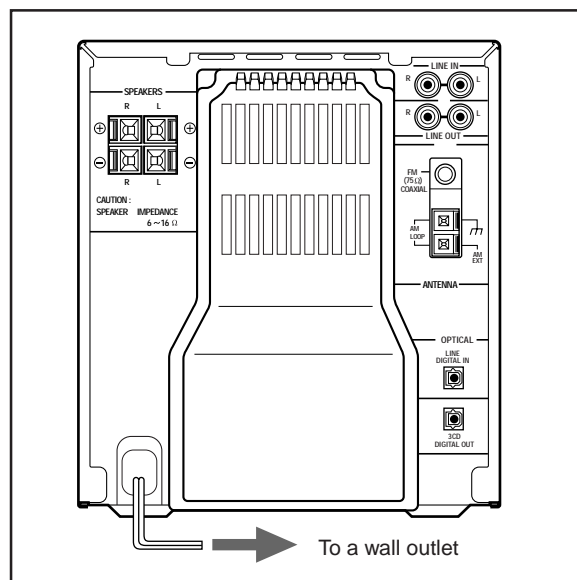

Connect between the optical digital input terminal on the other component and the 3CD DIGITAL OUT terminal.

Putting the Batteries into the Remote Control

Insert the batteries—R6(UM-3)/AA(15F)—into the remote control, by matching the polarity (+ and -) on the batteries with the + and - markings on the battery compartment. When the remote control can no longer operate the unit, replace both batteries at the same time.



- DO NOT use an old battery together with a new one.
- DO NOT use different types of batteries together.
- DO NOT expose batteries to heat or flame.
- DO NOT leave the batteries in the battery compartment when you are not going to use the remote control for an extended period of time. Otherwise, it will be damaged from battery leakage.

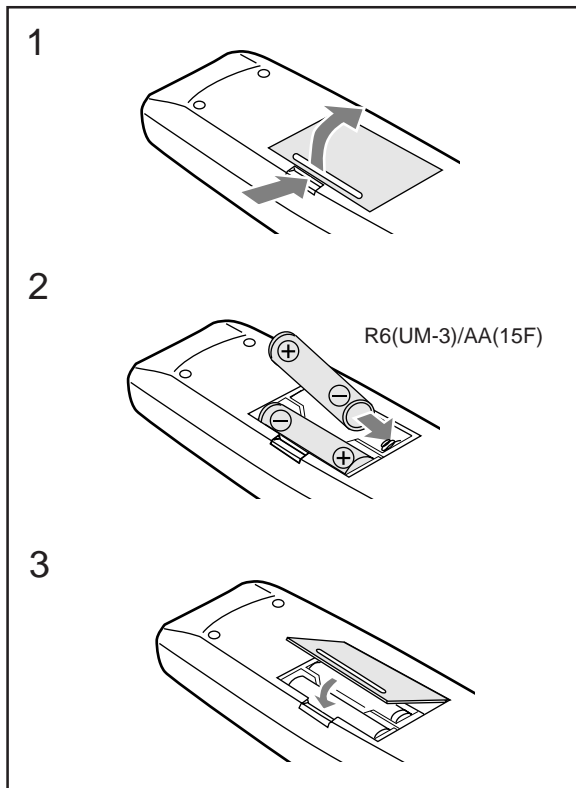

When using the remote control, point it at the remote sensor on the front panel.

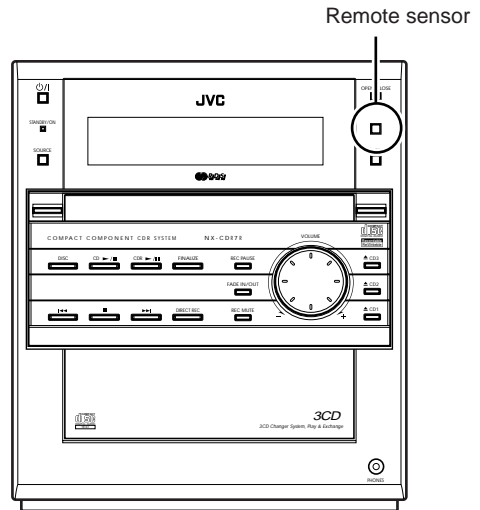

Basic and Common Operations

The buttons and controls enlarged in the illustration below are used and explained in this section (pages 14 to 16).

Remote control

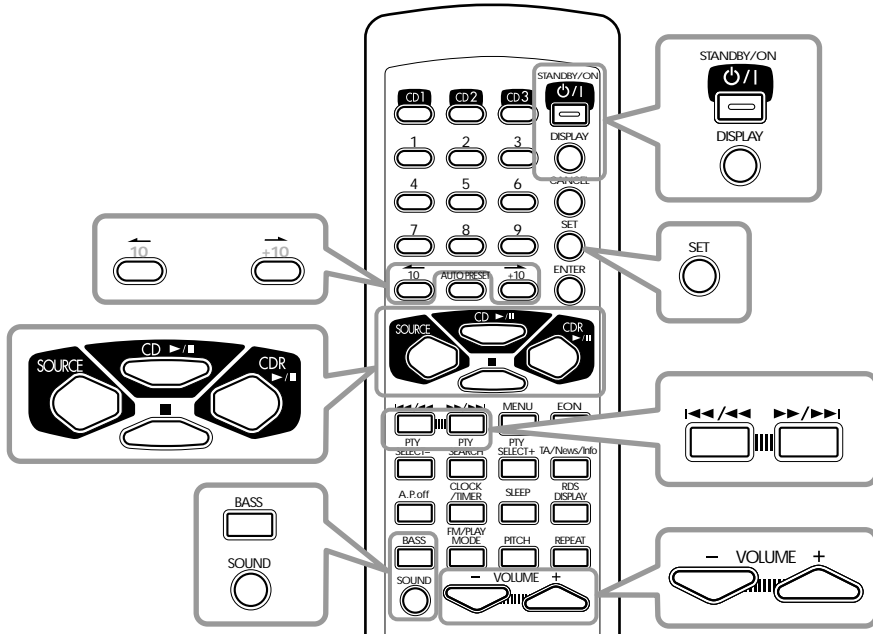

Main unit

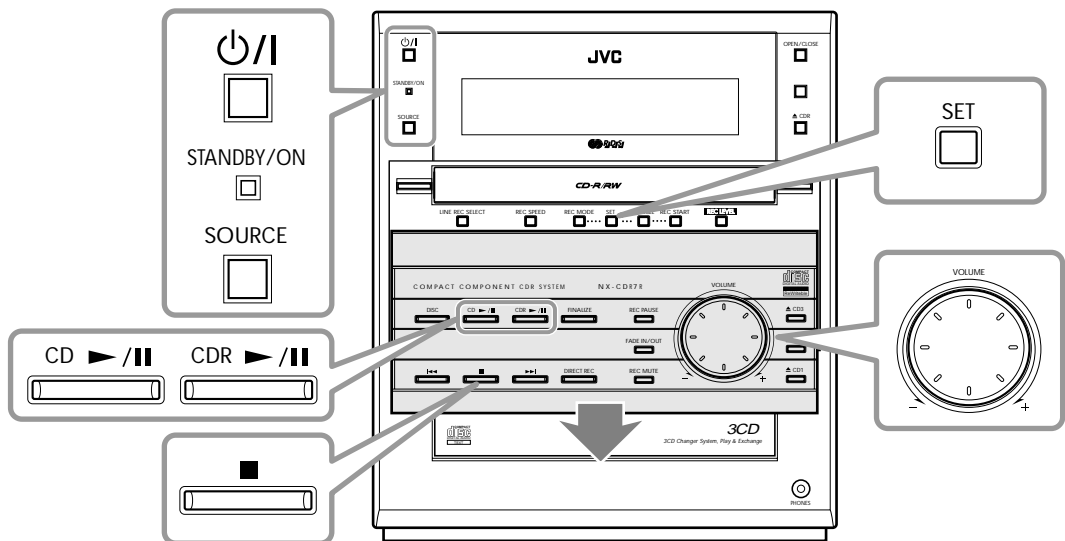

Press OPEN/CLOSE to move down (or up) the sliding panel.

Before operating the unit any further, first set the clock built in this unit (see page 48).

Turning On the Power

To turn on the unit without playing, press $\odot/|$ so that the STANDBY/ON lamp on the unit lights green, and the CDR lamps light.

HELLO

To turn off the unit (on standby), press $\odot/|$ again so that the STANDBY/ON lamp lights red, and the CDR lamps go off.

SEE YOU

- When the power is off (on standby), clock time appears in the main display—initial setting when shipped from the factory (see “Saving the Power Consumption while On Standby” below).
- A little power is always consumed even while the unit is in standby mode.

To switch off the power supply completely, unplug the AC power cord from the AC outlet.

Saving the Power Consumption while On Standby

You can save the power consumption while the unit is turned off by erasing the clock display.

To save the power consumption while on standby, press DISPLAY on the remote control while the unit is turned off (on standby—while the STANDBY/ON lamp lights red).

DISPLAY OFF

- Power consumption during standby is reduced (see “Specifications” on page 57) and the clock will not be shown while the unit is turned off (on standby).

To cancel the power consumption saving mode, press DISPLAY again while the unit is turned off (on standby).

DISPLAY ON



When you unplug the AC power cord or if a power failure occurs

The power consumption saving mode (“DISPLAY OFF”) will be canceled.

Selecting the Sources and Starting Play

To select 3-CD Changer as the source, press CD \blacktriangleright / \parallel . The unit automatically turns on. (Play starts if a CD is on the last selected disc tray.)

To stop play, press \blacksquare .

- For more detailed operations, see pages 23 to 28.

To select CD Recorder as the source, press CDR \blacktriangleright / \parallel . The unit automatically turns on. (Play starts if a disc is in CD Recorder.)

To stop play, press \blacksquare .

- For more detailed operations, see pages 29 and 30.

To select the tuner and external component as the source, press SOURCE. The unit automatically turns on.

- Each time you press the button, the source changes as follows:

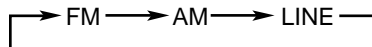

FM: To listen to an FM broadcast.

AM: To listen to an AM (MW/LW) broadcast.

LINE: To play back the external component connected to the LINE IN jacks on the rear panel.

- For operating FM/AM (MW/LW), pages 17 to 22.
- For operating the external components, refer to its manual.

To adjust the input level through the LINE IN jacks

If the sound from the component connected to the LINE IN jacks is too loud or is not loud enough when changing the source to “LINE” from another source (without adjusting the volume level), you can change the input level through the LINE IN jacks.

On the unit ONLY:

When the source is “LINE,” press and hold SET (inside the sliding panel) repeatedly to select your desired level.

- Each time you press and hold the button, the input level changes—“LEVEL 1,” “LEVEL 2,” and “LEVEL 3.”

LEVEL 1: Normally select this. (Initial setting when shipped from the factory.)

LEVEL 2: Select this when the sound is not loud enough.

LEVEL 3: Select this when the sound is too loud.

Adjusting the Volume

You can adjust the volume level only while the unit is turned on.

When using the remote control, press **VOLUME +** to increase the volume or press **VOLUME -** to decrease it.

When using the unit, turn **VOLUME** clockwise to increase the volume or counterclockwise to decrease it.



Ex.: When setting the volume level to "20"



For private listening

Connect a pair of headphones to the PHONES jack. No sound comes out of the speakers. Be sure to turn down the volume before connecting or putting on the headphones.



If "CANNOT LISTEN" appears in the main display

During high-speed recording (see page 33), you cannot listen to any source, and therefore, cannot adjust the volume level.



For adjusting the recording level

Normally, the **VOLUME** control and **VOLUME +/-** buttons work to adjust the playback sound volume.

If you want to adjust the recording level, see "To adjust the recording input level" on page 35.



DO NOT turn off (on standby) the unit with the volume set to an extremely high level; otherwise, the sudden blast of sound can damage your hearing, speakers and/or headphones when you turn on the unit or start playing any source. REMEMBER you cannot adjust the volume level while the unit is in standby mode.

Changing the Display Information

You can change the information in the main display.

- For display information while recording, see "To change the display information while recording" on page 35.

On the remote control ONLY:

Press **DISPLAY** repeatedly.

- Each time you press the button, the information in the main display changes as follows:

When the source is CD Recorder:

- Before playing—

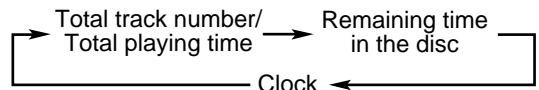

- While playing—

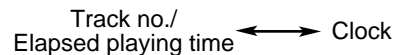

When the source is other than CD Recorder:

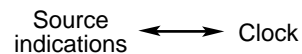

When the current playback source is a CD Text in 3-CD Changer

See "To show the text information recorded on a CD Text" on page 28.

Reinforcing the Bass Sound

The richness and fullness of the bass sound is maintained regardless of how low you set the volume—Active Bass.

- You can use this effect only for playback, but not for recording.

On the remote control ONLY:

Press **BASS** so that "ACT-BASS ON" appears in the main display.

The **BASS** indicator also lights on the display.

- Each time you press the button, Active Bass turns on and off alternately.

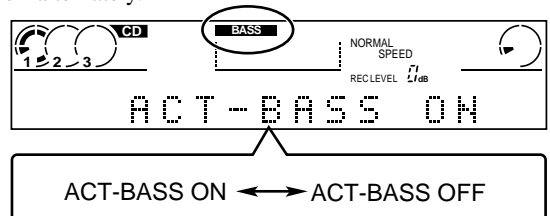

To cancel the effect, press the button again so that "ACT-BASS OFF" appears in the main display (and the **BASS** indicator goes off).

Selecting the Sound Modes

You can select one of the 5 preset sound modes and 2 manual modes.

- You can use this effect only for playback, but not for recording.

On the remote control ONLY:

Press **SOUND** repeatedly until the sound mode you want appears in the main display.

The **SOUND** indicator also lights on the display.

- Each time you press the button, the sound modes change as follows:

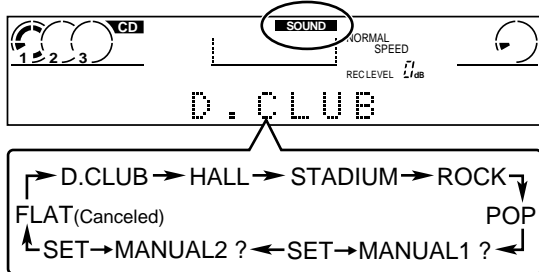

D. (Dance) CLUB: Increases resonance and bass.*

HALL: Adds depth and brilliance to the sound.*

STADIUM: Adds clarity and spreads the sound, like in an outdoor stadium.*

ROCK: Boosts low and high frequency. Good for acoustic music.

POP: Good for vocal music.

SET->MANUAL1 ?: Your individual mode stored in memory **without** surround elements.**

SET->MANUAL2 ?: Your individual mode stored in memory **with** surround elements.**

FLAT: Cancels the sound mode.

* Surround elements are added to create a being-there feeling.

**See “Creating Your Own Sound Modes—MANUAL Modes” on the right column.

To check the sound mode currently selected, press **SOUND** once while the **SOUND** indicator is lit. The currently selected sound mode appears in the main display.

Creating Your Own Sound Modes —MANUAL Modes

You can create and store your own sound modes.

- There is a time limit in doing the following steps. If the setting is canceled before you finish, start from step 1 again.

On the remote control ONLY:

- 1 Press **SOUND** repeatedly until “**SET->MANUAL1 ?**” or “**SET->MANUAL2 ?**” appears in the main display.

The **SOUND** indicator also lights on the display.



Ex.: When selecting “SET->MANUAL1 ?”

SET->MANUAL1 ?: Select this when you want to store your individual mode **without** surround elements.

SET->MANUAL2 ?: Select this when you want to store your individual mode **with** surround elements.

- 2 Press **SET**.



- 3 Adjust the equalizer pattern.

1) Press **▶▶ / ▶▶▶** or **◀◀ / ◀◀◀** to select the frequency range to adjust (**LOW, MIDDLE, HIGH**).

2) Press **→ (+10)** or **← (10)** to adjust the level (-3 to +3) of the selected frequency range.



Ex.: When adjusting middle frequency range

3) Repeat steps 1) and 2) to adjust the level of the other frequency ranges.

- 4 Press **SET** again (or wait until the above indication disappears).

“**MEMORY**” appears in the main display and the equalizer pattern you have created is stored in memory.

To use your own sound mode

See “Selecting the Sound Modes” on the left column.

Tuning into a Station

1 Press **SOURCE** repeatedly until **FM** or **AM (MW/LW)** is selected.

The unit automatically turns on and tunes into the previously received station (either FM or AM—MW/LW).

- Each time you press the button, the source changes as follows:

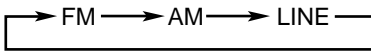

2 Tune into a station.

On the remote control:

Press and hold **▶▶ / ▶▶▶** or **◀◀ / ◀◀◀** until the station frequencies start changing in the main display.

On the unit:

Press and hold **▶▶▶** or **◀◀◀** until the station frequencies start changing in the main display.

- **▶▶ / ▶▶▶ (▶▶▶)**: to increase the frequencies.
- **◀◀ / ◀◀◀ (◀◀◀)**: to decrease the frequencies.

The unit starts searching stations and stops when a station of sufficient signal strength is tuned in.

- If an FM stereo program is received, the **STEREO** indicator lights on the display.

To stop during searching, press the same button you have pressed in step 2 above.



When you press the button briefly and repeatedly in step 2

The frequency changes step by step.

To change the FM reception mode

On the remote control ONLY:

When an FM stereo broadcast is hard to receive or noisy, press **FM/PLAY MODE** so that “**MONO**” appears in the main display.

The **MONO** indicator also lights on the display. Reception improves.

MONO MONO

To restore the stereo effect, press **FM/PLAY MODE** again so that “**AUTO**” appears in the main display.

In this stereo mode, you can hear stereo sounds when a program is broadcast in stereo.

AUTO

Presetting Stations

You can preset 30 FM and 15 AM (MW/LW) stations—using either automatic presetting method or manual presetting method.

- You cannot store FM reception mode separately for each preset station.

In some cases, test frequencies have been already memorized for the tuner since the factory examined the tuner preset function before shipment. This is not a malfunction. You can preset the stations you want into memory by following the presetting method.

To preset stations automatically—Automatic Presetting
You need to preset stations separately for the FM and AM bands.

On the remote control ONLY:

1 Press **SOURCE** repeatedly until **FM** or **AM (MW/LW)** is selected.

2 Press and hold **AUTO PRESET** for more than 4 seconds.

Automatic Presetting starts and local stations with strong signals are searched and stored in memory automatically.

When automatic presetting is over, the station stored in preset number 1 is tuned in.

3 Repeat steps 1 and 2 to store stations of the other band—**FM** or **AM (MW/LW)**.

STEREO FM 1 87.50 MHz



When you cannot store stations you want automatically

Stations with weak signals cannot be detected with this automatic presetting method. To store such a station, use the manual presetting method on page 19.

To preset stations manually—Manual Presetting

On the remote control ONLY:

- There is a time limit in doing the following steps. If the setting is canceled before you finish, start from step 2 again.

1 Tune into a station you want to preset.

- See “Tuning into a Station” on page 18.



2 Press SET.

The preset number appears and starts flashing.



3 Press the number buttons to select a preset number.



Ex.: When selecting preset number “8”

Ex.: For preset number 5, press 5.

For preset number 15, press +10, then 5.

For preset number 20, press +10, then 10.

For preset number 30, press +10, +10, then 10.

4 Press SET again.

“MEMORY” appears in the main display, and the tuned station in step 1 is stored in the preset number selected in step 3.

- Storing a new station on a used number erases the previously stored one.



When you unplug the AC power cord or if a power failure occurs

The preset stations will be erased in a few days. If this happens, preset the stations again.

Tuning into a Preset Station

On the remote control ONLY:

1 Press SOURCE repeatedly until FM or AM (MW/LW) is selected.



Ex.: When selecting FM

2 Press the number buttons to select a preset number.



Ex.: When selecting preset number “8”

Ex.: For preset number 5, press 5.

For preset number 15, press +10, then 5.

For preset number 20, press +10, then 10.

For preset number 30, press +10, +10, then 10.

Receiving FM Stations with RDS

RDS allows FM stations to send an additional signal along with their regular program signals. For example, the stations send their station names, as well as information about what type of program they broadcast, such as sports or music, etc.

When tuned into an FM station which provides the RDS service, the RDS indicator lights on the display.

- Some FM stations do not provide RDS signals.

With the unit, you can receive the following types of RDS signals.

PS (Program Service):

Shows commonly known station names.

PTY (Program Type):

Shows types of broadcast programs.

RT (Radio Text):

Shows text messages the station sends.

EON (Enhanced Other Networks):

Provides the information about the types of the programs sent by other RDS stations than the one being received.



More about RDS

- Broadcast RDS signals differ among FM stations. If in doubt, check with local radio stations for details on RDS in your area.
- RDS may not work correctly if the received station is not transmitting the signals properly or if the signal strength is weak.

Changing the RDS Information

You can see RDS information in the main display while listening to an FM station.

On the remote control ONLY:

Press **RDS DISPLAY** while listening to an FM station.

- Each time you press the button, the display changes to show the following information:

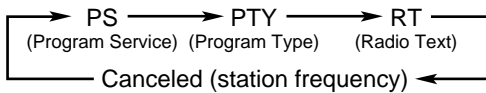

If no PS, PTY, or RT signals are sent by a station “NO PS,” “NO PTY,” or “NO RT” appears in the main display.



If the unit takes time to show the RDS information received from a station “WAIT PS,” “WAIT PTY,” or “WAIT RT” may appear in the main display.

Searching for Programs by PTY Codes (PTY Search)

One of the advantages of RDS is that you can locate a particular kind of program by specifying the PTY codes.

- The PTY Search is applicable only to the preset stations.

To search for a program using the PTY codes, follow the procedure below.

- There is a time limit in doing the following steps. If the setting is canceled before you finish, start from step 1 again.

On the remote control ONLY:

- Press **PTY SEARCH** while listening to an FM station.



- Press **PTY SELECT** + or – to select a PTY code while “PTY SELECT” is still in the main display.



- Each time you press the button, the PTY codes change as follows (refer also to the list on page 22):

News ⇄ Affairs ⇄ Info ⇄ Sport ⇄ Educate ⇄
 Drama ⇄ Culture ⇄ Science ⇄ Varied ⇄
 Pop M ⇄ Rock M ⇄ Easy M ⇄ Light M ⇄
 Classics ⇄ Other M ⇄ Weather ⇄ Finance ⇄
 Children ⇄ Social ⇄ Religion ⇄ Phone In
 ⇄ Travel ⇄ Leisure ⇄ Jazz ⇄ Country ⇄
 Nation M ⇄ Oldies ⇄ Folk M ⇄ Document ⇄
 TEST ⇄ Alarm! ⇄ (back to the beginning)

- Press **PTY SEARCH** again.

While searching, the selected PTY code and “SEARCH” appear alternately and repeatedly in the main display.

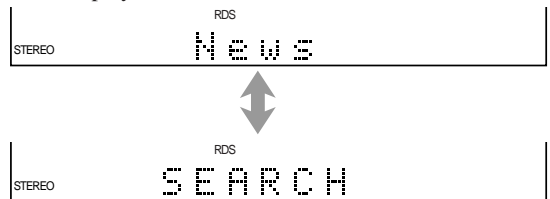

The unit searches 30 preset FM stations, stops when it finds the one you have selected, and tunes into that station.

To continue searching after the first stop:

Press **PTY SEARCH** again while the indications in the main display are flashing.

If no program is found, “NOT FOUND” appears in the main display and the unit returns to the last received station.

To stop searching any time during the process:

Press **PTY SEARCH** while searching.

The unit returns to the last received station.

Switching to a Program of Your Choice Automatically

The EON function allows the unit to switch temporarily to a broadcast program of your choice (TA, News, and/or Info) from a different station except when you are listening to a non-RDS stations—some FM stations and AM (MW/LW) stations.

- This function only works while receiving a preset RDS station sending the EON data (the RDS and EON indicators light while receiving such a station).
- This function is applicable only to the preset stations.

To activate the EON function, follow the procedure below.

- There is a time limit in doing the following steps. If the setting is canceled before you finish, start from step 1 again.

On the remote control ONLY:

1 Press EON while listening to an FM station.

“EON ON” appears in the main display, and the last program type selected—[TA News Info]—lights on the display.



2 Press TA/News/Info repeatedly until the program type you want is selected.

- At the first press, “EON SELECT” appears in the main display, then from the second press on, the program types change as follows:

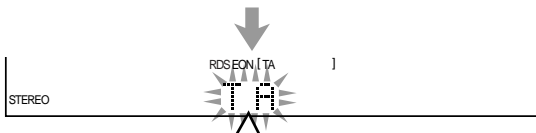
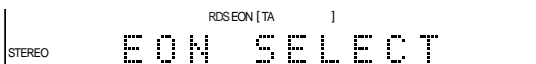

TA: Traffic announcement
News: News
Info: Programs the purpose of which is to impart advice in the widest sense.

To cancel the EON function, press EON again so that the [TA News Info] indicator goes off. “EON OFF” also appears in the main display for a while.

- If you cancel the EON function while receiving a program selected by the EON function, the unit goes back to the previously tuned station.

How the EON function actually works:

CASE 1

If there is no station broadcasting the program you have selected

The unit continues tuning in the current station.



When a station starts broadcasting the program you have selected, the unit automatically switches to the station. The indicator of received PTY code starts flashing.



When the program is over, “EON END” appears in the main display, and the unit goes back to the previously tuned station, but the EON function still remains activated.

CASE 2

If there is a station broadcasting the program you have selected

The unit tunes into the program. The indicator of received PTY code starts flashing.



When the program is over, “EON END” appears in the main display, and the unit goes back to the previously tuned station, but the EON function still remains activated.

CASE 3

If the FM station you are listening to is broadcasting the program you have selected

The unit continues to receive the station.

Alarm function

If an "Alarm!" (Emergency) signal is received from a station while listening to an RDS station sending the EON data, the unit automatically switches to the station broadcasting the "Alarm!" signal.



More about the EON function

- EON data sent from some stations may not be compatible with this unit.
- While listening to a program tuned in by the EON function, the station does not change even if another network station starts broadcasting a program of the same type.
- If the stations alternate intermittently between the station tuned by the EON function and the currently tuned station ("WAITING" flashes in the main display), press EON to cancel the EON function.

If you do not press the button, the currently tuned station is received finally ("NOT FOUND" appears this time), and the indication of the program type flashing on the display disappears.

Description of the PTY codes:

News:	News.
Affairs:	Topical program expanding or enlarging upon the news—debate, or analysis.
Info:	Programs the purpose of which is to impart advice in the widest sense.
Sport:	Programs concerned with any aspect of sports.
Educate:	Educational programs.
Drama:	All radio plays and serials.
Culture:	Programs concerning any aspect of national or regional culture, including language, theater, etc.
Science:	Programs about natural sciences and technology.
Varied:	Used for mainly speech-based programs such as quizzes, panel games and personality interviews.
Pop M:	Commercial music of current popular appeal.
Rock M:	Rock music.
Easy M:	Current contemporary music considered to be "easy-listening."
Light M:	Instrumental music, and vocal or choral works.
Classics:	Performances of major orchestral works, symphonies, chamber music, etc.
Other M:	Music not fitting into any of the other categories.
Weather:	Weather reports and forecasts.

Finance:	Stock Market reports, commerce, trading etc.
Children:	Programs targeted at a young audience.
Social:	Programs about sociology, history, geography, psychology and society.
Religion:	Religious programs.
Phone In:	Involving members of the public expressing their views either by phone or at a public forum.
Travel:	Travel information.
Leisure:	Programs about recreational activities.
Jazz:	Jazz music.
Country:	Songs which originate from, or continue the musical tradition of the American Southern States.
Nation M:	Current popular music of the nation or region in that country's language.
Oldies:	Music from the so-called "golden age" of popular music.
Folk M:	Music which has its roots in the musical culture of a particular nation.
Document:	Programs concerning factual matters, presented in an investigative style.
TEST:	Broadcasts for testing emergency broadcast equipment or receiver.
Alarm!:	Emergency announcement.
None:	Undefined.

Classification of the PTY codes for some FM stations may be different from the above list.

Playing Back Discs on 3-CD Changer

The buttons and controls enlarged in the illustration below are used and explained in this section (pages 24 to 28).

Remote control

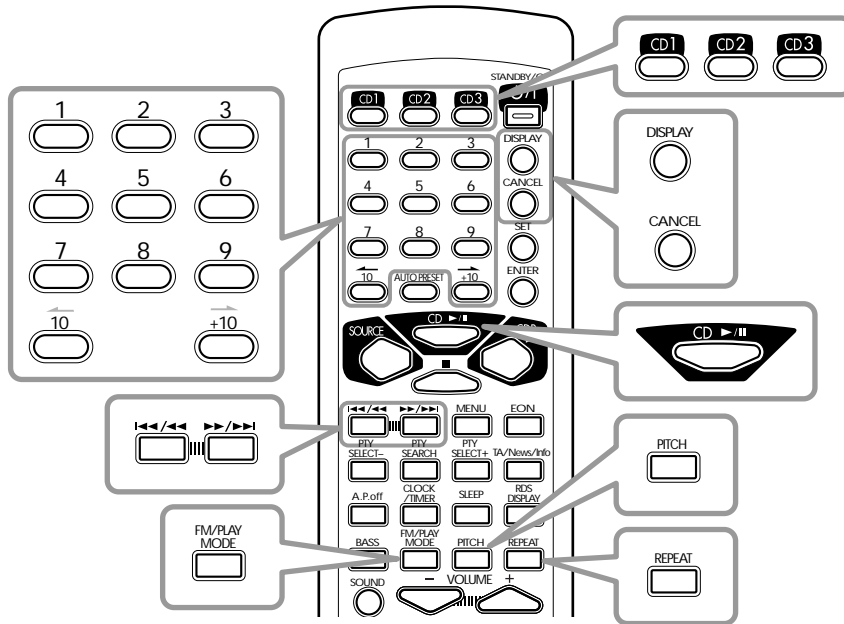

Main unit

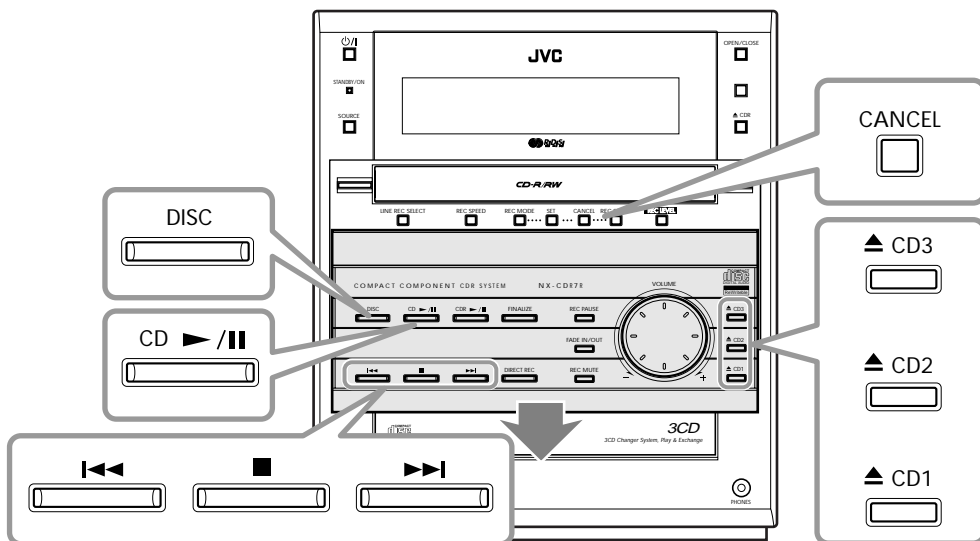

Press OPEN/CLOSE to move down (or up) the sliding panel.

The built-in 3-CD Changer can play back both finalized and unfinalized CD-Rs/CD-RWs. However, **some unfinalized discs cannot be played back because of their disc characteristics.**

Loading Discs

On the unit ONLY:

- 1 Press one of the open/close buttons (\blacktriangle CD1, \blacktriangle CD2, and \blacktriangle CD3) for the disc tray you want to load a CD onto.

The unit automatically turns on and the selected disc tray comes out.

- If the sliding panel is left open, it moves up automatically before the disc tray comes out.

- 2 Place a disc correctly on the circle of the disc tray, with its label side up.

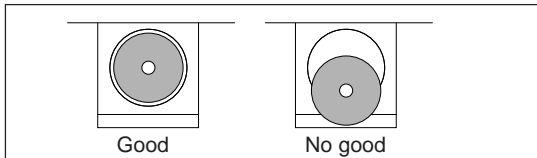
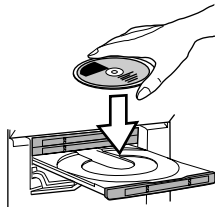

- When using a CD single (8 cm), place it on the inner circle of the disc tray.

- 3 Press the same open/close button (\blacktriangle CD1, \blacktriangle CD2, or \blacktriangle CD3) you have pressed in step 1.

The disc tray closes.



When loading more than one disc continuously

Press the open/close button (\blacktriangle CD1, \blacktriangle CD2, or \blacktriangle CD3) for the next tray you want to place a disc onto. The first disc tray automatically closes and the next disc tray comes out.

Playing Back the Entire Discs—Continuous Play

You can play discs continuously.

- 1 Load discs into 3-CD Changer.
- 2 Select a disc, and start playback.

On the unit:

- 1 Press DISC repeatedly to select the disc you want.
- 2 Press CD \blacktriangleright / \parallel .

On the remote control:

Press one of the disc number buttons (CD1, CD2, and CD3).

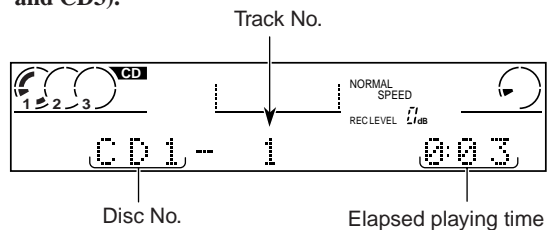

CD playback starts from the first track of the selected disc.

- Without selecting the disc number, pressing CD \blacktriangleright / \parallel starts playing back the currently selected CD.

To stop playback for a moment, press CD \blacktriangleright / \parallel . To resume play, press CD \blacktriangleright / \parallel again.

To stop during play, press \blacksquare .

To remove the disc, press the corresponding open/close buttons (\blacktriangle CD1, \blacktriangle CD2, or \blacktriangle CD3) on the unit.



Disc playback sequence in 3-CD Changer

When 3 discs are loaded on the disc trays, they are played in one of the following sequences.

- When CD 1 is pressed : CD 1 \Rightarrow CD 2 \Rightarrow CD 3 (then stops)
 - When CD 2 is pressed : CD 2 \Rightarrow CD 3 \Rightarrow CD 1 (then stops)
 - When CD 3 is pressed : CD 3 \Rightarrow CD 1 \Rightarrow CD 2 (then stops)
- * If no disc is on the disc trays, 3-CD Changer skips such an empty tray.



If the current disc is a CD Text

You can change the information in the main display. See "To show the text information recorded on a CD Text" on page 28.

Basic Disc Operations

To exchange a disc during playback of another disc

On the unit ONLY:

Press the open/close buttons (▲ CD1, ▲ CD2, or ▲ CD3) to eject a disc not currently playing.

If discs are exchanged during playback, playback will stop after playing all newly inserted discs.

To start playing a disc during playback of another disc

On the remote control:

Press CD1, CD2 or CD3.

The selected disc play starts.

On the unit:

Press DISC repeatedly.

Each time you press the button, the next disc is selected and playback starts.

To locate a particular point in a track during play

On the remote control:

Press and hold ►► / ►►| or |◄◄ / ◄◄.

On the unit:

Press and hold ►►| or |◄◄.

- ►► / ►►| (►►|): Fast-forwards the tracks.
- |◄◄ / ◄◄ (|◄◄): Fast-reverses the tracks.

To go to another track

On the remote control:

Press ►► / ►►| or |◄◄ / ◄◄ repeatedly.

On the unit:

Press ►►| or |◄◄ repeatedly.

- ►► / ►►| (►►|): Skips to the beginning of the next or succeeding tracks.
- |◄◄ / ◄◄ (|◄◄): Goes back to the beginning of the current or previous tracks.

To go to another track directly using the number buttons

On the remote control ONLY:

Press the number button(s) allows you to start playing the track number you want.

Ex.: For track number 5, press 5.

For track number 15, press +10, then 5.

For track number 20, press +10, then 10.

For track number 32, press +10, +10, +10, then 2.

Programming the Playing Order of the Tracks—Program Play

You can arrange the order in which the tracks play before you start playing. You can program up to 32 tracks.

On the remote control ONLY:

1 Load discs into 3-CD Changer.

- If the current playing source is not 3-CD Changer, press CD ► / ||, then ■ before going to the next step.

2 Press FM/PLAY MODE repeatedly so that “CD PROGRAM” appears in the main display.

The PROGRAM indicator also lights on the display.

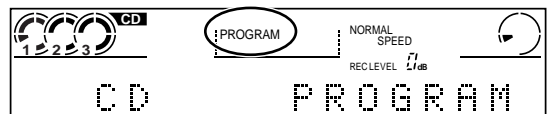

- Each time you press the button, play mode changes as follows:

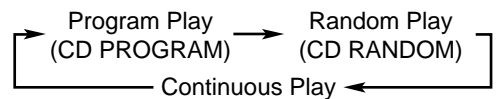

3 Press one of the disc number buttons (CD1, CD2, and CD3) to select the disc number you want to play.

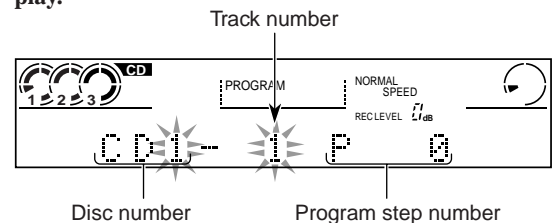

Ex.: Disc number 1 is selected

4 Press the number buttons to select a track from the disc selected in the above step.

- For how to use the number buttons, see “To go to another track directly using the number buttons” on the left column.

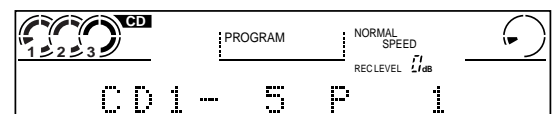

Ex.: Track number 5 is selected

5 Program other tracks you want.

- To program tracks from the same disc, repeat step 4.
- To program tracks from a different disc, repeat steps 3 and 4.

6 Press CD ► / II.

The tracks are played in the order you have programmed. Program Play stops when all the programmed tracks are played (unless Repeat Play is activated—see page 27).

To stop during play, press ■.

To exit from Program Play mode, before or after play, press FM/PLAY MODE once or twice so that the unit enters another playback mode (Random Play or Continuous Play).

To check the program contents

Before playing, you can check the program contents by pressing ►► / ►►► or ◀◀◀ / ◀◀ on the remote control.

- ►►► / ►►►► : Shows the programmed tracks in the programmed order.
- ◀◀◀◀ / ◀◀◀ : Shows them in the reverse order.

To modify the program

Before playing, you can erase the last programmed track by pressing CANCEL.

Each time you press the button, the last programmed track is erased from the program.

- When you eject a disc, the tracks selected from that ejected disc are also erased from the program.
- Turning off the unit also erases the entire program.

To add tracks to the program before playing, simply select disc numbers and track numbers you want to add.



If you try to program a 33rd step

“MEMORY FULL” will appear in the main display.



If your entry is ignored

You have tried to program a track from an empty tray, or a track number that does not exist on the disc (for example, selecting track 14 on a disc that only has 12 tracks). Such entries are ignored.

Playing at Random—Random Play

The tracks of all loaded discs will play at random.

On the remote control ONLY:

1 Load discs into 3-CD Changer.

- If the current playing source is not 3-CD Changer, press CD ► / II, then ■ before going to the next step.

2 Press FM/PLAY MODE repeatedly so that “CD RANDOM” appears in the main display.

The RANDOM indicator also lights on the display.

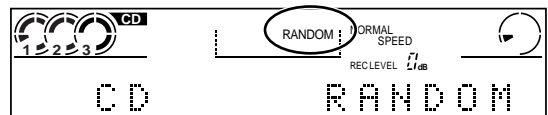

- Each time you press the button, play mode changes as follows:

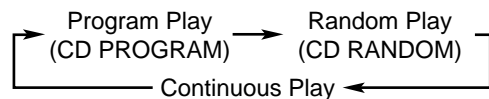

3 Press CD ► / II.

The tracks are played at random.

Random Play stops when all the tracks are played once (unless Repeat Play is activated—see page 27).

To stop during play, press ■.

- Random Play also stops when you open a disc tray.

To exit from Random Play mode, before or after play, press FM/PLAY MODE once or twice so that the unit enters another playback mode (Continuous Play or Program Play).

- Pressing CD1, CD2, or CD3 starts Continuous Play from the first track of the selected disc.
- Pressing one of the number buttons will start Continuous Play from the selected track of the currently selected disc.

Repeating Tracks or Discs—Repeat Play

You can have all the discs, the program or the individual track currently playing repeat as many times as you like.

- If an unfinalized CD-R or CD-RW is loaded, it will be skipped and not be played back.

On the remote control ONLY:

Press **REPEAT** repeatedly during or before playing.

- Each time you press the button, Repeat Play mode changes and appears in the main display as follows:

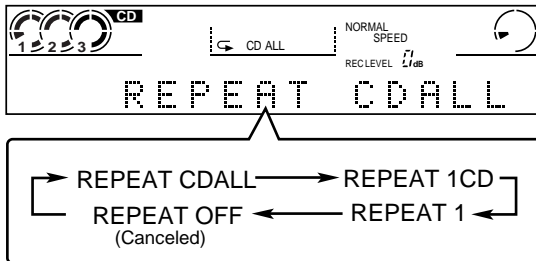

Ex.: When "REPEAT CDALL" is selected

- **REPEAT CDALL**: Repeats all the tracks on all the discs (continuously or at random), or all the tracks in the program.
 - **REPEAT 1CD***: Repeats all the tracks on one disc.
 - **REPEAT 1**: Repeats one track.
 - **REPEAT OFF**: Cancels Repeat Play.
- * REPEAT 1CD is not used for Program Play and Random Play.

Other Convenient Functions

The following functions can be used only for 3-CD Changer.

To select the Continuous Play mode for 3-CD Changer

This is not possible when the current source is 3-CD Changer.

On the unit ONLY:

1 Press DISC while listening to a source other than 3-CD Changer.

- Each time you press the button, the following play modes appear in the main display.

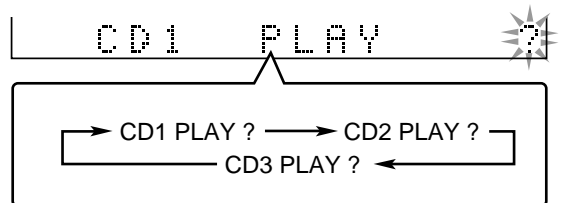

- **CD1 PLAY ?**: Select this to start playback from the disc on the CD 1 tray.
- **CD2 PLAY ?**: Select this to start playback from the disc on the CD 2 tray.
- **CD3 PLAY ?**: Select this to start playback from the disc on the CD 3 tray.

2 Press CD ► / II while the selected play mode still remains in the main display.

Now the playback source is changed to 3-CD Changer and Continuous Play starts.

To show the text information recorded on a CD Text

On a CD Text, some information about the disc (its disc title, performer, composer, arranger, etc.—shaded portion in the illustration below) is recorded.

While the currently selected disc in 3 CD Changer is a CD Text, the TEXT indicator lights on the display, and you can show this text information in the main display.

On the remote control ONLY:

Press **DISPLAY** repeatedly.

- Each time you press the button, the following information appear in the main display:

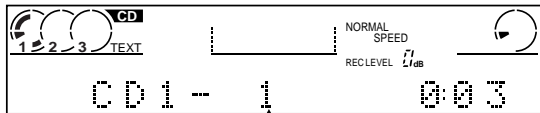

DISC TITLE or TRACK TITLE* → PERFORMER →
GENRE → SONGWRITER → COMPOSER →
ARRANGER → MESSAGE →
Clock time → (back to the beginning)

- * Disc title appears before playing, and track title appears while playing.



If there is no data recorded for a particular item

Only recorded information will be shown. "NO DATA" will appear.

To adjust the playback speed

You can change the disc playback speed up to 12% faster or 12% slower when playing back a disc on 3-CD Changer. This function will be useful when you want to enjoy singing along. (Note, however, no microphone can be used when you are using only this unit since no microphone input jack is provided.)

- No signals are output through the 3CD DIGITAL OUT terminal on the rear when playback speed is adjusted (while the PITCH indicator is lit).

On the remote control ONLY:

1 Press PITCH during play.

The current setting appears in the main display— "PITCH 0" (no effect) when shipped from the factory.

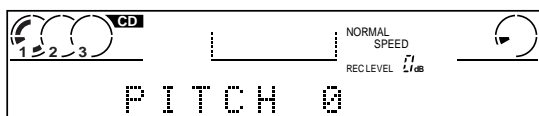

2 Press ►► / ►►| or |◀◀ / ◀◀ while the current setting still remains in the main display.

When playback speed (pitch) is adjusted and set to any percentage other than "0," the PITCH indicator lights on the display.

- ►► / ►►|: to increase the playback speed (pitch) up to 12% faster.
- |◀◀ / ◀◀: to decrease the playback speed (pitch) down to 12% slower.

- If you press and hold the button, you can continuously change the pitch setting until you release the button.
- You can also change the pitch setting by pressing ►►| or |◀◀ on the unit repeatedly.

To restore normal speed playback, select "PITCH 0" so that the PITCH indicator goes off.

- Do not forget to restore normal speed playback after you have enjoyed this effect; otherwise, sounds you hear will be strange.
- Turning off the unit also restores normal speed playback.



During CD Synchronized Recording from 3-CD Changer to CD Recorder

Playback speed (pitch) adjustment is automatically canceled temporarily. (The PITCH indicator goes off.)

To prohibit disc ejection—Disc Lock

You can prohibit disc ejection both from 3-CD Changer and from CD Recorder.

Notice you cannot move the sliding panel while Disc Lock is in use. This means that you cannot use the buttons inside the sliding panel.

On the unit ONLY:

To prohibit disc ejection, press ■ while holding REC PAUSE with the unit set in standby mode.

"LOCKED" appears in the main display for a while, and the loaded discs (both in 3-CD Changer and in CD Recorder) and the sliding panel are locked.

LOCKED



If you try to eject the locked discs or open the sliding panel.

"LOCKED" appears to inform you that Disc Lock is in use.

To cancel the prohibition and unlock the discs,

press ■ while holding REC PAUSE with the unit set in standby mode. "UNLOCKED" appears for a while, and the loaded discs (both in 3-CD Changer and in CD Recorder) and the sliding panel are unlocked.

Playing Back a Disc on CD Recorder

The buttons and controls enlarged in the illustration below are used and explained in this section (page 30).

Remote control

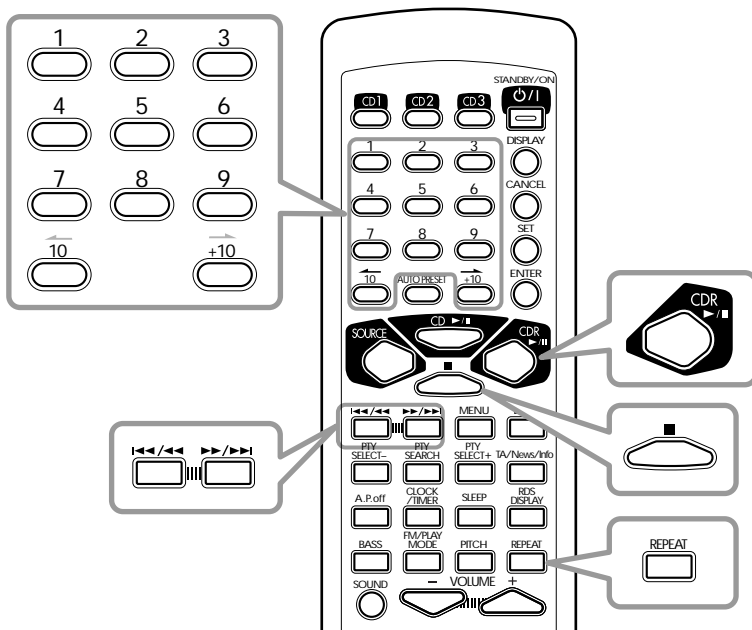

Main unit

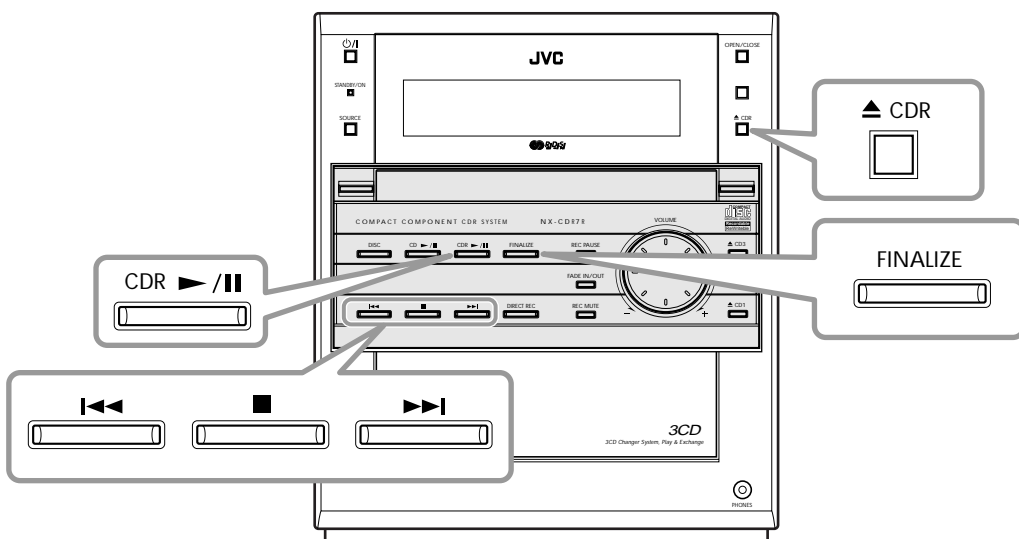

Notice you cannot use Program Play and Random Play while playing a disc on CD Recorder.

Basic Disc Operations

To locate a particular point in a track during play

On the remote control:

Press and hold ►► / ►►► or ◀◀ / ◀◀◀.

On the unit:

Press and hold ►►► or ◀◀◀.

- ►► / ►►► (►►►): Fast-forwards the tracks.
- ◀◀ / ◀◀◀ (◀◀◀): Fast-reverses the tracks.

To go to another track

On the remote control:

Press ►►► / ►►►► or ◀◀◀ / ◀◀◀◀ repeatedly.

On the unit:

Press ►►► or ◀◀◀ repeatedly.

- ►►► / ►►►► (►►►►): Skips to the beginning of the next or succeeding tracks.
- ◀◀◀ / ◀◀◀◀ (◀◀◀◀): Goes back to the beginning of the current or previous tracks.

To go to another track directly using the number buttons

On the remote control ONLY:

Press the number button(s) allows you to start playing the track number you want.

- Ex.: For track number 5, press 5.
 For track number 15, press +10, then 5.
 For track number 20, press +10, then 10.
 For track number 32, press +10, +10, +10, then 2.

Repeating Tracks—Repeat Play

You can repeat an individual track or all tracks in a disc many times as you like.

On the remote control ONLY:

Press REPEAT repeatedly during or before playing.

- Each time you press the button, Repeat Play mode changes and appears in the main display as follows:

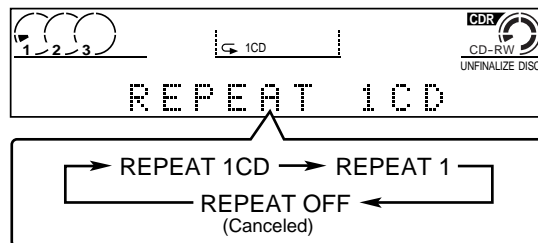

Ex.: When "REPEAT 1CD" is selected

- **REPEAT 1CD:** Repeats all the tracks.
- **REPEAT 1:** Repeats one track.
- **REPEAT OFF:** Cancels Repeat Play.

Playing Back a Disc—Normal Play

You can play back both finalized and unfinalized discs on CD Recorder.

On the remote control ONLY:

1 Press ▲ CDR.

The unit automatically turns on and the CDR disc tray comes out.

- If the sliding panel is closed, it moves down automatically before the CDR disc tray comes out.

2 Place a disc correctly on the circle of the disc tray, with its label side up.

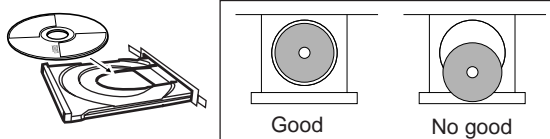

- When using a CD single (8 cm), place it on the inner circle of the disc tray.

3 Press CDR ► / II.

The CDR disc tray also closes and CD Recorder starts playing the loaded disc. The CDR lamps start flashing.

- If you press ▲ CDR again in this step, the disc tray closes, but playback does not start.

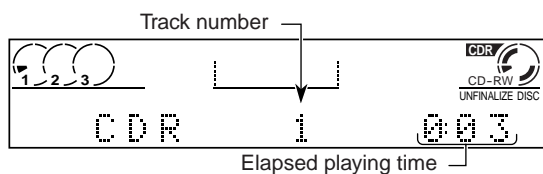

Ex.: When an unfinalized CD-RW is loaded

To close the CDR disc tray, press ▲ CDR again.

To stop playback for a moment, press CDR ► / II.

To resume play, press CDR ► / II again.

To stop during play, press ■.

To remove the disc, press ▲ CDR on the unit.

- When you try to eject the unfinalized CD-R or CD-RW, "FINALIZE ?" appears and flashes in the main display.

If you do not finalize the disc, press ▲ CDR again.

If you do finalize the disc, press FINALIZE. (See also "Finalizing a Disc—CD-R/CD-RW" on page 41.)

Recording on a CD-R/CD-RW

The buttons and controls enlarged in the illustration below are used and explained in this section (pages 32 to 41). For recording operations, you mainly use the buttons and controls on the unit.

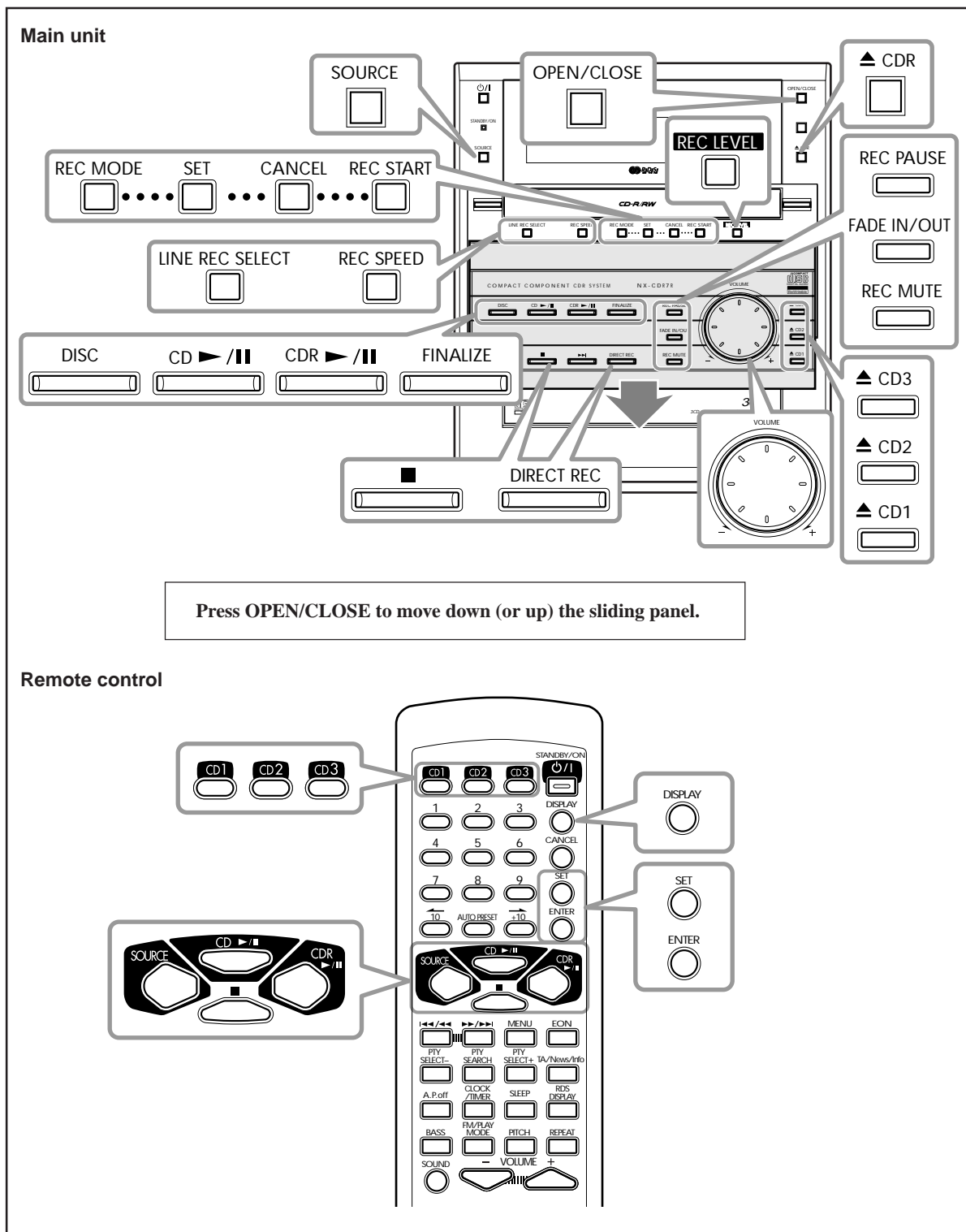

Before You Start Recording

- When you record onto a partially recorded unfinalized CD-R or CD-RW, its contents are not erased or overwritten. The recording starts from the point following the last recorded track of the disc.
For CD-RW only: If you want to record on such a CD-RW from the beginning, you have to erase its contents first (see “Erasing All Tracks (Only for CD-RW)” on page 46). (You cannot erase the contents recorded on a CD-R.)
- When the data recordable memory area of an CD-R or CD-RW becomes fully while recording, recording will stop automatically.

Optimum Power Control (OPC)

When an unfinalized CD-R or CD-RW is loaded in CD Recorder, this CD Recorder automatically checks the disc condition and automatically adjusts the laser output level to obtain optimum recording on the disc before recording.

While OPC is being performed (for about 10 seconds), “UPDATE OPC” flashes in the main display (and the REC indicator also lights on the display).



If “OPC ERROR” appears in the main display

The disc inserted cannot be used for recording.

Sampling frequency rate converter

The sampling frequency rate converter built in the CD Recorder allows you to record a digital source having sampling frequency (fs) of 32 kHz, 44.1 kHz, or 48 kHz.

- When you can record dts* CD or HDCD** signals coming through the LINE DIGITAL IN terminal, bypass the built-in sampling frequency rate converter.

To bypass the sampling frequency rate converter, see “Turning On or Off Sampling Frequency Rate Converter” on page 44.

* dts is a trademark of Digital Theater Systems, Inc.

**HDCD® is a registered trademark of Pacific Microsonic, Inc.

Auto track space

While recording from the 3-CD Changer onto CD Recorder, you can use this function.

When this function is turned on, CD Recorder automatically makes 2-second blank portion at the beginning of each track on a recorded disc.

To use this function for your recording, see “Separating Recorded Tracks Automatically—Auto Track Space” on page 44.

Auto track-marking

Whenever you turn on the unit, auto track-marking is activated. (The AUTO TRACK indicator will light on the display.)

When auto track-marking is activated

• Recording from 3-CD Changer:

Track marks are recorded automatically at the points where the tracks change.

• Recording an analog source—FM, AM, and external component connected to the LINE IN jacks:

No track mark is recorded on a disc. This means that, when playing this disc, a CD player will regard the entire recording as one track. However, if there is a blank of 3 seconds or more, CD Recorder will consider it as a blank separating 2 tracks and consequently put a track mark.

• Recording through the LINE DIGITAL IN terminal:

- If the playback source DOES have track marks recorded, they are recorded automatically at the points where the tracks change.
- If the playback source DOES NOT have track marks recorded, this unit functions in the same way for recording an analog source.

To cancel auto track-marking and use manual track-marking, see “Recording Track Marks Manually—Manual Track-Marking” on page 43.

Available recording modes—REC MODE

CD Recorder provides a variety of the recording methods—called “Recording Modes.”

Available recording modes vary according to the playback source and its playback status.

By pressing REC MODE after all preparation for recording is finished, you can select and use the following recording modes.

■ When the source is 3-CD Changer

—CD Synchronized Recording:

- CD Direct Recording (with or without finalization)—See page 36.
- First Track Recording—See page 38.
- Listening Edit Recording (with or without finalization)—See page 39.

During play, you can only perform a single track recording—See page 41.

■ When the source is the external component

- Sound Synchronized Recording—See page 40.

When recording is stopped or finished, CD Synchronized Recording and Sound Synchronized Recording are canceled automatically.



Digital recording or analog recording?

CD Recorder automatically selects appropriate recording—either digital or analog—during CD Synchronized Recording. When digital source is selected as the playback sound, it will be recorded digitally unless it is a first-generation digital copy (see “SCMS (Serial Copy Management System)” on page 54). In this case, CD Recorder selects analog recording.



During CD Synchronized Recording

- Repeat Play will be canceled automatically.
- Auto track-marking is activated automatically.



Other recording methods

You can also use the REC PAUSE button to perform the recording. See “Recording Any Sound Source—Standard Recording” on page 34.

High-Speed Recording

When using some of the Recording Modes mentioned on the left column, this unit allows you to change the recording speed—normal speed and high speed.

For CD-R, high speed means 4 times normal speed and for CD-RW, 2 times normal speed.

When you select high speed for your recording, you cannot listen to the played-back sounds.



During high-speed recording

You cannot listen to any source, and therefore, cannot adjust the volume level. (“CANNOT LISTEN” will flash in the main display if you try to do.)

Finalization

This is the final process in recording on a CD-R or CD-RW. “Finalizing a disc” means writing the TOC (Table of Contents) on the recorded disc.

Only after this process is completed, a recorded CD-R or CD-RW can be played back on a CD player compatible with CD-R/CD-RW.

- It is also recommended to finalize a disc in order to play it back on 3-CD Changer.

To finalize a disc, see “Finalizing a Disc—CD-R/CD-RW” on page 41.

Recording Any Sound Source —Standard Recording

The following recording method can be applied to any sound source.

On the unit **ONLY**:

1 Select the source to record from.

- **When recording from 3-CD Changer:**
 - Press CD ► / ||, then ■. To select a disc, press DISC repeatedly, then ■.
 - You can also use the remote control. When using it, press CD1, CD2, or CD3, then ■.
 - If the current play mode is either Program Play or Random Play, press FM/PLAY MODE on the remote control to select Continuous Play.
- **When recording an FM/AM (MW/LW) broadcast:** Press SOURCE repeatedly to select FM or AM (MW/LW), then tune into a station you want.
- **When recording from external equipment:**
 - 1 Press SOURCE repeatedly to select “LINE.”
 - 2 Press LINE REC SELECT (inside the sliding panel) repeatedly to select either “ANALOG IN” or “DIGITAL IN.”

ANALOG IN: To record through the LINE IN jacks (analog-to-digital recording).

DIGITAL IN: To record through the LINE DIGITAL IN terminal (digital-to-digital recording).

2 Insert a recordable CD-R or CD-RW on the CDR disc tray.

3 Press REC PAUSE so that CD Recorder enters recording pause mode.

- The REC indicator starts flashing on the display, and the CDR lamps also start flashing.
- If OPC (see page 32) is being performed, “UPDATE OPC” flashes first in the main display.

Selected recording method—
digital or analog—is shown here.



Ex.: When recording an FM station

4 Adjust the recording input level if necessary.

See “To adjust the recording input level” on page 35.

5 Press CDR ► / ||.

Recording starts.



6 When recording from 3-CD Changer:

Press CD ► / ||.

- Recording stops when a selected disc is recorded.

When recording from the external component: Start playback.

- For details, see the manual supplied with your component.

To stop recording for a moment, press REC PAUSE (or CDR ► / ||) again.

To resume recording, press CDR ► / || again. (A track mark is recorded when you resume recording.)

To stop recording, press ■.

- When recording from 3-CD Changer, both 3-CD Changer and CD Recorder stop.

To remove the recorded disc, press ▲ CDR.

“FINALIZE ?” flashes in the main display for a while.

- If you do finalize the disc, press FINALIZE. Remember once you finalize a CD-R, no further recording can be made on the disc. (For more details, see “Finalizing a Disc—CD-R/CD-RW” on page 41.)
- If you do not finalize the disc, press ▲ CDR again.

To fade in and fade out the recording

You can fade in and fade out the recording—for about 5 seconds—when using Standard Recording.

To start recording by fading in, press FADE IN/OUT on the unit in step 5 of the Standard Recording procedure (in other words, while CD Recorder is in recording pause).

To pause recording by fading out, press FADE IN/OUT (instead of the ■ button) when you want to pause the recording.

To stop recording, press ■.

To adjust the recording input level

You can adjust the recording input level.

Once adjustment is made, it is memorized, and will be recalled when you record any source on CD Recorder, using any recording method (except when high speed recording is selected).

While adjusting the recording input level, the sounds through the speakers and headphones also change so that you can check the difference by your own ears.

On the unit ONLY:

1 While CD Recorder is in recording pause mode, press REC LEVEL (inside the sliding panel).

Now the VOLUME control (and VOLUME +/- on the remote) works to adjust the recording level.

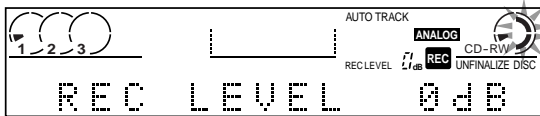

2 Turn the VOLUME control while listening to the playback sound.

- Adjust the recording input level so that the OVER indicator never lights.

Recording input level is also shown here



- You can adjust the recording input level within the range of +12 dB to -12 dB in 2 dB intervals. Normally set it to 0 dB (initial setting at factory).

3 Press REC LEVEL again to finish the adjustment.

Now the VOLUME control (and VOLUME +/- on the remote) works as usual to adjust the volume level.

4 Press ■ to cancel recording pause mode.

- If you press CDR ► / ■, standard recording (see page 34) will start.



When you unplug the AC power cord or if a power failure occurs

Input level adjustment will be erased in a few days. If this happens, adjust the input level again.

To make a silent portion in your recording

You can record a 4-second silence when using Standard Recording. This is convenient when recording tracks from many discs.

- This function can be used both for digital and analog recording.

To make a silent portion in your recording, press REC MUTE on the unit while recording.

Recording enters recording pause mode after recording a 4-second silence. (You can also make a silent portion as long as you want by holding the button.)

To resume recording, press CDR ► / ■. (A track mark is recorded when you resume recording.)

To change the display information while recording

You can change the information in the main display.

- For display information during playback, see “Changing the Display Information” on page 15.

On the remote control ONLY:

Press DISPLAY repeatedly.

- Each time you press the button, the information in the main display changes as follows:

■ When the source is 3-CD Changer:

- During Standard Recording

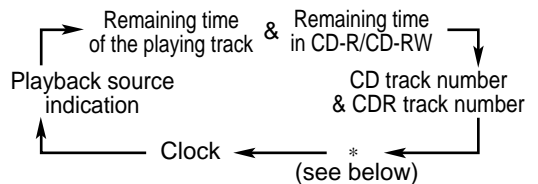

- During CD Synchronized Recording (see page 36)

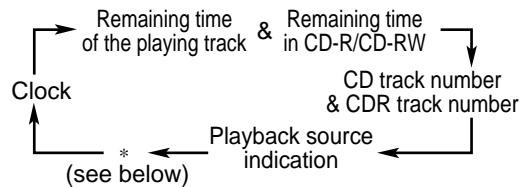

* When the current playback source is a CD Text, CD Text information will be shown. See “To show the text information recorded on a CD Text” on page 28.

■ When the source is other than 3-CD Changer:

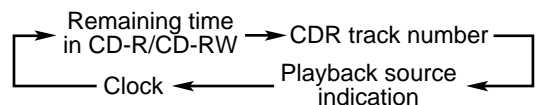

Recording from 3-CD Changer —CD Synchronized Recording

You have three methods to record from 3-CD Changer to CD Recorder.

Using these synchronized recording methods, you can start and playback and recording at the same time.

- **CD Direct Recording**—Records a disc in 3-CD Changer (or the program you have made)—with or without finalization (see page 33).
- **First Track Recording**—Records the first track of each disc in 3-CD Changer.
- **Listening Edit Recording**—Records only tracks you select while playing back discs in 3-CD Changer—with or without finalization (see page 33).

Before starting any of the above recording, adjust the recording input level if necessary. See “To adjust the recording input level” on page 35.

CD Direct Recording

CD Direct Recording allows you to easily record a disc in 3-CD Changer onto a CD-R or CD-RW in CD Recorder.

■ Using the DIRECT REC button

On the unit ONLY:

1 Prepare discs in 3-CD Changer.

- If the current playing source is not 3-CD changer, press CD ► / II, then ■. To select a disc, press DISC repeatedly, then ■.
- You can also use the remote control. When using it, press CD1, CD2, or CD3, then ■.

You can make a program (see page 25) if you want. (But you cannot select Random Play.)

2 Insert a recordable CD-R or CD-RW on the CDR disc tray.

3 Press REC SPEED (inside the sliding panel) if necessary.

- Each time you press the button, recording speed alternates between normal speed and high speed*.

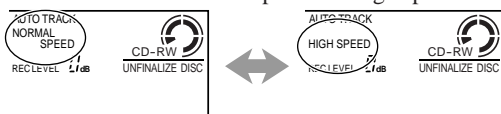

* For CD-R, 4 times normal speed; for CD-RW, 2 times normal speed.

When high speed is selected, recording input level is reset to “0” temporarily, and will not affect the recording.

4 Press DIRECT REC.

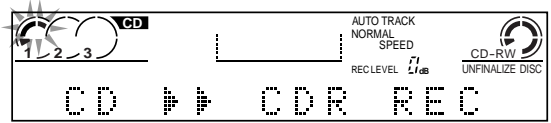

- If OPC (see page 32) is being performed, “UPDATE OPC” flashes first in the main display, then recording starts.

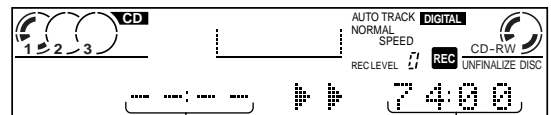

Remaining time of the currently playing track

Remaining time in the CD-R/CD-RW

Recording stops when a selected disc (or a program) is recorded.

- Both 3-CD Changer and CD Recorder stop automatically.

To confirm the recording contents, see “To change the display information while recording” on page 35.

To stop recording, press ■. “STOP DUBBING” flashes for a while.

- Both 3-CD Changer and CD Recorder stop automatically.

To remove the recorded disc, press ▲ CDR.

“FINALIZE ?” flashes in the main display for a while.

- If you do finalize the disc, press FINALIZE. Remember once you finalize a CD-R, no further recording can be made on the disc. (For more details, see “Finalizing a Disc—CD-R/CD-RW” on page 41.)
- If you do not finalize the disc, press ▲ CDR again.



If “SHORT REM. OK ?” appears when you press DIRECT REC

There is not enough remaining time left on the recordable disc. Eject and change a disc or press DIRECT REC one more time to start recording anyway (the entire source disc cannot be recorded in this case).



If you press DIRECT REC while listening to any other source than 3-CD Changer (and CD Recorder)

Recording will also start if a recordable disc is on the CDR disc tray. However, recording will not stop until you press ■.



During CD Direct Recording

Repeat Play will be canceled automatically.

■ Using the REC MODE button

On the unit ONLY:

1 Prepare discs in 3-CD Changer.

- If the current playing source is not 3-CD changer, press CD ► / II, then ■. To select a disc, press DISC repeatedly, then ■.
You can also use the remote control. When using it, press CD1, CD2, or CD3, then ■.

You can make a program (see page 25) if you want. (But you cannot select Random Play.)

2 Insert a recordable CD-R or CD-RW on the CDR disc tray.

3 Press REC SPEED (inside the sliding panel) if necessary.

- Each time you press the button, recording speed alternates between normal speed and high speed*.

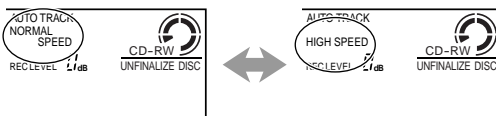

- * For CD-R, 4 times normal speed; for CD-RW, 2 times normal speed.
When high speed is selected, recording input level is reset to “0” temporarily, and will not affect the recording.

4 Press REC MODE (inside the sliding panel) to select “CD REC?” or “CD REC & FINALIZE ?”

- Each time you press the button, recording modes change as follows:

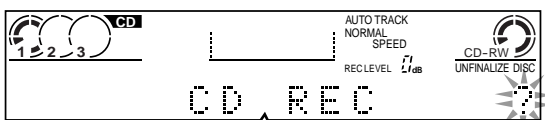

- **CD REC ?**: Select this to perform CD Direct Recording.
- **CD REC & FINALIZE ?**: Select this to automatically finalize the disc after recording.

5 Press REC START (inside the sliding panel).

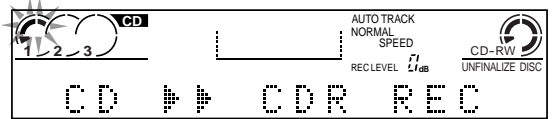

- If OPC (see page 32) is being performed, “UPDATE OPC” flashes first in the main display, then recording starts.

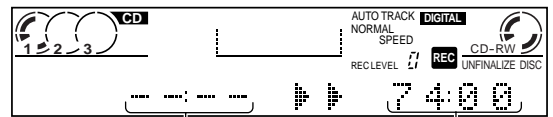

Remaining time of the currently playing track

Remaining time in the CD-R/CD-RW

Recording stops when a selected disc (or a program) is recorded.

- Both 3-CD Changer and CD Recorder stop automatically.

To confirm the recording contents, see “To change the display information while recording” on page 35.

To stop recording, press ■. “STOP DUBBING” flashes for a while. (In this case, the disc will not be finalized even if you have selected “CD REC & FINALIZE ?” in step 4.)

- Both 3-CD Changer and CD Recorder stop automatically.

To remove the recorded disc, press ▲ CDR.

“FINALIZE ?” flashes in the main display for a while if you have selected “CD REC?” in step 4.

- If you do finalize the disc, press FINALIZE.
Remember once you finalize a CD-R, no further recording can be made on the disc. (For more details, see “Finalizing a Disc—CD-R/CD-RW” on page 41.)
- If you do not finalize the disc, press ▲ CDR again.



If “SHORT REM. OK ?” appears when you press REC START

There is not enough remaining time left on the recordable disc. Eject and change a disc or press REC START one more time to start recording anyway (the entire source disc cannot be recorded in this case).



During CD Direct Recording

Repeat Play will be canceled automatically.

First Track Recording

First Track Recording allows you to record the first track of each loaded disc in 3-CD Changer.

You can, for example, make a directory of all your best CDs.

■ Using the REC MODE button ONLY

On the unit ONLY:

1 Prepare discs in 3-CD Changer.

- If the current playing source is not 3-CD changer, press CD ► / II, then ■. To select a disc, press DISC repeatedly, then ■.

You can also use the remote control. When using it, press CD1, CD2, or CD3, then ■.

- If the current play mode is either Program Play or Random Play, press FM/PLAY MODE on the remote control to select Continuous Play.

2 Insert a recordable CD-R or CD-RW on the CDR disc tray.

3 Press REC SPEED (inside the sliding panel) if necessary.

- Each time you press the button, recording speed alternates between normal speed and high speed*.

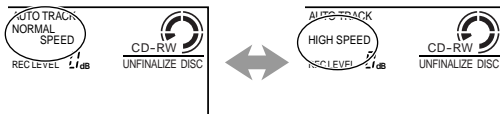

- * For CD-R, 4 times normal speed; for CD-RW, 2 times normal speed. When high speed is selected, recording input level is reset to "0" temporarily, and will not affect the recording.

4 Press REC MODE (inside the sliding panel) to select "1st Tr. REC?"

- Each time you press the button, recording modes change as follows:

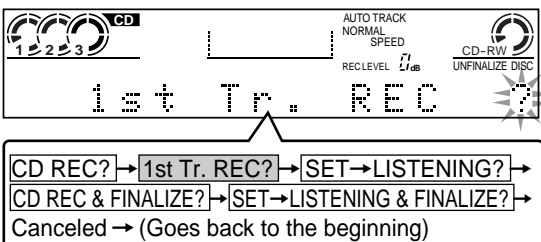

5 Press REC START (inside the sliding panel).

- If OPC (see page 32) is being performed, "UPDATE OPC" flashes first in the main display, then recording starts.

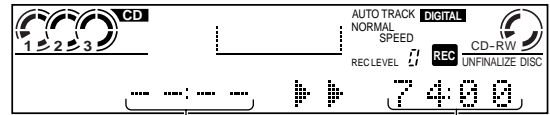

Remaining time of the currently playing track

Remaining time in the CD-R/CD-RW

After the first track of the disc on the CD1 tray is recorded, the first track of the CD on the CD2 tray will be recorded. (If no disc is on the CD tray, it will be skipped.)

After the first tracks of all loaded discs are recorded, First Track Recording stops.

6 Repeat steps 1, 4, and 5 to continuously record more tracks using First Track Recording.

To confirm the recording contents, see "To change the display information while recording" on page 35.

To stop recording, press ■. "STOP DUBBING" flashes for a while.

- Both 3-CD Changer and CD Recorder stop automatically.

To remove the recorded disc, press ▲ CDR.

"FINALIZE ?" flashes in the main display for a while.

- If you do finalize the disc, press FINALIZE. Remember once you finalize a CD-R, no further recording can be made on the disc. (For more details, see "Finalizing a Disc—CD-R/CD-RW" on page 41.)
- If you do not finalize the disc, press ▲ CDR again.



If "SHORT REM. OK ?" appears when you press REC START

There is not enough remaining time left on the recordable disc. Eject and change a disc or press REC START one more time to start recording anyway (the entire track cannot be recorded in this case).



During First Track Recording

Repeat Play will be canceled automatically.

Listening Edit Recording

Listening Edit Recording allows you to make a program while listening and checking each track of the loaded discs (up to 3 discs) in 3-CD Changer, then to start recording the program.

- You can program up to 32 tracks.

■ Using the REC MODE button ONLY

On the unit ONLY:

1 Prepare discs in 3-CD Changer.

- If the current playing source is not 3-CD changer, press CD ► / II, then ■. To select a disc, press DISC repeatedly, then ■. You can also use the remote control. When using it, press CD1, CD2, or CD3, then ■.
- If the current play mode is either Program Play or Random Play, press FM/PLAY MODE on the remote control to select Continuous Play.

2 Insert a recordable CD-R or CD-RW on the CDR disc tray.

3 Press REC SPEED (inside the sliding panel) if necessary.

- Each time you press the button, recording speed alternates between normal speed and high speed*.

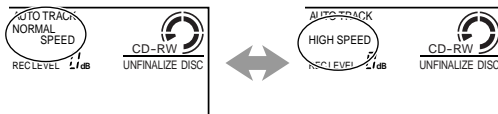

- * For CD-R, 4 times normal speed; for CD-RW, 2 times normal speed.

When high speed is selected, recording input level is reset to "0" temporarily, and will not affect the recording.

4 Press REC MODE (inside the sliding panel) to select "SET→LISTENING?" or "SET→LISTENING & FINALIZE ?"

- Each time you press the button, recording modes change as follows:

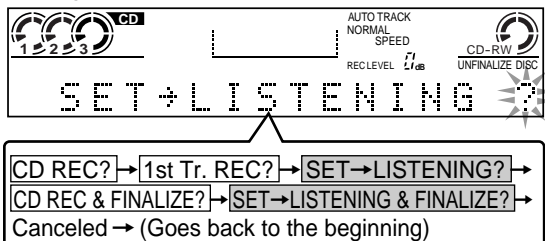

- SET→LISTENING ?**: Select this to perform Listening Edit Recording.
- SET→LISTENING & FINALIZE ?**: Select this to automatically finalize the disc after recording.

5 Press SET (inside the sliding panel).

3-CD Changer starts playing.

- Playback starts from the currently selected disc if two or three discs are loaded.

6 Decide if you want to include the current track in the program or to skip it.

- To include the current playing track in the program**, press SET. The current playing track is programmed and the next track starts playing. (After the last track of a disc is programmed, the first track of the next disc starts playing.)
- To skip the current playing track**, press CANCEL. The current playing track is not programmed and the next track starts playing.

If you do not press either button while the current track is playing, 3-CD Changer will skip the track and play the next track.

7 Repeat step 6 to program other tracks.

When you finish checking all tracks or if there is no more remaining time on the recordable CD-R or CD-RW, Listening Edit Recording starts automatically.

- If the remaining time of the CD-R or CD-RW becomes short, CD Recorder will search for a track fitting into the remaining time. To include the track found in the program, press SET. To find another, press CANCEL.

To stop during editing process and start recording, press REC START.

To confirm the recording contents, see "To change the display information while recording" on page 35.

To stop recording, press ■. "STOP DUBBING" flashes for a while. (In this case, the disc will not be finalized even if you have selected "SET→LISTENING & FINALIZE ?" in step 4.)

- Both 3-CD Changer and CD Recorder stop automatically.

To remove the recorded disc, press ▲ CDR.

"FINALIZE ?" flashes in the main display for a while if you have selected "SET→LISTENING?" in step 4.

- If you do finalize the disc, press FINALIZE. Remember once you finalize a CD-R, no further recording can be made on the disc. (For more details, see "Finalizing a Disc—CD-R/CD-RW" on page 41.)
- If you do not finalize the disc, press ▲ CDR again.



During Listening Edit Recording

Repeat Play will be canceled automatically.

Recording the External Components —Sound Synchronized Recording

With this recording method, you can start recording automatically when the source sound comes into this unit through the LINE IN jacks or the LINE DIGITAL IN terminal.

Observe the following when recording from external component through the LINE DIGITAL IN terminal.

- Make sure that it is connected correctly.
- Make sure to turn it on, and leave it turned on while recording.

- Sound Synchronized Recording will stop automatically if no sound comes in for more than 30 seconds.

On the unit ONLY:

Before recording, adjust the recording input level if necessary.

See “To adjust the recording input level” on page 35.

- 1 Insert a recordable CD-R or CD-RW on the CDR disc tray.
- 2 Press SOURCE repeatedly until “LINE” appears in the main display.
- 3 Press LINE REC SELECT (inside the sliding panel) repeatedly to select either “ANALOG IN” or “DIGITAL IN.”
 - **ANALOG IN:** Select this to record sounds through the LINE IN jacks. The ANALOG indicator lights on the display (analog-to-digital recording).
 - **DIGITAL IN:** Select this to record sounds through the LINE DIGITAL IN terminal. The DIGITAL indicator lights on the display (digital-to-digital recording).
- 4 Press REC MODE (inside the sliding panel) to select “SOUND SYNC. REC?”
 - Each time you press the button, Sound Synchronized Recording turns on and off.

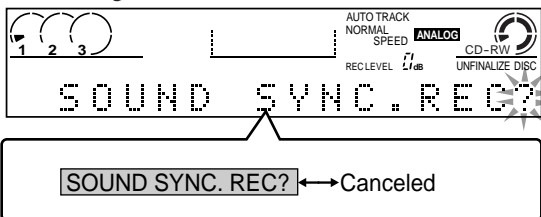

- 5 Press REC START (inside the sliding panel).

The REC indicator flashes on the display for a while.

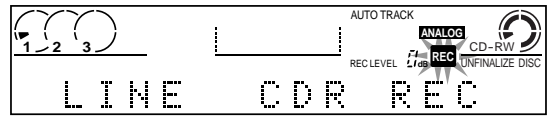

Ex.: When “ANALOG IN” is selected in step 3

- 6 Start playback on the selected external component.

Recording starts automatically when the sound signals come in.



Remaining time in the CD-R/CD-RW

To confirm the recording contents, see “To change the display information while recording” on page 35.

To stop recording, press ■. “STOP DUBBING” flashes for a while.

- Both 3-CD Changer and CD Recorder stop automatically.

To remove the recorded disc, press ▲ CDR.

“FINALIZE ?” flashes in the main display for a while.

- If you do finalize the disc, press FINALIZE. Remember once you finalize a CD-R, no further recording can be made on the disc. (For more details, see “Finalizing a Disc—CD-R/CD-RW” on page 41.)
- If you do not finalize the disc, press ▲ CDR again.



If Sound Synchronized Recording do not work correctly when “ANALOG IN” is selected as the input terminal

Use the Standard Recording method (see page 34).

Sound Synchronized Recording starts automatically when this unit detects sound signals coming in. This means that, if sound signal is too weak for this unit to detect, Sound Synchronized Recording will not start (or will stop even while the source is being played).



When recording from a DAT deck using Sound Synchronized Recording

Two track marks may be recorded at the beginning of the recording. If this occurs, record a skip mark so that either track mark will be ignored during playback. (See page 45.)

Recording a Single Track during Play

You can record the current track while playing back a disc on 3-CD changer.

- If a recordable disc is not loaded, “CDR NO DISC” appears in the main display. Insert a recordable CD-R or CD-RW.

■ Using the DIRECT REC button

On the unit ONLY:

Press **DIRECT REC** while playing back or pausing a track you want to record.

Playback of that track is stopped, and the same track starts playing from the beginning again. This time, CD Recorder starts recording the track.

■ Using the REC MODE button

On the unit ONLY:

1 Press **REC MODE** (inside the sliding panel) repeatedly, while playing back or pausing a track you want to record until “1Tr. REC ?” or “AUTO LEVEL CONTROL REC ?” appears in the main display.

- You cannot select “AUTO LEVEL CONTROL REC ?” when high-speed recording is selected. If this happens, press **REC SPEED** once to select normal speed recording.

1Tr. REC ?:

Select this to record the current track **without** input level adjustment.

AUTO LEVEL CONTROL REC ?:

Select this to record the current track **with** input level adjustment.

2 Press **REC START** (inside the sliding panel).

- **When “1Tr. REC ?” is selected:** Playback of that track is stopped, and the same track starts playing from the beginning again. This time, CD Recorder starts recording the track.
- **When “AUTO LEVEL CONTROL REC ?” is selected:** Playback of that track is stopped, and the same track starts playing from the beginning again. In the first playback, CD Recorder checks the recording condition of the track and adjusts the recording level without recording. (“LEVEL ADJUST” flashes in the main display.) Then when the second playback starts, CD Recorder starts recording the track.

After the track is recorded, both 3-CD Changer and CD Recorder stop.

Finalizing a Disc—CD-R/CD-RW

Finalization is the final process in recording on a CD-R or CD-RW. “Finalizing a disc” means writing the TOC (Table of Contents) on the recorded disc.

Only after this process is completed, a recorded CD-R or CD-RW can be played back on a CD player compatible with CD-R/CD-RW.

Before you start...

- Once a CD-R has been finalized, no further recording can be made on the disc.
- If you unplug the power cord or if a power failure occurs during finalization process, recorded data will be lost and the disc may not be utilized any more.

On the unit ONLY:

1 Insert a disc you want to finalize on the CDR disc tray.

- If a disc is being played on 3-CD Changer, press ■ to stop playback.

2 Press **FINALIZE**.

“FINALIZE ?” appears in the main display.

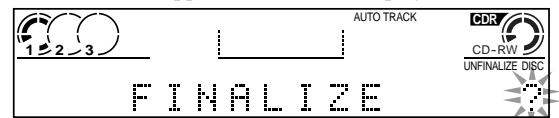

- If you want to cancel finalization, press **CANCEL**.

3 Press **FINALIZE** again to finalize the disc.

The **REC** indicator lights and “FINALIZE” starts flashing during finalization.



- The finalization process requires about a few minutes to complete (when finalized, the **REC** indicator goes off and “FINALIZE” stops flashing and goes off).

To unfinalize a CD-RW, see “Unfinalizing a Disc (Only for CD-RW)” on page 46.

The buttons and controls enlarged in the illustration below are used and explained in this section (pages 43 to 46).

Remote control

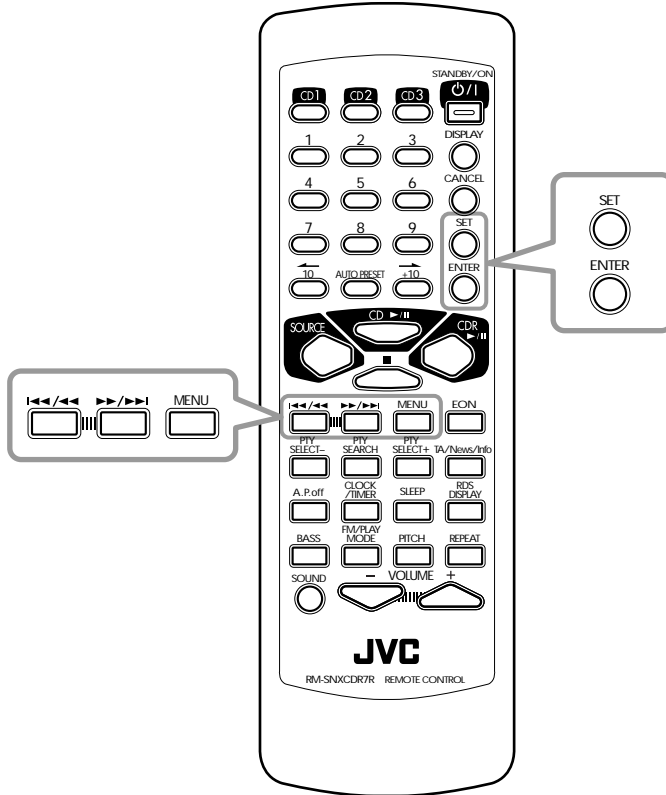

You cannot use the buttons and controls on the unit.
Use only the remote control.

By pressing MENU, you can use (or cancel) the following convenient CD Recorder functions:

-
- AUTO TRACK:** Selects either auto-track marking or manual track marking (see the right column.)
-
- TRACK SPACE:** Automatically places a 2-second blank space at the beginning of each track on a recorded disc (see page 44).
-
- CONVERTER:** Turns on or off the built-in sampling frequency rate converter (see page 44).
-
- TRACK SKIP:** Records a skip mark to an unwanted track so that it will be skipped (ignored as if it does not exist) during play (see page 45).
-
- TRACK ERASE:** Erases the unwanted tracks on a CD-RW (see page 45).
-
- DISC ERASE:** Erases all the recorded tracks on a CD-RW (see page 46).
-
- UNFINALIZE:** Erases the TOC (Table of Contents) of a finalized CD-RW (see page 46).
-

Before using the following functions explained in this section, make sure of the following.

- The following procedures are only possible when CD Recorder is selected as the source and playback is not started.
- To stop any time during the following procedures, press CANCEL.

Recording Track Marks Manually —Manual Track-Marking

When auto track-marking is activated (initial setting at the factory), track marks are recorded automatically (see “Auto track-marking” on page 32 for more details).

To cancel auto-track marking and use manual track marking, follow the procedure below.

On the remote control ONLY:

1 Press MENU repeatedly until “AUTO TRACK” appears in the main display.

- Each time you press the button, the following menu items appear as follows:

AUTO TRACK

TRACK ERASE	→	DISC ERASE	→	UNFINALIZE	→
TRACK SKIP	→	AUTO TRACK	→	TRACK SPACE	→
CONVERTER	→	Canceled → (back to the beginning)			

2 Press SET.

The current setting for auto-track marking appears.

AUTO TRACK

Ex.: When auto-track marking is activated (initial setting)

3 Press **▶▶** or **◀◀** to select “AUTO TRACK OFF” then press ENTER.

The AUTO TRACK indicator goes off from the display, and auto track-marking is canceled, and now you can put track marks manually during recording.

- To put track marks during recording, press SET at the point where you want to put a track mark.

To restore auto track-marking, repeat steps 1 to 2 and select “AUTO TRACK ON” then press ENTER in step 3.

- The AUTO TRACK indicator lights on the display.



About manual track-marking

- Track marks must be recorded apart from each other by 4 seconds. If you press SET twice within 4 seconds, the second press of the button will be ignored (only one track mark will be recorded where you press SET for the first time).
- You cannot put track marks manually during CD Synchronized Recording. (Auto track-marking is activated temporarily.)

Separating Recorded Tracks Automatically—Auto-Track Space

While recording from the 3-CD Changer onto CD Recorder using Standard Recording method (see page 34), CD Recorder automatically places a 2-second blank space at the beginning of each track in the recording. When shipped from the factory, this function is turned “ON.”

- This function works when “AUTO TRACK” is set to “ON.” (See page 43.)

To cancel Auto-Track Space, follow the procedure below:

On the remote control ONLY:

- 1 Press MENU repeatedly until “TRACK SPACE” appears in the main display.

- Each time you press the button, the following menu items appear as follows:

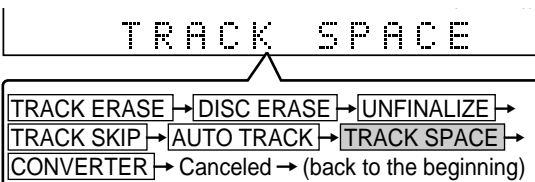

- 2 Press SET.

The current setting for Track Space appears.



Ex.: When Track Space is activated (initial setting)

- 3 Press ►► or ◀◀ to select “TR SPACE OFF” then press ENTER.

To activate Track Space, repeat steps 1 to 2 and select “TR SPACE ON” then press ENTER in step 3.

Turning On or Off Sampling Frequency Rate Converter

The sampling frequency rate converter built in the CD Recorder allows you to record a digital source having sampling frequency (fs) of 32 kHz, 44.1 kHz, or 48 kHz by converting the fs of the source signals into 44.1 kHz (required fs to record on CD Recorder).

When the sampling frequency converter is turned “OFF,” digital signals are sent to CD Recorder bypassing the sampling frequency converter (without conversion).

- Normally set it to “ON” (Initial setting at the factory).
Only when you record dts CD or HDCD signals coming through the LINE DIGITAL IN terminal, turn off the sampling frequency rate converter.

To turn off Converter, follow the procedure below:

On the remote control ONLY:

- 1 Press MENU repeatedly until “CONVERTER” appears in the main display.

- Each time you press the button, the following menu items appear as follows:

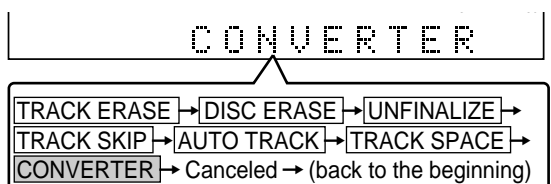

- 2 Press SET.

The current setting for Converter appears.



Ex.: When Converter is activated (initial setting)

- 3 Press ►► or ◀◀ to select “CONVERTER OFF” then press ENTER.

To activate Converter, repeat steps 1 to 2 and select “CONVERTER ON” then press ENTER in step 3.

Recording Skip Marks onto a CD-R/CD-RW

Before finalizing a disc, you can record a skip mark to an unwanted track so that it will be skipped (ignored as if it does not exist) during play.

IMPORTANT

- Once skip marks are recorded, they cannot be erased (you can only erase skip marks by erasing the tracks with skip marks).
- If you unplug the power cord or if a power failure occurs while “WRITE SKIP” is flashing in the main display (in step 3), the disc may not be utilized any more.

On the remote control ONLY:

- 1 Press MENU repeatedly until “TRACK SKIP” appears in the main display.
 - Each time you press the button, the following menu items appear as follows:

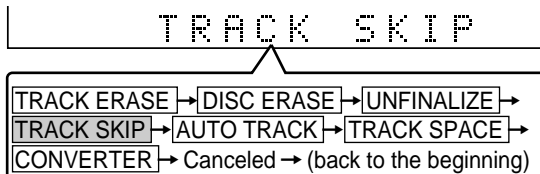

- 2 Press SET.

The following indication appears in the main display.

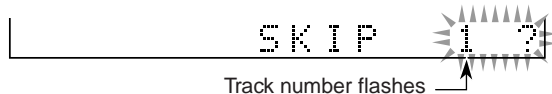

- 3 Press ►► or ◄◄ to select a track you want to skip (during play) then press ENTER.

The SKIP ON indicator lights on the display.



- 4 Repeat steps 1 to 3 until you record skip marks to all unwanted tracks.
 - You can record up to 21 skip marks on a disc.



More about skip marks

- “Skipping tracks during play” does not mean erasing recorded data. Therefore the remaining time of the disc will not change.
- Tracks with skip marks will be skipped only when playing the disc on CD Recorder and other CD player which can read these skip marks.

Erasing Tracks (Only for CD-RW)

Before finalizing a disc, you can erase recorded tracks—from a selected track up to the last track—on a CD-RW at a time.

- To erase recorded tracks on a finalized CD-RW, unfinalize the disc first (see page 46).

IMPORTANT

- Once erasure is performed, erased data cannot be restored.
- If you unplug the power cord or if a power failure occurs while “ERASE TRACK” is flashing in the main display (in step 4), the disc may not be utilized any more.

On the remote control ONLY:

- 1 Press MENU repeatedly until “TRACK ERASE” appears in the main display.
 - Each time you press the button, the following menu items appear as follows:

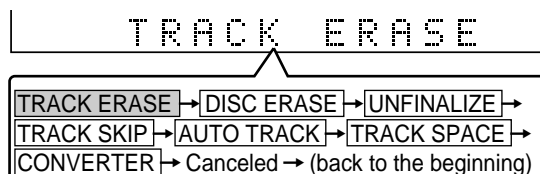

- 2 Press SET.

The following indication appears in the main display.



- Erasure start track number, when it appears, is the same as the last track number. (In the above example, 18 tracks are recorded on the CD-RW.)

- 3 Press ►► or ◄◄ to select the erasure start track.
 - You can also use the number buttons to select the track. (See “To go to another track directly using the number buttons” on page 30.)



Ex.: When you erase the 12th track up to the last

- 4 Press ENTER.

While erasure is performed, “ERASE TRACK” flashes in the main display. (The REC indicator also lights on the display.)



Erasing All Tracks (Only for CD-RW)

You can erase all the recorded tracks on a **CD-RW** at a time.

Before you start...

- Once erasure is performed, erased data cannot be restored.
- If you unplug the power cord or if a power failure occurs while "ERASE DISC" is flashing in the main display (in step 3), the disc may not be utilized any more.

On the remote control ONLY:

1 Press **MENU** repeatedly until "DISC ERASE" appears in the main display.

- Each time you press the button, the following menu items appear as follows:

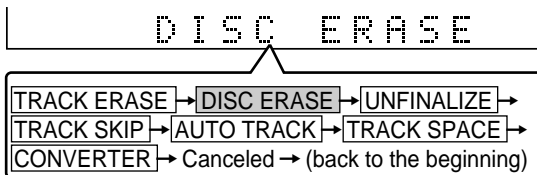

2 Press **SET**.

The confirmation message appears.

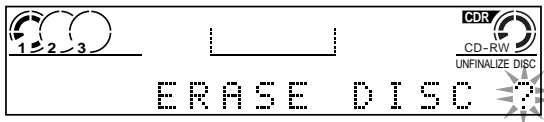

3 Press **ENTER**.

While erasure is performed (for about 90 seconds), "ERASE DISC" flashes in the main display. (The REC indicator also lights on the display.)

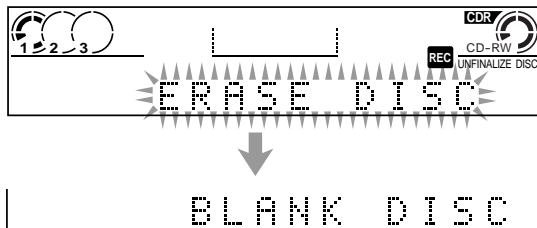

Unfinalizing a Disc (Only for CD-RW)

By erasing the TOC (Table of Contents) of a finalized CD-RW, you will be able to record on the CD-RW again.

This erasing process of the TOC is called "Unfinalization."

- Unfinalization is just to erase the TOC only, but not the recorded music signals on the disc.

IMPORTANT

If you unplug the power cord or if a power failure occurs while "UNFINALIZE" is flashing in the main display (in step 3), the disc may not be utilized any more.

On the remote control ONLY:

1 Press **MENU** repeatedly until "UNFINALIZE" appears in the main display.

- Each time you press the button, the following menu items appear as follows:

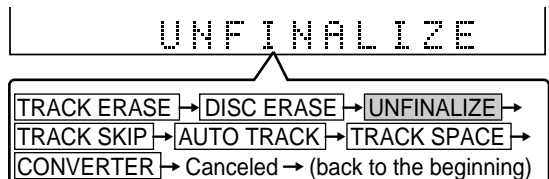

2 Press **SET**.

The confirmation message appears.

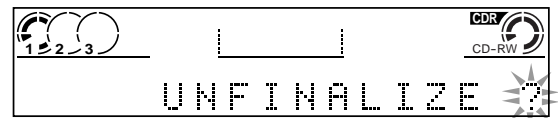

3 Press **ENTER**.

While erasure is performed (for about 90 seconds), "UNFINALIZE" flashes in the main display.

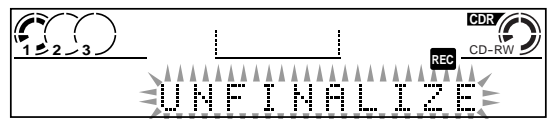

Using the Timers

The buttons and controls enlarged in the illustration below are used and explained in this section (pages 48 to 52).

Remote control

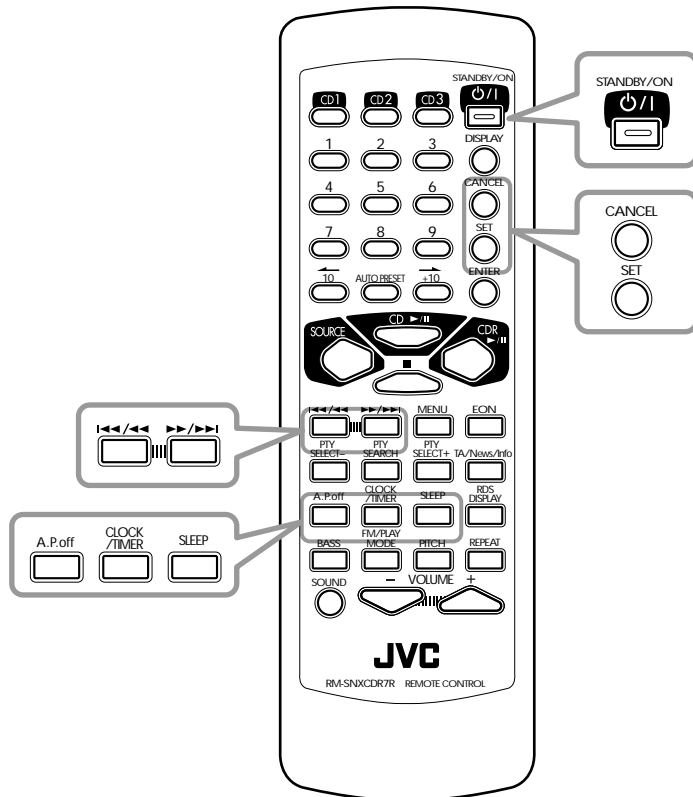

You cannot use the buttons and controls on the unit.
Use only the remote control.

There are three timers available—Recording Timer, Daily Timer, and Sleep Timer.

Before using these timers, you need to set the clock built in the unit.

- In addition to these three timers, you can also use Auto Power Off to shut off the power automatically.

Setting the Clock

You can set the clock whether the unit is turned on or off (on standby).

- If you have activated the power consumption saving mode (“DISPLAY OFF”), you cannot adjust the clock while the unit is turned off (on standby). For details, see page 14.

On remote control ONLY:

1 Press CLOCK/TIMER.

The hour digit in the main display starts flashing.

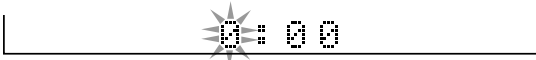

2 Press ►► / ►►► or ◀◀ / ◀◀◀ to adjust the hour, then press SET.

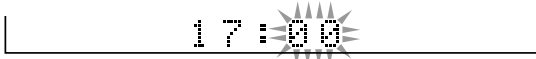

- If you want to correct the hour after pressing SET, press CANCEL. The hour digit starts flashing again.

3 Press ►► / ►►► or ◀◀ / ◀◀◀ to adjust the minute, then press SET.

The built-in clock starts working.

To adjust the clock again

Once you have adjusted the clock, you need to press CLOCK/TIMER repeatedly until the clock setting screen appears in the main display (the hour digit starts flashing).



When you unplug the AC power cord or if a power failure occurs

The clock will be reset to “0:00” in about one minute.

Using Recording Timer

With Recording Timer, you can make an unattended recording.

- You can set Recording Timer whether the unit is turned on or off (on standby).
- To correct a misentry any time during the process, press CANCEL.
- To cancel the setting any time during the process, press CLOCK/TIMER.

How Recording Timer actually works

The unit automatically turns on about 3 minutes before timer recording starts, then turns off the volume and starts recording on CD Recorder when the timer on-time comes. When the timer off-time comes, the unit automatically turns off (stands by).

- Recording Timer works only once, but the timer settings remain stored in memory.

Before you start....

- Make sure that a recordable CD-R or CD-RW is inserted on the CDR disc tray. If not, insert a recordable CD-R or CD-RW.
- When you want to record from the external component (“LINE”), make sure the input you want to use is currently selected—either “ANALOG IN” or “DIGITAL IN.” (See page 34 for more details.)

On remote control ONLY:

1 Press CLOCK/TIMER repeatedly until the Recording Timer on-time setting screen appears in the main display.

The ⌚ (Timer) indicator lights and the REC (Recording Timer) indicator starts flashing on the display.

- Each time you press the button, the timer mode changes as follows:

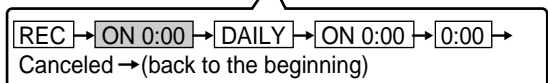
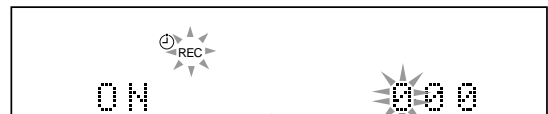

* “0:00” is the initial setting time at the factory.

To be continued

2 Press ►► / ►►| or |◄◄ / ◄◄ to set the hour of the on-time, then press SET.

3 Press ►► / ►►| or |◄◄ / ◄◄ to set the minute of the on-time, then press SET.

4 Press ►► / ►►| or |◄◄ / ◄◄ to set the hour of the off-time, then press SET.

5 Press ►► / ►►| or |◄◄ / ◄◄ to set the minute of the off-time, then press SET.

6 Press ►► / ►►| or |◄◄ / ◄◄ to select the source, then press SET.

- The source changes as follows:

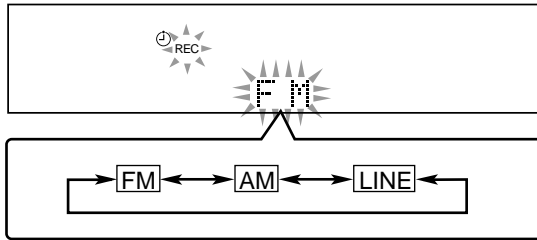

- FM:** Tunes into an FM station.
- AM:** Tunes into an AM (MW/LW) station.
- LINE*:** Selects the external component as the source through the currently selected input—“ANALOG IN” or “DIGITAL IN.”

* To operate the component with the Recording Timer, it also needs to have the timer function.

7 If you have selected “FM” or “AM” as the source in the above step, select a preset number.

Press ►► / ►►| or |◄◄ / ◄◄ to select a preset station, then press SET.

If you have selected “LINE” as the source in the above step, simply press SET.

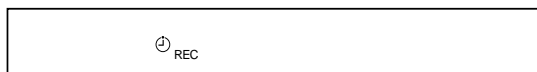

The REC (Recording Timer) indicator stops flashing, and remains lit.

8 Press ⏻ to turn off the unit (on standby) if you have set the timer with the unit turned on.

IMPORTANT: If you turn off the unit within 4 minutes before the timer on-time, timer recording will not start.

To turn on or off Recording Timer after its setting is done

1 Press CLOCK/TIMER repeatedly until “REC” appears in the main display.

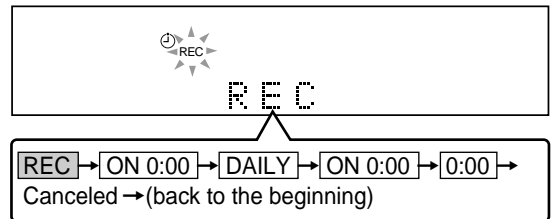

* “0:00” is the initial setting time at the factory.

2 To turn off the Recording Timer, press CANCEL to select “REC OFF.”

The ⏻ (Timer) and REC (Recording Timer) indicators go off from the display.

The Recording Timer is canceled, but the setting for the Recording Timer remains in memory.

To turn on the Recording Timer, press SET.

The ⏻ (Timer) and REC (Recording Timer) indicators light on the display. The settings you have done are shown in the main display for your confirmation.



If you change the source or press CLOCK/TIMER or SLEEP while a timer recording is being performed

Recording Timer is canceled (but recording continues). The unit does not turn off automatically.

- When you set Sleep Timer by pressing SLEEP, the unit turns off as you set by Sleep Timer.

Using Daily Timer

With Daily Timer, you can wake up to your favorite music or radio program.

- You can set Daily Timer whether the unit is turned on or off (on standby).
- To correct a misentry any time during the process, press CANCEL.
- To cancel the setting any time during the process, press CLOCK/TIMER.

How Daily Timer actually works

The unit automatically turns on about 3 minutes before Daily Timer playback starts, then starts playing the specified source when the timer on-time comes. The volume level increases to the preset level step by step. When the timer off-time comes, the unit automatically turns off (stands by).

- Daily Timer works every day, and the timer settings remain stored in memory until you reset them.

On remote control ONLY:

- 1 Press **CLOCK/TIMER** repeatedly until the **Daily Timer on-time setting screen appears in the main display.**

The  (Timer) indicator lights and the **DAILY** (Daily Timer) indicator starts flashing on the display.

- Each time you press the button, the timer mode changes as follows:

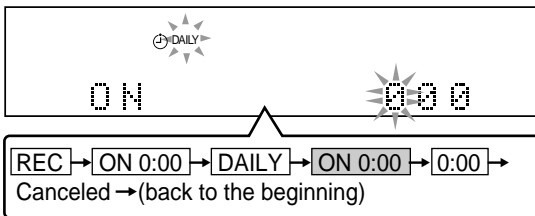

* "0:00" is the initial setting time at the factory.

- 2 Press **▶▶ / ▶▶|** or **◀◀ / ◀◀|** to set the hour of the on-time, then press **SET**.
- 3 Press **▶▶ / ▶▶|** or **◀◀ / ◀◀|** to set the minute of the on-time, then press **SET**.

- 4 Press **▶▶ / ▶▶|** or **◀◀ / ◀◀|** to set the hour of the off-time, then press **SET**.
- 5 Press **▶▶ / ▶▶|** or **◀◀ / ◀◀|** to set the minute of the off-time, then press **SET**.
- 6 Press **▶▶ / ▶▶|** or **◀◀ / ◀◀|** to select the source, then press **SET**.

- The source changes as follows:

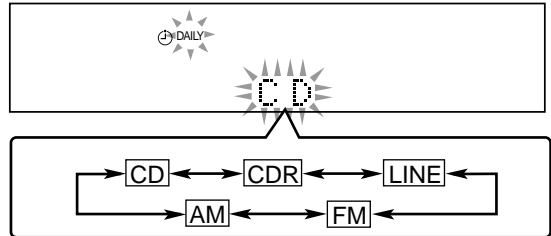

- CD:** Plays a disc in 3-CD Changer.
→ Prepare a disc, then go to step 7 to select the disc number.
- CDR:** Plays a disc in CD Recorder.
→ Prepare a disc, then go to step 8.
- LINE*:** Selects the external component connected to the LINE IN jacks.
→ Make the external component ready for playback, then go to step 8.
- FM:** Tunes into an FM station.
→ go to step 7 to select a preset station.
- AM:** Tunes into an AM (MW/LW) station.
→ go to step 7 to select a preset station.

* To operate the component with the Daily Timer, it also needs to have the timer function.

7 **If you have selected “CD” as the source in the above step,** select a disc number.

Press ►► / ►►| or |◄◄ / ◄◄ to select the disc number (CD 1, CD 2, or CD 3), then press SET.

IMPORTANT: When selecting a disc number, make sure that a disc is already loaded on the selected disc number tray. If there is no disc on the tray, playback will not start.

If you have selected “FM” or “AM” as the source in the above step, select a preset station.

Press ►► / ►►| or |◄◄ / ◄◄ to select a preset station, then press SET.

8 Press ►► / ►►| or |◄◄ / ◄◄ to adjust the volume level, then press SET.

The DAILY (Daily Timer) indicator stops flashing and remains lit.



9 Press ⏻/| to turn off the unit (on standby) if you have set the timer with the unit turned on.

IMPORTANT: If you turn off the unit within 4 minutes before the timer on-time, Daily Timer playback will not start.



If the unit is kept turned on when the timer on-time comes

Daily Timer does not work at all.



If you change the source or press CLOCK/TIMER or SLEEP while Daily Timer playback is being performed

Daily Timer is canceled and the unit does not turn off automatically.

- When you set Sleep Timer by pressing SLEEP, the unit turns off as you set by Sleep Timer.

To turn on or off Daily Timer after its setting is done

1 Press CLOCK/TIMER repeatedly until “DAILY” appears in the main display.

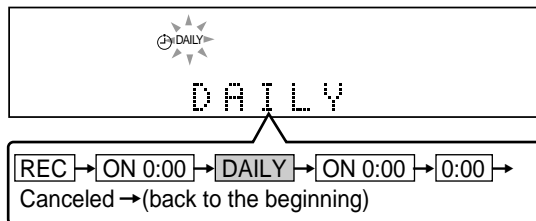

* “0:00” is the initial setting time at the factory.

2 To turn off the Daily Timer, press CANCEL to select “DAILY OFF.”

The ⌚ (Timer) and DAILY (Daily Timer) indicators go off from the display.

The Daily Timer is canceled, but the setting for the Daily Timer remains in memory.

To turn on the Daily Timer, press SET.

The ⌚ (Timer) and DAILY (Daily Timer) indicators light on the display. The settings you have done are shown in the main display for your confirmation.

Using Sleep Timer

With Sleep Timer, you can fall asleep to your favorite music or radio program.

- You can set Sleep Timer when the unit is turned on.

How Sleep Timer actually works

The unit automatically turns off after the specified time length passes.

On the remote control ONLY:

1 Press SLEEP.

- Each time you press the button, the time length changes as follows:

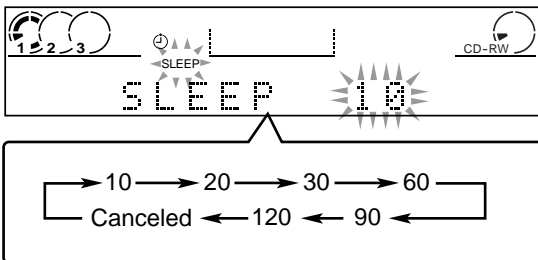

2 Wait for about 5 seconds after specifying the time length.

The display dims.

To check the remaining time until the shut-off time, press SLEEP once. The remaining time until the shut-off time appears for about 5 seconds.

To change the shut-off time, press SLEEP repeatedly until the time length you want appears.

To cancel the setting, press SLEEP repeatedly so that the SLEEP indicator goes off.

- Sleep Timer is also canceled when you turn off the unit.



If you press SLEEP while Recording Timer or Daily Timer is operating

The operating timer will be canceled.

To sleep with the Sleep Timer and wake up with the Daily Timer

The unit turns off when the shut-off time comes (set by Sleep Timer), and turns on when the timer on-time (set by Daily Timer) comes.

1 Set the Daily Timer (see pages 50 and 51).

2 Start playing back any source you want to listen to until you sleep.

3 Set the Sleep Timer.

Using Auto Power Off

You can use this function only while playing a disc either on 3-CD Changer or on CD Recorder.

Auto Power Off automatically turns off the unit if no sound comes in for more than about 3 minutes.

If any operation is done during this 3-minute period (approximately), Auto Power Off is canceled temporarily even though no sound comes in.

On the remote control ONLY:

Press A.P.off so that the A.P.off indicator lights on the display.

- Each time you press the button, Auto Power Off turns on and off.

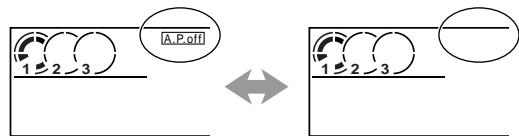

- When Auto Power Off is activated, the A.P.off indicator lights on the display.

The A.P.off indicator starts flashing if no sound comes in. When the remaining time until the shut-off time becomes 10 seconds, "AUTO P.OFF" appears and flashes in the main display.

Maintenance

To get the best performance of the unit, keep your discs and mechanism clean.

General Notes

In general, you will have the best performance by keeping your discs and the mechanism clean.

- Store discs in their cases, and keep them in cabinets or on shelves.
- Keep the disc trays closed when not in use.

To handling discs

When removing a disc from its case, press down the center holder of the case and lift the disc out, holding it by the edges.

- Always hold the disc by the edges. Do not touch its recording surface. When storing a disc into its case, gently insert the disc around the center holder (with the printed surface facing up).
- Make sure to store discs into the cases after use.
- Be careful not to scratch the surface of the disc when placing it back in its case.
- Avoid exposure to direct sunlight, temperature extremes, and moisture.

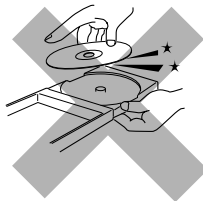
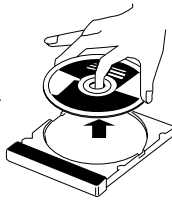

To clean the disc

Wipe the disc with a soft cloth in a straight line from center to edge.



DO NOT use any solvent—such as conventional record cleaner, spray, thinner, or benzine—to clean the disc.

To play new discs

New discs may have some rough spots around the inner and outer edges. If such a disc is used, this unit may reject the disc.

To remove these rough spots, rub the edges with a pencil or ballpoint pen, etc.

Moisture condensation

Moisture may condense on the lens inside the unit in the following cases:

- After starting the heater.
- When the unit is moved from the extremely hot place to the extremely cold place.

Should this occur, the unit may malfunction. In this case, eject the disc and leave the unit turned on for a few hours until the moisture evaporates.



- DO NOT expose discs to direct sunlight or any heat source or place them in a place subject to high temperature and humidity.
- DO NOT leave discs in a car.

To clean the unit

• Stains on the unit

Should be wiped off with a soft cloth. If the unit is heavily stained, wipe it with a cloth soaked in water-diluted neutral detergent and wrung well, then wipe clean with a dry cloth.

• Since the unit may deteriorate in quality, become damaged or get its paint peeled off, be careful about the followings.

- DO NOT wipe it with a hard cloth.
- DO NOT wipe it strong.
- DO NOT wipe it with thinner or benzine.
- DO NOT apply any volatile substance such as insecticides to it.
- DO NOT allow any rubber or plastic to remain in contact with it for a long time.

Glossary

OPC (Optimum Power Control)

OPC is a function that checks the loaded disc and automatically adjusts the laser for optimum recording setting before recording through the Digital Optical Input terminal.

PCA (Power Calibration Area)

A space reserved at the beginning of a CD-R/CD-RW for calibrating the laser output power required to record on that disc.

PMA (Program Memory Area)

A temporary memory area on a CD-R/CD-RW, where the information about the recordings on the disc—track numbers, tracks' start points and end points, etc. is stored until the disc is finalized.

When the disc is finalized, this information is written in the TOC (see below).

Sampling Frequency

When analog signals are converted into digital signals, they are divided into many points and digitized. This dividing method is called "sampling." The sampling frequency indicates how many points one second is divided into—for example, for CD sound, one second is divided into 44 100 points since its sampling frequency is 44.1 kHz.

SCMS (Serial Copy Management System)

Digital audio components, such as CD recorder, MD (Mini-Disc) recorder and DAT (Digital Audio Tape) recorder, can exchange audio signals in the digital forms through digital input/output terminals. The digital audio components allow digital copy of music signals with little deterioration. This has made it necessary to have a copy restriction rule for protecting the copyright, and "SCMS (Serial Copy Management System)" has been established as a result.

To protect the copyright, the SCMS allows only first-generation digital copies to be made from premastered software (like CDs or prerecorded MDs).

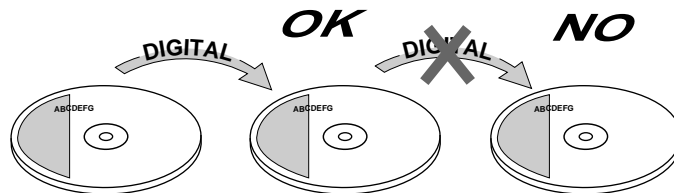

TOC (Table of Contents)

TOC is a kind of disc information containing sub-data (track number, playing time, etc.) that enables us to search for tracks quickly on the disc.

To write the TOC on a CD-R or CD-RW, you need to finalize the disc.

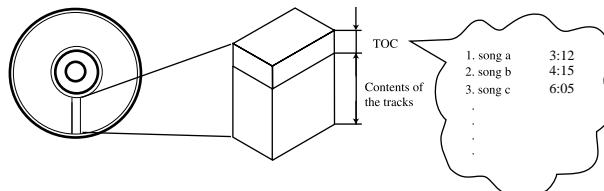

Messages

Message	Signification	Solution
ALL SKIP TR	Skip marks are recorded to all the tracks.	Replace the disc.
ALREADY FINAL	You are trying to erase a track or add a skip mark on a finalized disc.	
ALREADY UNFIN.	You are trying to unfinalize an unfinalized disc.	
BLANK DISC	Loaded disc is blank.	
CANNOT ERASE	Loaded disc is damaged. Erasure on this disc is impossible.	Replace the disc.
CANNOT FIN.	Loaded disc is damaged. Finalization on this disc is impossible.	Replace the disc.
CANNOT LISTEN	You are trying to adjust the volume during high-speed recording.	During high-speed recording, no sound can be heard; therefore you cannot adjust the volume.
CANNOT REC	Disc is damaged. Recording on this disc is impossible.	Replace the disc.
CANNOT UNFIN.	Loaded disc is damaged. Unfinalization on this disc is impossible.	Replace the disc.
CDR DISC NG	Loaded CD-R is damaged.	Replace the disc.
DAO DISC	You are trying to unfinalize a CD-RW which has been recorded using the "Disc At Once" recording system.	Replace the disc.
DISC FULL	You are trying to record on a fully recorded CD-R or CD-RW.	Replace the disc.
NOT AUDIO IN	Incoming digital signal is not of an audio format.	Check the source played on the external component connected to the LINE DIGITAL IN terminal.
NOT REC MUTE	You are trying to use the REC MUTE button during Synchronized Recording.	You can only use the REC MUTE button during Standard Recording.
NO AUDIO DISC	Loaded disc is not an audio disc.	Replace the disc.
NO RW DISC	You are trying to perform one of the functions which is only possible on a CD-RW.	Load a CD-RW.
NO R/RW DISC	You are trying to perform one of the functions which is only possible on a CD-R or CD-RW.	Load a CD-R or CD-RW.
OPC ERROR	OPC cannot be performed. No recording or erasure can be performed on this disc.	Replace the disc.
OPC FULL	PCA is full. No recording or erasure can be performed on this disc.	Replace the disc.
PMA FULL	PMA is full. No recording or erasure can be performed on this disc.	Replace the disc.
SCMS PROTECT	Digital recording is prohibited in accordance with SCMS regulations.	See "SCMS" on page 54.
SHORT REMAIN	The remaining time on a disc is shorter than the playing time of the track you are trying to record.	
SKIP FULL	21 skip marks are already recorded.	
TNO FULL	99 tracks have been recorded. No further recording is possible.	
UNLOCK	The external digital component is not connected properly or is turned off, or its signals are incompatible.	Check the connection, or playback source.
UPDATE OPC	OPC is being performed before recording, if a disc is just inserted in CD Recorder.	This is normal. After OPC is correctly done, recording starts.

Troubleshooting

If you are having a problem with your unit, check this list for a possible solution before calling for service.

If you cannot solve the problem from the hints given here, or the unit has been physically damaged, call a qualified person, such as your dealer, for service.

Symptom	Possible Cause	Action
No sound is heard.	<ul style="list-style-type: none"> • Connections are incorrect, or loose. • CD-ROM is loaded. 	<ul style="list-style-type: none"> • Check all connections and make corrections. (See pages 8 – 11.) • Replace the disc .
Unable to record on a CD-R or CD-RW.	<ul style="list-style-type: none"> • CD-R or CD-RW has been loaded upside down. (“NO DISC” appears on the display.) • Finalized CD-R or CD-RW has been loaded. • Disc is dirty or scratched. 	<ul style="list-style-type: none"> • Insert the disc correctly. • CD-R: Replace the disc. CD-RW: Unfinalize the CD-RW (see page 46). • Clean or replace the disc (see page 53).
Poor radio reception.	<ul style="list-style-type: none"> • The antenna is not connected correctly. • The AM (MW/LW) loop antenna is too close to the unit. • The FM antenna is not properly extended and positioned. 	<ul style="list-style-type: none"> • Reconnect the antenna securely. • Change the position and direction of the AM (MW/LW) loop antenna. • Extend FM antenna to the best reception position.
Unable to operate the remote control.	<ul style="list-style-type: none"> • The path between the remote control and the remote sensor on the unit is blocked. • The batteries have lost their charge. 	<ul style="list-style-type: none"> • Remove the obstruction. • Replace the batteries. (See page 12.)
Loaded discs cannot be ejected.	<ul style="list-style-type: none"> • The main AC power cord is not plugged in. • Disc Lock is in use. 	<ul style="list-style-type: none"> • Plug in the AC power plug. • Turn off Disc Lock. (See page 28.)
The disc does not play.	The disc is upside down.	Put the disc in with the label side up.
The disc play skips.	The disc is dirty or scratched.	Clean or replace the disc. (See page 53.)
Operations are disabled.	The built-in microprocessor has malfunctioned due to external electrical interference.	Unplug the unit then plug it back in.

IMPORTANT

- If you are going to record something important, always test-record first to check that the recording turns out properly before proceeding with the actual recording.
- The manufacturer assumes no liability whatsoever for any damage resulting from missed opportunity or accidental erasure that occurs while conducting recording or playback operations due to malfunctioning of or trouble in the unit, or for any incidental damage.

Specifications

Amplifier

Output Power (IEC 268-3/DIN):

19 W per channel, min. RMS, both channels driven into $6\ \Omega$ at 1 kHz, with no more than 0.9% total harmonic distortion

Audio input sensitivity/Impedance (at 1 kHz)

Analog input:

LINE IN: 125 mV/47 k Ω (at "LEVEL 2")
500 mV/47 k Ω (at "LEVEL 1")
1.3 V/47 k Ω (at "LEVEL 3")

Digital input:

LINE DIGITAL IN: OPTICAL

Signal wave length: 660 nm
Input level: -23 dBm to -15 dBm
(With the built-in sampling rate converter, corresponding to 32 kHz/44.1 kHz/48 kHz)

Audio output level/Impedance (at 1 kHz)

Analog output:

LINE OUT: 160 mV/2.2 k Ω

Digital output:

3CD DIGITAL OUT: OPTICAL

Signal wave length: 660 nm
Output level: -23 dBm to -15 dBm

Speakers/Impedance: $6\ \Omega$ — $16\ \Omega$

Tuner

FM tuning range:

87.50 MHz — 108.00 MHz

AM (MW/LW) tuning range:

MW: 522 kHz — 1 629 kHz
LW: 144 kHz — 288 kHz

CD player

CD Capacity:	3 CDs
Dynamic range:	88 dB
Signal-to-noise ratio:	95 dB
Wow and flutter:	Immeasurable

CD Recorder

System:	Compact disc digital audio recording system
Sampling frequency:	44.1 kHz
Dynamic range:	91 dB
Signal-to-noise ratio:	94 dB
Frequency response:	20 Hz to 20 kHz
Wow and flutter:	Immeasurable

General

Power requirement:	AC 230 V~, 50 Hz
Power consumption:	70 W (at operation) 1 W (on standby: with Display Off) 3.3 W (on standby: with Display On)
Dimensions (approx.):	185 mm x 210 mm x 349 mm (W/H/D)
Mass (approx.):	7.4 kg

Supplied accessories

See page 8.

Design and specifications are subject to change without notice.

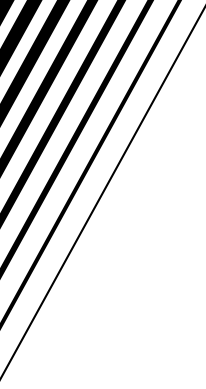

Free Manuals Download Website

<http://myh66.com>

<http://usermanuals.us>

<http://www.somanuals.com>

<http://www.4manuals.cc>

<http://www.manual-lib.com>

<http://www.404manual.com>

<http://www.luxmanual.com>

<http://aubethermostatmanual.com>

Golf course search by state

<http://golfingnear.com>

Email search by domain

<http://emailbydomain.com>

Auto manuals search

<http://auto.somanuals.com>

TV manuals search

<http://tv.somanuals.com>